

# **Fyziologie působení farmak a toxických látek**

## **Přednáška č.2**

**Jaderné receptory (ER, AR, PR, GR, TR, RAR/RXR, PPAR) a jejich ligandy.**



# Jaderné receptory

- jaderné receptory představují největší skupinu transkripčních regulátorů u mnohobuněčných živočichů;
- společná architektura – málo konzervovaná **N-koncová doména**, vysoce konzervovaná **DNA vazebná doména (DBD)**, spojovací oblast, **doména vázající ligandy (LBD)** a variabilní C-koncová doména;
- N-koncová doména bývá také označována jako doména zodpovědná za tzv. **aktivační funkci 1 (AF1)** – pomocí této oblasti je jaderný receptor regulován dalšími signálními dráhami indukujícími specifické posttranslační modifikace, např. fosforylace; LBD je označována jako AF2 – receptor je aktivován specifickým ligandem;
- spektrum ligandů jaderných receptorů je velmi široké, přesto je u většiny jaderných receptorů neznáme a označujeme je jako **sirotčí (orphan) receptory**;



# JADERNÉ RECEPTORY

Nuclear Hormone Receptors

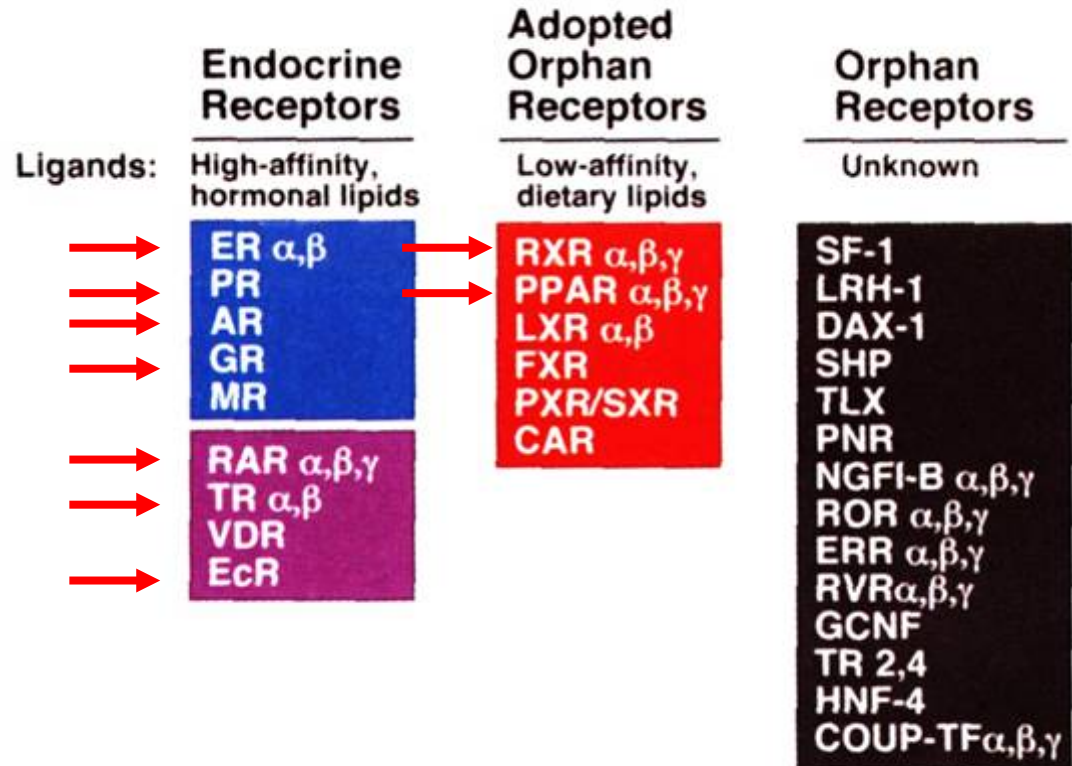
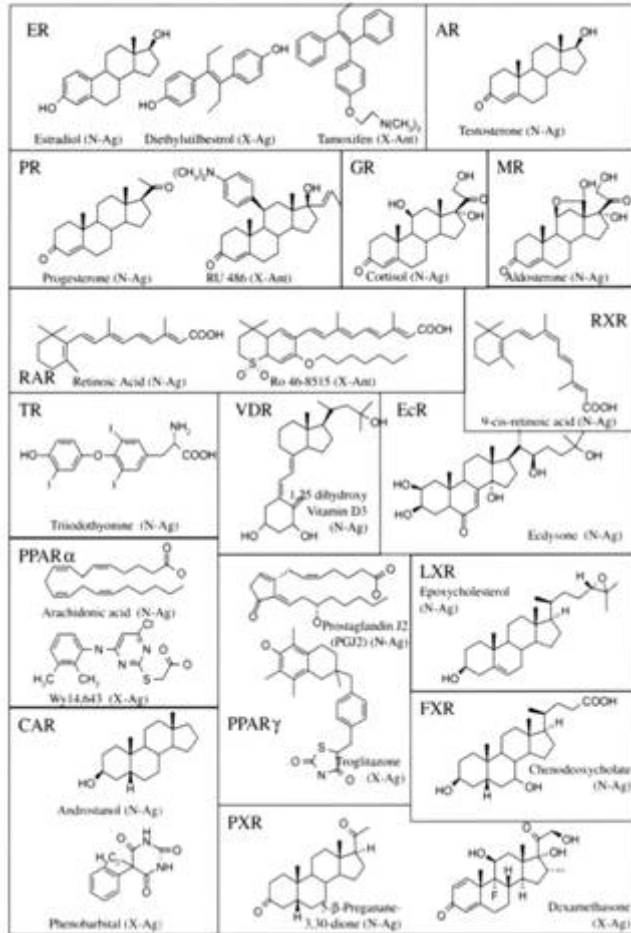



# Vazebné motivy DNA na které se váží jaderné receptory

**Fig. 2.** The types of DNA-response elements used by nuclear receptors. (a) Symmetric repeats using the consensus half-site 5'-AGAACA-3' are used by the glucocorticoid receptor (GR), progesterone receptor (PR), androgen receptor (AR) and mineralocorticoid receptor (MR), each of which is a homodimer. The estrogen receptor (ER) binds similar symmetric sites but with consensus 5'-AGGTCA-3' half-sites. (b) A '1-5 rule' specifies the use of direct repeats with variable spacings by RXR and its many partners (depicted in red). Some receptors, such as the vitamin D receptor (VDR) or RevErb, can form homodimers as an alternative to heterodimers. The size of the inter-half-site spacing (n) can vary from one to five base-pairs. (c) Sites containing just one copy of 5'-AGGTCA-3' flanked with specific 5' sequences (xxx) are used by the nerve growth factor induced B (NGFI-B) receptor, RevErb and some other orphan receptors.

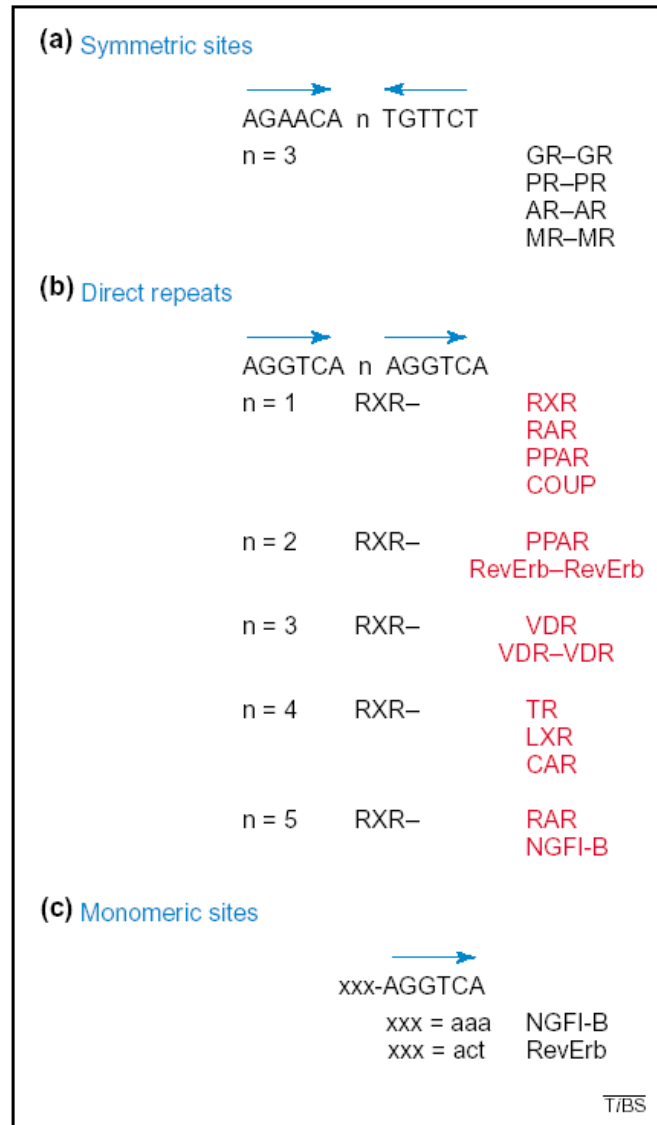

**Jaderné receptory bývají také někdy rozdělovány na základě jejich dimerizace:**

- **steroidní receptory – vytvářejí homodimery** – receptory pro estradiol (ER), progesteron (PR), androgeny (ARs), glukokortikoidy (GR) a mineralokortikoidy (MR);
- **receptory vytvářející heterodimery s retinoidními X receptory (RXR; receptor pro kyselinu 9-*cis* retinovou).** Patří sem receptory pro kyselinu all-*trans* retinovou (RAR), vitamín D3 (VDR), tyroidní hormony (TR), jaterní X receptor (LXR), receptory aktivované peroizómovými proliferátory (PPAR) a další;
- **skupina receptorů schopných vázat DNA jako monomery** – např. NGFI-B, RevErb, ROR a SF-1.



**Fig. 4.** (a) The DNA-binding domains (DBDs) in the nuclear receptor family contain a conserved recognition  $\alpha$  helix (shown in blue) and a variable C-terminal extension (CTE) that continues past the core 66-residue DBD into the hinge region. Each of these two elements provides a distinct DNA-binding surface<sup>35</sup>. (b) The recognition helix recognizes the major groove half-sites, with H<sub>2</sub>O bridging some of the protein–DNA interactions (water molecules are shown as dark circles). (c) By contrast, the CTEs of RevErb, NGFI-B and TR bind along the minor groove and backbone of DNA (Refs 32,35,36).

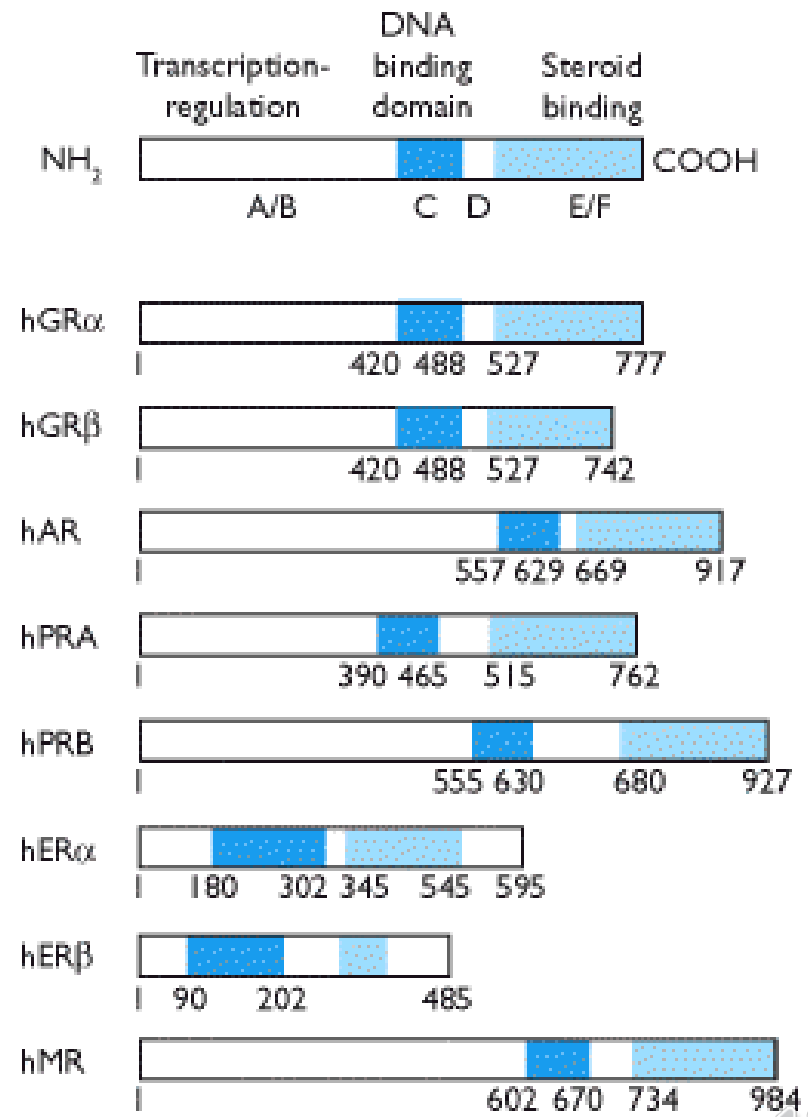
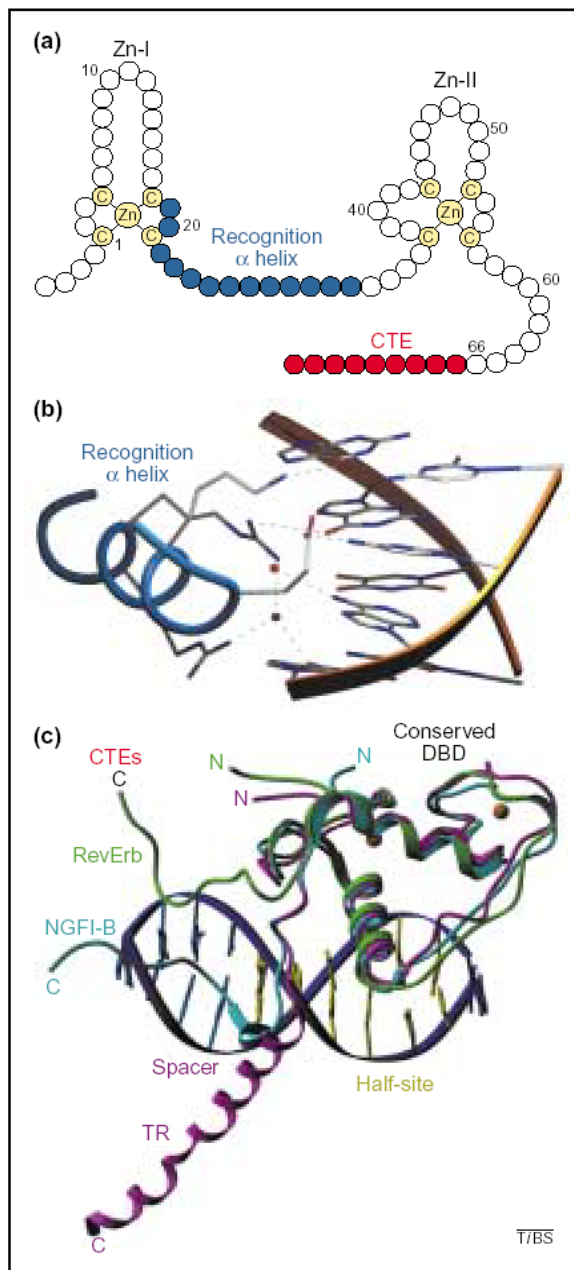

# GR a jeho aktivace kortizolem – modelová aktivace jaderného receptoru

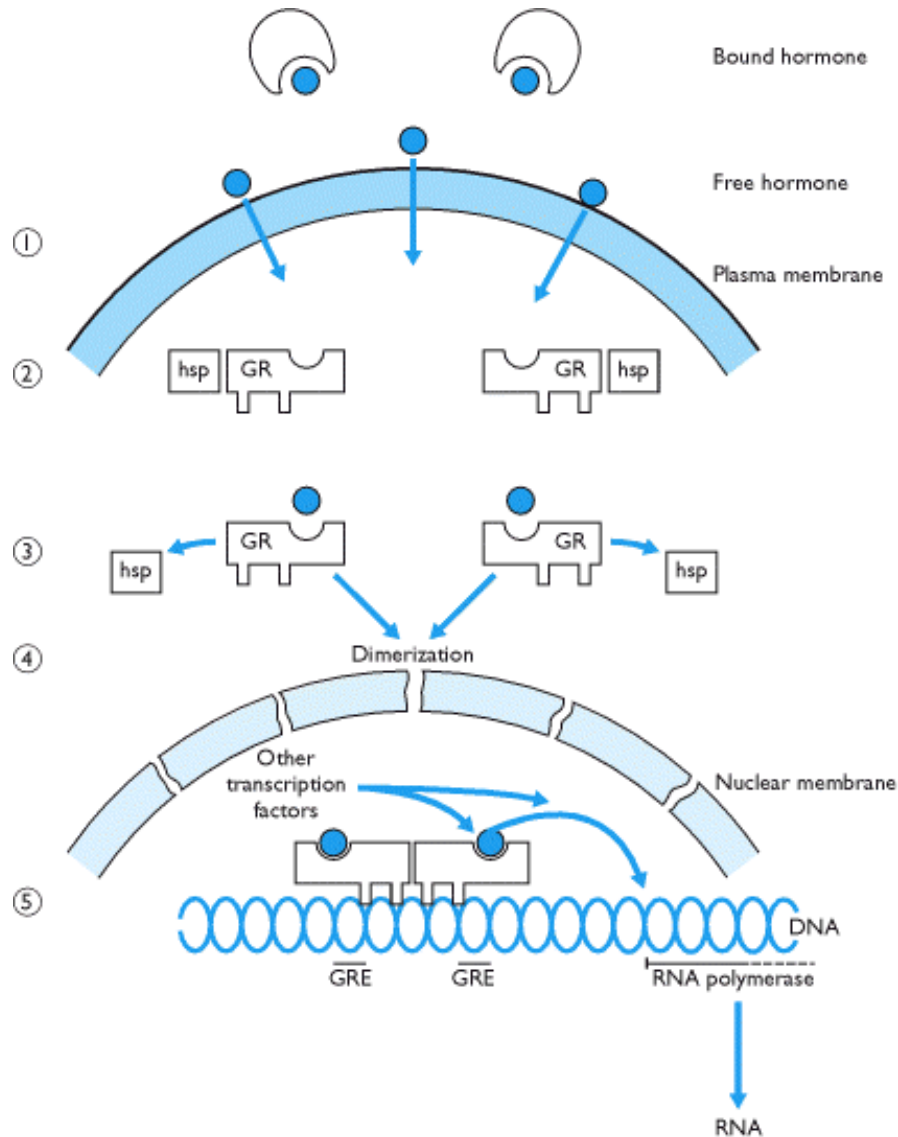

1. Volný lipofilní kortizol snadno prochází buněčnou membránou a váže se na GR;
2. Podobně jako další steroidní receptory je GR v neaktivním stavu vázán v cytoplasmě na tzv. heat shock proteiny (hsp-90, hsp-70 a hsp-56);
3. Po navázání ligandu na receptor dochází k uvolnění Hsp a translokaci GR do jádra;
4. Vznikající homodimer se váže na specifické sekvence DNA – glukokortikoidní responzivní elementy (GRE);
5. Ve spolupráci s dalšími koaktivátory a faktory remodelujícími chromatin iniciuje transkripci cílových genů;



# Regulace transkripce jadernými receptory – komplexní proces

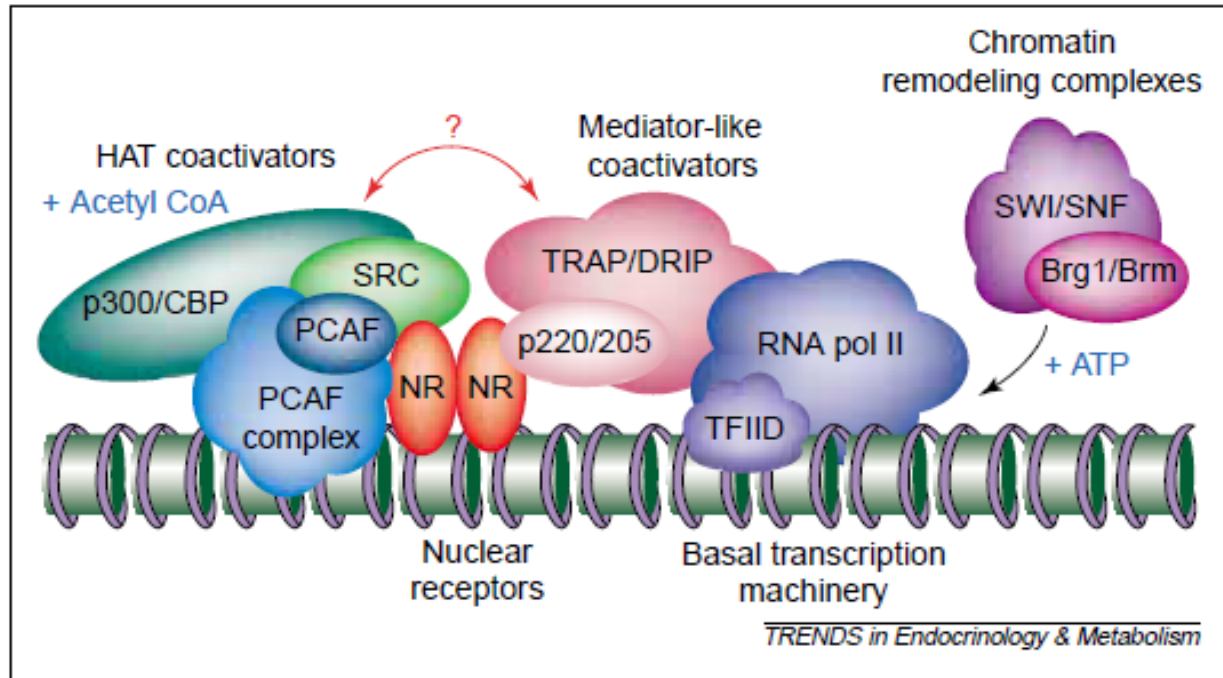

**Fig. 6.** Multiple physical and functional interactions among nuclear receptors, coactivators, chromatin remodelers and chromatin lead to an ordered sequence of events culminating in the transcription of hormone-regulated genes including: (1) ligand-dependent interaction of coactivators with chromatin-bound NRs, (2) ATP-dependent chromatin remodeling by chromatin remodeling complexes, (3) histone acetylation by HAT coactivators and (4) contacts between NRs and the basal transcriptional machinery by the Mediator-like coactivators (e.g. TRAP/DRIP). Whether functional interactions occur between the SRC-p300/CBP-PCAF coactivators and the TRAP/DRIP complex is currently unclear, as is indicated by the question mark. Abbreviations: acetyl CoA, acetyl coenzyme A (the acetyl donor for acetylation reactions); CBP, CREB-binding protein; CREB, cAMP-response element-binding protein; HAT, histone acetyltransferase; NR, nuclear receptor; PCAF, p300/CBP-associated factor; p220/205, TRAP220/DRIP205; RNA pol II, RNA polymerase II; SRC, steroid receptor coactivator; TFIID, transcription factor IID [which contains TATA-binding protein (TBP) and TBP-associated factors]; TRAP/DRIP, thyroid hormone receptor-associated proteins/vitamin D receptor-interacting proteins.





# Toxické látky, farmaka

?????

## Vnitrobuněčná signalizace

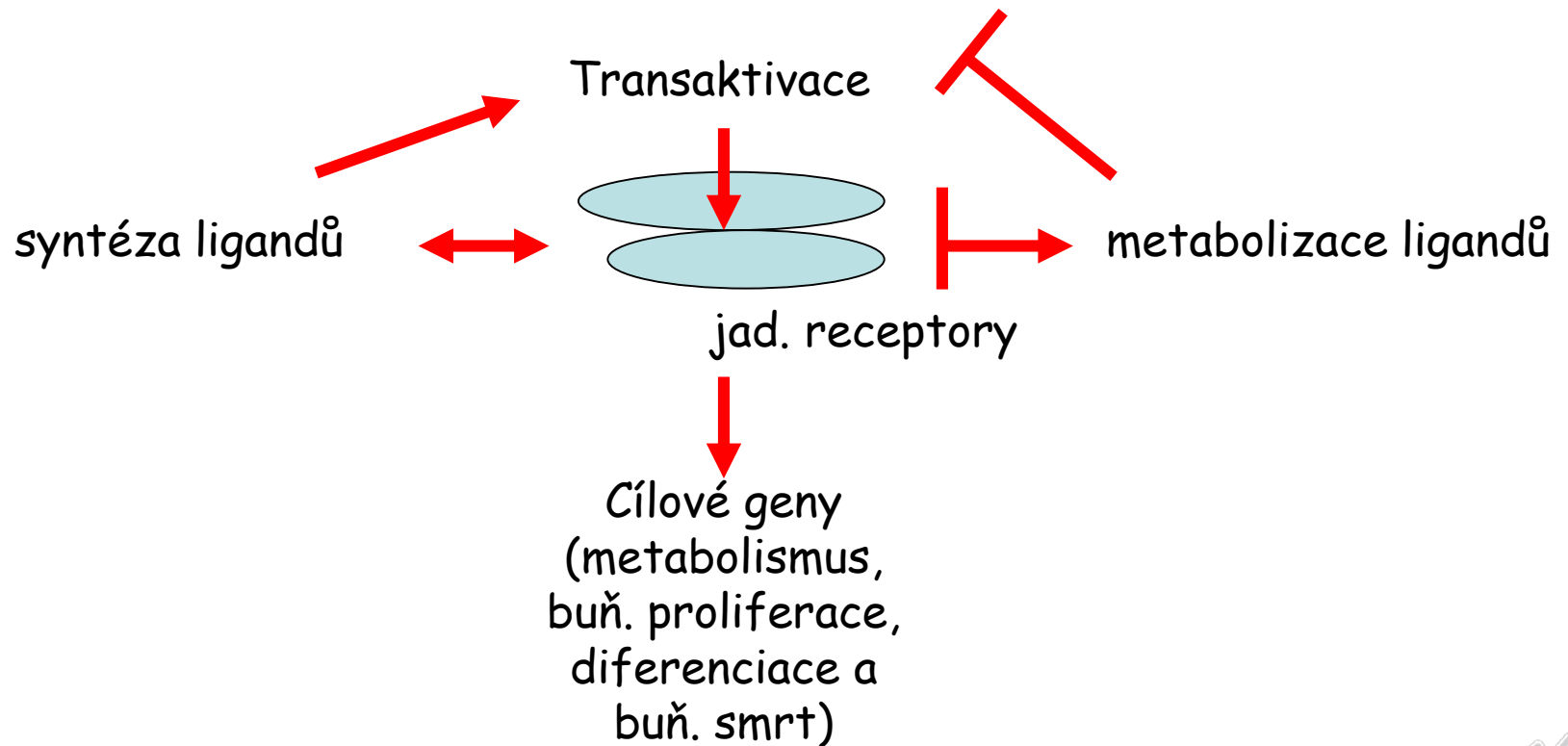

# Jaderné receptory a enzymy:

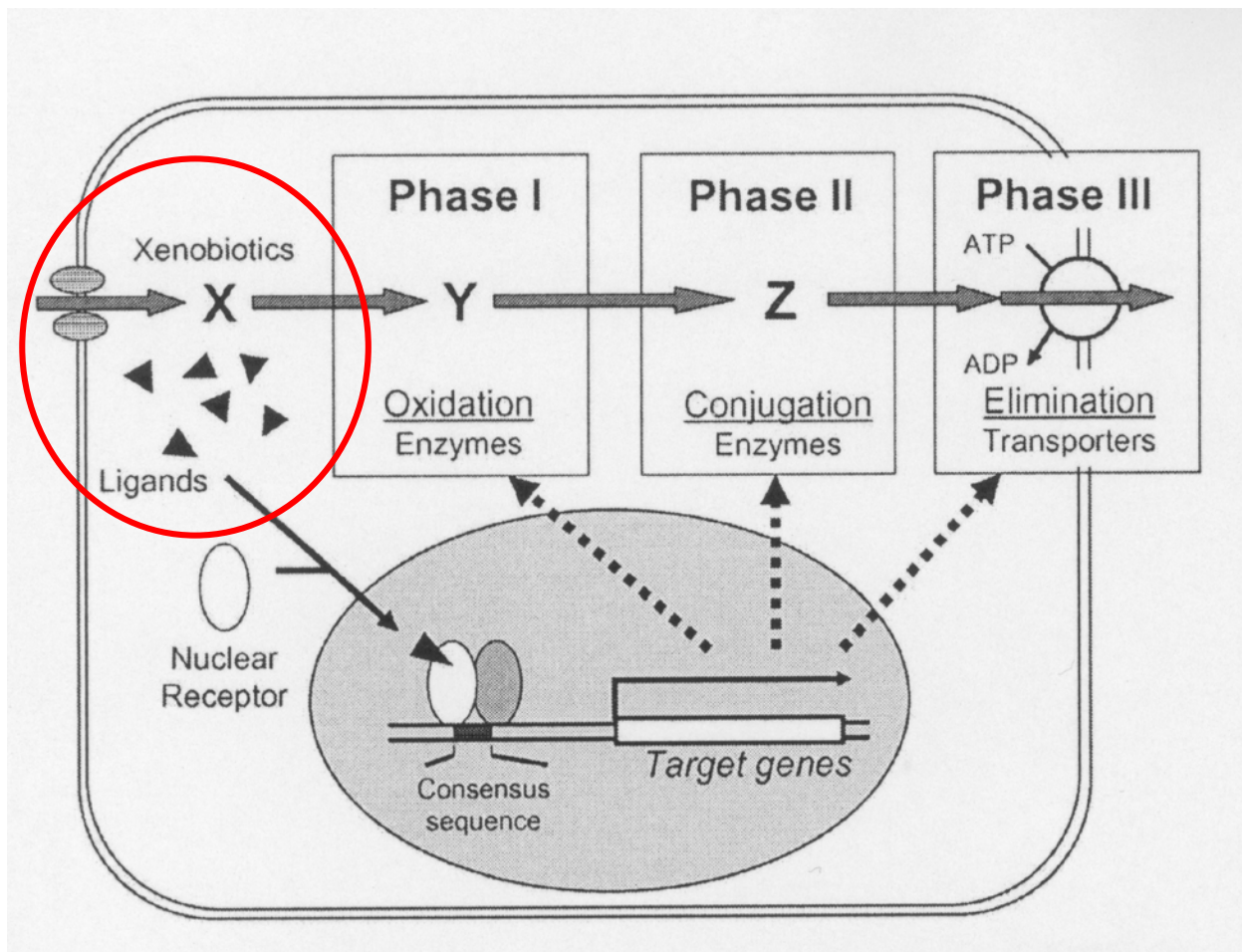

# Metabolické dráhy zajišťující syntézu a eliminaci ligandů jaderných receptorů

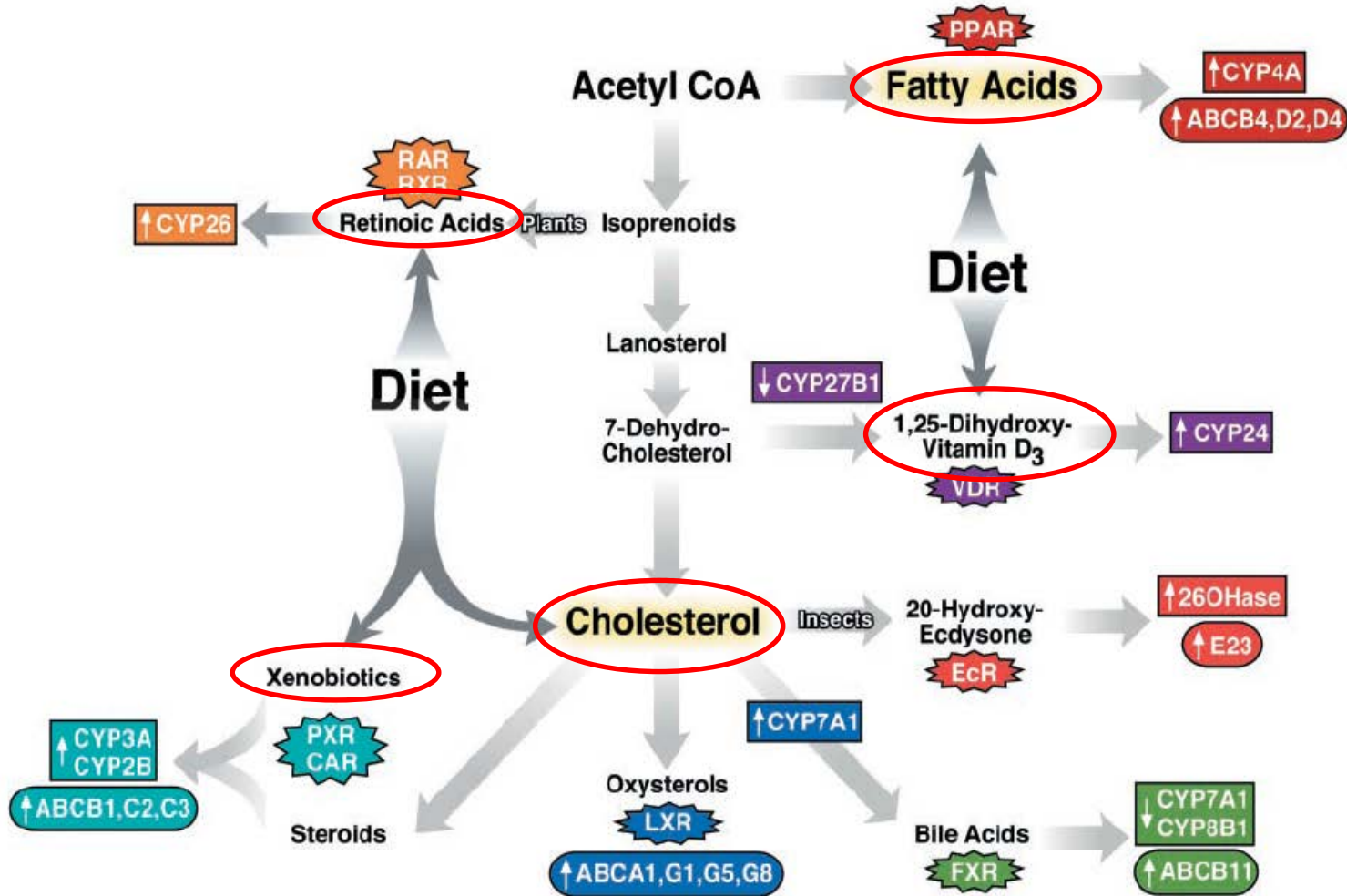

# Jaderné receptory vytvářejí složitou síť regulující funkce organismu

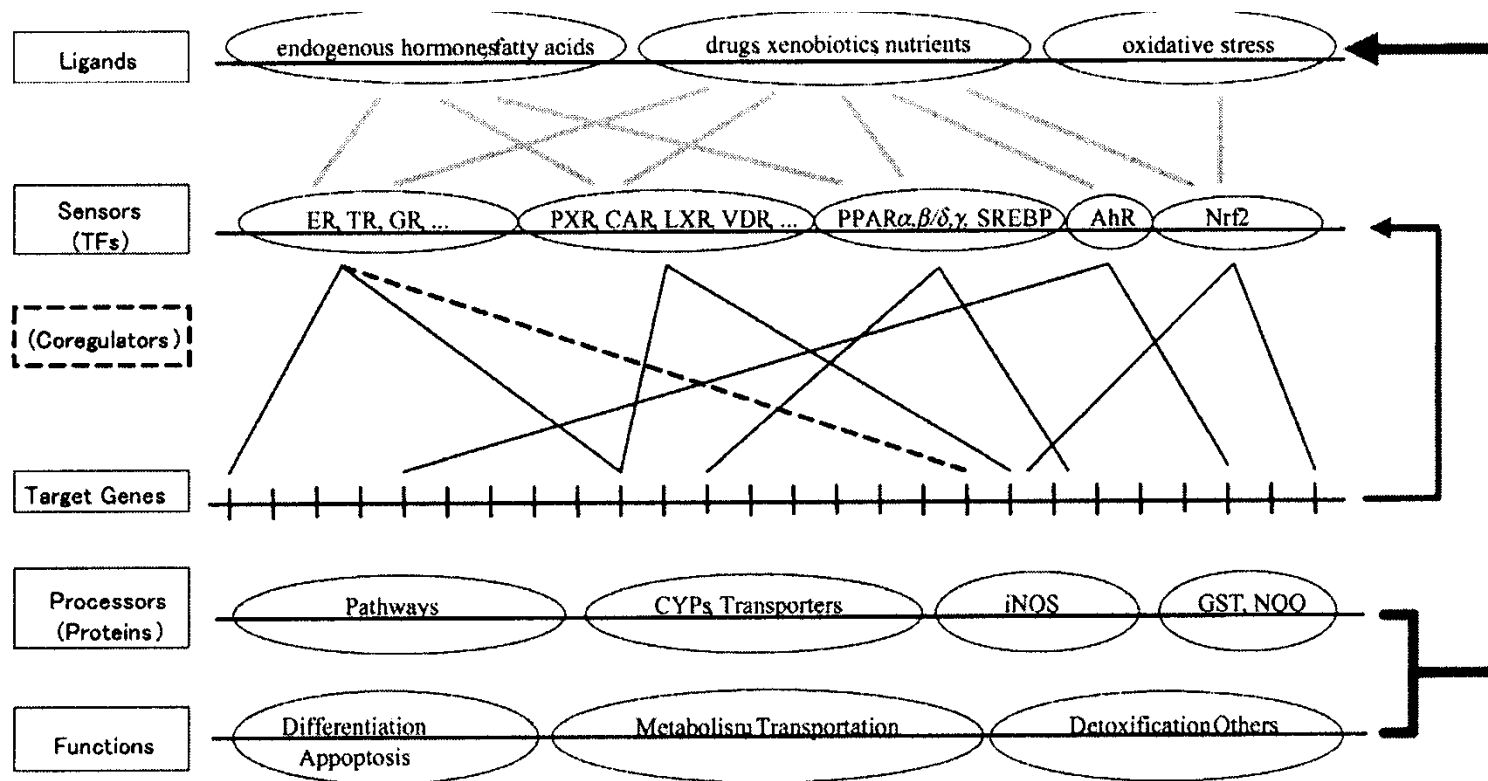

**Fig. 5.** Schematic diagram of overall xenobiotic responsive systems. iNOS: inducible nitric oxide synthase, GST: glutathione S-transferase NQO: NAD(P)H:quinone oxidoreductase



# Hepatocyty – mechanismy regulující transport a metabolismus endogenních látek a xenobiotik

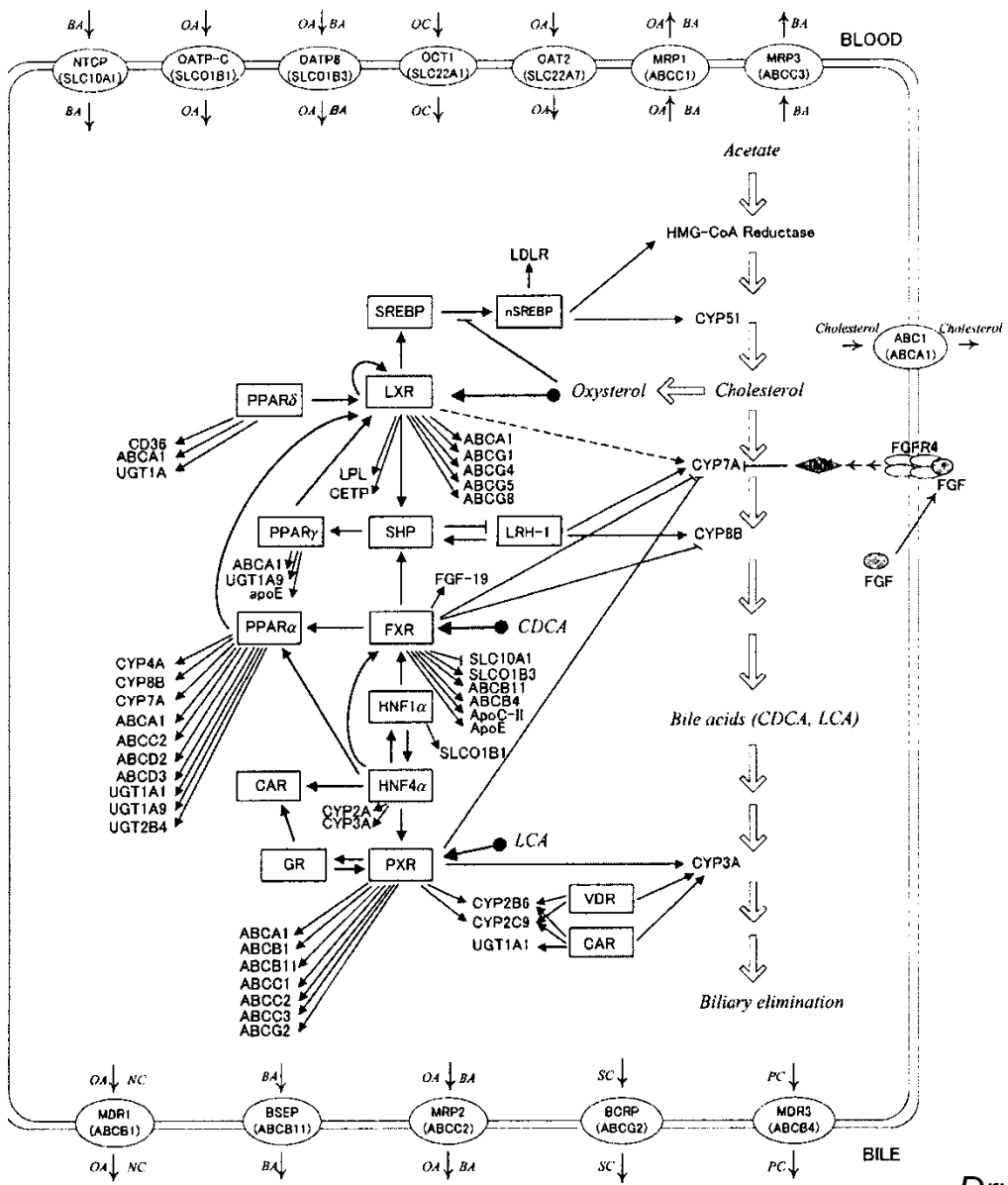

# Jaderné receptory hrají zásadní roli v endokrinní signalizaci

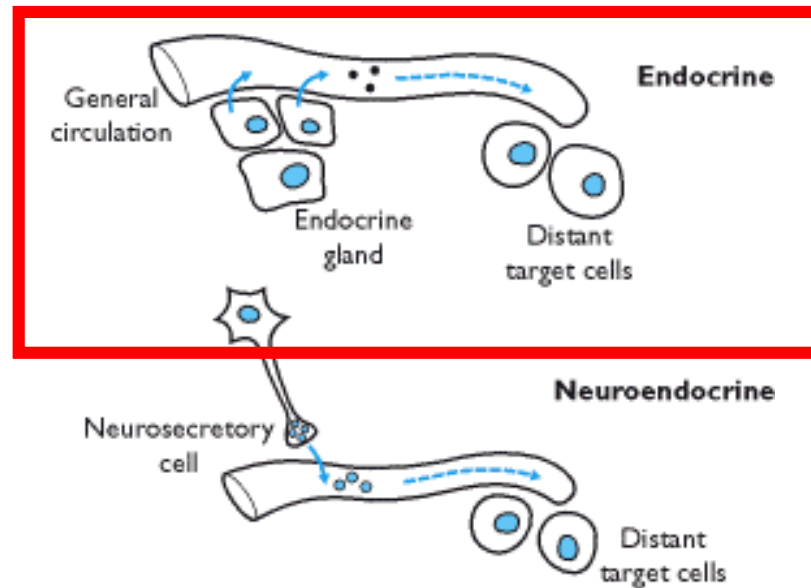
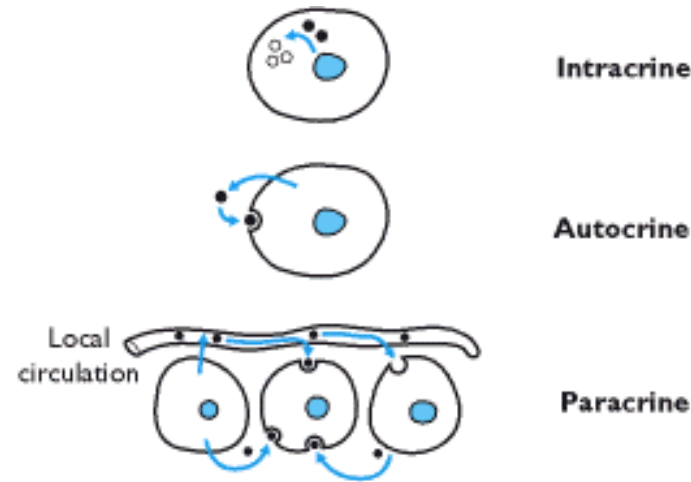

# **Steroidní hormony a jejich receptory**



### Protein and Peptide Hormones

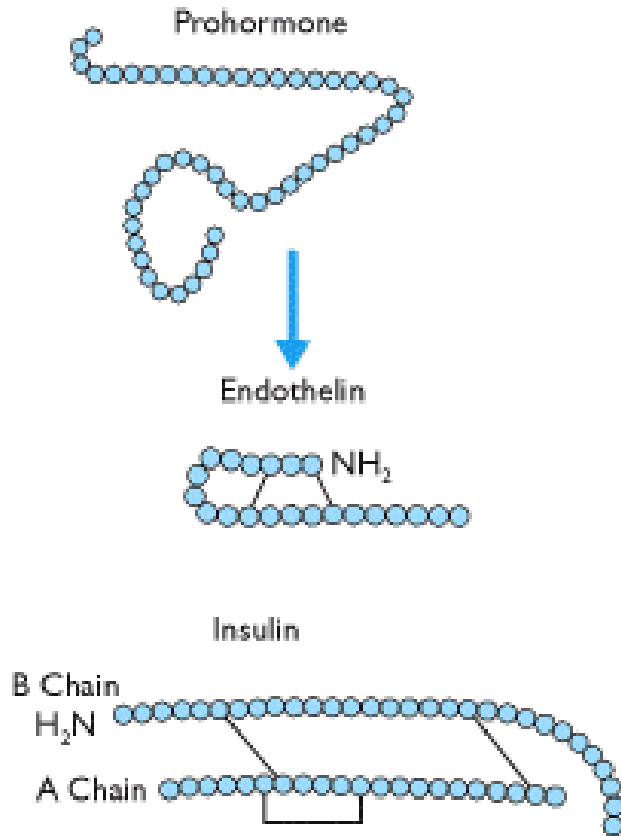

### Steroid Hormones

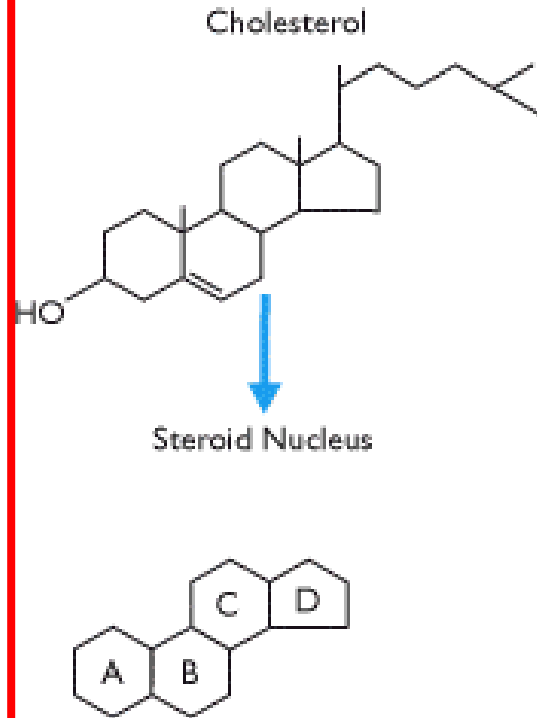

### Tyrosine Derivatives

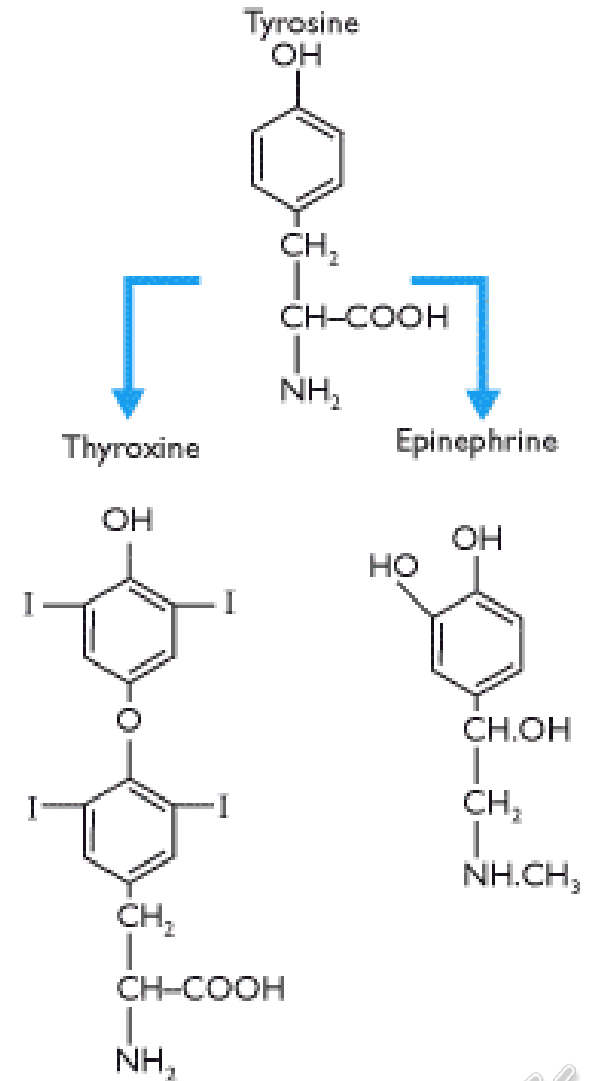



## Hormones

## Peptide/protein

## Steroid

## Amino acid or fatty acid derived

Thyroid hormones

Thyroxine (T<sub>4</sub>)

Triiodothyronine (T<sub>3</sub>)

Adrenal cortical steroids

Cortisol

Aldosterone

DHEA

Male reproductive hormones

Inhibin

Testosterone

Dihydrotestosterone

Female reproductive hormones

Inhibin

Estradiol

Oxytocin

Progesterone

Human chorionic gonadotropin (hCG)

Human chorionic somatotrophin



# Hlavní skupiny steroidních hormonů:

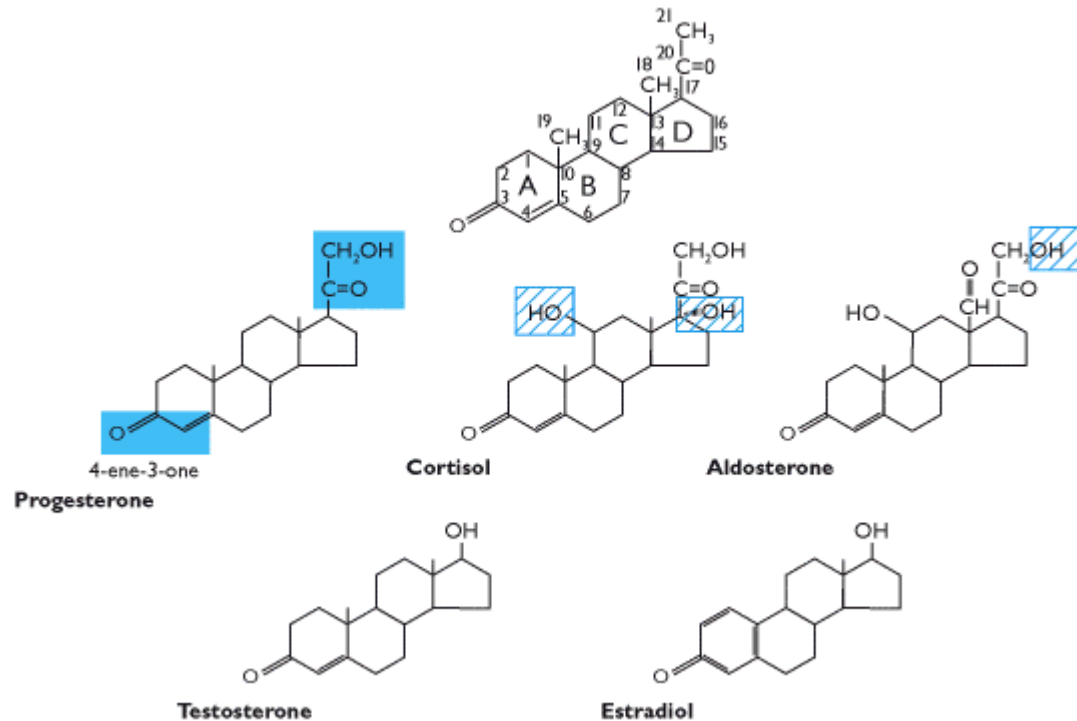

Shaded boxes show structural requirements for glucocorticoid and mineralocorticoid activity. Hatched boxes show additional structural requirements for specific glucocorticoid or mineralocorticoid activity.



# Syntéza kortizolu z cholesterolu v kůře nadledvinek

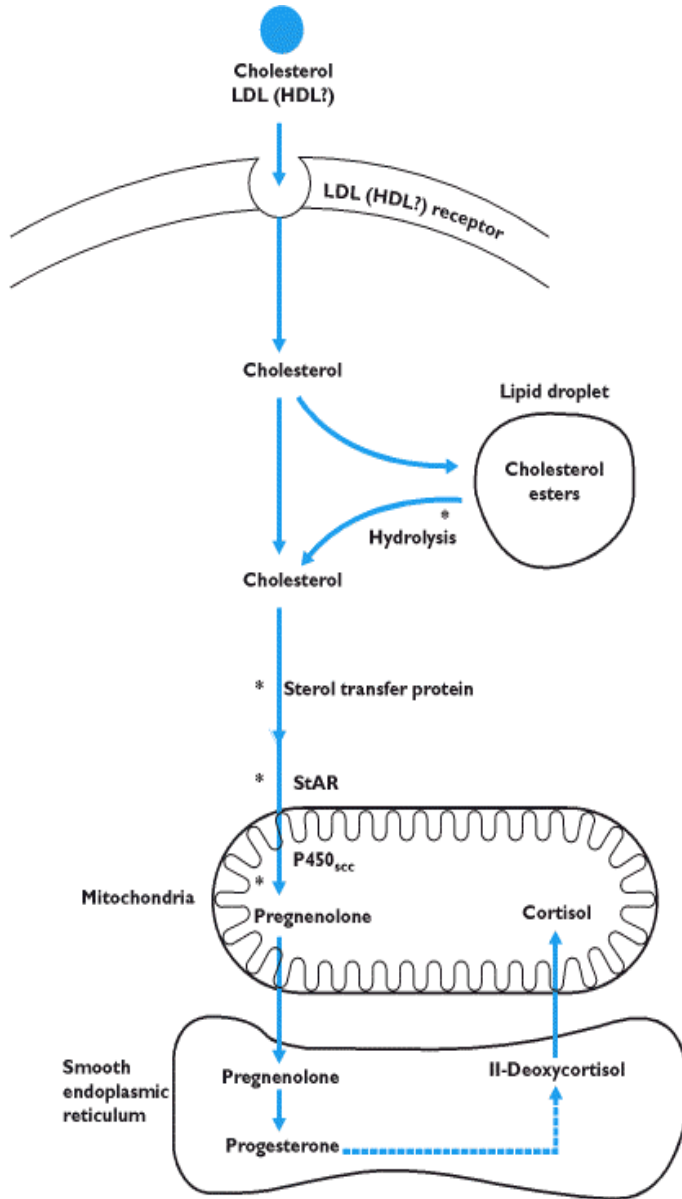

- Cholesterol je syntetizován v těle nebo získáván z potravy v poměru cca 600 mg/300 mg denně.
- Vzhledem k tomu, že je nerozpustný ve vodě, je z jater (hlavní místo jeho tvorby) transportován ve formě lipoproteinů.
- V kůře nadledvinek dochází k zachycení cca 80% cholesterol nezbytného pro syntézu steroidů na receptorech pro nízkodenzitní lipoproteiny (LDL). Zbýlých 20% je syntetizováno z acetátu přímo v buňkách nadledvinek.



# Biosyntéza steroidních hormonů:

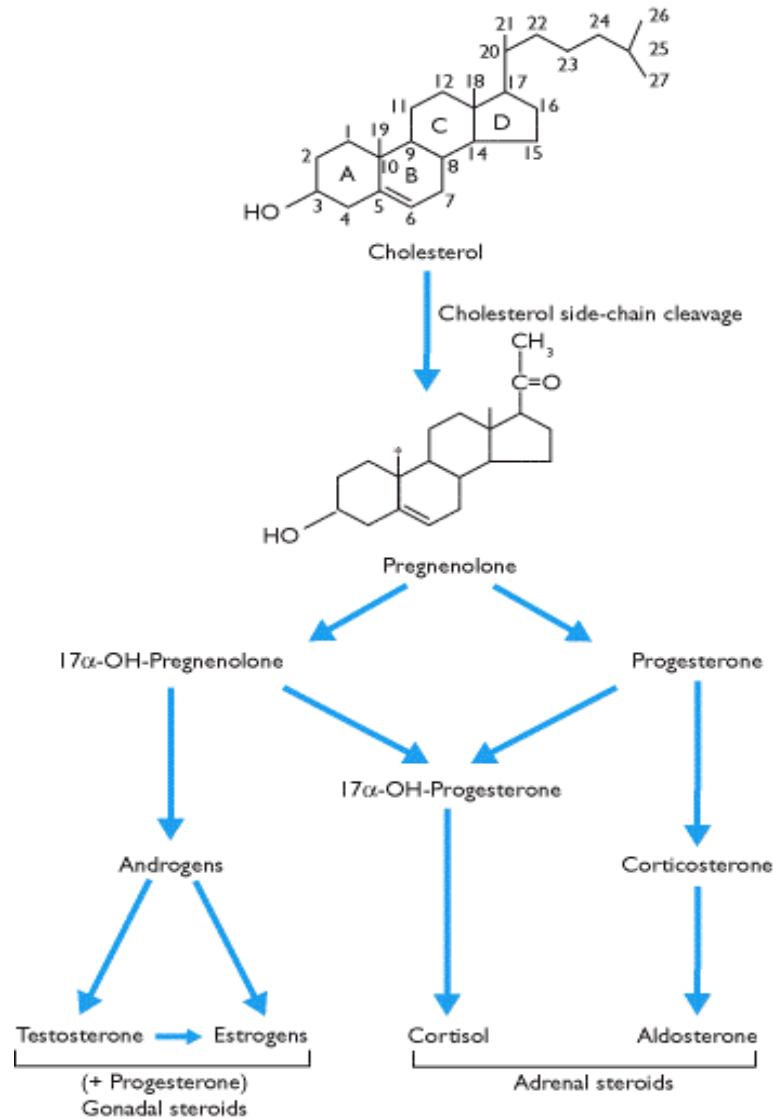



# Biosyntéza pohlavních steroidních hormonů:

<b>Male</b>	<b>Testis</b>	<b>Adrenal</b>	<b>Peripheral conversion</b>
Testosterone	95	<1	<5
5 $\alpha$ -DHT	20	<1	80
Androstenedione	20	<1	90
DHEA	2	<1	98
DHEA-S	<10	90	-

<b>Female</b>	<b>Ovary</b>	<b>Adrenal</b>	<b>Peripheral conversion</b>
Testosterone	5–25	5–25	50–70
5 $\alpha$ -DHT	-	-	100
Androstenedione	45–60	30–45	10
DHEA	20	80	-
DHEA-S	<5	>95	-

Total serum concentrations of testosterone - male: 9–25 nmol/l - female: 0.5–2.5 nmol/l  
Abbreviations: DHT, dihydrotestosterone; DHEA(-S), dihydroepiandrosterone (-sulfate).



# Biosyntéza pohlavních steroidních hormonů:

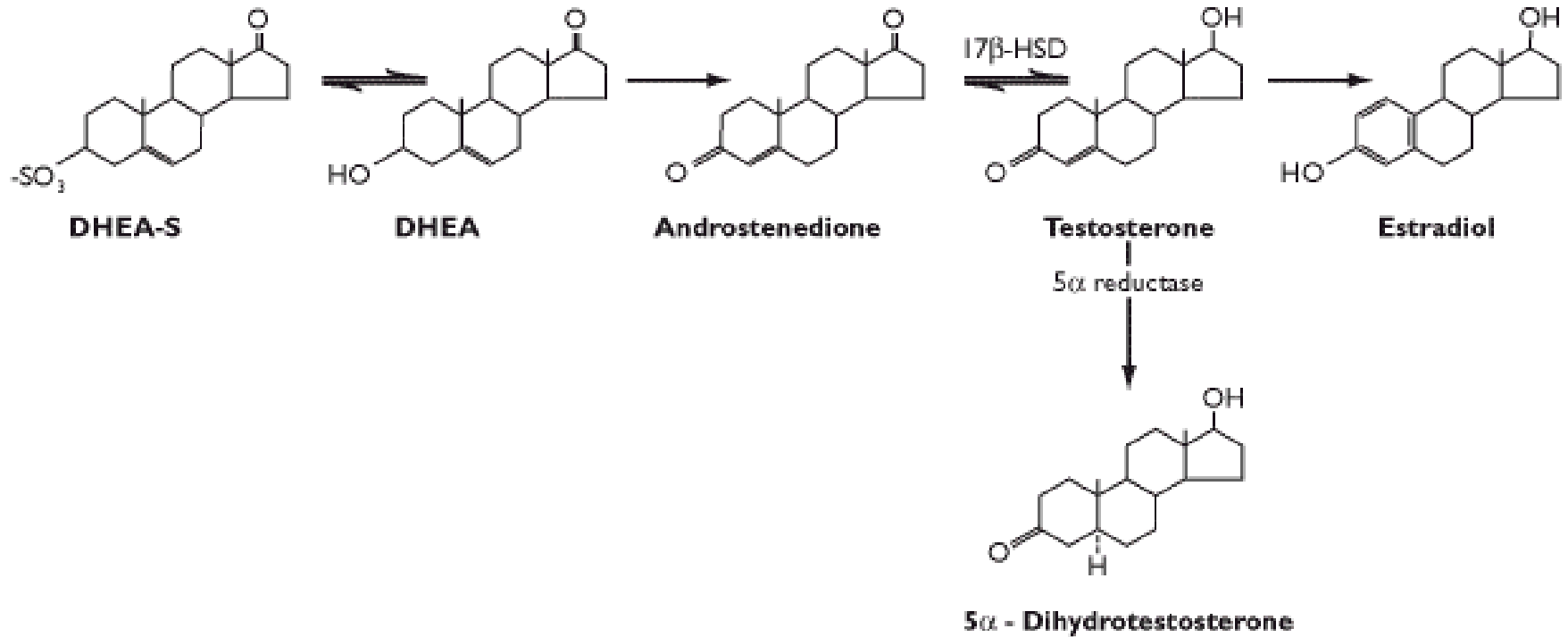

# Transport a metabolizace pohlavních steroidních hormonů:

- jen asi 2% **testosteronu** v oběhu je ve volné formě, která je schopna vstoupit do buněk. Zbytek je vázán v plazmě na **albumin** (cca 40%) nebo na **sex-hormone-binding globulin (SHBG)**. Volná forma a vázaná forma je v rovnováze. SHBG je syntetizován v játrech a jeho hladina je kontrolována řadou faktorů (estrogen, tyroidní hormony, androgeny, glukokortikoidy, růstovým hormonem a dalšími faktory – stres, obezita apod.). Testosteron je v játrech metabolizován na androsteron, etiocholanolon a ty jsou po konjugaci exkretovány ve formě 17-ketosteroidů.
- **estradiol**, je transportován ve formě vázané na albumin (cca 60%) and SHBG (30%). V játrech je rychle metabolizován na estron a poté většinou dále na estriol nebo na 2- or 4-hydroxyestron pomocí katecho-O-methyltransferáz. Metabolity jsou dále konjugovány a vyloučeny s močí.





# Tyroidní hormony štítné žlázy



### Protein and Peptide Hormones

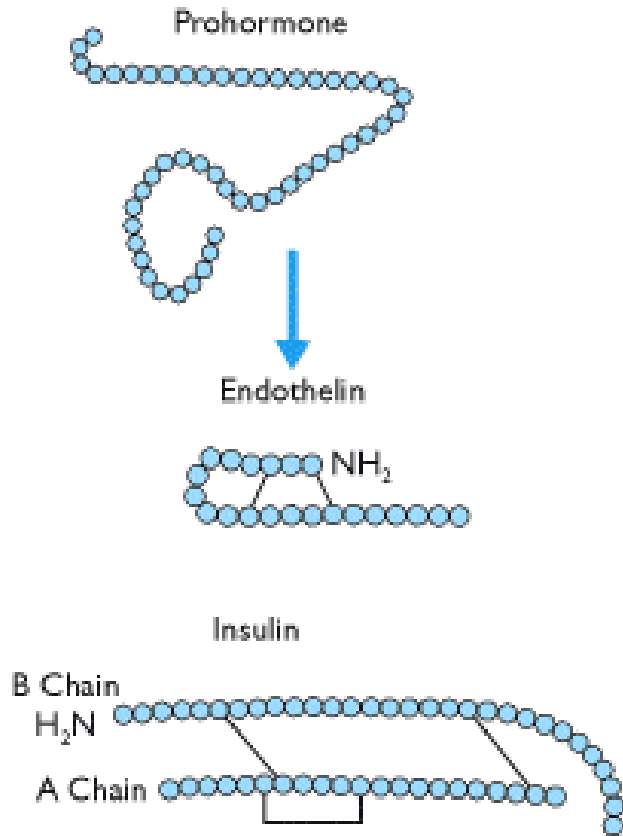

### Steroid Hormones

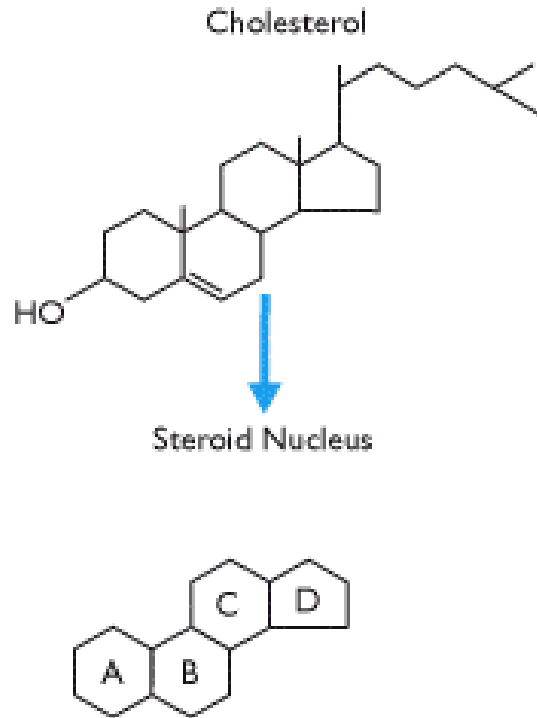

### Tyrosine Derivatives

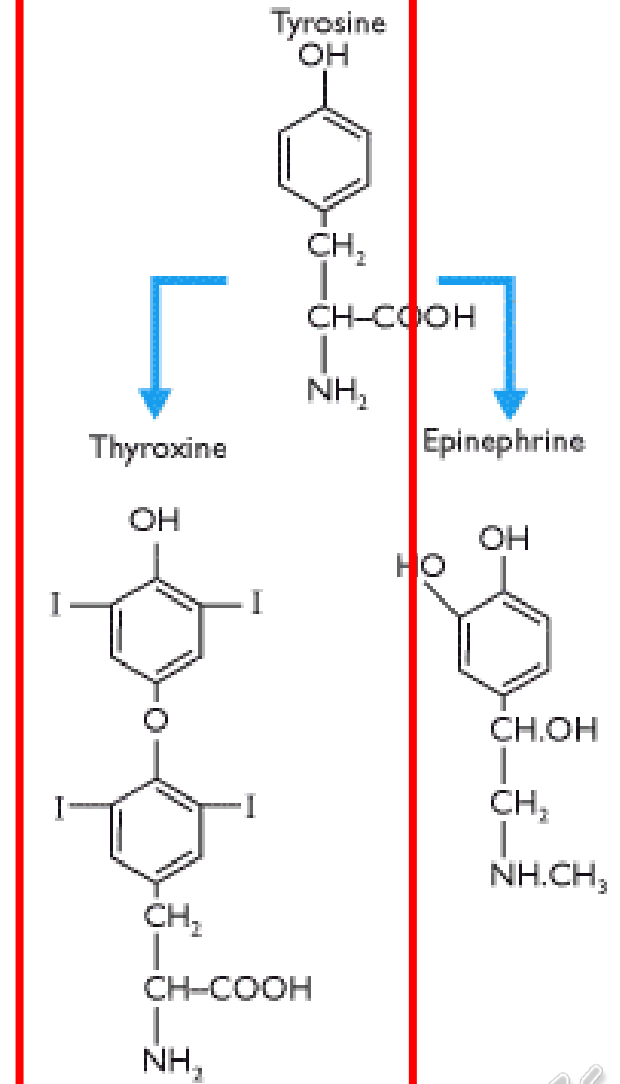

# Syntéza tyroidních hormonů:

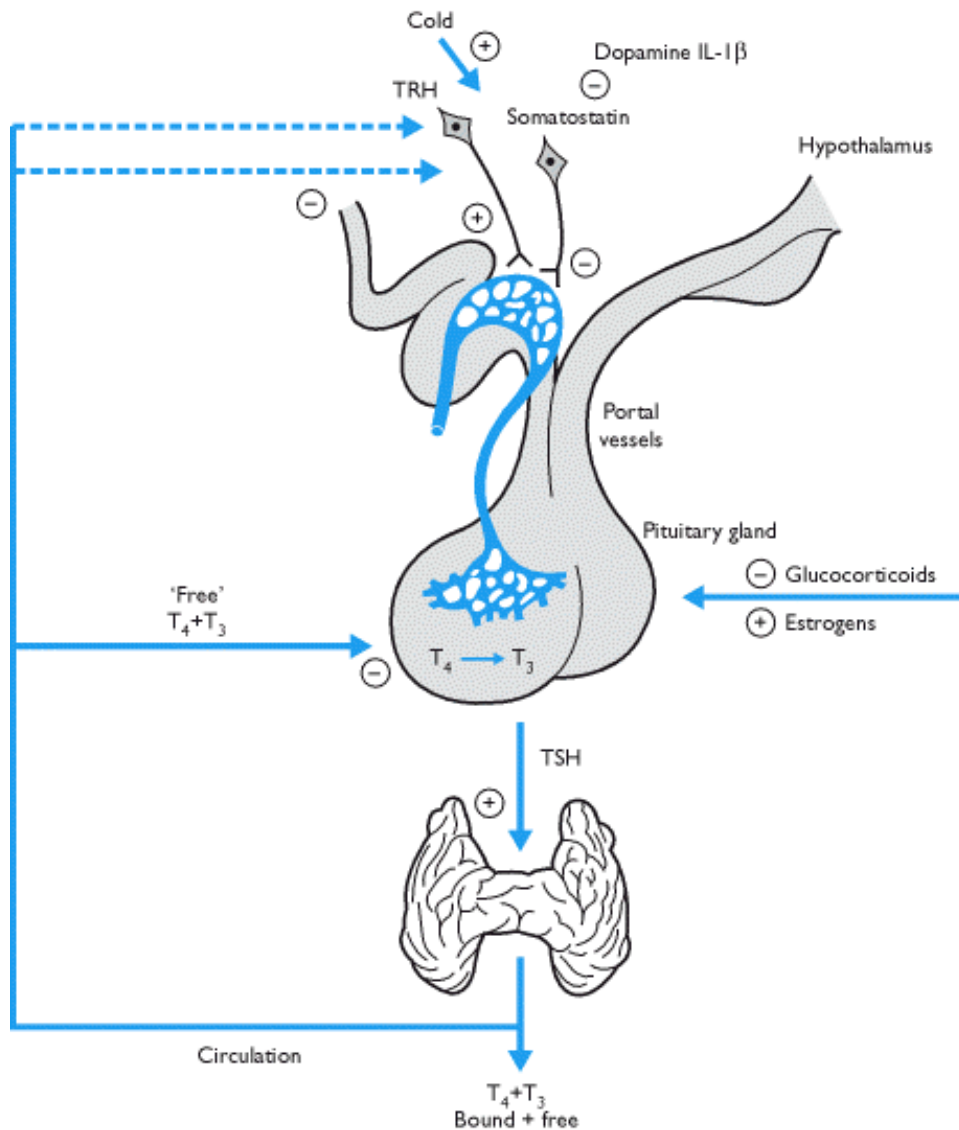

# Syntéza tyroidních hormonů:

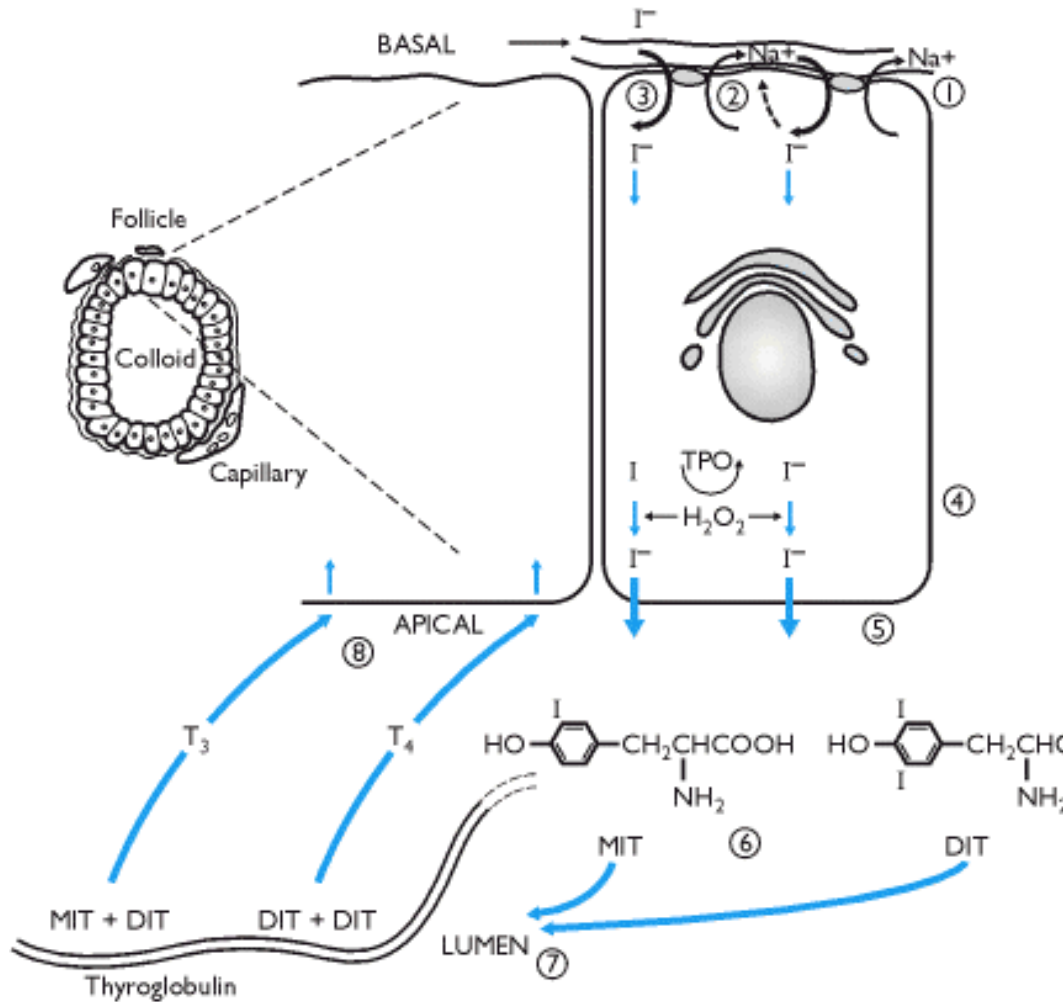

- 1) Active uptake of iodide ( $I^-$ ) in exchange for  $Na^+$ .
- 2) Iodide may be discharged from the follicular cell by administration of competing ions such as perchlorate, bromide or chlorate.
- 3) Iodide uptake, the main control point for hormone synthesis, is stimulated by TSH.
- 4) Oxidation of iodide by hydrogen peroxide ( $H_2O_2$ ) to form active iodine. The reaction is catalyzed by thyroid peroxidase (TPO).
- 5) Active transport of iodine across the apical surface of the follicular cell.
- 6) Incorporation of active iodine into the tyrosine residues of thyroglobulin molecules to form mono- and di-iodotyrosines (MIT and DIT).
- 7) Uptake of the thyroglobulin into the lumen of the follicle and lining of iodinated tyrosine residues.



# Uvolňování tyroidních hormonů:

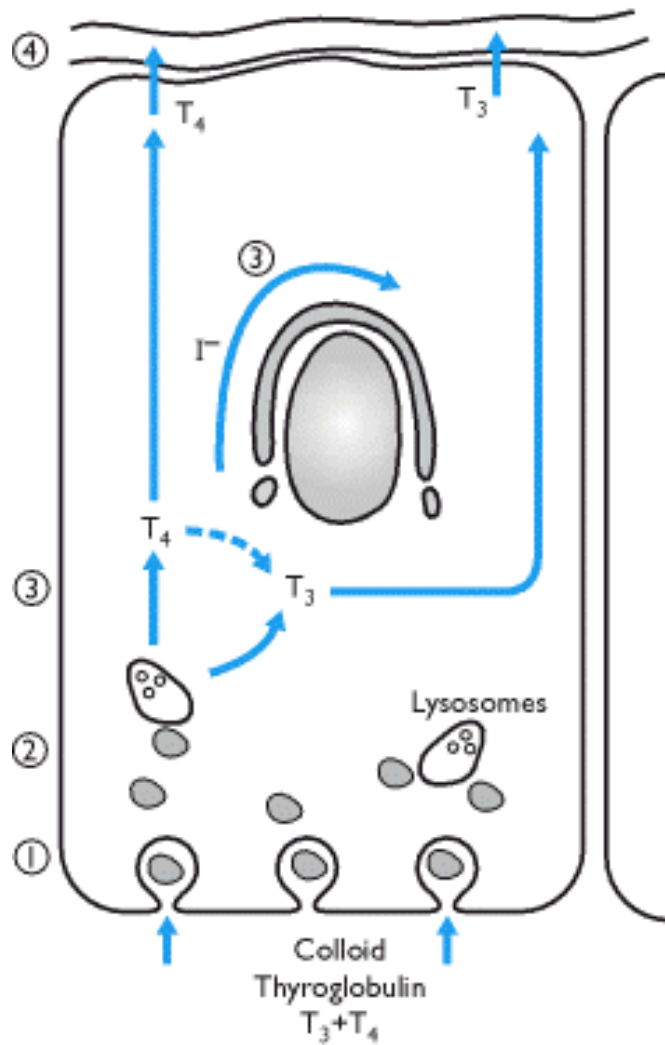

- 1) Under the influence of TSH, colloid droplets consisting of thyroid hormones within the thyroglobulin molecules are taken back up into the follicular cells by pinocytosis.
- 2) Fusion of colloid droplets with lysosomes causes hydrolysis of thyroglobulin and release of T<sub>3</sub> and T<sub>4</sub>.
- 3) About 10% of T<sub>4</sub> undergoes mono-deiodination to T<sub>3</sub> before it is secreted. The released iodide is reutilized. Several-fold more iodide is reused than is taken from the blood each day but in states of iodide excess there is loss from the thyroid.
- 4) On average approximately 100 µg T<sub>4</sub> and about 10 µg T<sub>3</sub> are secreted per day



# Transport a metabolizace tyroidních hormonů:

Podobně jako steroidní hormony jsou i tyroidní hormony prakticky nerozpustné ve vodě – po uvolnění se rychle vážou na proteiny v plazmě, především **transthyretin**, **thyroxine-binding globulin (TBG)** a **albumin**. Ty mají různou afinitu vůči T<sub>3</sub> a T<sub>4</sub>; cca 70% cirkulujících tyroidních hormonů se váže na TBG. Jen velmi malý podíl (<0.5%) tyroidních hormonů existuje ve volné formě a je v rovnováze s vázanými formami tyroidních hormonů.

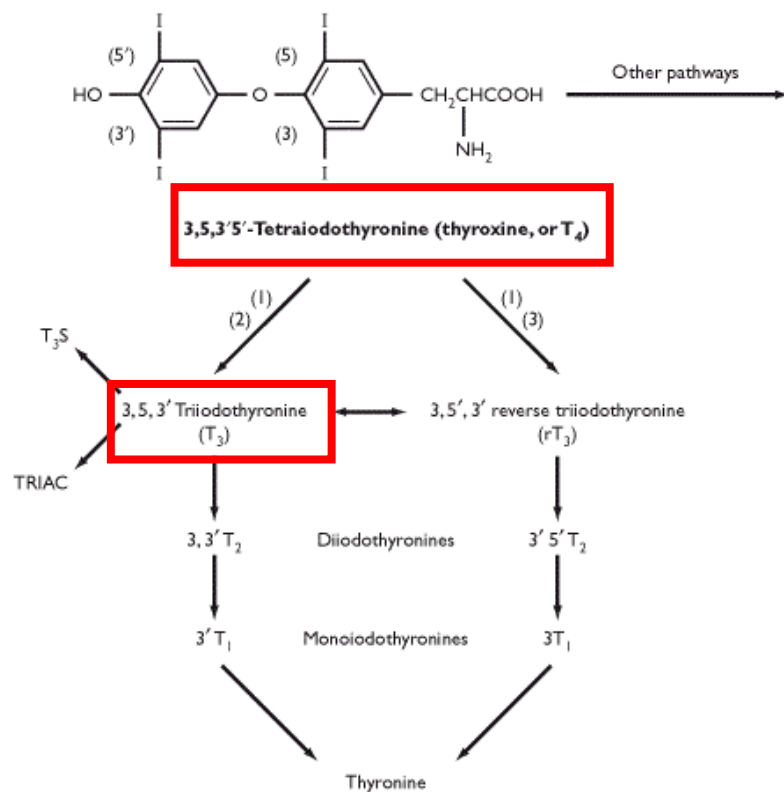

- tyroidní hormony jsou metabolizovány pomocí specifických deiodináz (viz čísla v závorkách);

- část T<sub>4</sub> může být přímo konjugována a vyloučena z organismu;

- podobně část T<sub>3</sub> může být sulfatována (T<sub>3</sub>S) nebo přeměněna na derivát kyseliny octové – (TRIAC)', který je ještě účinnější než T<sub>3</sub>;



# Transport a metabolizace tyroidních hormonů:

- cca 80% uvolněných tyroidních hormonů tvoří T4, ale ten je relativně málo aktivní a tak je považován za prohormon. Většina T4 je působením deiodináz v cílových tkáních přeměněna na biologicky aktivní T3 a inaktivní rT3;
- odstraněním I z uhlíku 5' prostřednictvím deiodináz typu 1 a 2 vzniká T3, zatímco odstraněním I z uhlíku 5 vzniká rT3. Dalším odštěpením atomů I vznikají di- a monojódtyroniny a jód organismus znovu využívá. část konjugovaných sloučenin je vylučována močí a žlučí.



# Struktura a aktivace tyroidních receptorů:

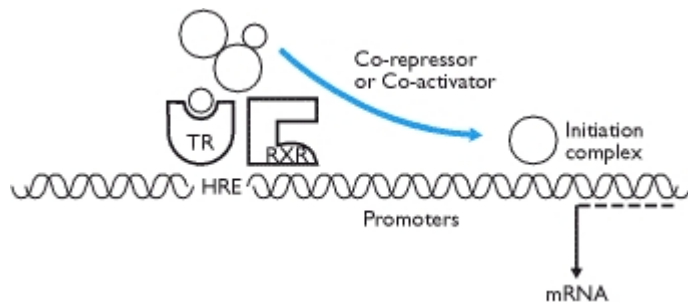
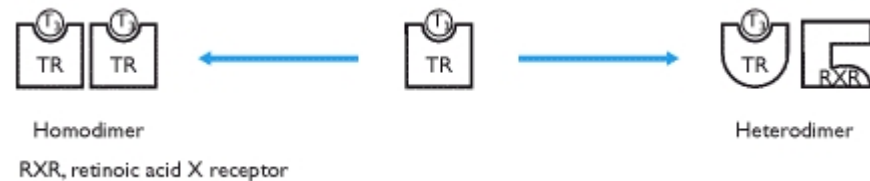
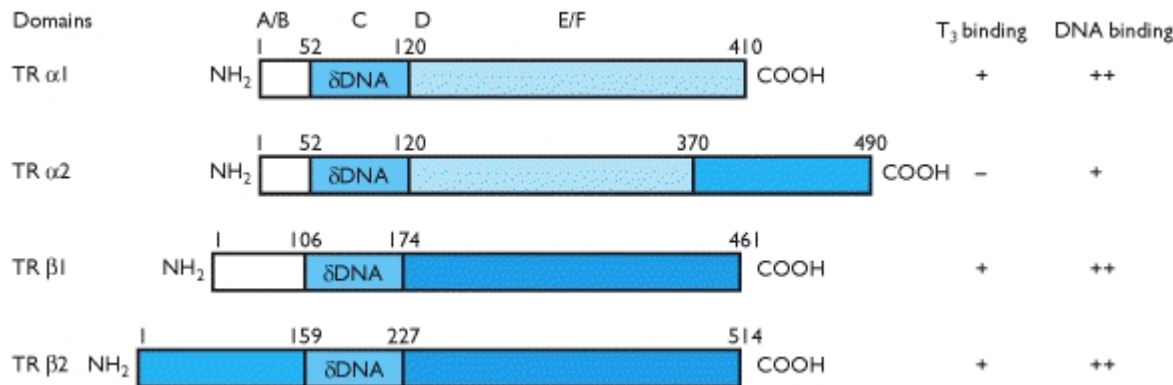



# Receptory pro retinoidy (RAR, RXR)



# Transport a metabolism retinoidů

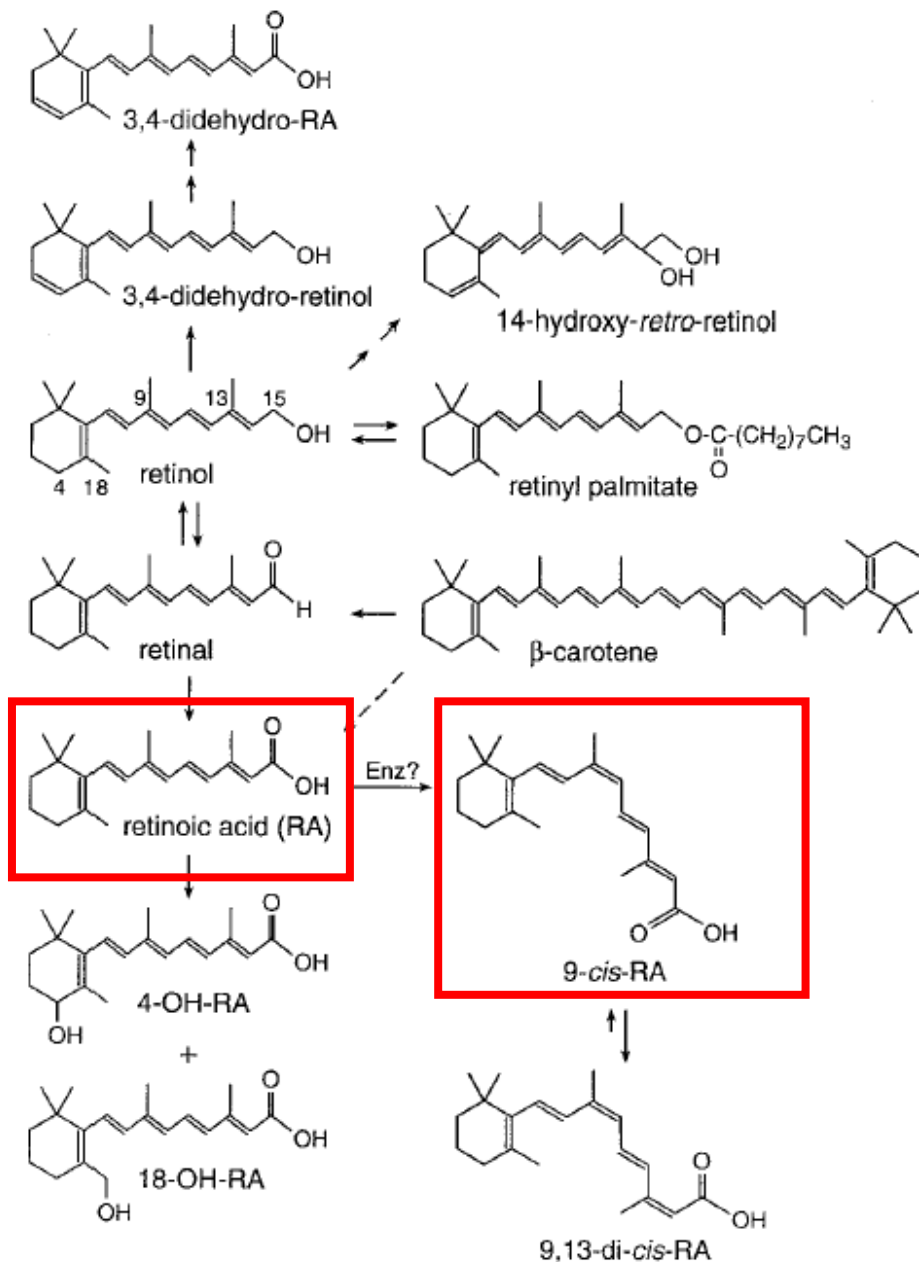
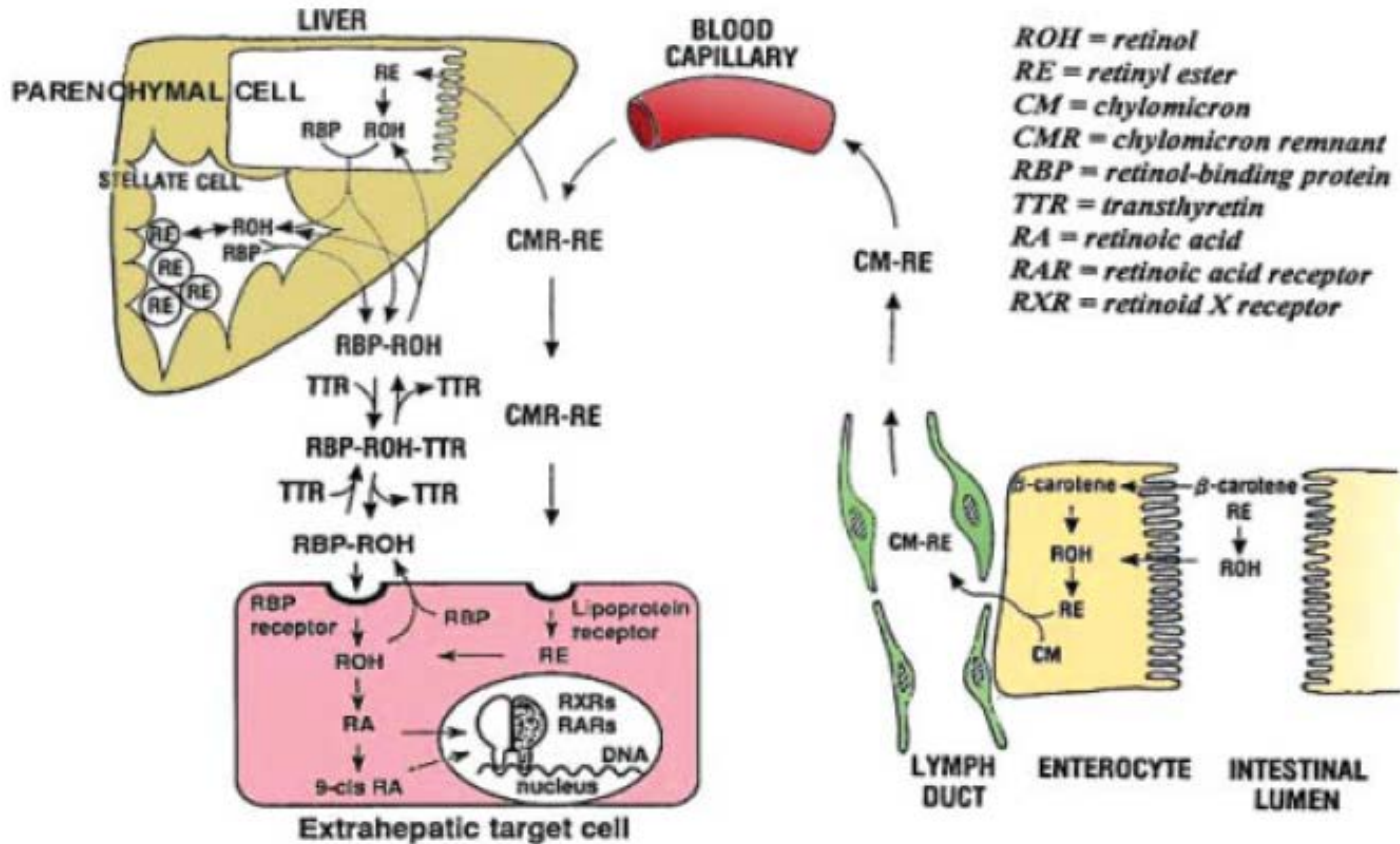

FIG. 2. Structures of naturally occurring retinoids.



# Transport a metabolismus retinoidů



# Retinoidy a jejich receptory:

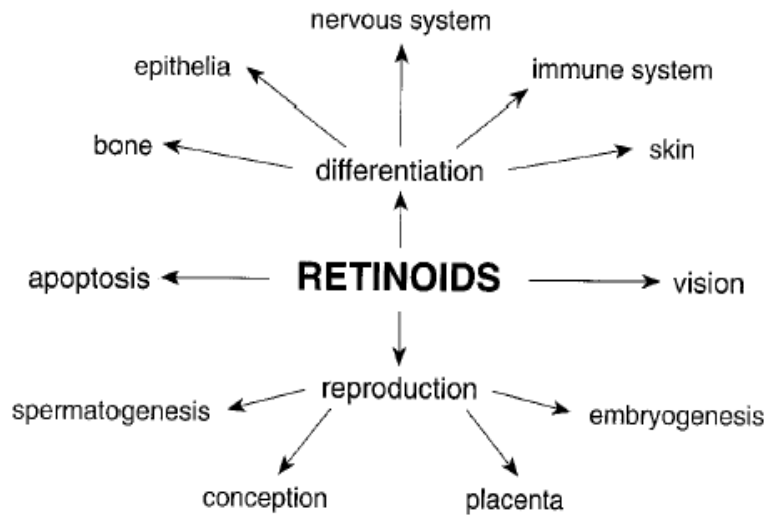

FIG. 1. Functions of naturally occurring retinoids.

TABLE I - LIGANDS AND ISOFORMS OF RAR AND RXR RECEPTORS

Receptor	Isoforms	Chromosomal location	Ligand
RAR $\alpha$	$\alpha 1, \alpha 2$	17q21.1	} all- <i>trans</i> RA & } 9- <i>cis</i> RA
RAR $\beta$	$\beta 1, \beta 2, \beta 3, \beta 4$	3p24	
RAR $\gamma$	$\gamma 1, \gamma 2$	12q13	
RXR $\alpha$	$\alpha 1, \alpha 2$	9q34	} 9- <i>cis</i> RA
RXR $\beta$	$\beta 1, \beta 2$	6q21	
RXR $\gamma$	$\gamma 1, \gamma 2$	1q22-q22	



# Proteiny podílející se na transportu retinoidů:

TABLE 1  
Retinoid Binding Proteins

Class/Protein	MW (kDa)	Primary ligands	Locl	Prospective function
Extracellular lipid-binding proteins (lipocalins)				
RBP	21	Retinol	Serum	Retinol transporter
$\beta$ -lactoglobulin	18.3	Retinol?	Milk	Retinol transporter?
E-RABP	18.5	RA = 9cRA	Epididymis	RA/9cRA transporter
Intracellular lipid-binding proteins				
CRBP	14.6	Retinol $\gg$ retinal	Many (e.g., liver, kidney, testis)	<i>holo</i> : substrate for LRAT and RoDH <i>apo</i> : stimulates REH; inhibits LRAT
CRBP(II)	14.6	Retinol = retinal	Intestine	<i>holo</i> : substrates for LRAT and retinal reductase
CRABP	15	RA $\gg$ 9cRA > 13cRA $\gg$ 9,13cRA	Many (e.g., testis, lung, kidney)	<i>holo</i> : substrate for RA metabolism; sequesters RA and possibly RA metabolites
CRABP(II)	15.7	RA $\gg$ 9cRA > 9cRA $\gg$ 9,13cRA	Adult skin, embryo	Same as for CRABP but with different affinities for RAs?
Others				
CRALBP	33	11- <i>cis</i> -retinal, 11- <i>cis</i> -retinol	RPE	Protects retinoids from isomerization
IRBP	145	Retinol, many others	Retina	Lipid transporter



# Struktura a aktivace retinoidních receptorů:

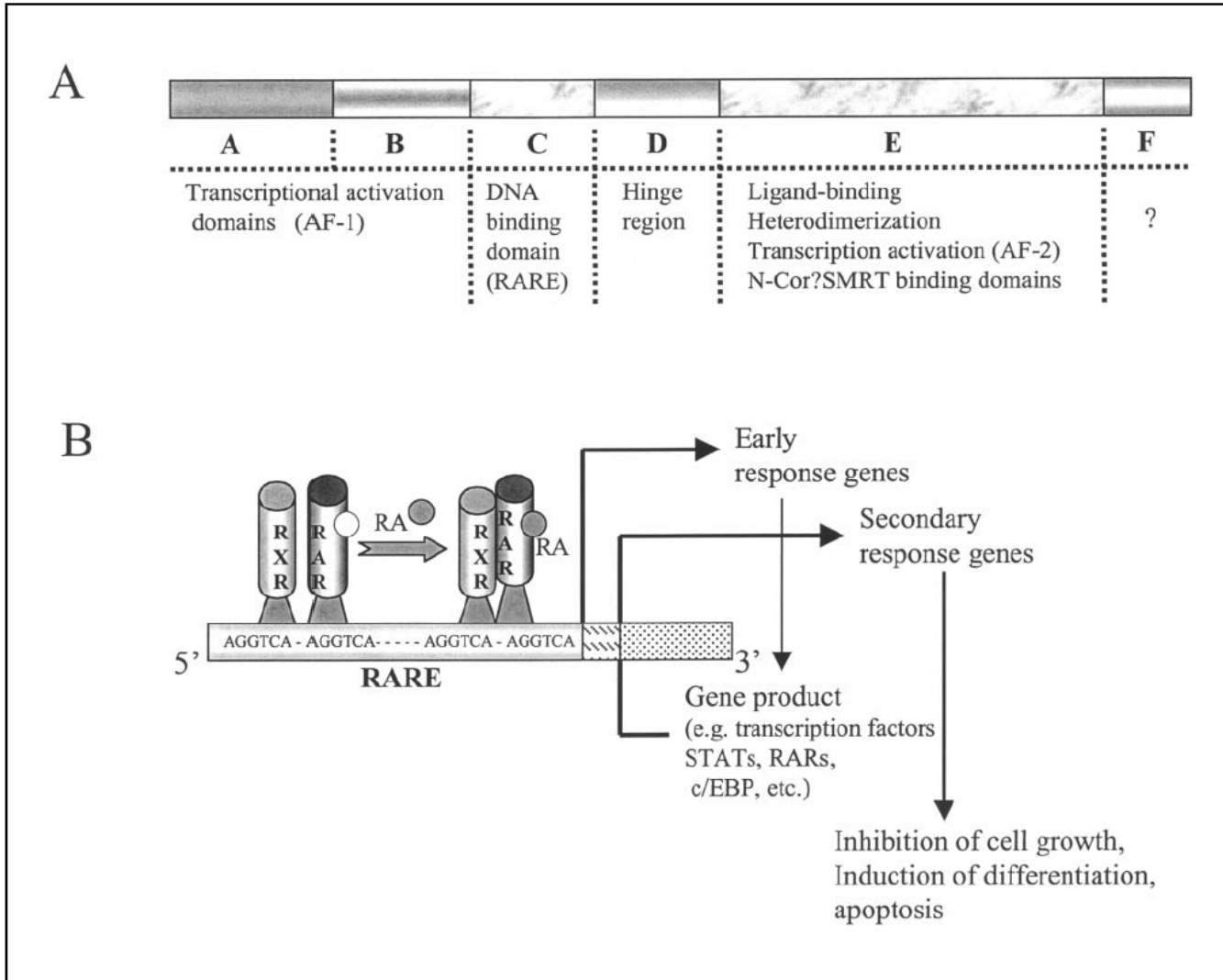

Fig. 1 - Structure and functions of retinoid receptors. A) Schematic representation of retinoid receptor protein depicting various functional domains. B) A molecular model for retinoid action. The liganded RAR forms heterodimer with RXR, binds to specific regulatory sequences (RARE) in the promoter region of target genes. Transactivation of such early response genes is a primary event of retinoid action. In addition to this, the products of early response genes can activate the transcription of secondary genes. Transactivation of these genes therefore represents secondary action of retinoids since their transcription requires protein synthesis. This cascade of gene events leads to secondary and tertiary events that eventually produce a phenotype that is characteristic of retinoid action.



# Struktura a aktivace retinoidních receptorů:

6

J. Bastien, C. Rochette-Egly / *Gene* 328 (2004) 1–16

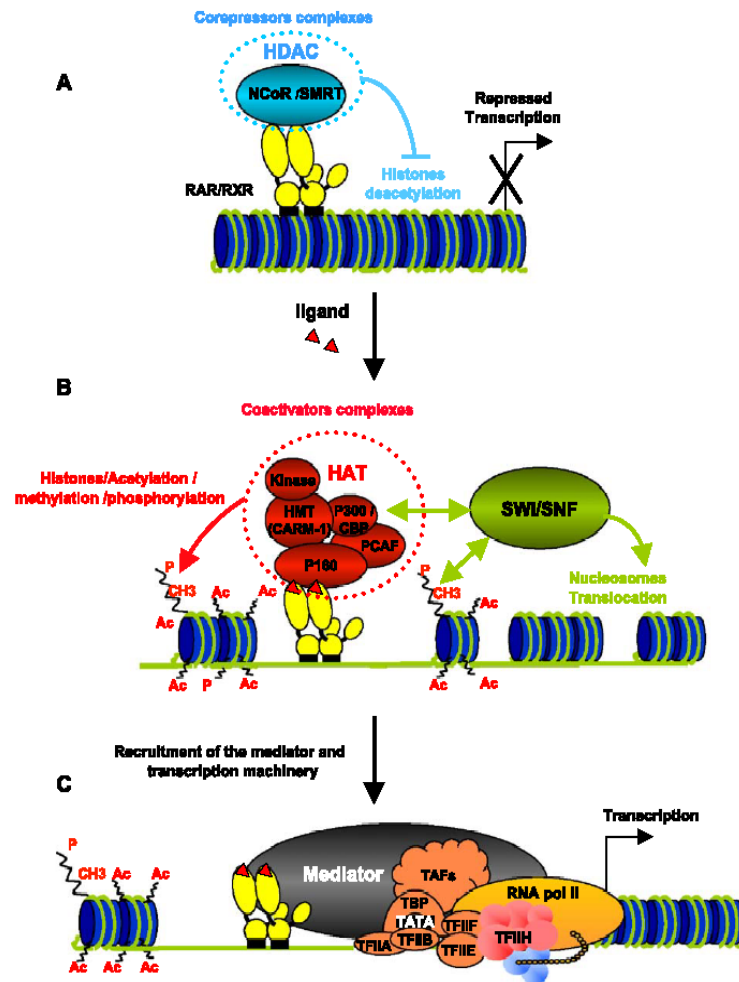

Fig. 5. Three-step mechanism of retinoid receptor action. (A) In the absence of ligand, retinoid receptors bound to response elements located in the promoter of target genes are associated with histone deacetylase-containing (HDAC) complexes tethered through corepressors and repress transcription. (B) Upon ligand binding, the corepressors dissociate, allowing the recruitment of coactivators associated with complexes displaying histone acetyltransferase (HAT), methyltransferase, kinase or ATP-dependent remodeling (SWI/SNF) activities that decompact repressive chromatin. (C) In the third step, the coactivators dissociate and the SMCC mediator complex assembles. Then the mediator expedites entry of the RNA Pol II and the general transcription factors to the promoter, resulting in transcription initiation.

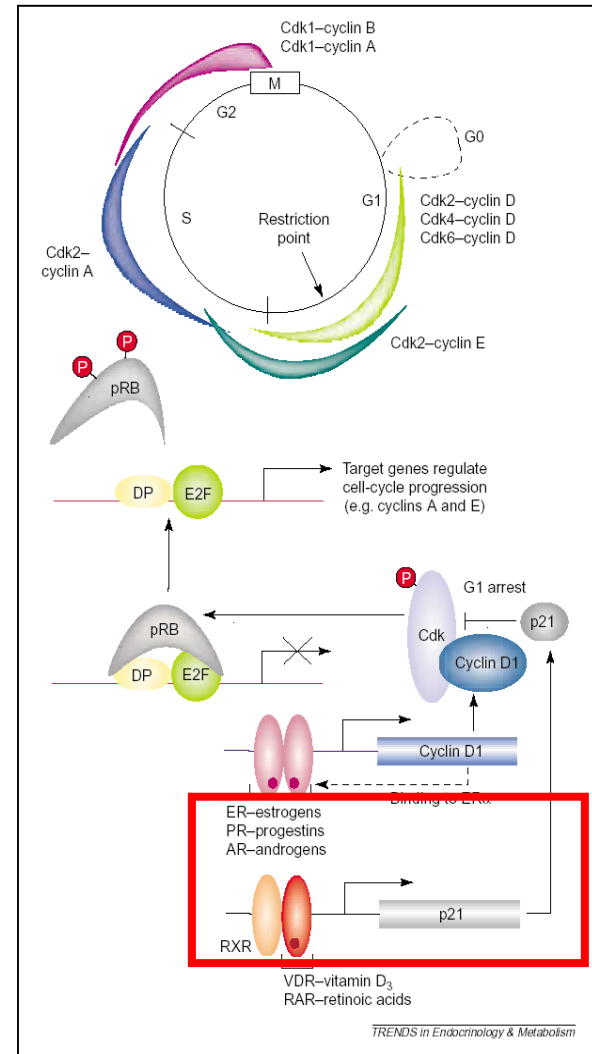

Fig. 2. Scheme illustrating cell-cycle regulation by certain nuclear receptors. The cell cycle phases G0, G1, S, G2 and M are depicted in (a), together with a schematic illustration of the corresponding levels of the various Cdk-cyclin complexes. Some steroid receptors (ER, AR and PR) stimulate expression of the gene that encodes cyclin D1, which interacts with and activates Cdk4. The activated cyclin-Cdk complex phosphorylates pRB, which dissociates from the pR-E2F complex, thus allowing transcription of cell cycle regulatory genes. In an opposite regulatory mode, vitamin D<sub>3</sub> and retinoic acids can induce expression of the CKI p21, which blocks Cdk activity, resulting in G1 arrest of treated cells, such as U937. Abbreviations: See Glossary.

# Receptory aktivované peroxizómovými proliferátory (PPAR)





# Struktura a aktivace PPAR:

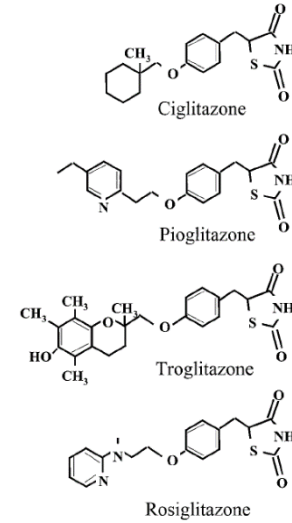
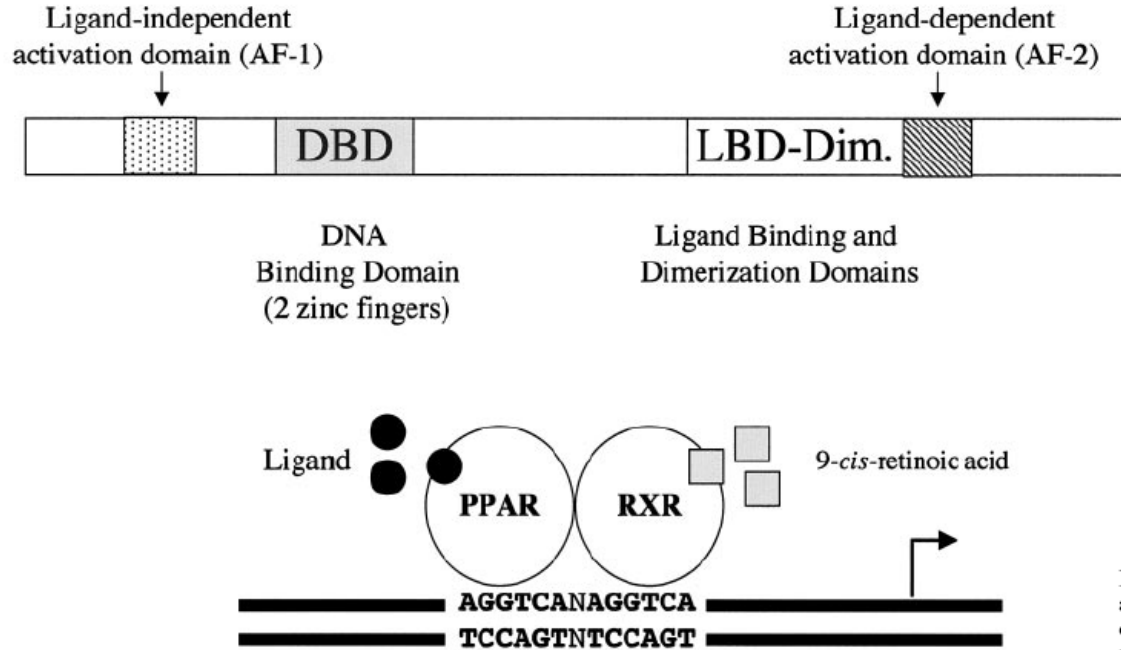
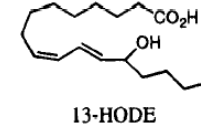
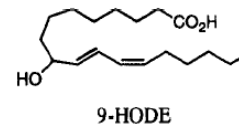
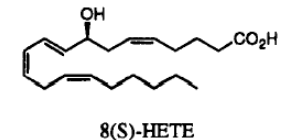
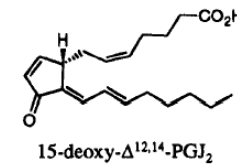
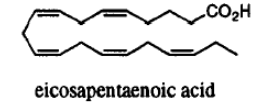
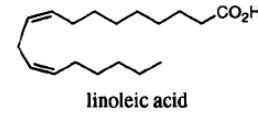
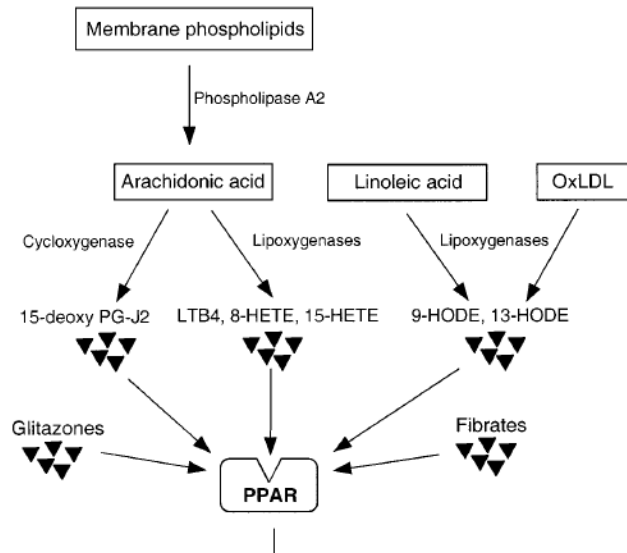

FIG. 1. General structure and mechanism of action of PPARs. PPAR isoforms share a common domain structure and molecular mechanism of action.



# Cílové geny PPAR:

Gene	Localization of PPRE	PPRE	function of gene product
ACO	(-570/-558)	→ → TGACCTtTGTCTT	First step in fatty acid β-oxidation
	(-214/-202)	→ → TGACCTtCTACCT	
HD	(-2939/-2927)	→ → → TGACCTaTGAActATTACCT	Second and third step in fatty acid β-oxidation
C-ACS	(-175/-154)	→ → → → TGACTGaTGCCCTgaaAGACCT	Conversion of fatty acids into acyl-CoA derivatives
CYP4A6	(-650/-662)	→ → → TCACTTtTGCCCTAGTTCA	Formation of dicarboxylic acids by α-oxidation
	(-728/-740)	→ → → GGACCTTGCCCTtTGTCTT	
	(-27/-1)	→ → TGACCTtTGCCCA	
HMG-CoAS	(-104/-92)	→ → AGACCTtTGCCCC	Liver ketogenesis
MCAD	(-301/-336)	→ → → TGGTCAgacctTCACCT-TTACCggagagaa AGGTCA	First step in β-oxidation of medium-chain fatty acids
L-FABP	(-68/-56)	→ → TGACCTaTGCCCT	Liver fatty acid binding protein
aP2	(-5222/-5209)	→ → GGATCAgAGTTCA	Adipose tissue fatty acid binding protein
ME	(-328/-340)	→ → TCAACTtTGACCC	Malate decarboxylation, providing NADPH for fatty acid synthesis
PEPCK	(-999/-987)	→ → AGACCT-TATCCC	Gluconeogenesis and glyceroneogenesis
LPL	(-169/-157)	→ → TGCCCTtTCCCC	Hydrolysis of triglyceride-rich particles
apo A-I	(-212/-197)	→ → → TGAACcctTGACCCcTGCCCT	Protein component HDL, co-factor LCAT
apoA-II	(-734/-716)	→ → CAACCTtTACCCT	Protein component HDL
Consensus		→ → TGACCT <sub>g</sub> TGACCT	



# Úloha PPAR v organismu:

**PPARs** jsou aktivovány vícenenasycenými mastnými kyselinami, eikosanoidy a řadou syntetických látek. Vzhledem k různé expresi isoform PPARG hraje každý typ PPAR unikátní roli v organismu:

**PPAR $\alpha$**  je hlavní regulátor katabolismu mastných kyselin - kontrola exprese řady proteinů podílejících se na transportu a metabolismu mastných kyselin, především v játrech - liver fatty acid-binding protein, ABC transportéry, ABCD2 and ABCD3 - transport mastných kyselin do peroxizómů -  $\beta$ -oxidace mastných kyselin; jaterní CYP4A enzymy - katalýza  $\omega$ -oxidace ligandů PPAR $\alpha$ .

**PPAR $\gamma$**  je klíčový regulátor adipogeneze a hraje významnou roli buněčné diferenciaci, citlivosti na inzulín, rozvoji aterosklerózy a nádorových onemocnění. Mezi jeho ligandy patří mastné kyseliny, metabolity kyseliny arachidonové, triterpenoidy a některá léčiva (např. thiazolidinediony). Na rozdíl od PPAR $\alpha$ , PPAR $\gamma$  napomáhá ukládání tuků prostřednictvím posílení diferenciaci adipocytů a indukce syntézy lipogenních proteinů.

Funkce **PPAR $\delta$**  jsou méně známé. Jeho ligandy zahrnují mastné kyseliny s dlouhým řetězcem, karboprostacyklin a předpokládá se, že ovlivňuje metabolismus lipidů ve periferních tkáních.



# Ligandy PPAR:

*P. Escher, W. Wahli / Mutation Research 448 (2000) 121–138*

127

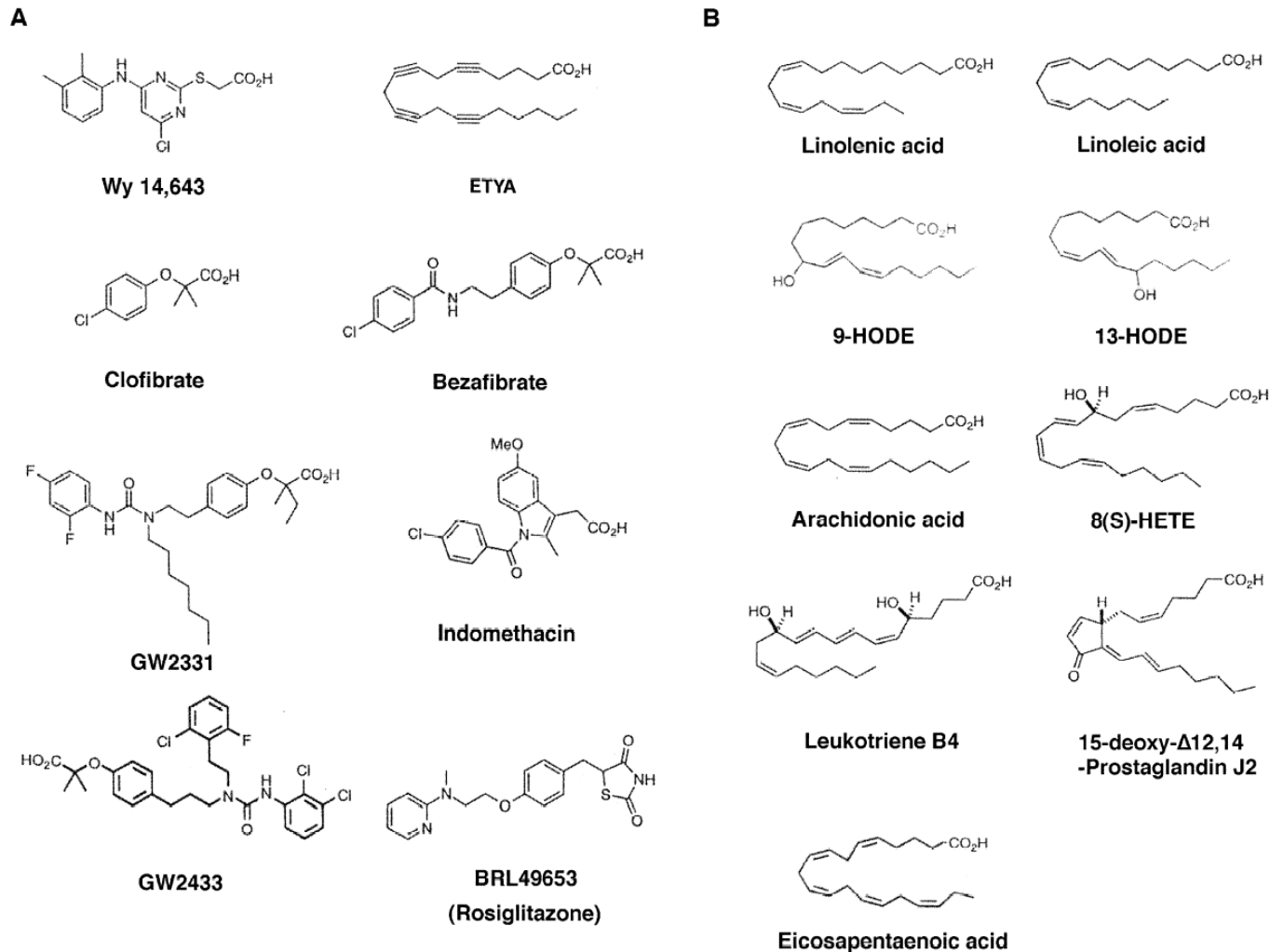

Fig. 4. Natural and synthetic PPAR ligands. (A) Synthetic PPAR agonists comprise peroxisome proliferators (Wy 14,643), fatty acid analogs (ETYA), fibrates (Clofibrate, Bezafibrate, GW2331, GW2433), non-steroidal anti-inflammatory drugs (Indomethacin) and thiazolidinediones (Rosiglitazone). (B) Natural PPAR agonists comprise polyunsaturated fatty acids and their metabolites.



# Pregnanový X receptor (PXR)

- aktivuje expresi genů obsahujících tzv. PXR responzivní elementy (PXRRE);
- nejznámější cílový gen je **CYP3A4**; indukuje ale i další enzymy I. a II. fáze biotransformace - ALDH, CYP2B, SULT, UGT;
- **CYP3A podrodina** – nejrozšířenější CYPy v játrech a střevní tkáni s velmi širokou substrátovou specifitou, které hrají zásadní roli při odbourávání celé řady léčiv, ale i toxických látek;



# Cytochromy P450

Cytochromy P450 (CYPy) představují velkou rodinu enzymů obsahujících hem, které katalyzují metabolismus řadu endogenních a exogenních substrátů:

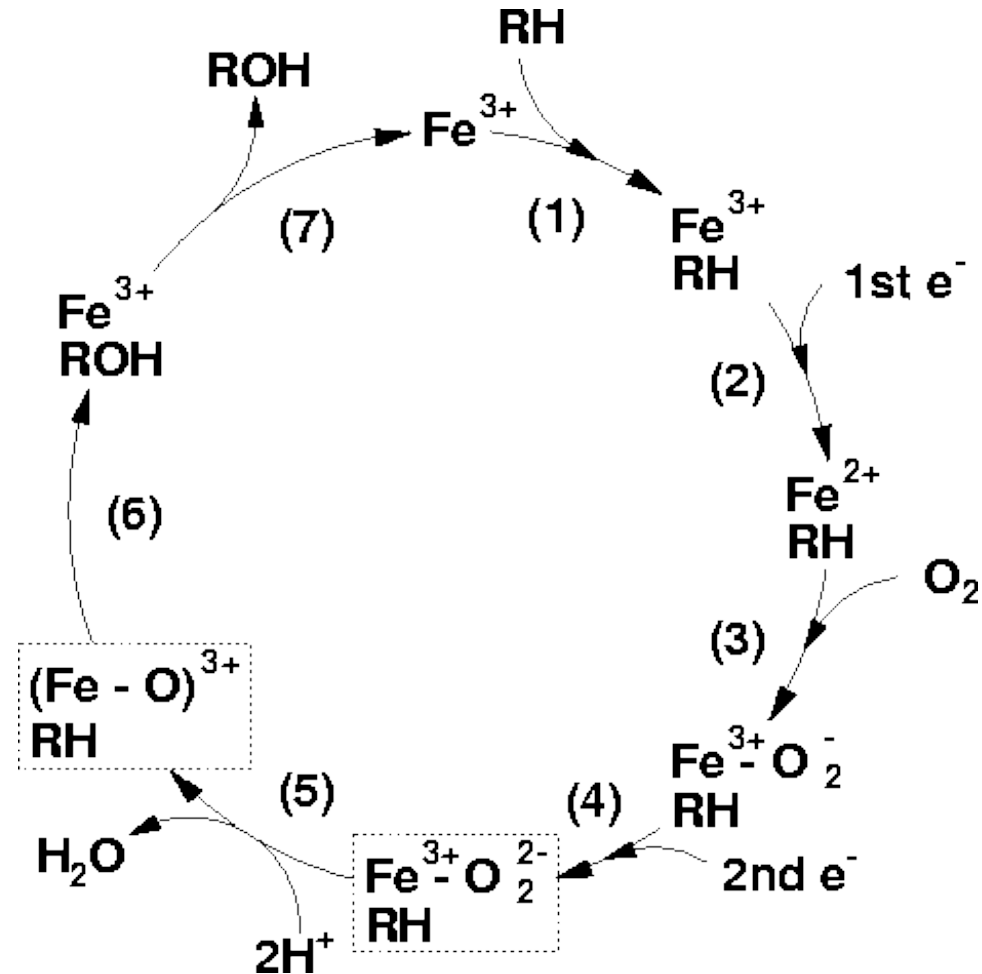
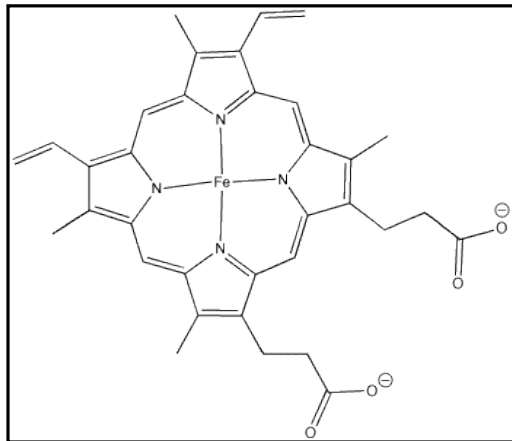

# Cytochromy P450

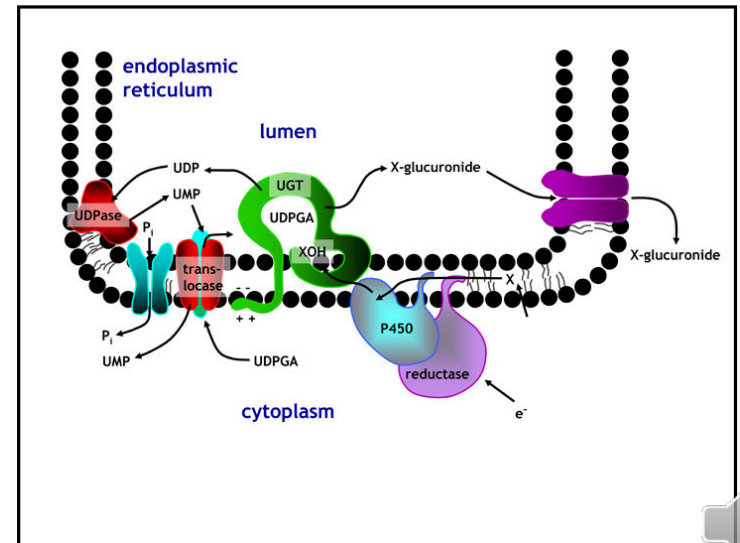
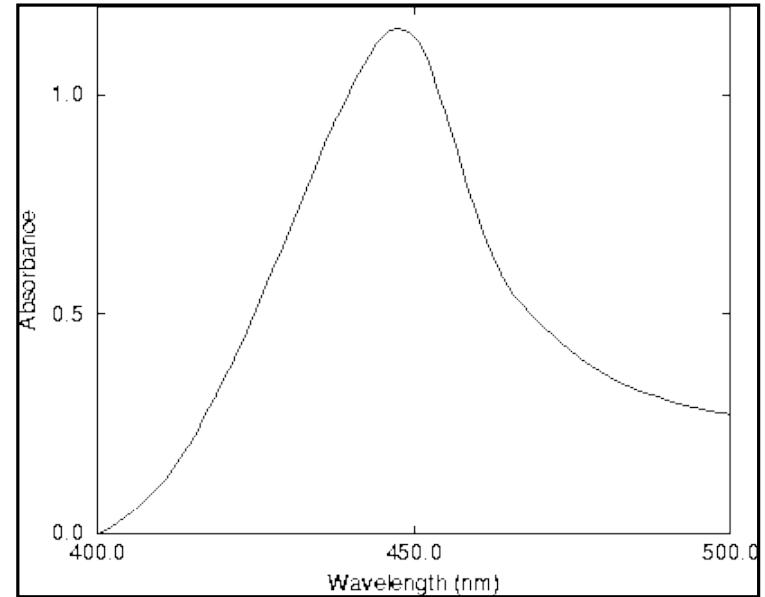
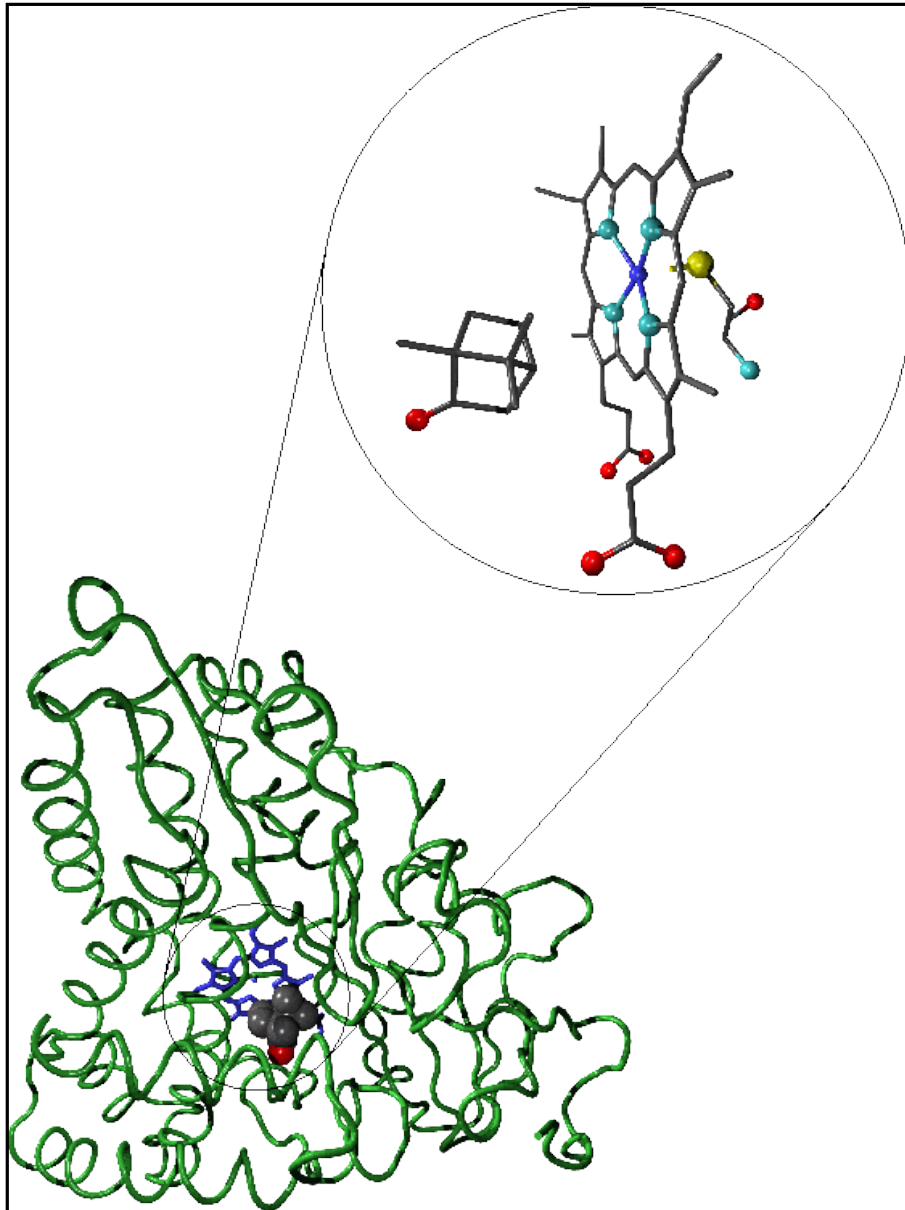

# Cytochromy P450

Table 2 | Functions of human CYP enzymes

Family	Number of subfamilies	Number of genes	Substrates/function
CYP1	2	3	Metabolism of eicosanoids* and xenobiotics; in addition, CYP1A2 metabolizes melatonin, oestrogen, uroporphyrin and ~24 drugs
CYP2	13	16	Metabolism of eicosanoids*, xenobiotics and many drugs
CYP3	1	4	Metabolism of eicosanoids*, xenobiotics and many drugs
CYP4	6	12	Metabolism of eicosanoids*, xenobiotics and few drugs
CYP5	1	1	Thromboxane A <sub>2</sub> synthase
CYP7	2	2	Cholesterol, bile acid synthesis
CYP8	2	2	Prostacyclin synthase, bile acid synthesis
CYP11	2	3	Steroidogenesis
CYP17	1	1	Steroid 17-hydroxylase, 17/20-lyase
CYP19	1	1	Oestrogen aromatization
CYP20	1	1	Expressed in gastrula, neural patterning and somitogenesis, organogenesis, fetus and nasopharynx
CYP21	1	1	Steroid 21-hydroxylase
CYP24	1	1	Vitamin D <sub>3</sub> 24-hydroxylase
CYP26	3	3	Retinoic acid hydroxylation
CYP27	3	3	Bile acid biosynthesis, vitamin D <sub>3</sub> hydroxylations
CYP39	1	1	24-hydroxycholesterol 7-hydroxylase
CYP46	1	1	Cholesterol 24-hydroxylase in the central nervous system
CYP51	1	1	Lanosterol 14-demethylase

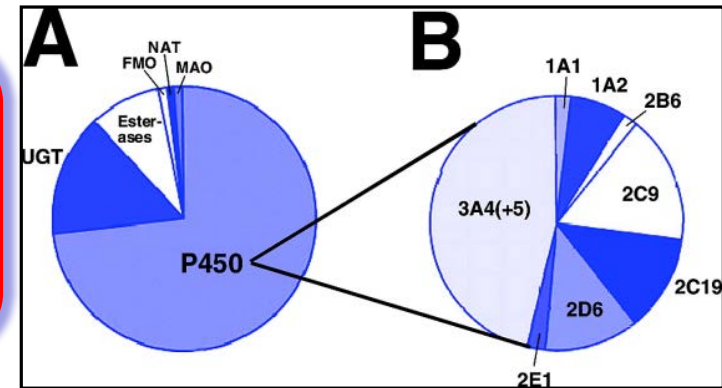

## Box 2 | The CYP gene families

Cytochrome P450 (CYP) proteins are arranged into families and subfamilies, which are derived from per cent amino-acid sequence identity. Proteins that have roughly >40% sequence similarity are members of the same gene family, whereas those with >70% similarity are members of the same subfamily. The development and application of this delightfully logical system of nomenclature<sup>3</sup> has eliminated the confusion that often plagues the naming of gene families and superfamilies. The fact that there are 20 CYP genes in *Mycobacterium tuberculosis* and seven in *Bacillus subtilis* emphasizes the likelihood that the CYP superfamily existed long before the prokaryote-eukaryote split some 2.1 billion years ago<sup>85</sup>, and the earliest ancestor probably arose around the time that the partial pressure of oxygen increased dramatically on the planet. The CYP51 gene exists in bacteria, plants, fungi and animals, indicating that this was probably the first eukaryotic CYP gene. The human, mouse and rat genomes contain 57, 102 and 87 CYP genes, respectively<sup>2</sup>. Orthologous Cyp genes between the mouse and rat generally show 90–92% sequence similarity, human CYP orthologues of rodent Cyp genes are usually 78–82% similar.





# Cytochromy P450 a bioaktivace prokarcinogenů

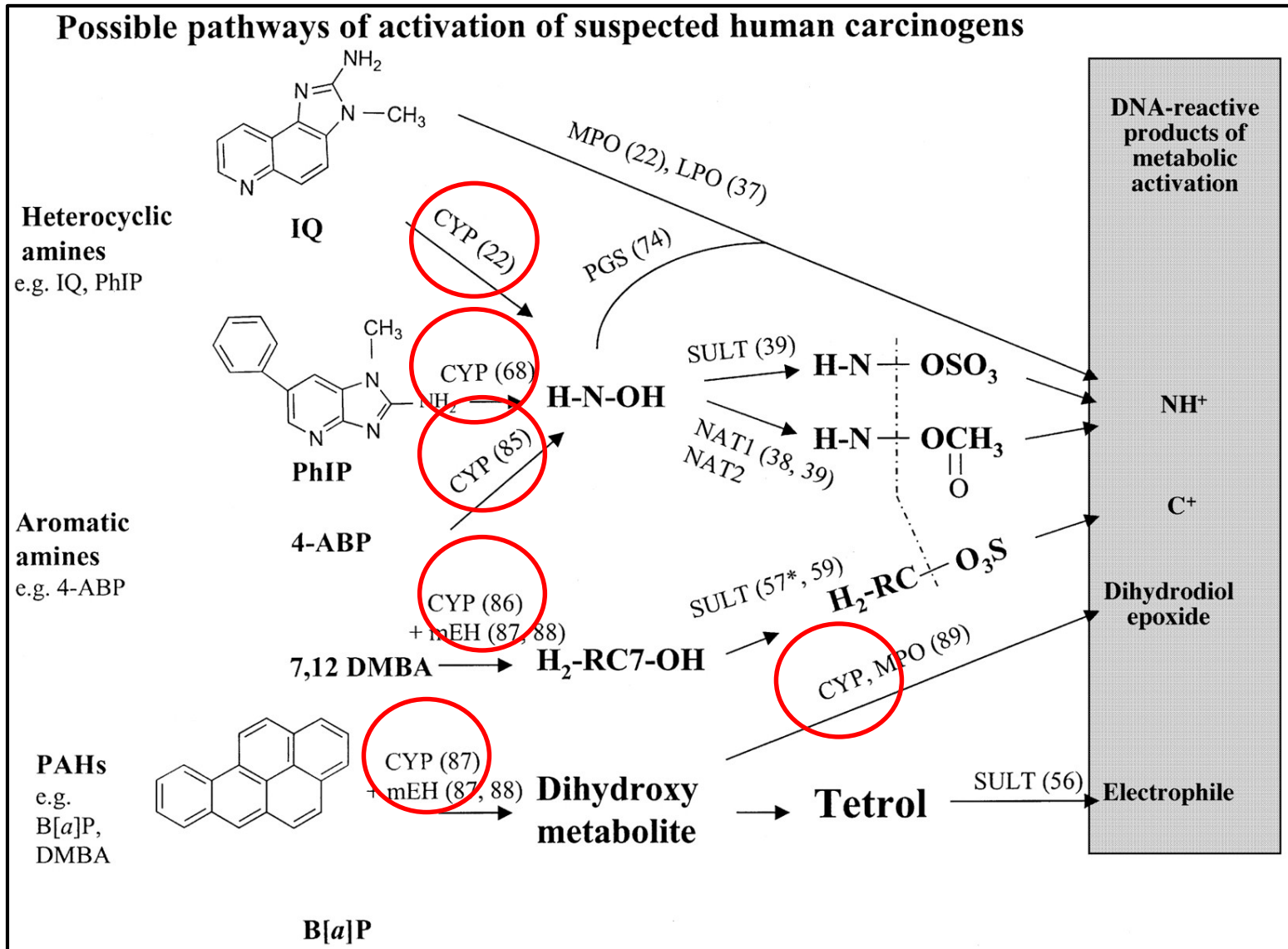

# PXR ligandy

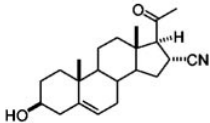

PCN

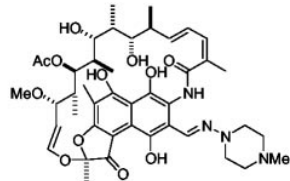

rifampicin

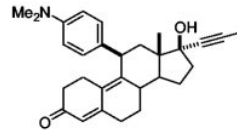

RU486

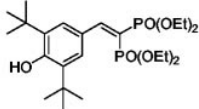

SR12813

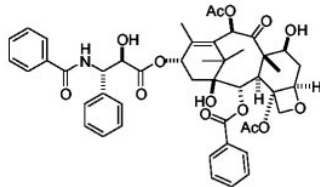

taxol

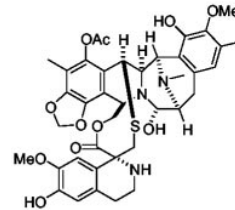

ET-743

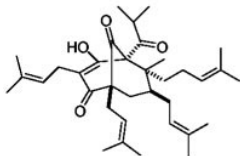

hyperforin

TABLE 1. Drugs that activate human PXR

Drug	Therapeutic Use	Reference(s)
Clotrimazole	Antimycotic	10, 11
Cyproterone acetate	Antiandrogen	10, 80
Dexamethasone	Anti-inflammatory	10
Glutethimide	Sedative	86
4-Hydroxytamoxifen	Anticancer	85
Lovastatin	Antihypercholesterolemic	10
Metyrapone	Diagnostic aid (pituitary function)	79, 154
Mifepristone (RU486)	Abortifacient	10, 11
Nifedipine	Antianginal, antihypertensive	11
Paclitaxel	Anticancer	84
Phenobarbital	Anticonvulsant, sedative	10
Rifampicin	Antibiotic	10, 12, 155
Ritonavir	HIV protease inhibitor	83
St. John's wort	Antidepressant	118, 119
Spirolactone	Antihypertensive	10
Tamoxifen	Anticancer	85
Troglitazone	Antidiabetic	67



# Překryv cílových genů PXR a CAR

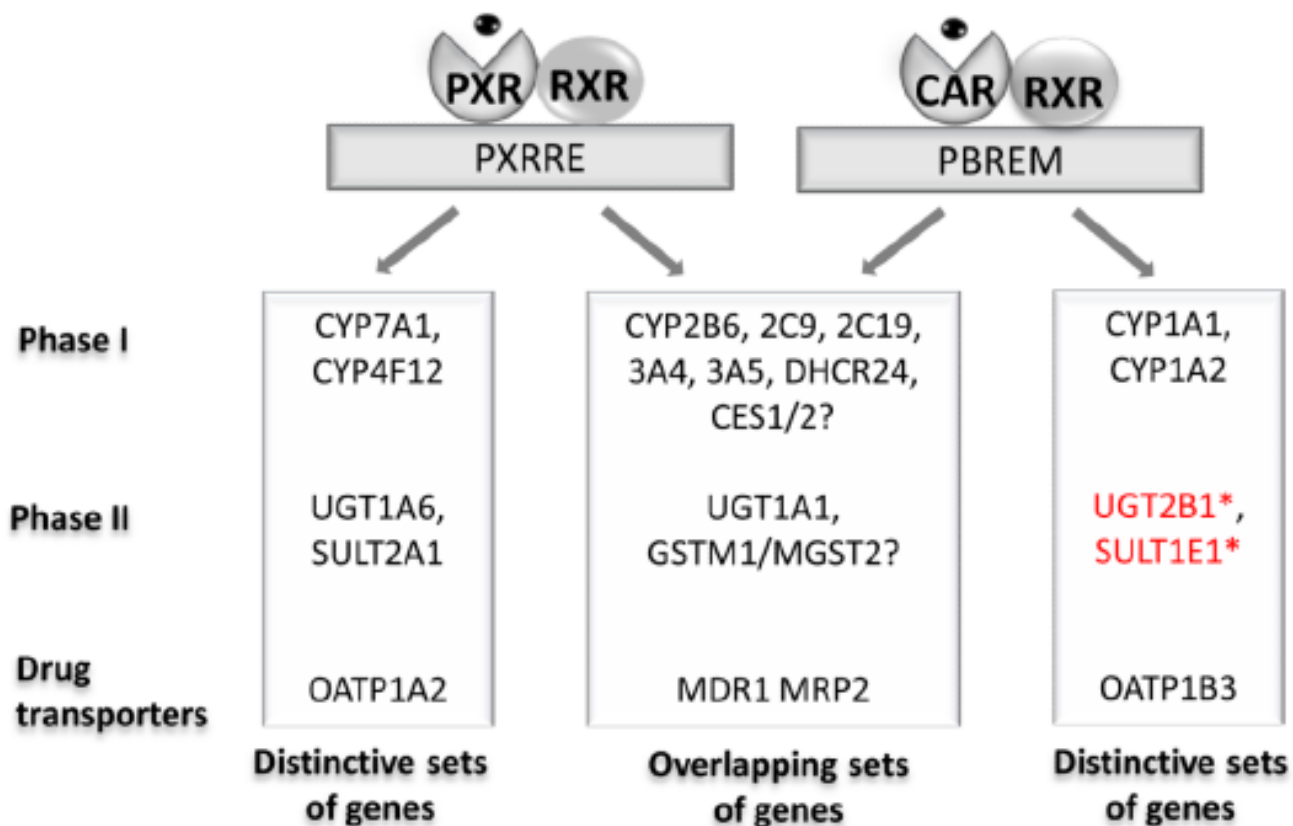

# Konstitutivní androstanový receptor (CAR)

- jak PXR, tak CAR hrají významnou úlohu v regulaci detoxifikace xenobiotik, která umožňuje ochranu organismu před toxickými chemikáliemi;
- oba receptory mají některé společné rysy: široké spektrum ligandů s variabilní strukturou a schopnost regulovat jak společné tak odlišné geny zapojené do biotransformace xenobiotik;
- jak PXR, tak CAR jsou aktivovány řadou konvenčních léčiv, což je spojeno s nežádoucími lékovými interakcemi;
- aktivita PXR je kontrolována transkripčně dalšími jadernými receptory (GR), interakcí s ko-faktory a na post-translační úrovni řadou modifikací – fosforylace, ubikvitinace, SUMOylace a acetylace;



# Konstitutivní androstanový receptor (CAR)

- jaderné receptor, řazený mezi tzv. sirotčí jaderné receptory (není znám jeho přirozený endogenní ligand);
- je aktivován jak některými toxickými endogenními metabolity, tak toxickými exogenními sloučeninami;
- exprese CAR – vysoká hladina zejména v játrech;
- modelový ligand – opět druhově specifický **CITCO** (6-(4-chlorophenyl)imidazo[2,1-b][1,3]thiazole-5-carbaldehyde O-(3,4-dichlorobenzyl)oxime) – specifický pro člověka; **TCPOBOP** (1,4-bis[2-(3,5-dichloropyridyloxy)] benzene) – aktivuje myší CAR; navíc nepřímá aktivace – např. **fenobarbital**;

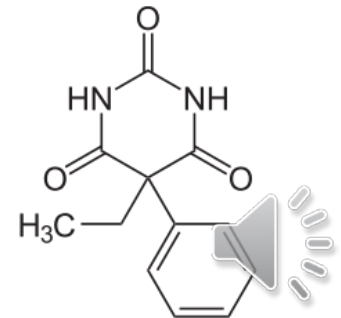
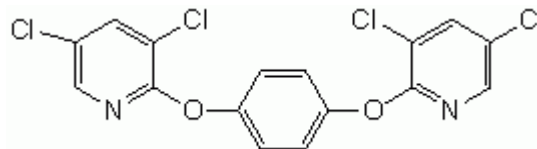
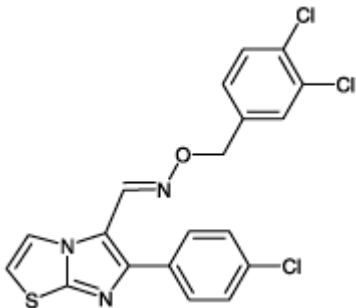

# Aktivace CAR

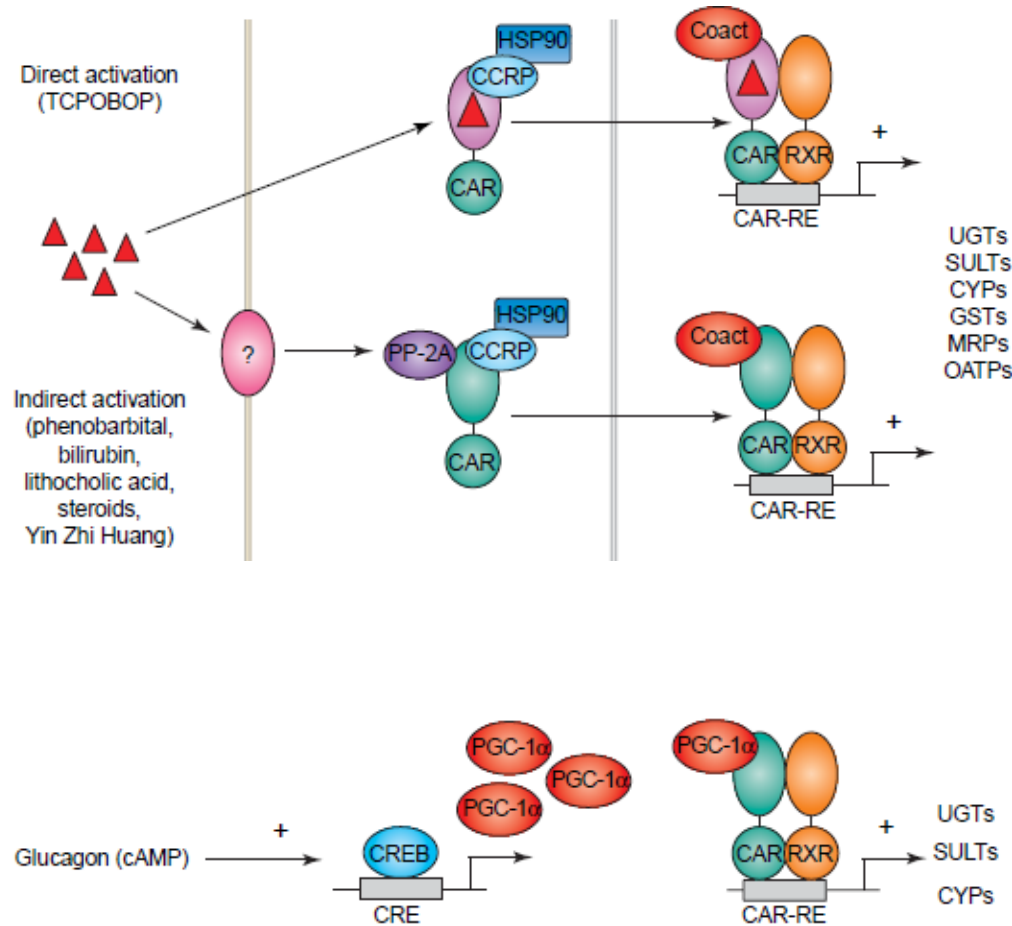

- v inaktivním stavu je CAR v cytoplasmě navázán na *CAR cytoplasmic retention protein* (CCRP) a *heat shock protein 90* (HSP90);
- CAR může být aktivován přímo, vazbou ligandu (TCPOBOP) nebo nepřímo prostřednictvím enzymů jako je např. protein fosfatáza 2A (PP-2A);
- po aktivaci je CAR translokován do jádra kde se váže na CAR-respozivní elementy (CAR-RE/PBREM) v regulačních oblastech genů kontrolujících metabolismus xenobiotik, steroidů, žlučových kyselin a žlučových barviv – po navázání ko-aktivátorů je aktivována transkripce cílových genů;
- vedle aktivace ligandy může být CAR aktivován také např. nutričním stresem – při hladovění je indukována exprese *peroxisome proliferator-activated receptor  $\gamma$  coactivator 1 $\alpha$*  (PGC-1 $\alpha$ ) – který funguje jako ko-aktivátor CAR-regulované transkripce;



# Ligandy CAR

Species-specific action of compounds on CAR\*

Classification	Compound	Activation/deactivation
Activator of hCAR	acetaminophen	?
	artemisinin	?
	atorvastatin	?
	diazepam	?
	carbamazepine	?
	sulfanilamides	?
	tri- <i>p</i> -methylphenyl phosphate	direct
	triphenyl phosphate	direct
	phenytoin	indirect
	phenobarbital	indirect
	chlorpromazine	?
	6,7-dimethylesculetin	?
	CITCO	direct
	Activator of mCAR	acetaminophen
atorvastatin		?
bilirubin		indirect
meclizine		direct
phenobarbital		indirect
chlorpromazine		?
17 $\beta$ -estradiol		direct
TCPOBOP		direct
Deactivator of hCAR	clotrimazole	direct
	17 $\beta$ -estradiol	direct
	meclizine	?
	PK11195	direct
Deactivator of mCAR	okadaic acid	indirect
	progesterone	direct
	testosterone	direct
	5 $\alpha$ -androstan-3 $\alpha$ -ol	direct
	5 $\alpha$ -androst-16en-3 $\alpha$ -ol	direct
	KN-62	indirect
	KN-93	indirect



# CAR a PXR hrají roli jak v metabolismu xenobiotik, tak v energetickém metabolismu

