



CRYSTALLIZATION

Petr Beňovský



CRYSTALLIZATION – DIFFERENT DEFINITIONS

Crystallization is a phase interconversion of the first order dependent on two parameters – concentration and structure

?

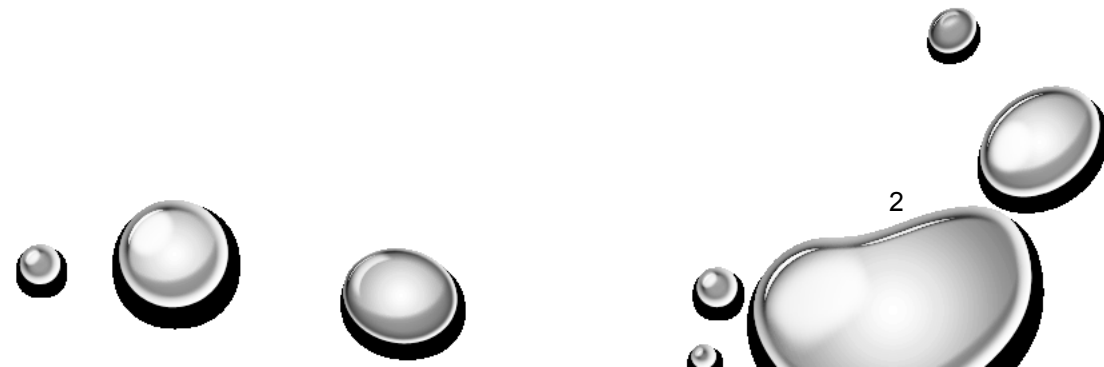

CRYSTALLIZATION – DIFFERENT DEFINITIONS



Crystallization is the natural or artificial process by which a solid forms, where the atoms or molecules are highly organized into a structure known as a crystal.





SOLUBILITY MEASUREMENT

SOLUBILITY

Is a measurement of the **equilibrium** state between a **solid** and a **liquid** phase



EQUILIBRIUM STATES

PHASE DIAGRAMS

- Can help in the selection of a crystallization method, yield determination and temperature of a crystallization process;
- Supersaturation – concentration of a compound in solution is higher than in equilibrium;
- Degree of supersaturation – driving force of crystallization, nucleation and crystal growth;

SOLUBILITY CURVES

van't Hoff equation for ideal solutions:

$$\ln x = \frac{\Delta H_f}{R} \left[\frac{1}{T_f} - \frac{1}{T} \right]$$

Unfortunately, the most of solutions differ from ideal solutions and calculated solubilities of the same compounds for different solvents differ a lot



EXPERIMENTALLY OBTAINED SOLUBILITY CURVES

PHASE DIAGRAM OF ICE POLYMORPHS

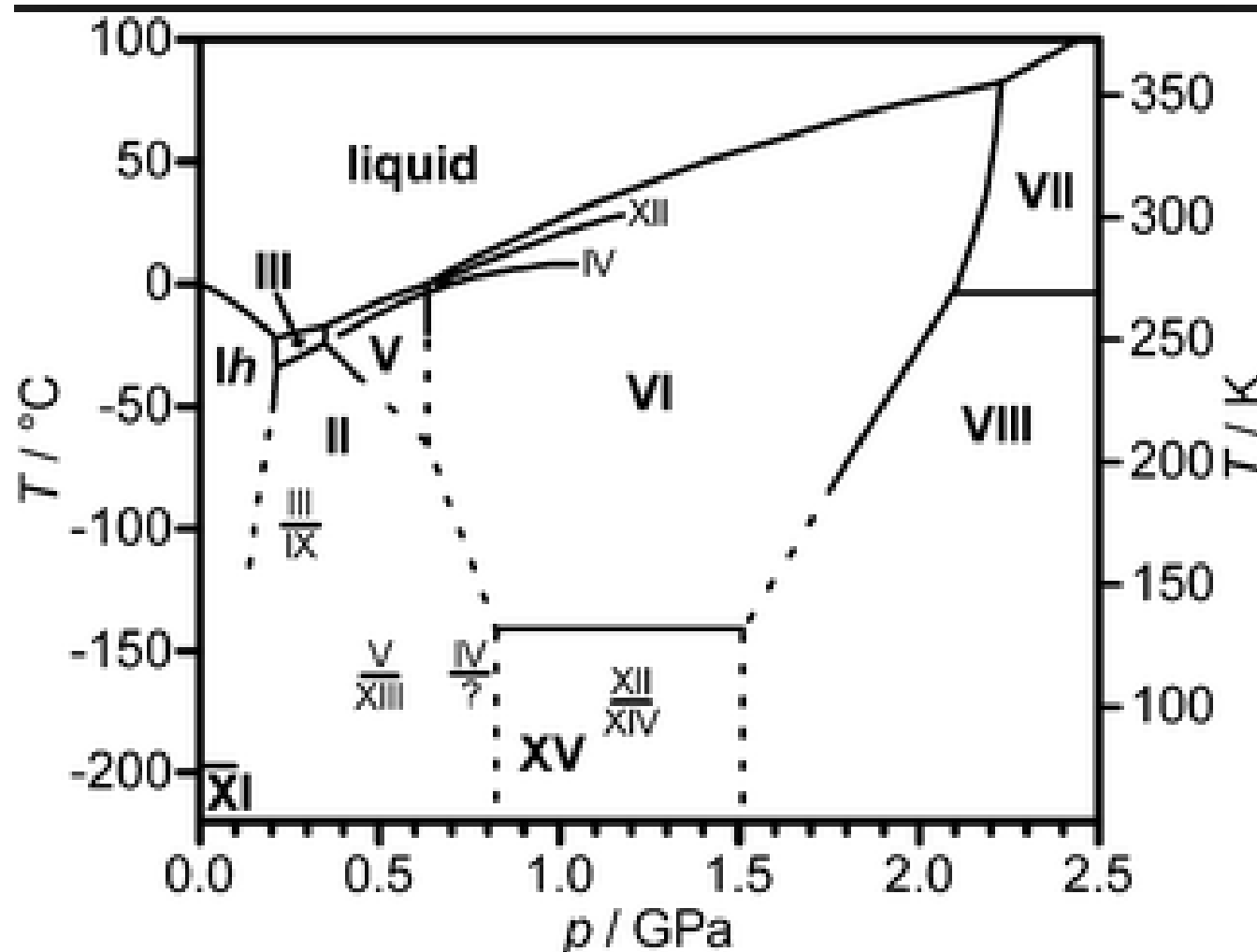

SOLUBILITY CURVE/METASTABLE ZONE FOR PHENACETIN IN ETHANOL

Solubility/super- solubility curve of phenacetin in Ethanol

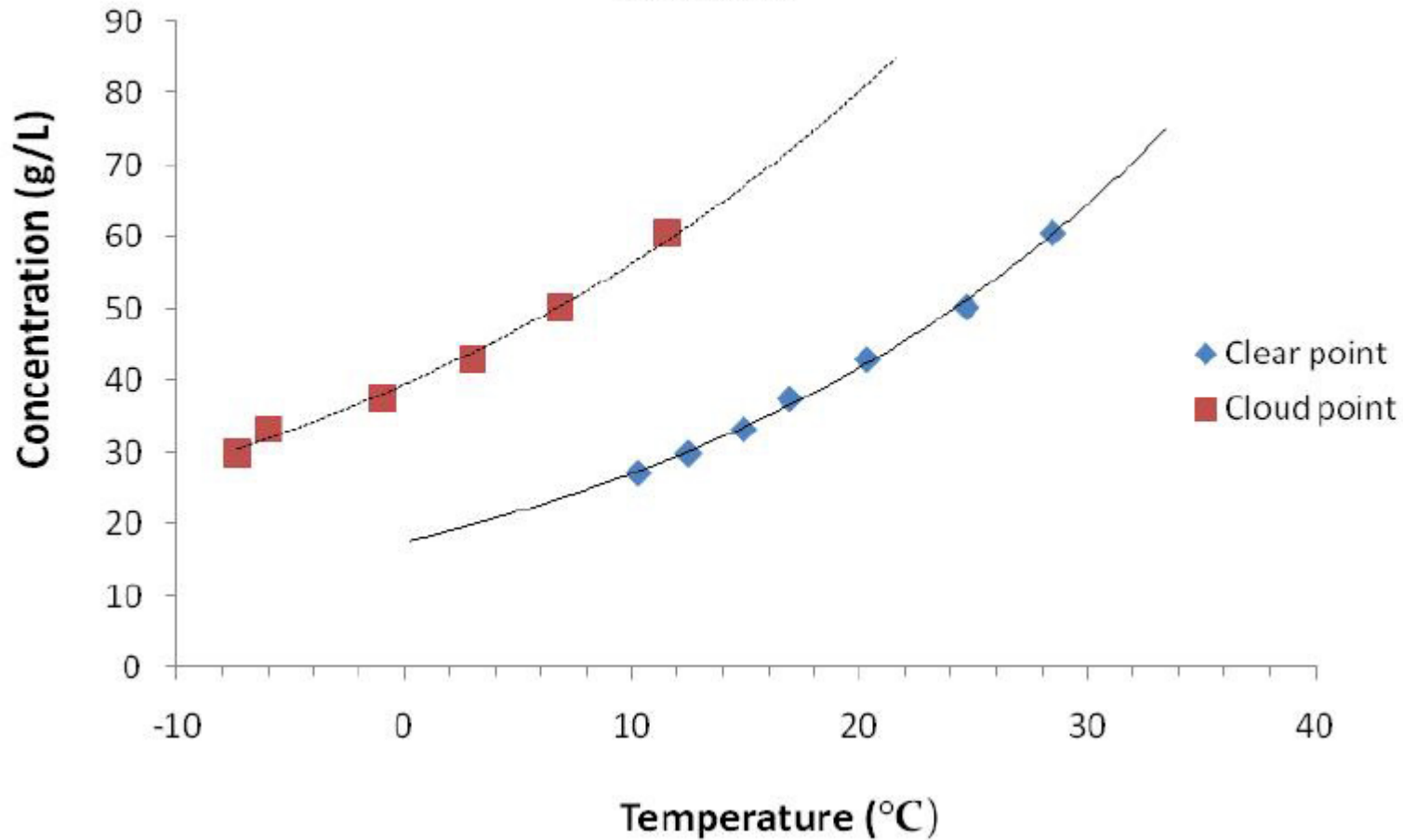

SOLUBILITY MEASUREMENT

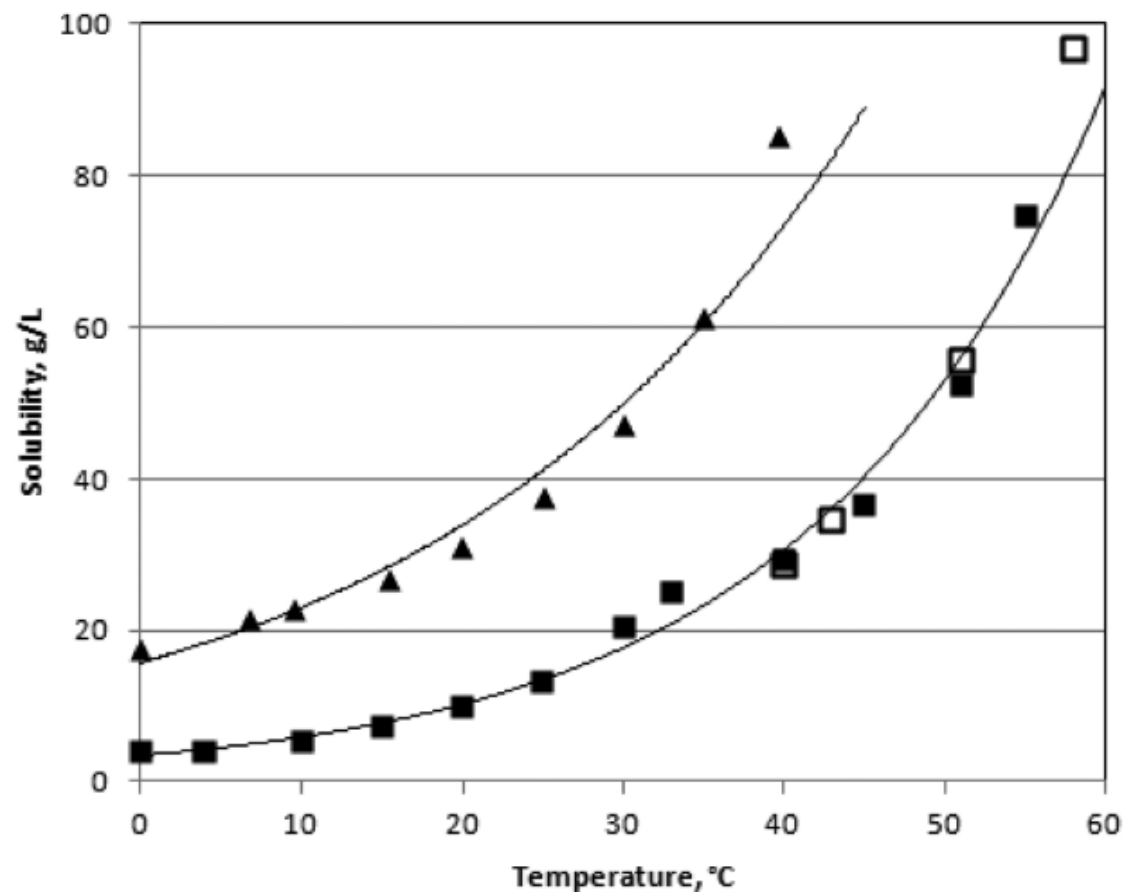
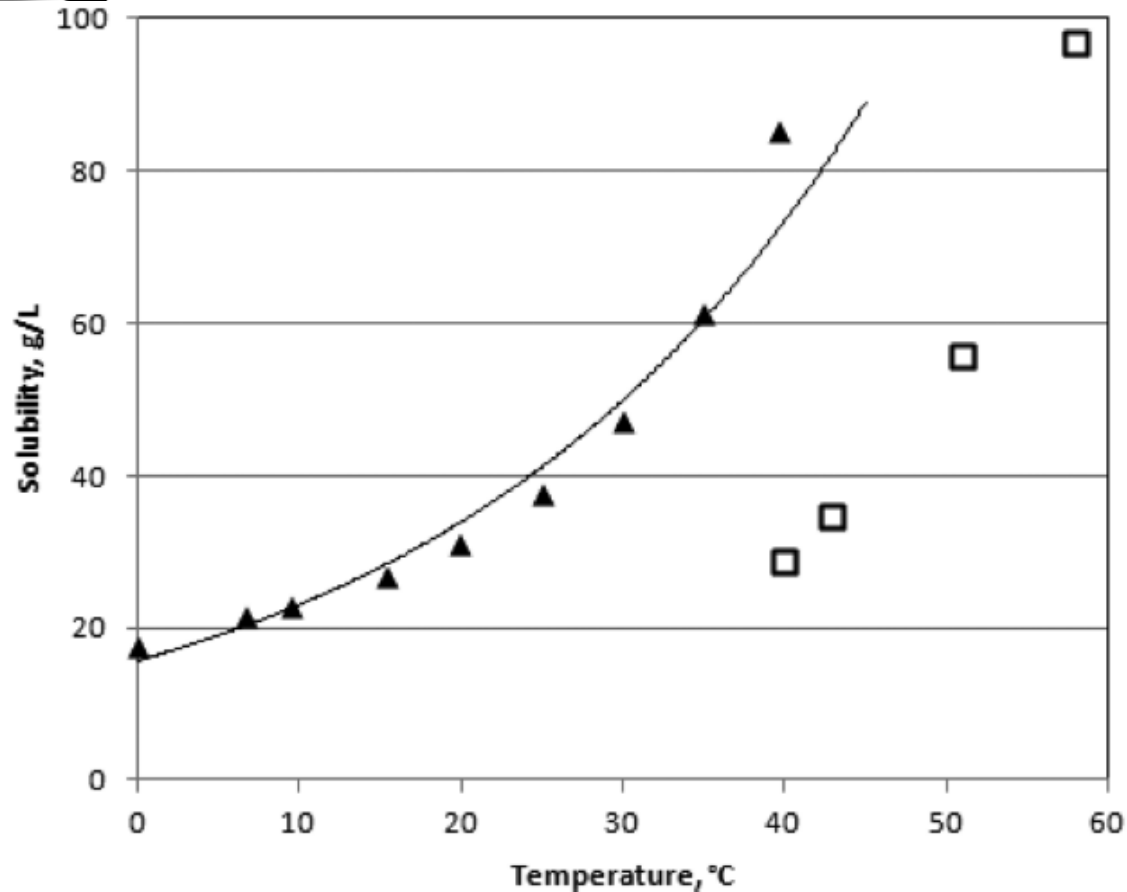

Possibility of polymorph interconversion

THE BLACK'S RULE

Simon Black (Astra Zeneca)

Solubility doubles with every 20 °C increase

Could be used for the solvent selection after the initial screening of solvents;

In cases, where the prediction according to the Black's rule significantly differs from experimentally obtained results, always consider possibility of the formation of solvates or different polymorphs;

Muller, F.L.; Fielding, M.; Black, S. *Org. Process Res. Dev.* 13, 1315 (2009)

Muller, F.L.; Black, S. *Org. Process Res. Dev.* 14, 661 (2010)

THE BLACK'S RULE

Solubility and MSZB Curves for GFB in 2-butanol

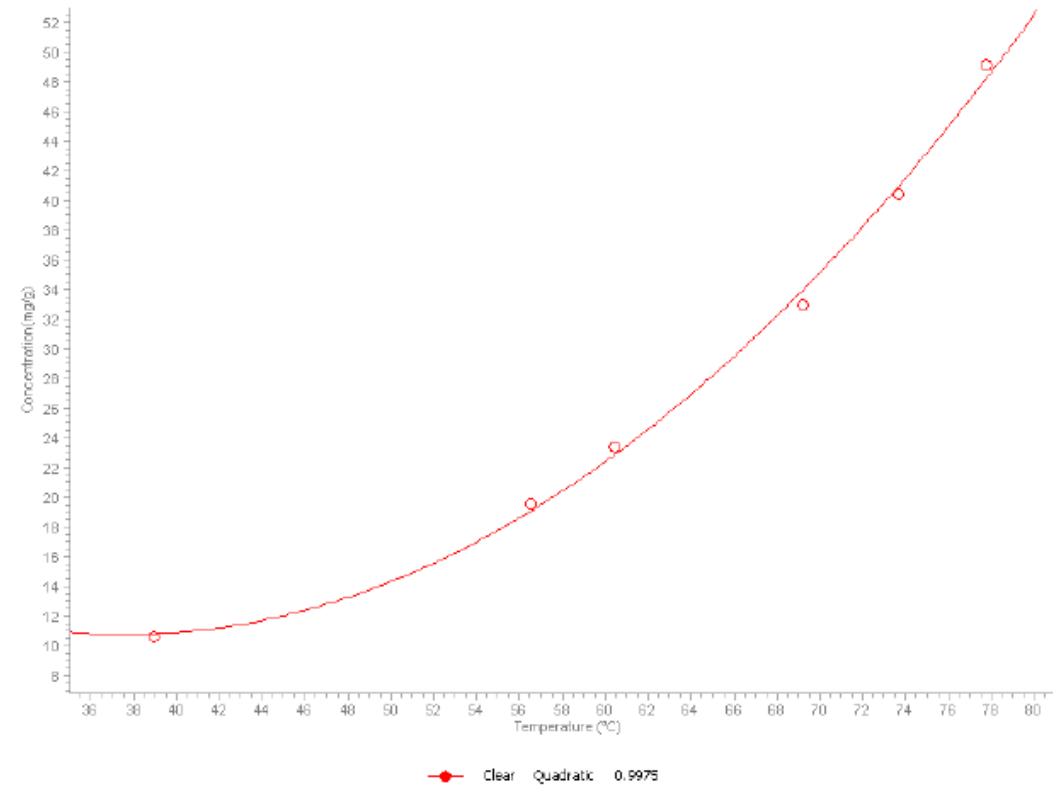

Clear

Concentration [mg/g]	Temperature [°C]	Experiment	Vial	Time [min]
10.61	38.9	GFB in 2-butanol (10.610 mg_g)	1	310.73
19.518	56.53	GFB in 2-butanol (19.518 mg_g)	1	399.17
23.327	60.43	GFB in 2-butanol (23.327 mg_g)	1	418.78
32.894	69.21	GFB in 2-butanol (32.894 mg_g)	1	462.55
40.424	73.7	GFB in 2-butanol (40.424 mg_g)	1	485.35
49.067	77.8	GFB in 2-butanol (49.067 mg_g)	1	505.92

METASTABLE ZONE

Metastability – a term introduced by Ostwald

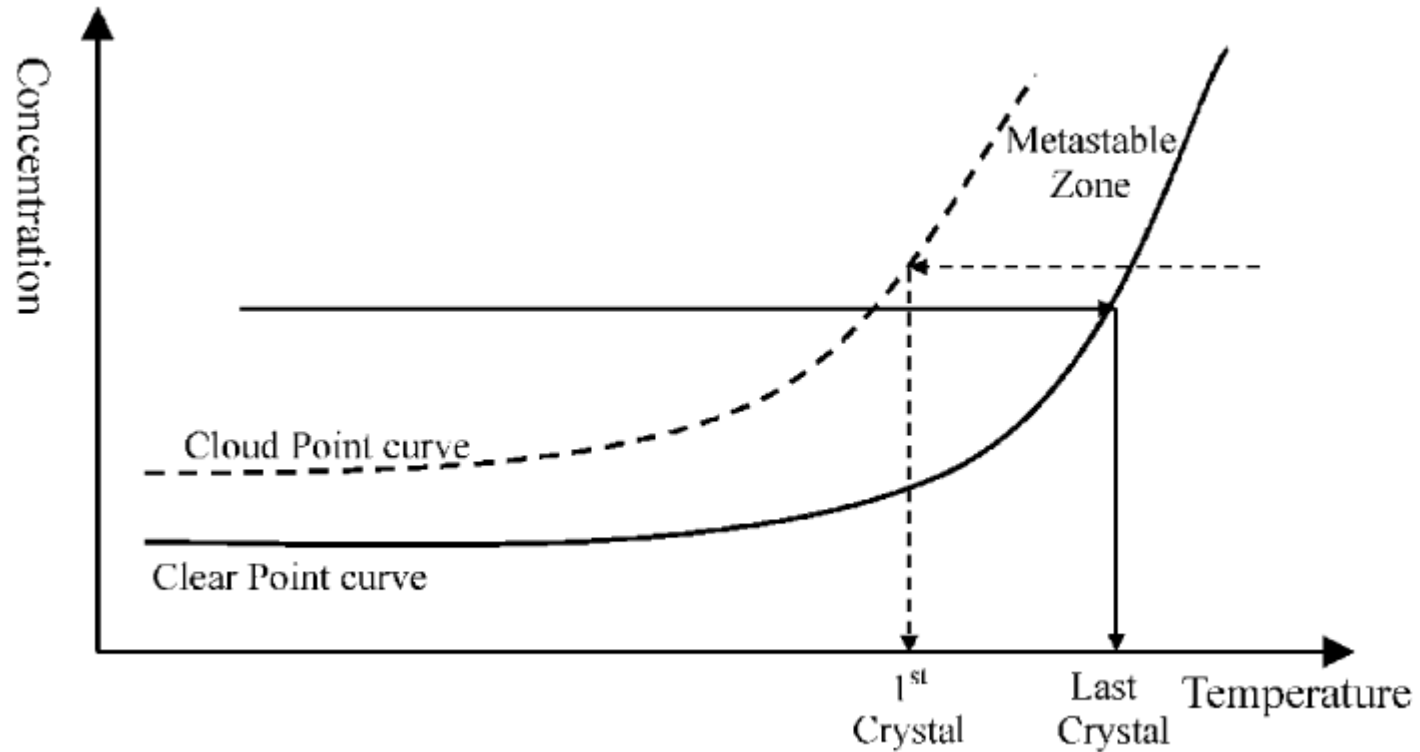

Parsons, A.R.; Black, S.N.; Colling, R. *Trans IChemE 81, Part A, 700 (2003)*

Ideal area for the crystal growth on already formed nuclei

METASTABLE ZONE

- **Metastable zone width – MZW**
- Exert influence on probability of nucleation and seeding options

The metastable zone width depends on types of measurement, temperature gradient, presence of impurities, equipment geometry, use of ultrasound, viscosity of solution, stirring mode

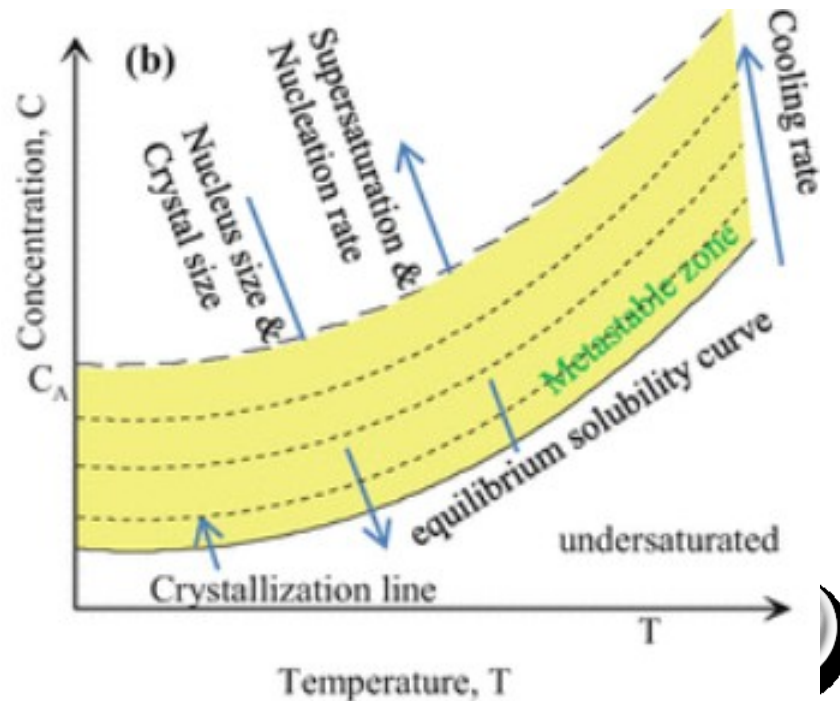

METASTABLE ZONE

Solubility curve and metastable zone determination

CRYSTALLINE (TECHNOBIS)



METASTABLE ZONE

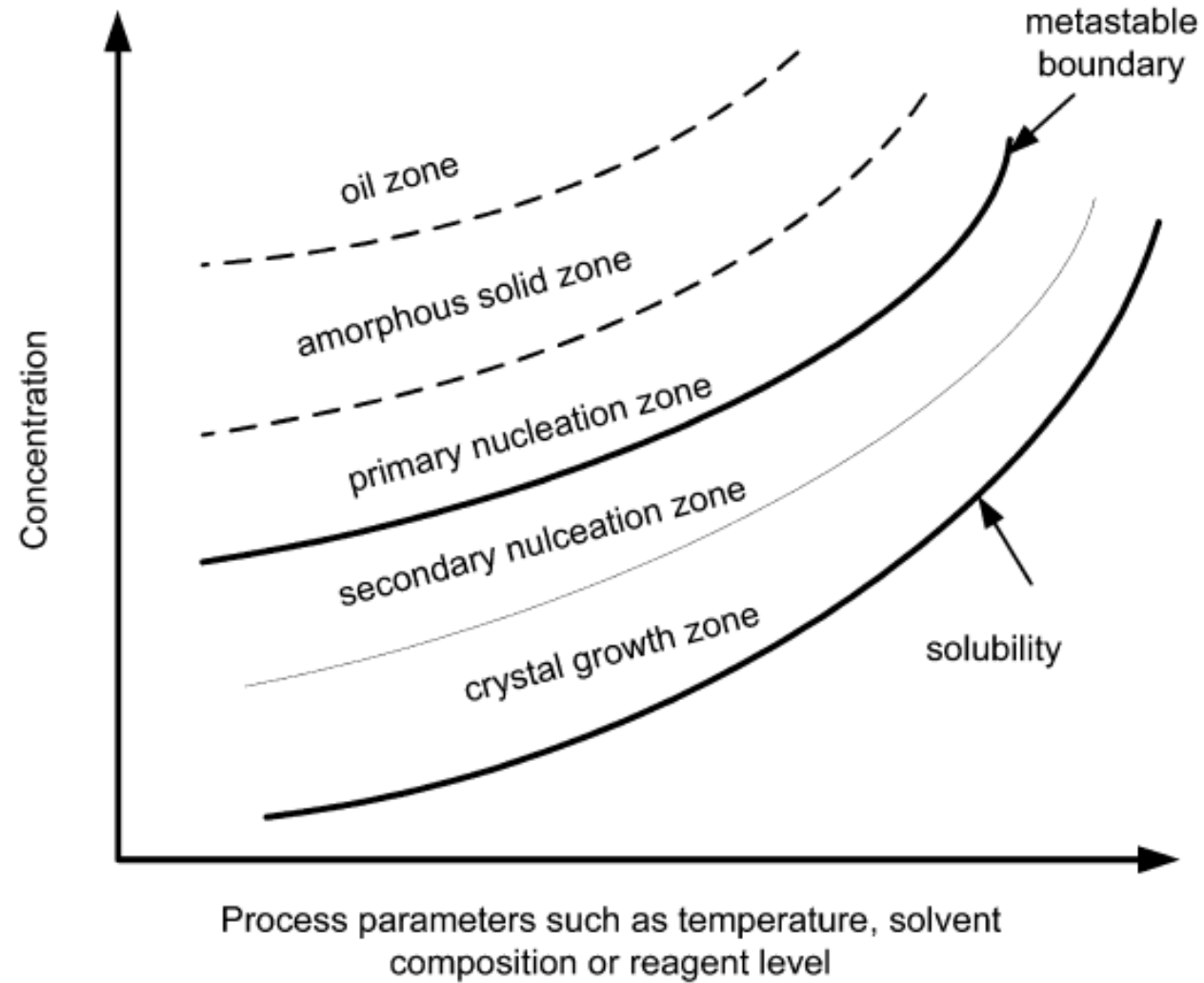

METASTABLE ZONE (AND WHAT NEXT?)

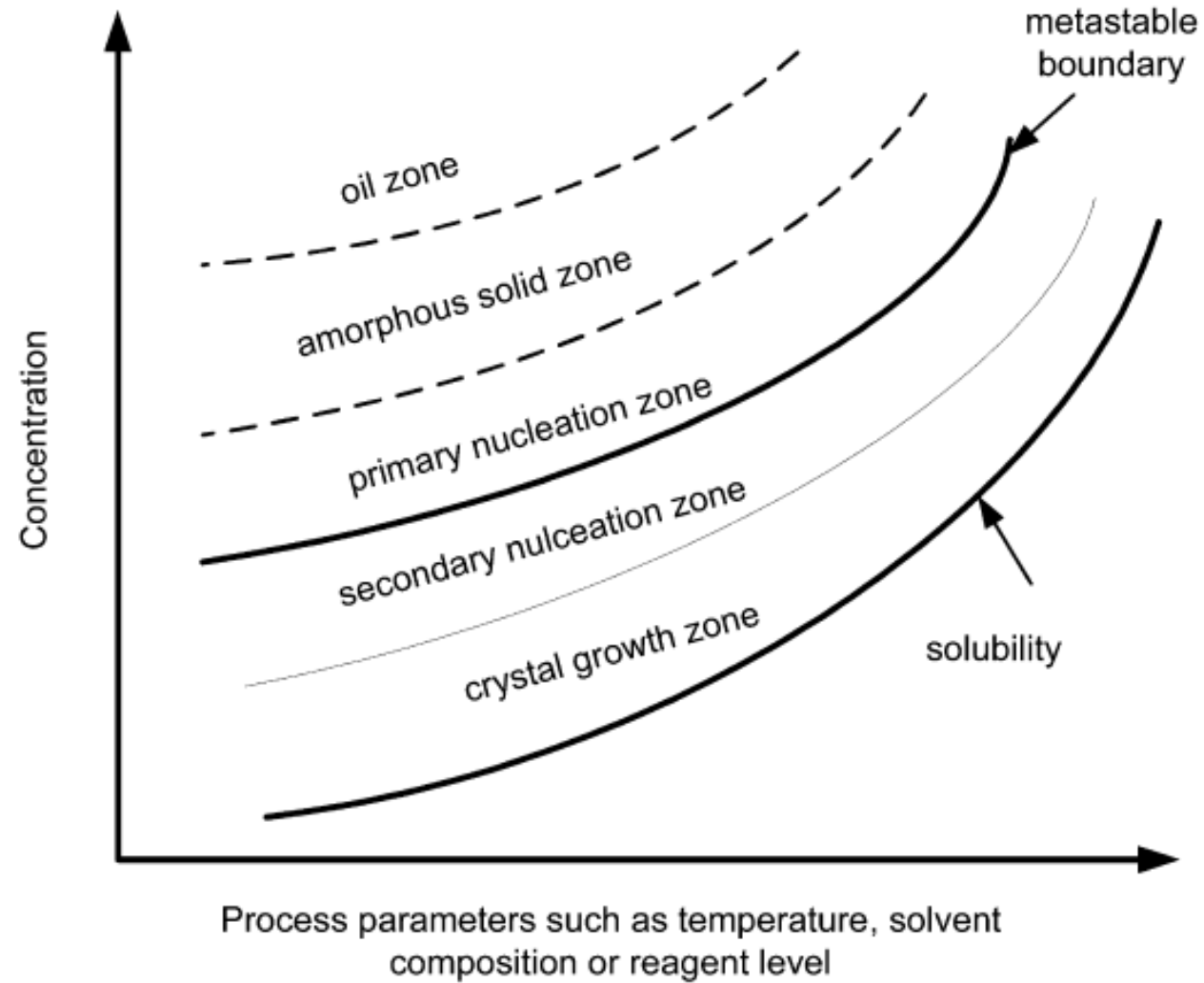

INDUCTION TIME

- Could be roughly correlated with the crystallization kinetics

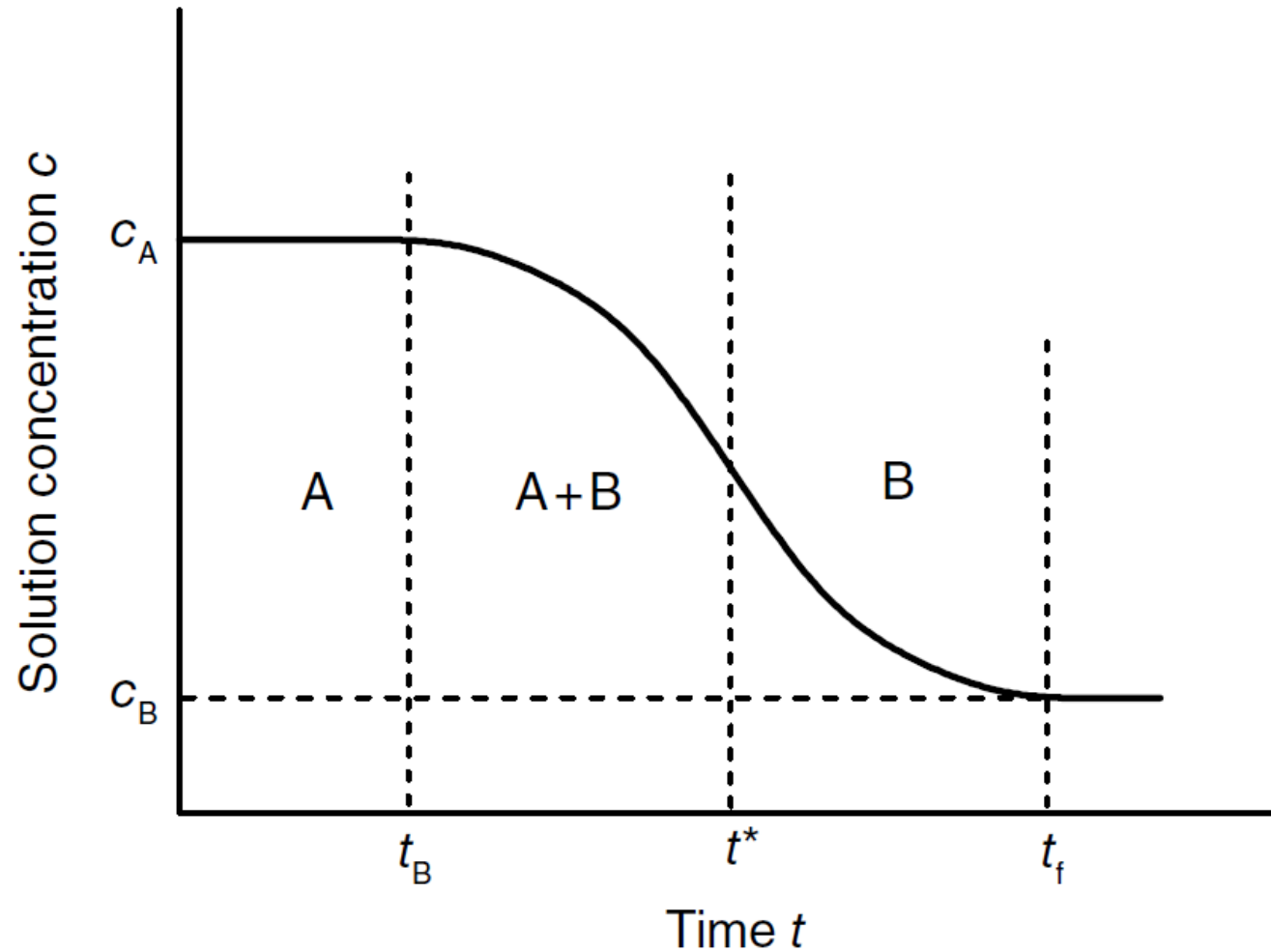

TYPES OF CRYSTALLIZATION

1. COOLING CRYSTALLIZATION

- Suitable for moderately to high soluble compounds – (100 – 300) g/l;
- Positive slope of solubility curve;
- Slope of the solubility curve is sufficiently steep;
- In the end of crystallization the content of solid product in the reaction mixture should not be higher than 30-35% (vol.);

- Product deposits or scaling could be a problem;
- Viscosity of solution;

- During crystallization, the system is NOT in thermodynamic equilibrium, but actual concentration does not differ much from equilibrium concentration → yields can be calculated using solubility curves;
- Yields are limited by solubility of a compound at the lowest temperature used → possibility to reprocess mother liquors.

TYPES OF CRYSTALLIZATION

2. EVAPORATIVE CRYSTALLIZATION

- Selected temperature, pressure and concentration of mother liquors are constant;
- Solubility is almost independent on pressure, so it can be derived from the solubility curve at atmospheric pressure;
- The challenge could be an accumulation of impurities in mother liquors → yield is limited by maximal accepted level of impurities in mother liquors;
- 100% yield could be accomplished;
- Yield could be calculated from mass balance in a solution and it is directly proportional to the mass of evaporated solvent(s);
- Could be used for moderately to highly soluble compounds (100 – 300) g/l;
- Could be used for the compounds with the flat solubility curve;
- Used for compounds not stable at atmospheric boiling

TYPES OF CRYSTALLIZATION

3. PRECIPITATION

- Used in the case of compounds with very low solubility ((0.001 – 1) g/l);
- Two very soluble compounds form together the product with very low solubility;
- Very fast process;
- Concentration of a product in solution is very low, so the yield can be determined only from its initial concentration;
- Mostly, amorphous material is produced, or different polymorphs obtained using different types of crystallization;



TYPES OF CRYSTALLIZATION

4. ANTI-SOLVENT CRYSTALLIZATION

- Solubility of a compound depends on the ratio solvent/antisolvent;
- Addition of antisolvent dilutes a reaction mixture → decrease in solubility should have higher impact than dilution effect;
- Compounds that form hydrates tend to provide compounds with lower number of water molecule in crystal lattice;

SUPERSATURATION

- Situation, where there is more compound in a solution than in equilibrium state under particular conditions;

Nucleation and **crystal growth** occur in supersaturated solutions;

Degree of supersaturation

- Mathematical expressions available – it is difficult and demanding to get corresponding data;
- Practical expression of degree of supersaturation based on easily available experimental values;

High supersaturation can lead to agglomeration of formed solid phase.

SUPERSATURATION PRACTICAL EXPRESSIONS

Thermodynamic expressions	Practical expressions	Crystallization method	Restriction
$\Delta H/T_{eq}, T - T_{eq}$	$T - T_{eq}$	Cooling, Melt	P constant, low supersaturation
[J mol ⁻¹] $RT \ln S_{cm}, RT \ln S_c$	[K] $\Delta c = c - c_{eq}$	Evaporative	T, P constant, low supersaturation
[J mol ⁻¹]	[(g solute) (g solution) ⁻¹ or (g solute) (g solvent) ⁻¹]		T, P constant, low supersaturation, single solute
$RT \ln S_{am}, RT \ln S_a$	$S_c = c/c_{eq}$	Precipitation, Anti-solvent	T, P , constant T, P constant, single solute
[J mol ⁻¹] $\Delta\mu = RTv\sigma, \Delta\mu = RT\sigma$	[-] $\sigma = \Delta c/c_{eq} = S - 1$	Evaporative,	T, P constant, low supersaturation
[J mol ⁻¹]	[-]	Anti-solvent	T, P constant, low supersaturation, single solute

SUPERSATURATION

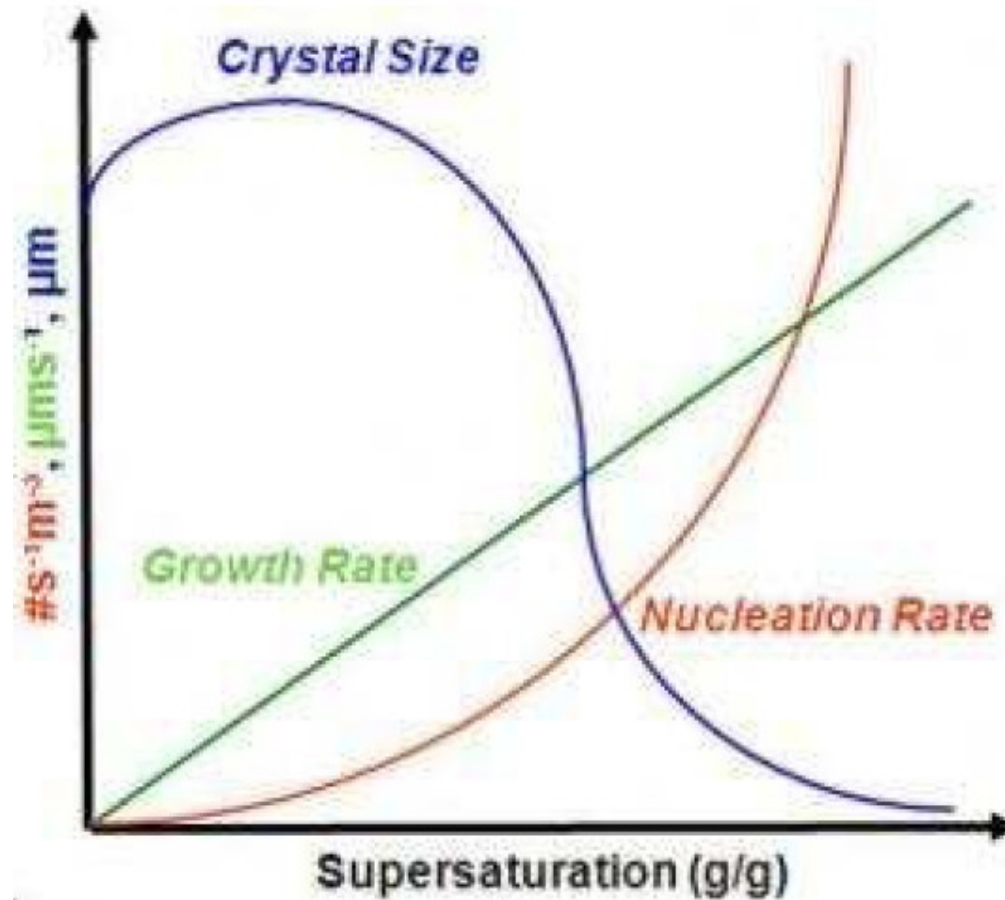

$$G = k_g \Delta C^g$$

$$B = k_b \Delta C^b$$

G = growth rate; k_g = growth rate constant; g = growth order (usually 1-2);
 ΔC = supersaturation; B = nucleation rate; k_b = nucleation rate constant;
 b = nucleation order (usually 5-10)

THERMODYNAMIC MODELS

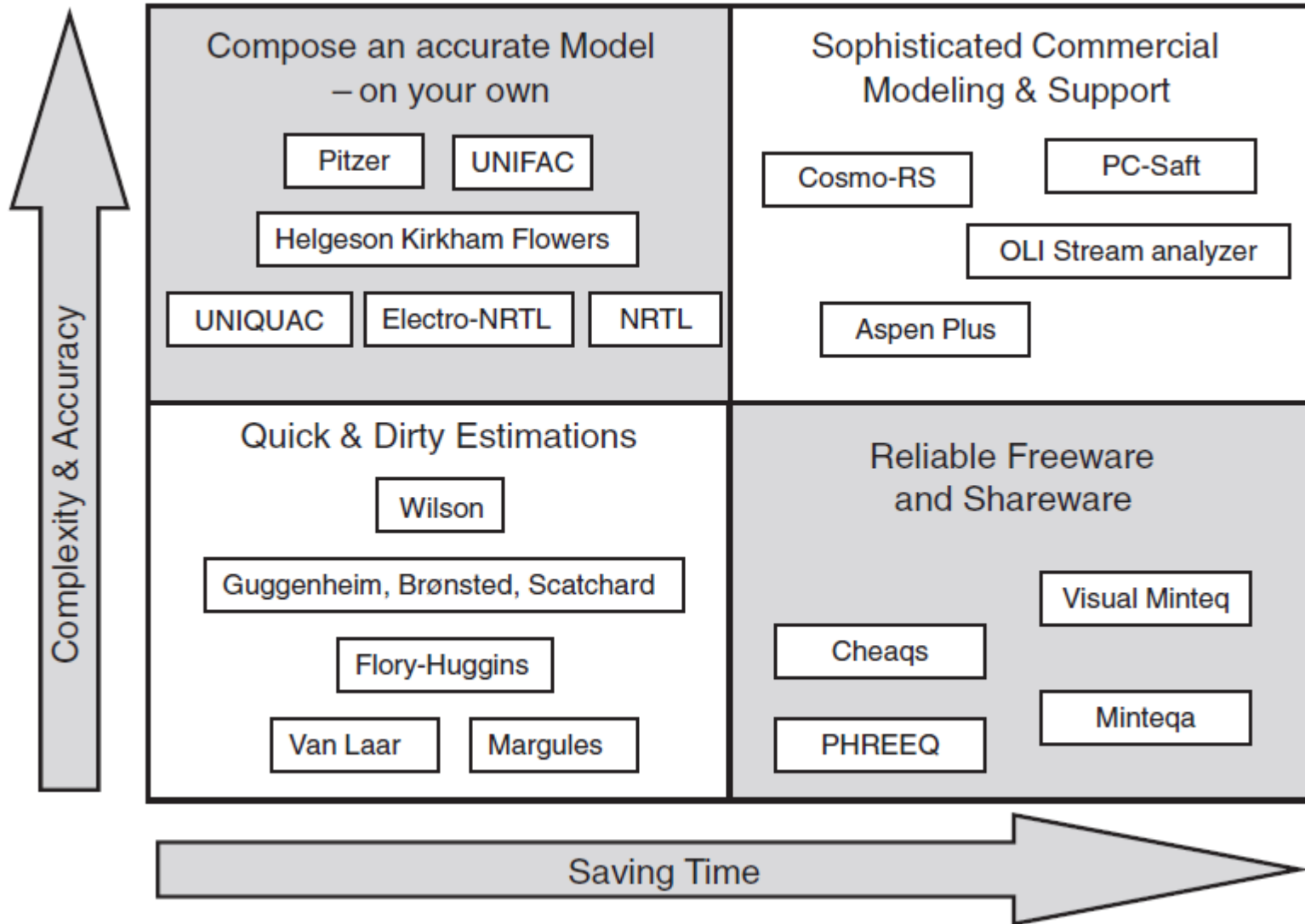



SUPERSATURATION – PRACTICAL EXAMPLE

Malwade, C.R.; Qu, H. *Org. Process Res. Dev.* 22, 697
(2018)

NUCLEATION

Nucleation control is essential for obtaining of desired polymorph and particle size distribution;

Homogeneous primary nucleation

- New phase is formed by a statistical fluctuation of entities of dissolved compound that agglomerate;

Heterogeneous primary nucleation

- New phase is formed in the presence of tiny, invisible particles of dust or impurities;

Secondary nucleation

- Supersaturated solution already contains crystals of crystallized compound – the only observed mechanism for cooling crystallizations or evaporative crystallizations (already present crystals and their growth decrease the value of supersaturation to the extent that primary nucleation is ruled out);

Cluster formation by combination and detachment of particular entities of a dissolved compound – subsequent combination of clusters – cluster concentration is much lower than concentration of dissolved compound – **critical size of clusters**

NUCLEATION

Homogeneous nucleation is practically very rare (it is extremely difficult to remove majority of dust particles) – therefore, crystallization mostly starts with heterogeneous nucleation mechanism;

Induction time – can be used as a measure of tendency of the system to remain in metastable state and therefore, can be used to determine the metastability limit ;

Induction time could be used for an estimation of nucleation rates.

Nucleation generally requires relatively large amount of energy and proceeds better in highly oversaturated solution.

NUCLEATION

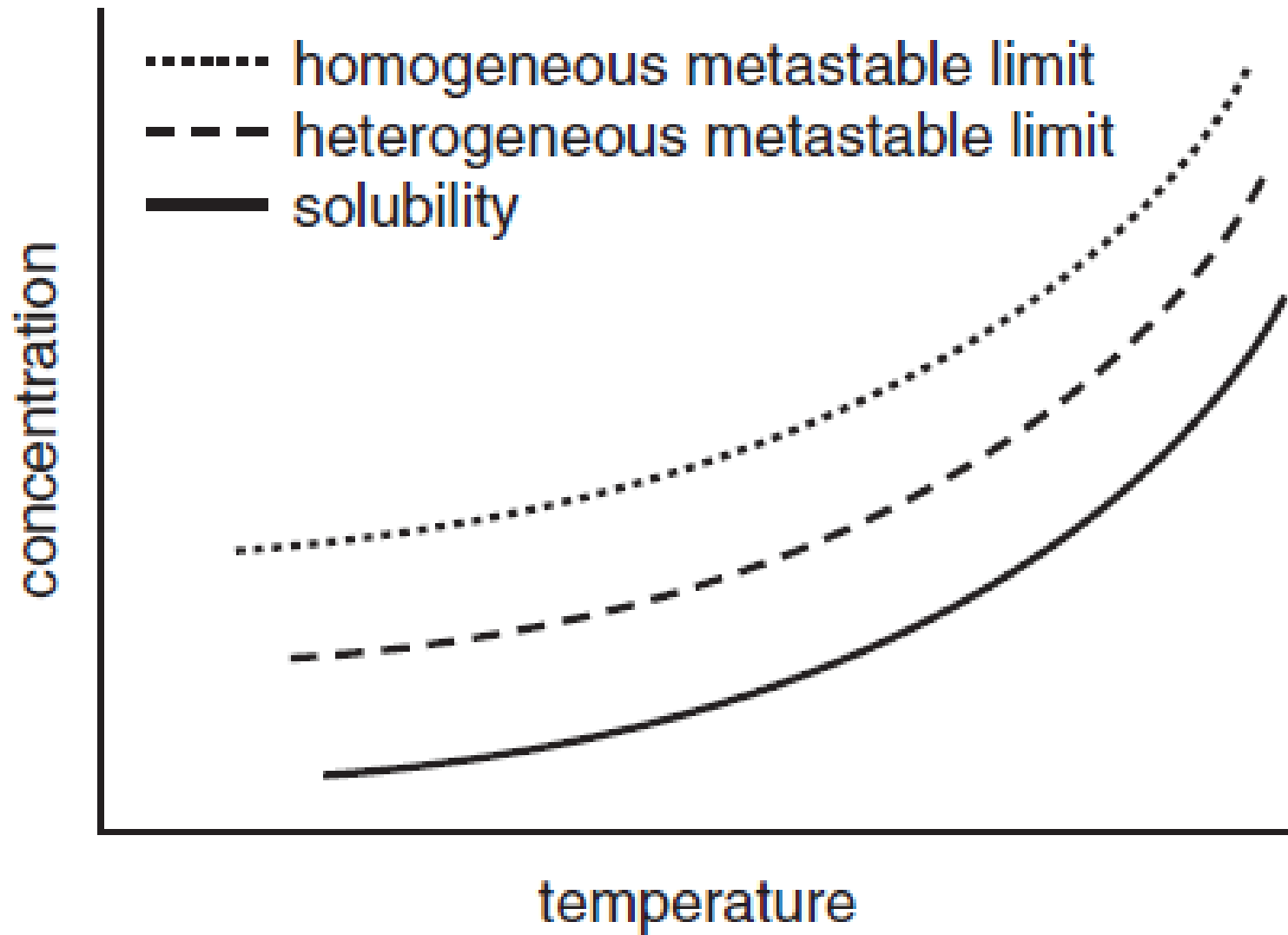

NUCLEATION

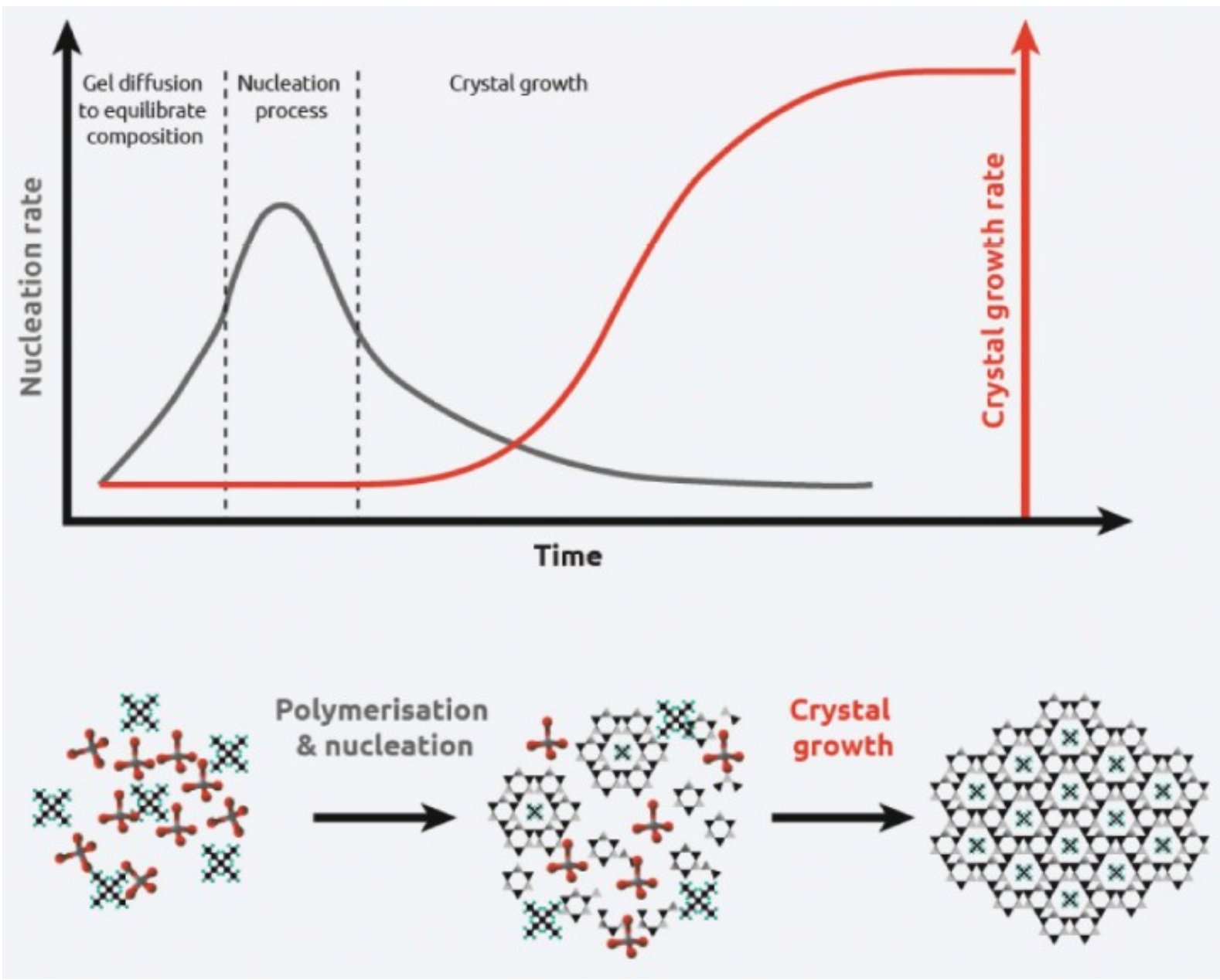

CRYSTAL GROWTH

The most important factors influencing crystal growth:

- supersaturation
- ambient phase (melt or solution?)
- interaction energy between dissolved compound and solvent
- the presence of impurities

Crystal growth rate depends on the size of crystals – the smaller crystals grow **slower** to a certain limit size than larger crystals

CRYSTAL GROWTH

OSTWALD RIPENING

● A phenomenon observed in solid solutions or liquid sols that describes the change of an inhomogeneous structure over time, i.e., small crystals or sol particles dissolve, and redeposit onto larger crystals or sol particles.

Dissolution of small crystals or sol particles and the redeposition of the dissolved species on the surface of larger crystals or sol particles was first described by Wilhelm Ostwald in 1896.



CRYSTAL GROWTH

Example of Ostwald ripening utilization for the modification of particle size distribution:

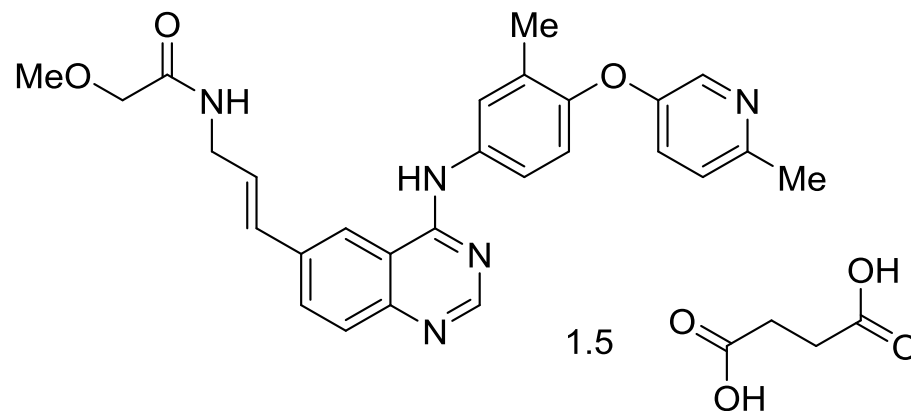

Problems with the crystallization of the salt (strict control of water content);

Free base and succinic acid dissolved in water/acetone mixture with lower amount of acetone than required for crystallization at 45 °C, filtered through 1 μm filter, acetone added to required ratio; Slow stirring and cooling to 43 °C, seeding with 1% of the product, stirred at 43 °C for 2 h and then cooled to 20 °C over 1 h.

The mixture was again heated to 38 °C over 1 h, slowly stirred for 1 h and cooled down to 33 °C in 3 h and cycles repeated in similar mode three times.

By this approach PSD (100-200) μm instead of original (10-15) μm was obtained.

CRYSTAL GROWTH

- Practical example of crystal healing process:

Codan, L.; Sirota, E.; Cote, A. *Org. Process Res. Dev.* 22, 1131
(2018)

SEEDING



SEEDING

● Main reasons for the seeding during crystallization:

- initiation of crystallization in the systems where crystallization is difficult and where the systems tend to oil out;
- particle size distribution control with the aim to get larger crystals with narrower particle size distribution;
- elimination of encrustation (scaling) caused by spontaneous nucleation, and also the preparation of a desired polymorph;
- preparation of a single crystal.

SEEDING

Operation, that could principally influence:

- progress of crystallization
- product purity
- particle size distribution of the product
- surface area
- orderliness (less disorders in a crystal lattice)
- polymorphism
- rate of crystallization

Based on many experiments it was observed and verified that **without seeding** about 30 – 50% of the product quickly precipitate from the solution during **spontaneous crystallization**. Thus, very large number of tiny crystals is formed with broad particle size distribution. Subsequently, possible crystal growth occurs on the surface of these tiny crystals (depending on concentration).

Ideal crystallization – addition of crystal seeds on which (and only there) the crystal growth occurs – number of crystals thus remains the same as in the beginning of crystallization

SEEDING

Very important operation of the crystallization process that principally influences various attributes of the solid product;

DEVIL IS HIDDEN IN DETAILS

The amount of seed (seed loading), particle size distribution of the seed can dramatically affect the result of crystallization;

Generally, it is close to ideal to seed in the region of lower oversaturation, and thus eliminate primary or secondary nucleation;

Based on the assumption that no primary and secondary nucleation occurs the number of crystals is the same as the number of seed crystals (on every seed crystal additional deposits of solid material is accumulated);

C_s = seed loading ratio

$$C_s = \frac{m_{seed}}{\Delta m} = \frac{L_{seed}^3}{L_{prod}^3 - L_{seed}^3}$$

SEEDING

Theoretically, for desired particle size of a product, it is possible to calculate seed particle size (direct proportion);

Practically, there are certain limitations:

- In the case C_s is too low → insufficient seed loading → small surface area → leads to large oversaturation and primary and secondary nucleation → not robust and small particle size → frequent agglomeration;
- In the case C_s is too high → excessive seed loading → not economical.

CRITICAL SEED LOADING RATIO C_s^*

The lowest possible seed loading at which **no nucleation** occurs

When C_s^* is used, unimodal particle size distribution is obtained regardless used temperature gradient, yield and volume of a crystallizer (under circumstances³ that no primary and secondary nucleation occurs – low oversaturation is maintained).

SEEDING

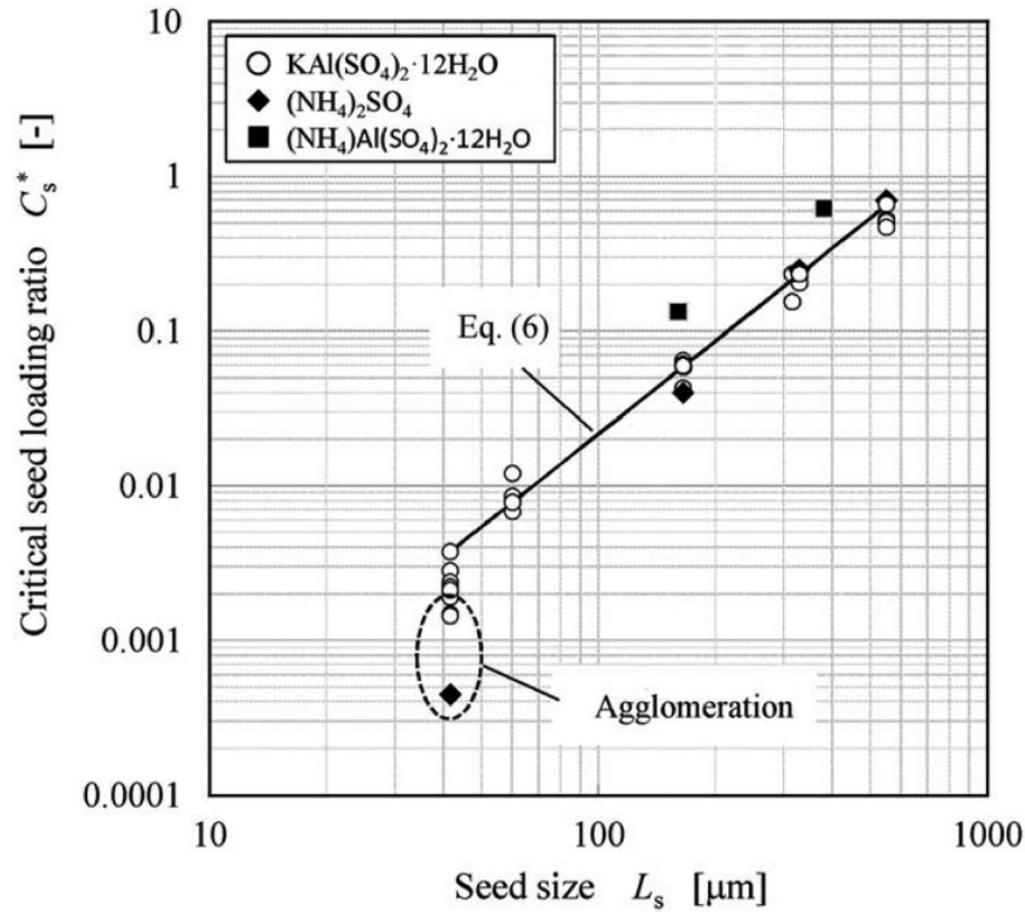

$$C_s^* = 2,17 \times 10^{-6} \times L_{SEED}^2$$

$$SEED \text{ LOADING} = CRYSTAL \text{ MASS} \times \left(\frac{SIZE \text{ OF SEED}}{SIZE \text{ OF CRYSTALS}} \right)^i$$

$i = 1$ (needles), 2 (plates) or 3 (cubes)

SEEDING

Timing of seed addition

- critical factor for a successful process;
- **too early** → seeds could be dissolved;
- **too late** → spontaneous nucleation might occur

Seed quality

- narrow particle size distribution as much as possible;
- always add seed as a suspension in slightly undersaturated solution;
- always use seed with the highest possible purity.

SEEDING

Seed loading

Paul, E.L.; Tung, H.-H.; Midler, M. *Powder Tech*, 150, 133 (2005)

„**Pinch**“ – used mostly in early phase of development on small scale with limited amount of material. Rarely effective or reliable on larger scale.

Small (< 1%) – aid in more controlled crystallization, but not adequate to achieve primarily growth on scale-up.

Large (5-10%) – to improve the probability of growth with the possibility of preventing further nucleation and bimodal distribution.

Massive – mostly used in continuous operations. Provides maximum opportunity for all growth.

SEEDING

Practical example of seeding:

Beckmann, W. *Org. Process Res. Dev.* 4, 372 (**2000**)

Beckmann, W.; Nickisch, K.; Budde, U. *Org. Process Res. Dev.* 2, 298 (**1998**)

CRYSTALLIZATION TRAJECTORY

Which crystallization trajectory is actually ideal??

- Particular crystallization conditions have significant impact on the yield, size and shape of crystals, polymorphism etc.;

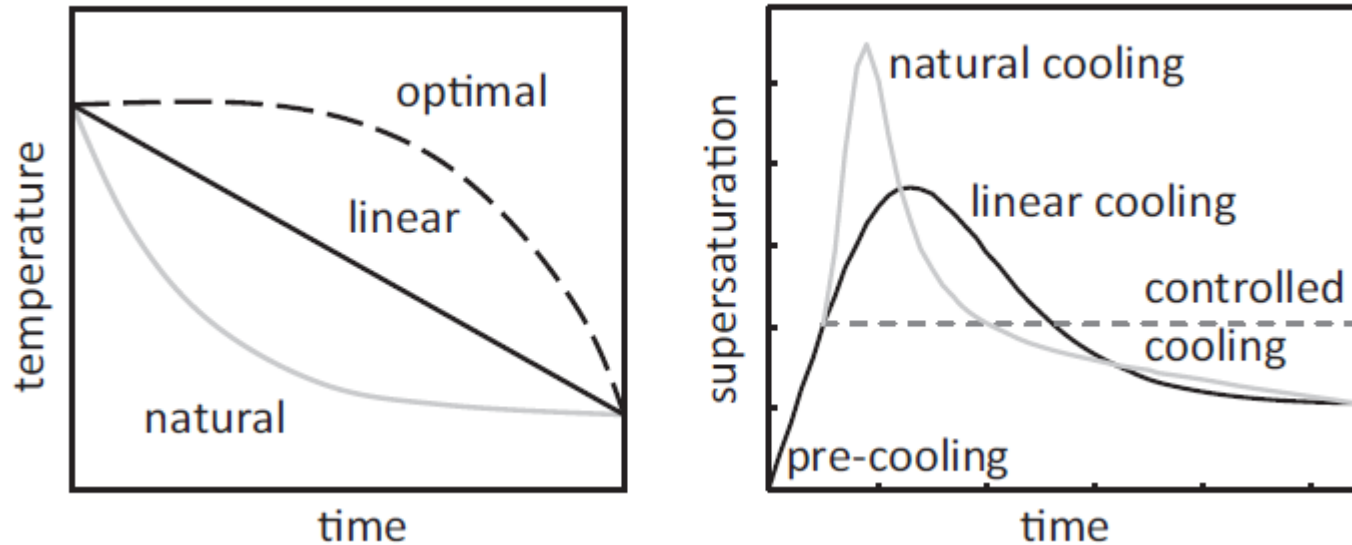

- Various ways how to control crystallization

- **Natural cooling** – the simplest, but mostly high degree of supersaturation occurs and very small crystals are formed;
- **Linear cooling** – often similar results are obtained as for natural cooling;

CRYSTALLIZATION TRAJECTORY

- **Constant supersaturation** – maintained by a regulated control of cooling/heating, evaporation or antisolvent addition – could bring technical challenges;
- **Optimal trajectory for a certain purpose** – a control system tries to create the best conditions for a certain phase of crystallization, and to get required attributes of crystalline product;

Open loop control – optimal trajectory is calculated by mathematical models and algorithms and is used by a control system – very difficult to control and calculate the impact of various factors and requested attributes (content of impurities, residual solvents, crystal habit etc.);

Closed loop control – the optimal operating policy is continuously updated during a run taking into account in-line process measurements;

Direct design – usually starts with a supersaturation trajectory determined from an open-loop method. The supersaturation is experimentally determined in the course of the process and possibly corrected according to values measured in real time (ATR-FTIR) – can be used to improve for the next batches.

CRYSTALLIZATION TRAJECTORY

Direct nucleation control (DNC)

Formation of crystalline entities/seeds **directly in the system** without external seeds (very useful for highly toxic compounds);

Does **not** require any information on the crystallization kinetics;

Overall number and size distribution of formed crystalline entities/seeds is controlled (FBRM) and parameters that influence these attributes are modified in the course of crystallization (temperature, antisolvent addition, solvent evaporation);

Thus, relatively narrow distribution of crystal size can be obtained – by appropriate temperature control fractions of very small crystals are dissolved again;

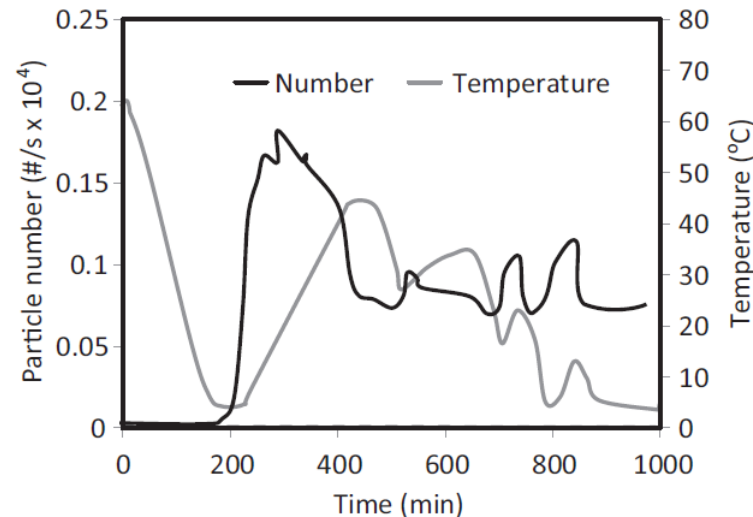

CRYSTALLIZATION TRAJECTORY

Direct nucleation control (DNC)

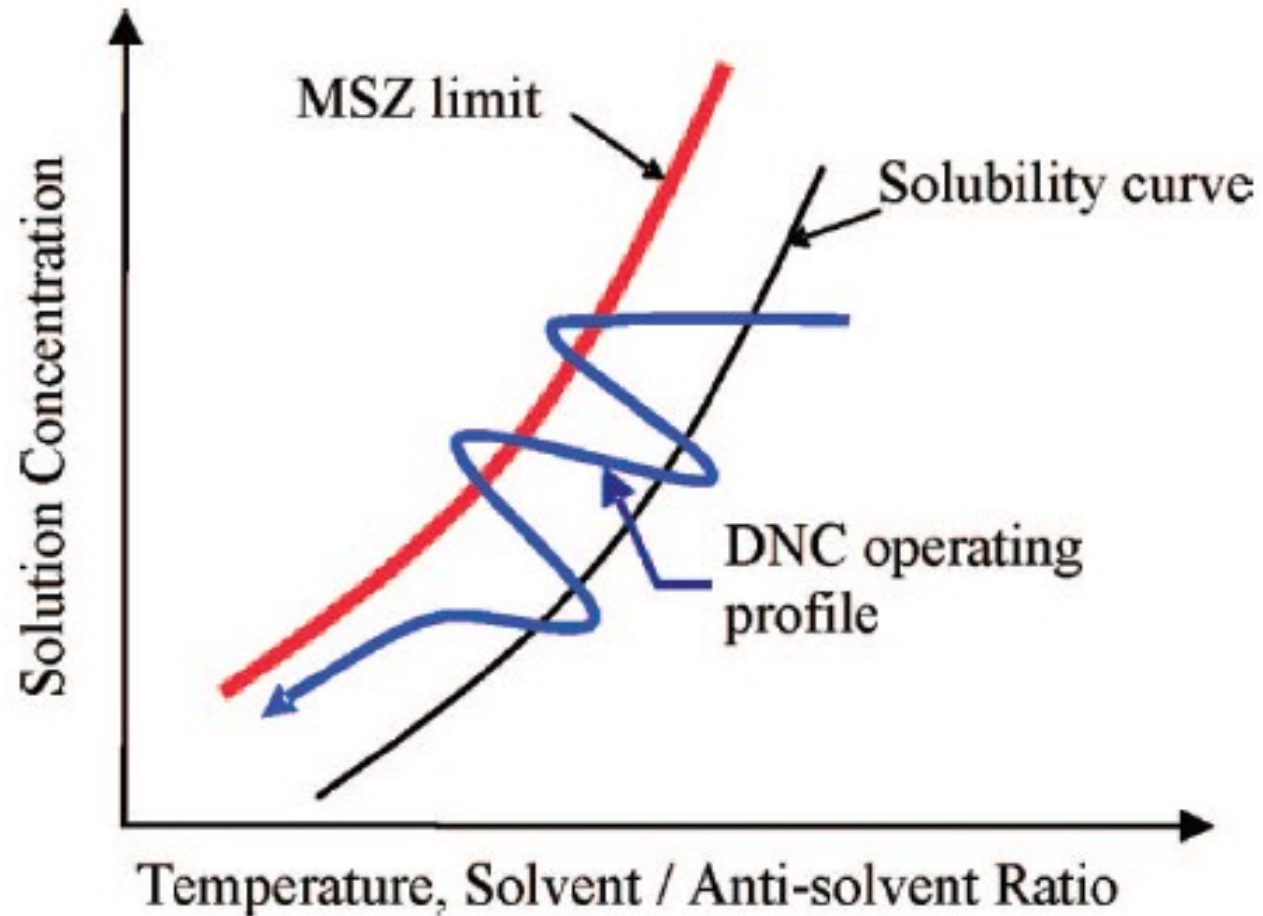

CRYSTALLIZATION TRAJECTORY

Direct nucleation control (DNC)

Practical example of application:

Abu Bakar, M.R.; Nagy, Z.K.; Saleemi, A.N.; Rielly Ch.D. *Crystal Growth Design* 9, 1378 (2009)

Liotta, V.; Sabesan, V. *Org. Process Res. Dev.* 8, 488 (2004)

Saleemi, A.N.; Steele, G.; Pedge, N.I.; Freeman, A.; Nagy, Z.K. *Int. J. Pharm.* 430, 56 (2012)

APPROACHES USED IN THE OPTIMIZATION OF CRYSTALLIZATION

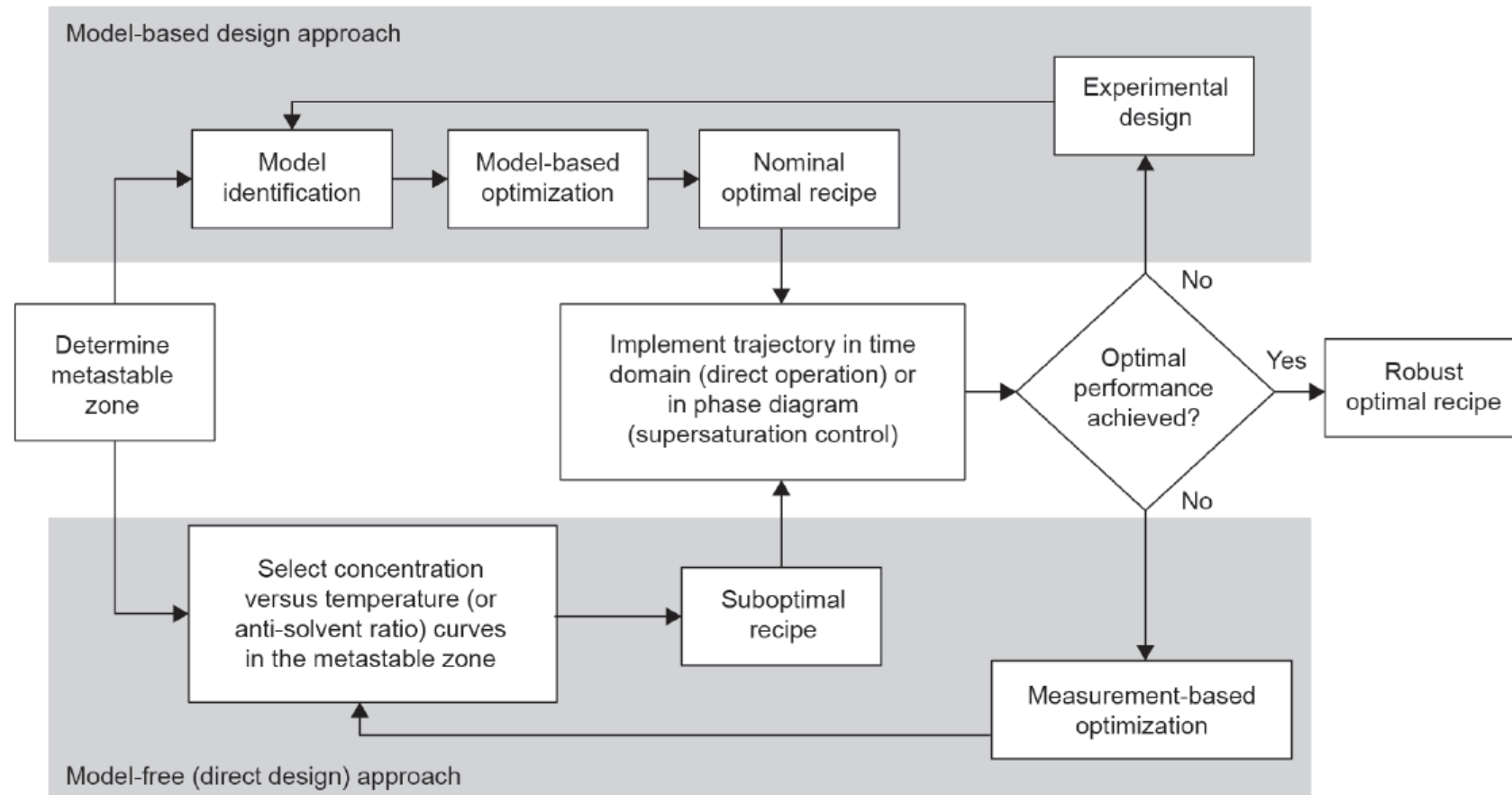



DUTCH RESOLUTION, ATTRITION ENHANCED DERACEMIZATION

Petr Beňovský



CRYSTALLIZATION OF ENANTIOMERS FROM RACEMIC MIXTURES

RACEMIC MIXTURE (CONGLOMERATE)

A mechanical mixture of enantiomerically pure crystals of one enantiomer and its opposite;

RACEMIC COMPOUNDS

The crystallographic unit cell contains both enantiomers in ordered 1 : 1 ratio;

RACEMIC SOLID SOLUTIONS

The crystallographic unit contains molecules of each enantiomer in a random order.

CRYSTALLIZATION OF ENANTIOMERS FROM RACEMIC MIXTURES

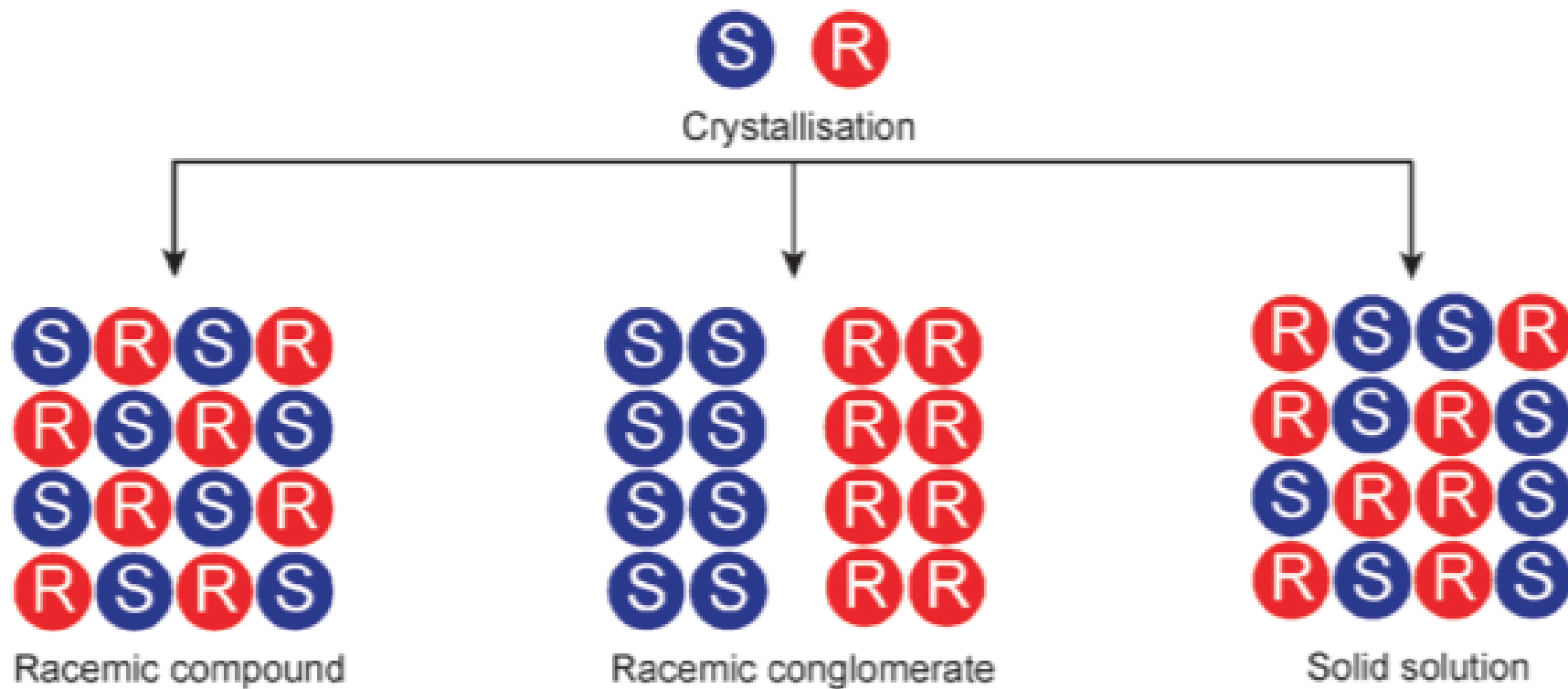

Sogutoglu, L.-C. *et al Chem. Soc. Rev.* 44, 6723 (2015)

CRYSTALLIZATION OF ENANTIOMERS FROM RACEMIC MIXTURES

CRYSTAL GROWTH

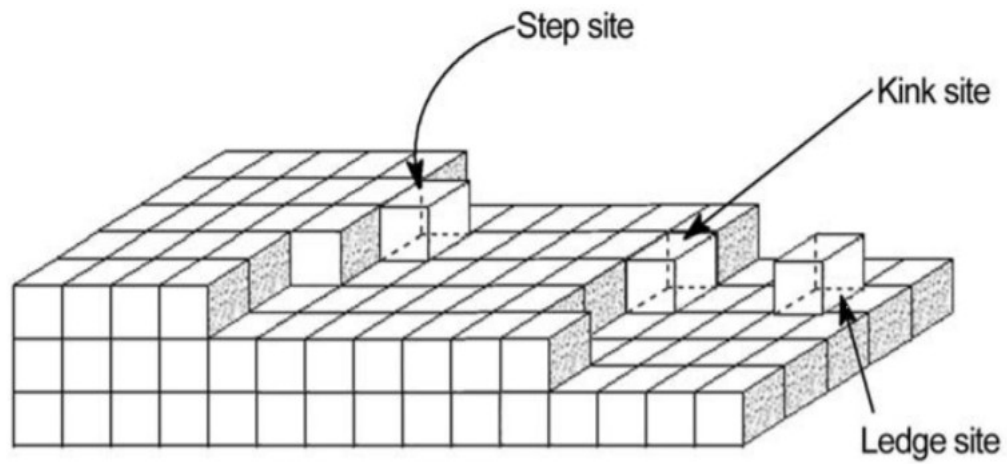

Step-wise growth

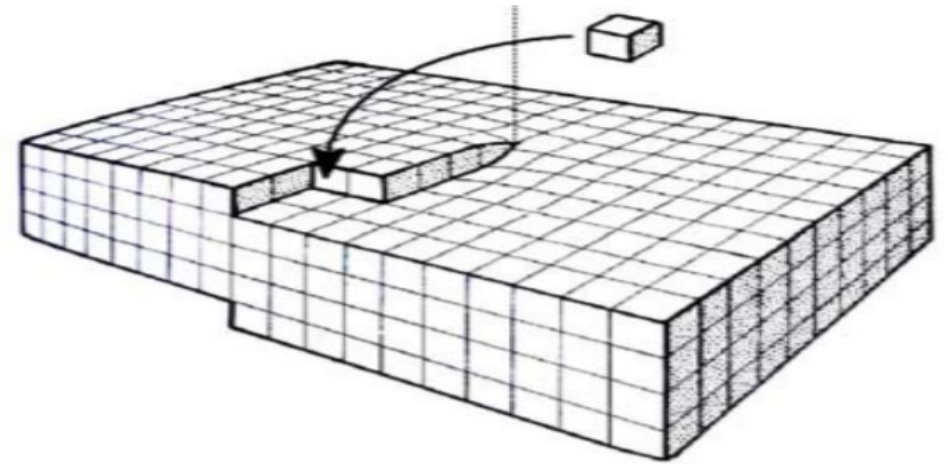

Spiral growth

CRYSTALLIZATION OF ENANTIOMERS FROM RACEMIC MIXTURES

CRYSTAL GROWTH

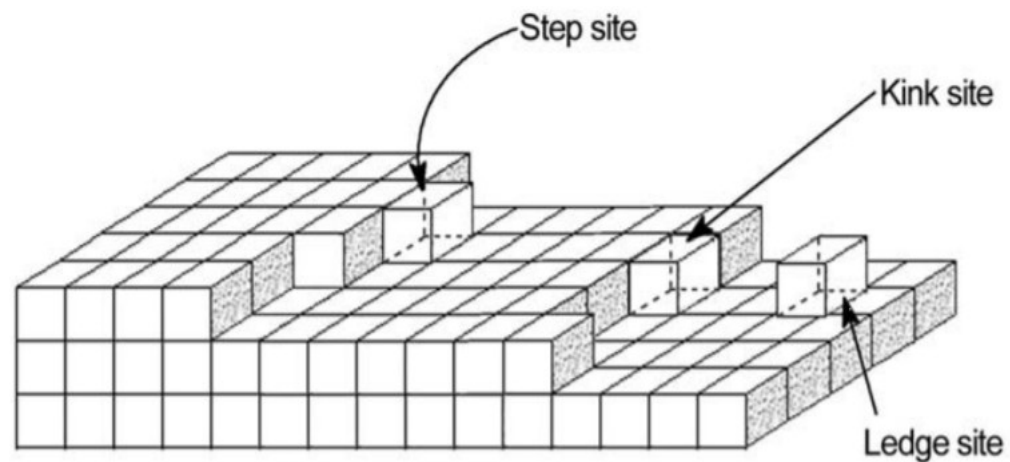

Step-wise growth

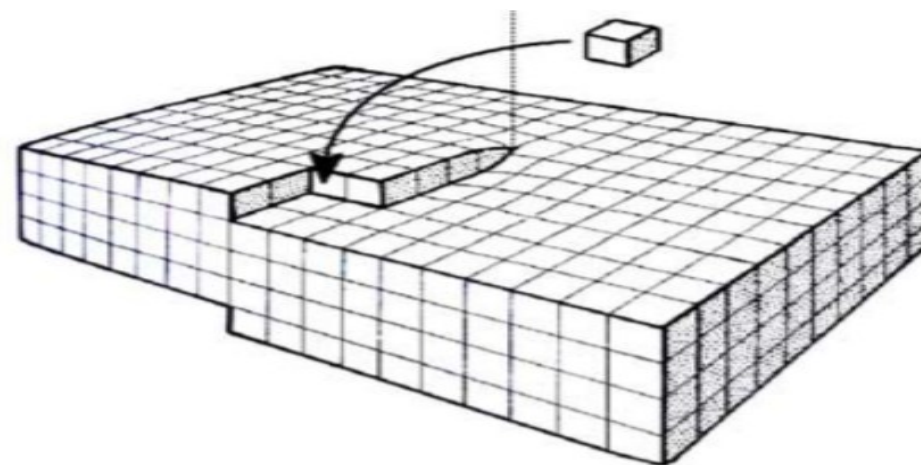

Spiral growth

CRYSTALLIZATION OF ENANTIOMERS FROM RACEMIC MIXTURES

CRYSTAL HABITS (ICE CRYSTALS)



CRYSTALLIZATION OF ENANTIOMERS FROM RACEMIC MIXTURES

CRYSTAL HABIT MODIFIERS

Present impurities or deliberately added compounds that have profound effect on growth rate of one or more faces even at very low concentrations;

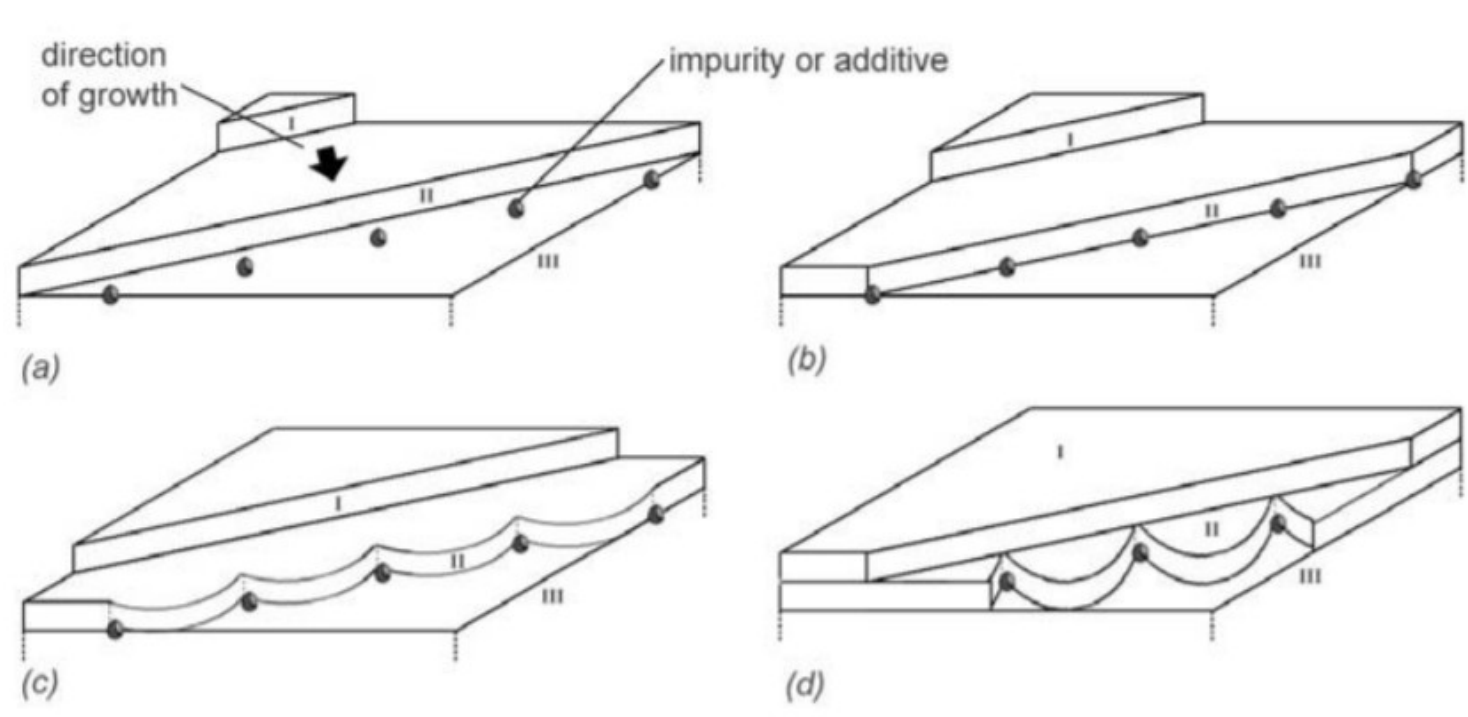

CRYSTALLIZATION OF ENANTIOMERS FROM RACEMIC MIXTURES

CRYSTAL HABIT MODIFIERS

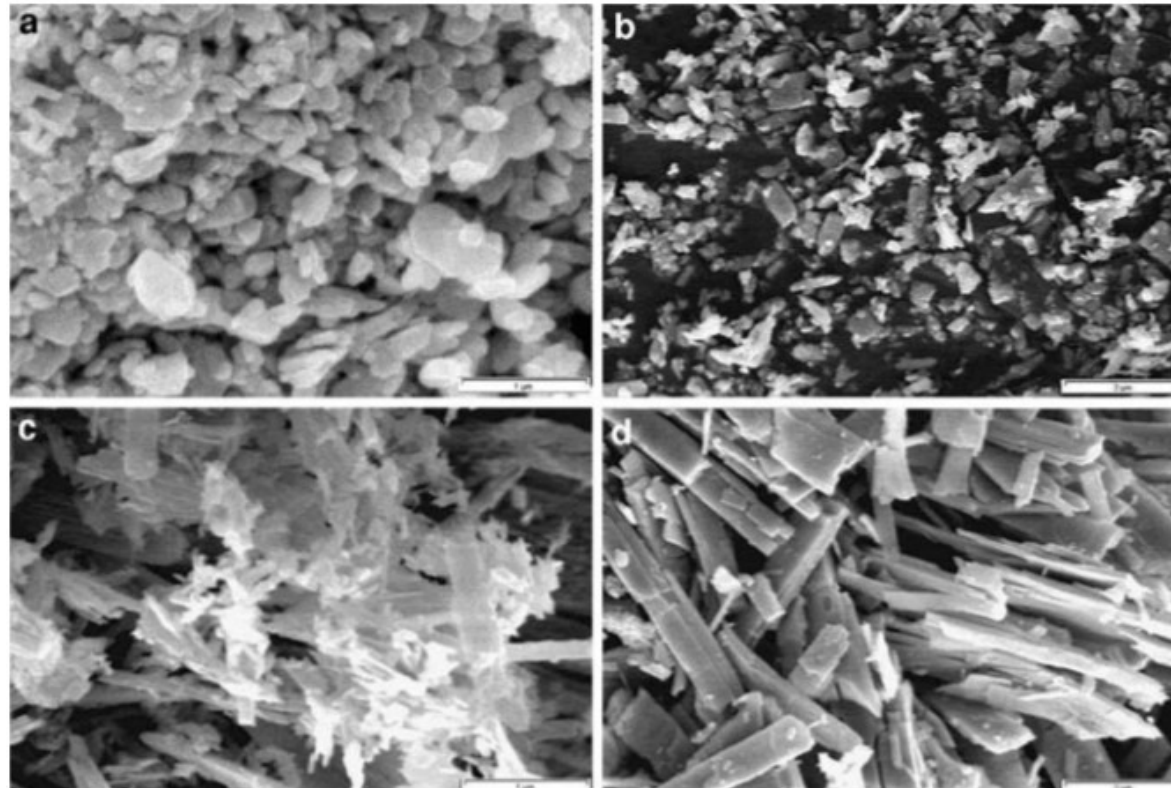

MoO₃ a – urea; b – PEG 200; c – EDTA; d – sorbitol
Parviz, D. *et al J. Nanopart. Res.* 12, 1509 (2010)



CRYSTALLIZATION OF ENANTIOMERS FROM RACEMIC MIXTURES

NUCLEATION INHIBITORS

Some compounds can efficiently block (or dramatically slow down) crystal growth or nucleation of crystals;

The metastable zone width is thus enlarged;

If we want to crystallize just one enantiomer from a racemic conglomerate we must block nucleation and crystal growth of the opposite one;

Inhibitor in that case must be homochiral;

Inhibitor must be the same enantiomorph

CRYSTALLIZATION OF ENANTIOMERS FROM RACEMIC MIXTURES

OPTICAL RESOLUTION VIA DIASTEREOMERIC SALTS

Single enantiomer drugs - \$147 billion worldwide sale (2001)

Optical resolution (besides utilization of chiral pool and asymmetric synthesis) is the most frequent used industrial method for obtaining single enantiomers;

1882 – Louis Pasteur demonstrated that by seeding a supersaturated solution of ammonium sodium tartrate with a *d*-crystals on one side of the reactor and a *l*-crystals on the opposite side, crystals of opposite handedness formed on the opposite sides of the reactor.

CRYSTALLIZATION OF ENANTIOMERS FROM RACEMIC MIXTURES

OPTICAL RESOLUTION VIA DIASTEREOMERIC SALTS

Peachey-Pope Resolution

Instead of one equivalent of homochiral resolving agent, only one half equivalent of resolving agent is used and supplemented with one half equivalent of an achiral, low cost acid or base (e.g. HCl, NaOH) to make the system neutral. The achiral supplement should provide very soluble salts with the racemate so this will not crystallize and ruin the resolution. The less soluble (desired) salt will start to crystallize and will consume most of a chiral resolving agent thus leaving only small amount of a chiral resolving agent for the more soluble diastereomer which, in ideal case, will not crystallize.

The solubility difference between two diastereomeric salts can be relatively small.



CRYSTALLIZATION OF ENANTIOMERS FROM RACEMIC MIXTURES

OPTICAL RESOLUTION VIA DIASTEREOMERIC SALTS

Peachey-Pope Resolution

Harrington, P.J. *Org.Process Res. Dev.* 1, 72 (1997) – naproxen example

CRYSTALLIZATION OF ENANTIOMERS FROM RACEMIC MIXTURES

OPTICAL RESOLUTION VIA DIASTEREOMERIC SALTS

Dutch Resolution

- The use of mixtures of resolving agents (families);
- The family members should bear strong structural similarity and are stereochemically homogeneous;
- 2 or 3 family members are used in a resolution;
- Usually, such resolutions proceed rapidly with high diastereomeric excess;
- Often, this combination of resolving agents brings better resolution than with just one resolution agent;
- Sometimes, all resolution agents are incorporated into the crystal lattice, but sometimes at least one of them serves as a nucleation inhibitor;

CRYSTALLIZATION OF ENANTIOMERS FROM RACEMIC MIXTURES

OPTICAL RESOLUTION VIA DIASTEREOMERIC SALTS

Dutch Resolution

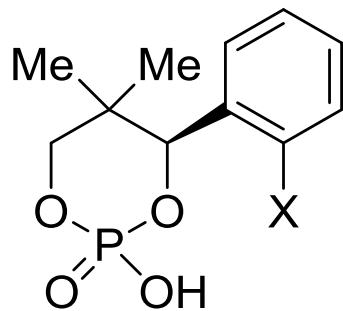

P-Mix

X = H, Cl, Me

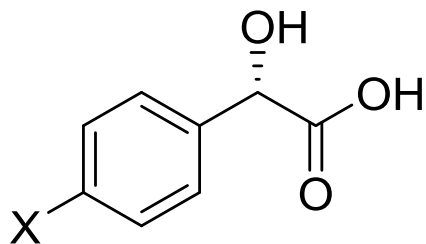

M-Mix

X = H, Me, Br

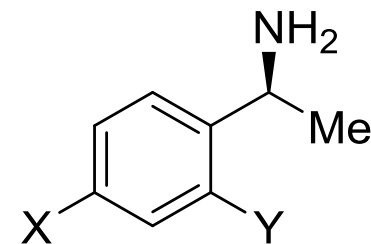

PE-II-Mix

X = Y = H

X = NO₂, Y = H

X = H, Y = NO₂



CRYSTALLIZATION OF ENANTIOMERS FROM RACEMIC MIXTURES

OPTICAL RESOLUTION VIA DIASTEREOMERIC SALTS



Dutch Resolution

Dalmolen, J. *et al Chem. Eur. J.* 11, 5619 (2005)

Kellogg, R.M. *Synthesis* (10), 1626 (2003)

CRYSTALLIZATION OF ENANTIOMERS FROM RACEMIC MIXTURES

ATTRITION ENHANCED DERACEMIZATION

Viedma Ripening

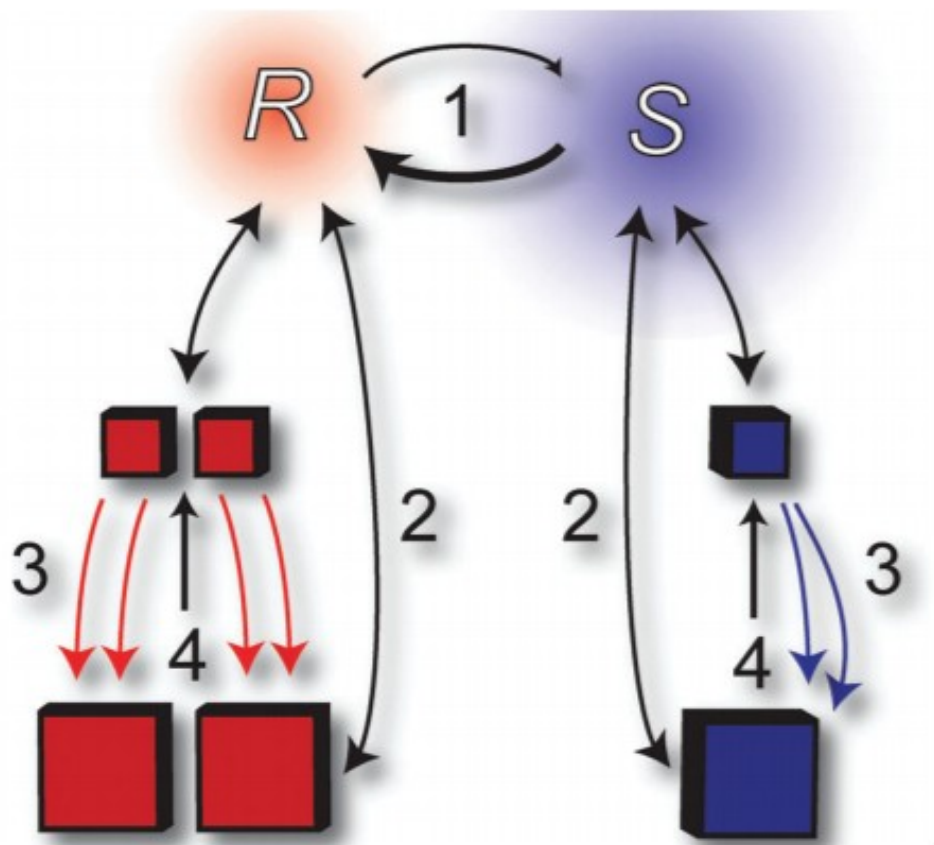

1. Racemisation in solution
2. Ostwald ripening
3. Enantioselective growing
4. Attrition

CRYSTALLIZATION OF ENANTIOMERS FROM RACEMIC MIXTURES

ATTRITION ENHANCED DERACEMIZATION

Viedma Ripening

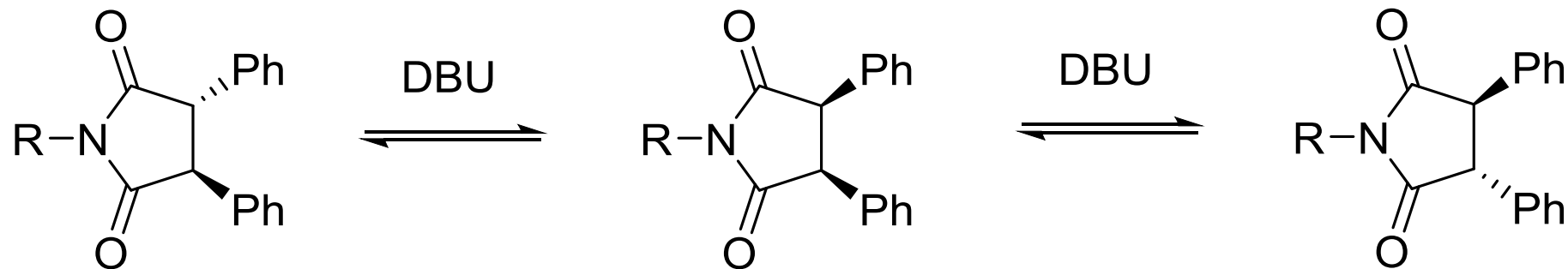

Hachiya, S. *Chem. Commun.* 49, 4776 (2013)

CRYSTALLIZATION OF ENANTIOMERS FROM RACEMIC MIXTURES

ATTRITION ENHANCED DERACEMIZATION

Upscaled synthesis of Clopidogrel (Plavix) using a bead mill

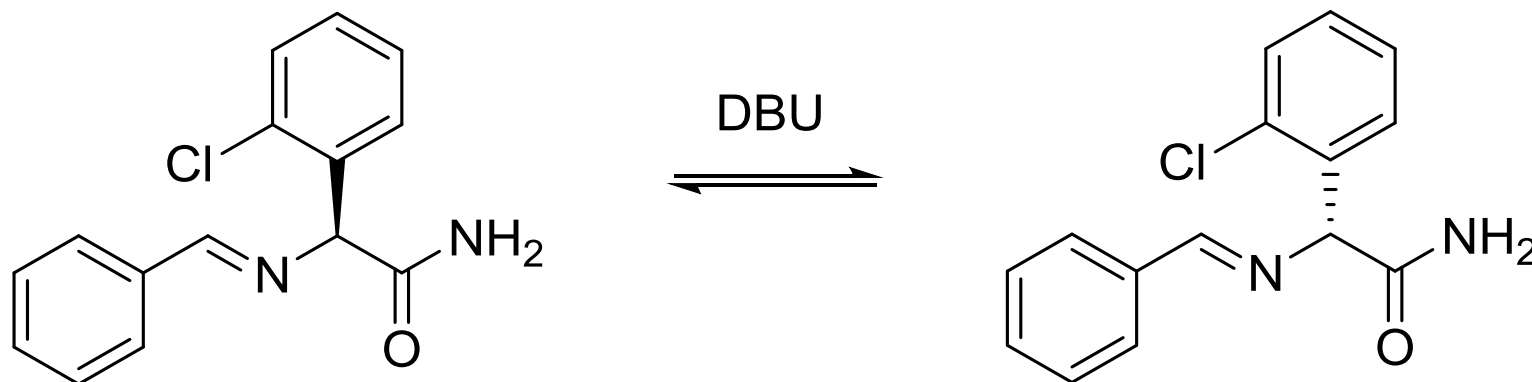

Noorduyn, W.L. *et al* *Org. Process Res. Dev.* **14**, 908 (2010)

CRYSTALLIZATION OF ENANTIOMERS FROM RACEMIC MIXTURES

ATTRITION ENHANCED DERACEMIZATION

Upscaled synthesis of Clopidogrel (Plavix) using a bead mill

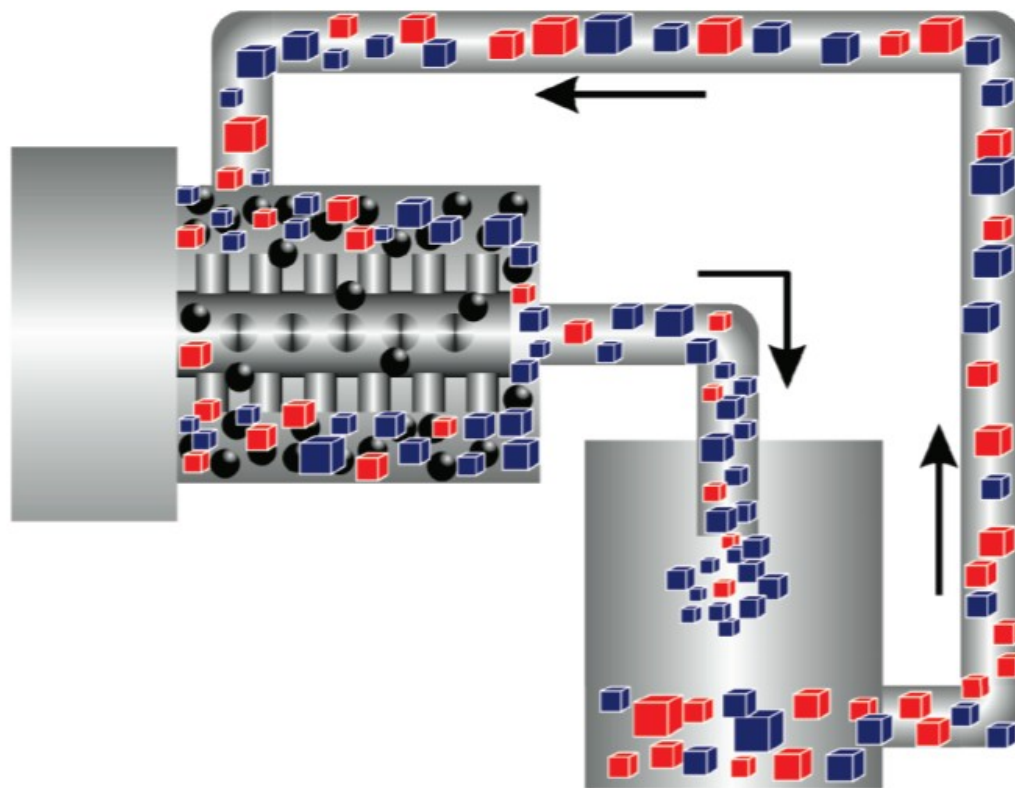

Noorduyn, W.L. *et al* *Org. Process Res. Dev.* **14** 908 (2010)

CRYSTALLIZATION OF ENANTIOMERS FROM RACEMIC MIXTURES

- ATTRITION ENHANCED DERACEMIZATION
- Upscaled synthesis of Clopidogrel (Plavix) intermediate using a bead mill

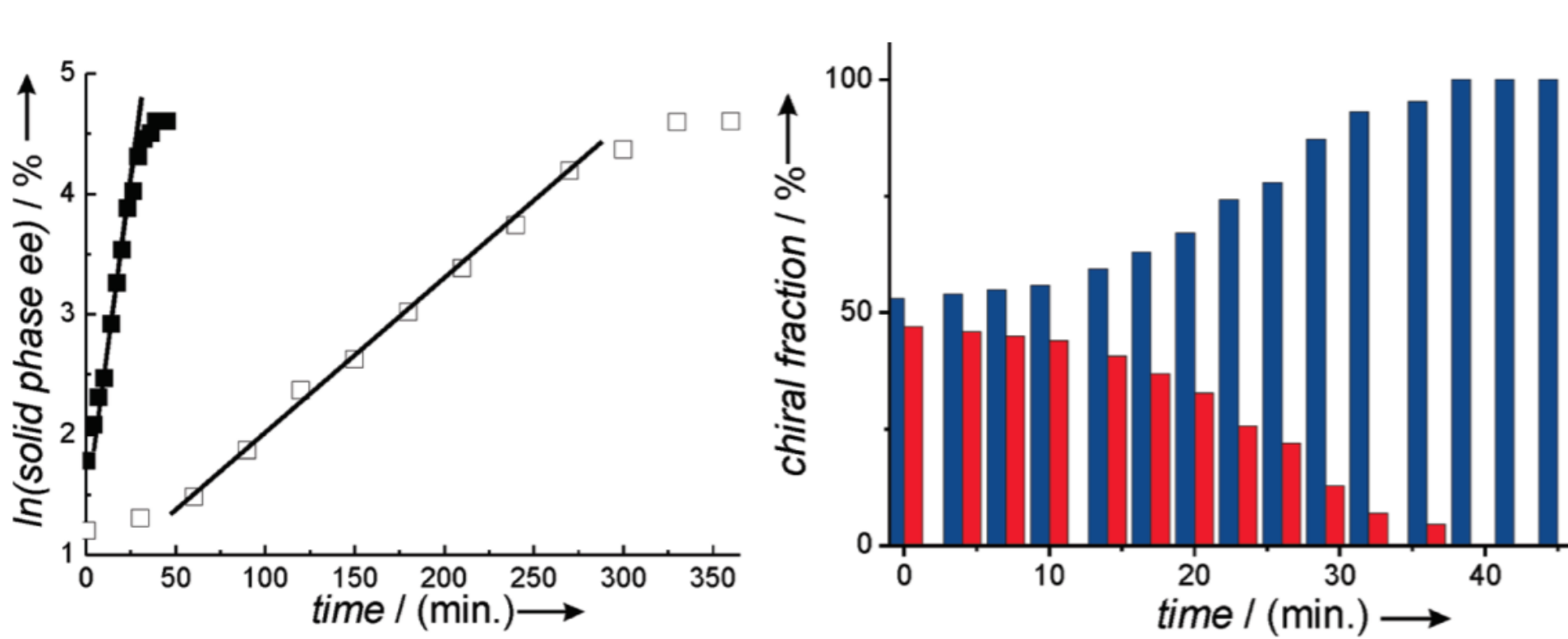

WHAT NEXT??

• **Solubility determination** using very small amounts

Peybernes, G.; Grossier, R.; Villard, F.; Letellier, P.; Lagaize, M.; Candoni, N.; Veessler, S. *Org. Process Res. Dev.* 22, 1856 (2018)

Membrane crystallizations

Drioli, E.; Di Profio, G.; Curcio, E. *Curr. Opinion Chem. Eng.* 1, 178 (2012)

Continuous reaction including crystallizations on microscale

Song, H.; Chen, D.L.; Ismagilov, F. *Angew. Chem. Int. Ed.* 45, 7336 (2006)

WHAT NEXT??

MSMPR (Mixed Suspension Mixed Product Removal) Crystallization

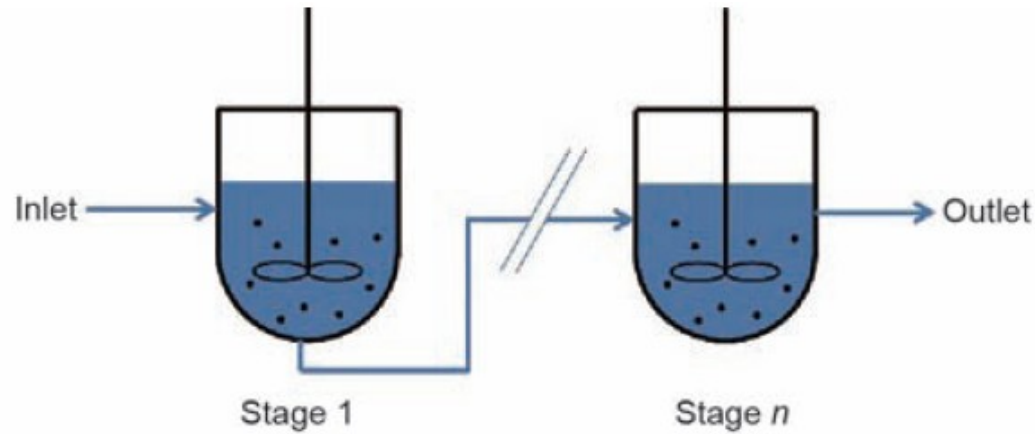

Zhang, D. *et al Engineering* 3, 354 (2017)

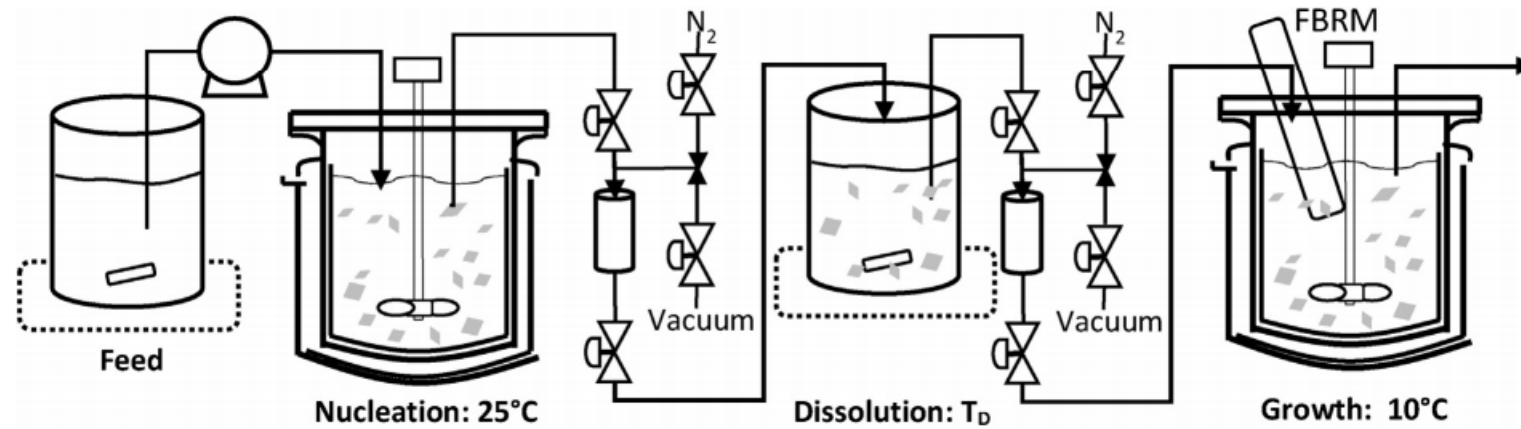

Nagy, Z.K. *et al Chem. Eng. Res. Des.* 135, 112 (2018)

WHAT NEXT??

MSMPR (Mixed Suspension Mixed Product Removal) Crystallization



MSMPR equipment in Eli Lilly;

Crystallization was the most important element of their control strategy for low impurity profile;

Purity of a crystallized compound was higher than 99.8 %.

WHAT NEXT??

Plug Flow Crystallization (PFC)

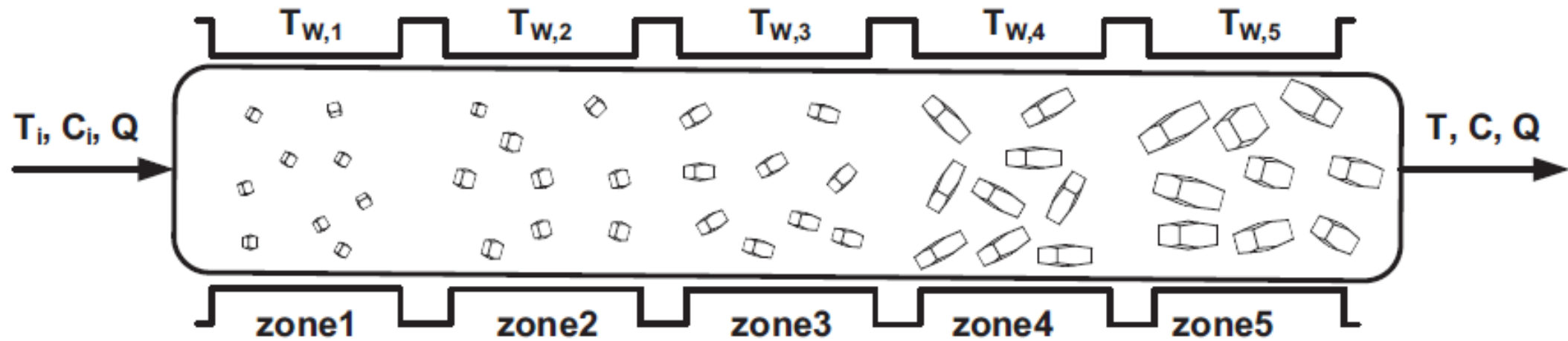

Kwon, J.S. *et al Chem. Eng. Sci.* 119, 30 (2014)

WHAT NEXT??

AIRLIFT CRYSTALLIZERS

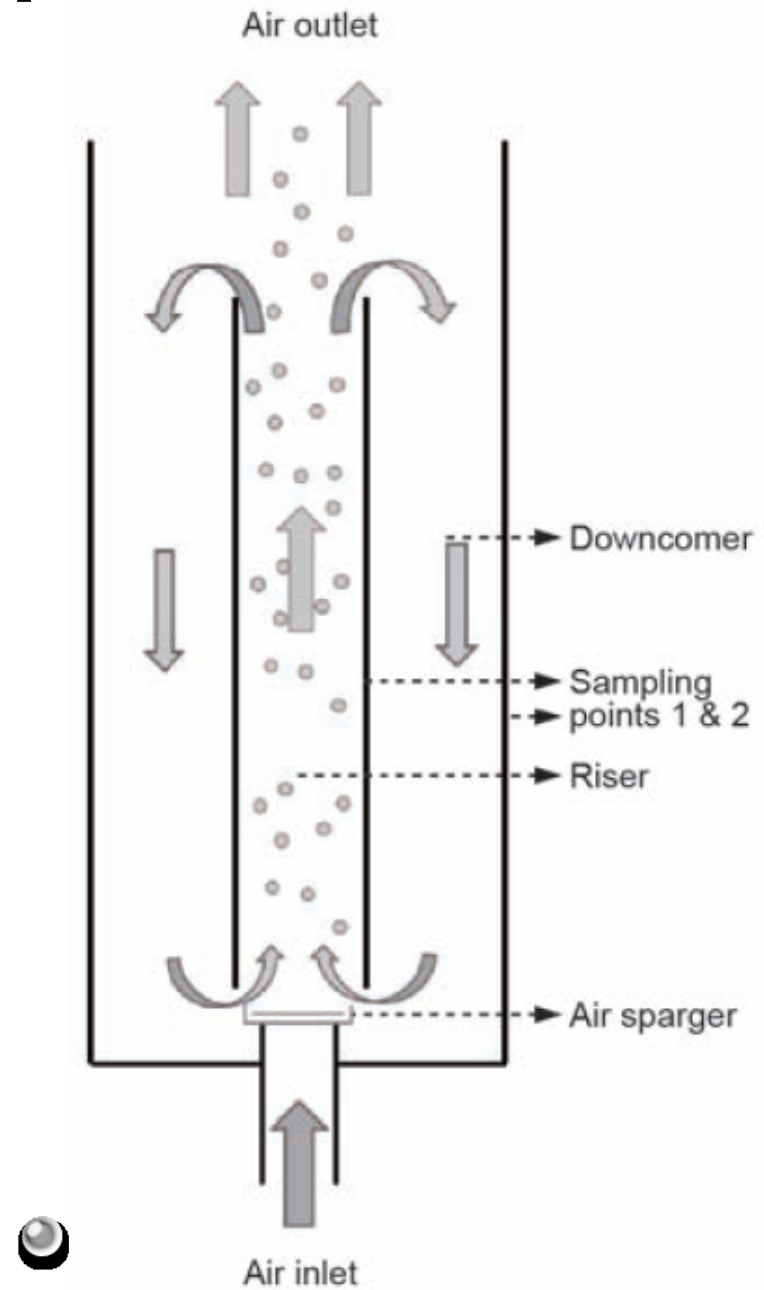

WHAT NEXT??

Microfluidic Crystallizations

Crystallization in droplets – every droplet with nanoliter volume is independent crystallizer

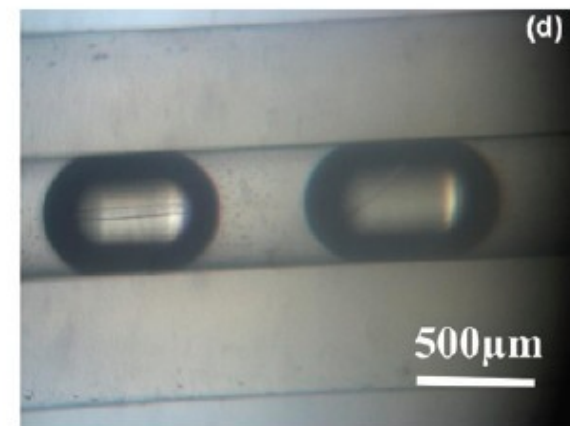
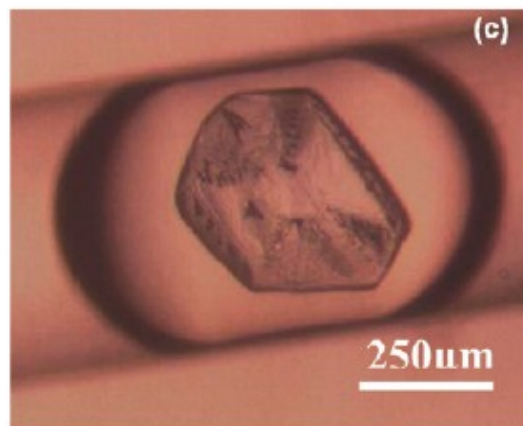
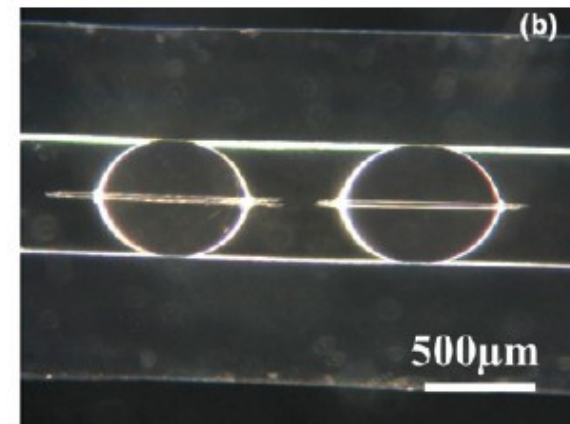
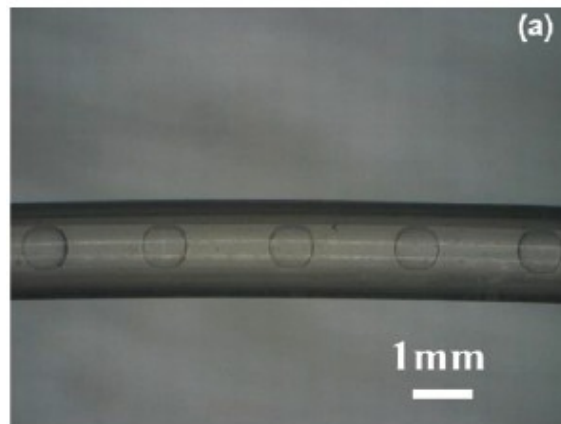
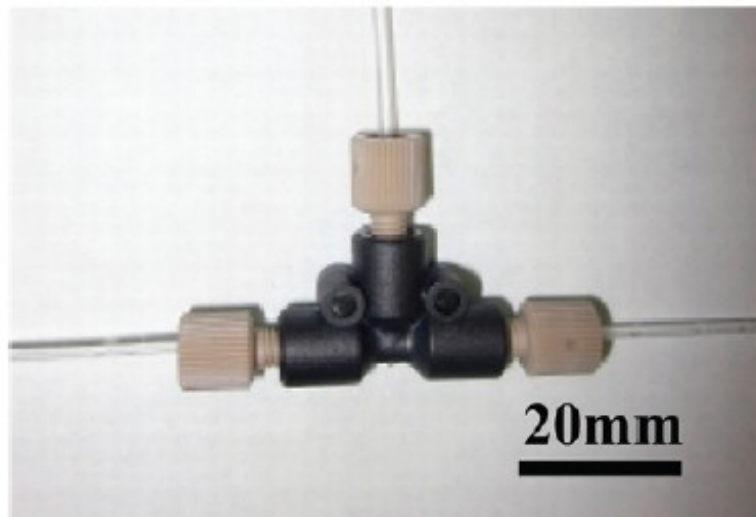
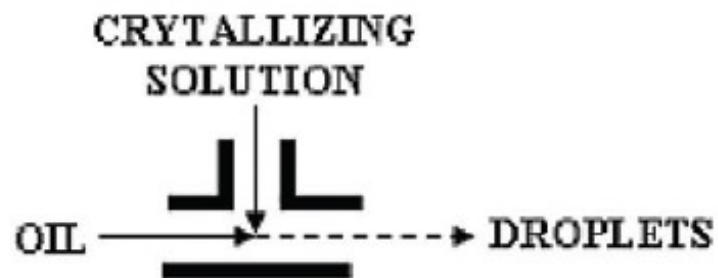

WHAT NEXT??

OSCILLATORY BAFFLED CRYSTALLIZATION

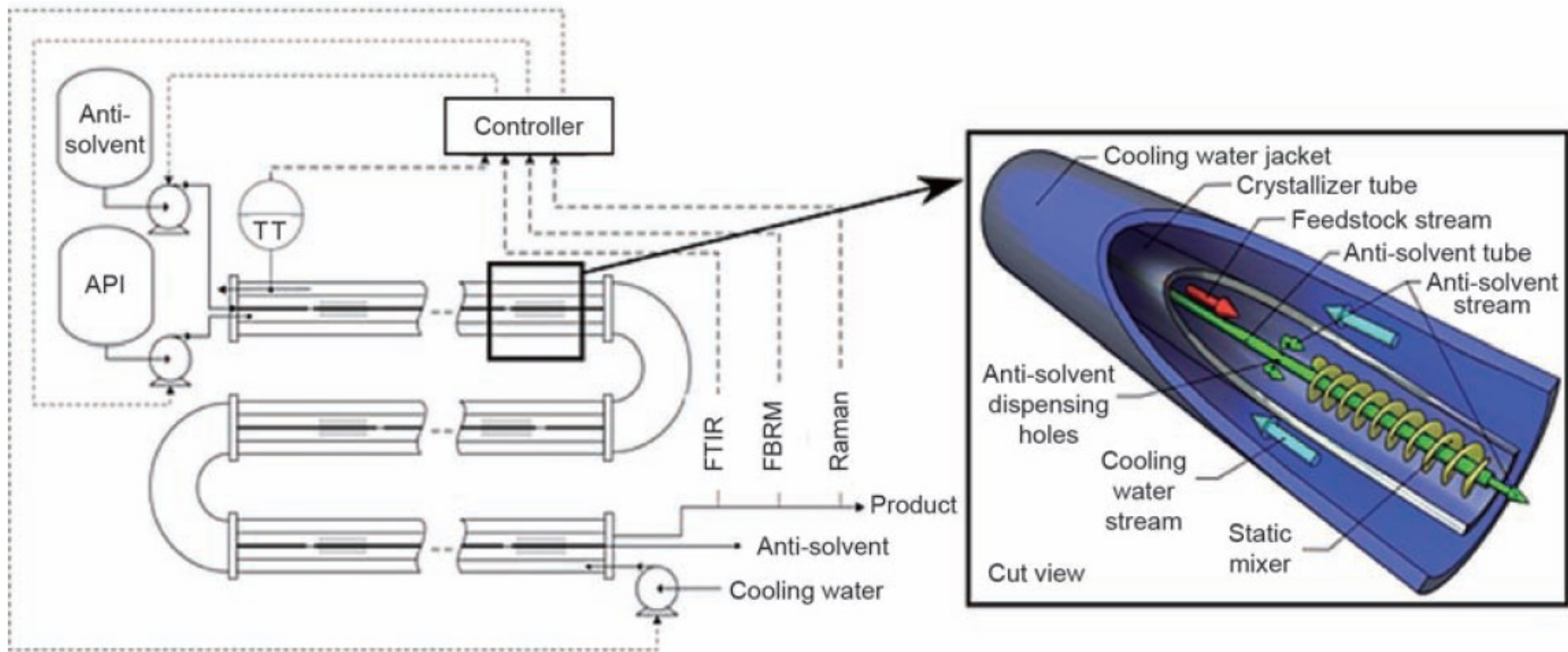

WHAT NEXT??

OSCILLATORY BAFFLED CRYSTALLIZATION

- Practical example

NiTech Solutions

Lawton, S.; Shering, P.; Zhao, L.; Laird, I.; Ni, X-W.
Org. Process Res. Dev. 13, 1357 (2009)

