

# **Physiology and Cultivation of Algae and Cyanobacteria**

**3.**

# Photosynthesis

- light
- structure & function
  - membrane structure
  - pigments
  - photosystems
- photosynthesis – reactions
  - light dependent
  - light independent
- energy transfers

# Light

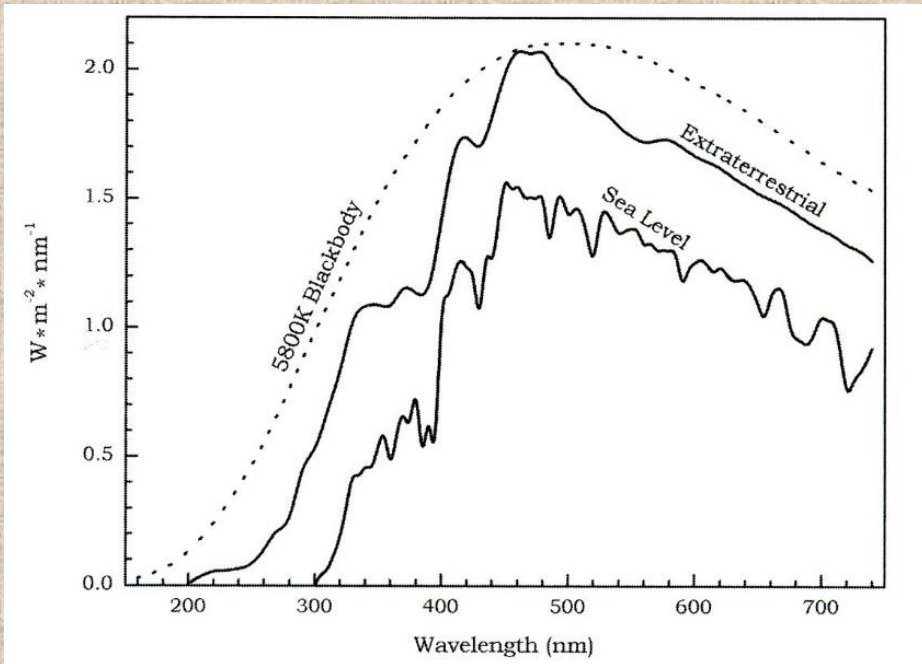
- sunlight *vs.* PAR
- units;  $\text{W m}^{-2} \text{s}^{-1}$ ;  $\mu\text{mol m}^{-2} \text{s}^{-1}$
- spectrum
- absorption, transmissivity, reflection, scattering, interference
- environmental accessibility (spectrum, int..)

### Sun Light Reflected by Sea Surface

Angle between Sun rays and zenith	0°	10°	20°	30°	40°	50°	60°	70°	80°	90°
Percentage of reflected light	2	2	2.1	2.1	2.5	3.4	6	13.4	34.8	100

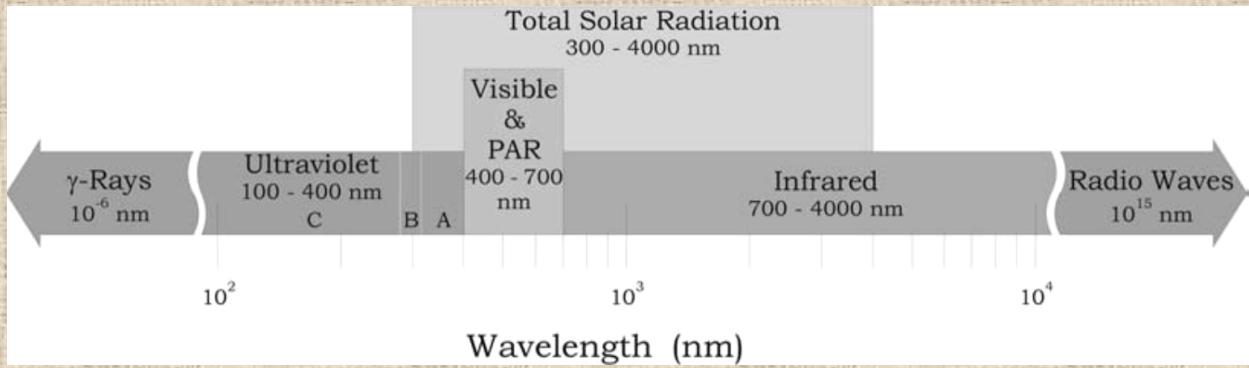
### Relationship between Transmitted Light Percentage and Absorbance Value

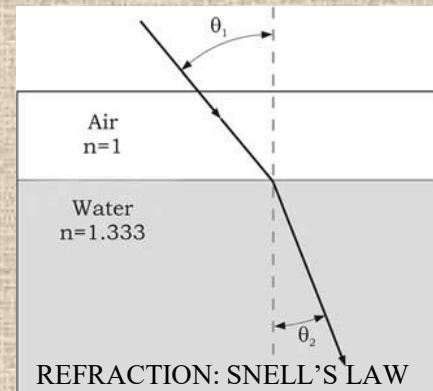
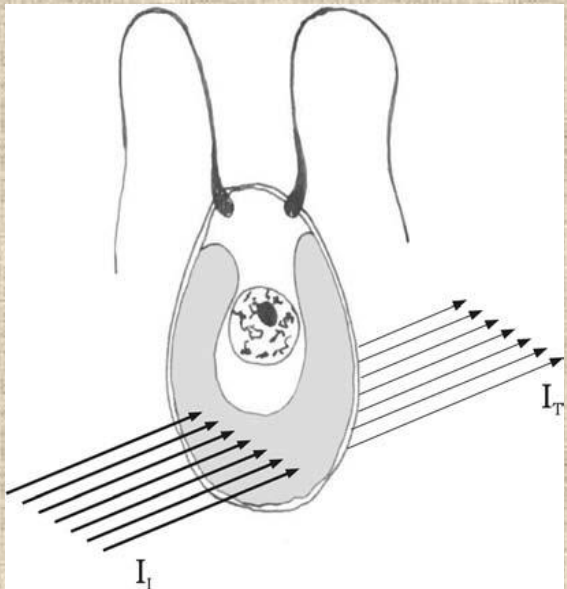
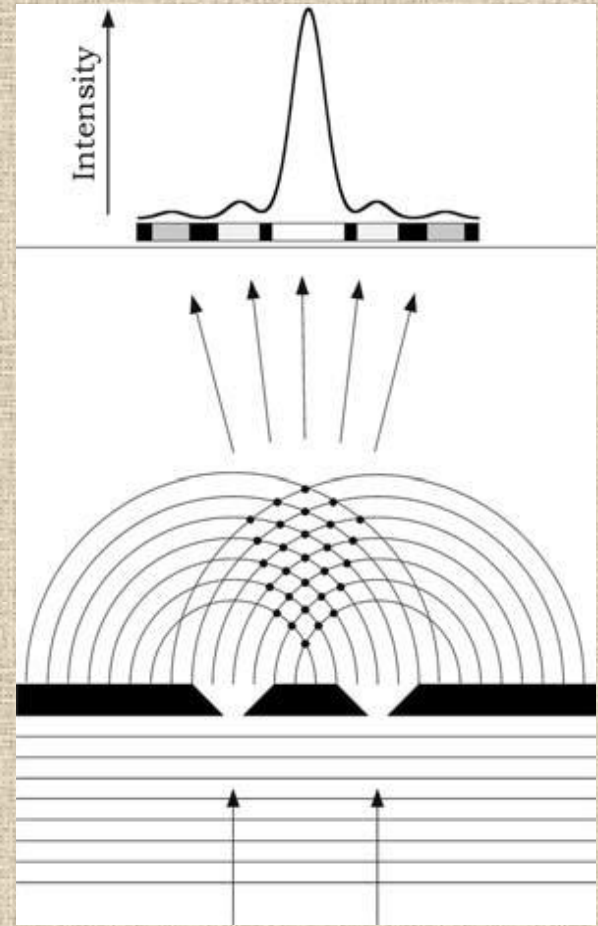
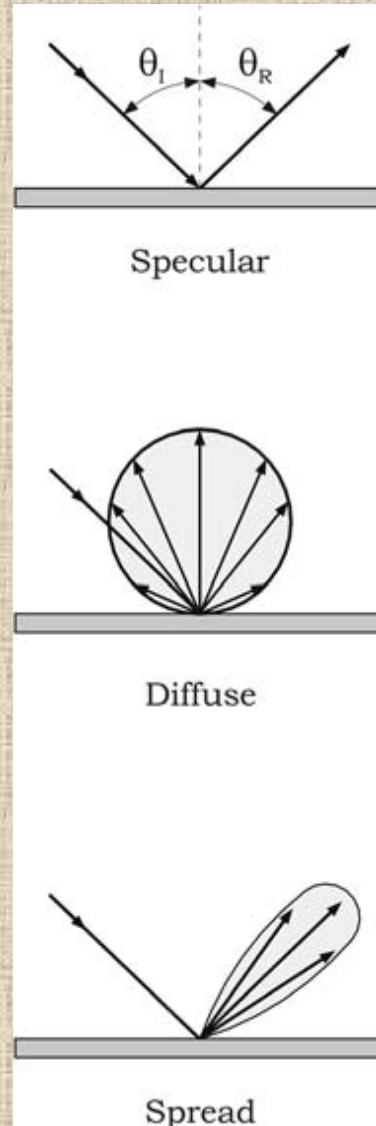
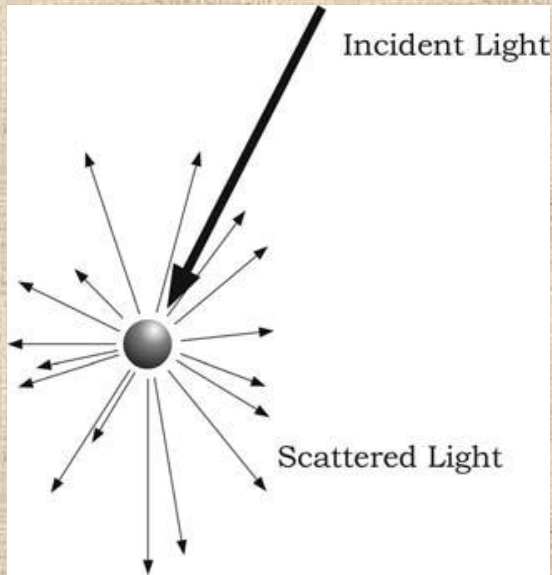
Transmittance	Absorbance
100	0.000
90	0.045
80	0.096
70	0.154
60	0.221
50	0.301
40	0.397
30	0.522
20	0.698
10	1.000
1	2.000
0.1	3.000



$$I_z = I_0 * e^{-kz}$$

Beer's law  
Light attenuation with depth (z)





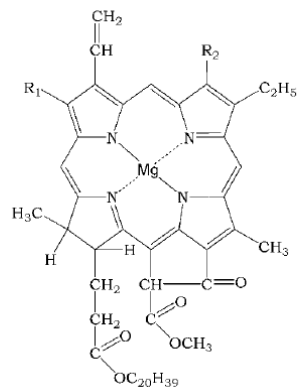
$$n = \frac{c_v}{c_s}$$

$${}_1n_2 = \frac{\sin(\theta_1)}{\sin(\theta_2)}$$

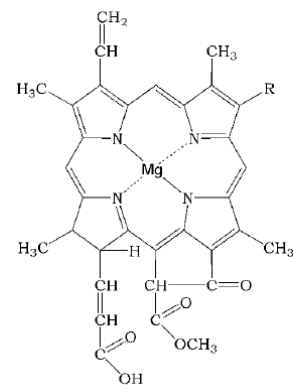
REFRACTION: SNELL'S LAW

# Structure & function

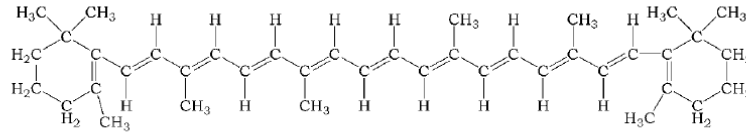
- thylakoid membrane structure
- pigments
- photosystems



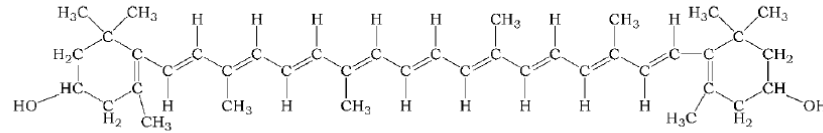
Chlorophyll a :  $R_1 = \text{CH}_3$   $R_2 = \text{CH}_3$   
 Chlorophyll b :  $R_1 = \text{CH}_3$   $R_2 = \text{CHO}$



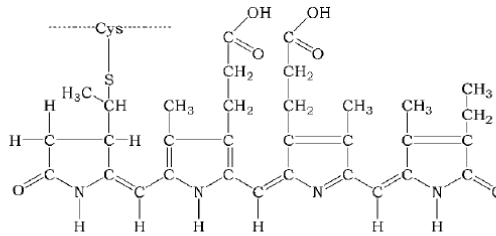
Chlorophyll  $c_1$  :  $R = \text{C}_2\text{H}_5$   
 Chlorophyll  $c_2$  :  $R = \text{CH}=\text{CH}_2$



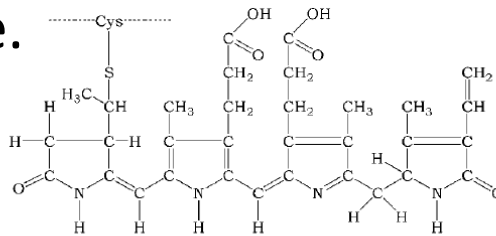
$\beta$ -carotene



Lutein

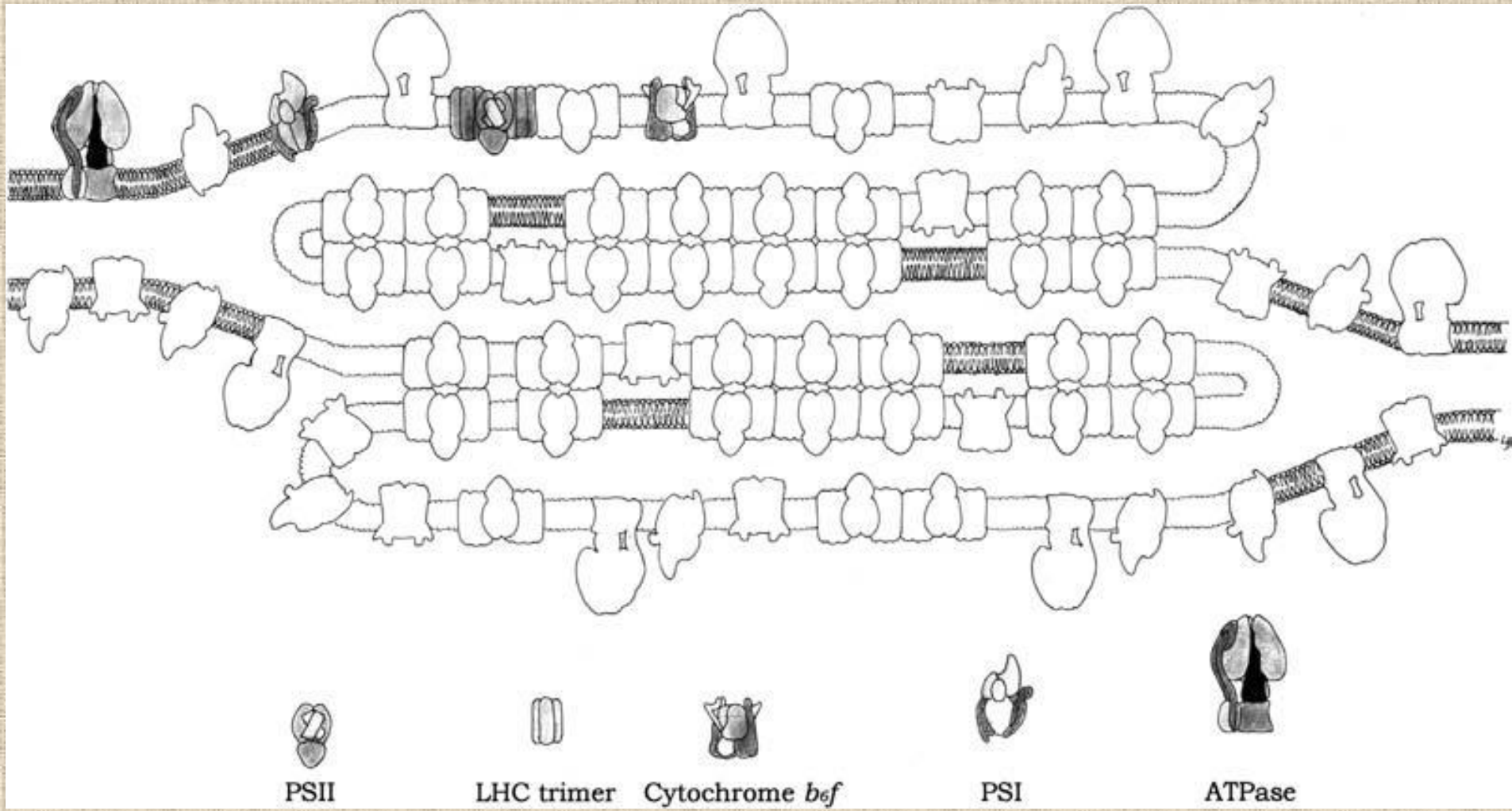


Phycocyanobilin

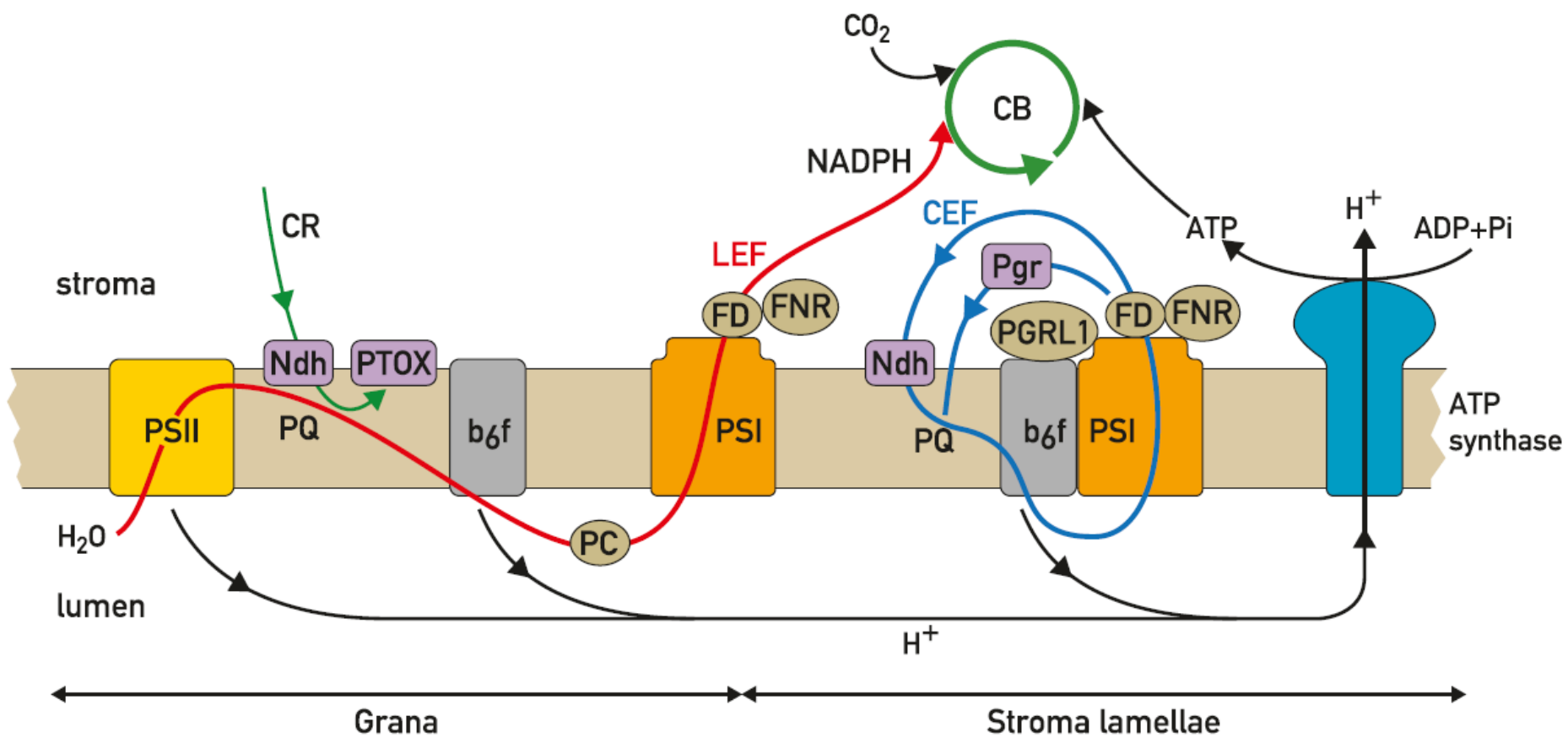


Phycoerythrobilin

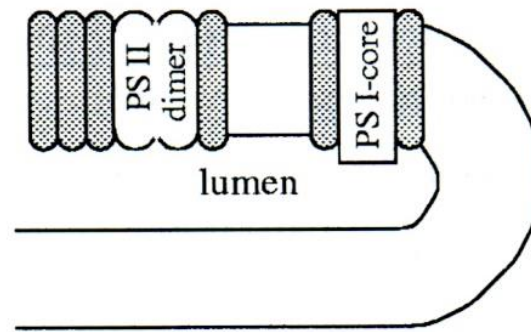
Structure of  
 the main pigments  
 of the thylakoid membrane.



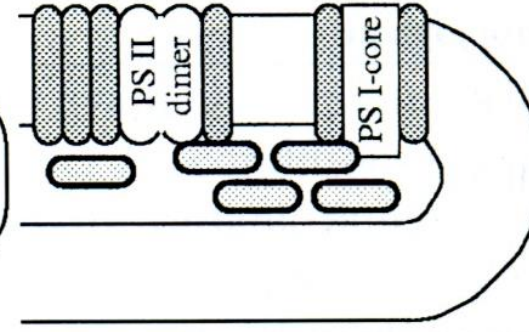




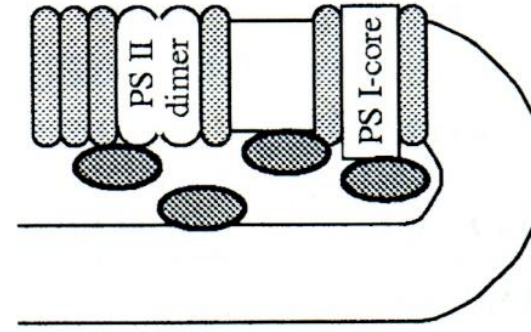
Chlorophyceae, Chromophytes and green plants:



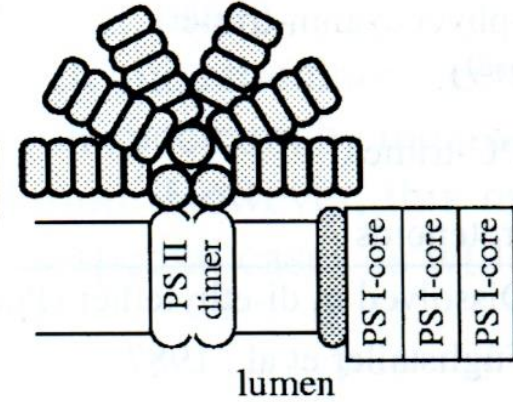
Cryptophyceae:



Dinophyceae:



Rhodophyceae:



soluble peridinin-Chl *a* complex:



phycobiliprotein:

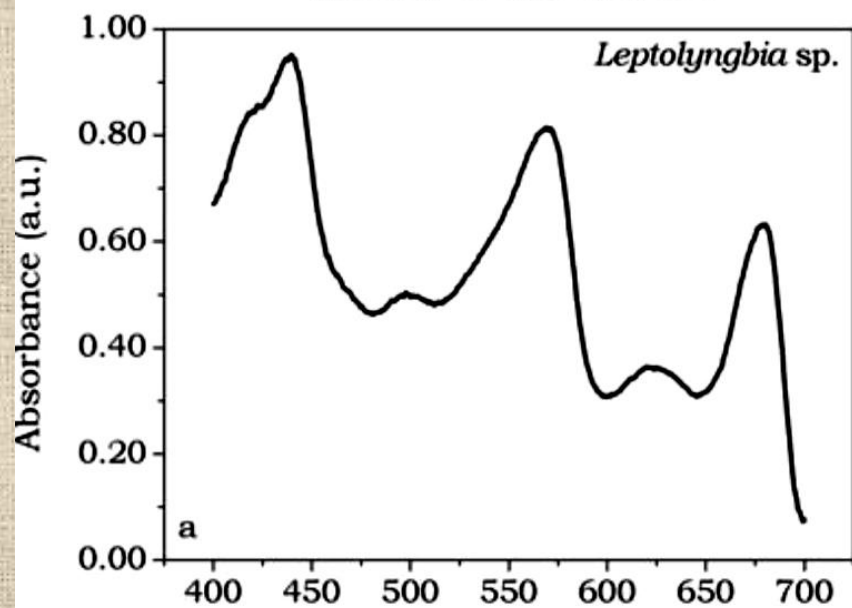


LHC:

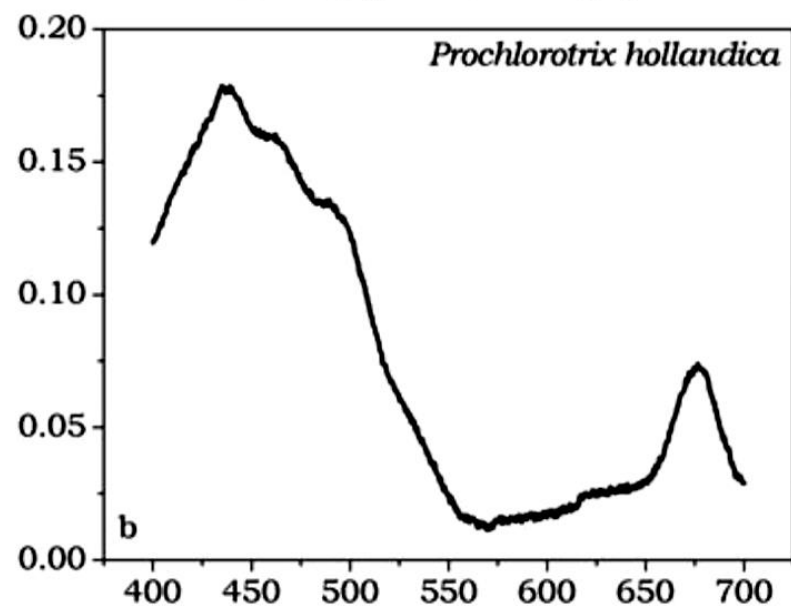


*Fig. 3.* Association of the different peripheral LHCs with the RCs of PS I and PS II in the thylakoid membranes of different groups of algae.

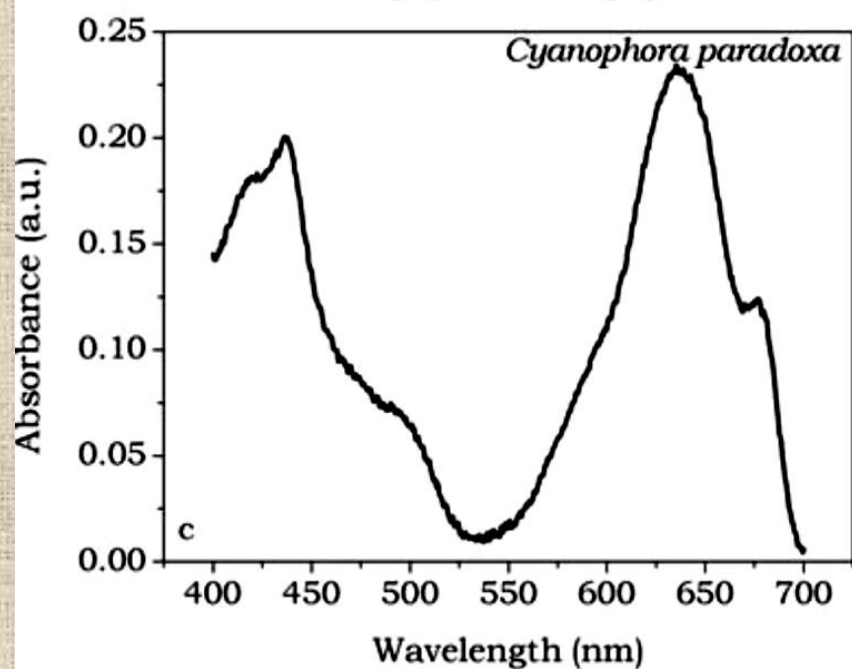
Cyanophyta: Cyanophyceae



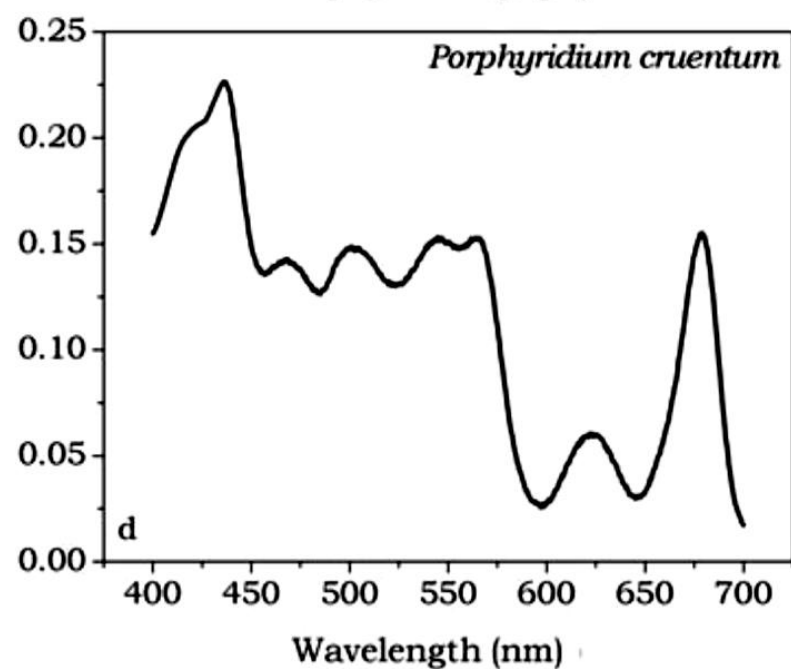
Prochlorophyta: Prochlorophyceae



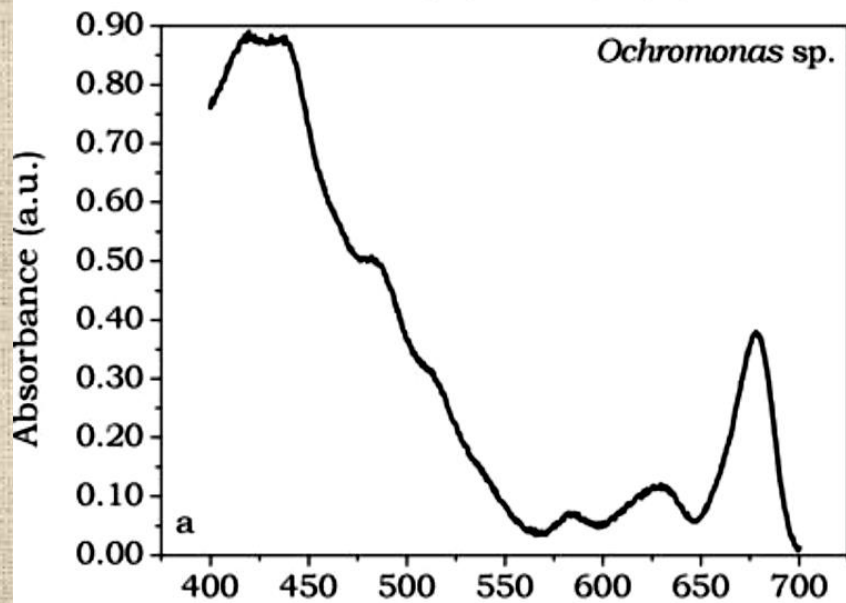
Glaucophyta: Glaucophyceae



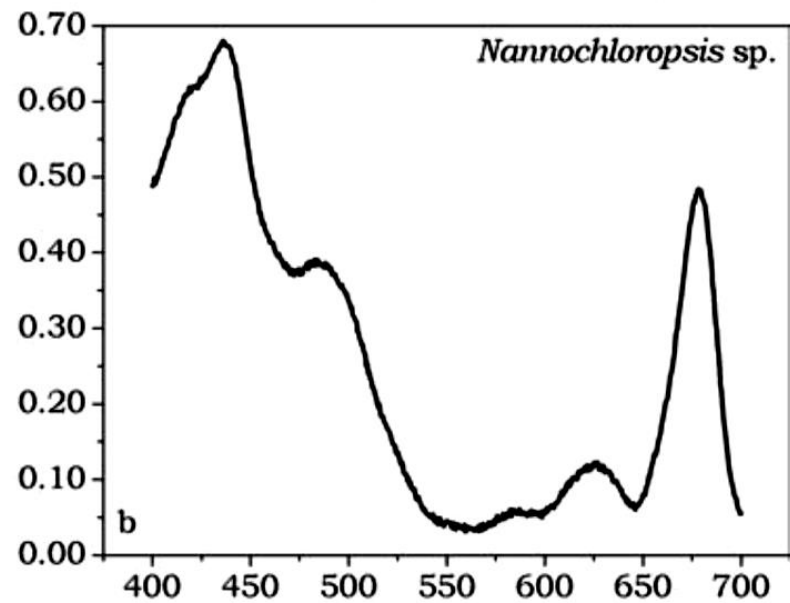
Rhodophyta: Bangiophyceae



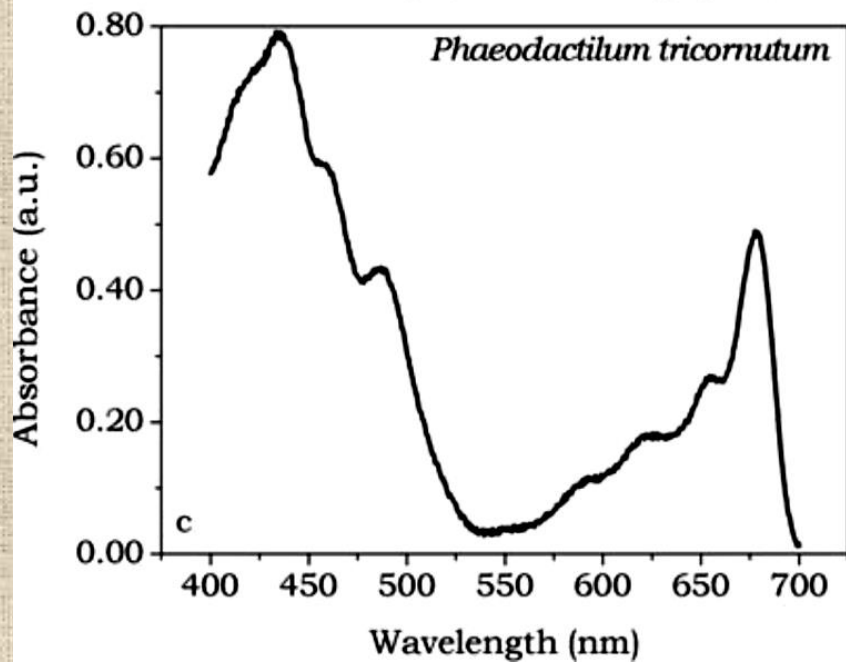
Heterokontophyta: Chrysophyceae



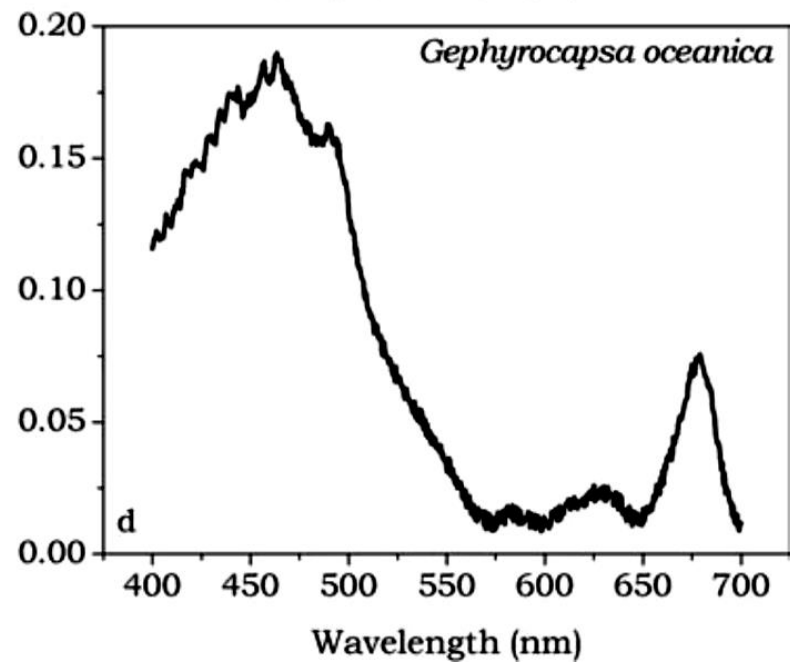
Heterokontophyta: Eustigmatophyceae



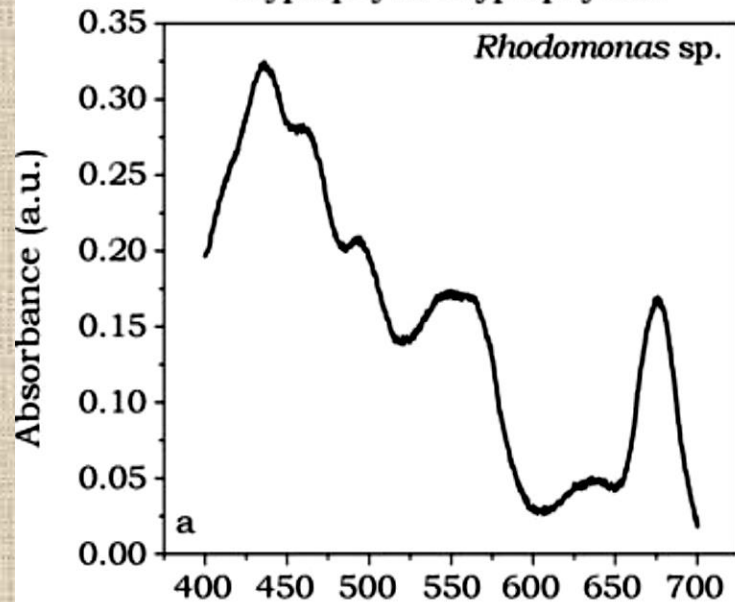
Heterokontophyta: Bacillariophyceae



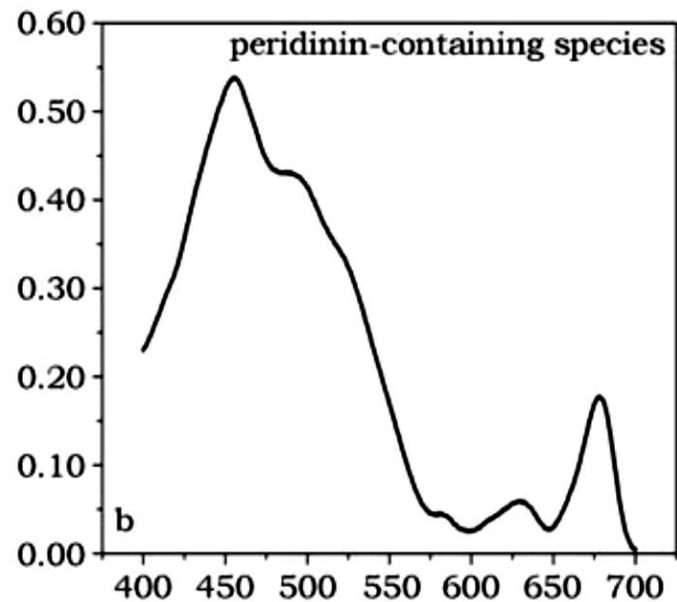
Haptophyta: Haptophyceae



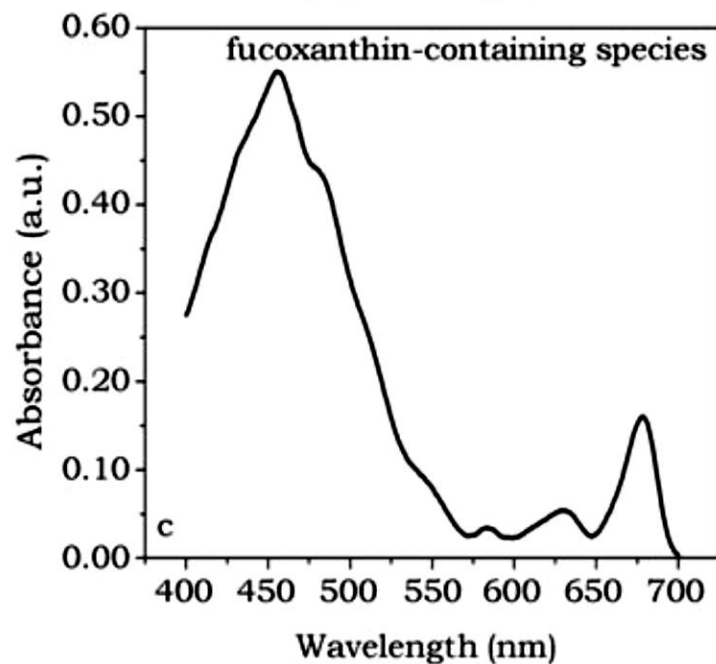
Cryptophyta: Cryptophyceae



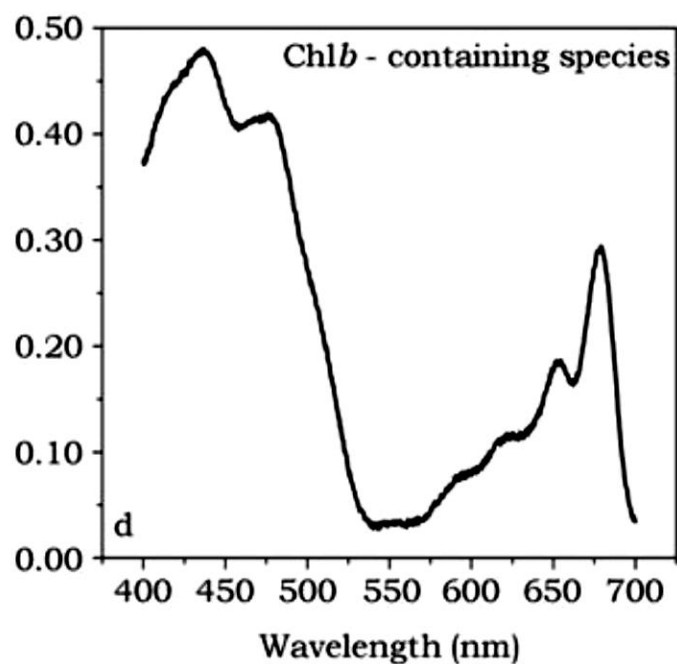
Dinophyta: Dinophyceae



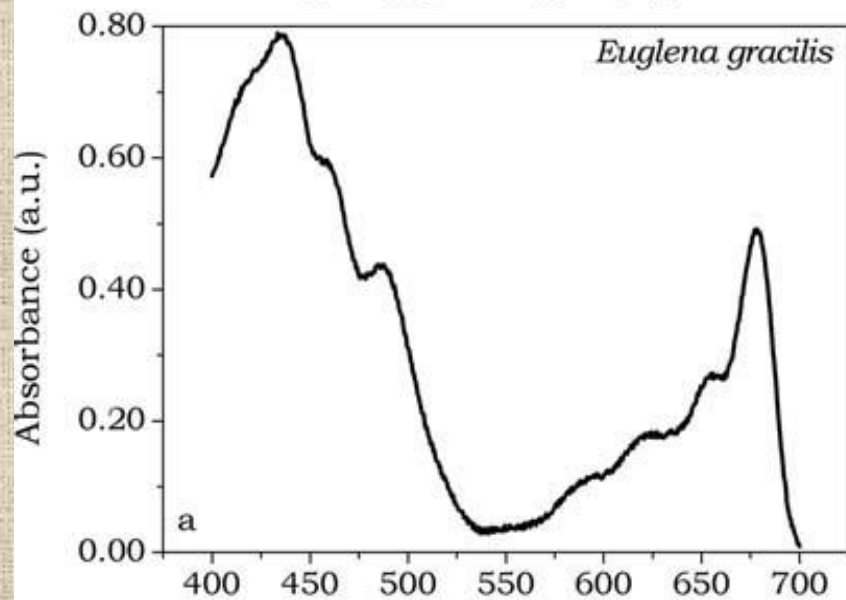
Dinophyta: Dinophyceae



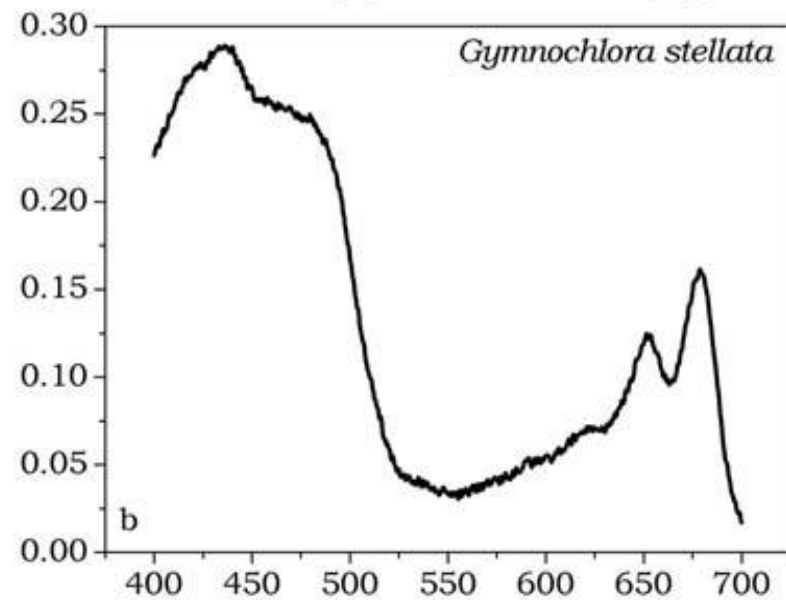
Dinophyta: Dinophyceae



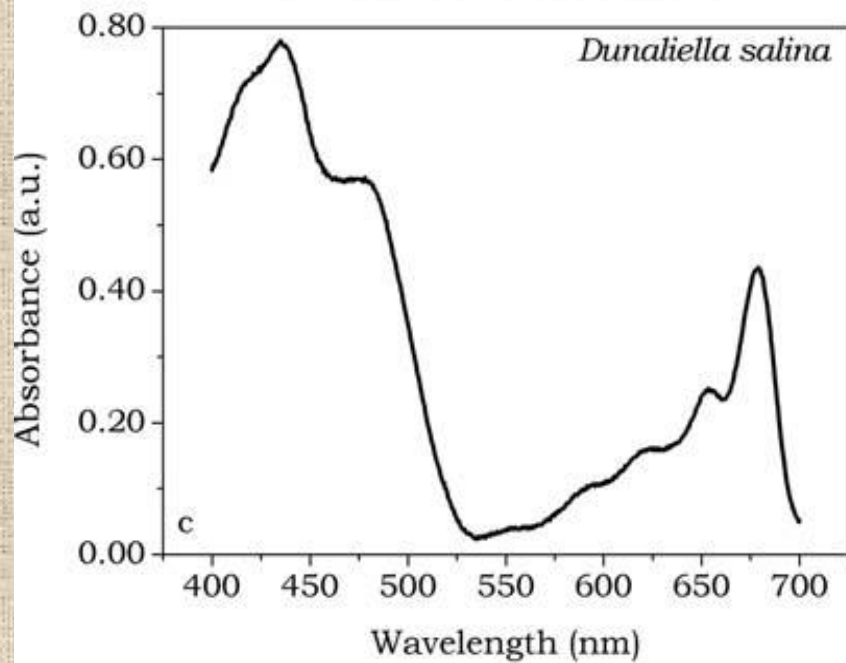
## Euglenophyta: Euglenophyceae



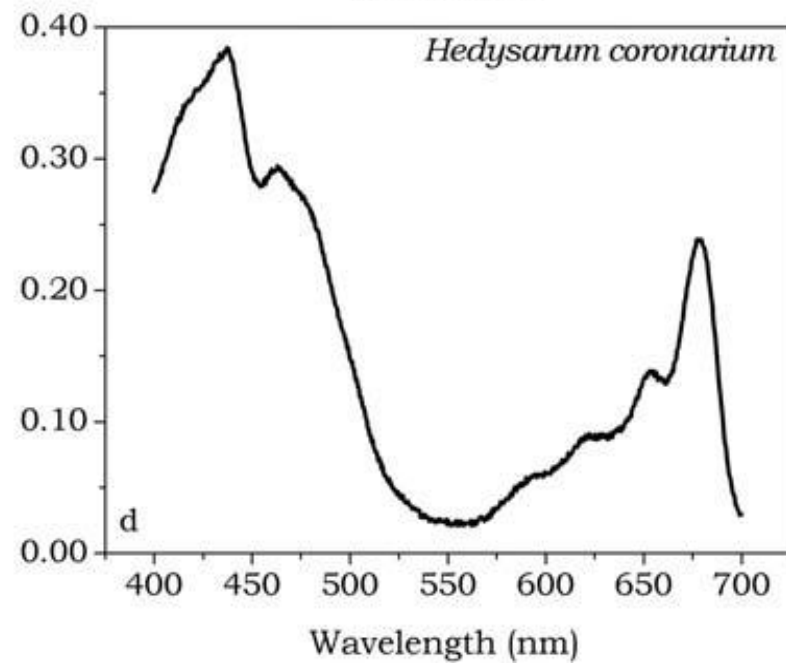
## Chlorarachniophyta: Chlorarachniophyceae

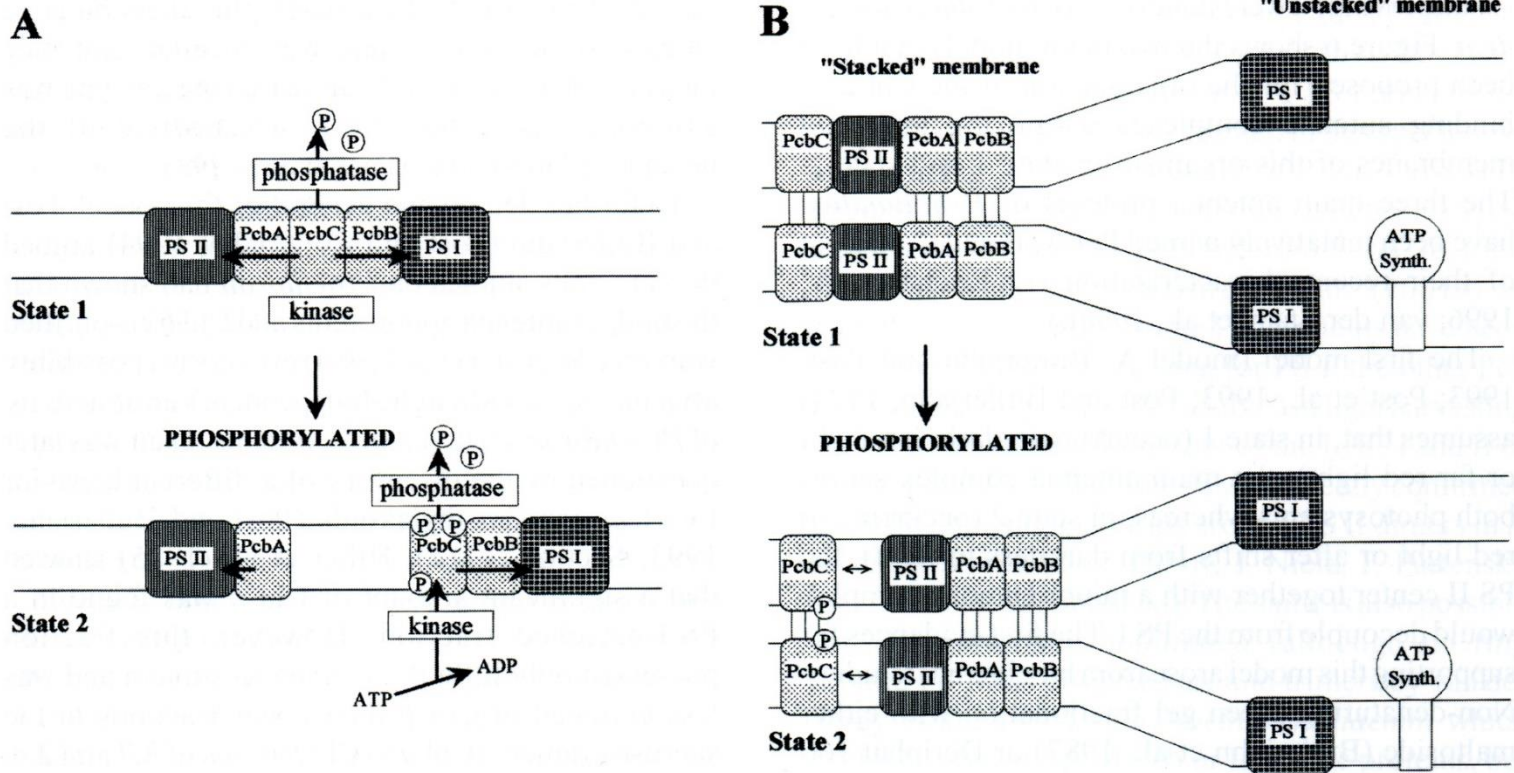


## Chlorophyta: Chlorophyceae



## Land Plants





*Fig. 6.* Current models for the localization of the antenna proteins with regard to photosystems in thylakoid membranes of *Prochlorothrix hollandica* and effect of state 1-state 2 transitions. The original schemes have been redrawn in light of the recent identification of the three Pcb proteins and for a better homogenization. **A:** Model from Post et al. (1993). The Chl *a/b* antenna consists of a bulk antenna which is located on apoproteins of '30-kDa' (PcbA) and '35-kDa' (PcbC) and associated preferably with PS I. A minor Chl *a/b* antenna is carried by a '33-kDa' (PcbB) apoprotein and is found to co-purify with PS II. The '35-kDa' antenna protein forms the major target protein of light/redox controlled kinase activity. Upon phosphorylation, the bulk antenna excludes PS II centers and enters a tighter association with PS I. Under such conditions, the energy transfer to PS I is enhanced. This process reverses to a state of balanced energy transfer by the bulk antenna following dephosphorylation of the antenna in either darkness or far red illumination. **B:** Model from van der Staay and Staehelin (1994). As in chloroplasts, PS II and the Chl *a/b* antenna are located in 'stacked' parts of the thylakoid membrane, whereas PS I and the ATP synthase are restricted to the 'unstacked' membranes. The Chl *a/b* antenna associated with PS II comprises four polypeptides with apparent molecular masses of '32-kDa' (PcbA), '33.5-kDa', '35-kDa' (one or both of these probably correspond to PcbB) and '38-kDa' (PcbC), all of which are assembled into one antenna complex. The '38-kDa' antenna gets phosphorylated at high light. In accordance with the fluorescence data, an uncoupling of the phosphorylated antenna from PS II is assumed to occur, but it would not migrate into the 'unstacked' membranes.

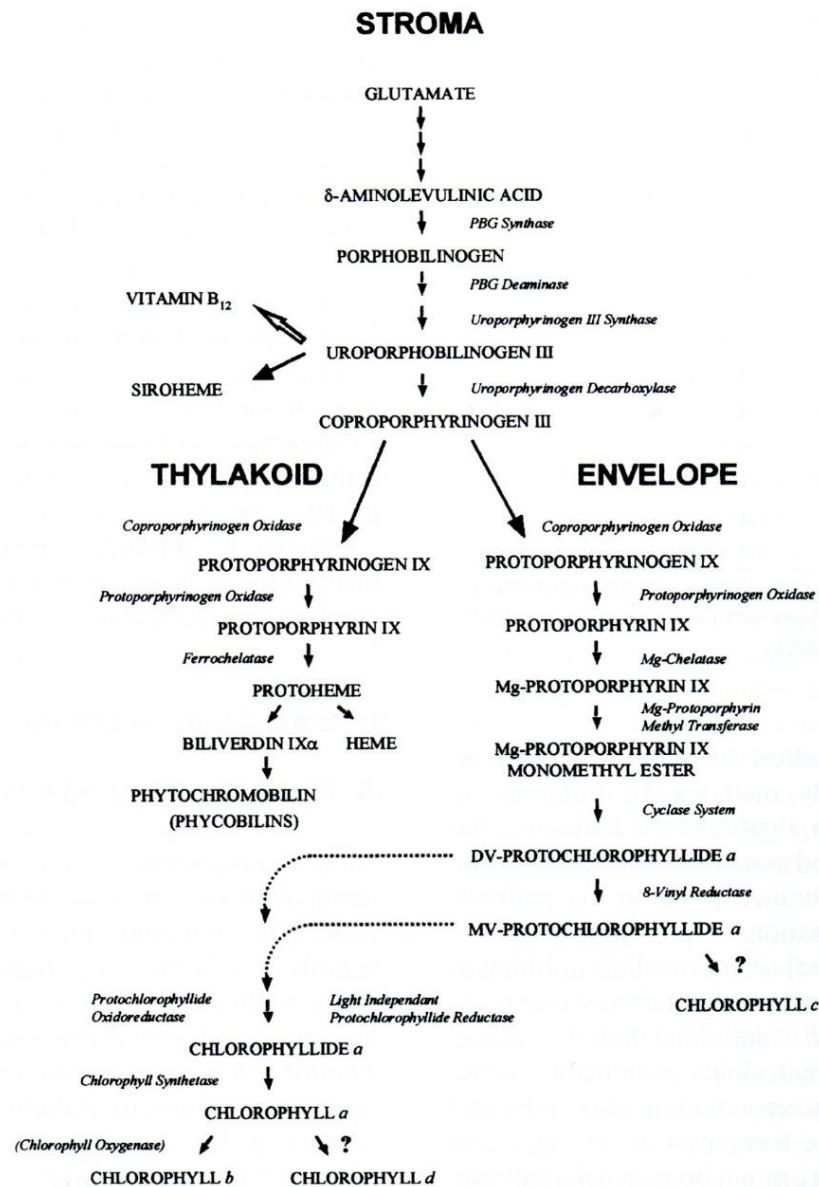


Fig 1. General outline of the tetrapyrrole biosynthesis pathway in photosynthetic organisms. Shown are the major intermediates and enzymes involved in tetrapyrrole formation in plants, algae, and photosynthetic bacteria and the proposed location of the enzymatic activities in plastids. The steps leading to phycobilin and vitamin B<sub>12</sub> formation appear to be restricted to prokaryotic organisms. The dashed lines indicate the possible transport of these compounds from the plastid envelope to the thylakoids.



# Photosynthetic reactions

- general equation:



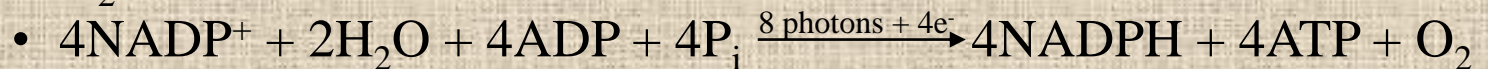
- light dependent reactions

- light interception, l. energy transfer
- excitation, charge separation
- ETR

» linear

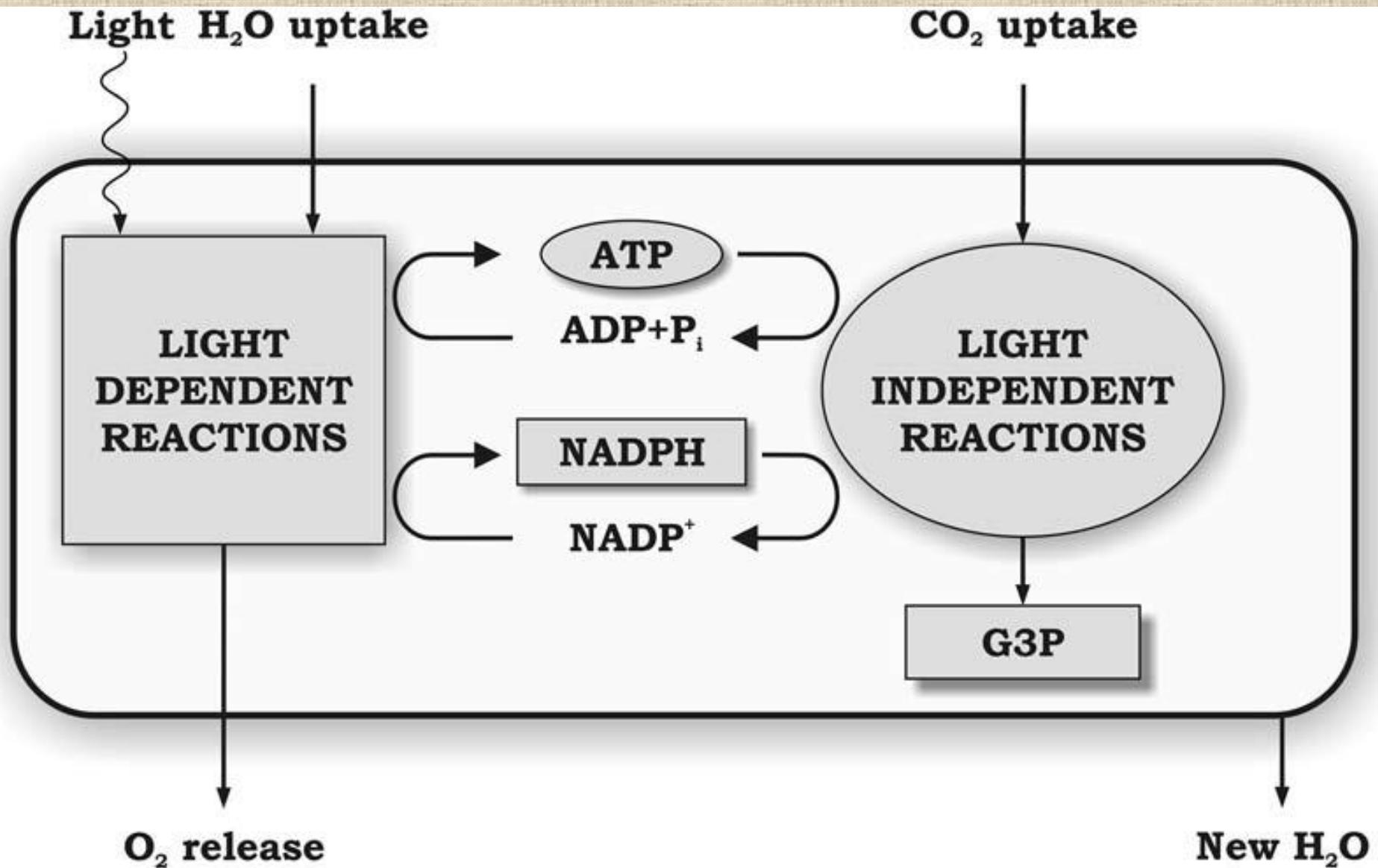
» cyclic

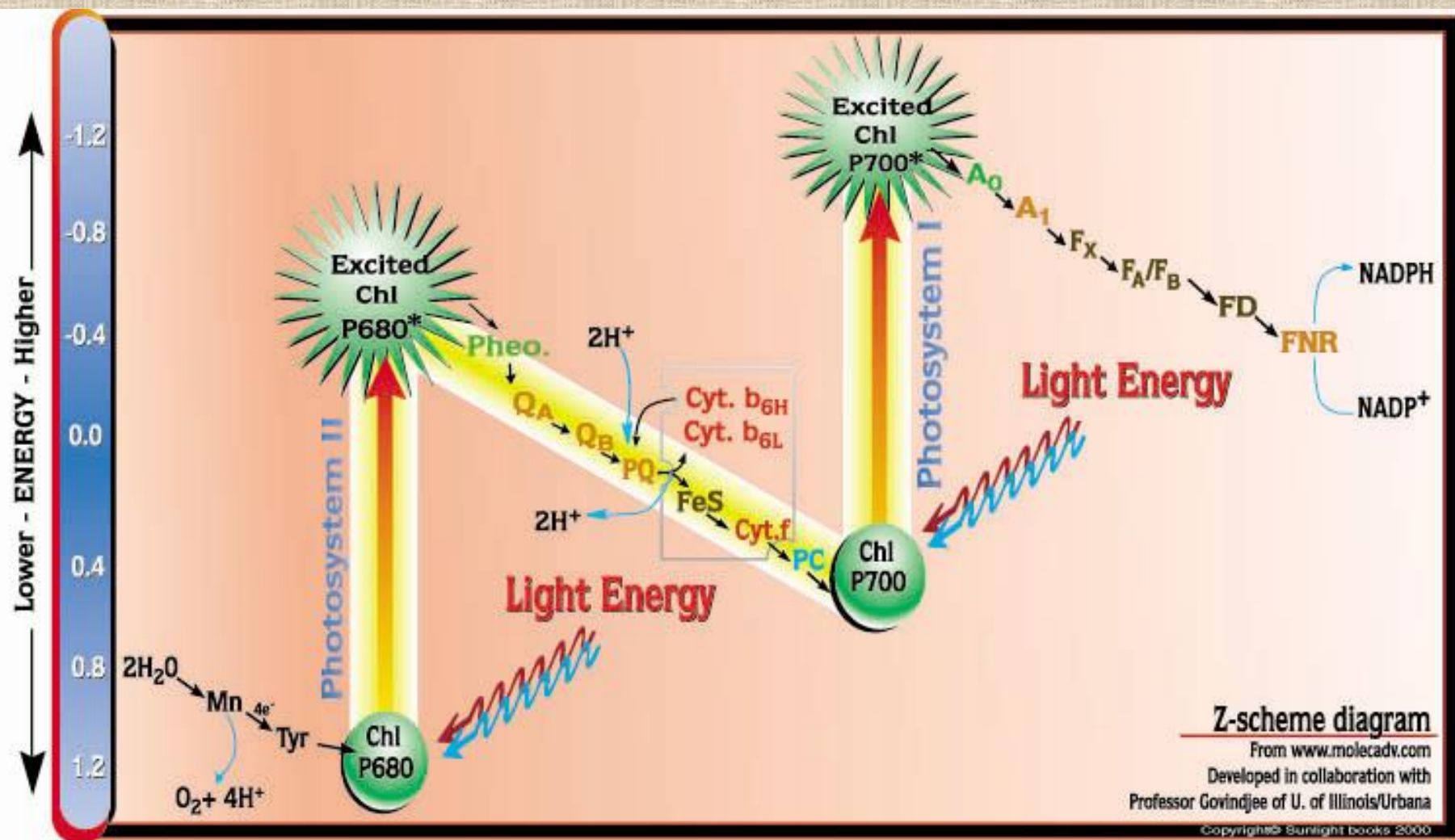
- O<sub>2</sub> evolution



- light independent reactions

- CBB – Calvin Benson Bassham Cycle
- RuBisCO
- CA





### Z-scheme diagram

From [www.molecadv.com](http://www.molecadv.com)

Developed in collaboration with  
Professor Govindjee of U. of Illinois/Urbana

Copyright © Sunlight books 2000

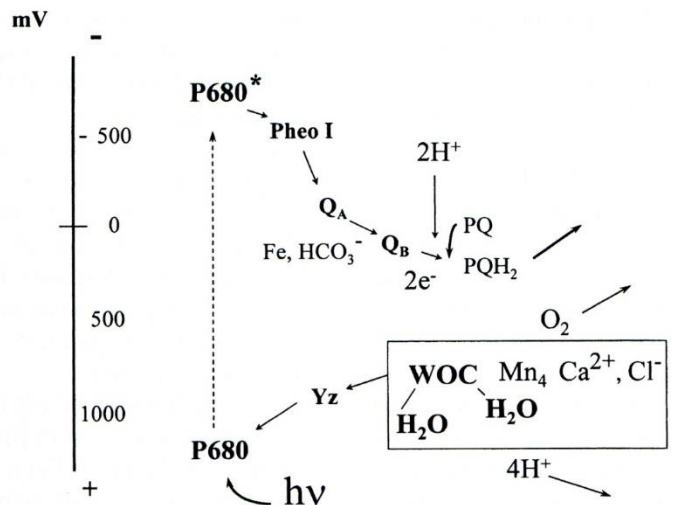


Fig. 1. Diagram showing the main cofactors of PS II, the pathway of electrons through the reaction center and the probable redox potential relationship between the cofactors. Electron flow occurs from P680 and Pheo I. Water donates electrons to P680\* via Y<sub>Z</sub> (D1 Tyr161). The water oxidizing complex (WOC) involves Mn, plus possibly Ca<sup>++</sup> and Cl<sup>-</sup> cofactors, oxygen evolution requiring four turnovers of the reaction center. A non-heme iron (Fe) is located between Q<sub>A</sub> and Q<sub>B</sub> and bicarbonate (HCO<sub>3</sub><sup>-</sup>) also binds in this region. Q<sub>B</sub> picks up two electrons and two protons, transferring these to the membrane plastoquinone pool (PQ). Key: P680, the primary chlorophyll electron donor; P680\*, excited state of P680; Pheo, pheophytin electron acceptor I; Q<sub>A</sub> and Q<sub>B</sub>, primary and secondary plastoquinones.

## Electron Transfer in PSII

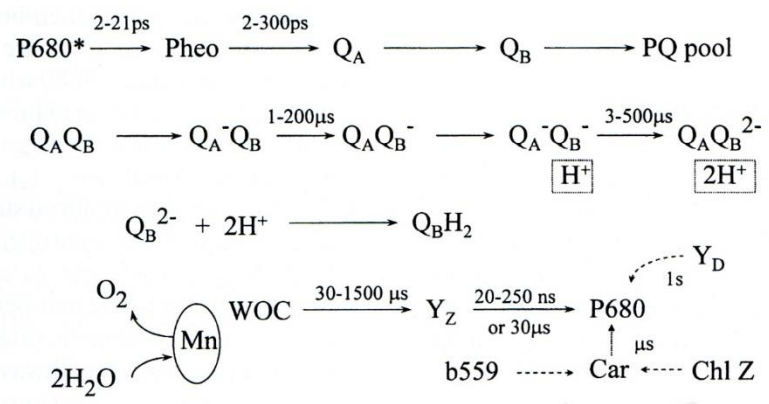
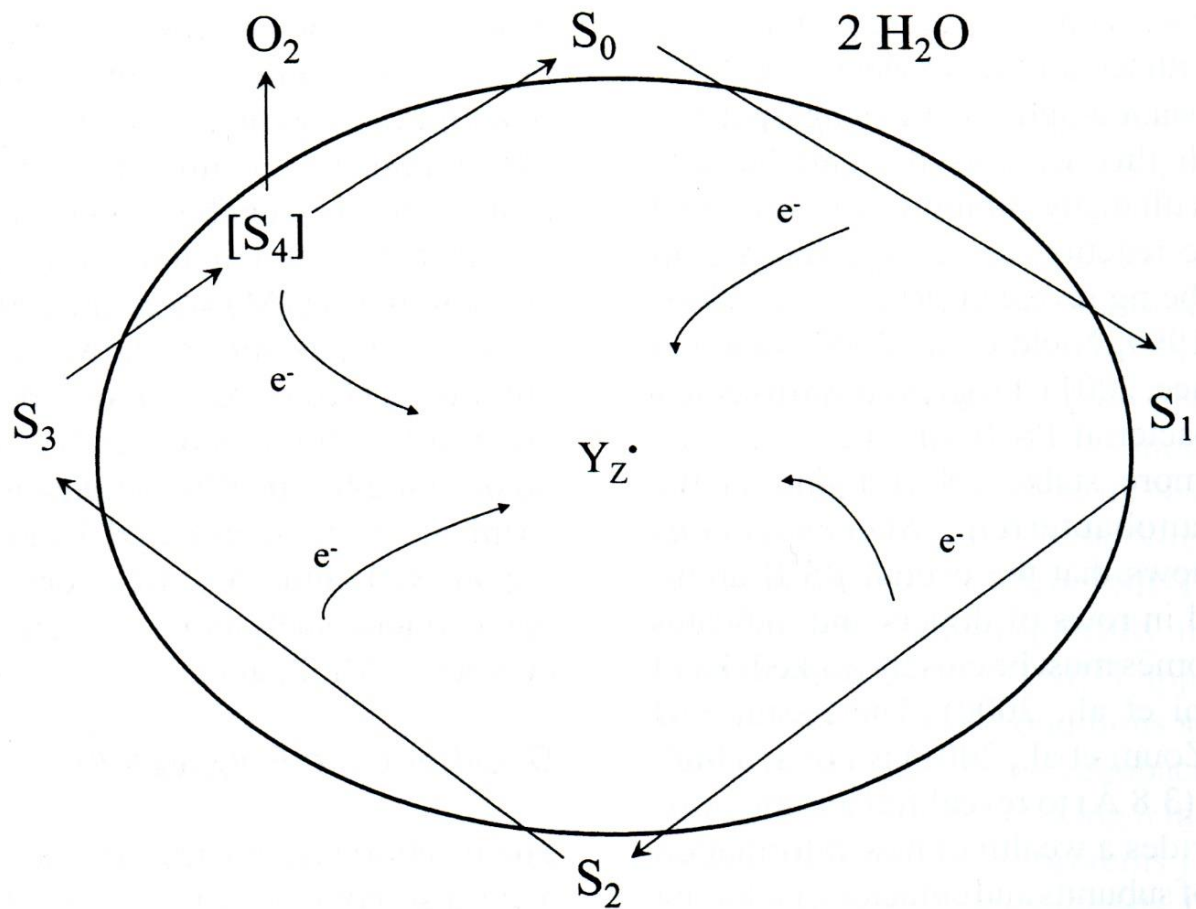


Fig. 2. Diagram showing the main kinetics of the main pathway of electrons through the PS II reaction center. Y<sub>D</sub> (D2 Tyr161), Chlorophyll Z (Chl Z) and Cytochrome b<sub>559</sub> (b<sub>559</sub>) are alternate electron donors under certain conditions. See also Figure 1.



*Fig. 3.* The S-states of the water oxidizing complex (WOC). Electrons are removed sequentially by  $\text{P680}^+$  via  $Y_Z$ . The S-state number indicates the number of oxidizing equivalents stored. On reaching  $S_4$ , oxygen is released and the cycle reset. The steps at which water may be bound, oxidized and protons released are discussed in the text.

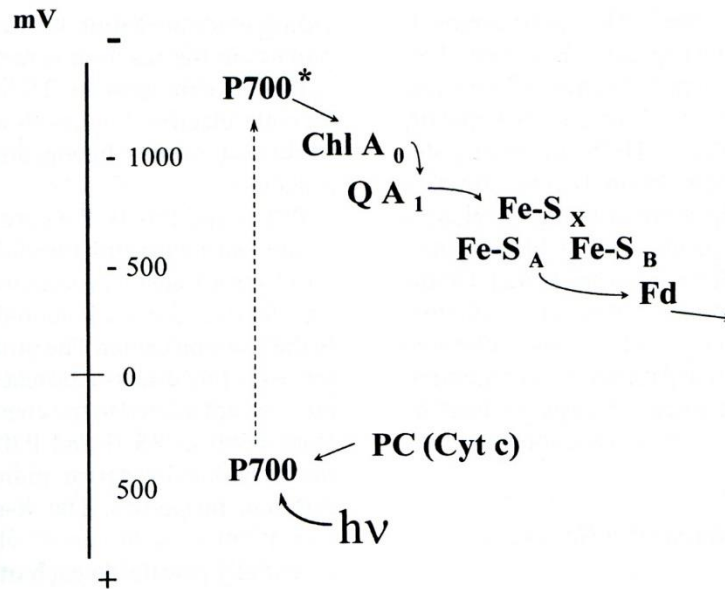


Fig. 4. Diagram showing the main cofactors of PSI, the pathway of electrons through the reaction center and the probable redox potential relationship between the cofactors. Absorption of light energy ( $h\nu$ ) or excitons by P700 leads to a photochemical charge separation. Electron flow occurs from Plastocyanin (PC) to Ferredoxin (Fd). Electron transfer from P700 occurs across the membrane to reduce the iron-sulfur centers. PC donates an electron to P700<sup>+</sup>. Key: P700, primary electron donor; P700\*, excited state of P700; A<sub>0</sub>, Chl electron acceptor; A<sub>1</sub>, phylloquinone (Q); Fe-S<sub>X</sub>, Fe-S<sub>A</sub> and Fe-S<sub>B</sub>, are iron-sulfur centers; Cyt c, cytochrome c is an alternative electron donor.

## Electron Transfer in PSI

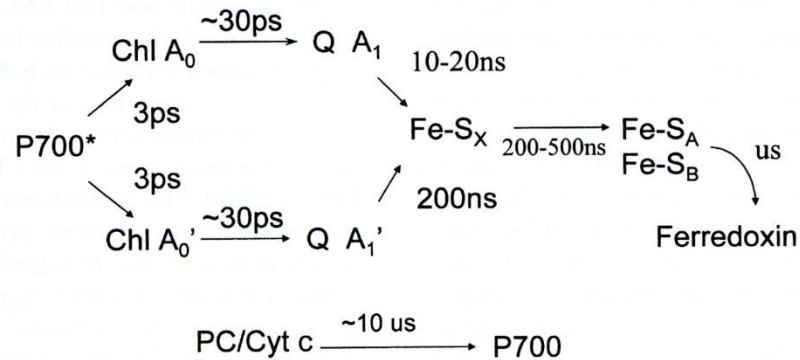
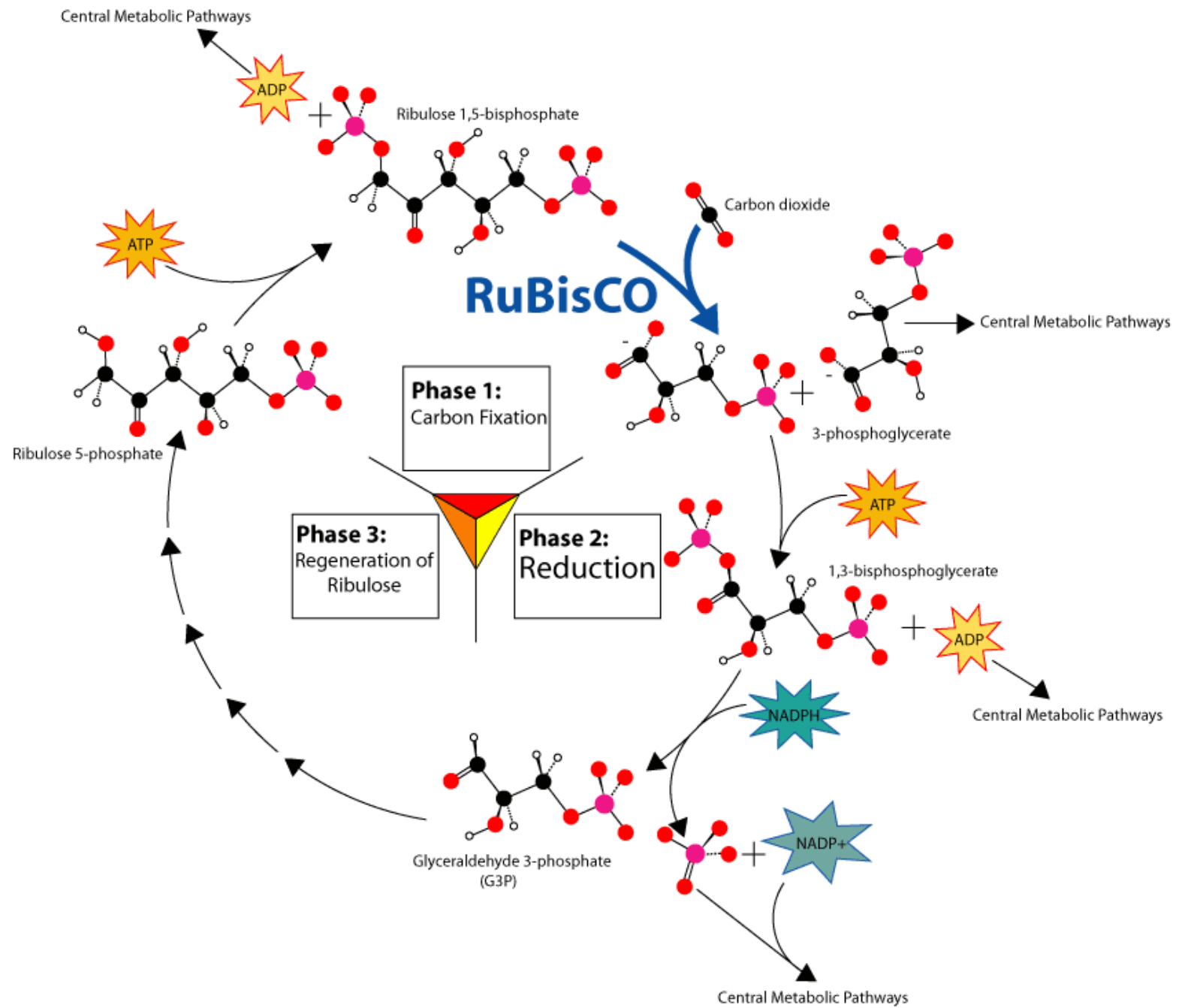


Fig. 5. Diagram showing the main kinetics of the main pathway of electrons through the PS I reaction center.



# Role of Carbon Concentrating Mechanism

- Carbonic Anhydrase
  - periplasmic space, carboxysomes (b-g algae), pyrenoid (algae)
  - CA *vs.* RuBisCO
- mechanisms of  $\text{HCO}_3^-$  uptake
  - active transp. via CMP (enough ATP)
  - symport  $\text{Na}^+ \text{HCO}_3^-$  - via icpB complex
  - $\text{Na}^+/\text{H}^+$  antiport help
  - diffusion
- $\text{CO}_2$  uptake - diffusion



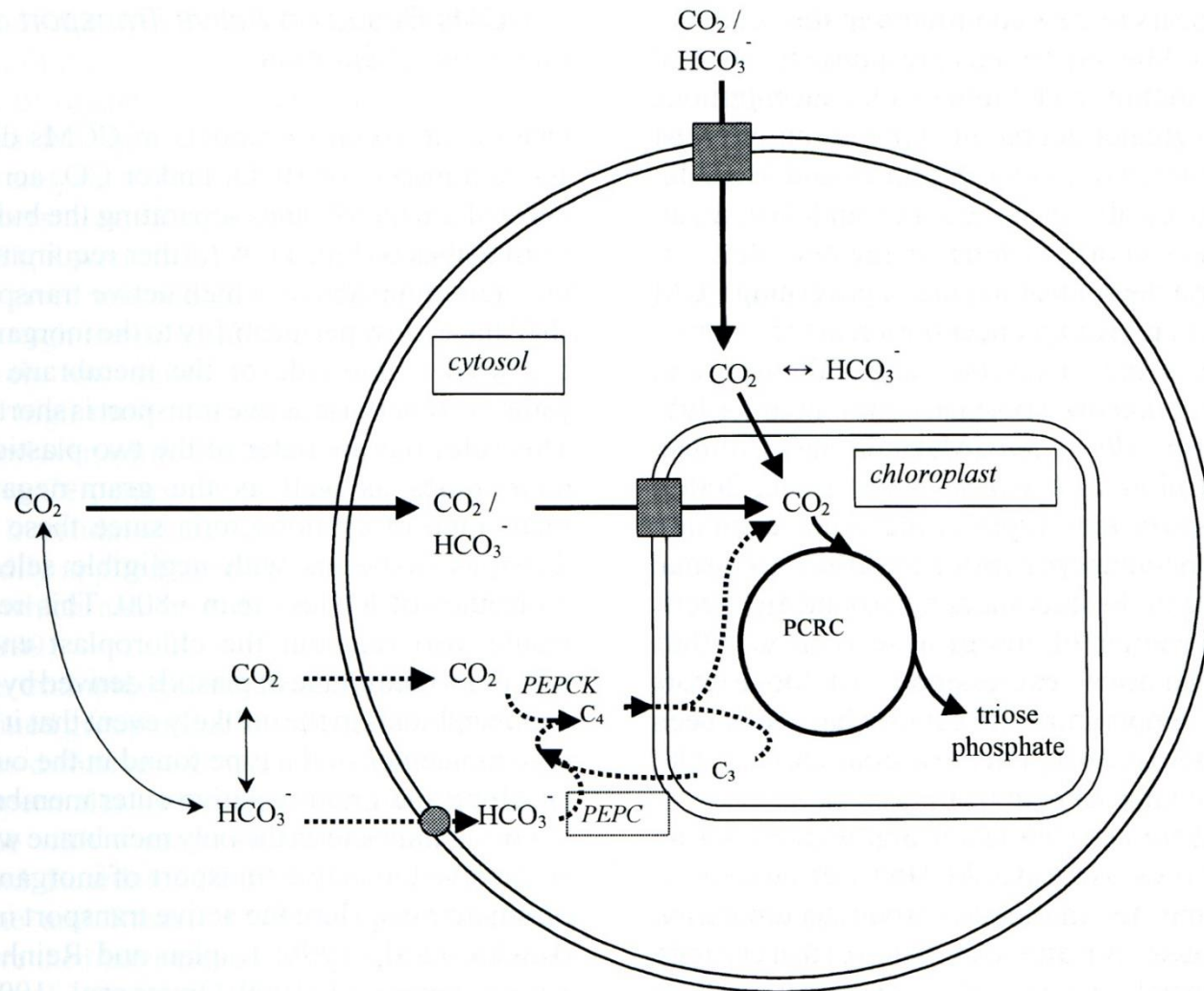
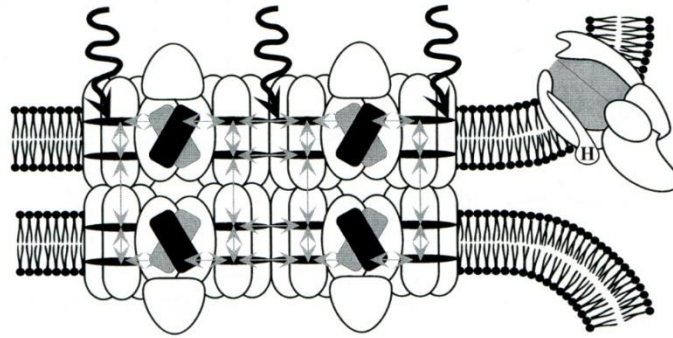


Fig. 1. A simplified scheme for transport of inorganic carbon into eukaryotic algal cells via active transport of  $\text{CO}_2$  and/or bicarbonate. As explained in the text,  $\text{CO}_2$  will cross membranes by diffusion, whereas active transport (shown by the shaded boxes) can be of  $\text{CO}_2$  or  $\text{HCO}_3^-$ . Active transport can occur at the plasmalemma or at the chloroplast envelope or at both membranes. Carbonic anhydrases in the periplasmic space, cytosol and chloroplast maintain equilibrium between  $\text{CO}_2$  and  $\text{HCO}_3^-$ . Also shown (dotted line) is a putative role for  $\text{C}_4$ -like metabolism in  $\text{CO}_2$  concentration (see text for details). PCRC – photosynthetic carbon reduction cycle; PEPC – phosphoenolpyruvate carboxylase; PEPCK – phosphoenolpyruvate carboxykinase. Redrawn after Sültemeyer (1998).

# Energy transfers & regulations

- excitation energy (excess) dissipation pathways
  - photosynthesis
  - state transitions
  - heat production (Xanthophyll cycle)
  - fluorescence
- photoacclimation
  - light dependent motions; state transitions; non-photochemical processes
- photoinhibition
  - photomodification
  - photodamage
- photorespiration & chlororespiration
  - RuBisCo – generation of glycolate
  - enigma; PQ pool reduction

state 1



state 2

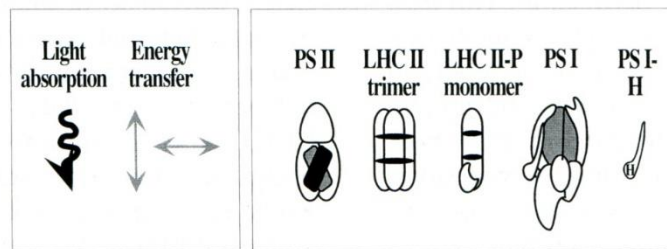
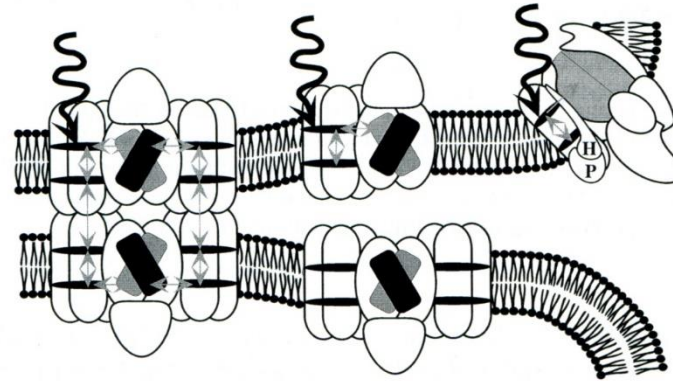
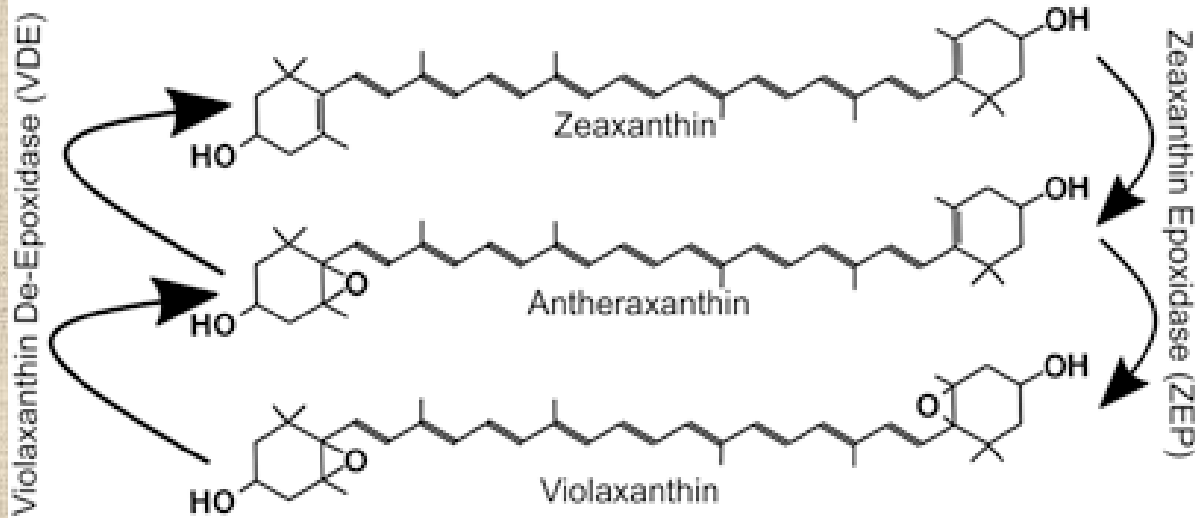
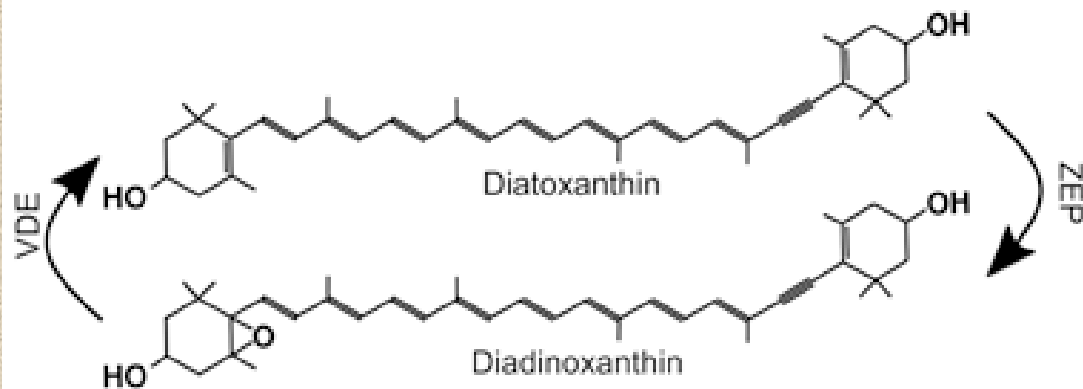


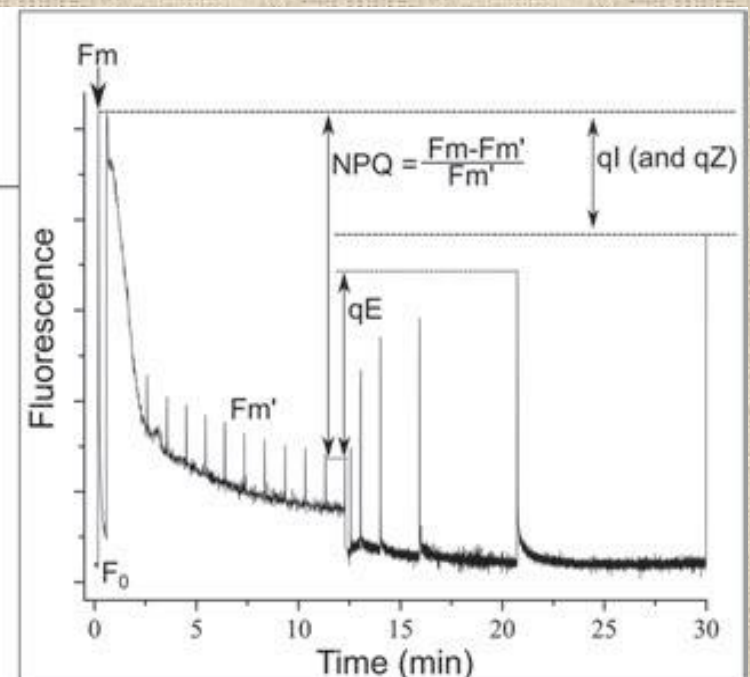
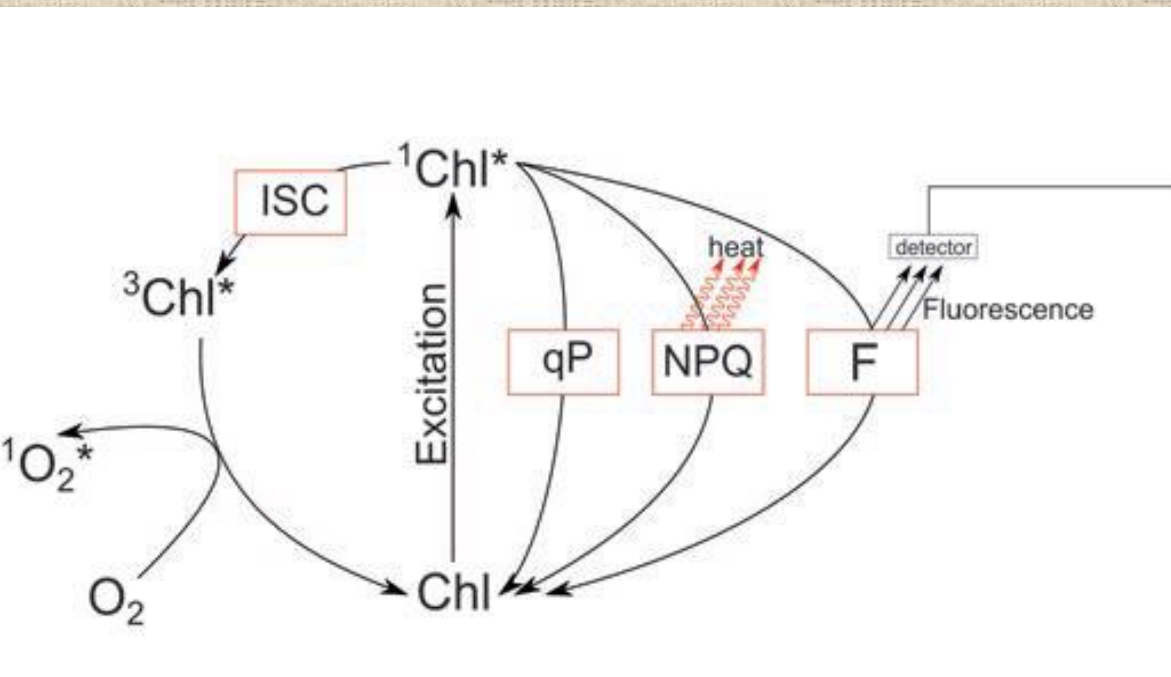
Fig 6. Artist's impression of the difference between State 1 and State 2 organization in appressed and non-appressed thylakoids in green plants. Redrawn with permission from Forsberg and Allen (2001a).

## Xanthophyll cycle

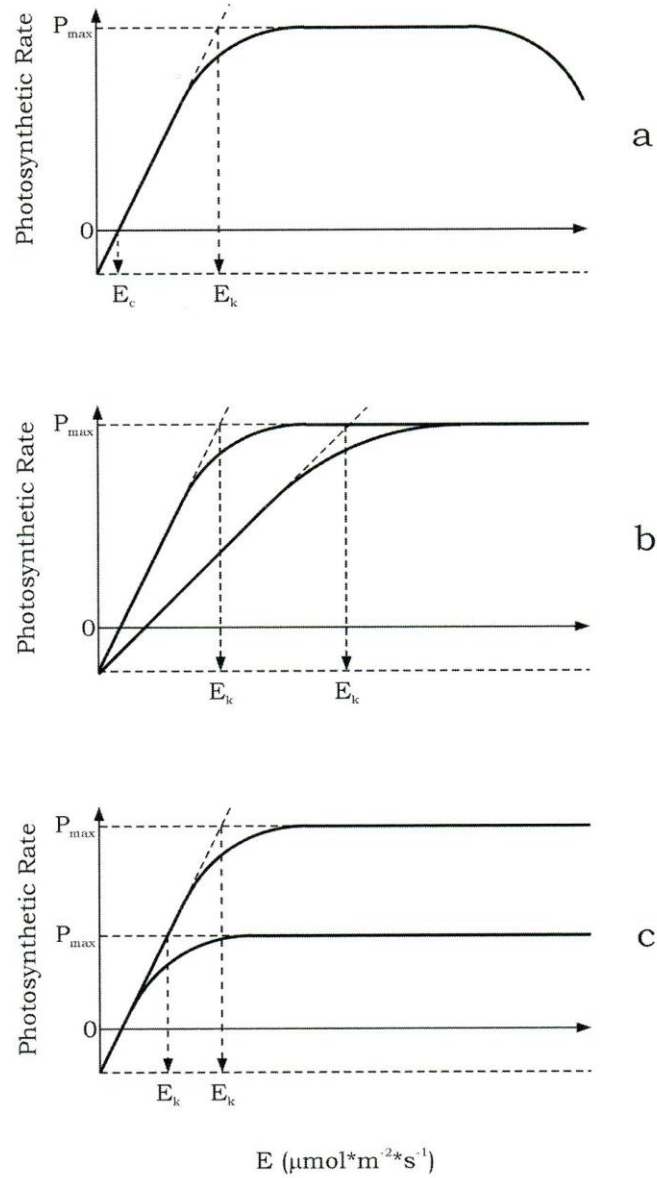


## Diadinoxanthin cycle





# Photosynthesis – Irradiance response curve ( $P$ vs. $E$ curve)



**FIGURE 5.15** Photosynthesis–irradiance response curves:  $E_c$ , irradiance compensation point;  $E_k$ , saturating irradiance; and  $P_{\text{max}}$ , maximum photosynthetic rate. (a) typical plot; (b) comparison of two curves with different slopes: keeping constant the number of photosynthetic units, but increasing the functional absorption cross-section, the slope increases; and (c) comparison of two curves with different maximum photosynthetic rate: increasing the number of photosynthetic units,  $P_{\text{max}}$  increases.

# Measurement of photosynthetic production

## Methods:

- gravimetric / volumetric
- turbidimetric / nephelometric
- fluorometric
- gasometric
  - IRGA; O<sub>2</sub> measurement
- Light response curve
  - $P_n = GP - R$

# Gravimetry / Voluntometry

- Dry weight, fresh weight
- PCV (packed cell volume)
- AFDW (Ash free dry weight)

$$\text{Dry weight mg / L} = \frac{(A - B) \square 1000}{\text{sample volume, mL}}$$

where: A = weight of filter + dried residue, mg  
B = weight of filter, mg

$$\text{AFDW, mg / L} = \frac{(C - D) \square 1000}{\text{sample volume, mL}}$$

- Content of primary compound
  - chl a, Total chl, proteins



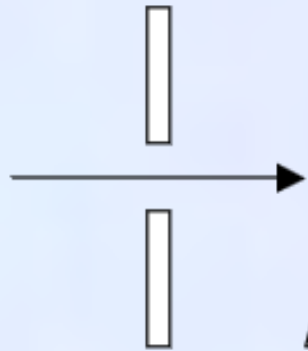
# Turbidimetry / Nephelometry

- Turbidimetry
  - amount of absorbed light *vs.* number & size of particles (cells)
  - spectrophotometers (750, 735, 680nm,..)
- Nephelometry
  - amount of scattered light ( $90^\circ$ ,  $70^\circ$ ,  $37^\circ$ ) *vs.* number & size of particles (cells)
  - amount of scattered light is far greater than the transmitted light >> offers higher sensitivity than turbidimetry

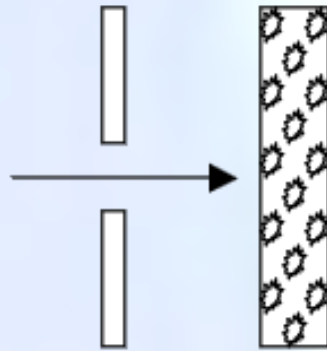
### Schematic diagram of a turbidimeter



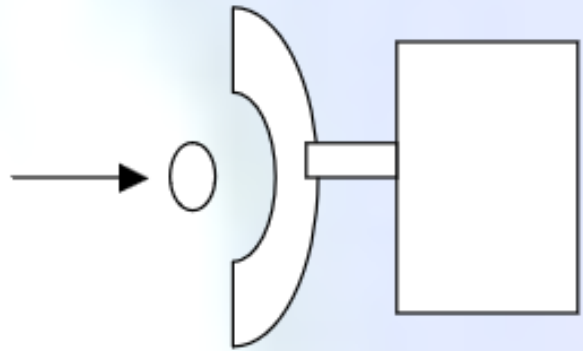
Light source



monochromator



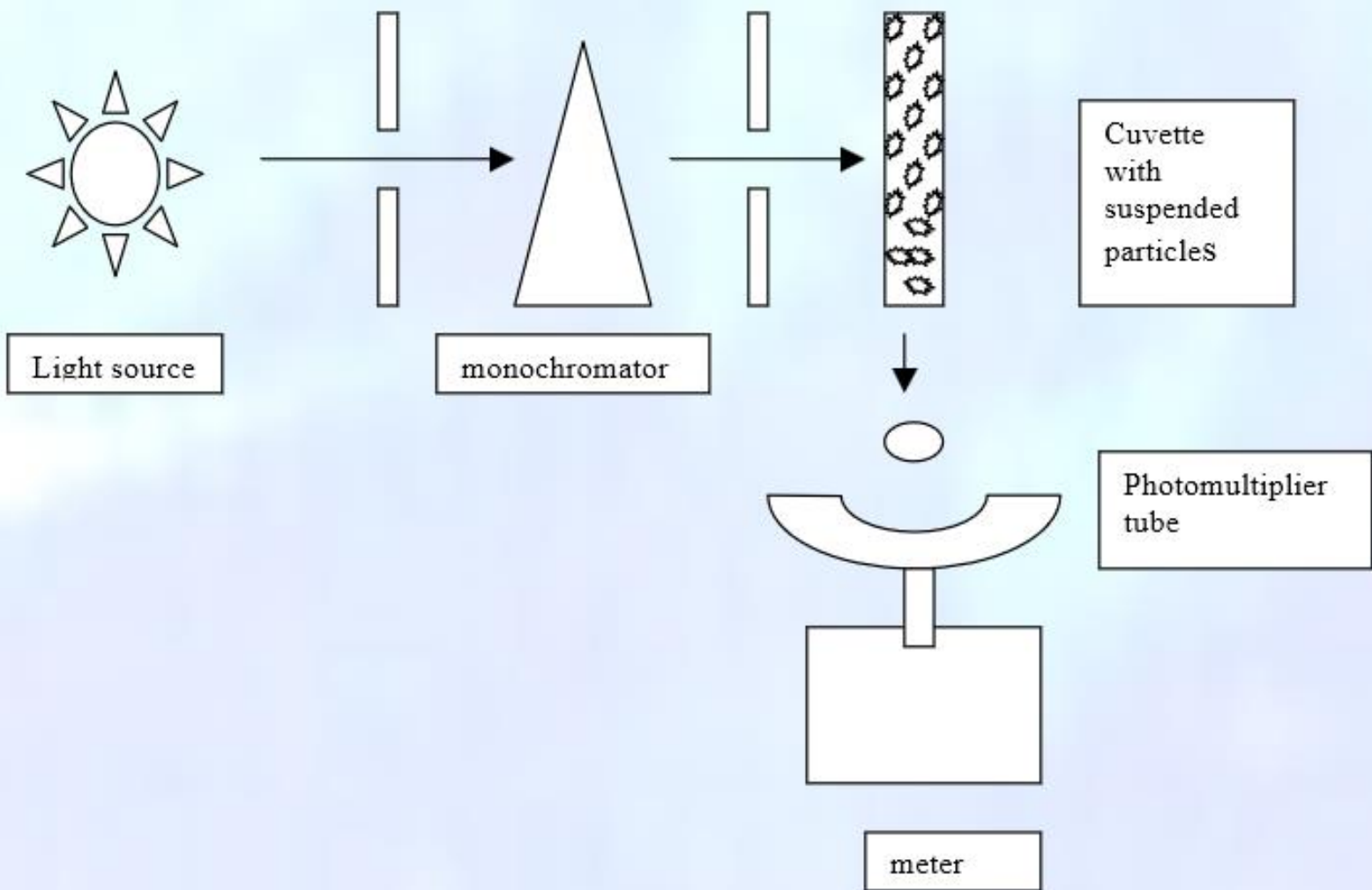
Cuvette  
with  
suspended  
particles



Photomultiplier  
tube

meter

# Schematic diagram of a nephelometer



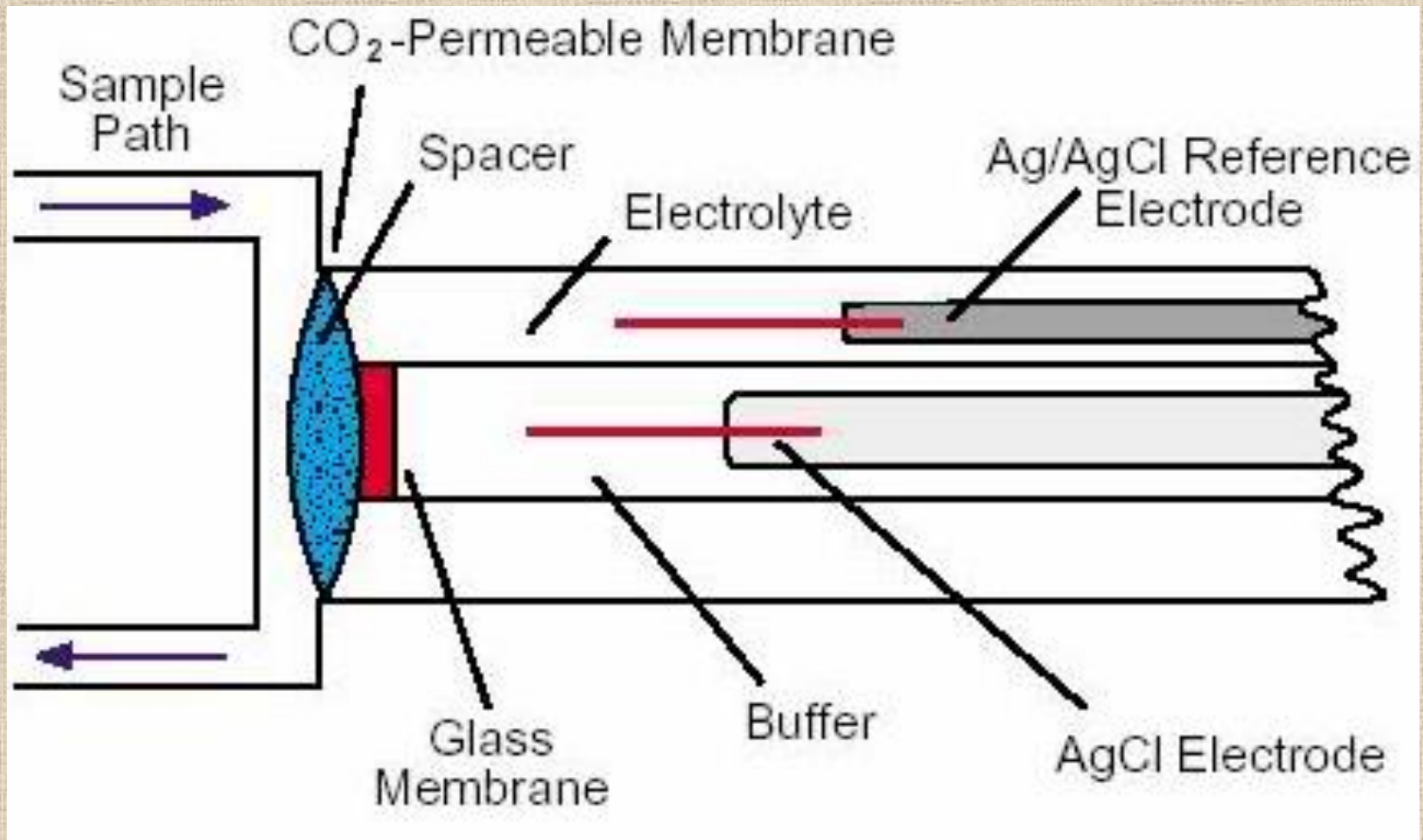
# Turbidimetry & Nephelometry

- blank
- selection of wavelength (750, 735, 680nm,..)
- standard curves must be plotted
  - similar cell size
- precipitation and settlement may occur
  - mix the sample well prior to measurement
  - keep the timing
- Kinetic reaction
  - provides additional information

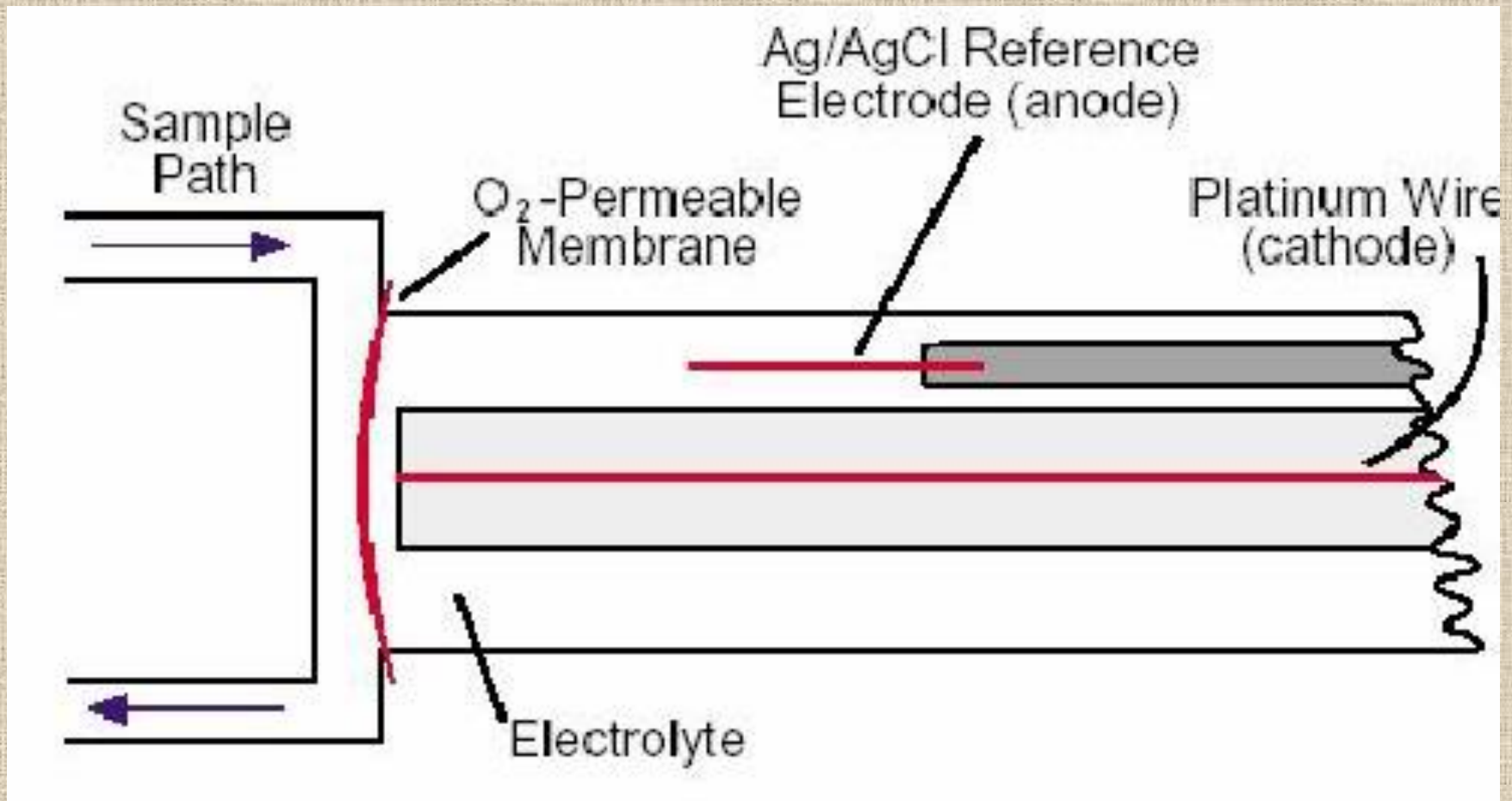
# Gasometry

- Manometry, Formation of titratable compounds ( $\text{NO} \rightarrow \text{NO}_2$ )
- measure  $\text{CO}_2$ ,  $\text{O}_2$
- IRGA cuvette
  - aerophytic algae, soil crusts
  - water vapor
- $\text{CO}_2$  electrode,  $\text{O}_2$  electrode, optode
  - Fast & sensitive, dimension vary
  - Cathode vs. background consumption !!
    - » Membrane type – Clark
    - » Bare type –  $\text{ZrO}_2$
  - Optode – luminescence quenching

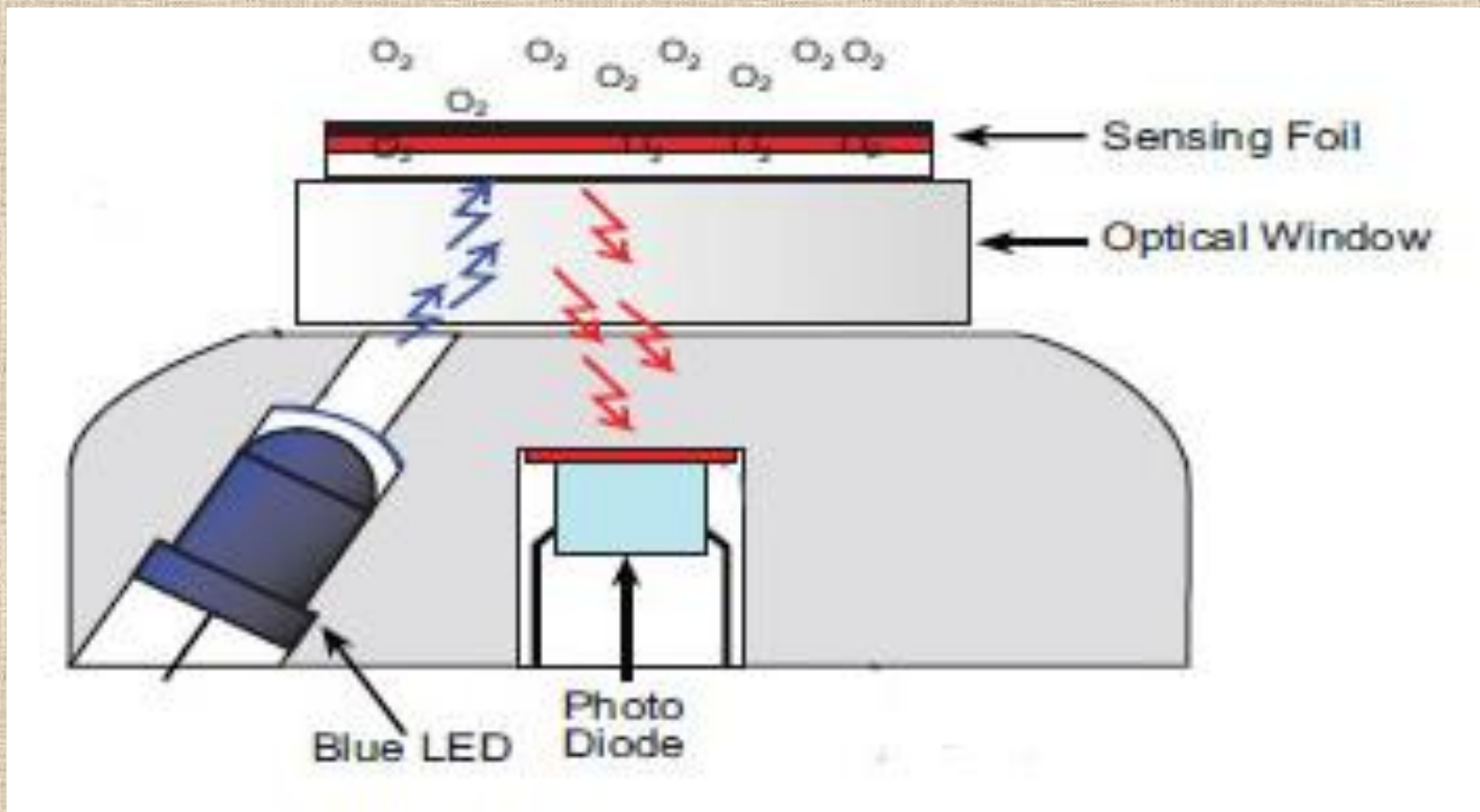
# Carbon dioxide electrode



# Clark type oxygen electrode



# Oxygen optode

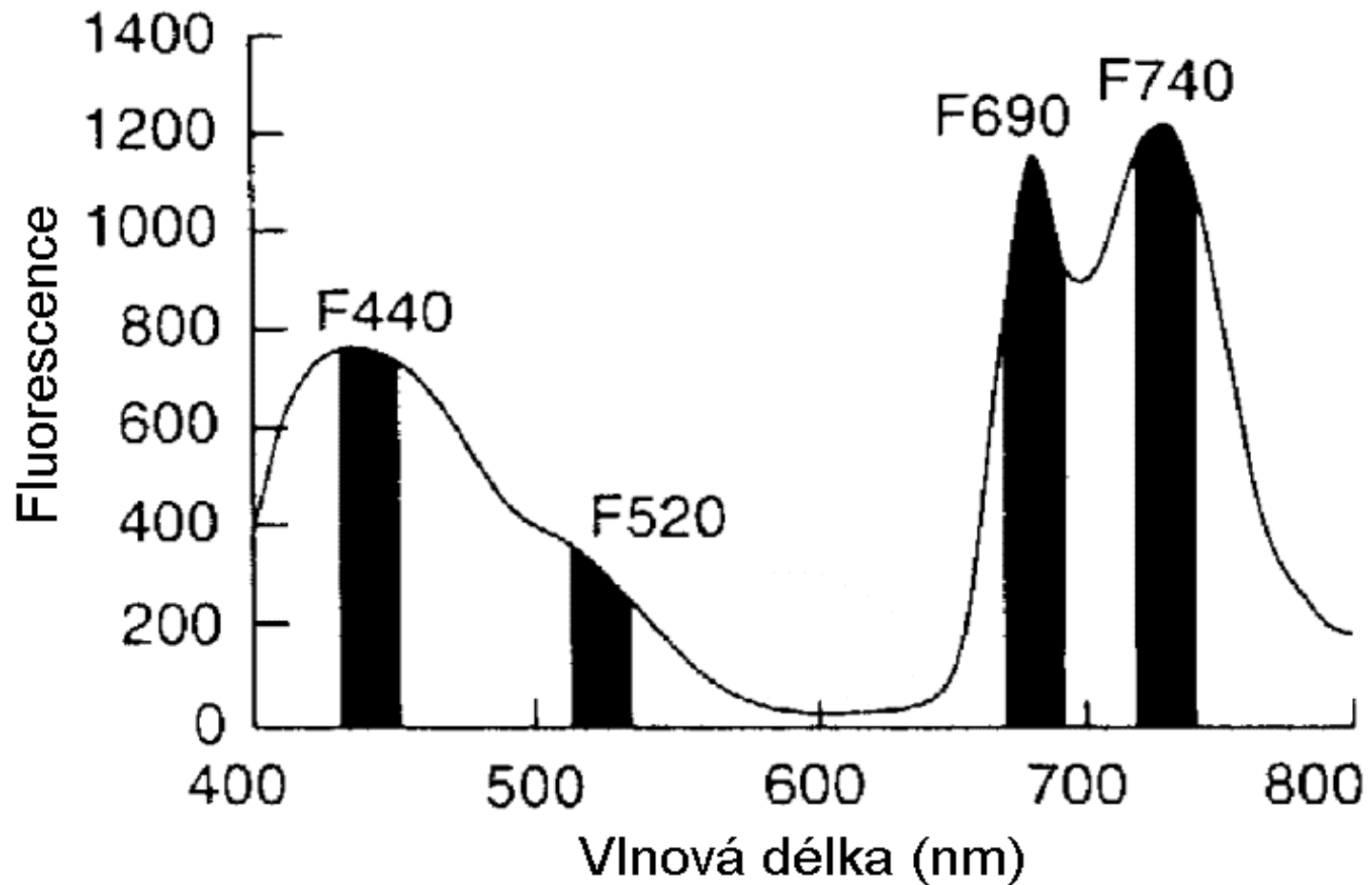




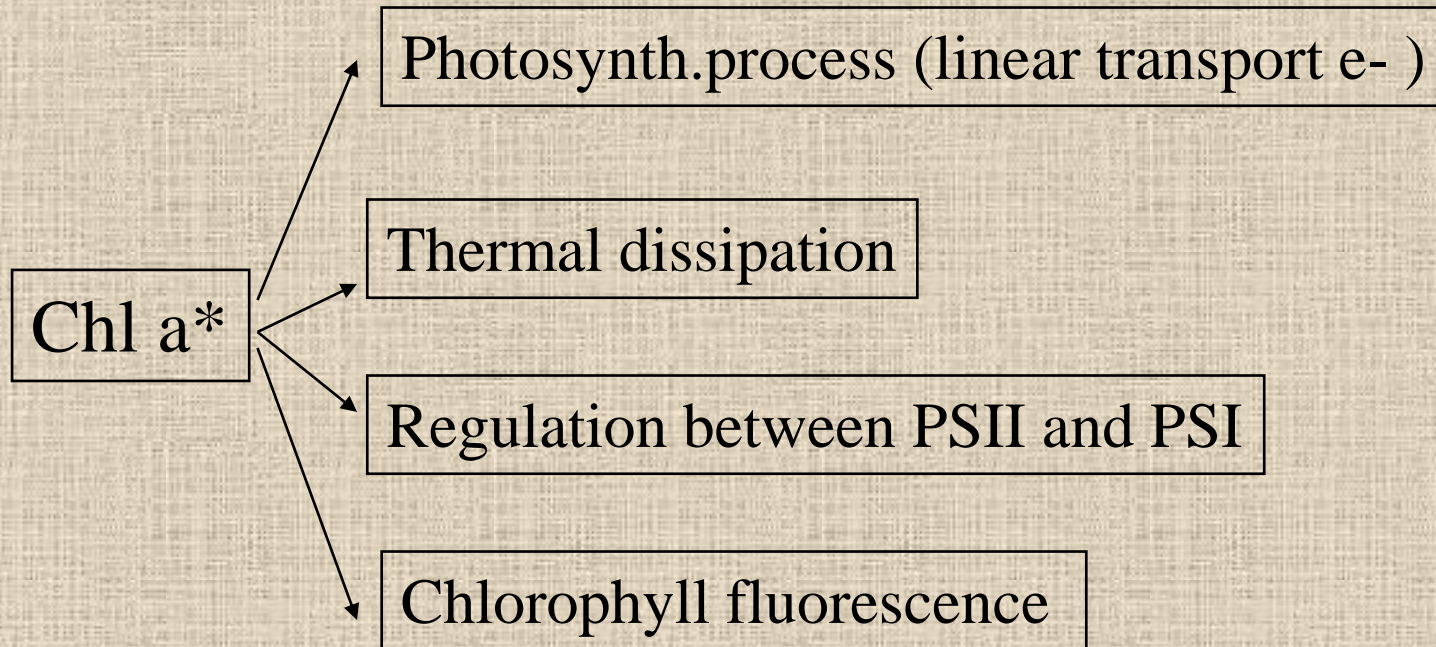
# Chlorophyll fluorescence

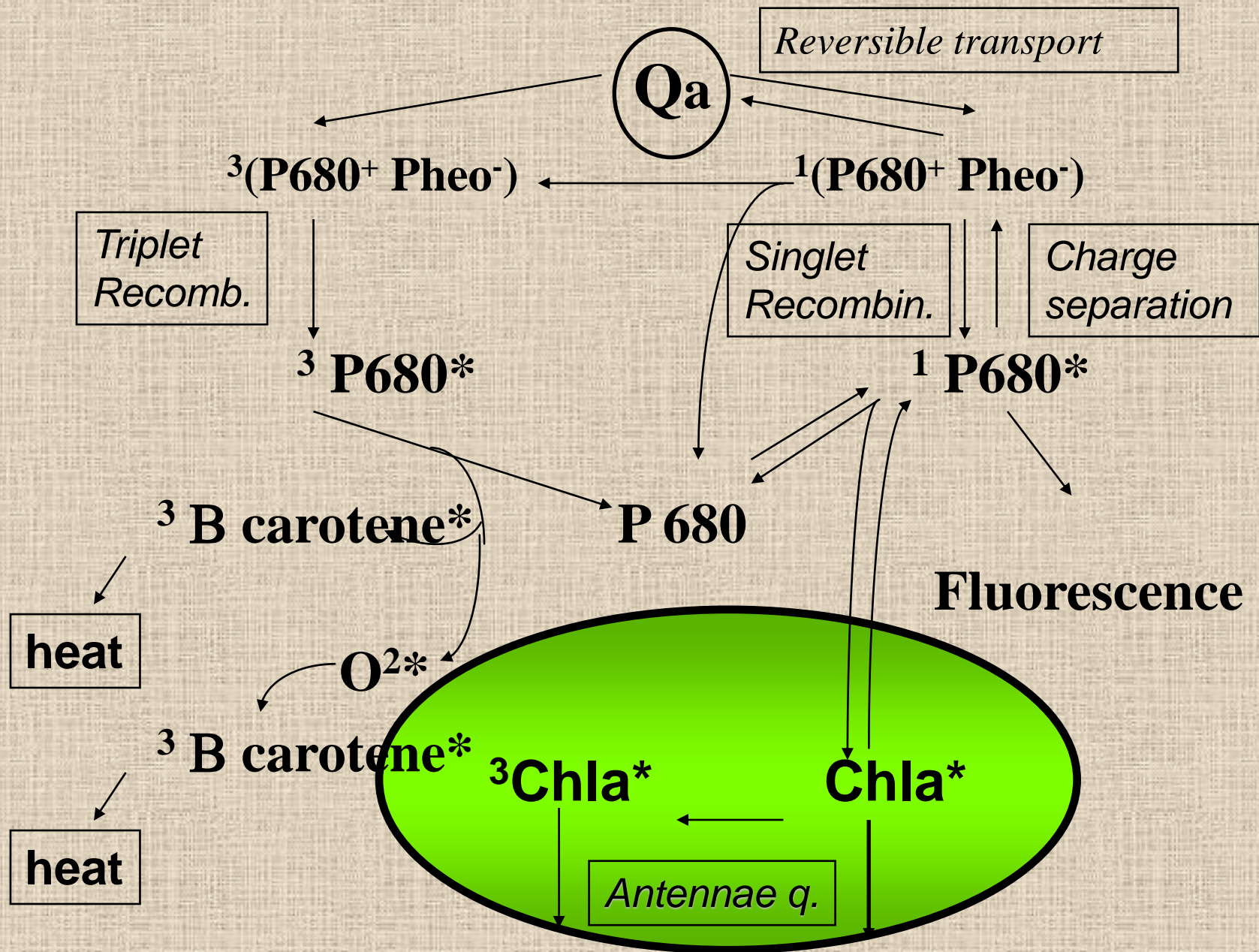
- What is chlorophyll fluorescence?
- Basic methods of Chl fluorescence measurements
- Signals, kinetics of Chl fluorescence
  - fast Chl fluorescence kinetics (parameters)
  - slow Chl fluorescence kinetics (parameters)
  - saturation pulse method, quenching analysis
- Chl fluorescence imaging

# Fluorescence emission



# Basic de-excitation mechanisms of Chl *a*

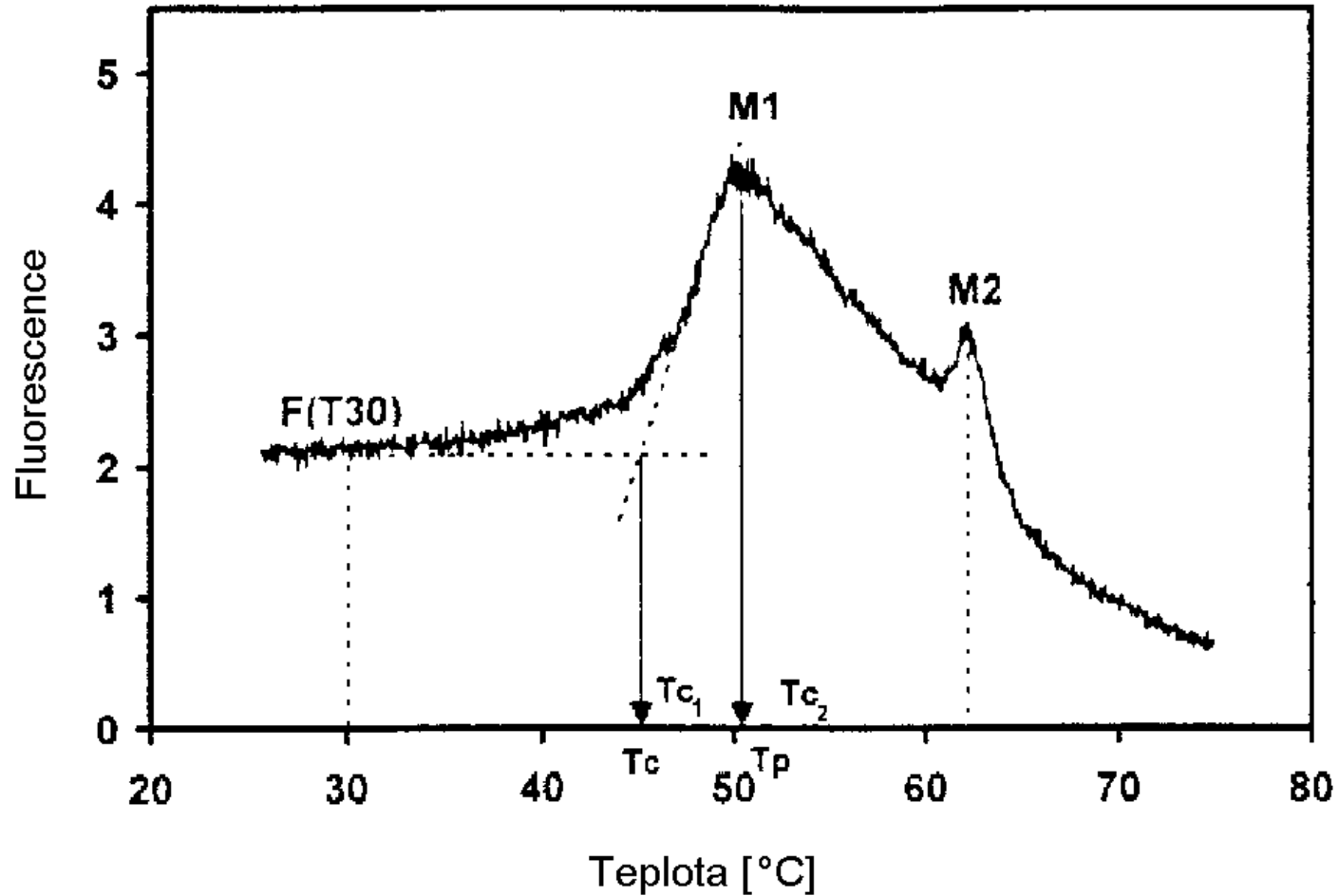




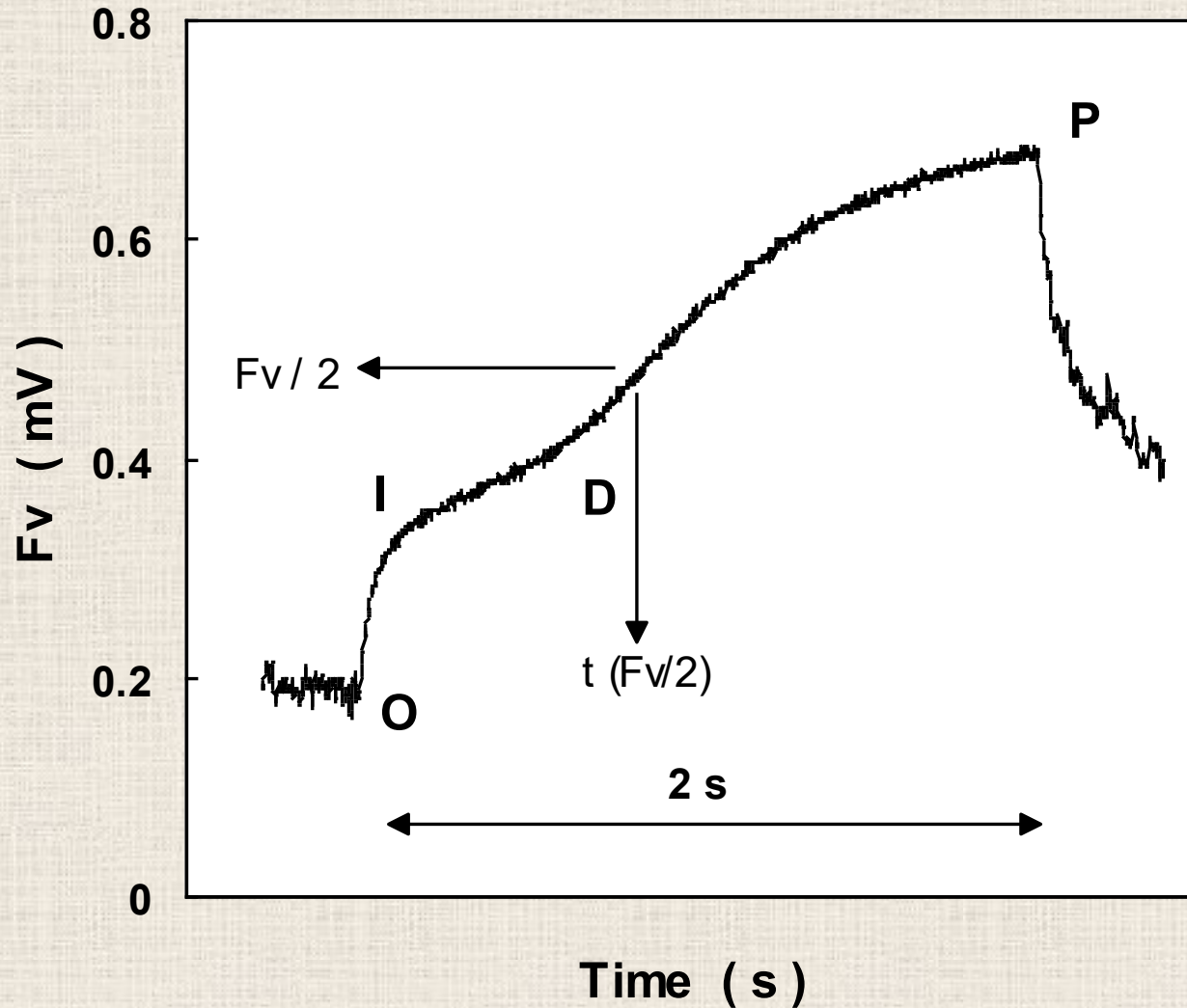
# Chlorophyll fluorescence techniques

- Chl fluorescence signal
- Saturation pulse method
- Chl fluorescence kinetics (transients)
- Quenching analysis
- Rapid light/response curves
- Emission/absorption spectra
- Chl fluorescence imaging

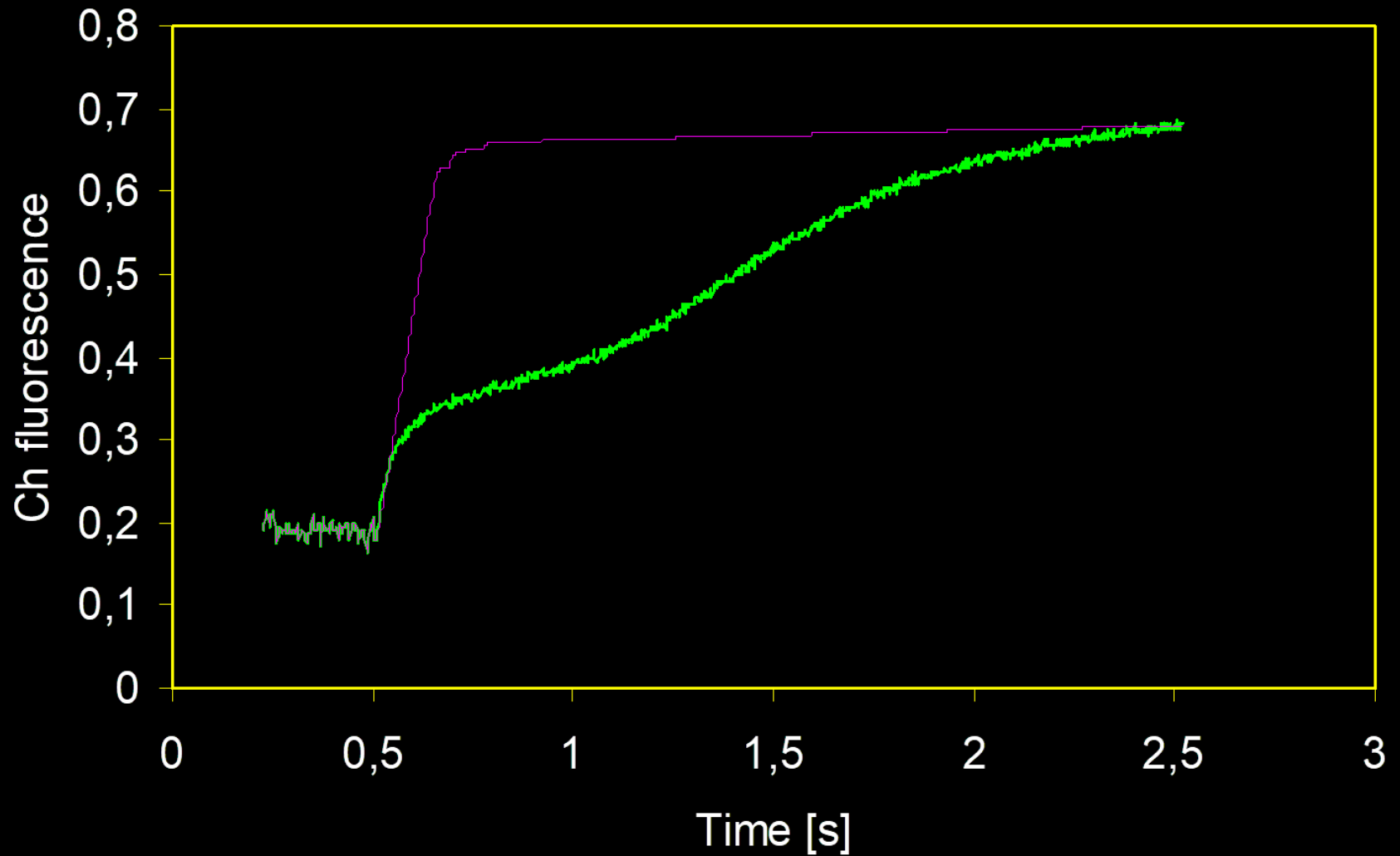
# Temperature response curve



# Fast Chl f. induction curve

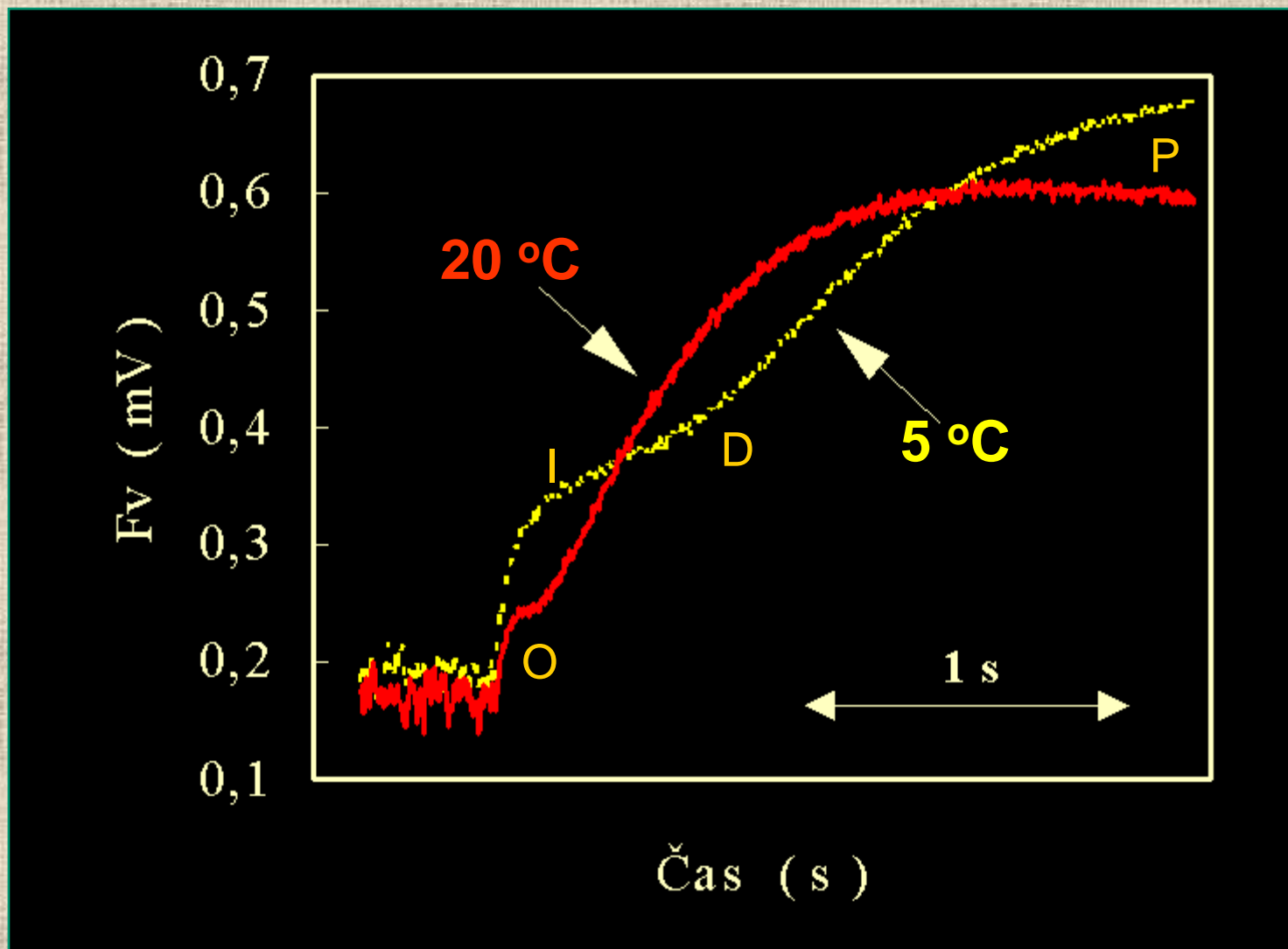


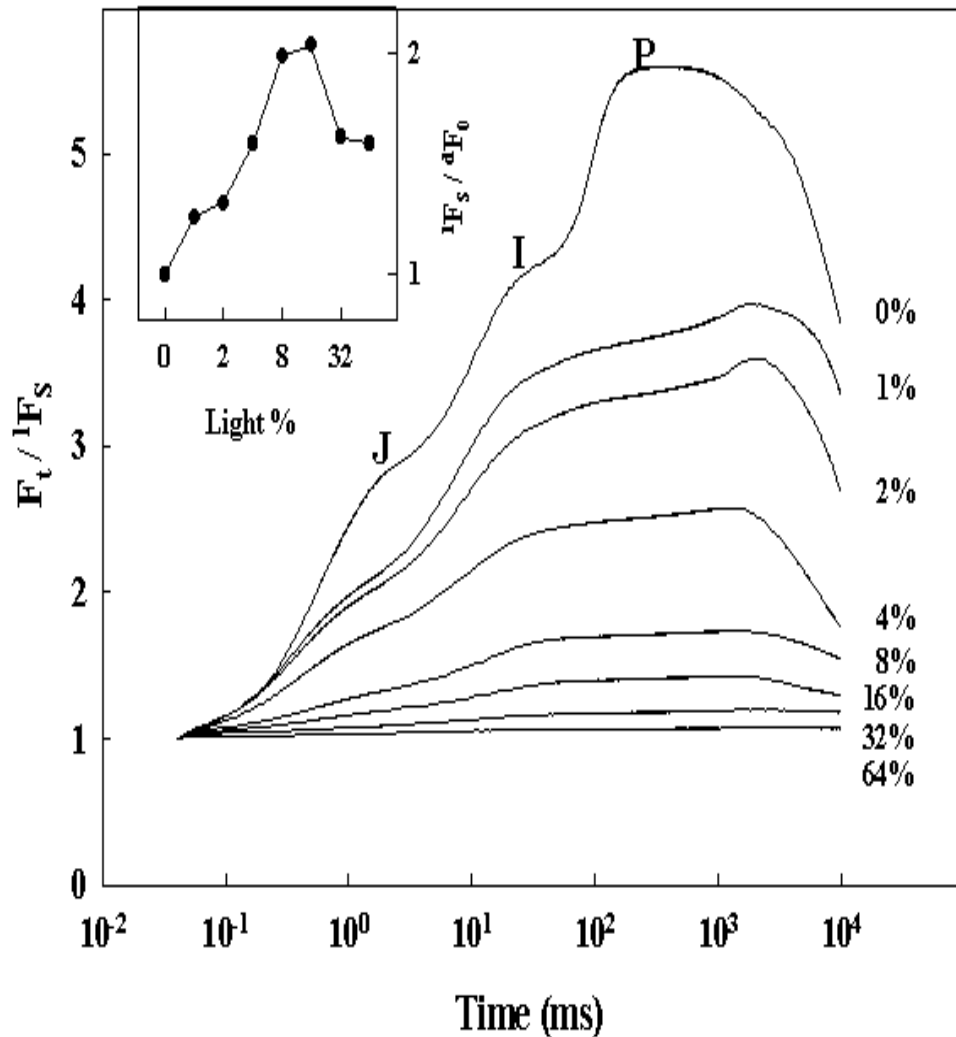
# DCMU effect on fast kinetics





# Effect of temperature on fast kinetics





OJIP taken after dark adaptation

OJIP taken after % light pretreatment (1-64 %)

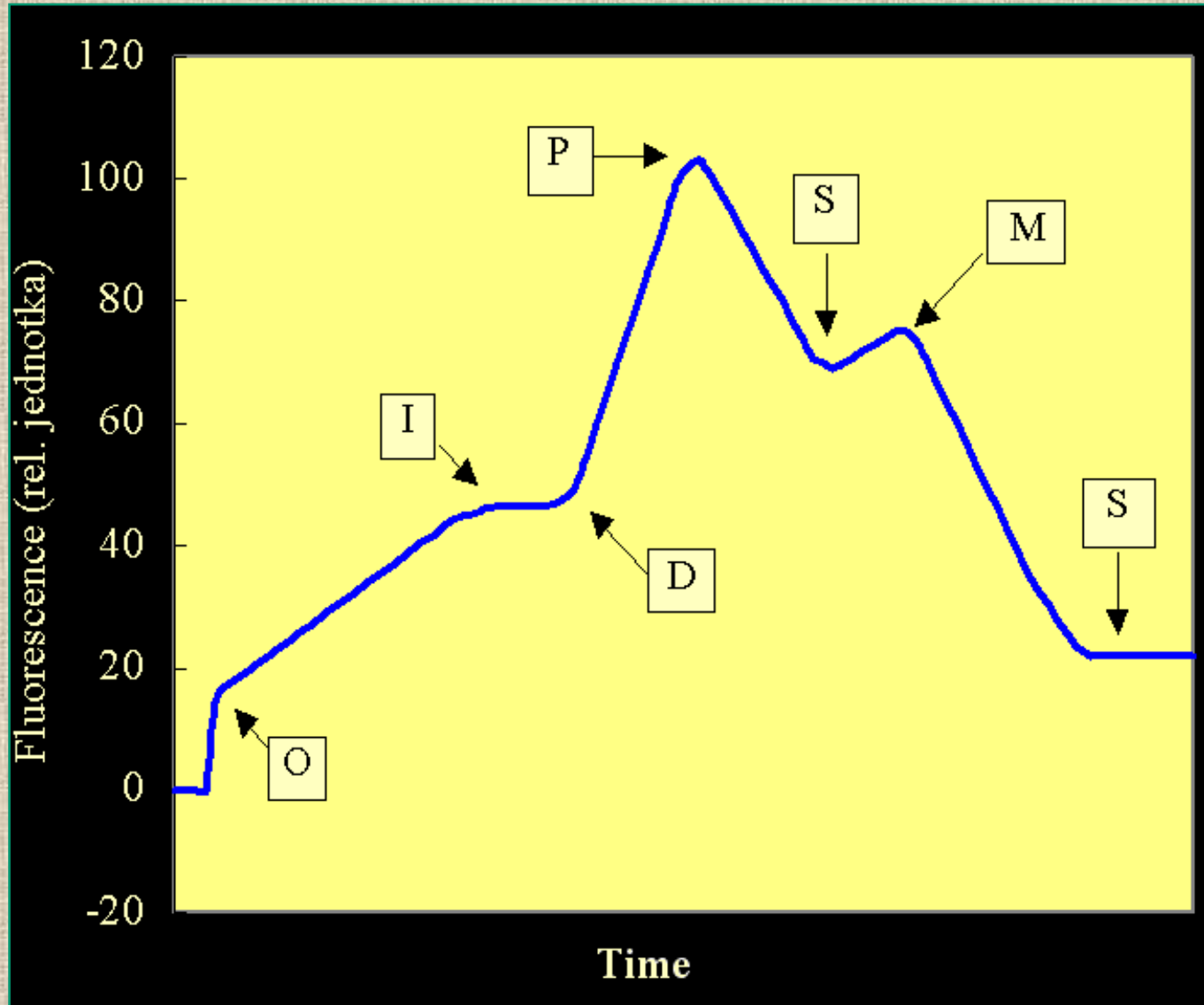
Fast Chl transient [R. Strasser]

# Parameters derived from fast kinetics

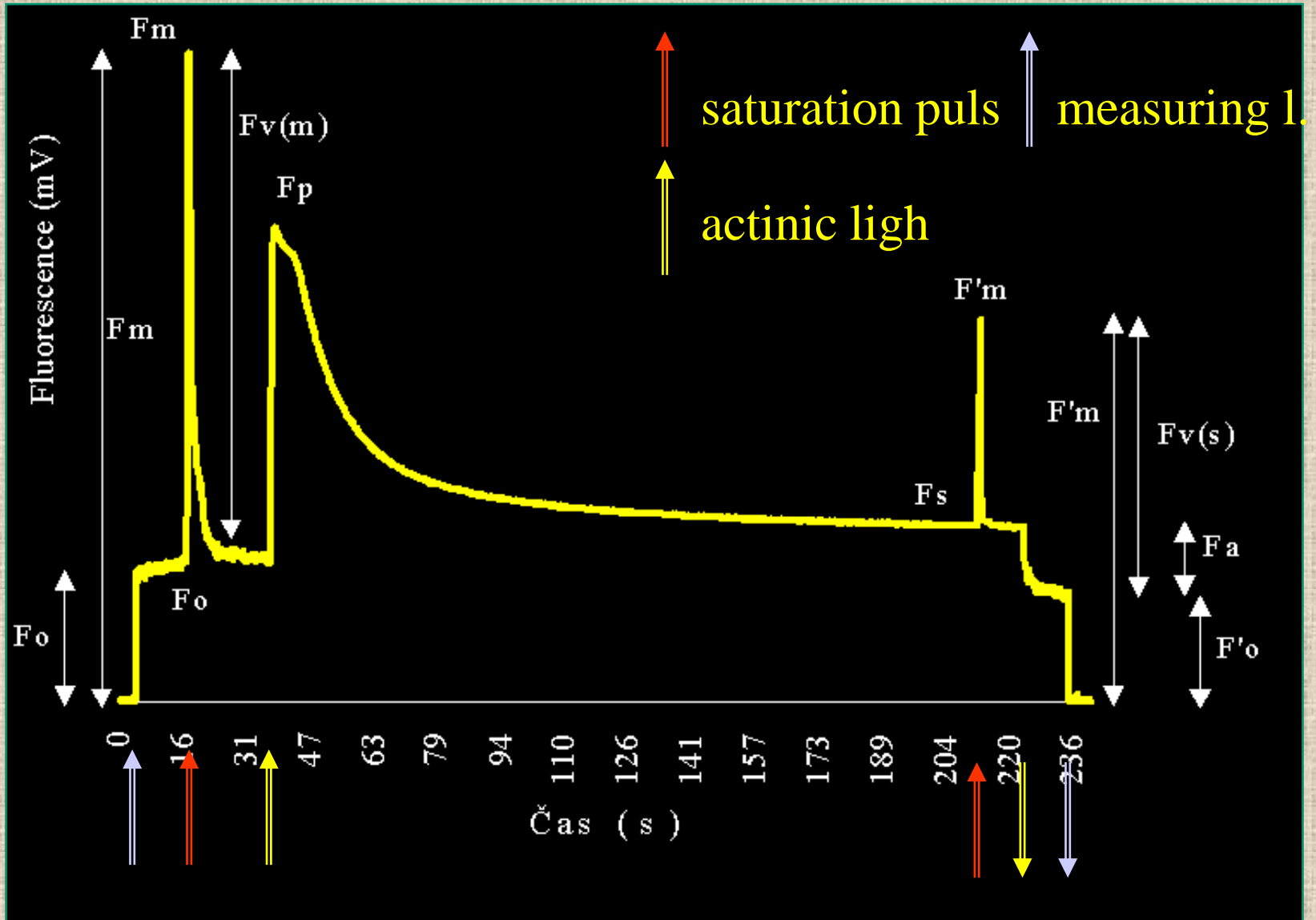
- Signals at O, I, D P points, O(K)JIP
- Ratios  $F_o/F_m$   $F_v/F_m$
- Half-times
- Rates of Chl fluorescence increase
- Area over rising part of curve
- Estimation of Active / inactive RC (Qb-reducing)

Parameters are related to structure and function of photosystem II

# Slow Chl fluorescence kinetics (log)



# Slow kinetics of Chl fluorescence +SP



# Parameters derived from slow kinetics

- $F_v / F_m$  (*“potential” photochemistry*)
- Yield PS II ( $\Phi_{II}$ ) (*“actual” photochemistry*)
- $R_{df}$  (*“vitality”*)
  
- Photochemical, non-photochemical quenching
  - $q_P$ ,  $q_N$ , NPQ,  $q_{Prel}$ ,  $q_{Nrel}$ ,  $q_{Fo}$
  - Components of  $q_N$ :  $q_E$ ,  $q_T$ ,  $q_I$

Parameters are related to whole photochemistry of photosynthesis

# Rapid light reponse curves

- Actinic light (AL) is step-increased after 30 sec.
- At each AL level, saturation pulse is applied
- For each AL level, Yield of PS II is calculated
- $P_n = (\text{Yield} * \text{PAR} * \text{abs} * 0.5) / c$        $c = 8-14$
- Light reponse curves of  $P_n$

# Chlorophyll fluorescence imaging

- Variable Chl fluorescence
  - Amount of Chl, mechanical load
  - Growing/active zones on crusts
- Chl fluorescence parameters
  - Stress (HL, heavy metals...*etc*)
  - Water status



# Schematic diagram of CCD camera

