

# O<sub>2</sub> Measurement Guide

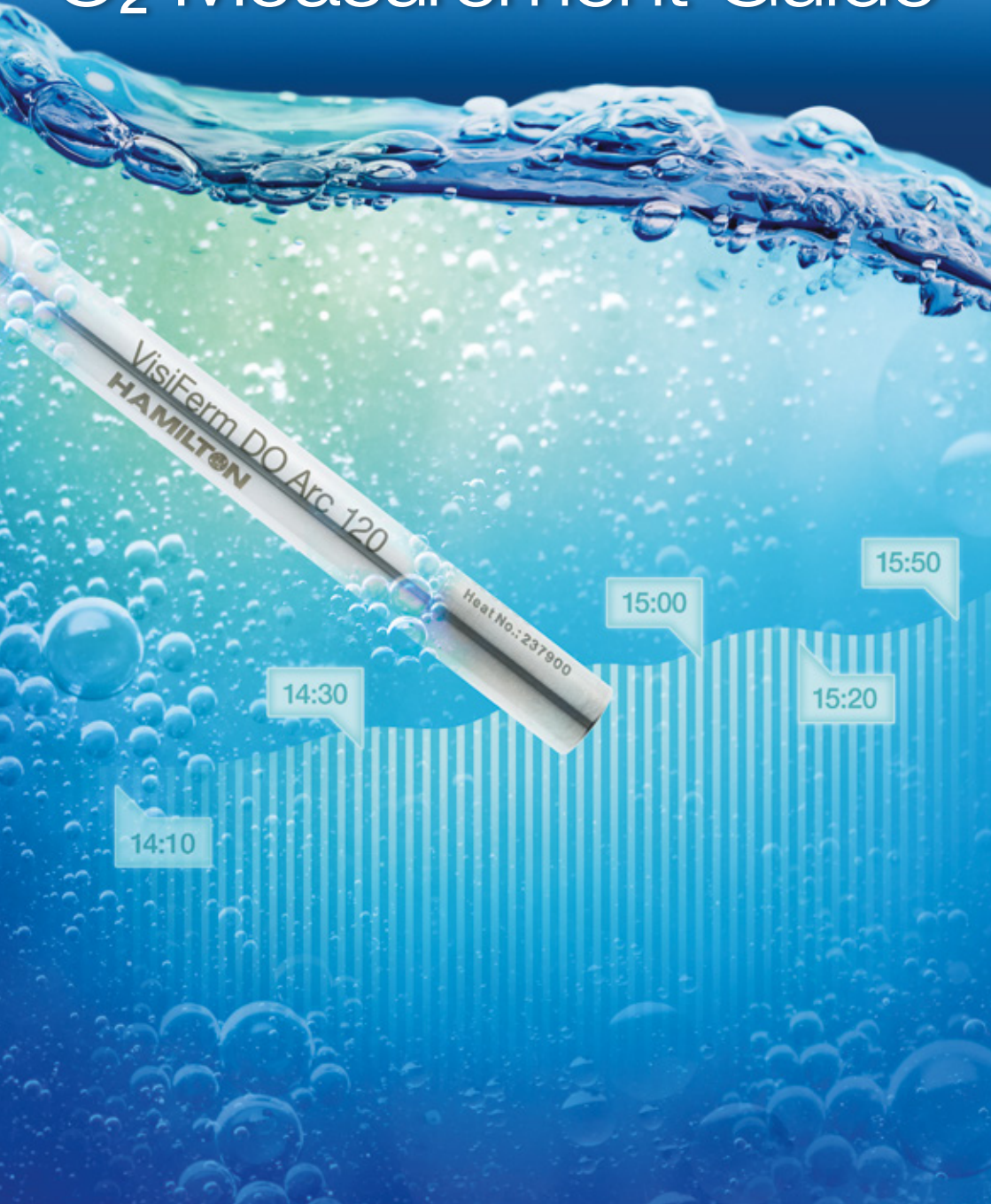

VisiFerm DO Arc 120  
HAMILTON

Heat No.: 237900

14:10

14:30

15:00

15:20

15:50

# Table of Contents

<b>1</b>	<b>Introduction .....</b>	<b>4</b>
1.1	Booklet Overview .....	5
<b>2</b>	<b>Oxygen .....</b>	<b>6</b>
2.1	The Importance of Oxygen .....	6
2.2	Properties of Oxygen .....	7
<b>3</b>	<b>Atmospheric Pressure.....</b>	<b>10</b>
3.1	What is Atmospheric Pressure?.....	10
3.2	Composition of the Atmosphere.....	11
<b>4</b>	<b>Saturated Vapor Pressure.....</b>	<b>14</b>
<b>5</b>	<b>Partial Pressure.....</b>	<b>16</b>
5.1	Absolute Pressure.....	17
<b>6</b>	<b>Oxygen Concentration in Aqueous Solutions .....</b>	<b>18</b>
6.1	Moist Air vs. Dry Air.....	19
6.2	Henry's Law .....	20
6.3	Oxygen Saturation Index .....	22
<b>7</b>	<b>Polarographic Measurement and the Clark Cell.....</b>	<b>23</b>
7.1	Principles of Polarographic Measurement.....	23
7.2	The Membrane-Covered Clark Dissolved Oxygen Sensor .....	26
7.3	Signal Measurement .....	28
<b>8</b>	<b>Optical Dissolved Oxygen Sensors .....</b>	<b>30</b>
8.1	Principles of Optical DO Sensor Operation .....	31
8.1.1	Fluorescence Quenching and Phase Shift .....	31
8.1.2	The Stern-Volmer Equation.....	32
8.1.3	Optical DO Sensor Components.....	33
8.1.4	Compensation .....	35
8.1.5	VisiFerm® ECS.....	36
8.1.6	VisiFerm® RS-485 .....	36
8.2	Optical vs. Polarographic DO Sensors: A Side-by-Side Comparison .....	37
8.2.1	A Note on Device Costs.....	37



<b>9</b>	<b>Calibration.....</b>	<b>38</b>
9.1	Sensor Zero Calibration .....	38
9.2	Sensor Slope Calibration .....	39
9.2.1	Calibration in Water.....	39
9.2.2	Calibration in Air.....	39
<b>10</b>	<b>DO Sensors and their Applications .....</b>	<b>42</b>
10.1	Biopharma .....	42
10.2	Brewing and Beverage Manufacturing .....	44
10.3	Water Treatment, Fish Farming, and Environmental Monitoring.....	45
10.4	Power Generation .....	46
<b>11</b>	<b>Care and Maintenance of Oxygen Sensors.....</b>	<b>47</b>
11.1	Optical Oxygen Sensor Maintenance .....	47
11.2	Polarographic Oxygen Sensor Maintenance .....	49
11.2.1	OxySens .....	49
11.2.2	OxyFerm®.....	49
11.2.3	OxyGold® G & B.....	51
11.3	Storage.....	51
11.4	Cleaning the Sensor.....	51
<b>12</b>	<b>Connecting the DO Sensor .....</b>	<b>52</b>
12.1	Connecting Polarographic DO Sensors .....	52
12.1.1	T82 / D4 .....	52
12.1.2	VP (VarioPin) .....	53
12.2	Connecting Optical DO Sensors.....	53
12.2.1	VisiFerm® Arc with Direct Connection to the PCS.....	53
12.2.2	VisiFerm® and VisiTrace® mA with Direct Connection.....	54
12.2.3	VisiFerm® ECS with Third-Leg Power Supply.....	54
<b>13</b>	<b>Appendix.....</b>	<b>55</b>
13.1	The Discovery of Oxygen.....	55
13.1.1	The Phlogiston Theory.....	55
13.1.2	Carl Wilhelm Scheele.....	56
13.1.3	Joseph Priestley .....	58
13.1.4	Antoine-Laurent de Lavoisier.....	59
13.1.5	Pascal's Principle.....	61
13.1.6	Dalton's Law .....	63
13.2	Oxidation and Reduction Reactions .....	64
13.3	DIN Saturated Oxygen Concentration Tables.....	65

# 1 Introduction

Life as we know it would not exist without oxygen in its free, gaseous state. On land, all animal life depends on atmospheric oxygen in a narrow concentration range around 20%. Either too much or too little oxygen in the air can cause injury or death to land animals.

Oxygen dissolves readily in water and is essential to life in rivers, lakes, and oceans. In water ecosystems, the concentration of dissolved oxygen depends on both the concentration of atmospheric oxygen and the temperature. Dissolved oxygen concentration can thus vary from place to place, but each individual species can still survive in only a limited aqueous oxygen concentration range.

It is, therefore, important for scientists to monitor oxygen levels in ecological systems, both in the wild and in the laboratory. Measurement of dissolved oxygen is crucial to other applications as well, such as:

- **Treatment of residential and industrial wastewater by microbes, which require high concentrations of dissolved oxygen to break down organic waste.**
- **Prevention of corrosion in boilers and other industrial systems.**
- **Optimization of chemical reactions for manufacturing products such as household cleaners, industrial chemicals, and fuels.**
- **Increasing yield in cell culture applications for biopharmaceutical drug production.**



## 1.1 Booklet Overview

The purpose of this booklet is to provide basic information about dissolved oxygen (DO) measurement in a brief and understandable form. We cover the following essential topics:

- **The basics of oxygen and its chemical and physical properties.**
- **The physics of dissolved oxygen.**
- **Types of DO sensors and how they work.**
- **Applications, calibration, and maintenance of DO sensors.**

The intended audience for this guide is anyone with an interest in DO sensor technology or anyone who needs to implement DO sensors in controlled environments such as laboratories and industrial plants.

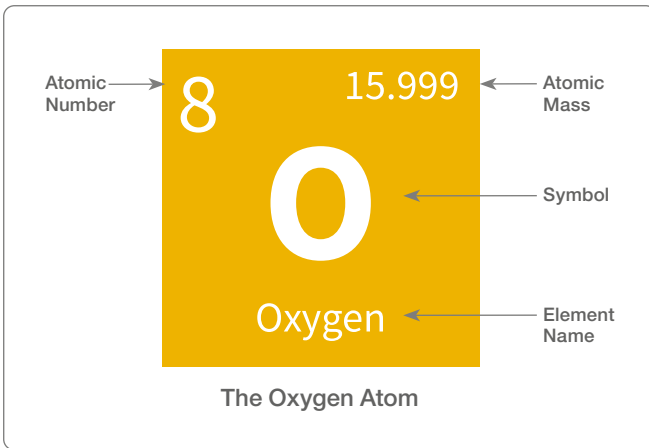

# 2 Oxygen

## 2.1 The Importance of Oxygen

After hydrogen and helium, oxygen is the third most abundant element in the universe. In stars such as our sun, its formation is part of the reaction that provides the star's energy. On planet Earth, oxygen is the most abundant element:

- **85.7% by weight in seawater (88.8% of pure water is oxygen).**
- **46.6% by weight in the earth's crust.**
- **20.95% by volume in the lower atmosphere.**

Compared with the other planets in our solar system, Earth has a remarkable level of oxygen gas in the lower atmosphere. The abundance of oxygen is one of the main reasons our planet supports life as we know it. Oxygen is essential to numerous biological systems and processes; among other things, oxygen is:

- **A key element in the metabolism of nutrients such as carbohydrates, fats, and proteins that are essential for life.**
- **Part of the genetic information in our DNA (deoxyribonucleic acid).**
- **Crucial for biochemical processes such as photosynthesis.**

Oxygen circulates through the ecosystem and the biosphere in various forms. It is free in the air and dissolved in water. Certain lower-order plants and all animals use oxygen to respire and return it to air and water as carbon dioxide (CO<sub>2</sub>). CO<sub>2</sub> is then taken up by algae and terrestrial green plants and converted into carbohydrates during the process of photosynthesis, combining it with water to create sugars and oxygen molecules. Free oxygen is returned to the air, and the cycle starts again. Almost all the free oxygen present in the atmosphere is the result of photosynthesis. The waters of the world are the main sources of atmospheric oxygen; their algae are estimated to replace about 90% of all oxygen used.



## 2.2 Properties of Oxygen

Oxygen is a non-metallic chemical element with the chemical symbol O, atomic number 8, and atomic mass 15.999. Under atmospheric pressure and temperature, oxygen is a colorless, odorless, and tasteless gas.

The Oxygen Atom

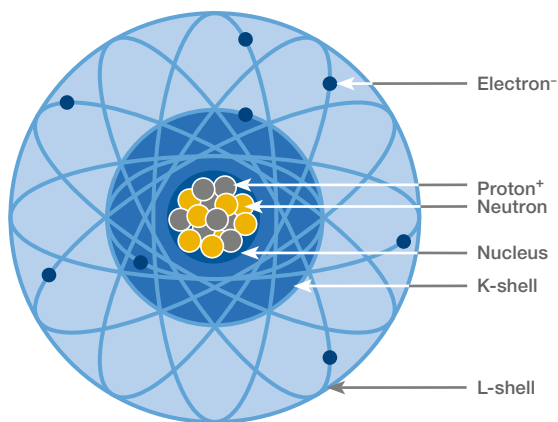

Atomic  
Number

8

15.999

Atomic  
Mass

O

Symbol

Oxygen

Element  
Name

Oxygen has a 2–6 electron configuration with a valence of 2. Because of this property, oxygen does not exist in nature as single atoms; instead, pairs of oxygen atoms combine by forming a double covalent bond that results in the highly stable  $O_2$  molecule.

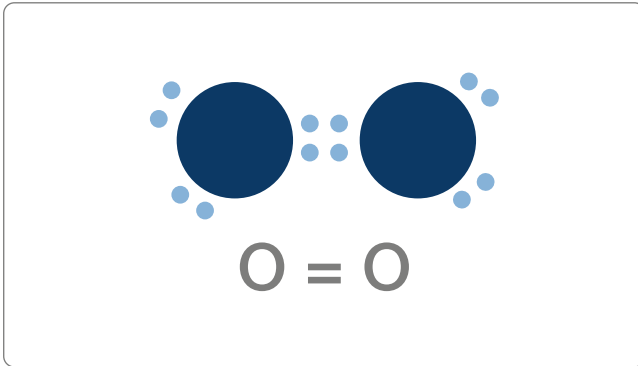

Oxygen's electron configuration also endows it with high reactivity. Oxygen combines with all elements except the noble gases and with most compounds under the influence of elevated energy from heat or light. A chemical reaction with oxygen is called *oxidation*, and the resulting compounds are called *oxides*. The combustion process is a special case of oxidation that features a rapid reaction rate and the release of energy in the form of heat and light.

Another form of elemental oxygen is ozone ( $O_3$ ), which is a triatomic molecule consisting of three oxygen atoms. The ozone molecule is much less stable than the diatomic  $O_2$  and is, therefore, less abundant, but it is still important to life on Earth.



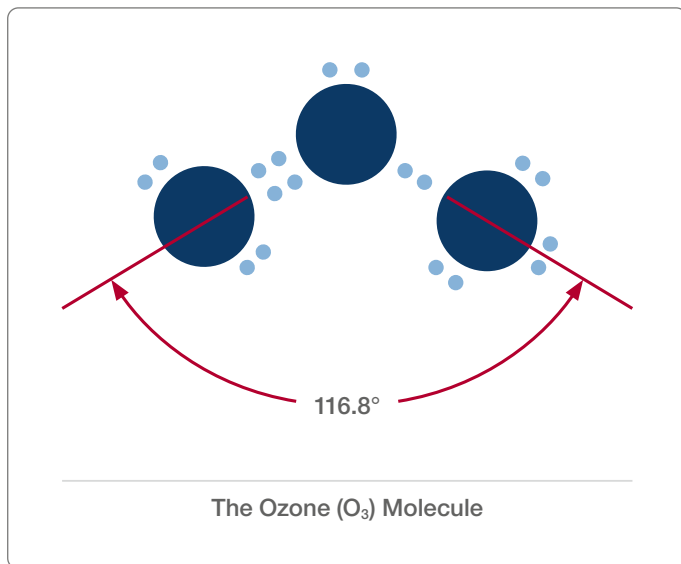

In the upper atmosphere (15 to 45 km), ozone forms a thin, protective layer around the earth that filters potentially damaging ultraviolet light from reaching the Earth's surface. Some pollutants in the atmosphere have a detrimental effect on this ozone layer.

At the same time, however, ozone close to the Earth's surface is toxic, with harmful effects on the respiratory systems of humans and animals. An ozone concentration of more than 125 parts per billion (ppb) is regarded as "unhealthy" by the World Health Organization.

Other properties of oxygen include:

- **Boiling point: -182.97°C (at 1 atm).**
- **Melting point: -218.76°C (at 1 atm).**
- **Critical point: -118.9°C (at 1 atm).**
- **Density: 1.429 g/l (at 1 atm and 0°C).**
- **Pure oxygen is 1.1 times heavier than air.**
- **Liquid oxygen has a strong magnetic property.**
- **Liquid and solid oxygen have a pale blue color.**

## 3 Atmospheric Pressure

Oxygen dissolved in water is gaseous oxygen ( $O_2$ ) and must not be mistaken for the oxygen bound to hydrogen in the water molecule ( $H_2O$ ). The amount of gaseous oxygen that water can dissolve depends on the water temperature, salinity, and the partial pressure of oxygen in the air above the water.

To understand the concept of *partial pressure* (which will be discussed in detail in Chapter 5), it is first necessary to understand the term *atmospheric pressure*.

### 3.1 What is Atmospheric Pressure?

The pressure of the Earth's atmosphere, called the atmospheric pressure, is a force per unit area exerted by a column of air extending to the hypothetical top of the atmosphere. This is the entire body of air above the specific area.

As with any fluid pressure, atmospheric pressure changes with depth; it is higher at sea level than at the top of a high mountain. However, the Earth's atmosphere is somewhat complicated because not only does the density of air vary greatly with altitude, but unlike a body of water, there is no distinct top surface to the atmosphere from which the height of an air column can be measured. However, with the following formula, the approximate difference in pressure between two altitudes can be calculated.

$$\Delta P = \rho g \Delta h \quad (1)$$

$\Delta P$  = the difference in air pressure

$\rho$  = the mean density of the air column

$g$  = the acceleration of gravity

$\Delta h$  = the difference in height

The pressure of the air at a given place varies slightly according to the weather. At sea level, the average atmospheric pressure is  $1.013 \times 10^5$  Newtons per square meter ( $N/m^2$  also known as the unit Pascal or Pa) This value is used to define another unit of pressure in common use, the atmosphere (atm).

Another unit of pressure sometimes used in meteorology and on weather maps is the *bar*, where 1 bar is  $1 \times 10^5$  Pa.

Thus, standard atmospheric pressure is slightly more than 1 bar. Other measures of air pressure are used in various fields, as shown in Table 1.



**Table 1. Conversion Factors Between Different Units of Pressure**

In Terms of 1 Pa = 1 N/m <sup>2</sup>	Related to 1 atm
1 atm = 1.013 x 10 <sup>5</sup> N/m <sup>2</sup> = 1.013 x 10 <sup>5</sup> Pa = 101.3 kPa	1 atm = 1.013 x 10 <sup>5</sup> N/m <sup>2</sup>
1 bar = 1.000 x 10 <sup>5</sup> N/m <sup>2</sup>	1 atm = 1.013 bar
1 dyne/cm <sup>2</sup> = 0.1 N/m <sup>2</sup>	1 atm = 1.013 x 10 <sup>6</sup> dyne/cm <sup>2</sup>
1 lb/in <sup>2</sup> = 6.90 x 10 <sup>3</sup> N/m <sup>2</sup>	1 atm = 14.7 lb/in <sup>2</sup>
1 lb/ft <sup>2</sup> = 47.9 N/m <sup>2</sup>	1 atm = 2.12 x 10 <sup>3</sup> lb/ft <sup>2</sup>
1 cm-Hg = 1.33 x 10 <sup>3</sup> N/m <sup>2</sup>	1 atm = 76 cm-Hg
1 mm-Hg = 133 N/m <sup>2</sup>	1 atm = 760 mm-Hg
1 torr = 133 N/m <sup>2</sup>	1 atm = 760 torr
1 mm-H <sub>2</sub> O (4°C) = 9.81 N/m <sup>2</sup>	1 atm = 1.03 x 10 <sup>4</sup> mm-H <sub>2</sub> O (4°C)

## 3.2 Composition of the Atmosphere

The air in the atmosphere is a mixture of gases, water vapor, and minute solids and liquid particles in suspension. The bulk of the lower atmosphere (0 to 100 km) is composed mainly of N<sub>2</sub> and O<sub>2</sub>, with a relative abundance of 0.78 N<sub>2</sub> and 0.21 O<sub>2</sub>, based on the average number of molecules present in a representative volume of air.

The mass of a hypothetical mean molecule of air of the lower atmosphere is 28.97 grams per mole. This value is intermediate between that of N<sub>2</sub> (28) and that of O<sub>2</sub> (32). The value reflects the presence of trace quantities of water, argon, carbon dioxide, and other less abundant compounds that form the mixture of air (see Table 2 on next page).

**Table 2. Composition of the Atmosphere**

Species		Relative Abundance (ppb by volume)*	Source
N <sub>2</sub>	Nitrogen	7.81 x 10 <sup>8</sup>	Biologic
O <sub>2</sub>	Oxygen	2.09 x 10 <sup>8</sup>	Biologic
H <sub>2</sub> O	Water	10 <sup>6</sup> x 10 <sup>7</sup>	Physical
Ar	Argon	9.34 x 10 <sup>6</sup>	Radiogenic
CO <sub>2</sub>	Carbon Dioxide	3.5 x 10 <sup>5</sup>	Biologic/Industrial
Ne	Neon	1.8 x 10 <sup>4</sup>	Interior
He	Helium	5.2 x 10 <sup>3</sup>	Radiogenic
CH <sub>4</sub>	Methane	1.6 x 10 <sup>3</sup>	Biologic
Kr	Krypton	1.0 x 10 <sup>3</sup>	Interior
H <sub>2</sub>	Hydrogen	5.0 x 10 <sup>2</sup>	Biologic/Photochem.
N <sub>2</sub> O	Nitrous Oxide	3.0 x 10 <sup>2</sup>	Biologic/Industrial
CO	Carbon Monoxide	1.0 x 10 <sup>2</sup>	Photochem./ Industrial
SO <sub>2</sub>	Sulphur Dioxide	< 10 <sup>2</sup>	Industrial/Photochem.
O <sub>3</sub>	Ozone	< 10 <sup>2</sup>	Photochem.
Xe	Xenon	9 x 10 <sup>1</sup>	Interior
NO	Nitric Oxide	Variable	Industrial/Biologic
NO <sub>2</sub>	Nitrogen Dioxide	Variable	Industrial/Biologic
NO <sub>x</sub>	Nitrous Gases	Variable	Industrial/Biologic
CH <sub>3</sub> Cl	Methyl Chloride	6.0 x 10 <sup>-1</sup>	Biologic
CCl <sub>2</sub> F <sub>2</sub>	Halogenated Methane	2.9 x 10 <sup>-1</sup>	Industrial
CCl <sub>3</sub> F	Halogenated Methane	1.7 x 10 <sup>-1</sup>	Industrial
CCl <sub>4</sub>	Carbon Tetrachloride	1.2 x 10 <sup>-1</sup>	Industrial
CH <sub>3</sub> CCl <sub>3</sub>	Methyl Chloroform	9.8 x 10 <sup>-2</sup>	Industrial
CF <sub>4</sub>	Carbon Fluoride	7.0 x 10 <sup>-2</sup>	Industrial
CH <sub>3</sub> Br	Methyl Bromide	1.0 x 10 <sup>-2</sup>	Biologic/Industrial

\* ppb = part per billion.



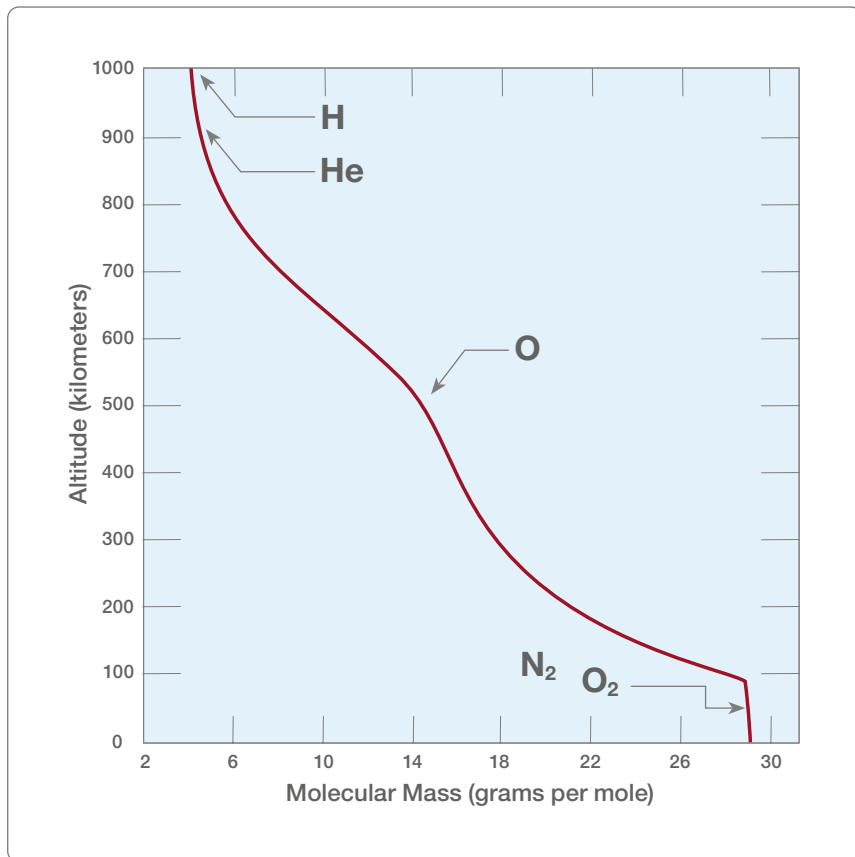

Figure 1. Average molecular mass of the atmosphere in atomic units.

The composition of the atmosphere is measured by its mean density (the average mass per unit volume). As it can be seen from Figure 1, the mean density of air (28.97 g/mol) does not change significantly from the earth's surface to a height of about 100 km. Thereafter it declines gradually down to less than 3 g/mol at a height of 1000 km.

The approximate uniformity in the first 100 km of height above the Earth's surface results from molecular motion and the high frequency with which molecules of a particular species are involved in collisions with their neighbors. For instance, an  $O_2$  molecule encounters an  $N_2$  molecule on average once every  $10^{-9}$  seconds near the Earth's surface. At 100 km altitude, the encounter time is reduced to about  $10^{-3}$  seconds. Because of their molecular masses, molecules experience the force of gravity. Heavy gases are attracted more closely to the Earth's surface, whereas lighter gases are free to float higher. Oxygen gives way to helium above 600 km, and hydrogen is the major constituent at altitudes higher than 1000 km.

## 4 Saturated Vapor Pressure

Air normally contains gaseous water, or *water vapor*, whose main source is *evaporation*. The process of evaporation can be explained on the basis of kinetic theory. The molecules in a liquid move past one another at different speeds. There are strong attractive forces between these molecules, keeping them together in the liquid phase. A molecule near the surface of the liquid may, because of its speed, leave the liquid momentarily. The combined attractive force of the other molecules can pull the escaping molecule back to the liquid surface if the velocity of this molecule is not too great. However, a molecule with a sufficiently high velocity (and therefore sufficient kinetic energy) will escape the liquid entirely into the gas phase.

Some proportion of liquid molecules have kinetic energy above a particular value that enables them to escape into the gas phase. This proportion increases with temperature.

In a closed glass vessel filled partly with water (or any other liquid) and from which the air has been removed, the fastest moving molecules evaporate into the space above. As they move around, some of these molecules strike the liquid surface and again become part of the liquid phase; this is one form of condensation.

From the initial state of no water vapor in the vessel, the number of molecules in the vapor (gas) phase increases for a period of time, until the number returning to the liquid equals the number leaving in the same time interval. At this state of equilibrium, the vapor is said to be saturated. The pressure of the vapor when it is saturated above the liquid surface is called the saturated vapor pressure.

The value of the saturated vapor pressure does not depend on the volume of the container. If the volume above the liquid were suddenly reduced, the density of molecules in the vapor phase would increase for a short time. More molecules would then return to the liquid phase until equilibrium is reached again. This would result in the same value of saturated vapor pressure as before.

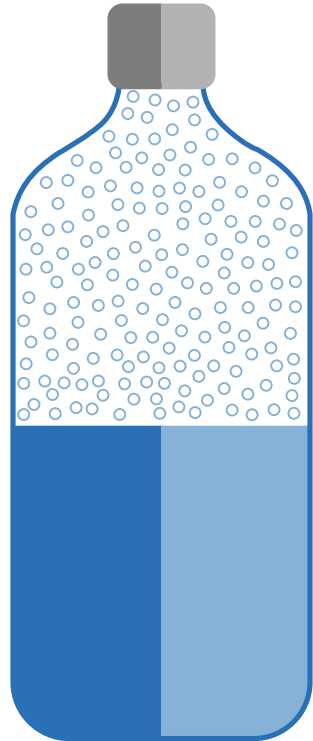

The saturated vapor pressure of any substance depends on its temperature. At higher temperatures, more molecules have sufficient kinetic energy to break from the liquid surface into the vapor phase. Under these conditions, equilibrium is reached at a higher pressure. This relationship between temperature and saturated vapor pressure for water is illustrated in Table 3.

**Table 3. Saturated Vapor Pressure of Water at Different Temperatures**

SATURATED VAPOR PRESSURE			
Temperature (°C)	Torr (mm Hg)	Pa (N/m <sup>2</sup> )	Millibar (mbar)
-50	0.030	4.0	0.04
-10	1.95	2.60 x 10 <sup>2</sup>	2.60
0	4.58	6.11 x 10 <sup>2</sup>	6.11
5	6.54	8.72 x 10 <sup>2</sup>	8.72
10	9.21	1.23 x 10 <sup>2</sup>	12.3
15	12.8	1.71 x 10 <sup>3</sup>	17.1
20	17.5	2.33 x 10 <sup>3</sup>	23.3
25	23.8	3.17 x 10 <sup>3</sup>	31.7
30	31.8	4.24 x 10 <sup>3</sup>	42.4
40	55.3	7.37 x 10 <sup>3</sup>	73.7
50	92.5	1.23 x 10 <sup>4</sup>	123
60	149	1.99 x 10 <sup>4</sup>	199
70	234	3.12 x 10 <sup>4</sup>	312
80	355	4.73 x 10 <sup>4</sup>	473
90	526	7.01 x 10 <sup>4</sup>	701
100	760	1.01 x 10 <sup>5</sup>	1013
120	1489	1.99 x 10 <sup>5</sup>	1985
150	3570	4.76 x 10 <sup>5</sup>	4760

## 5 Partial Pressure

As discussed in Chapter 3, atmospheric air is a mixture of several kinds of gases. According to Dalton's Law, the atmospheric pressure is the sum of the vapor pressures of each individual type of gas. The pressure contribution of each kind of gas toward the total atmospheric pressure is called the partial pressure of that gas.

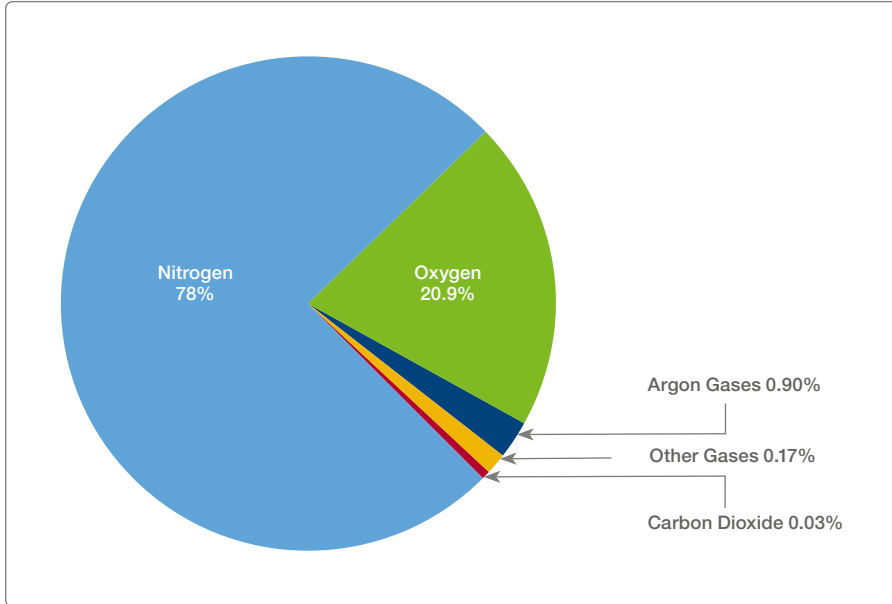

Dry atmospheric air contains 78.1% nitrogen ( $N_2$ ) and 20.95% oxygen ( $O_2$ ) by volume. It follows that 78.1% of the atmospheric pressure can be attributed to the partial pressure of  $N_2$  and 20.95% to the partial pressure of  $O_2$ .

At an atmospheric pressure of 101.3 kPa at sea level (1 atm), oxygen exerts a partial pressure  $P_{\text{oxygen}}$  of 21.22 kPa, and nitrogen exerts a partial pressure  $P_{\text{nitrogen}}$  of 79.12 kPa. The partial pressure of oxygen can be calculated by:

$$P_{\text{oxygen}} = X_{\text{oxygen}} \cdot P_{\text{air}} \quad (2)$$

where  $X_{\text{oxygen}} = 0.2095$  (20.95% by volume of  $O_2$  molecules in air) and  $P_{\text{air}}$  is the total absolute air pressure.



## 5.1 Absolute Pressure

The absolute atmospheric pressure depends on altitude. At sea level the absolute pressure is 101.3 kPa. The pressure decreases approximately 0.2 kPa per every 100 m increase in altitude. This relationship is defined by the barometric-altitude equation:

$$P_a = P_s \cdot 10^{-a/c} \quad (3)$$

where  $P_a$  is the absolute atmospheric pressure (unit: kPa) at altitude “ $a$ ,”  $P_s$  is the atmospheric pressure at sea level (101.3 kPa),  $a$  is the altitude (unit: km) above sea level, and  $c$  is a constant equal to 18.4 km. Some absolute pressure values for various altitudes are shown in Table 4.

**Table 4. Altitude vs. Atmospheric Pressure**

0 m = 101.3 kPa	1200 m = 87.2 kPa
200 m = 98.8 kPa	1400 m = 85.0 kPa
400 m = 96.4 kPa	1600 m = 82.9 kPa
600 m = 94.0 kPa	1800 m = 80.9 kPa
800 m = 89.4 kPa	2000 m = 78.9 kPa
1000 m = 89.4 kPa	

### Oxygen Control in Biopharma Applications

In a bioreactor, proper dissolved oxygen measurement and control is necessary to optimize the oxygen transfer rate (OTR) from gas to liquid phase and the oxygen uptake rate (OUR) of cells. The amount of oxygen is also known as the degree of aeration.

If oxygen levels drop below a certain threshold, then cells can be stressed to the point of limited growth (hypoxia) or cell death (anoxia). High levels of dissolved oxygen (hyperoxia) are also undesirable because of oxygen toxicity. Too much gas (oxygen or air) can also cause excessive foam buildup that increases operational costs for anti-foam chemicals and equipment usage.

Depending on the cell type, typical dissolved oxygen control is optimized at 30% to 60% air saturation with control limits of +10% and -5%. Different cell types (such as mammalian or bacterial) exhibit a wide variation in OUR values.

The OUR value must be determined for each process to accurately determine oxygen control needs. The key to accurate oxygen control is measuring the dissolved oxygen in the liquid phase (see Figure 2).

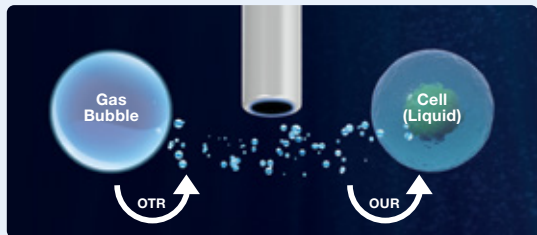

*Figure 2. Oxygen must transfer from gas phase to liquid phase (OTR—Oxygen Transfer Rate) in order to be consumed by the cell (OUR—Oxygen Uptake Rate).*

## 6 Oxygen Concentration in Aqueous Solutions

If oxygen-free water comes in contact with atmospheric air, the water tries to draw oxygen molecules (and of course molecules of other gases) from the air until it reaches saturation. By doing so, the water dissolves the oxygen gas like any other solid or liquid. The solubility depends on temperature. For solids and liquids, solubility increases with rising temperature, whereas for gases, solubility decreases with rising temperature.

The increasing temperature provides the kinetic energy for the acceleration of all gas molecules. Some gas molecules escape from the water back into the air. This is the reason why a glass of beer goes flat when it gets warm and why fish seek deeper water in summer. They cannot survive in the oxygen-starved warm water at the surface.

Oxygen exerts the same partial pressure when dissolved in water as it does in air. The in-and-out movement of oxygen molecules at the air/water phase boundary stops when the partial pressure of oxygen in the water equals the partial pressure of oxygen in air above the water. The water is now saturated with oxygen, and a state of equilibrium is reached at the air/water phase boundary.

Therefore, only the partial pressure of oxygen in the air above the water determines the maximum partial pressure of oxygen in the water.

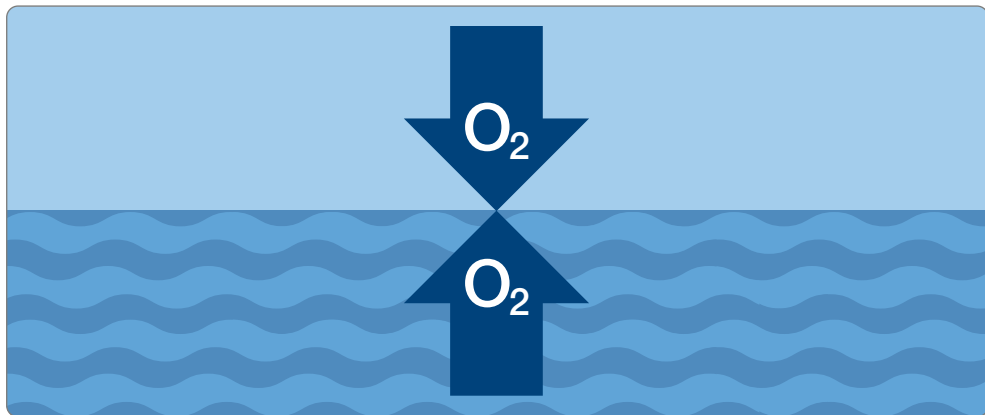

$$P_{O_2}(\text{water}) = P_{O_2}(\text{air})$$

In addition to oxygen molecules, water molecules also leave the water, as well as those of nitrogen, argon, and other gases. The total partial pressure is therefore spread amongst all gases and vapors in the air; the volume concentration of oxygen (20.95%) is not affected. Therefore, the air above the water/air phase boundary is always moist to the extent that the air is saturated with water vapor.

## 6.1 Moist Air vs. Dry Air

The behavior of moist air is different from that of dry air. Equation 2 (page 16) is valid only for dry air, and, therefore, must be re-written to account for the water vapor:

$$P_{O_2} = X_{O_2} \cdot (P_{air} - P_{water}) \quad (4)$$

where:

$P_{O_2}$  = partial  $O_2$  pressure in water-vapor-saturated air (kPa)

$X_{O_2}$  = volume concentration of oxygen in atmospheric air (0.2095)

$P_{air}$  = total atmospheric pressure (kPa)

$P_{water}$  = partial water vapor pressure (kPa from Table 3)

Saturated water vapor pressure varies with temperature (see Table 3), and, therefore, the partial oxygen pressure depends on temperature.

For example, what is the partial pressure for oxygen in water-vapor-saturated air at sea level and at an air temperature of 20°C?

$$\begin{aligned} P_{O_2} &= X_{O_2} \cdot (P_{air} - P_{water}) \\ &= 0.2095 \cdot (101.3 - 2.33) \\ &= 0.2095 \cdot 98.97 \\ &= 20.73 \text{ kPa} \end{aligned}$$

This value is approximately 2.3% below the value for dry air (21.22 kPa).

With Equation 4, we can calculate the oxygen concentration of air-saturated water in units of the partial pressure of oxygen, i.e. in **kPa**. However, industry often requires the oxygen concentration to be expressed in mg/l or ppm (part per million) instead of **kPa**.

## 6.2 Henry's Law

The oxygen concentration in any liquid depends on the solubility of oxygen in that liquid and is proportional to the partial pressure of oxygen. The conversion from partial pressure to concentration is possible with the aid of the principles defined in Henry's law.

The British physician and chemist William Henry (1775–1836) stated in 1803 that:

***When the temperature is kept constant, the weight of a gas that dissolves in a liquid is proportional to the pressure exerted by the gas on the liquid, provided that no chemical action occurs.***

Henry's Law describes how many liters of a gas dissolve in 1 liter of water at a certain temperature and a partial pressure of **P**:

$$S = (P/P_N) \cdot \alpha \quad (5)$$

where **S** is the solubility of the gas (by volume), **P** is the partial pressure of the gas, **P<sub>N</sub>** is the atmospheric pressure (1 atm or 101.3 kPa at sea level), and **α** is a dimensionless absorption coefficient.

In the case of air-saturated water, the partial pressure of oxygen for water-saturated air must be substituted for **P**. The absorption coefficient **a** is different for every liquid (see Figure 3); therefore, different solutions have a different dissolved oxygen concentration at the same partial pressure of oxygen.

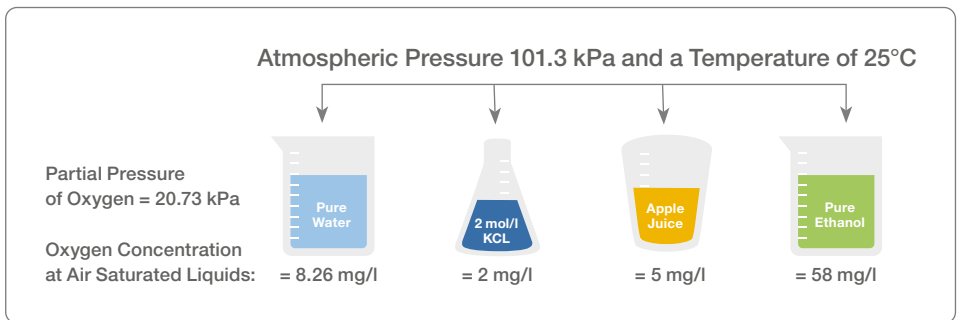

Figure 3. Oxygen concentration in different air-saturated liquids.

Note that the absorption coefficient  $\alpha$  is also temperature dependent, as shown in Table 5.

**Table 5. Absorption Coefficient Values for Oxygen in Water**

°C	0	5	10	15	20	25	30	35	40	50
$\alpha$	48.90	42.86	38.02	34.15	31.03	28.44	26.16	24.40	23.06	20.90

With Henry's Law and the molar mass ( $M_{O_2}$ ) and molar volume ( $V_{O_2}$ ) of oxygen, it is possible to calculate the saturated oxygen concentration (mg/l) in air-saturated water (water in equilibrium with air):

$$C_{O_2} = \frac{X_{O_2}(P_{air} - P_{water})}{P_N} \cdot \alpha \cdot \frac{M_{O_2}}{V_{O_2}} \quad (6)$$

where:

$C_{O_2}$  = saturated oxygen concentration

$X_{O_2}$  = 0.2095

$P_{air}$  = total atmospheric pressure

$P_{water}$  = partial water vapor pressure

$P_N$  = atmospheric pressure (1 atm or 101.3 kPa)

$\alpha$  = absorption coefficient for water (dimensionless)

$M_{O_2}$  = molar mass of oxygen (32 g/l)

$V_{O_2}$  = molar volume of oxygen (22.414 l/mol)

The values of the saturated oxygen concentration at different temperatures and different pressures play an important role for the calibration of DO analyzers. Therefore, these values are combined in the saturated oxygen concentration tables, which are discussed in the Appendix (section 13.3). Also note that salinity can influence the solubility of the liquid thus must be considered when discussing oxygen concentration. Please see section 9.2.2 for more information.

## 6.3 Oxygen Saturation Index

Until now, we have discussed only oxygen-saturated water, i.e., water that has dissolved the maximum amount of oxygen that it theoretically can take up. In this water the same partial pressure of oxygen prevails as in the water-saturated air above the water surface.

However, it is possible that the oxygen concentration in water can be higher or lower than its saturation level. This means that the equilibrium of the partial pressure of oxygen between air and water no longer exists. Water, not in equilibrium, may be quite stable with regard to its oxygen concentration. The water will, of course, either lose oxygen to the air or gain oxygen from the air, but these diffusion processes are extremely slow.

In order to determine the saturation condition for oxygen of these waters, the so-called oxygen saturation index  $s$  can be applied. This oxygen saturation index specifies the percentage of the actual oxygen concentration in relation to the saturation value  $C_{O_2}$ :

$$s = (C/C_{O_2}) \cdot 100\% \quad (7)$$

where  $s$  is the oxygen saturation index,  $C$  is the actual oxygen concentration, and  $C_{O_2}$  is the saturated oxygen concentration.

**Example:** What is the oxygen saturation index if water at 20°C and at an atmospheric pressure of 98 kPa contains 7.12 mg/l oxygen? First, the saturated oxygen concentration at 98 kPa must be calculated. To do this reference the Saturated Oxygen Concentration Table in the Appendix (section 13.3). The value of oxygen at 20°C is 9.08 mg/l:

$$\begin{aligned} C_{O_2(P_{air})} &= \frac{P_{air} - P_{water}}{P_N - P_{water}} \cdot C_{O_2(P_N)} \\ &= \frac{98 - 2.33}{101.3 - 2.33} \cdot 9.08 \\ &= 8.78 \text{ mg/l} \end{aligned}$$

Now, the oxygen saturation index can be calculated:

$$\begin{aligned} s &= (C/C_{O_2}) \cdot 100\% \\ &= (7.12/8.78) \cdot 100\% \\ &= 81.1\% \end{aligned}$$

Note that the same mass concentration of oxygen in water, but at different temperatures, will result in different saturation indexes. The previous example at 35°C would result in a saturation index of 106%.



# 7 Polarographic Measurement and the Clark Cell

## 7.1 Principles of Polarographic Measurement

One of the most common devices for measuring the DO concentration in water is called a polarographic sensor. A polarographic sensor operates by inducing an electrochemical reaction with the dissolved oxygen; the resulting electrical signal indicates the DO concentration.

The basic design of a polarographic sensor consists of a working electrode (cathode), a counter electrode (anode), a reference electrode, a voltage source, and an electrical current detector (see Figure 4).

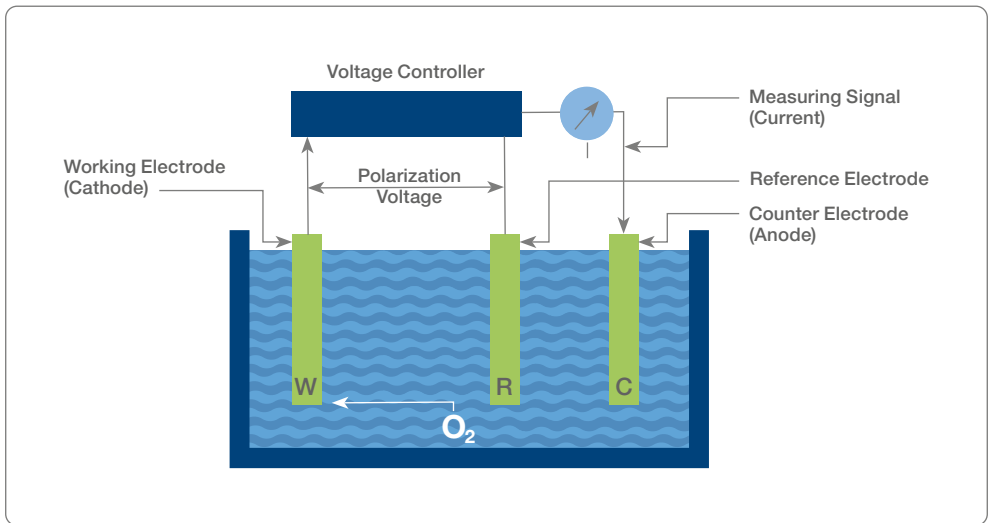
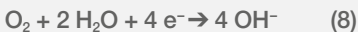

Figure 4. Schematic diagram of a polarographic sensor.

The voltage source applies a small voltage, referred to as a polarization voltage, between the working electrode and the counter electrode. The dissolved oxygen undergoes a reduction reaction at the working electrode:



The source of the electrons ( $e^-$ ) in Equation 8 is the counter electrode. The counter electrode, typically made of silver (**Ag**) or silver chloride (**AgCl**), undergoes an *oxidation reaction* that releases electrons into the water:



See the Appendix (section 13.2) for details on reduction-oxidation (redox) reactions.

This electron flow (electrical current) from the anode to the cathode represents the measuring signal, which is proportional to the partial pressure of the oxygen in the measured solution.

These reactions do not start automatically; the polarization voltage must be greater than the standard redox potential (+401 mV) of the reaction at the cathode, but with reversed polarity. This negative *polarization voltage* must be absolutely constant and stabilized against the reference electrode.

The standard redox potential is measured against the standard hydrogen electrode; the **Ag/AgCl** reference electrode itself has a potential difference of +210 mV against the standard hydrogen electrode. The applied polarization voltage must, therefore, be the sum of both voltages:  $-(401 + 210) = -611$  mV (see Figure 5). This is only an indication value; as discussed below, the actual applied polarization voltage is much higher.

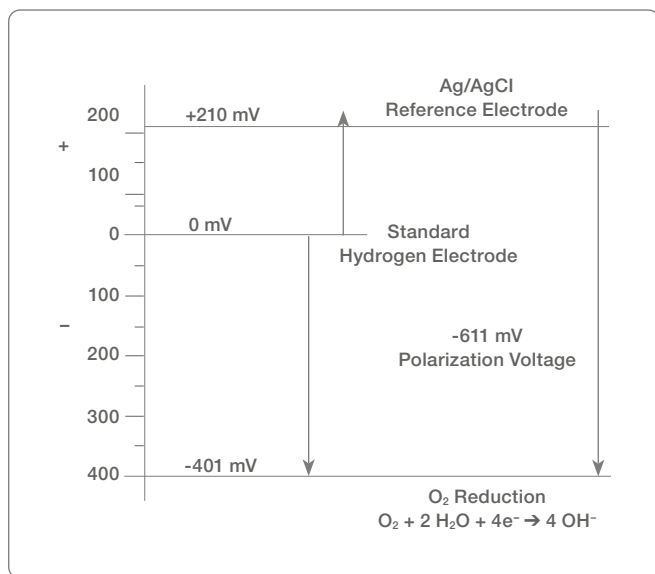

Figure 5. Composition of polarization voltage.



If the applied polarization voltage is too low, for example below  $-200$  mV, no oxygen reduction can take place at the cathode. The applied voltage must be raised above that value in order to start the reduction that consumes electrons at the cathode. This condition initiates an electron flow from the anode to the cathode. Under increasing applied voltage, the current increases steeply until a plateau is reached at approximately  $-600$  mV. Further voltage increases do not raise the current significantly. Under this condition the chemical reaction proceeds so fast that all oxygen molecules at the cathode are reduced, and the resulting electron flow (the measuring current) depends only on the oxygen concentration in the measured solution (see Figure 6).

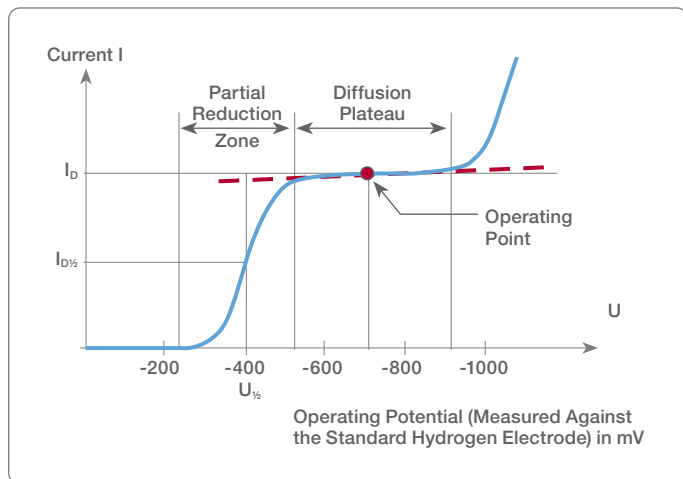

Figure 6. Diffusion plateau.

As shown in Figure 6, in the partial reduction zone, the polarization voltage is insufficient to enable a total reduction of all oxygen molecules at the cathode. At the diffusion plateau, the current no longer depends on the polarization voltage. All oxygen molecules at the cathode are reduced. The current is proportional to the quantity of oxygen molecules in the sample solution.

The design operating point of the device should be in the middle of the diffusion plateau.

The oxygen concentration at the working electrode is not necessarily representative of the oxygen concentration in the entire sample solution. Oxygen molecules are constantly reduced, and, therefore, the oxygen concentration decreases continuously at the cathode. To overcome this problem, the measured solution must be stirred or agitated to deliver fresh oxygen molecules to the working electrode. However, there will always be a small unstirred boundary layer at the cathode surface, no matter how strong the stirring action. Only by diffusion can the oxygen molecules reach the cathode surface. The electron flow is thereby governed by this diffusion, and thus the current at the diffusion plateau is called the diffusion current ( $I_D$ ).

## 7.2 The Membrane-Covered Clark Dissolved Oxygen Sensor

Before 1956, dissolved oxygen sensors consisted of bare, un-insulated noble metal electrodes. These sensors had a major drawback in that they were quickly coated with the measured medium, which degraded the measuring result.

American scientist Leland C. Clark (1918–2005) invented a polarographic oxygen sensor that overcame this issue. The Clark sensor consists of two electrodes, a silver anode and a platinum cathode (see Figure 7). Both electrodes are immersed into a half-saturated potassium chloride (KCl) electrolyte chamber. The electrolyte chamber is separated from the sample solution by a Teflon membrane that is held in place by a rubber ring. Oxygen molecules from the sample solution diffuse through the membrane into the electrolyte. The platinum cathode is completely insulated by a glass cylinder, and only the tip, with a diameter of approximately  $20\ \mu\text{m}$ , is exposed to the electrolyte. The electron flow between the two electrodes, when polarized with a negative potential of  $-600\ \text{mV}$ , determines the oxygen concentration in the measured medium.

The Clark oxygen sensor is a two-electrode sensor, i.e., the anode is combined with the reference electrode. To fulfill the role of a reference electrode, the anode must be coated with AgCl or silver bromide (AgBr). The electrolyte surrounding the anode must also contain the coating material.

The most important development of the Clark oxygen sensor is the protection of the electrodes from the measured medium by a membrane. This membrane must have the ability to allow oxygen to diffuse through it from the measured medium to the cathode. The membrane material is normally

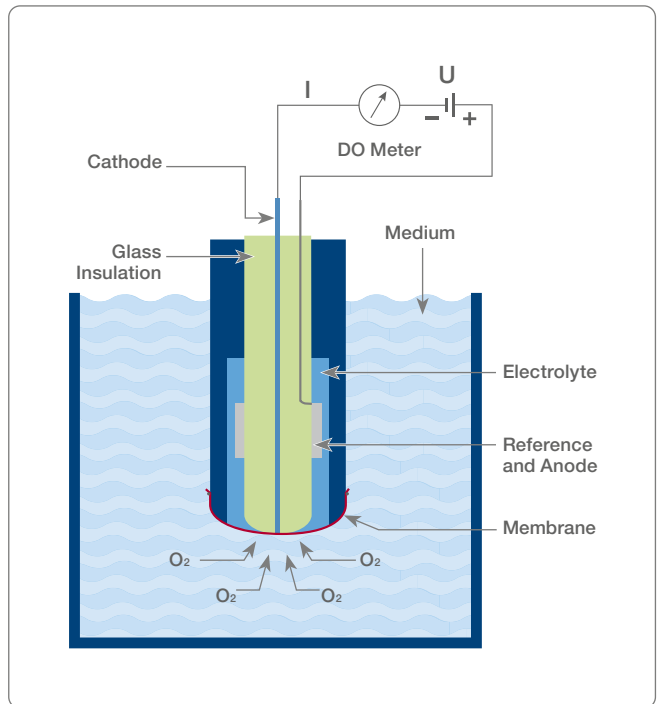

Figure 7. Clark dissolved oxygen sensor.

polytetrafluoroethylene (PTFE) or fluorinated ethylene propylene (FEP), with a thickness of between 10 and 50  $\mu\text{m}$ . These plastics possess a high oxygen permeability, are highly resistant to chemical corrosion, and can be exposed to high temperatures. The membrane must be fitted to the sensor in such a manner that it will lie flat against the cathode tip so that all the diffused oxygen is reduced.

The membrane-covered Clark sensor requires a constant flow of new liquid in order to supply oxygen molecules to the sensor cathode. If the reduction at the cathode is low, the flow velocity can also be low, but if the reduction is fast, the flow velocity of the measured medium must be increased accordingly.

The oxygen consumption at the cathode depends on the thickness of the membrane and the size of the cathode tip area. A thicker membrane decreases the oxygen consumption and increases the response time. A smaller cathode tip area also decreases the oxygen consumption.

By optimizing these parameters, it is possible to slow the flow velocity of the measured medium down to less than 5 mm/s. However, a low flow velocity increases the sensor response time beyond acceptable levels. Achieving a fast response time requires a thin membrane (approximately 10  $\mu\text{m}$ ). The oxygen consumption at the cathode again depends on the thickness of the membrane and the size of the cathode tip area; therefore, a sufficiently thin membrane to achieve fast response time requires a high flow velocity of up to 300 mm/s.

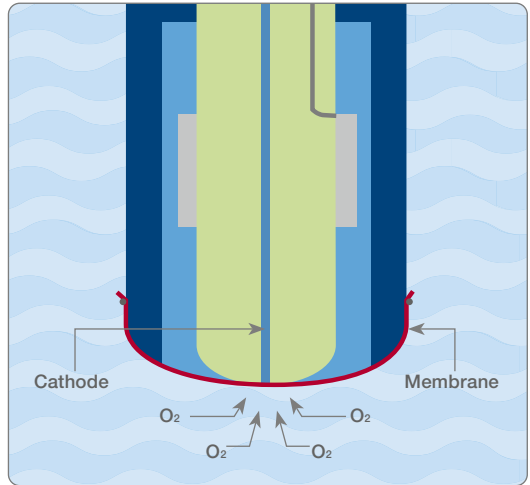

## 7.3 Signal Measurement

The measuring signal, which is the electron flow between anode and cathode, is mathematically expressed by:

$$I = n \cdot F \cdot P_M \left( \frac{P_{O_2}}{b} \right) \cdot A \quad (10)$$

where:

- I** = measured signal (A · s)
- n** = number of electrons released by the chemical reaction (n = 4)
- F** = faraday's constant (9.649 × 10<sup>4</sup> As/mol<sup>-1</sup>)
- P<sub>M</sub>** = oxygen permeability of the membrane (cm<sup>2</sup>)
- P<sub>O<sub>2</sub></sub>** = partial pressure of oxygen (mol/cm<sup>3</sup>)
- b** = membrane thickness (cm)
- A** = area of cathode tip (cm<sup>2</sup>)

Equation (10) shows that the measured signal is directly proportional to the partial pressure of oxygen and not to the oxygen concentration. If the measured value must be expressed in ppm, ppb, or mg/l, then the sample fluid temperature, the barometric pressure, and the oxygen solubility of the measured media must be known. A separate temperature probe can be used, but most oxygen sensors have a built-in temperature probe. A solubility table for oxygen in water (see Appendix, section 13.3) is normally included in the software of modern dissolved oxygen meters, and even a barometric pressure sensor is incorporated into some sensor devices.

The membrane's permeability is also temperature dependent. The oxygen permeability of the membrane increases strongly with rising temperature, which allows more oxygen to diffuse into the electrolyte of the oxygen probe, even though the oxygen partial pressure has not changed. This would result in false measuring results if not compensated for with a temperature measurement near the membrane.

The temperature dependency of the oxygen diffusion **P<sub>M</sub>** is explained by:

$$P_M = P_{Stp} \cdot e^{-\frac{E}{RT}} \quad (11)$$

where:

- P<sub>M</sub>** = oxygen permeability of the membrane (m<sup>2</sup>)
- P<sub>Stp</sub>** = oxygen permeability at standard temperature and pressure (m<sup>2</sup>)
- E** = initiation energy (J/mol)
- R** = gas constant (J · K<sup>-1</sup> · mol<sup>-1</sup>)
- T** = absolute temperature (K)



## Polarization Modules

The stabilization time is the time between connection of the oxygen sensor to the converter (measuring instrument) and the time when accurate measurements can be expected. Polarization is needed because oxygen diffuses through the membrane into the electrolyte compartment of the sensor when no voltage is applied to the sensor. This oxygen must be consumed by the cathode first; the result is a temporarily high O<sub>2</sub> concentration indication by the measuring instrument.

The stabilization time depends on the sensor type and on the required measuring accuracy. Normally manufacturers of oxygen sensors specify the stabilization time in the sensor technical specifications. Because these times can range between 30 minutes and 24 hours, Hamilton introduced polarization modules in order to prepare replacement oxygen sensors for immediate use once being connected to a measuring instrument.

The polarization module is attached to the sensor prior to use. A small battery generates the polarization voltage needed to consume oxygen within the electrolyte. Because the Hamilton OxyGold® B sensor differs from the OxyGold G in its polarization voltage, there are two polarization modules available, one for all sensors having a polarization voltage of  $-670$  mV (including OxyGold G) and one specific to the OxyGold B sensor.



*Hamilton Polarization Unit*

The measuring current increases exponentially when the temperature of the membrane rises. The temperature dependency of the membrane is normally given as the “membrane temperature coefficient” and can be compensated for by a compensation circuit and a temperature probe.

# 8 Optical Dissolved Oxygen Sensors

The DO sensors discussed so far depend on electrochemical processes to generate the signals that indicate the DO level in aqueous solutions. However, this approach is not suitable for all applications. In particular, traditional polarographic sensors have a number of issues:

- **High maintenance:** These sensors require regular replacement of the electrolyte and membrane cap.
- **Long startup time:** Polarographic sensors must undergo a polarization process to remove any residual oxygen in the sensor prior to use. This process can take 2 to 8 hours.
- **Accuracy issues:** Polarographic sensors are susceptible to contamination by gases such as carbon dioxide, which can alter the pH of the electrolyte, and by mobile ions such as sulfides, which can foul the electrodes. These issues affect the accuracy of the sensor.
- **Environmental requirements:** Because polarographic sensors consume the oxygen they measure, they require a constant flow or agitation of the water to avoid local depletion of the measured oxygen and reduction in accuracy.

These shortcomings have motivated intense research into alternative methods of measuring DO. The most effective approach found so far is the optical DO sensor. Optical DO Sensors normally consist of the following:

- **Excitation light.**
- **Oxygen-sensing material, which is made of a luminescent dye, called luminophore, and the polymer matrix permeable to oxygen.**
- **Photodetector to measure the alterations in the emitted light characteristics of a luminophore in absence or presence of oxygen.**

In addition to addressing the shortcomings of traditional DO sensors listed above, optical DO sensors have a number of advantages:

- **Less fouling from contaminants in the liquid (and therefore less signal drift).**
- **Faster response time.**
- **Immunity against electrostatic noise.**
- **Greater stability against pressure spikes.**

In this chapter we discuss the development and operating principles of the DO sensor and some specific comparisons between DO sensors and traditional polarographic DO sensors.



## 8.1 Principles of Optical DO Sensor Operation

### 8.1.1 Fluorescence Quenching and Phase Shift

Optical DO sensors operate on the principle of luminescence. In certain materials, called luminophores, electrons within the luminophore absorb the energy of the specific excitation light and reach an excited state. In this state, interactions with other molecules (e.g. oxygen) can take place since the luminophore remains in the excited state for defined time (fluorescence lifetime). When the electrons return from the excited state back to the ground state, they emit light thus luminesce or fluoresce.

The interesting thing about luminophore materials is that the presence of oxygen gas ( $O_2$ ) in the excited state has two effects on the material's fluorescence properties. When the oxygen molecule collides with the luminophore during the excited state, the energy is transferred from the luminophore to the oxygen and:

- 1) The intensity of the emitter fluorescence is reduced.
- 2) The fluorescence lifetime of the luminophore is shortened.

This phenomenon is called fluorescence quenching and is shown in Figure 8.

With optical DO sensors, fluorescence quenching can

be measured by detecting changes in intensity and fluorescence lifetime. There is a relationship between the amount of oxygen present in the measurement sample and decrease in fluorescence intensity and/or fluorescence lifetime, which is described by the Stern-Volmer equation. Thus, by detecting and measuring one of these properties of the emitted light, the amount of oxygen present in the sample can be determined.

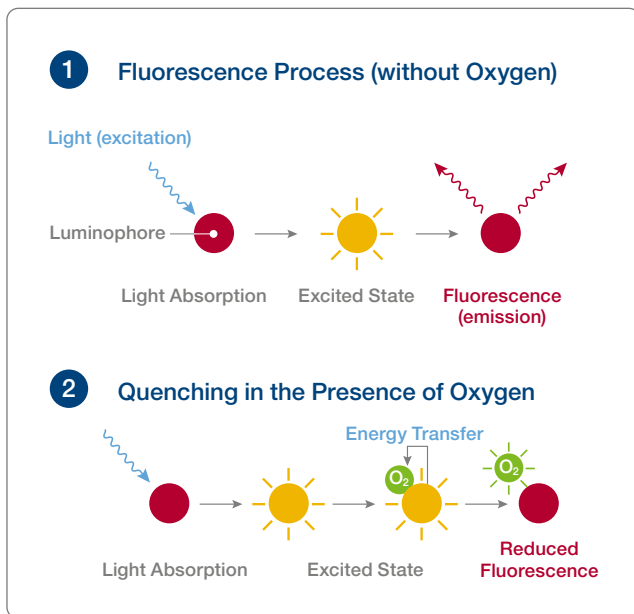

Figure 8. Fluorescence quenching process.

## 8.1.2 The Stern-Volmer Equation

Both the change in fluorescence intensity and the phase shift are correlated with the concentration of dissolved oxygen. This relationship is called the Stern-Volmer equation:

$$\frac{I}{I_0} = \frac{\tau}{\tau_0} = 1 + K_{SV}[O_2] \quad (12)$$

where:

$I$  = the measured fluorescence intensity

$I_0$  = the reference (oxygen-free) fluorescence intensity

$\tau$  = the measured lifetime

$\tau_0$  = the reference (oxygen-free) lifetime

$K_{SV}$  = the fluorescence quenching constant, which is a property of the fluorescent material

$[O_2]$  = the concentration of oxygen

The simplicity and linearity of the Stern-Volmer equation simplifies the task of converting either the measured intensity or measured lifetime to an electronic signal that represents the dissolved oxygen concentration.

The first optical DO sensors relied solely on intensity. They suffered from accuracy issues over long periods of use because of factors such as fading of the dye compound and physical damage to the luminophore.

However, using phase shift as a measure of DO concentration has some advantages over intensity. As shown in Figure 9, page 33, the relationship between phase shift and oxygen concentration follows a stable, predictable pattern. In addition, phase shift is less sensitive to physical damage to the luminophore. As a result, more-recent optical DO sensor designs rely on phase shift rather than intensity.



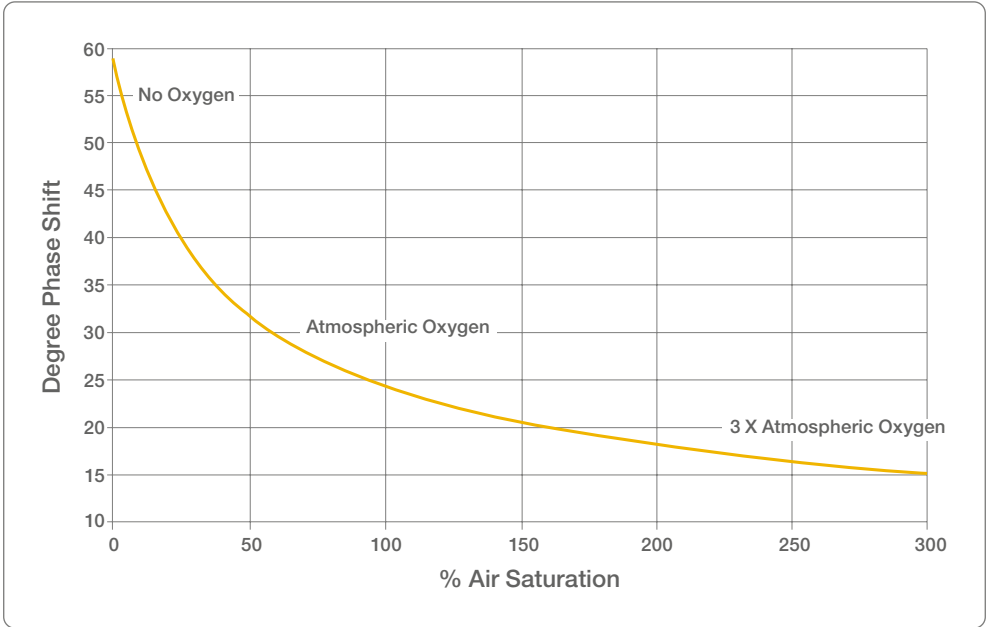

Figure 9. Relationship between dissolved oxygen and phase shift.

### 8.1.3 Optical DO Sensor Components

As shown in Figure 10, page 34, a basic optical DO sensor consists of the following components:

- **A light source.**
- **A transmission medium (either a fiber optic or a window through which the light travel from the source to the fluorescent material).**
- **The luminophore (fluorescent dye suspended in a silicone gel matrix) that comes in contact with the aqueous solution.**
- **A photodetector to detect the light emitted from the fluorescent dye.**
- **Electronic circuitry to convert the detected fluorescence intensity and/or lifetime to an electronic signal.**

Although the concept of fluorescence quenching was first described scientifically in 1939, it wasn't until the late 20<sup>th</sup> century that the technology started attracting intense research interest, driven by the shortcomings of electrochemical DO detection and the improvements in light sources, photodetectors, and electronic signal processing.

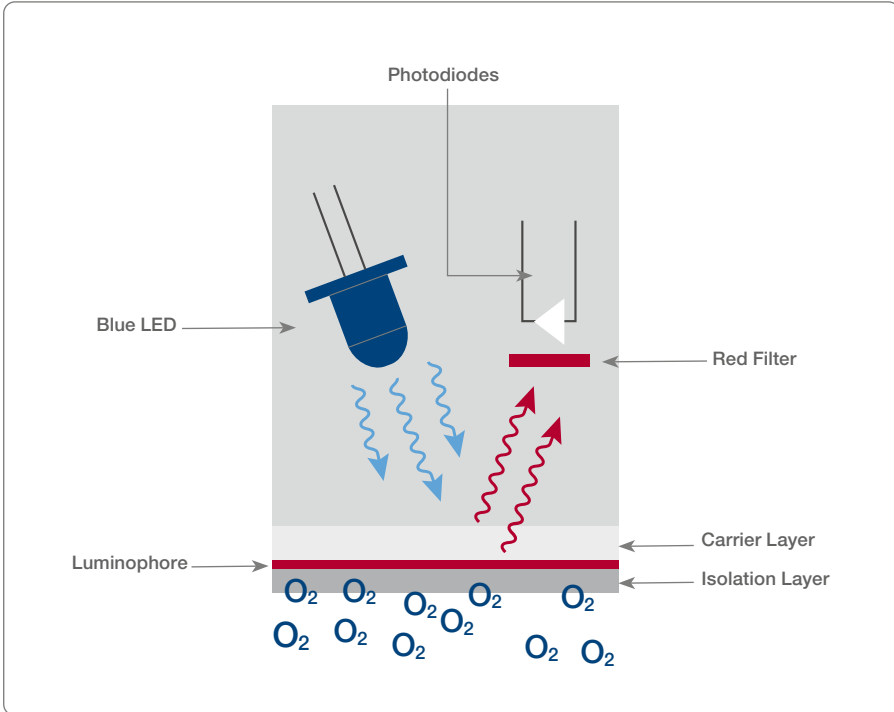

Figure 10. Basics of optical DO sensor measurement channel. Starting at the blue LED, photons travel to the luminophore and are emitted back to the photodiode at a frequency relative to the amount of oxygen diffused through the membrane.

Much of the research and development work in optical DO sensors has centered on the oxygen sensitive dye found in the luminophore. Several luminescent compounds are suitable for the optical DO sensor application; they fall into three main classes:

- Polycyclic aromatic compounds.
- Platinum-based compounds.
- Ruthenium-based compounds.

Each luminophore material has advantages and disadvantages for optical DO sensing. The exact material used in a given commercial sensor is often a strict trade secret.

The light source and photodetector are also critical components. Because each dye material fluoresces at a different wavelength of incident light, the light source, usually a light-emitting diode (LED), must be tuned to the correct wavelength. Similarly, the photodetector must be capable of detecting the intensity and phase of the fluorescent emission of the dye material.

## 8.1.4 Compensation

The performance of fluorescence-quenching optical DO sensors can be affected by various environmental and operational factors, such as temperature, pressure, and component aging. To maintain accurate readings and extend the useful life of the device, the effects of these factors must be compensated.

- **Temperature:** Changes in the temperature of the water being analyzed can alter the quenching effect of the dissolved oxygen, resulting in a reduction in sensor accuracy. Most commercial optical DO sensors incorporate a temperature sensing component. The electronic circuitry uses the temperature signal to correct the DO reading.
- **Pressure:** The pressure of the ambient air can also cause accuracy issues. The solubility of gas in water depends on the partial pressure of the gas, which is affected by altitude and weather conditions. Most optical DO measurement systems enable the user to enter the value of local atmospheric pressure. The system uses this value to correct the DO reading.
- **Salinity:** The amount of dissolved salt (NaCl) in the water also affects the solubility of oxygen gas. As with the case of pressure compensation, salinity compensation can be achieved by manual input based on a separate salinity measurement.

## Hamilton's Optical DO Sensor Technologies

As a leader in sensor technology for bioreactors and scientific instruments, Hamilton has recognized the need for DO sensors that overcome the shortcomings of polarographic sensors while producing output signals that are compatible with those sensors. This demand motivated the development of our VisiFerm® ECS DO sensor product.

### 8.1.5 VisiFerm® ECS

Hamilton's VisiFerm sensors with electrochemical signal (ECS) output transform the photodetector output to the nano-ampere (nA)-level output that is typical of traditional polarographic DO sensors. The ECS interface is a good choice for replacing polarographic sensors connected to existing bioreactors. In addition, most DO transmitters currently on the market require a nA signal thus the Visiferm ECS can be retrofitted to work with these products. The output from an NTC 22-k $\Omega$  temperature sensor is also included to enable temperature compensation by external electronic circuitry.

### 8.1.6 VisiFerm® RS-485

VisiFerm RS-485 DO sensors incorporate a built-in microtransmitter within the sensor. The output of these sensors is either 4–20 milliampere (mA) analog output or a Modbus digital signal. Hamilton's Arc technology compensates for temperature changes and adjusts for input pressure and salinity values, all within the sensor with no need for external compensation circuitry. The output signal is therefore fully compensated. One advantage of this design is that VisiFerm Arc sensors can be directly connected to the process control system (PCS) without the need for a secondary transmitter.



## 8.2 Optical vs. Polarographic DO Sensors: A Side-by-Side Comparison

The following table summarizes the differences between optical and polarographic DO sensing technology.

**Table 6. DO Measurement Technology Comparison**

	Polarographic	Optical
Response Time $T_{98\%}$	<60 s @25°C Air to N <sub>2</sub>	<30 s @25°C Air to N <sub>2</sub>
Typical Measurement Range	10 ppb to 40 ppm (DO)	4 ppb to 40 ppm (DO); versions also exist for trace DO measurement
Power	None, but the sensor requires connection to transmitter for polarization and conversion of weak nA signal	7 to 30 VDC max, 1W
Operation	Consumes oxygen; requires flow past sensor	No oxygen consumption or need for flow
Startup Time	2-h polarization time required prior to measurement	Measurement is immediate
Maintenance	Requires frequent rebuild and replacement of electrolyte and membrane cap; periodic replacement of cathode	Periodic membrane cap replacement as indicated by internal quality indicator
Known Interferences	CO <sub>2</sub> , H <sub>2</sub> S, strong chemicals that can permeate the membrane	Strong oxidizers such a ClO <sub>2</sub> may require special cap design with additional jacketing. Consult factory for additional support.

### 8.2.1 A Note on Device Costs

The purchase price of optical DO sensors tend to be higher than that of their polarographic counterparts. However, the price difference is more than made up for by the reduction in ongoing maintenance. The electrolyte and membrane cap for a polarographic sensor are pricey and must be replaced frequently, and the process is labor-intensive. Over the service life of the device, an optical DO sensor has a much lower total cost of ownership than its polarographic equivalent.

# 9 Calibration

Not every dissolved oxygen sensor supplies the same output for a given oxygen concentration. Even for a given type of sensor (polarographic or optical), each sensor differs slightly in its physical characteristics, material composition, and membrane fabrication. For polarographic sensors, aging of the electrolyte causes the measuring current to decrease slowly with time.

Together these differences can result in slight variations of the sensor output from one sensor to the next. Therefore, each sensor has its own characteristic curve (called *slope*) of output current vs. oxygen concentration. To retain high measurement accuracy, the output of the transmitter must be adapted (calibrated) to the sensor's zero-current and slope at regular intervals.

## 9.1 Sensor Zero Calibration

The zero current of the oxygen sensor at 0% oxygen concentration must be calibrated first. Normally the zero current is negligibly small and almost identical with the transmitter zero point. Nevertheless, the sensor zero current should be periodically checked, especially before the measurement of low oxygen concentrations.

Zero-point calibration may be performed either in pure nitrogen or in water saturated with nitrogen. Another alternative is the use of a freshly-prepared 2% bisulfite solution. In any case, the sensor tip must be exposed to 0% oxygen.

The saturation of water with nitrogen can be time consuming, therefore calibration with pure nitrogen gas is faster and more reliable. The nitrogen gas must flow over the sensor tip. The zero point can be read after approximately 2–3 minutes.

The zero-point calibration may often be omitted because modern oxygen sensors are “zero current free,” but it should be performed at least at the first-time calibration. Because today's DO transmitters are mostly software-based, they can store the oxygen sensor data as reference values for sensor statistics. These are the deviations of slope and zero-point, corresponding calibration values for temperature, air pressure, response time, and calibration date and time, all with respect to the reference values of the first-time calibration.

For polarographic sensors, a first-time calibration must be performed any time the complete sensor, the electrolyte, or the membrane with electrolyte is replaced.



## 9.2 Sensor Slope Calibration

The slope calibration can be performed in water or air where the oxygen concentration is known.

### 9.2.1 Calibration in Water

Water calibration is usually performed in 100% air-saturated water, i.e., the water must be in equilibrium with air. Oxygen exchange between water and air is normally quite slow. In order to accelerate the saturation process, air may be forced into water by a small fish-tank pump or with the aid of a compressed air bottle. Care must be taken that the air inlet is not placed too deep below the water surface and the air velocity is not too fast; otherwise, the air might be compressed by the water column, causing bubble formation. The bubbles would cause a higher partial oxygen pressure in the water than that above the surface.

Another requirement is an absolute constant water temperature during the calibration process. Water temperature might be influenced by changing room temperature and by the cooling effect of the forced air intake. Stabilizing the temperature can be a long process. As a result, it is quite difficult to produce air-saturated water with an accuracy better than 1 to 2%.

Modern DO transmitters include a small barometric pressure sensor. As explained previously, the oxygen sensor incorporates a temperature probe. Pressure and temperature are, therefore, always known, and the software automatically performs the necessary calculations for ambient pressure and temperature compensation for membrane permeability and water solubility.

For polarographic sensors, the calibration water must be stirred to achieve the minimum required flow velocity, and the water temperature and pressure conditions should correspond as closely as possible to those expected to be encountered during the actual measurement.

### 9.2.2 Calibration in Air

Because it is easier to produce water vapor-saturated air than air-saturated water, slope calibration should be performed in air. The partial pressure of oxygen, as explained previously, is the same above the water surface as that just under the water surface. A water bottle filled partly with water and left alone for approximately 15 minutes provides 100% water vapor-saturated air. It is important to keep the tip of the oxygen sensor dry because condensed water droplets at the membrane can influence the oxygen diffusion through the membrane and cause an incorrect electron current.

Parameters such as temperature and pressure must remain constant during calibration.

With modern DO measurement software such as ArcAir<sup>®</sup>, it is no longer required to perform the air calibration in water vapor-saturated air. An input is provided to manually enter the ambient relative air humidity in percent. The calibration is set to a 100% saturation index. The software calculates

the partial pressure of oxygen at the set relative humidity and adds the missing partial pressure of the water vapor. The result is an indication of 100% saturation index either just above a water surface or just under the water surface. The measuring result in ambient air will be higher than 100% because the partial pressure of oxygen in ambient air will be higher because of the missing water vapor. See Figure 11.

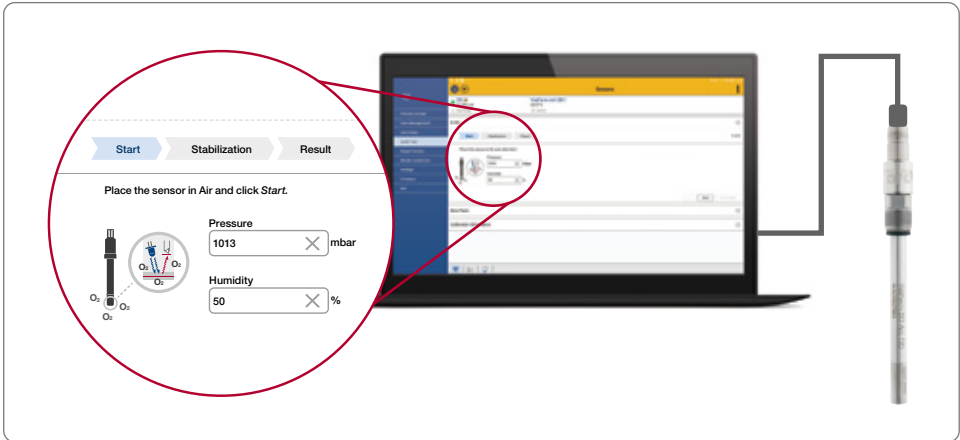

Figure 11. Hamilton ArcAir® Software allows humidity to be input prior to calibration.

Hamilton ArcAir® Software allows humidity to be input prior to calibration.

The partial pressure of oxygen in partially water vapor-saturated air can be calculated by:

$$P''_{O_2} = X_{O_2} (P_{air} - h \cdot P_{water}) \quad (13)$$

where:

$P''_{O_2}$  = pressure of the partially water vapor-saturated air (kPa)

$X_{O_2}$  = volume fraction of oxygen in air (0.2095)

$P_{air}$  = total atmospheric pressure (kPa)

$P_{water}$  = partial water vapor pressure (kPa from Table 3)

$h$  = relative humidity in %/100 (reference section 6.1)



Example: What is the saturation index indication of a DO meter in ambient air at 20°C, 101.3 kPa atmospheric pressure, and a relative humidity of 50%?

$$\begin{aligned}
 P_{\text{O}_2}^{\text{a}} &= X_{\text{O}_2} (P_{\text{air}} - h \cdot P_{\text{water}}) \\
 &= 0.2095(101.3 - 0.5 \cdot 2.33) && (14) \\
 &= 0.2095(101.3 - 1.165) \\
 &= 0.2095 \cdot 100.135 \\
 &= 20.98 \text{ kPa}
 \end{aligned}$$

Recall from Chapter 6 that 20.73 kPa was the calculated value for the partial pressure of oxygen in water vapor-saturated air at equal conditions. The percentage difference can then be calculated as follows:

$$\frac{P_{\text{O}_2}^{\text{a}}}{P_{\text{O}_2}} = \frac{20.98}{20.73} \cdot 100 = 101.2\%$$

## Influence of Salinity

If a Winkler titration is performed on air-saturated freshwater and, for the sake of comparison, on air-saturated seawater, both under identical temperature and barometric pressure conditions, the oxygen concentration (mg/l) in seawater will be observed to be approximately 20% lower than it is in freshwater. If these measurements are repeated with a Clark sensor, both measurements will render identical results, because the membrane-covered oxygen sensor responds only to the partial pressure of oxygen.

The partial pressure of oxygen in both freshwater and seawater under identical conditions is the same because it is governed only by the air above the water surface. It follows that saltwater does not require as much oxygen to establish equilibrium in the partial pressure of oxygen at the air/water boundary (see Chapter 6). The solubility of oxygen in water is reduced by the salt content in that water, and a dissolved oxygen measurement with a Clark sensor does not detect this fact.

An accurate dissolved oxygen concentration measurement with a Clark sensor is possible if one can refer to a special saturation oxygen table for saltwater. Some DO measurement software integrates these so-called oceanographic tables, supplied by Unesco, in order to calculate the correct oxygen concentration in seawater.

It is not possible to provide general guidance for the salinity correction when measuring the dissolved oxygen concentration in aqueous solutions. This depends mainly on the ability of the available measuring system; it is necessary to refer to the operating instructions.

# 10 DO Sensors and Their Applications

Hamilton offers a full line of dissolved oxygen sensors for applications in a wide variety of industries.

## 10.1 Biopharma

Perhaps the most common application in biopharma is the measurement of dissolved oxygen in cell culture applications. Oxygen is a critical process parameter (CPP) required for cell growth. Cells are grown in a vessel called a bioreactor (see Figure 12), where oxygen is maintained at approximately 30 to 60% air saturation. Too little oxygen stresses the cells, limits growth (hypoxia) or possibly causes cell death (anoxia). Excessive levels of oxygen cause the negative effects of foam buildup within the vessel and even oxygen toxicity.

DO sensors used in bioreactor applications can be either polarographic or optical. These sensors must have a hygienic design and the ability to withstand sterilization (autoclave or steam-in-place) as well as chemical cleaning (clean-in-place).

### Hamilton DO Sensors for Biopharma

- **Optical:** VisiFerm® family.
- **Polarographic:** OxyFerm® FDA.

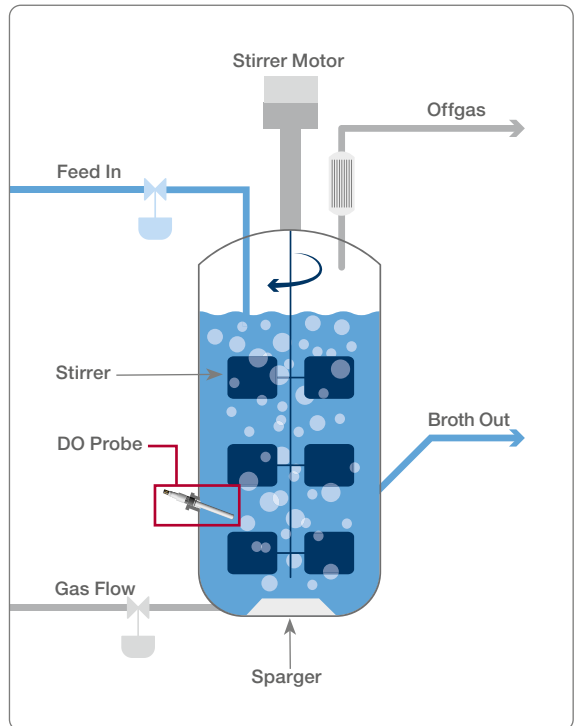

Figure 12. Basic bioreactor layout.

## Single-Use Dissolved Oxygen Sensors

In recent years, the biopharma market has transitioned from glass or stainless-steel reusable bioreactor vessels to single-use disposable bioreactors. Single-use bioreactors rely on a plastic bag or container that is gamma sterilized prior to use. The benefits of this design include eliminated risk of batch-to-batch contamination, more predictable yield, and reduced setup and downtime between runs.

Single-use sensors have also been adapted for these applications. Optical sensor caps can be pre-mounted within the bag or container and gamma sterilized with the entire assembly. Once operational, the sensor can be threaded into the cap so that dissolved oxygen can be measured throughout the run. Once complete, the sensor is removed and the cap is disposed of with the rest of the plastic hardware.



VisiFerm® DO SU

## 10.2 Brewing and Beverage Manufacturing

Dissolved oxygen measurements are needed throughout the beer brewing process (see Figure 13). Yeast in the fermentation process requires initially high oxygen levels to maintain metabolism. Toward the end of fermentation, the oxygen drops to trace levels as alcohol and CO<sub>2</sub> increase. Downstream from the fermentation process, oxygen measurement serves as a quality control check. Excessive oxygen in the final product can reduce the shelf life and stability of the beer and degrade its taste and color.

Sensors used in brewery processes often have a difficult life. They must withstand frequent chemical cleaning and disinfection after each batch. The sensor may be exposed to solids such as grains and hops. Hamilton carries multiple sensors for the brewing industry, including portable DO measurement devices.



Figure 13. DO sensor in the wort line at Bitburger Brewery.

### Hamilton DO Sensors for Brewing

- **Optical:** VisiTrace® mA, VisiFerm® mA. Beverly® (portable).
- **Polarographic:** OxyGold® B.

## 10.3 Water Treatment, Fish Farming, and Environmental Monitoring

Multiple industries rely upon dissolved oxygen to keep biological organisms alive. In water treatment, aerobic bacteria are used to digest organic matter. Raw water is pumped into large aeration ponds where submersed dissolved oxygen sensors are used to control the flow rate of air injection into the liquid. Proper aeration not only keeps the bacteria healthy but also helps to control the expense of operating these air blower systems, which account for 40 to 60% of the electrical cost of the facility.

In fish farming, changes in oxygen levels can be caused by algae blooms, pollutants, and seasonal changes. Oxygen levels below 4 to 5 PPM can cause die-off and loss of the fish stock. Dissolved oxygen must be constantly monitored to ensure proper aquatic health and operational profitability.

In environmental monitoring, many applications exist for dissolved oxygen measurement. Large manufacturing sites for pulp and paper, steel production, and chemicals use large volumes of water in their production processes. These facilities have in-house water treatment operations to remove pollutants before the effluent water is pumped back into the local source. Government regulations mandate that the dissolved oxygen levels of the effluent must be sufficiently high to avoid harming the river or lake that receives this treated water.

In the applications described above, it is common to submerge the dissolved oxygen sensor beneath the surface (see Figure 14). A long, fixed cable is used to send the sensor output signal to the dissolved oxygen transmitter or process control system.



*Figure 14. VisiWater DO P Arc sensor is designed for submersion with a 10-meter fixed cable.*

### Hamilton DO Sensors for Water Treatment, Fish Farming, and Environmental Monitoring

- **Optical:** VisiWater Family.
- **Polarographic:** OxySens™.

## 10.4 Power Generation

The elevated temperatures and pressures required for steam generation in power plants magnify the corrosive oxidizing effects of dissolved oxygen. Feedwater used in these applications must be deaerated to parts-per-billion trace levels to ensure that oxygen does not prematurely damage boiler tubing. Dissolved oxygen is measured before and after the deaeration process to ensure that the treated water is suitable for the boiler. After the steam is used in the turbine, it is condensed and pumped back with the boiler feedwater for reuse. Dissolved oxygen is frequently measured in the condensate pipelines to check for outside leaks that may lead to trace oxygen reentering the process.

Because of the extreme pressures and temperatures involved in power plant systems, DO is frequently measured in a sample line that has been pre-conditioned to reduce pressure and temperature. The measurement passes the sensor in a flow cell and then is disposed down a drain.

### Hamilton DO Sensors for Power Generation

- **Optical:** VisiTrace® mA.
- **Polarographic:** OxyGold® G.



# 11 Care and Maintenance of Oxygen Sensors

## 11.1 Optical Oxygen Sensor Maintenance

One of the major advantages of optical oxygen technology is the reduced need for ongoing sensor maintenance. The following guidelines apply to the VisiFerm® family, VisiWater, and VisiTrace® products.

When connected to ArcAir® software, all of Hamilton's powered sensors indicate their health status with simple traffic-light color coding (Figure 15). Yellow or red coloring can be an indication of errors, warnings, or hardware failures.

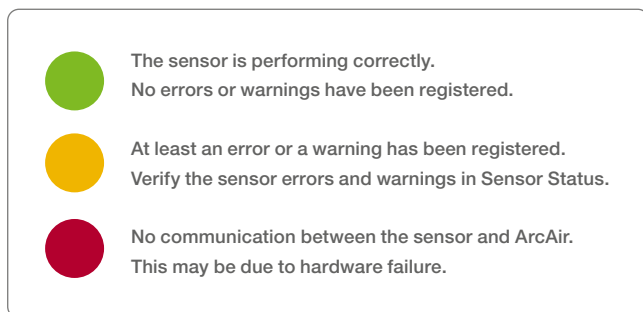

Figure 15. Sensor health indicators.

Optical oxygen sensor health depends in large part on the condition of the optical cap. Applications that expose the cap to elevated temperature, pressure, or harsh chemicals can accelerate cap aging and reduce sensor performance.

As shown in Figure 16, ArcAir® software provides real-time measurement quality indication as a percentage of top expected performance. The quality indicator accounts for both sensor and cap quality.

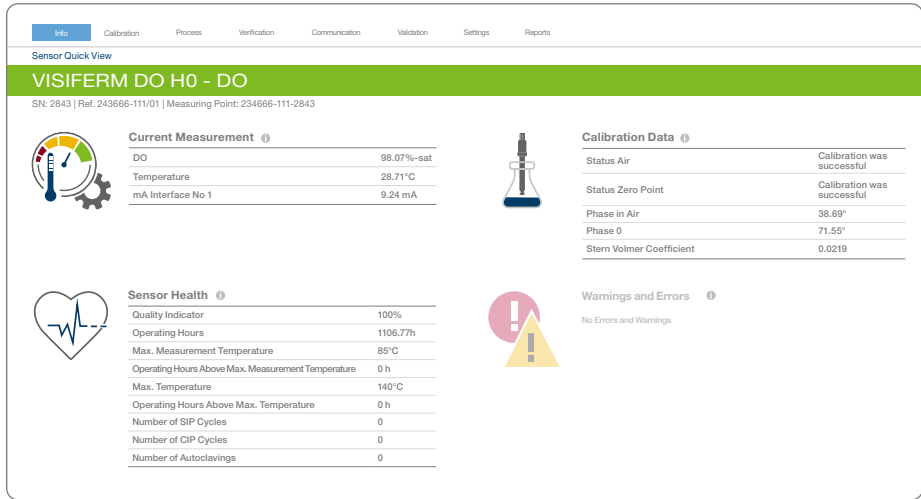

Figure 16. ArcAir Software sensor dashboard.

The software warns the user to replace the optical cap if the quality drops below 35%. After cap replacement, the new cap should boost the quality indicator to at least 60%. Cap replacement should be followed with a proper zero-point calibration and air calibration.

Replacing the optical cap is a simple procedure (see Figure 17):

- 1) Unscrew the ODO cap from the shaft.
- 2) Remove the O-ring and replace it with a new one.
- 3) Firmly screw the new ODO cap onto the sensor shaft again.
- 4) Perform sensor calibration.



Figure 17. Optical cap replacement.



## 11.2 Polarographic Oxygen Sensor Maintenance

The following sections discuss maintenance activities for Hamilton's polarographic oxygen sensor products.

### 11.2.1 OxySens™

The OxySens dissolved oxygen sensor is maintenance-free. It is provided with a water-filled storage cap over the sensor tip. This cap must be removed before installation or calibration. If the sensor can no longer be calibrated, it must be replaced.

### 11.2.2 OxyFerm®

With the exception of the FDA type, the OxyFerm sensors (see Figure 18) are shipped dry (no electrolyte in the membrane cartridge). The membrane cartridge must be carefully unscrewed from the sensor body, pre-rinsed with the corresponding electrolyte, and then filled with 1.0–1.5 mL of that electrolyte. Care must be taken not to touch or break the cathode/anode glass assembly. The filled membrane cartridge must be screwed tightly to the sensor body.

After connection to a measuring instrument (process converter, transmitter) the polarization voltage must be set to  $-670 \text{ mV} \pm 50 \text{ mV}$ . After a maximum period of 2 hours, the sensor is ready for calibration.

If the sensor is disconnected from the measuring instrument for a short time, the renewed polarization time must be twice the disconnection time, but no more than 2 hours.

During external sterilization, the OxyFerm sensor's bayonet plug T82/D4 should be covered by a protective cap (available from

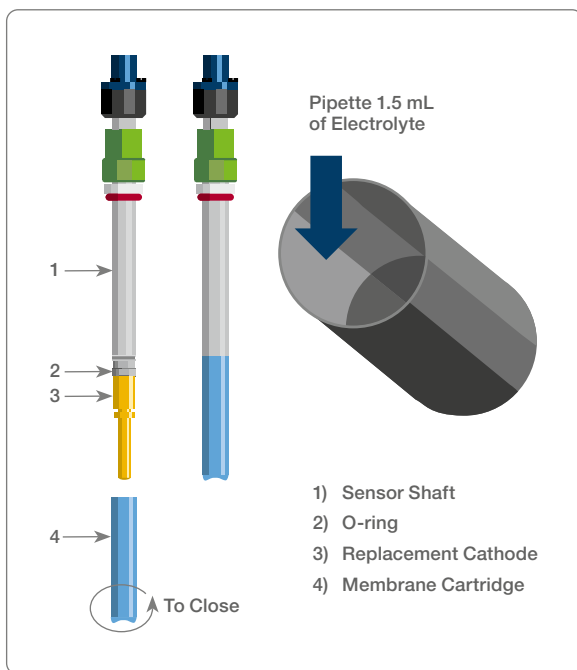

Figure 18. OxyFerm sensor.

Hamilton). If the plug is partially filled with water despite the protective cap, the plug should be rinsed with ethanol and dried afterward with a forced-air dryer (such as a hair dryer). No protection is necessary when using a VP 6.0 connection.

An operational sensor check can be performed as follows:

Calibrate the polarized sensor in air and adjust the measuring instrument to 100%. Immerse the sensor in a nitrogen gas-filled bag. After the sensor is immersed for 1 minute in nitrogen, the instrument must show a value below 2% of the previous value in air. If the value in nitrogen is too high, the electrolyte might be exhausted or the membrane might be deformed or otherwise defective. In such a case, the electrolyte or the membrane cartridge and the electrolyte must be replaced.

If the sensor still does not calibrate well, i.e., the response is too sluggish or the zero current is too high, the cathode and the front end of the glass body must be cleaned with the polishing strip included in the membrane kit. After cleaning, rinse the glass body under a running water tap and dry carefully.

If the sensor problem persists, the cathode must be replaced. With the cathode, the membrane also must be exchanged to regain the full performance of the sensor. The cathode assembly is replaced as follows (Figure 19):

- 1) Place the sensor in an upright position and carefully unscrew the membrane cartridge.
- 2) Flush the replaceable cathode assembly with deionized water and then dry the metal parts. *Do not touch anode and cathode!*
- 3) Hold the cathode assembly on the metal part (**B**) in front of the thread (**A**) and the sensor on the shaft (**C**) and pull apart. *Do not turn!*
- 4) Check that all contacts are dry and clean.
- 5) Replace the cathode assembly with a new one (blue for OxyFerm®, yellow for OxyGold® B, and black for OxyGold® G). Rotate the cathode assembly slowly and carefully until the correct position is found and then push the cathode assembly into the sensor shaft.
- 6) Check the small O-ring (**D**) above the thread. Replace if damaged.
- 7) Use the 1 mL plastic pipette of the membrane kit to pipette 1.0-1.5 mL of electrolyte into the new membrane cartridge. *The pipette must not touch the membrane itself!*
- 8) Screw the cartridge onto the sensor shaft. Rinse away any spilled electrolyte with water.

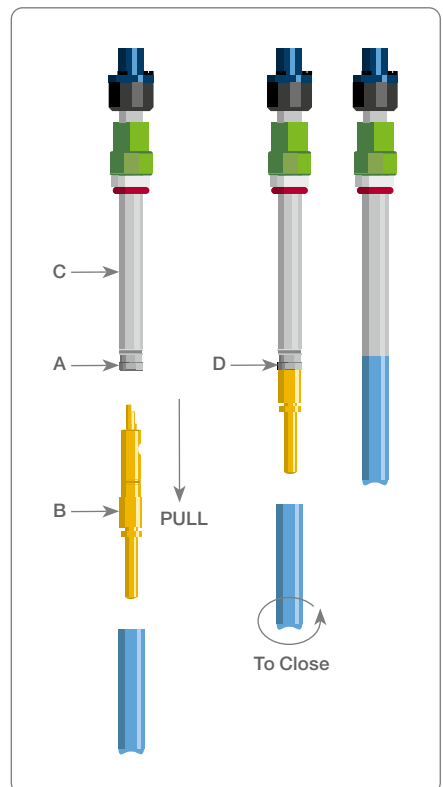

Figure 19. Cathode assembly replacement.

### 11.2.3 OxyGold® G & B

OxyGold sensors are shipped dry (no electrolyte in the membrane cartridge). The membrane cartridge must be carefully unscrewed from the sensor body, pre-rinsed with the corresponding electrolyte (G or B), and then filled with 1.0–1.5 mL of that electrolyte. Care must be taken not to touch or break the cathode/anode glass assembly. The filled membrane capsule must be re-screwed tightly to the sensor body.

For the OxyGold G sensor, after connection to a measuring instrument (process converter, transmitter) the polarization voltage must be set to  $-670 \text{ mV} \pm 50 \text{ mV}$ . After a maximum period of 2 hours, the sensor is ready for calibration.

For the OxyGold B sensor, the polarization voltage must be set to 0 mV. After a maximum period of 24 hours, the sensor is ready for calibration. If this polarization time is considered too long, the purchase of a polarization module is recommended.

## 11.3 Storage

Optical DO sensors should be stored in a clean, dry environment prior to use. Avoid prolonged exposure of the inside of the cap to ambient light.

For polarographic sensors that will be stored longer than 1 month, Hamilton recommends that the technician remove the internal electrolyte, rinse the cathode assembly with deionized water, and store the sensor dry. Polarographic sensors must be stored at temperatures between  $-10^{\circ}\text{C}$  and  $+60^{\circ}\text{C}$  with a water-filled cap covering the sensor tip. Prior to calibration and measurement, this cap must be removed. Add fresh electrolyte prior to using the sensor again.

## 11.4 Cleaning the Sensor

Take care when removing deposits from the sensor. Avoid strong chemicals that could harm the silicone membrane used on the sensor tip. Start the cleaning with a dust-free cloth or tissue paper and deionized water. If oil, grease, or other organic matter is present, then use isopropyl alcohol to clean the membrane. If other matter is present, then a non-aggressive detergent such as Alconox® may be used.

# 12 Connecting the DO Sensor

Each DO sensor connects to the measurement apparatus with one of a handful of connector types. Connecting the cable to the sensor must be performed carefully to ensure proper contact and avoid damage to the cable or the sensor. This chapter describes common types of connectors and how to use them.

## 12.1 Connecting Polarographic DO Sensors

For the most part, the connectors and cabling for polarographic DO sensors is not complex. There are two common connectors used for Hamilton's polarographic DO sensors:

### 12.1.1 T82 / D4

The T82 connector (Figure 20), sometimes known as a D4 connector, uses a twist-lock design to secure the cable to the sensor. They are less common than other types of connectors. Among Hamilton sensors, they are found only on the OxyFerm® FDA dissolved oxygen sensors.



Figure 20. T82 connector.

## 12.1.2 VP (VarioPin)

This is a common connector used throughout the Hamilton sensor product line (Figure 21). VP is an abbreviation for “VarioPin.” The VP designation often includes a number that refers to the number of exposed poles on the connector head; for example, VP6 indicates a six-pole connector. VP connectors are fully autoclavable and have an IP68 protection rating for submersion in water. The OxyGold® products use VP connectors exclusively, and they are available as an option on the OxyFerm® FDA dissolved oxygen sensors.



Figure 21. VP connector.

## 12.2 Connecting Optical DO Sensors

Optical DO sensors include built-in electronics that must be powered. One must consider the power source for these devices. Hamilton offers a variety of cable configurations for different applications and situations.

### 12.2.1 VisiFerm® Arc with Direct Connection to the PCS

These applications use 24 VDC directly from the control system and feature bare wire leads. The VisiFerm® Arc® (Figure 22) provides either a 4–20 mA analog or Modbus digital signal back to the control system. All VisiFerm Arc products use the VP Connector.

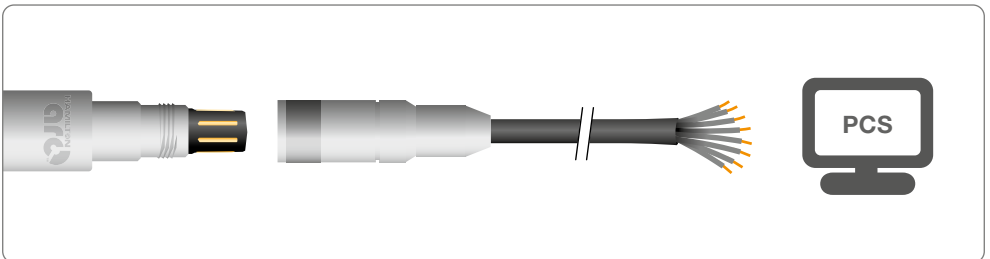

Figure 22. VisiFerm Arc with direct cable connection.

## 12.2.2 VisiFerm® and VisiTrace® mA with Direct Connection to the PCS (Two-Wire Loop Powered)

The VisiFerm and VisiTrace mA products (Figure 23) are unique in that they are loop-powered optical DO sensors. The 24 VDC bare-wire power leads also transmit the 4–20 mA analog signal back to the control system. These products also include the HART digital protocol. An M12 connector is standard.

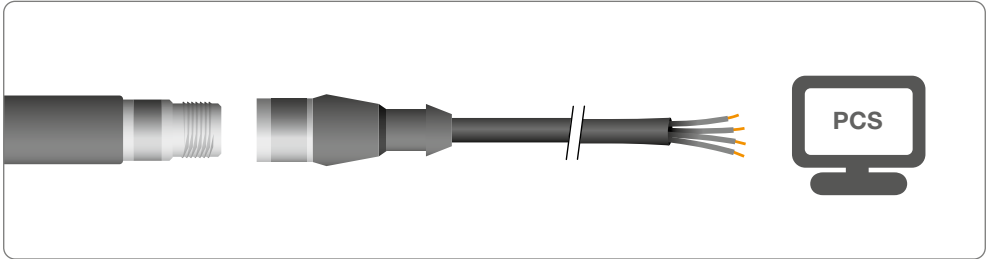

Figure 23. Loop-powered optical DO sensor.

## 12.2.3 VisiFerm® ECS with Third-Leg Power Supply

Powered cables are commonly used with the VisiFerm ECS DO sensors in applications where no power is available from the bioreactor or transmitter. A separate “third-leg” power supply uses available wall power to provide power to the sensor (Figure 24). These cables have a variety of connector options for use in bioreactors, including BNC, M16 Binder, AMP, and Lemo connectors, as well as bare wire leads for direct connection. The VisiFerm ECS uses a VP connector to mate with the cable. The VisiFerm ECS sensor can be powered through the cable, and the ECS signal will mimic the nano-ampere signal typical of polarographic sensors.

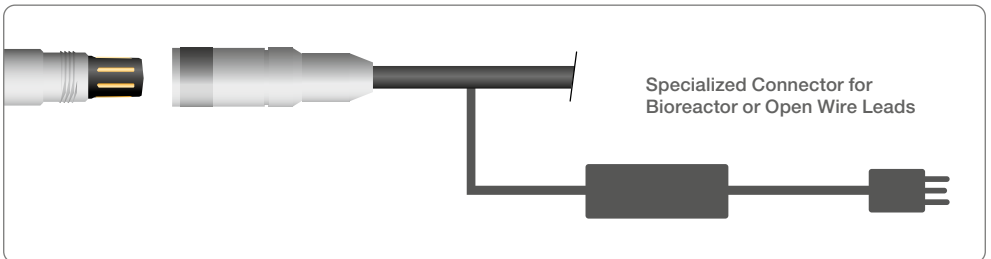

Figure 24. Cable with “third-leg” power supply.

# 13 Appendix

## 13.1 The Discovery of Oxygen

### 13.1.1 The Phlogiston Theory

Johann Joachim Becher (1635–1682), a German alchemist and physician, proposed in 1669 that substances are composed of three types of earth: “terra fluida” is the mercurial element, which contributes fluidity and volatility; “terra lapida” is the solidifying element, which produces the binding quality; and the third element is “terra pinguis” (fatty earth), which gives material substances their combustible qualities. This is the principle of inflammability. Wood, for instance, consists of ash and “terra pinguis.” When wood was burned according to this thinking, the wood was converted to ash and the “terra pinguis” was released.

Later, Georg Ernst Stahl (1660–1734), another German alchemist and physician, adopted the idea, but changed the name of “terra pinguis” to “phlogiston,” from the Greek *phlogios* (fiery); hence the name “phlogiston theory”.

He modified the theory and stated that all combustible materials were composed of two parts. One part, the “phlogiston,” was given off when the substance containing it was burned. The other, “de-phlogisticated” part was thought to be its true form, its “calx.” Stahl also included the calcination and corrosion of metals. When the metal was heated, “phlogiston” was set free and the “calx” remained. Highly combustible materials, such as coal, were made mostly of “phlogiston,” whereas non-combustible substances, such as iron, contained very little. Air did not play a role in the “phlogiston theory” and no initial quantitative experiments were conducted to test the idea. The “phlogiston theory” was based only on observation of what happened when something burned.

For almost a century the false doctrine of “phlogiston” clouded the thinking of all alchemists. Nobody ever had the idea that the actual process was the reverse: During combustion, a gas combines with the burned substance.

### 13.1.2 Carl Wilhelm Scheele

Carl Wilhelm Scheele (1742–1786) was born in Stralsund, Germany, which at that time was the capital of Swedish-occupied Pomerania. Scheele was the seventh of eleven children, and there was no money for his education. Even so, without formal training in chemistry, he became one of the greatest experimental chemists, and perhaps the most unfortunate scientific discoverer, of the 18th century.

Scheele (Figure A1) taught himself chemistry while apprenticed to an apothecary in Göteborg, Sweden. Later he worked as a pharmacist in the Swedish cities of Malmö, Stockholm, and Uppsala, eventually buying his own pharmacy in Köping, where he remained for the rest of his life.

This industrious, self-taught chemist is now credited with the discovery and identification of seven chemical elements and compounds, more than any other scientist before or since.

In 1772, while experimenting with a mixture of calcium nitrate and sulfuric acid, Scheele observed that a colorless gas escaped when the mixture was heated. He collected the gas in a glass cylinder and when he lit a candle within the cylinder, he saw that the candle burned much brighter than normal.

From this and similar experiments he deduced that air consists of two gases, one that supports combustion and the other that prevents it. He named the former “fire air” and the latter “rotten air.” Scheele experimented with this “fire air” (Figure A2, page 58). He discovered various ways to produce “fire air”: from nitric acid, potassium nitrate, manganese dioxide, mercuric oxide, and many others.

Scheele discovered that “fire air” was not only necessary for burning but for breathing as well. He put rats and mice, flies and bees, one after another, into jars and watched their behavior. Every time the result was as he suspected: after the “fire air” was consumed, the creatures died.

But Scheele failed to recognize “fire air” as a chemical element (namely oxygen), without which no life is possible on this planet. The “phlogiston theory” of Stahl was a barrier that prevented Scheele from understanding this vital and essential fact.



Figure A1. Carl Wilhelm Scheele.



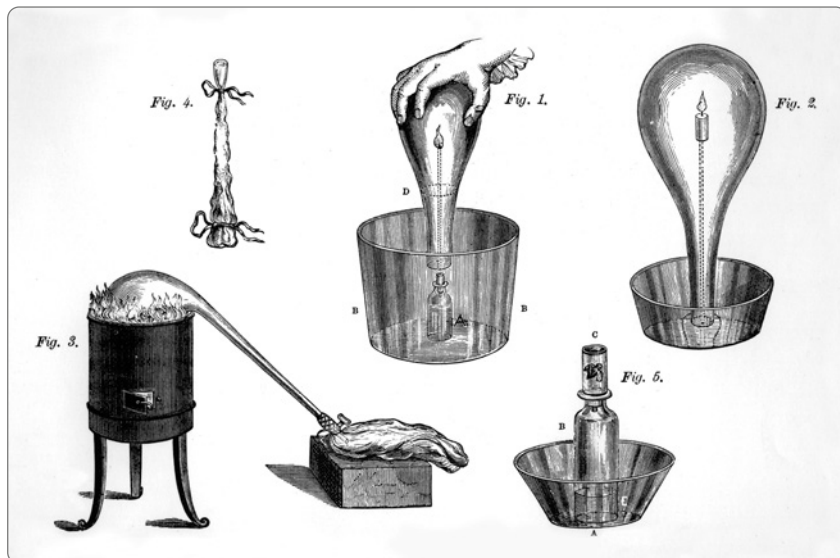

Figure A2. Tools Carl W. Scheele used during his experiments to analyze the composition of air.

Scheele wrote an account of his discovery in a manuscript he titled “Treatise on Air and Fire,” which he sent to his publisher in 1773. However, that document was not published until 1777. Because of the delay in publishing the results of his experiments, Scheele missed being credited with the discovery of oxygen.

In early 1786, aged only 44 years, Carl Wilhelm Scheele fell seriously ill. The symptoms suggest mercury poisoning; he was a victim of his own chemical experiments.

### 13.1.3 Joseph Priestley

Joseph Priestley (1733–1804) was born in Fieldhead, Yorkshire, England. Joseph was the first of six children. He was educated at Daventry Academy and trained as a minister of the Dissenting Church of England. In addition to his radical theological work and writings, Priestley (Figure A3), became interested in physical science, mainly electricity and chemistry. But Priestley was first and foremost a Unitarian minister and at first practiced science only as a hobby.

Priestley attended lectures and demonstrations on practical chemistry given in 1763–1765 by the surgeon Matthew Turner. In 1766 he met the American statesman Benjamin Franklin in London, who encouraged him to conduct experiments in the new science of electricity. A year later Priestley wrote his famous work “The History and Present State of Electricity.” Priestley discovered that charcoal was conductive and noted the relationship between electricity and chemical change. His interest turned increasingly towards chemistry. He studied “airs,” as gases were then called.

Joseph Priestley’s most famous discovery occurred in 1774 when he heated a red “calx” of mercury (mercuric oxide) in a glass vessel by focusing sunlight on it through a large lens. He found that silvery drops of mercury began appearing amongst the red “calx.” Simultaneously the decomposing “calx” emitted a colorless gas. Priestley collected the gas in a flask and lit a candle in it. He noted that, “The candle was burning with a remarkably vigorous flame. But to complete the proof of the superior quality of this air, I introduced a mouse into it; and in a quantity in which, had it been common air, it would have died in about a quarter of an hour, it lived ... a whole hour.”

Priestley, like his contemporary Scheele, believed in the “phlogiston theory,” which blurred his intellect and scientific judgement. He named the “new air” he discovered “dephlogisticated air,” believing that because objects burned so easily in its presence, it meant they rapidly released their “phlogiston.” He believed that ordinary air became saturated with “phlogiston” when it could no longer support combustion or life.

During a visit to Paris later in 1774, Priestley passed on his discovery of “dephlogisticated air” to the greatest chemist of the era, Antoine-Laurent de Lavoisier, and published his findings in 1775 in a work titled “Experiments and Observations on Different Kinds of Air.” For this work, he received the credit for the discovery of oxygen.



Figure A3. Joseph Priestley.

Priestley's observation that light was important for plant growth and that green plants gave off "dephlogisticated air" became the foundation for systematic studies on photosynthesis by other scientists.

The radical and liberal theological ideas of Priestley, plus his support for the principles of the French Revolution, angered the British public. On the second anniversary of the fall of the Bastille prison, a paid mob went on a rampage and burned and looted his house, laboratory, and church. Priestley escaped, and three years later, in 1794, fled England to settle in Northumberland, Pennsylvania. He died there in 1804, the last champion of the phlogiston theory.

### 13.1.4 Antoine-Laurent de Lavoisier

Antoine-Laurent de Lavoisier (1743–1794) was born into a wealthy, upper-class family in Paris. His grandfather and father were both successful lawyers, and his mother was the daughter of a rich advocate. After she died when Antoine (Figure A4), was five years old, he was brought up in his grandmother's house by his unmarried aunt Marie, sister of his mother.

When he was 11 years old, he attended the famous Collège Mazarin, the best institute in France at that time. At 17 Lavoisier entered the School of Law at the Sorbonne, the oldest university in the world, and at the age of 21 he graduated as a Bachelor of Law and qualified as Licentiate a year later.

After completing his study of law, it was science, not law, that called. Lavoisier attended courses in astronomy and mathematics, botany, geology, and alchemy (chemistry was not yet an academic subject). He became known in scientific circles initially, when he was awarded a gold medal, presented by the president of the Royal Academy of Science, for an essay on the best way to light the streets of a large town at night. He became a member of the Royal Academy of Science at the young age of 25.

Lavoisier was among the most educated men of his time, and he was rich. There was no need for him to work to earn money. Young Lavoisier became more and more interested in the newly emerging scientific subject "chimie." He was fascinated by the mystery of chemistry, which had not yet grown out of the alchemical arts of trying to make gold from other substances, and it was still dominated by Aristotle's four elements: water, earth, air, and fire.



*Figure A4. Antoine-Laurent de Lavoisier with his wife Anne-Marie.*

Lavoisier became the father of modern chemistry. He was the first scientist who introduced quantitative procedures into chemical investigations, he formulated the principle of the conservation of matter in chemical reactions, he clarified the distinction between elements and compounds, and he was instrumental in devising the modern system of chemical nomenclature.

Yet he was not a single-minded pioneer. During his brief fifty years of life he not only adopted a modern approach to chemistry, but also held simultaneously several top-level public offices in the French government. He contributed technological advances in ballooning, the mineralogical mapping of France, urban street lighting, the Paris water supply, the efficiency of gunpowder, and a full-scale model farm. He was a member of the commission appointed to secure uniformity of weights and measures throughout France. The report of that commission led to the adoption of the metric system.

In 1768 he became a member of the “Ferme Générale,” a governmental tax collecting agency. He introduced a tax reform and in 1788 built a wall around Paris in order to make the custom collection more efficient. This turned out to be the worst decision of his life because it made him a hated enemy by the lower classes.

In 1772, after various other chemical investigations, Lavoisier turned his attention to the much-discussed problem of combustion. He conducted an experiment heating lead in a sealed vessel containing a limited supply of air. At the beginning of the heating process the surface of the lead formed a layer of calx (lead oxide), and then it stopped doing so. Lavoisier now weighed the entire apparatus (the lead, calx, air, and the container itself), and found that it weighed exactly the same as it had done before being heated. Next he weighed the lead and its coating of calx – and found that this weighed more than the metal had previously weighed. But if the metal had gained weight, then something else in the vessel must have lost a similar amount of weight, and this could only be the air.

Lavoisier’s experiment proved that when metal turned into its calx, this had nothing to do with the loss of some mysterious phlogiston. He had shown that the metal in fact combined with a material substance which had weight, and that material substance consisted of a portion of the air.

It was now, in 1774, that Priestley arrived in Paris, and demonstrated to Lavoisier the new gas he had discovered, which he called “dephlogisticated air.” Lavoisier immediately grasped the far-reaching significance of this discovery. Lavoisier then experimented with a burning candle floating in a bowl of water. He placed an upturned glass jar over the candle and observed that when the candle burned, the water always rose to occupy one fifth of the jar. Air obviously consisted of two gases, in proportion of one to four. The one-fifth part used in combustion was Priestley’s “dephlogisticated air.” Through his experiments, Lavoisier demonstrated that burning is a chemical reaction, combining a substance with the newfound gas. He disproved the “phlogiston theory” and paved the way for a correct analysis of chemical compounds.

Lavoisier decided to rename this elemental gas “oxygen,” from the Greek oxy, meaning “acid,” and gen, meaning “generator” or “producer.” Lavoisier mistakenly thought that oxygen was present in all acids.



With the storming of the Bastille in 1789, the French revolution had begun and found Lavoisier in an extremely tricky situation. As a scientist he had done as much as anyone to promote enlightened reform, but he was also a member of two institutions that were strongly linked with the ancien régime: the Académie des Sciences and the hated Ferme Générale. Lavoisier survived in this environment for four years, but in November 1793, when the Reign of Terror was in full swing, Lavoisier was arrested. On the 8th of May 1794 Lavoisier was brought before the revolutionary tribunal, tried, sentenced to death, and guillotined on the same day.

When his friend, the celebrated French mathematician Joseph-Louis Lagrange, heard the news, his comment made a bitter epitaph: "Only a second to cut off that head, and a hundred years may not give us another like it."

### 13.1.5 Pascal's Principle

The earth's atmosphere exerts a pressure on all objects with which it is in contact, including other fluids. External pressure acting on a fluid is transmitted throughout that fluid.

For example: What is the magnitude of water pressure at a depth of 35 m below the surface of the sea?

$$\begin{aligned}
 P &= p \cdot g \cdot h \\
 &= (1000) \cdot (9.8) \cdot (35) \quad (15) \\
 &= 343,000 \text{ N/m}^2 \\
 &= 343.00 \text{ kPa}
 \end{aligned}$$

**p** = The average density of the fluid (1000 kg/m<sup>3</sup>)

**g** = The acceleration of gravity (9.8 m/sec<sup>2</sup>)

**h** = The height of the fluid column (m)

However, the total pressure at this point is the pressure of the water plus the pressure of the air above it (101.3 kPa). Hence, the total pressure is:

$$343.00 \text{ kPa} + 101.3 \text{ kPa} = 444.30 \text{ kPa}$$

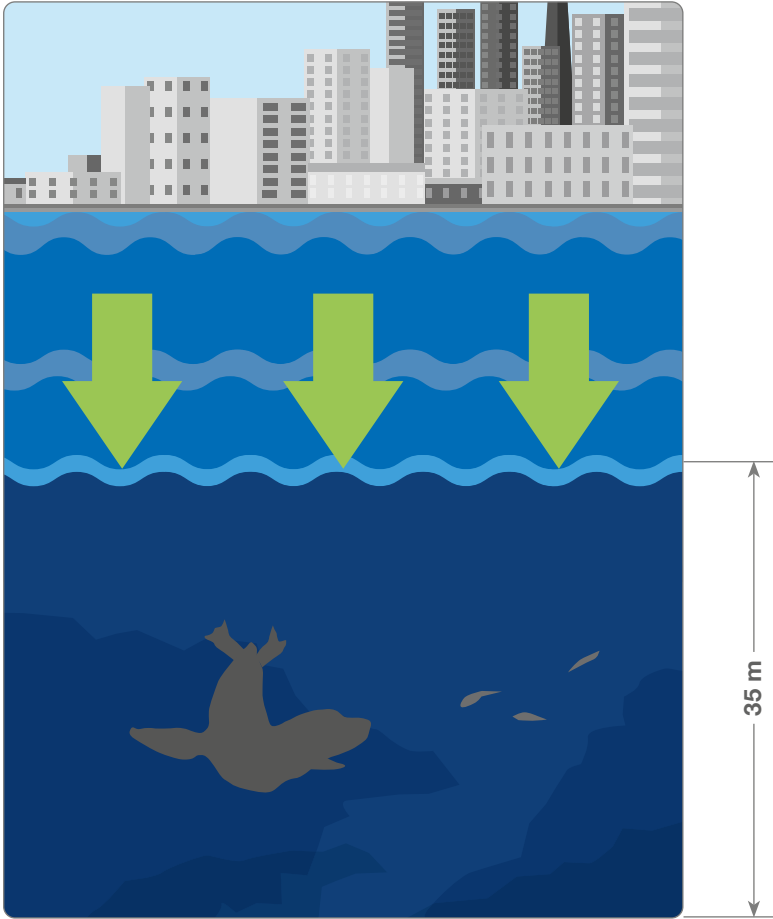

This is just one example of a general principle attributed to the French philosopher and scientist Blaise Pascal (1623–1662). Pascal's principle states that:

***Pressure applied to a confined fluid increases the pressure throughout by the same amount.***

### 13.1.6 Dalton's Law

John Dalton (1766–1844), a British researcher in mathematics and chemistry, is well known for the revival of the ancient Greek atomic philosophy. He transformed it from a hypothesis into a scientific theory: “Each element is composed of tiny, indestructible particles, atoms, all alike and having the same atomic weight. Different elements have atoms of different weights. Each element therefore is characterized by the weight of its atom.”

Dalton's early studies on gases led to the development of the law of partial pressure, also known as Dalton's Law:

***The total pressure of a mixture of gases or vapors is equal to the sum of the partial pressures of the individual component gases, i.e., the sum of the pressures that each component gas would exert if it were present alone and occupied the same volume as the mixture of gases.***

Strictly speaking, the principle is true only for *ideal gases*. It assumes no chemical interaction between the component gases. An *ideal gas* is a hypothetical gas that would consist of molecules that occupy negligible space and have negligible forces between them. All collisions between molecules and the container wall or between molecules and other molecules would be perfectly elastic because the molecules would have no means of storing energy except as translational kinetic energy.

Dalton's Law is approximately valid for real gases at low pressures (up to 600 kPa) and high temperatures.

## 13.2 Oxidation and Reduction Reactions

Originally, *oxidation* was simply regarded as a chemical reaction with oxygen. The reverse process, or loss of oxygen, was called *reduction*. Oxidation and reduction processes occur continuously in nature. Most metals are oxidized directly by free oxygen; for example, iron reacts in accordance with the equation.



Ferrous oxide (**FeO**) can also be oxidized further to ferric oxide:



This oxidation reaction may also take place in aqueous solutions, where certain substances form ions:



whereby the ferrous ion (**Fe<sup>2+</sup>**) loses an electron to the oxygen, thus becoming the ferric ion (**Fe<sup>3+</sup>**), hence passing from the bi-valent to the tri-valent state.

The last oxidation example leads us to today's wider definition of oxidation and reduction, which is universally accepted and independent of the element oxygen:

- **Oxidation takes place when a molecule or ion loses electrons.**
- **Reduction takes place when a molecule or ion gains electrons.**

However, because free electrons rarely exist in any solution, reduction and oxidation reactions are always coupled together. It is the movement of electrons that causes both oxidation and reduction: one reaction releases just as many electrons by oxidation as the other consumes by reduction. These simultaneous and complementary reduction and oxidation processes are generally called "redox" reactions.

A simple example of a redox reaction is the combination of hydrogen with oxygen to form water:

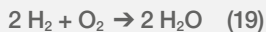

The hydrogen is oxidized and the oxygen is reduced.





## 13.3 DIN Saturated Oxygen Concentration Tables

As discussed in Chapter 6, the values of the saturated oxygen concentration at different temperatures and different pressures play an important role in the calibration of dissolved oxygen analysis. However, there is no calculation that determines these values; they must be established through empirical studies.

Because the saturated oxygen concentration in water depends on atmospheric pressure and temperature, samples of air-saturated water at stable air pressure and at various temperatures must be produced and their oxygen concentration determined. This is normally done by an iodometric Winkler titration in a laboratory. Various Saturated oxygen concentration tables exist with slightly varying values. In Europe the DIN 38 408 table (Table A1, page 66), published by the Deutsche Industrie Norm (German Industrial Standard), is generally used.

Because the DIN Saturated Oxygen Concentration Table is based on only one atmospheric pressure value (101.3 kPa), a calculation is required to establish the saturated oxygen concentration at the actual atmospheric pressure. The formula for this calculation is:

$$C_{O_2(P_{air})} = \frac{(P_{air} - P_{water})}{(P_N - P_{water})} \cdot C_{O_2(P_N)} \quad (20)$$

where:

$C_{O_2(P_{air})}$  = Saturated oxygen concentration at actual atmospheric pressure (mg/l)

$C_{O_2(P_N)}$  = Saturated oxygen concentration at standard atmospheric pressure (mg/l) from the table

$P_{air}$  = Actual atmospheric pressure (kPa)

$P_{water}$  = Partial water pressure (kPa from table 3)

$P_N$  = Standard atmospheric pressure (1 atm or 101.3 kPa)

Example: What is the saturated oxygen concentration at an actual atmospheric pressure of 96.2 kPa and a temperature of 20°C?

$$\begin{aligned} C_{O_2(P_{air})} &= \frac{(P_{air} - P_{water})}{(P_N - P_{water})} C_{O_2(P_N)} \\ &= \frac{96.2 - 2.33}{101.3 - 2.33} \cdot 9.08 \\ &= 8.61 \text{ mg/l} \end{aligned}$$

Table A1. DIN 38 408 (1986) Saturated Oxygen Concentration Table

$\alpha$ in°C	.00	.10	.20	.30	.40	.50	.60	.70	.80	.90
0	14.64	14.60	14.55	14.51	14.47	14.43	14.39	14.35	14.31	14.27
1	14.23	14.19	14.15	14.10	14.06	14.03	13.99	13.95	13.91	13.87
2	13.83	13.79	13.75	13.71	13.68	13.64	13.60	13.56	13.52	13.49
3	13.45	13.41	13.38	13.34	13.30	13.27	13.23	13.20	13.16	13.12
4	13.09	13.05	13.02	12.98	12.95	12.92	12.88	12.85	12.81	12.78
5	12.75	12.71	12.68	12.65	12.61	12.58	12.55	12.52	12.48	12.45
6	12.42	12.39	12.36	12.32	12.29	12.26	12.23	12.20	12.17	12.14
7	12.11	12.08	12.05	12.02	11.99	11.96	11.93	11.90	11.87	11.84
8	11.81	11.78	11.75	11.72	11.69	11.67	11.64	11.61	11.58	11.55
9	11.53	11.50	11.47	11.44	11.42	11.39	11.36	11.33	11.31	11.28
10	11.25	11.23	11.20	11.18	11.15	11.12	11.10	11.07	11.05	11.02
11	10.99	10.97	10.94	10.92	10.89	10.87	10.84	10.82	10.79	10.77
12	10.75	10.72	10.70	10.67	10.65	10.63	10.60	10.58	10.55	10.53
13	10.51	10.48	10.46	10.44	10.41	10.39	10.37	10.35	10.32	10.30
14	10.28	10.26	10.23	10.21	10.19	10.17	10.15	10.12	10.10	10.08
15	10.06	10.04	10.02	9.99	9.97	9.95	9.93	9.91	9.89	9.87
16	9.85	9.83	9.81	9.70	9.76	9.74	9.72	9.70	9.68	9.66
17	9.64	9.62	9.60	9.58	9.56	9.54	9.53	9.51	9.49	9.47
18	9.45	9.43	9.41	9.39	9.37	9.35	9.33	9.31	9.30	9.28
19	9.26	9.24	9.22	9.20	9.19	9.17	9.15	9.13	9.11	9.09
20	9.08	9.06	9.04	9.02	9.01	8.99	8.97	8.95	8.94	8.92
21	8.90	8.88	8.87	8.85	8.83	8.82	8.80	8.78	8.76	8.75
22	8.73	8.71	8.70	8.68	8.66	8.65	8.63	8.62	8.60	8.58

Continued on page 67.

Table A1. DIN 38 408 (1986) Saturated Oxygen Concentration Table (Continued)

$\alpha$ in°C	.00	.10	.20	.30	.40	.50	.60	.70	.80	.90
23	8.57	8.55	8.53	8.52	8.50	8.49	8.47	8.46	8.44	8.42
24	8.41	8.39	8.38	8.36	8.35	8.33	8.32	8.30	8.28	8.27
25	8.25	8.24	8.22	8.21	8.19	8.18	8.16	8.15	8.14	8.12
26	8.11	8.09	8.08	8.06	5.05	8.03	8.02	8.00	7.99	7.98
27	7.96	7.95	7.93	7.92	7.90	7.89	7.88	7.86	7.85	7.83
28	7.82	7.81	7.79	7.78	7.77	7.75	7.74	7.73	7.71	7.70
29	7.69	7.67	7.66	7.65	7.63	7.62	7.61	7.59	7.58	7.57
30	7.55	7.54	7.53	7.51	7.05	7.49	7.48	7.46	7.45	7.44
31	7.42	7.41	7.40	7.39	7.37	7.36	7.35	7.34	7.32	7.31
32	7.30	7.29	7.28	7.26	7.25	7.24	7.23	7.21	7.20	7.19
33	7.18	7.17	7.15	7.14	7.13	7.12	7.11	7.09	7.08	7.07
34	7.06	7.05	7.04	7.02	7.01	7.00	6.99	6.98	6.97	6.96
35	6.94	6.93	6.92	6.91	6.90	6.89	6.88	6.87	6.85	6.84
36	6.83	6.82	6.81	6.80	6.79	6.78	6.77	6.75	6.74	6.73
37	6.72	6.71	6.70	6.69	6.68	6.67	6.66	6.65	6.64	6.63
38	6.61	6.60	6.59	6.58	6.57	6.56	6.55	6.54	6.53	6.52
39	6.51	6.50	6.49	6.48	6.47	6.46	6.45	6.44	6.43	6.42
40	6.41	6.40	6.39	6.38	6.37	6.36	6.35	6.34	6.33	6.32











12:30

13:10

13:40

12:50

12:10

©2022 Hamilton Company. All rights reserved.  
All other trademarks are owned and/or registered by Hamilton Company in the U.S. and/or other countries.  
Lit. No. 10143807/00 — 02/2022

# HAMILTON®

Web: [www.hamiltoncompany.com](http://www.hamiltoncompany.com)  
USA: 800-648-5950  
Europe: +41-81-660-10-10

**Hamilton Americas & Pacific Rim**  
Hamilton Company Inc.  
4970 Energy Way  
Reno, Nevada 89502 USA  
Tel: +1-775-858-3000  
Fax: +1-775-856-7259  
[sales@hamiltoncompany.com](mailto:sales@hamiltoncompany.com)

**Hamilton Europe, Asia, & Africa**  
Hamilton Bonaduz A.G.  
Via Crusch 8  
CH-7402 Bonaduz, Switzerland  
Tel: +41-58-610-10-10  
[contact.pa.ch@hamilton.ch](mailto:contact.pa.ch@hamilton.ch)

To find a representative in your area, please visit [hamiltoncompany.com/contacts](http://hamiltoncompany.com/contacts).