

# C8888 Nanochemistry

Jiri Pinkas

Office C12/224

Phone 549496493

Email: [jpinkas@chemi.muni.cz](mailto:jpinkas@chemi.muni.cz)

Ph.D. level course

Prerequisite C7780 Inorganic Materials Chemistry

Course grading:

Select a topic concerning nanochemistry and prepare:

**Presentation** - 20 min (20 %)

**Written term paper** - min 7 pages (80 %)

Au nanoparticles



# **C8888 Nanochemistry Time Plan for Spring 2023**

## Lectures 1 – 4

- Think of a topic for your paper and send me a title
- Send me a 1-page abstract of your paper
- Final topic approval
- Study and work on your paper/presentation
- Hand in your term paper

## Presentations (C12-311)

# Nanoscopic Materials



- Chemical methods used to change physical and chemical properties – chemical composition, substituents, concentration, crystal structure....
- **Size is another variable** to change physical and chemical properties for constant chemical composition
- Each physical property or phenomenon has a **characteristic length**
- When particle size is comparable to the characteristic length, property starts to **depend on the size**

# Nanoscopic Scales

Atoms/ Molecules	Nanoscale Particles		Condensed Matter	
1	125	70,000	$6 \times 10^6$	$\infty$ N <sup>o</sup> Atoms
Quantum Chemistry	1	?	10	$\infty$ Diameter(nm) Solid State Physics

**Nanomaterials**

**1 – 100 nm**

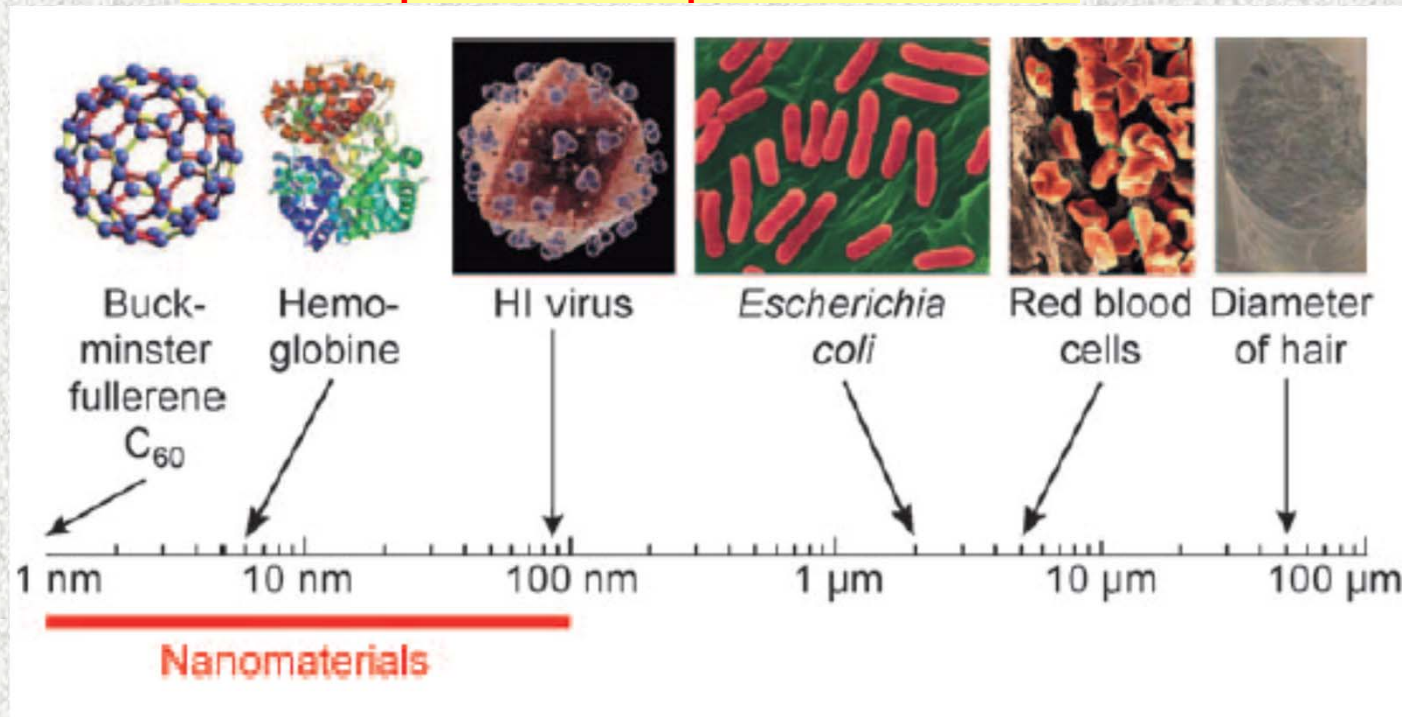

# Nanoscopic Scales

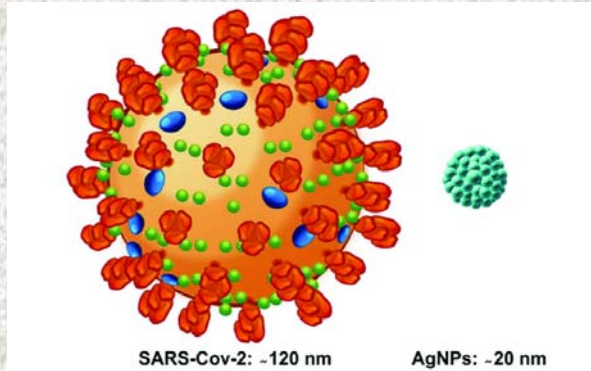

## Nanomaterials

1 – 100 nm

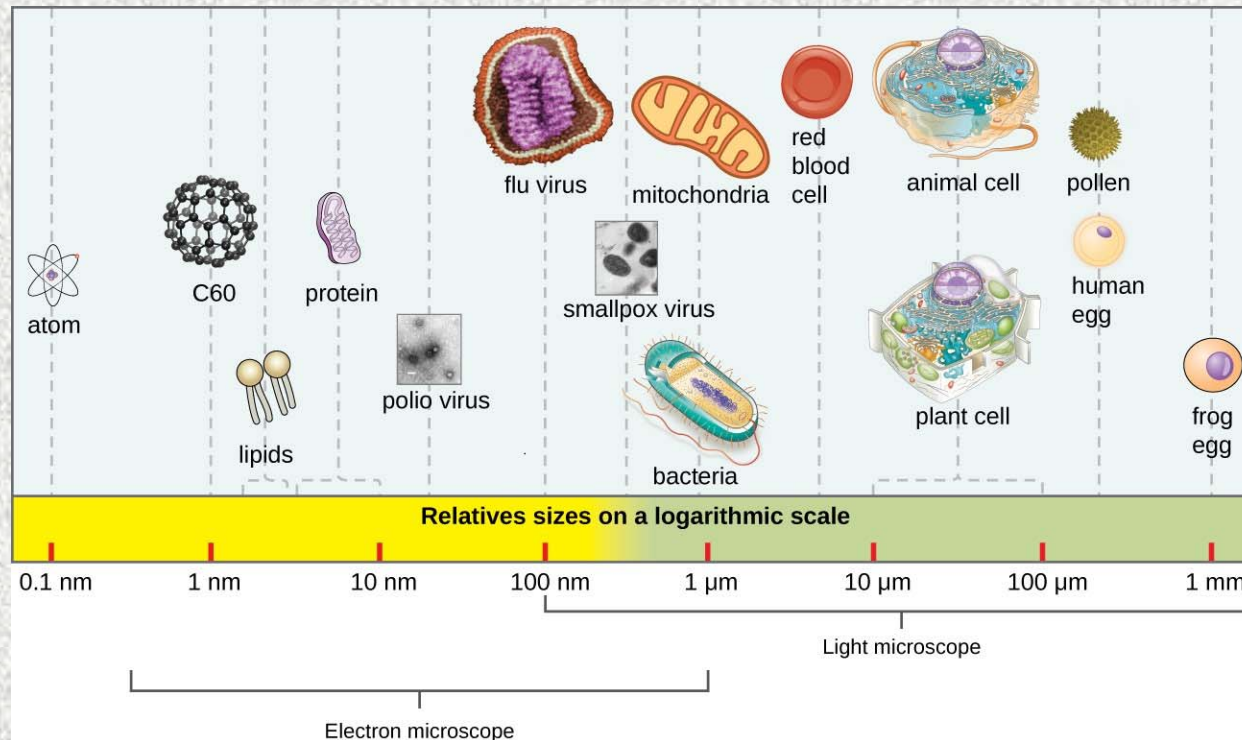

# Nanostructural Materials and Society

**“Prey”, the novel by Michael Crichton, author of “Jurassic Park”. The horrible beasts threatening humanity in this thriller are not giant dinosaurs, but swarms of minute “nanobots” that can invade and take control of human bodies.**

**A report issued by a Canadian environmental body called the action group on erosion, technology and concentration took a swipe at nanotechnology. It urged a ban on the manufacture of new nanomaterials until their environmental impact had been assessed. The group is better known for successfully campaigning against biotechnology, and especially against genetically modified crops.**

**The research, led by a group at the National Aeronautics and Space Administration's Johnson Space Centre in Houston, has found in preliminary studies that inhaling vast amounts of nanotubes is dangerous. Since they are, in essence, a form of soot, this is not surprising. But as most applications embed nanotubes in other materials, they pose little risk in reality.**

# Dictionary of Nano Terms

**Nanoscience** - fundamental scientific study of matter on the 1–100 nm scale, especially if the properties are distinct from those of bulk materials

**Nanotechnology** - the creation of functional materials, devices, and systems through control of matter on the nanometer length scale and the exploitation of novel properties and phenomena

**Nanochemistry** - study of chemical aspects of synthesis, properties and application of matter on the 1–100 nm scale

**Nanomaterials** - general term for materials (polymers, semiconductors, ceramics, oxides, metals, etc.) with particle sizes in the 1–100 nm range in at least one dimension

**Nanoparticles** (NPs) - nanomaterials that appear to be spherical, have similar sizes in all 3 dimensions

# Faraday's Work on Gold Nanoparticles 1856

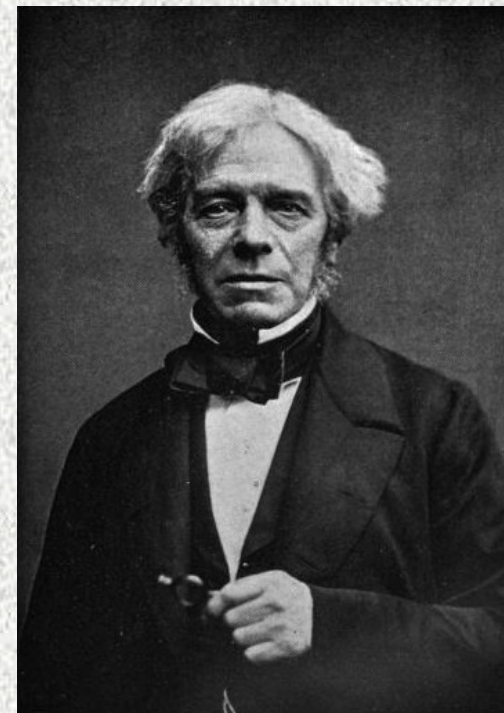
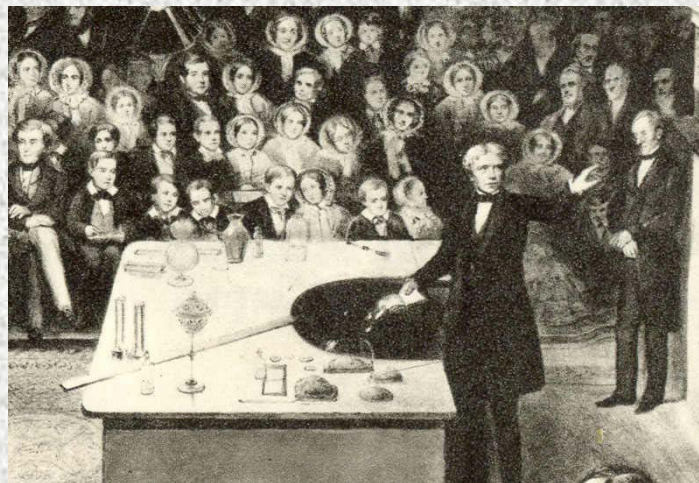

Typical Faraday discourse in the Royal Institution in London

M. Faraday, *Philos. Trans. R. Soc. London*, 147, 145, 1857

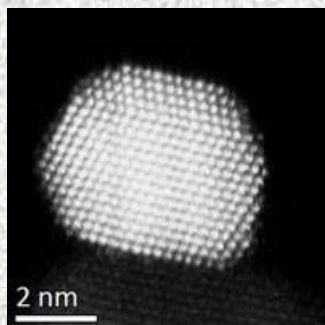

HRTEM image of gold NP

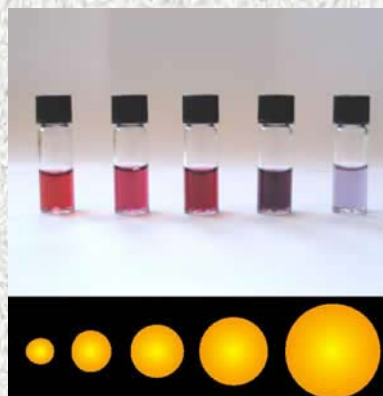

Gold nanoparticles 10-24 nm



# Transmission Electron Microscopy (TEM)

prozařovací

1930 Knoll a Ruska

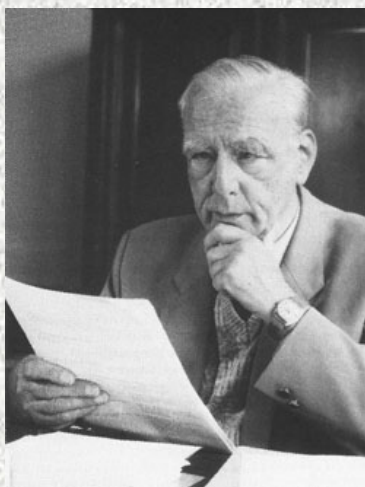

Ernst Ruska  
Nobel Prize in  
Physics 1986

$\text{SrTiO}_3$

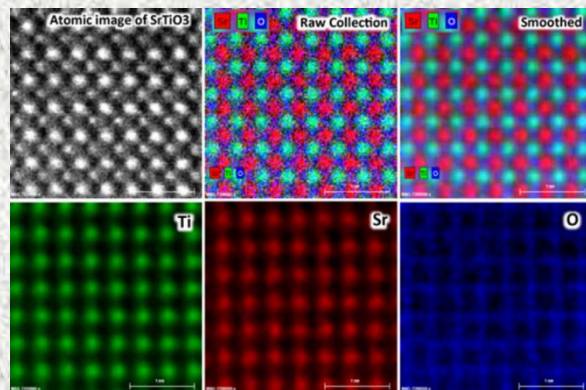

Gold nanoparticle in different tilt angles

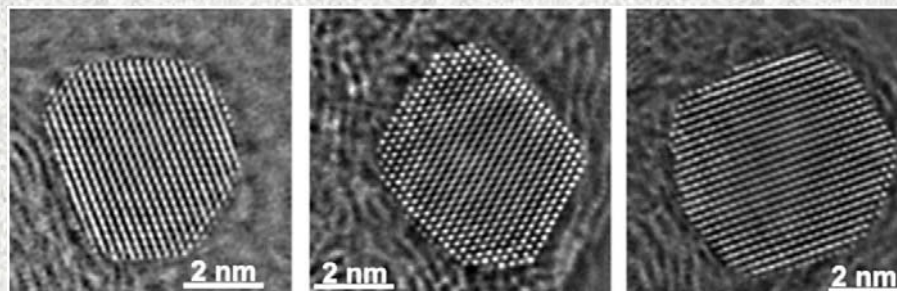

# Transmission Electron Microscopy (TEM)

In situ real-time liquid cell electron microscopy

HAADF-STEM images

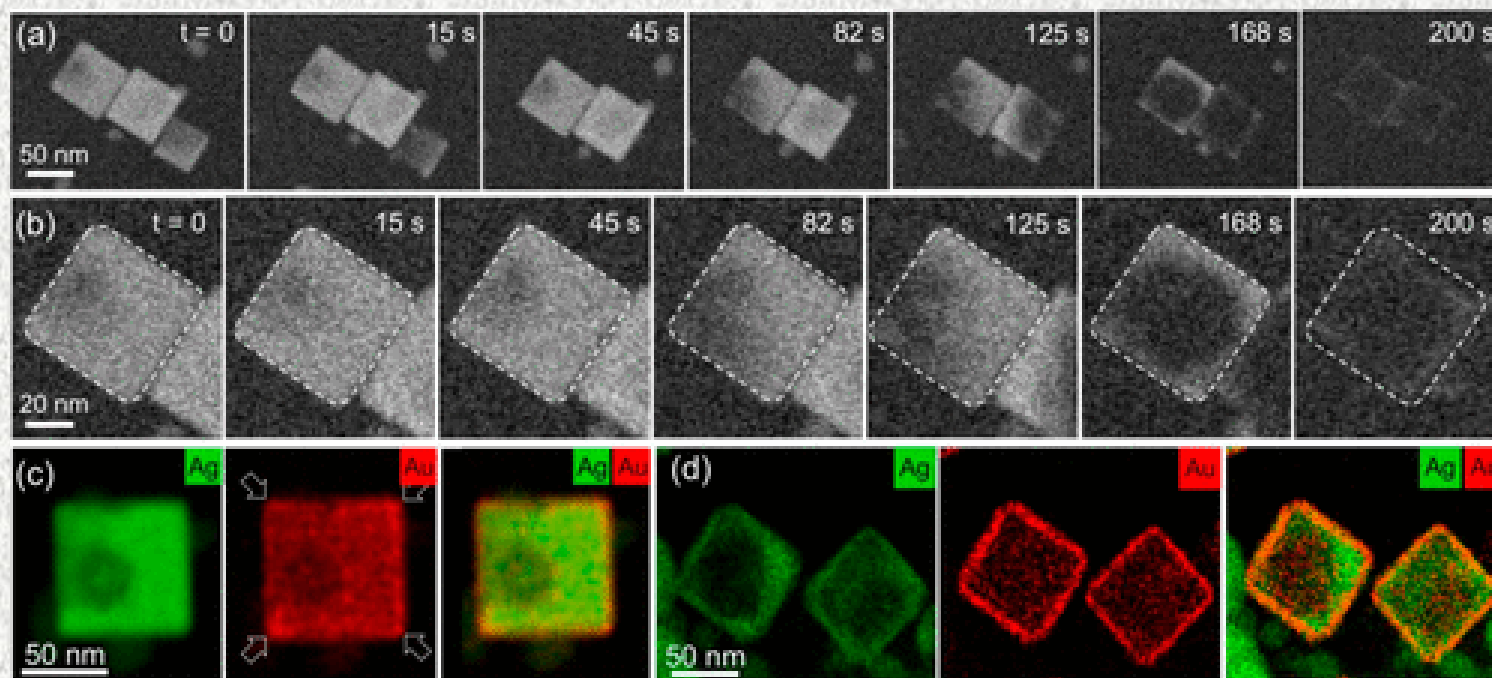

EDS chemical maps

Au–Ag galvanic replacement:  $[\text{AuCl}_4]^- + 3 \text{Ag}^0 (\text{s}) \rightarrow \text{Au}^0 (\text{s}) + 3 \text{AgCl} (\text{s}) + \text{Cl}^-$

$\text{H}_2\text{SO}_4$  added to pH = 2.5 to suppress reduction of  $[\text{AuCl}_4]^-$  to  $\text{Au}^0$  by radicals generated by radiolysis of water by the high-energy imaging electron beam

# Scanning Electron Microscopy (SEM)

rastrovací /řádkovací

1942 Zworykin, Hiller, Snyder

SEM is a surface imaging method in which the incident electron beam scans across the sample surface and interacts with the sample to generate **backscattered** and **secondary** electrons that are used to create an image of the sample

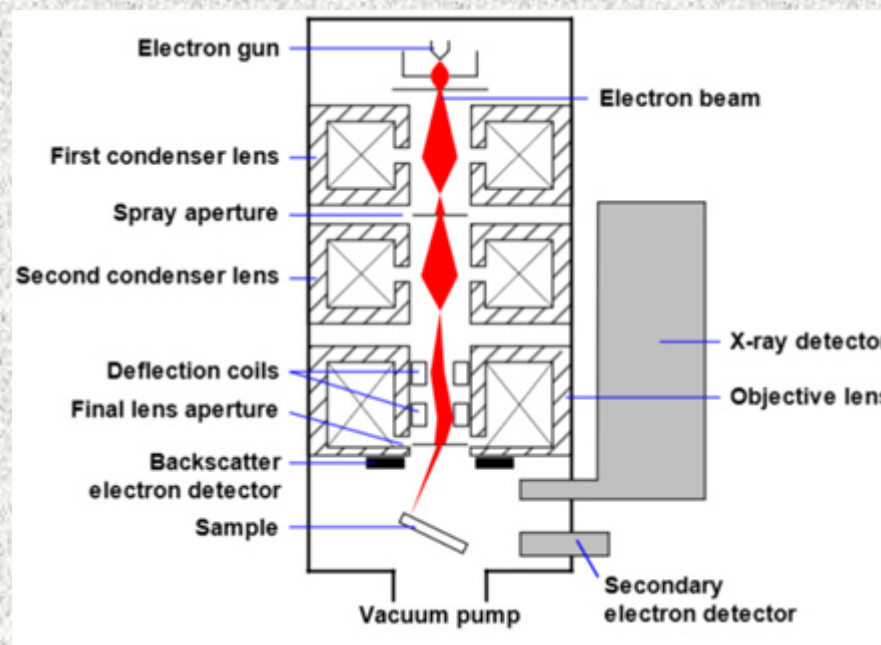

# Scanning Tunelling Microscopy (STM)

1982 Binnig and Rohrer

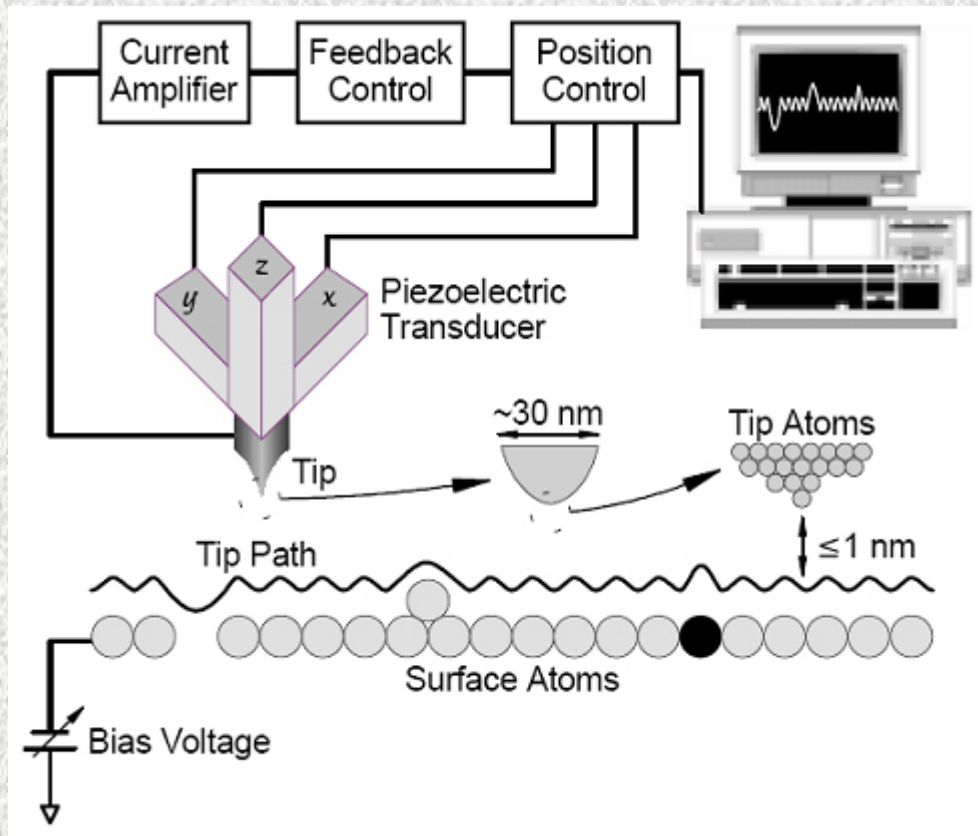

Binnig and Rohrer  
Nobel Prize 1986

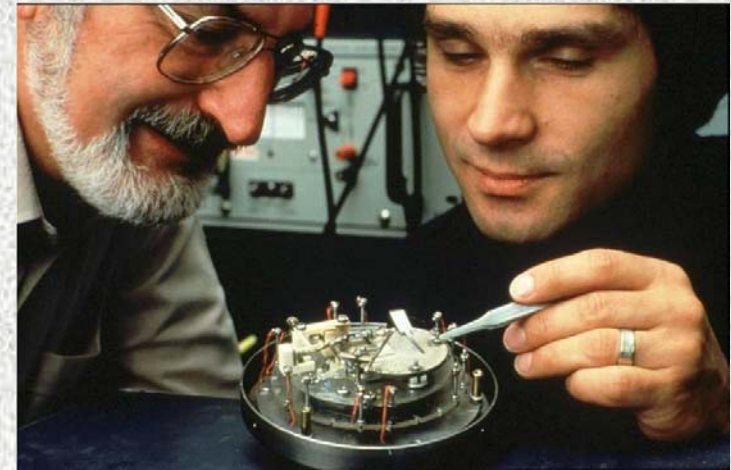

# Nanoscale Writing

## Manipulation atom-by-atom

1989 STM positioned Xe atoms on Ni (110) crystal at 4 K, 5 nm letters

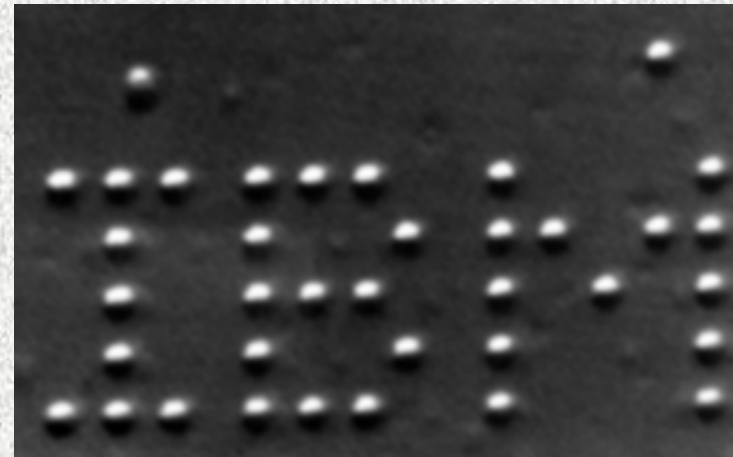
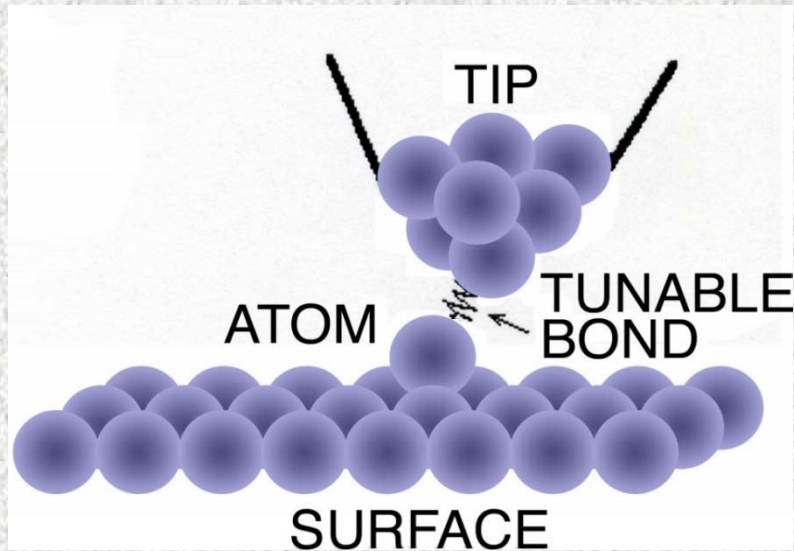

40 x 40 Å constant-current STM image of Xe adsorbed on Ni(110) the tip biased +0.020 V relative to the sample, a tunneling current of  $1 \times 10^{-9}$  A  
Xe appears as a  $1.53 \pm 0.02$  Å high protrusion  
Covalent radius 140 pm  
Van der Waal radius 216 pm

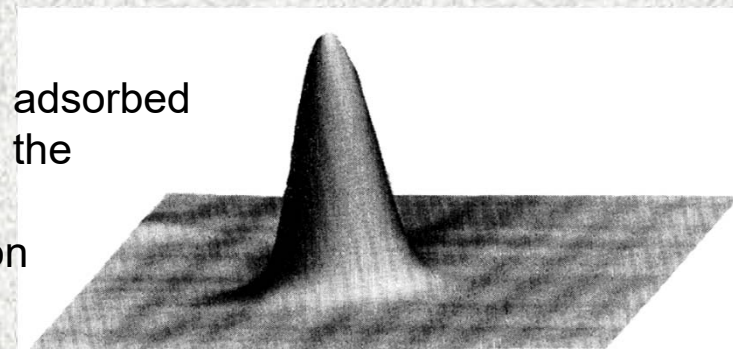

# Atomic Force Microscopy (AFM)

1986 Binnig, Quate, and Gerber

AFM is a method allowing a variety of non-conducting surfaces to be imaged and characterized at the atomic level

The detection of forces between an observed sample surface and a sharp tip located at the end of a cantilever

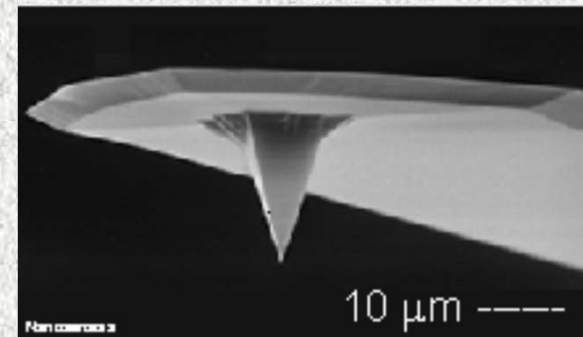
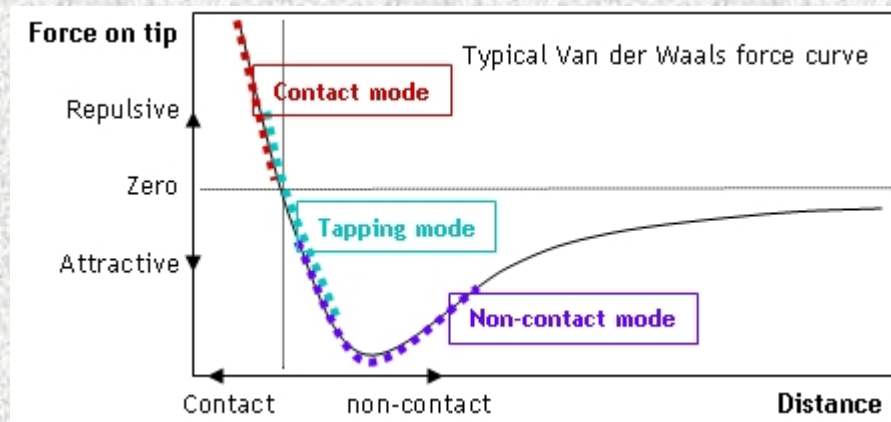

# Atomic Force Microscopy (AFM)

## *Atomic Force Microscopy (AFM) :* General Components and Their Functions

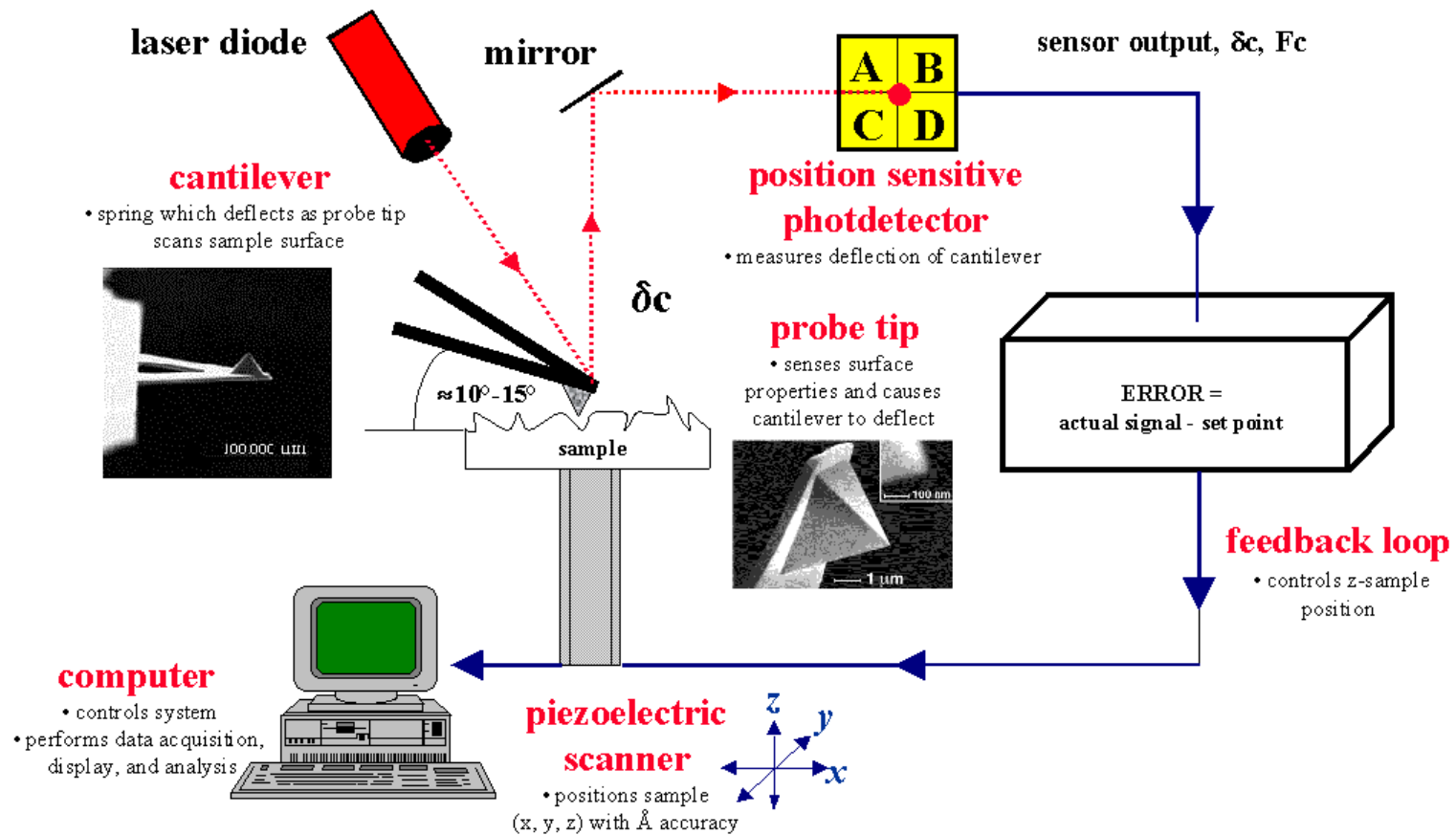

# Nanoscale Writing

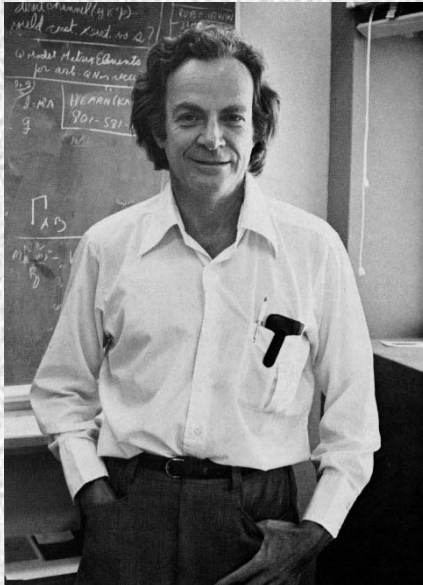

**Richard Feynman**  
**(1918–1988)**  
**NP in Physics 1965**

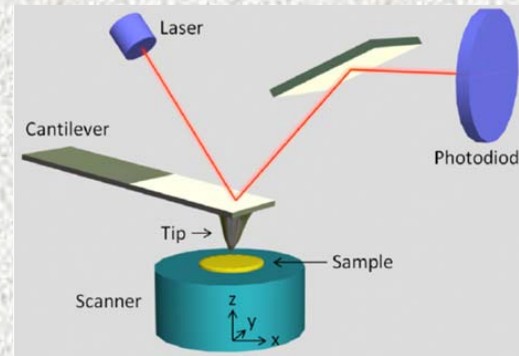

**“There’s Plenty of Room at the Bottom”**

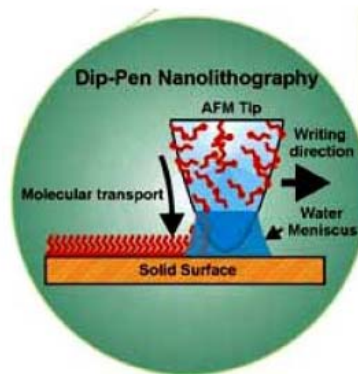

Nanoscale writing with an  
AFM (Mirkin et al.)

As soon as I mention this, people tell me about miniaturization, and how far it has progressed today. They tell me about electric motors that are the size of the nail on your small finger. And there is a device on the market, they tell me, by which you can write the Lord's Prayer on the head of a pin. But that's nothing; that's the most primitive, halting step in the direction I intend to discuss. It is a staggeringly small world that is below. In the year 2000, when they look back at this age, they will wonder why it was not until the year 1960 that anybody began seriously to move in this direction.

Richard P. Feynman, 1960



# **Applications of Nanomaterials**

**Small size - can be manipulated like molecules, made by chemical reactions in solutions, injected into biological systems, self-assembled into structures, superior lithographic resolution, negligible light scattering**

**Intense optical absorbance and emission properties - surface plasmon resonance, photothermal therapy, biosensing**

**Quantum size effects - band gap engineering, information technology, storage media, quantum dot-sensitized solar cells**

**High surface area - catalysts, adsorbents, energy storage, composites, molecules on the surfaces are at high local concentrations yet low in “global” concentrations, interaction of NPs with biomolecules**

**Surface modifications - functionalized with small organics or polymers, the optical/electronic/bio properties of the inorganic core<sup>17</sup> can be tuned, targeted drug delivery**

# The Nano-Family

At least one dimension is between 1 - 100 nm

0-D structures (3-D confinement):

- Quantum dots
- Nanoparticles

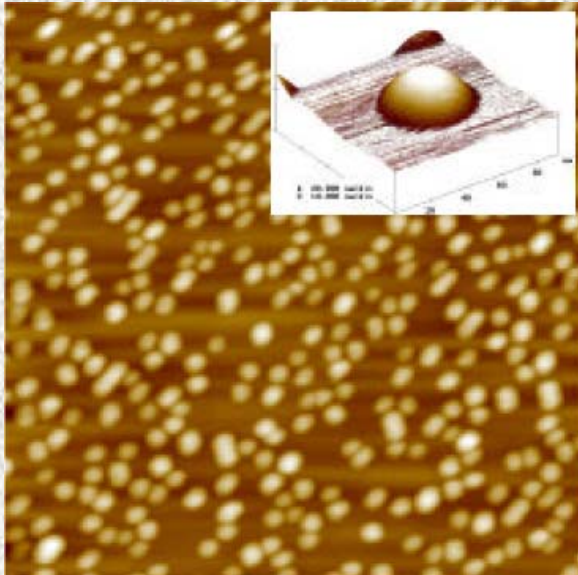

AFM 1  $\mu\text{m}$  x 1  $\mu\text{m}$   
InAs on GaAs/InP

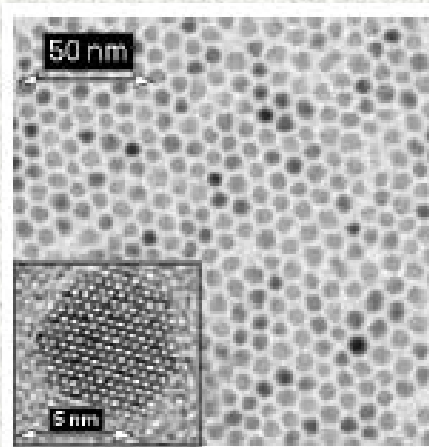

CdTe nanoparticles

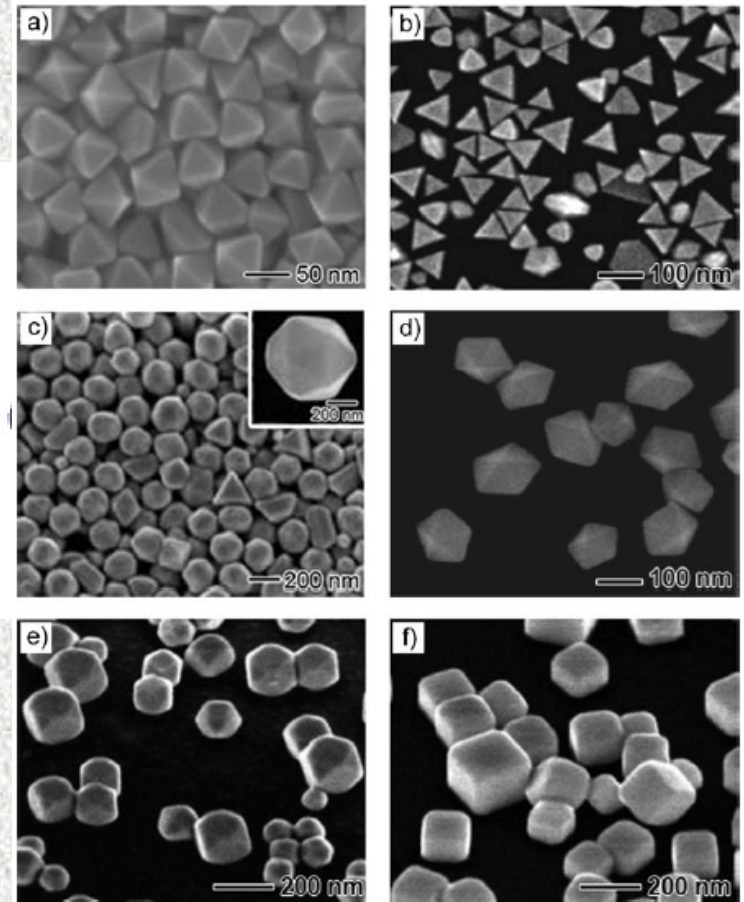

Au nanoparticles

# The Nano-Family

## 1-D structures (2-D confinement):

- Nanowires
- Nanorods
- Nanotubes
- Nanofibers
- Nanowhiskers

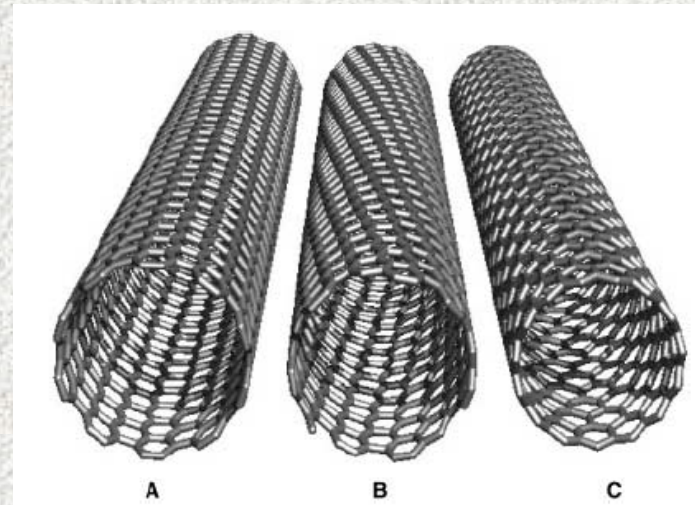
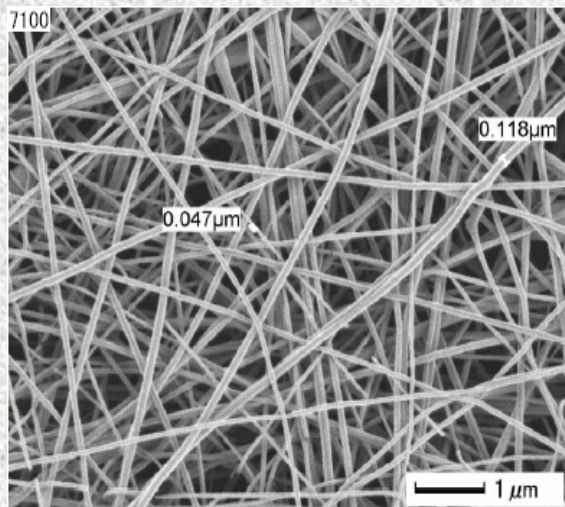
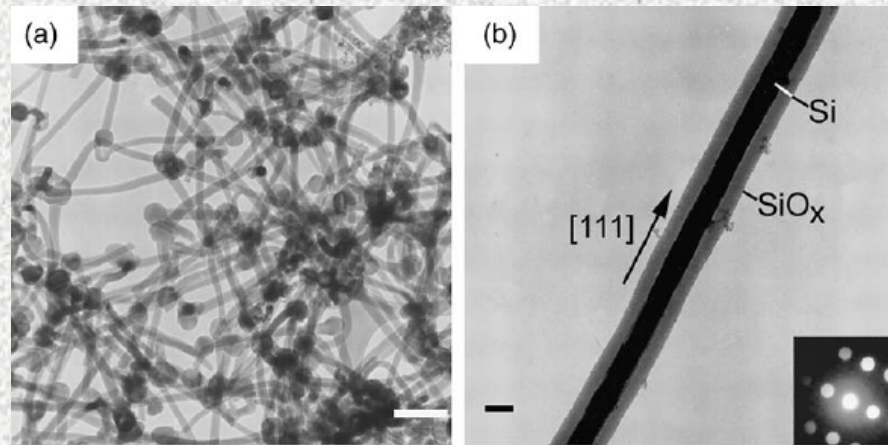

# The Nano-Family

## 2-D structures (1-D confinement):

- Thin films - CVD, ALD
- Planar quantum wells
- Superlattices
- Graphene
- SAM

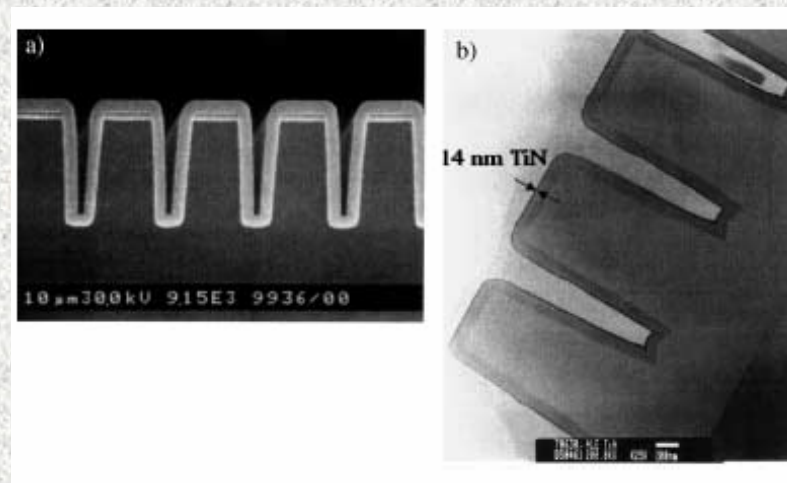
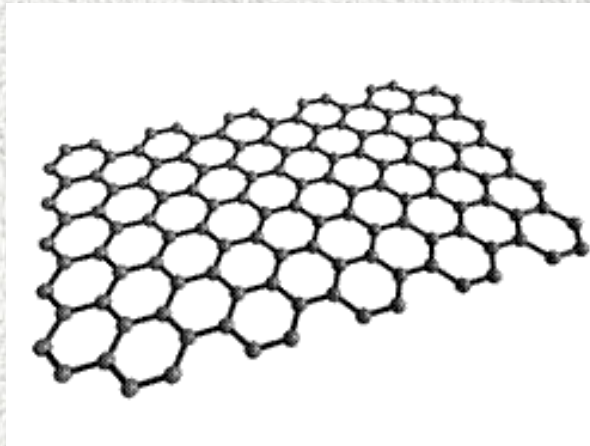
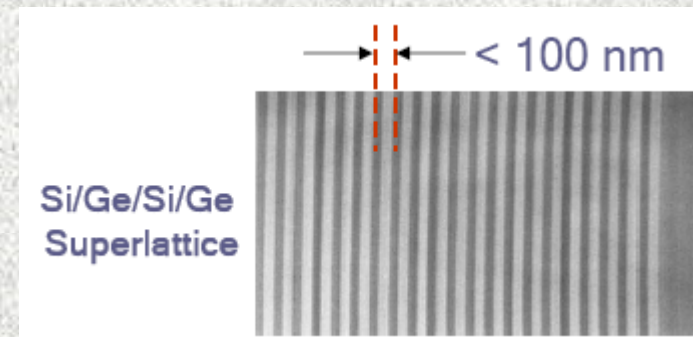

# Coherence Length, $d$

Scherrer equation

$$d = \frac{k\lambda}{\beta \cos \theta}$$

$k = 0.89$ ,  $\lambda =$  wavelength,  
 $\beta =$  full width at half-maximum of  
a standard (Si)

XRD patterns of iron oxide nanocrystals  
of 4, 6, 8, 9, 10, 11, 12, 13, and 15 nm

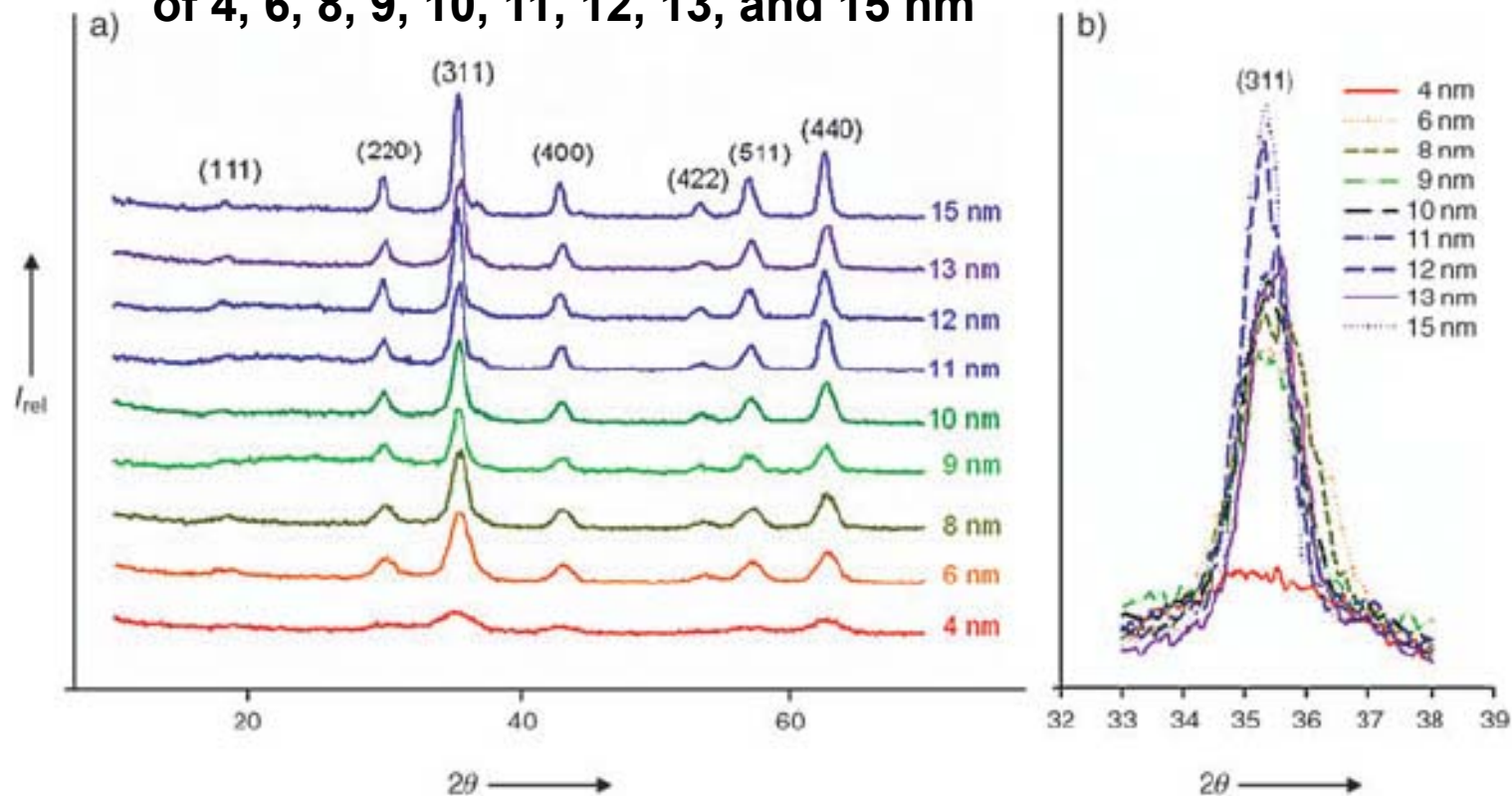

# Nanoscopic Behavior of Materials

Differences between bulk and nanoscale materials

- **Surface Effects**
- **Quantum Confinement Effects**

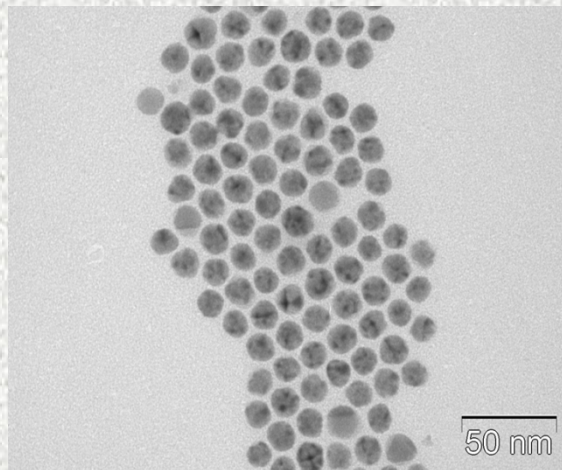

# Surface Effects

Decreasing grain size = Increasing volume fraction of grain boundaries (50% for 3 nm particles)

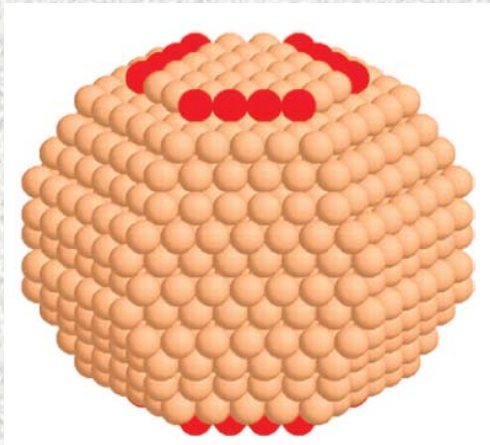

Ru particle  
diameter 2.9 nm

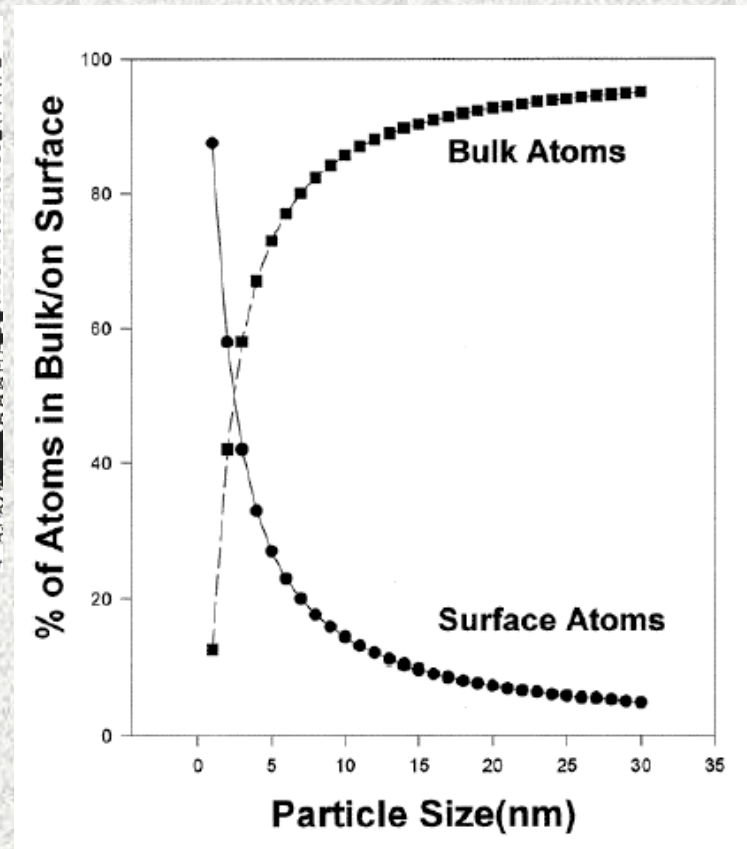
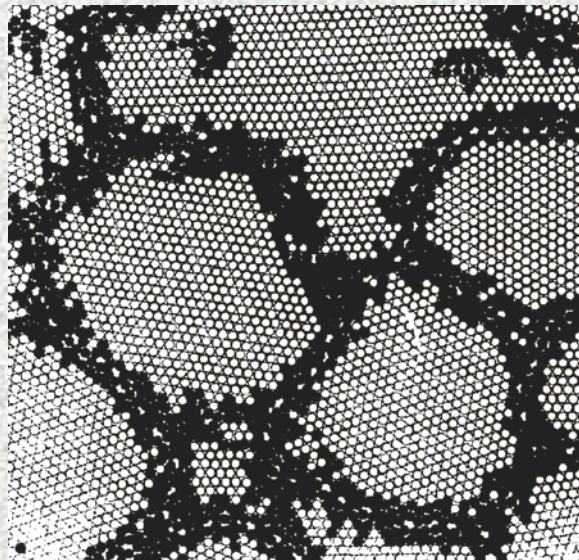

# Surface Effects

**Dispersion F = the fraction of atoms at the surface**

**F is proportional to surface area divided by volume**

**N = total number of atoms**

**$V \sim r^3 \sim N$**

$$F \approx \frac{r^2}{r^3} \approx \frac{1}{r} \approx \frac{1}{\sqrt[3]{N}}$$

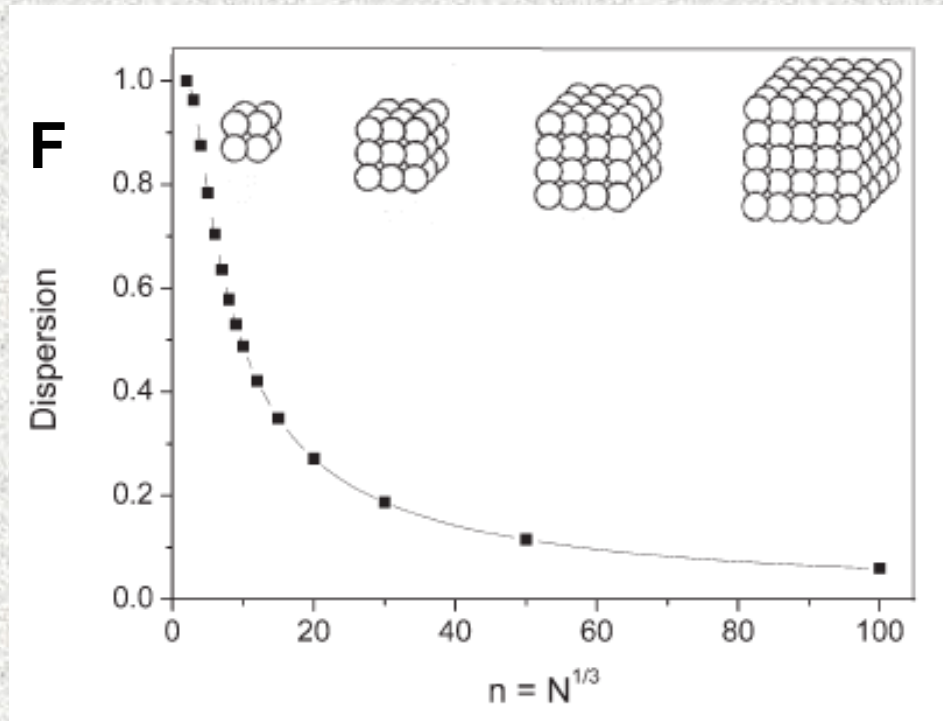

**n = number of atoms at the cube edge**



# Surface Effects

## Properties of grain boundaries

- Lower coordination number of atoms
- Reduced atomic density (by 10–30 %)
- Broad spectrum of interatomic distances

## Experimental evidence

- HREM
- EXAFS, reduced number of nearest and next-nearest neighbors
- Raman spectroscopy
- Mössbauer spectroscopy, quadrupole splitting distribution broadened
- Diffusivity enhanced by up to 20 orders of magnitude !!
- Solute solubility in the boundary region

Ag (fcc) and Fe (bcc) immiscible in (s) or (l), but do form solid solution as nanocrystalline alloy

- EPR, nano-Si gives a sharp signal

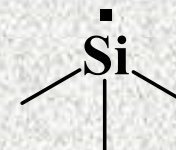
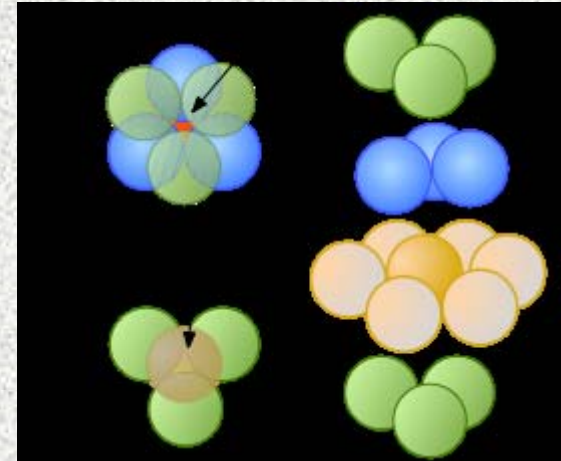

# Surface Effects

## Atoms at surfaces

- fewer neighbors than atoms in the bulk  
= lower coordination number
- stronger and shorter bonds
- unsatisfied bonds - dangling bonds
- surface atoms are less stabilized than bulk atoms

The smaller a particle, the larger the fraction of atoms at the surface, and the higher the average binding energy per atom

The melting and other phase transition temperatures scale with surface-to-volume ratio and with the inverse size

Example: the melting point depression in nanocrystals

2.5 nm Au particles 930 K

bulk Au 1336 K

# Dangling Bonds

- Empty orbital
- 1-e orbital
- 2-e orbital

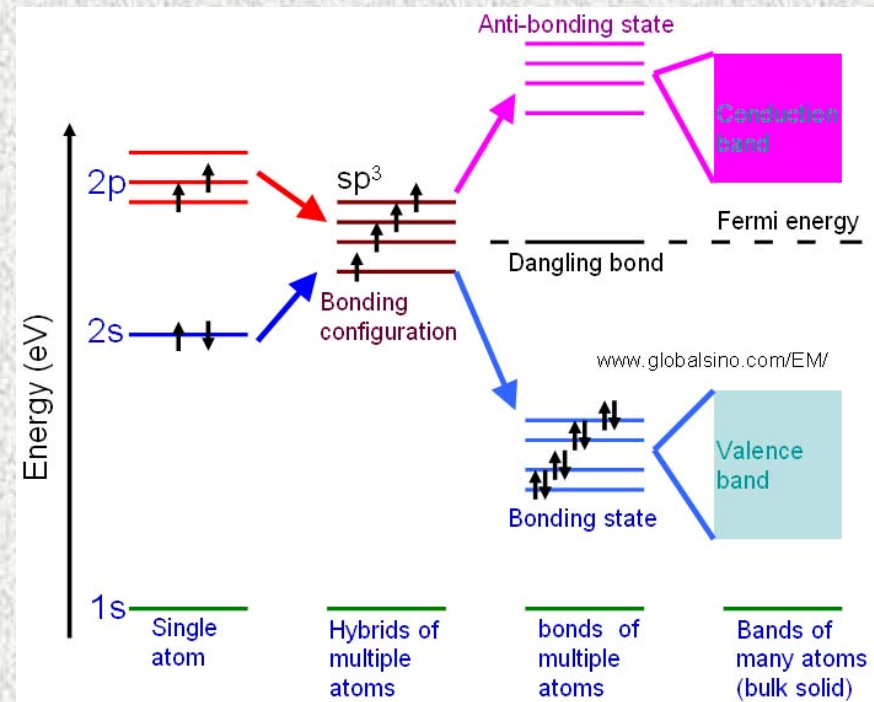
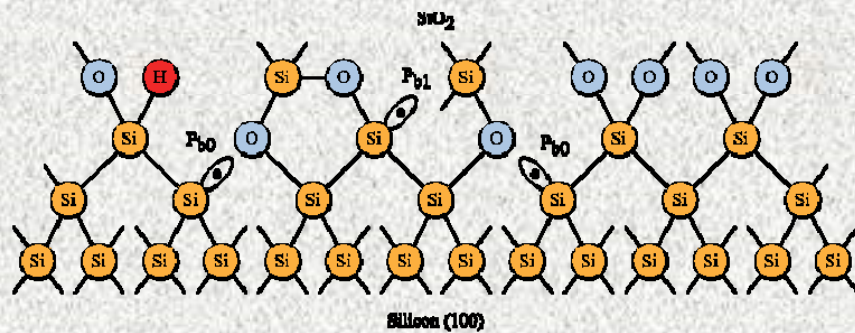
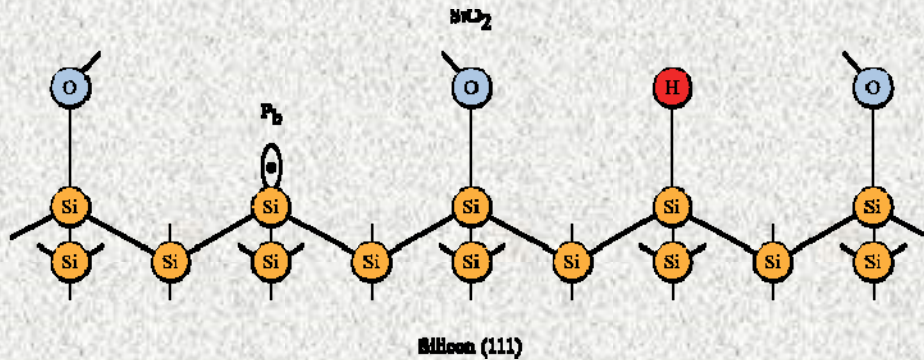

## Surface Effects

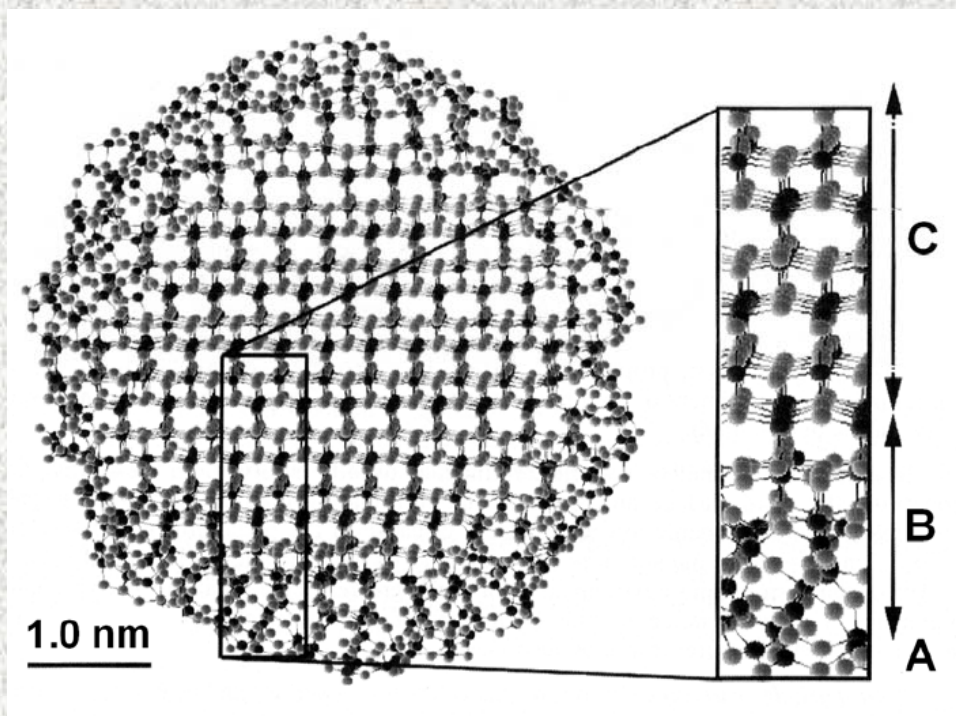

**A = Atoms at surfaces (one layer) – fewer neighbors, lower coordination, unsatisfied (dangling) bonds**

**B = Atoms close to surface (several layers) – deformation of coordination sphere, distorted bond distances and angles**

**C = Bulk atoms, regular ordering – not present in particles below 2 nm**

# Shape Factor, $\alpha$

**Shape Factor = the ratio between a surface area of a non-spherical particle with that of a spherical one**

Polyhedron	A	V	A/V	dA/dV	$\alpha$
Tetrahedron	$\sqrt{3}a^2$	$(\sqrt{2}/12)a^3$	$6\sqrt{6}/a$	$4\sqrt{6}/a$	1,4900
Cube	$6a^2$	$a^3$	$6/a$	$4/a$	1,2407
Octahedron	$2\sqrt{3}a^2$	$(\sqrt{2}/3)a^3$	$3\sqrt{6}/a$	$2\sqrt{6}/a$	1,1826
Dodecahedron	$3\sqrt{(25 + 10\sqrt{5})}a^2$	$[(15 + 7\sqrt{5})/4]a^3$	$12\sqrt{(25 + 10\sqrt{5})}/(15 + 7\sqrt{5})a$	$8\sqrt{(25 + 10\sqrt{5})}/(15 + 7\sqrt{5})a$	1,0984
Icosahedron	$5\sqrt{3}a^2$	$[(15+5\sqrt{5})/12]a^3$	$12\sqrt{3}/(3+\sqrt{5})a$	$8\sqrt{3}/(3+\sqrt{5})a$	1,0645

# Surface Effects

What is the bulk value?

Mean coordination number

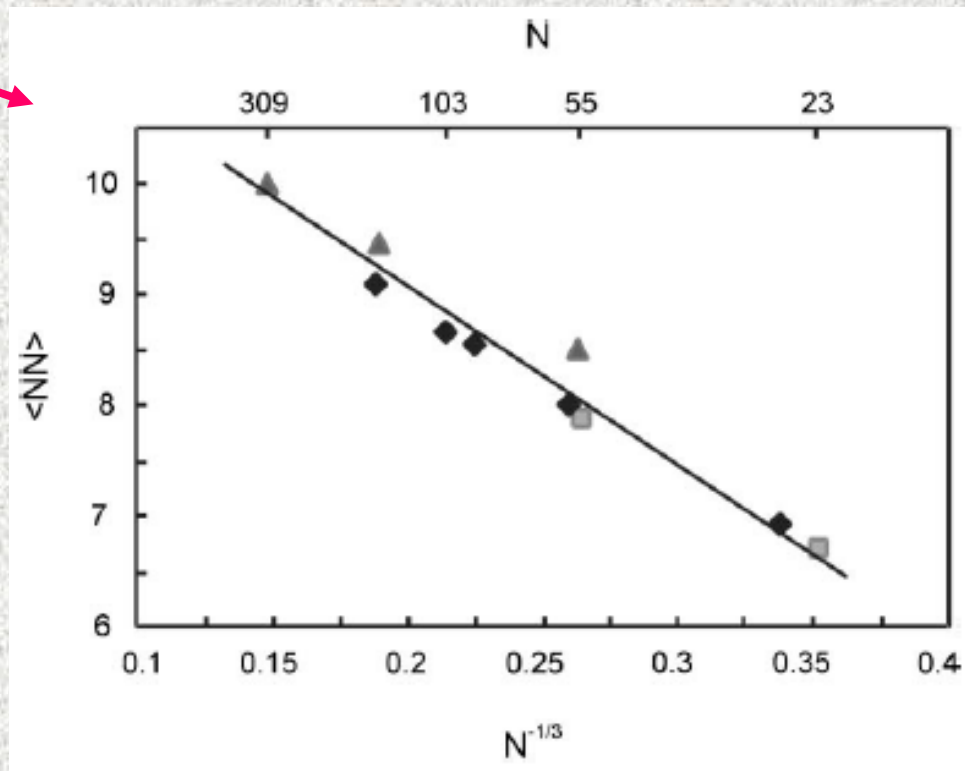





Calculated mean coordination number  $\langle NN \rangle$  as a function of inverse radius, represented by  $N^{-1/3}$  for Mg clusters (triangles = icosahedra, squares = decahedra, diamonds = hcp)

# Surface Effects

**Atom binding (vaporization) energies lower in nanoparticles, fewer neighbors to keep atoms from escaping**

**Plasticity of nanocrystalline ceramics**

Full-shell "magic number" clusters					
Number of shells	1	2	3	4	5
Number of atoms in cluster	13	55	147	309	561
Percentage of surface atoms	92	76	63	52	45

# Surface Effects in Alloys

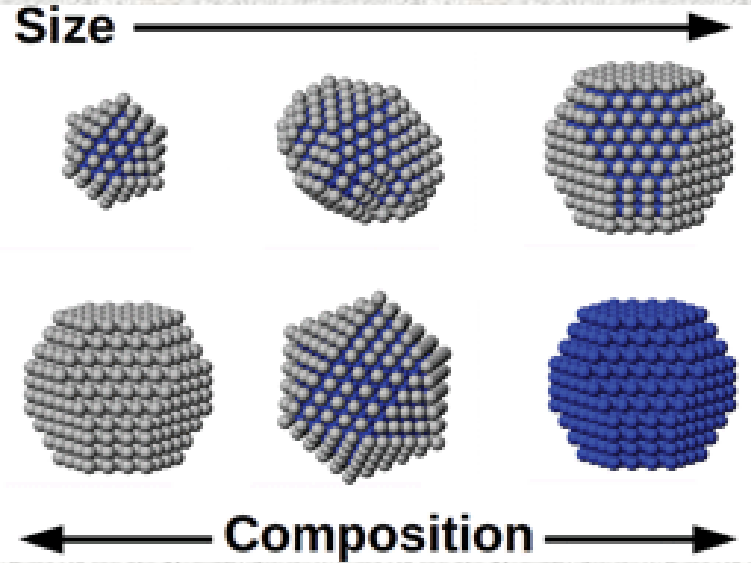

Alloys:

- Core-shell
- Janus
- Random mixture
- Intermetallics

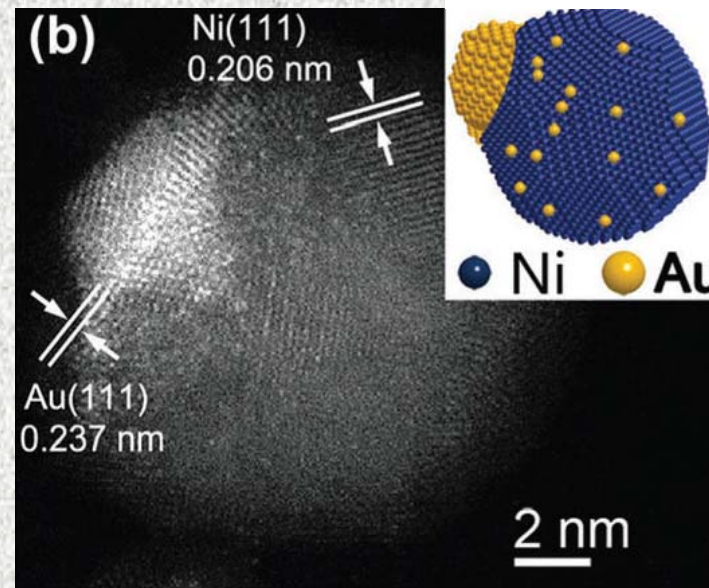
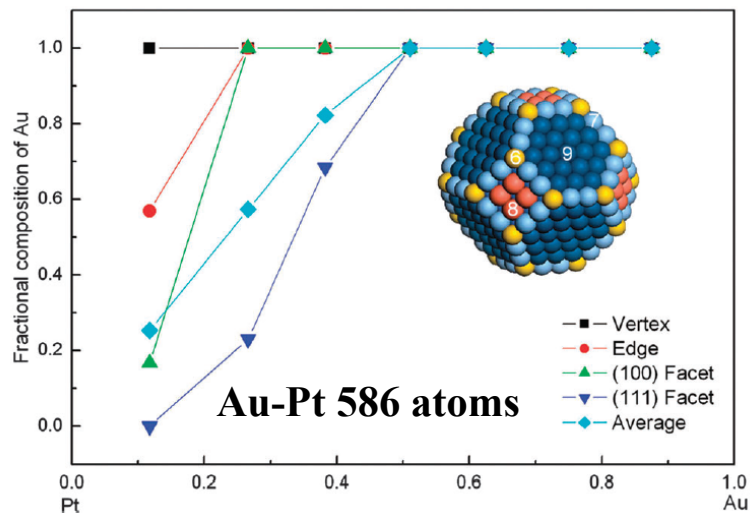
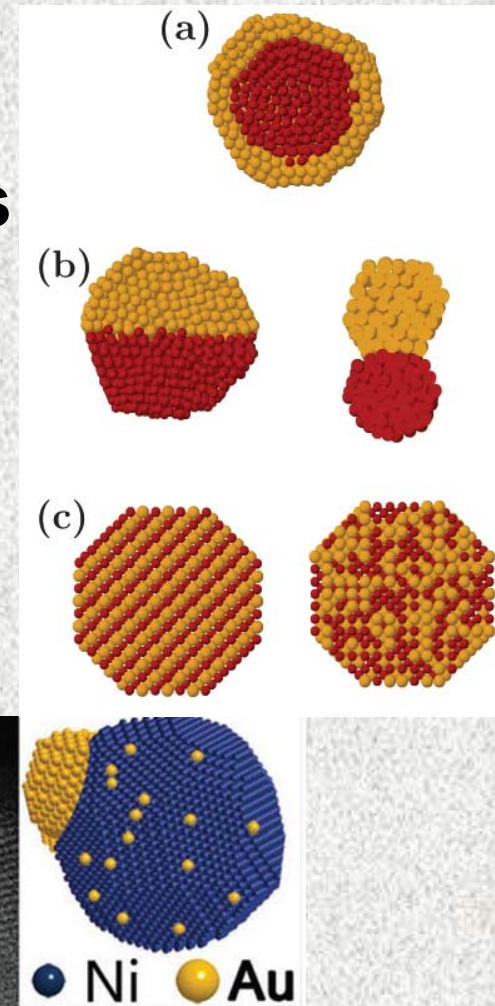



# Surface Effects in Alloys

Alloys:

- Core-shell
- Janus
- Random mixture – solid solution
- Intermetallics

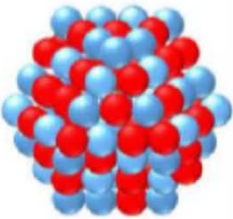
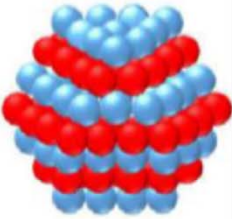
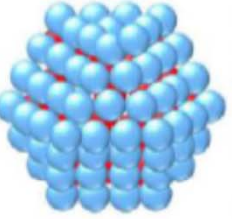
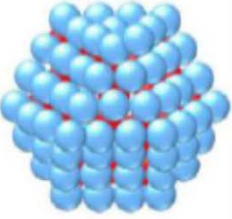
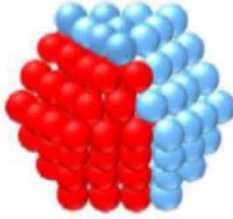
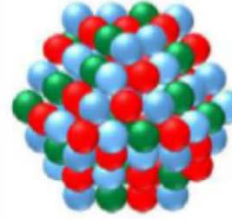
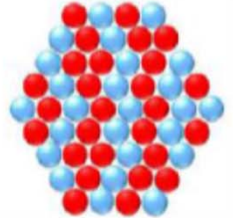
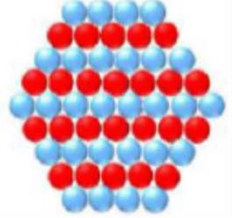
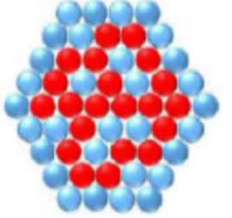
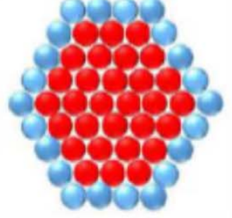
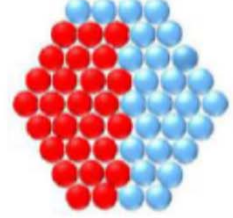
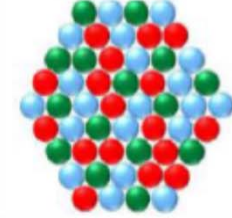
	Binary solid solution	intermetallic	dealloyed	core shell	Janus-like	Ternary solid solution
nanoparticle						
Cross section						

# Transmission Electron Microscopy

# Energy Dispersive X-ray Spectroscopy

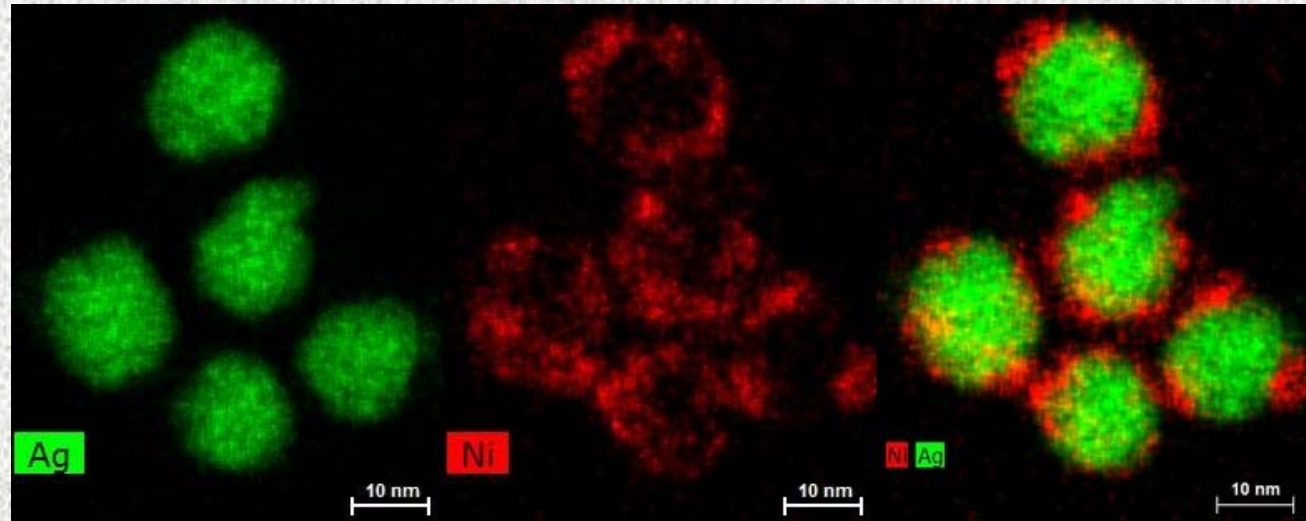

ICP-OES: Ag 68.8 mol%, EDS: Ag 84.2 mol%

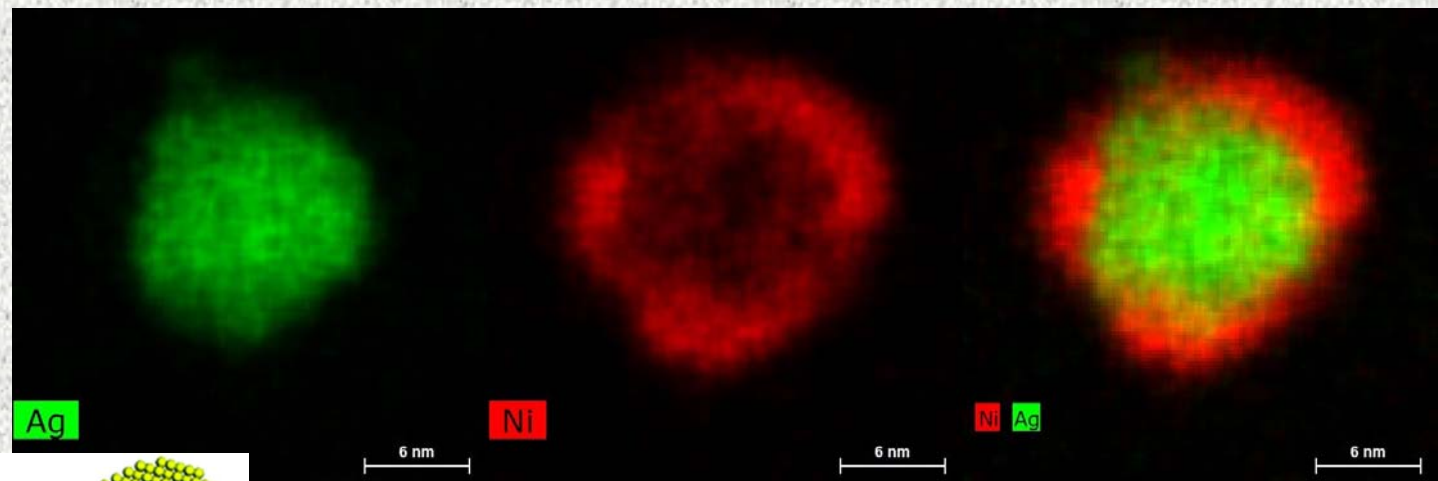

ICP-OES: Ag 50.3 mol%, EDS: Ag 62.5 mol%

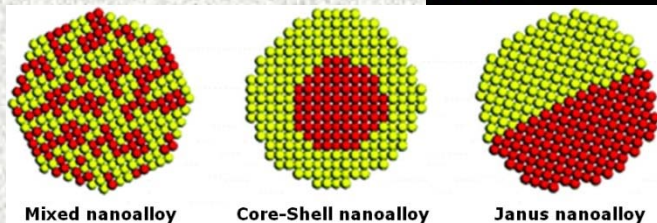

# Effects of Synthesis

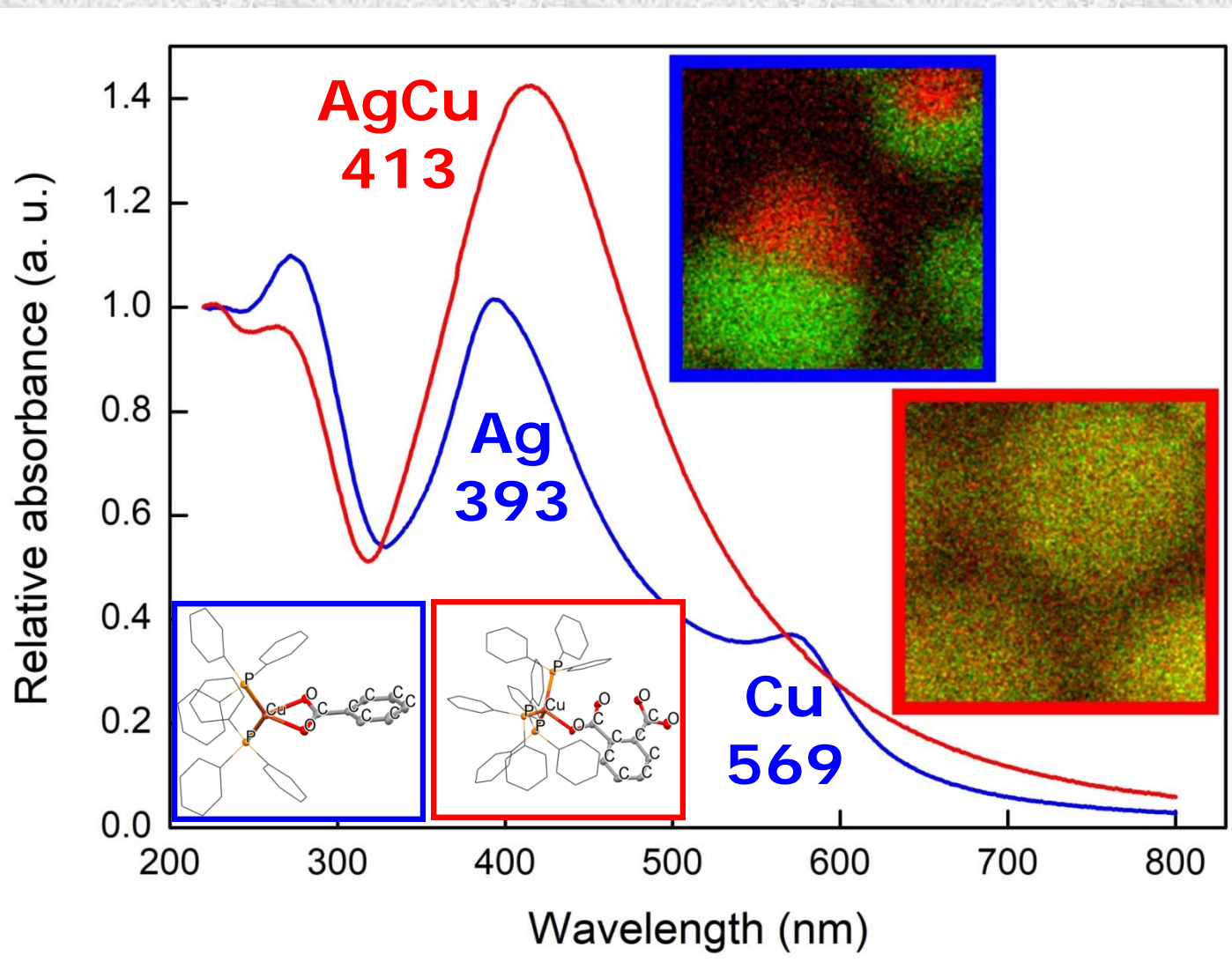

# Localized Surface Plasmon Resonance (LSPR)

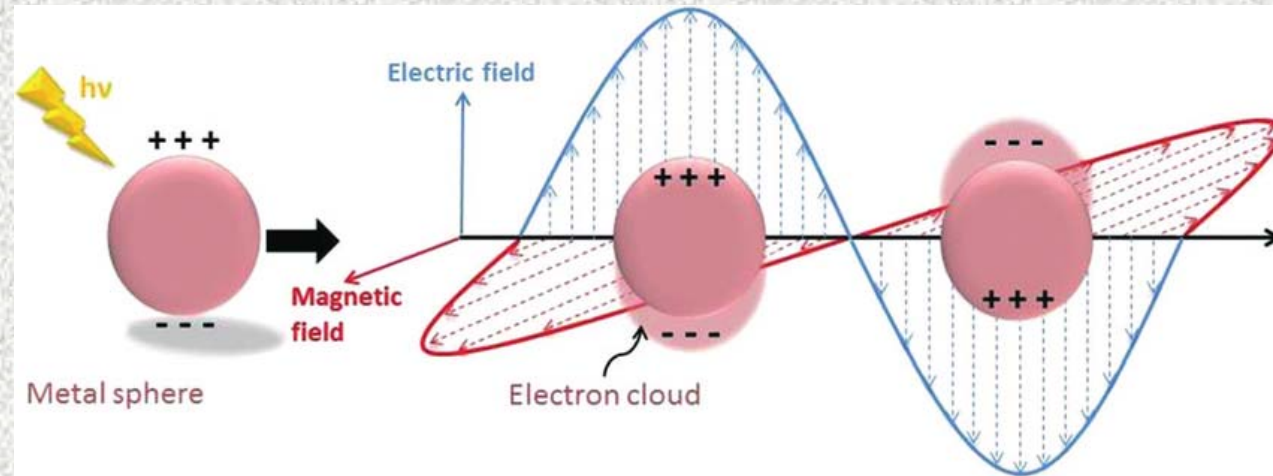

**Metal NPs**

**Plasmon - the collective coherent oscillations of the electron gas - conduction-band electrons - at the surface of nanoparticles in response to incident electromagnetic field of light**

**The metal NP must be large enough to support a conduction band rather than discrete localized states, like a molecule**

**Size cutoff ~2–5 nm for most metals**

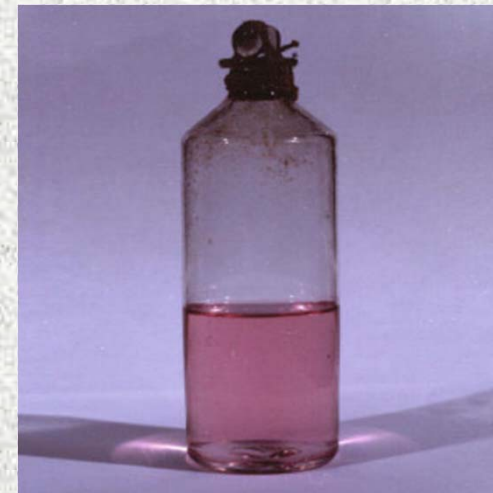

36

**Faraday's colloidal solution of gold**

# Localized Surface Plasmon Resonance (LSPR)

LSPR results in strong absorbance and scattering of light, the energy can be tailored by different metal cores with different sizes and shapes

Au NPs - the visible region for spheres ( $D_{\text{core}}$  3.0 – 200.0 nm)

colorimetric sensing, biological contrast agents

anisotropic Au NPs - the near-infrared, a strong scatterer (in vivo imaging) or absorber (photothermal therapy)

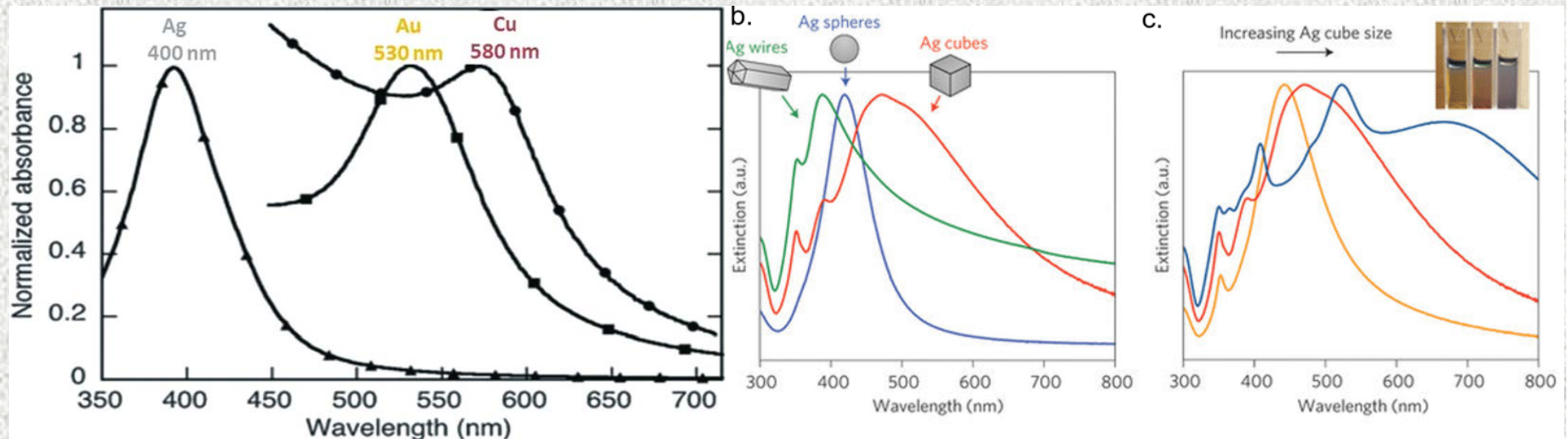

# Melting Point Depression

Surface atoms in solids are bound by a lower number of shorter and stronger bonds  
Nanoparticles with a large fraction of surface atoms

- Lowering of average cohesion energy
- Increasing average amplitude of thermal
- Increasing internal pressure

Result = depression of melting point of nanoparticles

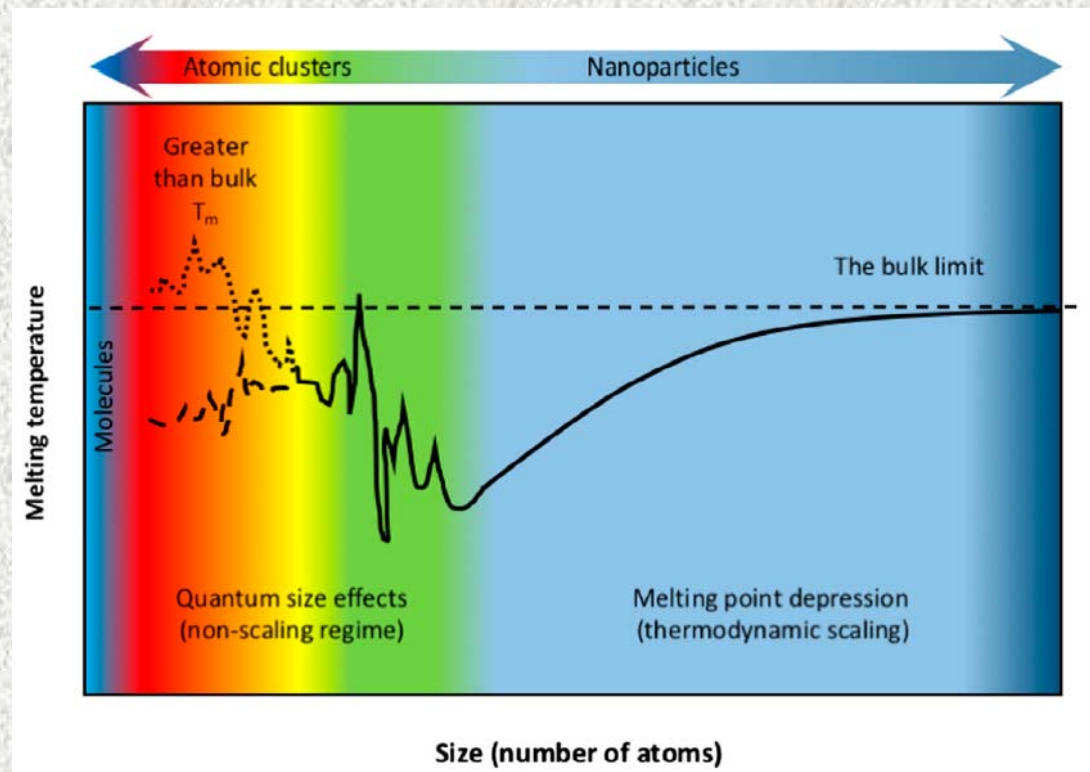

# Melting Point and Enthalpy Depression

## Nanocalorimetry of Sn nanoparticles

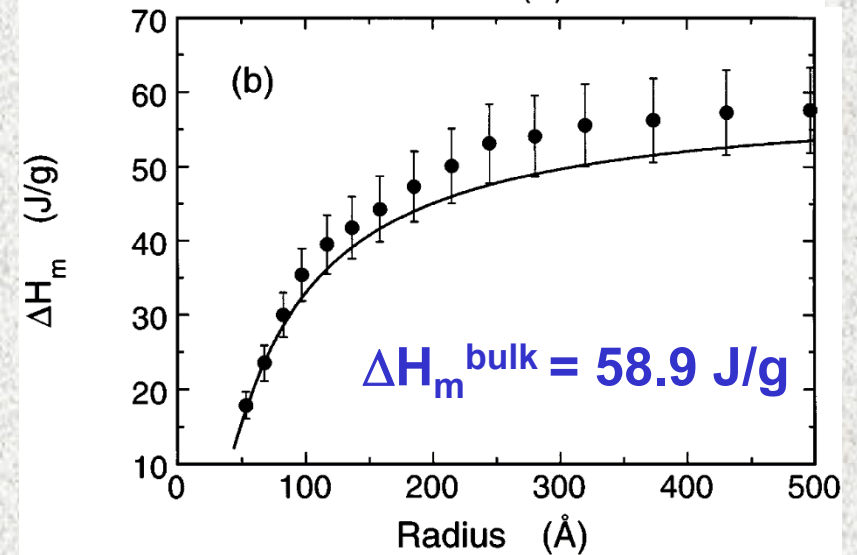
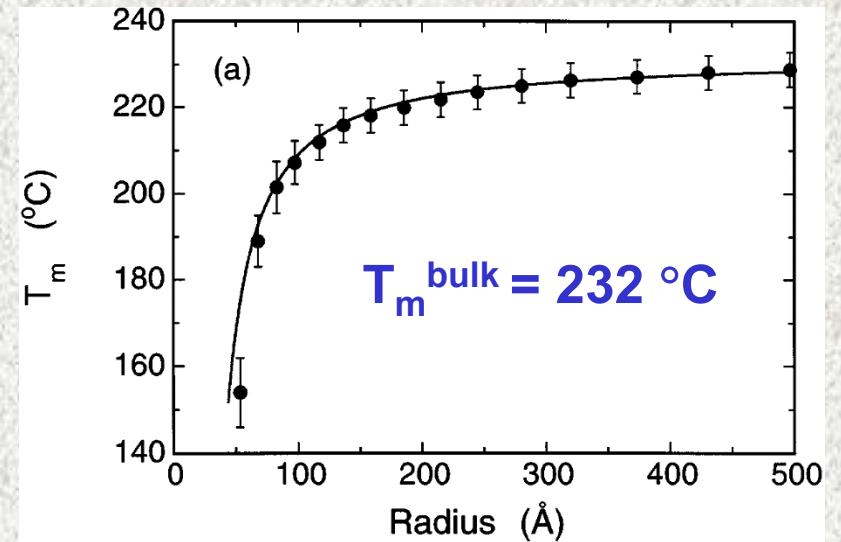
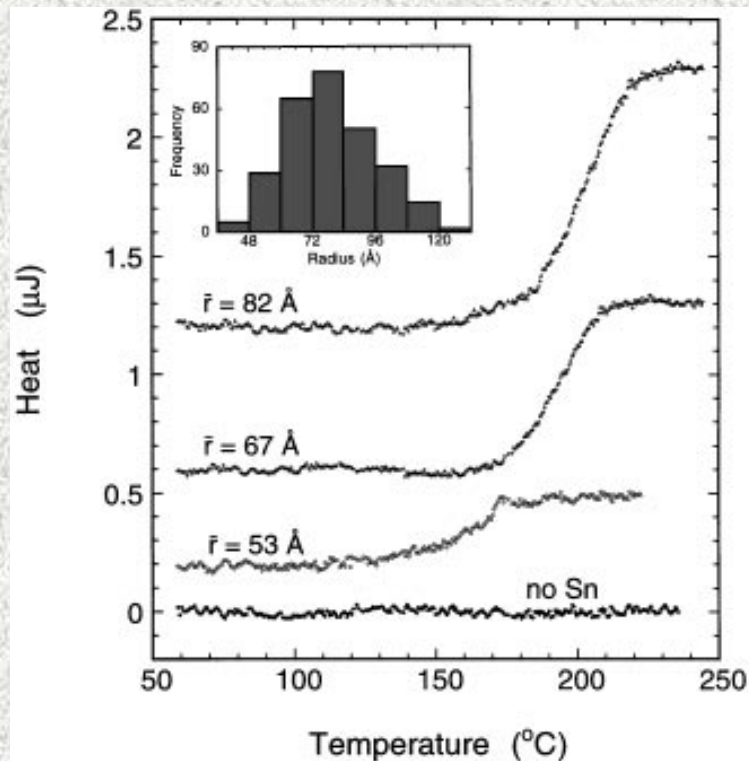

# Melting Point and Enthalpy Depression

## Nanocalorimetry of Sn nanoparticles

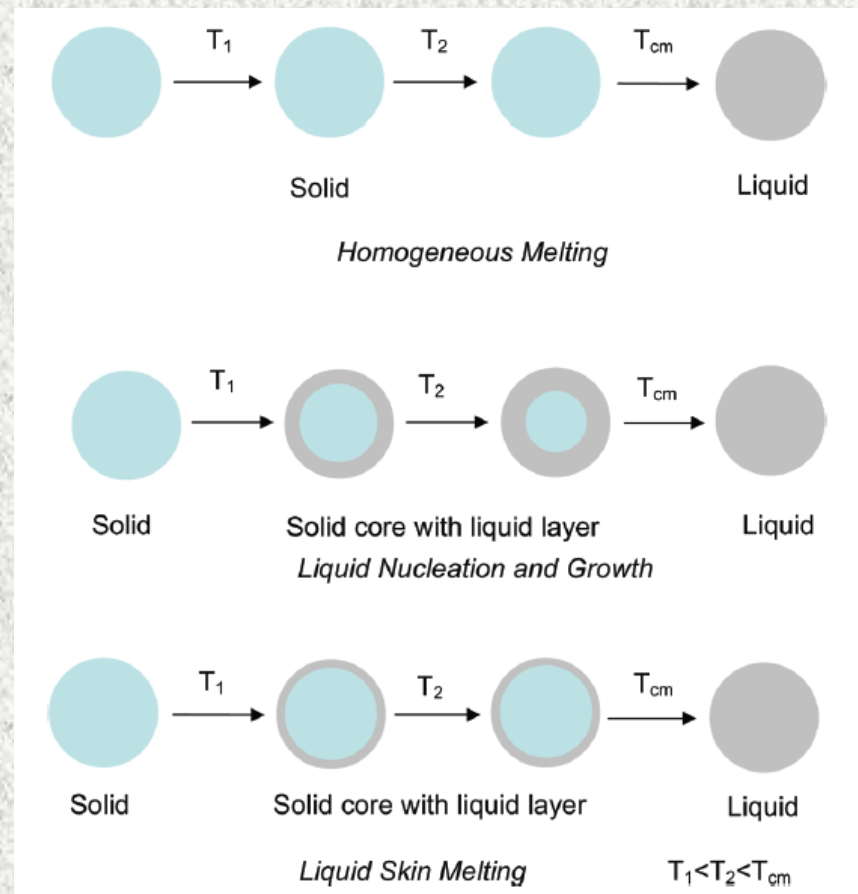
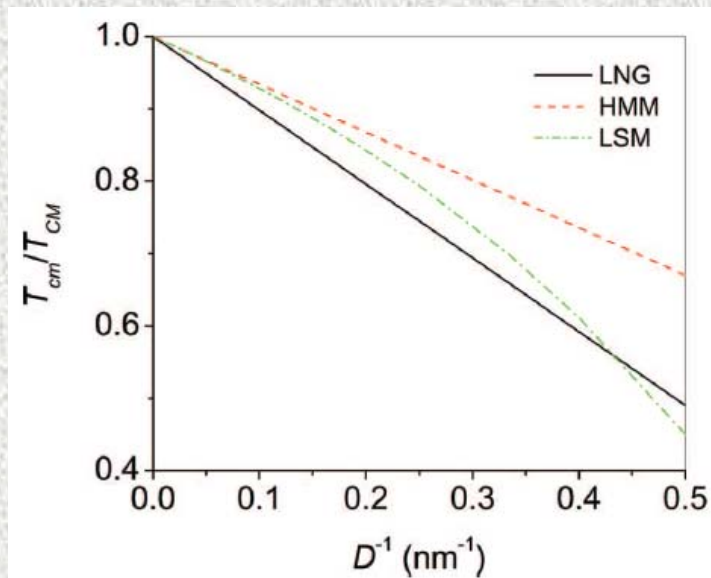



# Melting Point Depression

Homogeneous melting model

Continuous Liquid Melting

Liquid Skin Melting

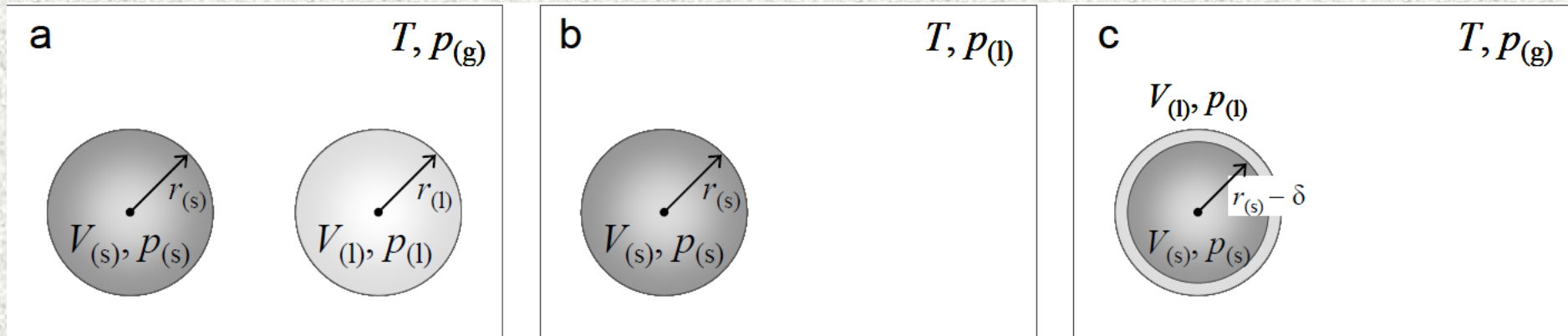

Triple point of coexisting solid and liquid nanoparticles of the same mass surrounded by vapor

Melting particle is surrounded by liquid

Thin melted layer of a constant thickness  $\delta$  coexisting with solid core and vapor

$$\frac{T_r^F}{T_\infty^F} = 1 - \frac{2M}{\Delta H_m^F \rho_{(s)} r_{(s)}} \gamma_{(sl)}$$

$$\frac{T_r^F}{T_\infty^F} = 1 - \frac{2M}{\Delta H_m^F \rho_{(s)} r_{(s)}} \left[ \gamma_{(sg)} - \gamma_{(lg)} \left( \frac{\rho_{(s)}}{\rho_{(l)}} \right)^{2/3} \right]$$

$$\frac{T_r^F}{T_\infty^F} = 1 - \frac{2M}{\Delta H_m^F \rho_{(s)} r_{(s)}} \left[ \frac{\gamma_{(sl)}}{1 - \delta/r_{(s)}} + \gamma_{(lg)} \left( 1 - \frac{\rho_{(s)}}{\rho_{(l)}} \right) \right]$$

# Melting Point Depression

$$T_m(r) = T_m(\text{bulk}) - \frac{2T_m(\text{bulk})M}{\Delta H_m^{\text{bulk}} \rho_s r} \left[ \gamma_{sg} - \gamma_{lg} \left( \frac{\rho_s}{\rho_l} \right)^{\frac{2}{3}} \right]$$

Sn – 4wt%Ag – 0.5wt%Cu Nano alloy particles

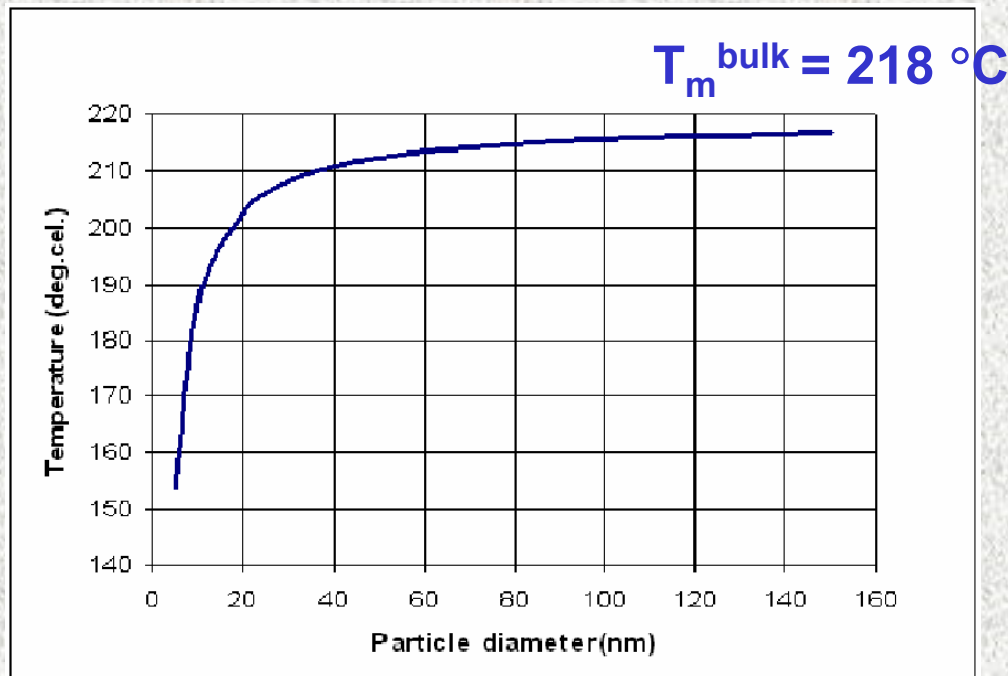

**Homogeneous melting model**

$T_m(r)$  = mp of the cluster with radius  $r$

$T_m^{\text{bulk}}$  = mp of the bulk material

$\gamma_{sg}$  = the interfacial energies between the s and g phases

$\gamma_{lg}$  = the interfacial energies between the l and g phases

$\rho_s$  and  $\rho_l$  = solid and liquid phase densities

$M$  = molar mass

$\Delta H_m^{\text{bulk}}$  = the bulk latent heat of melting

# Gibbs–Thomson Equation

In nanoparticles confined in pores

for  $\rho_s \sim \rho_l$

$$\gamma_{sl} = \gamma_{sg} - \gamma_{lg} \quad \text{Continuous Liquid Melting}$$

$$\frac{T_m(r) - T_m^{bulk}}{T_m^{bulk}} = - \frac{2V_{mol}^l \gamma_{sl}}{\Delta H_m r}$$

$T_m(r)$  = mp of the nanoparticle with radius  $r$

$T_m^{bulk}$  = mp of the bulk material

$V_{mol}^l$  = the molar volume of the **liquid** =  $M/\rho_s$  **solid**?

$\gamma_{sl}$  = the interfacial tension between the s and l surface

$\Delta H_m^{bulk}$  = the bulk molar enthalpy of melting, endothermic

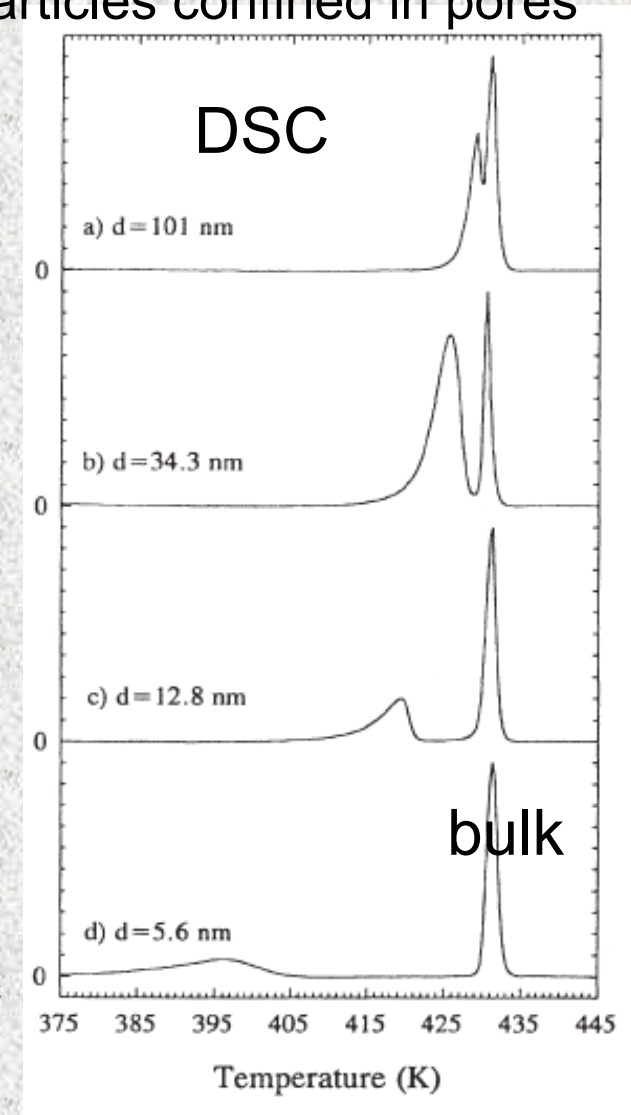

# Phase Transitions

Phase transitions = collective phenomena

With a lower number of atoms in a cluster a phase transition is less well defined and broadened

Small clusters behave more like molecules than as bulk matter

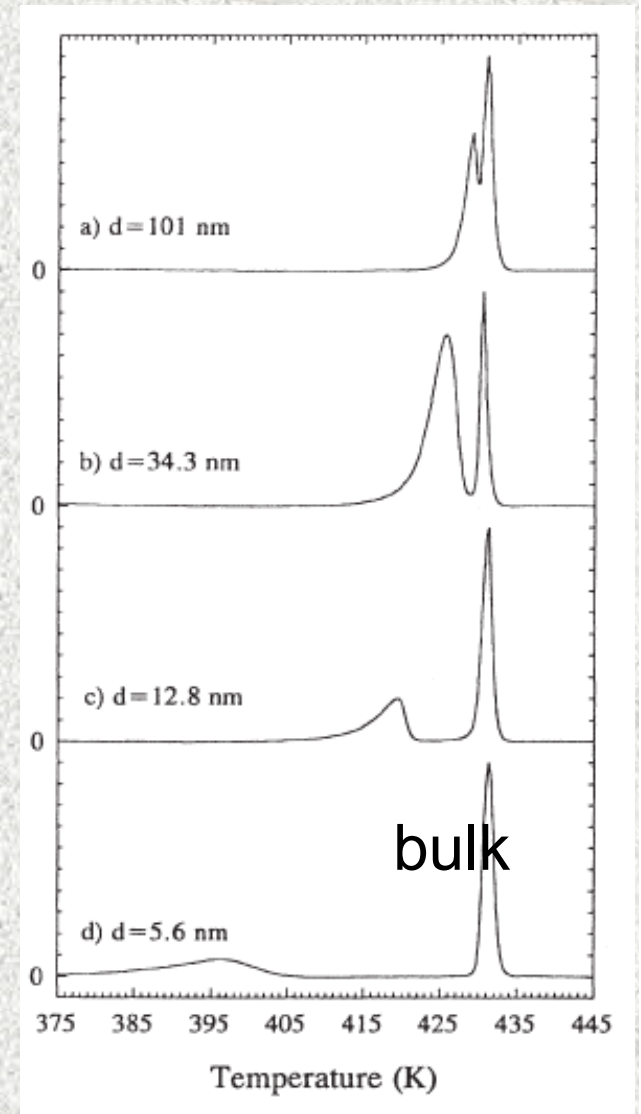
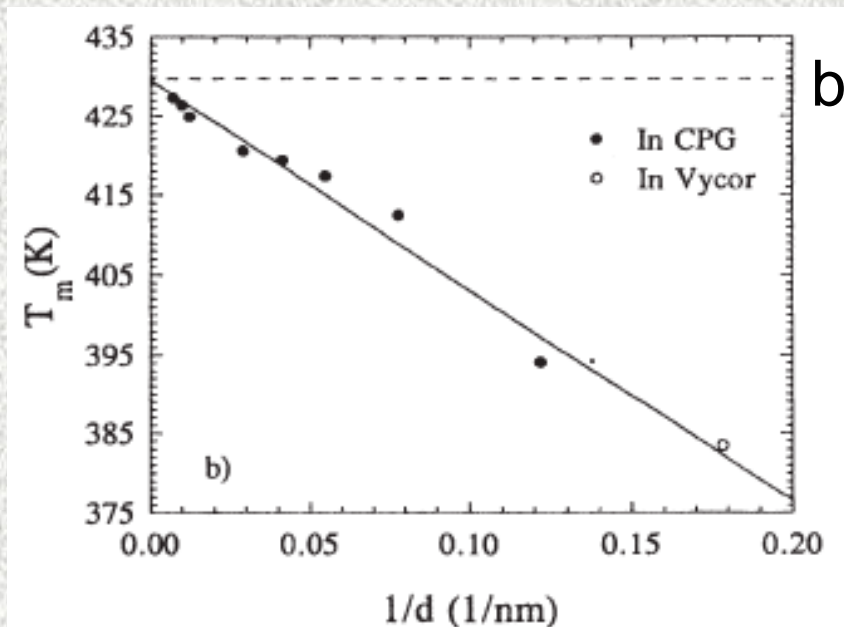

# First-Order Phase Transitions

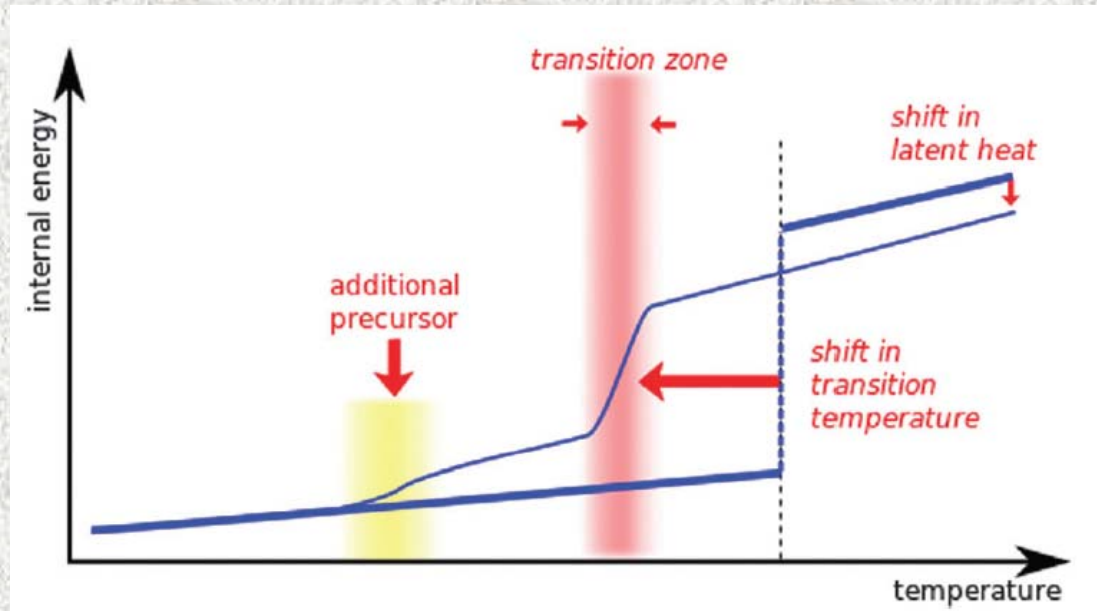

Three main consequences of a size decrease on caloric curve:

- The transition is shifted, usually to a lower temperature (surface atoms are less coordinated and less bound than interior atoms)
- The transition temp. is no longer sharp but becomes smooth and takes place over a finite range (fluctuations in TD quantities)
- The latent heat is lower than in the bulk limit

# Surface Effects

## Reduction in particle size

- **Metal** particles usually exhibit a lattice **contraction**
- **Oxide** particles exhibit a lattice **expansion**

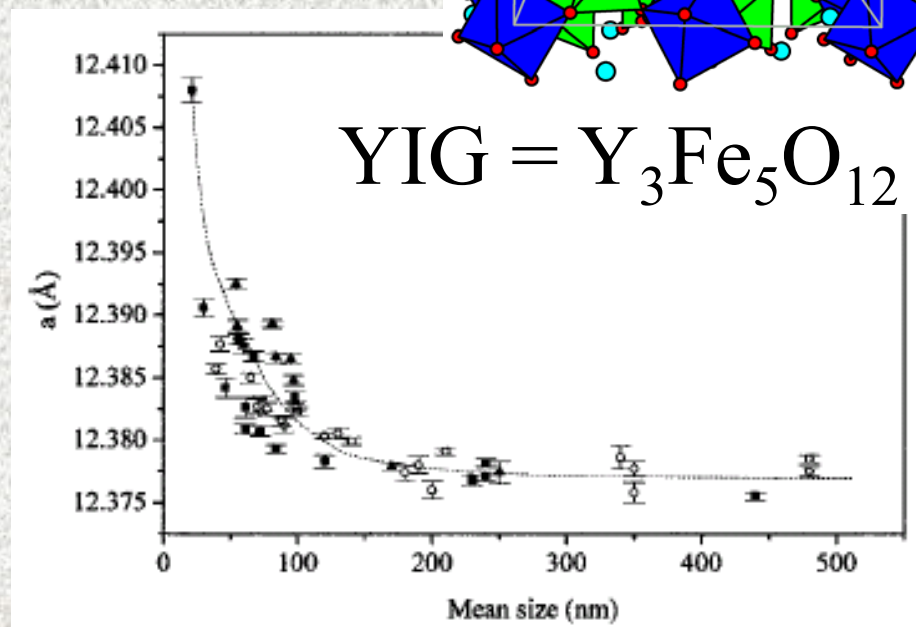
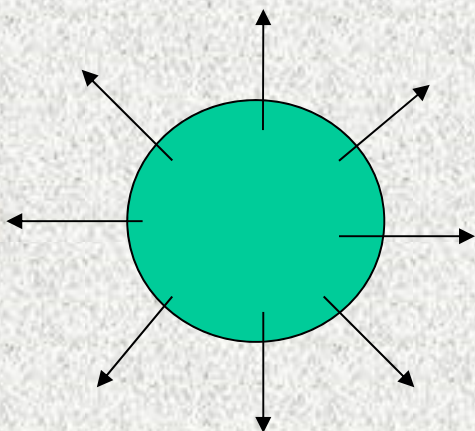
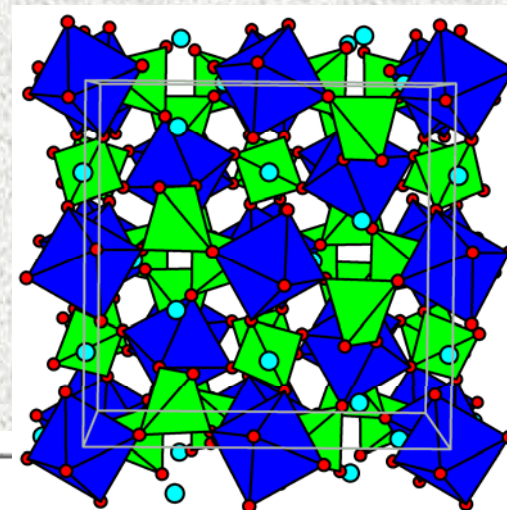

# Surface Effects

**Correlation between the unit-cell volume (cubic) and the XRD particle size in  $\gamma$ -Fe<sub>2</sub>O<sub>3</sub> nanoparticles**

**The smaller the particle size the larger the unit cell volume**

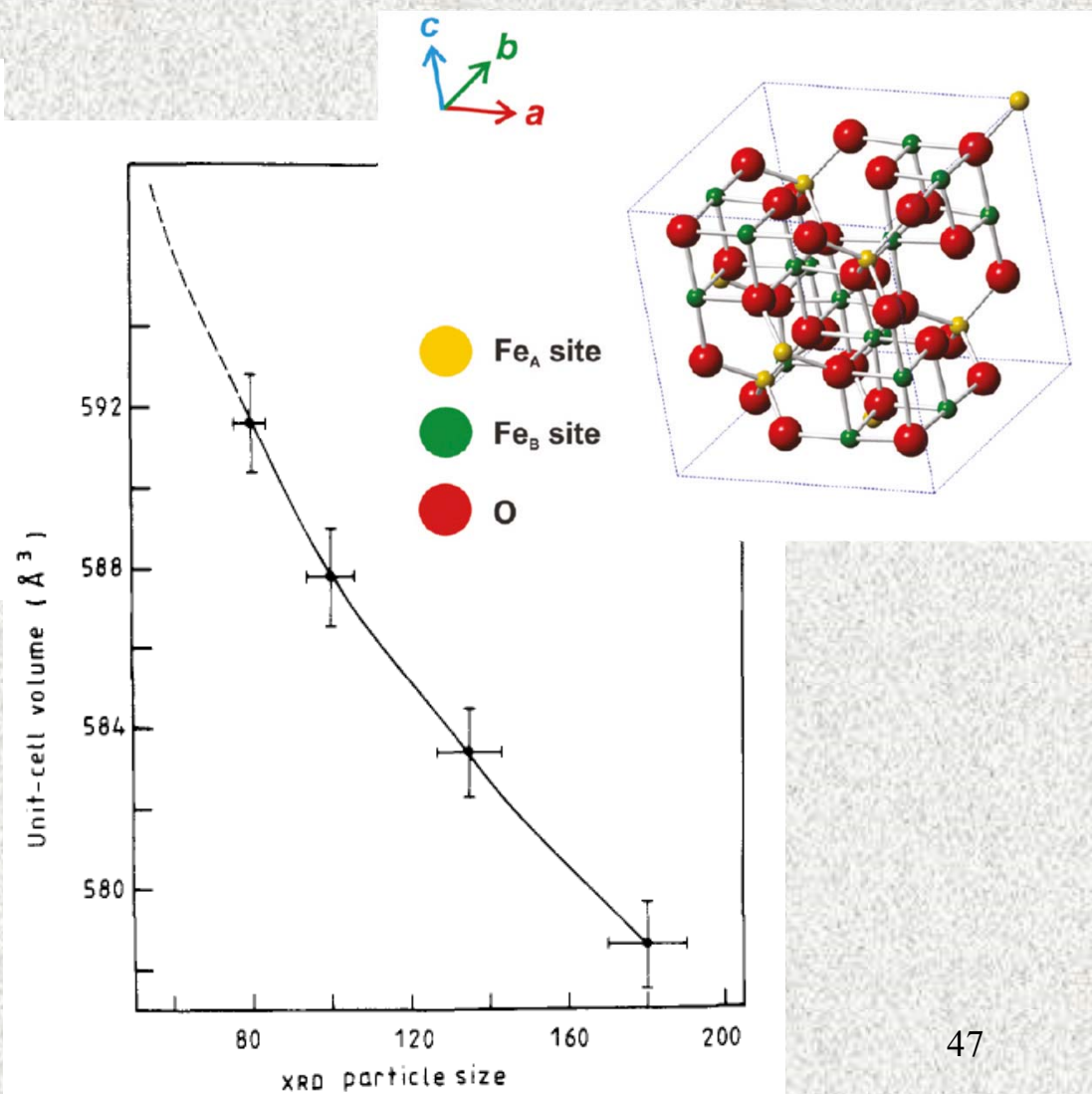

# Surface Effects

The inter-ionic bonding in nanoparticles has a directional character

Ions in the outermost layer of unit cells possess unpaired electronic orbitals

Associated **electric dipole moments**, aligned roughly parallel to each other point outwards from the surface

The repulsive dipolar interactions increase in smaller particles, are reduced by allowing unit cell volume to increase

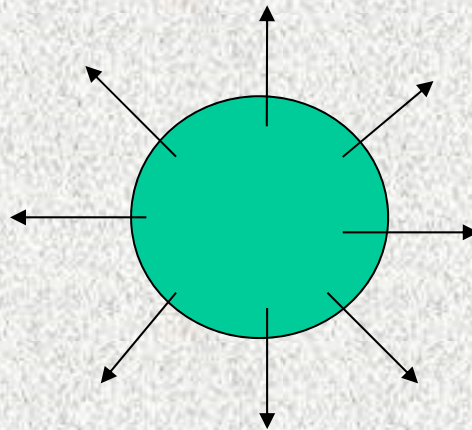



# Surface Effects

**Metal nanocrystals**

**A continuum elastic model**

**The lattice contraction observed in Ag nanoclusters**

**Interpreted as the result of hydrostatic pressure exerted by the surface stress**

**The surface stress 6.3 N/m for free Ag NPs 1–7 nm in diameter**

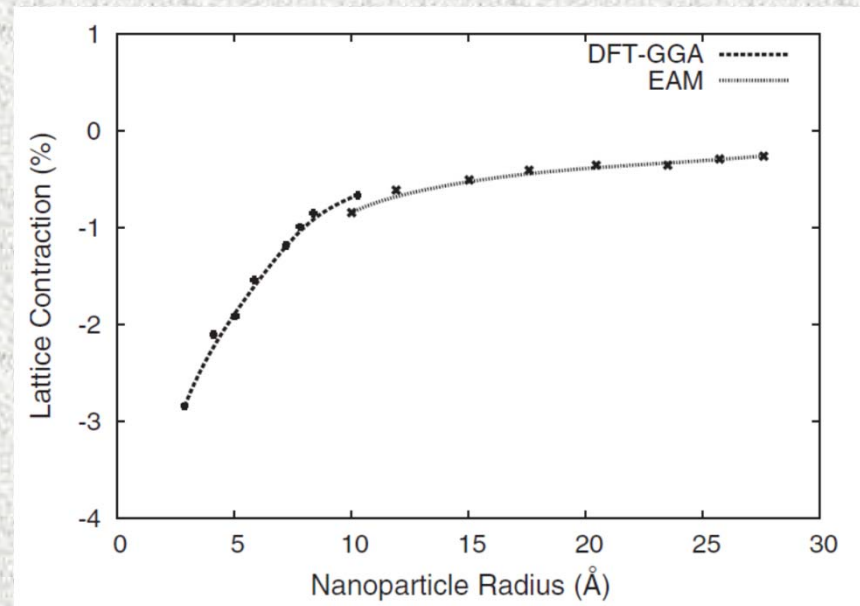

**The smaller the particle size, the smaller the unit cell volume**

# Defects in Nanocrystals

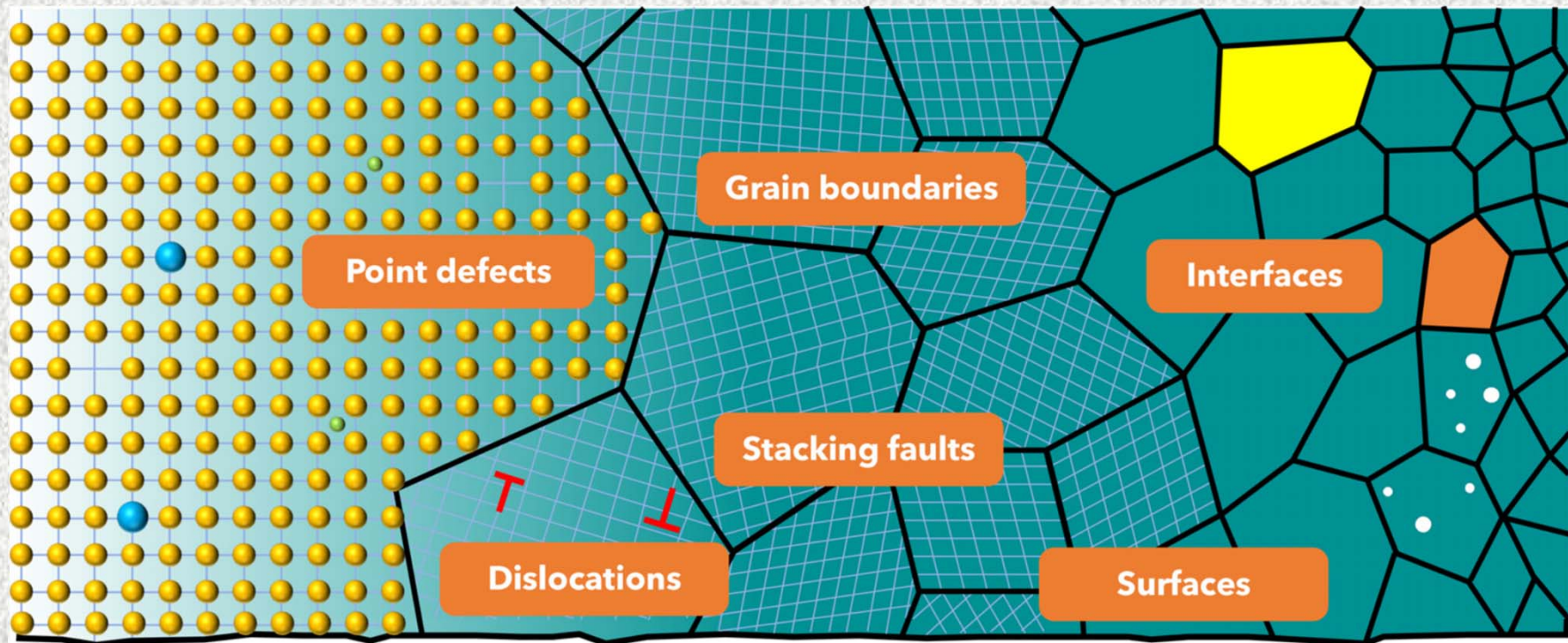

# Quantum Size Effects

**Size quantization** - changes in the energy-level structures of materials as the material-unit (most often a crystal) size drops below a certain size - the Bohr diameter of the electron-hole pair

**Semiconductors** - between a few nm and several tens of nm

**Metals** - Au clusters, approx. 1 nm (often less than 100 atoms)

## **Size quantization**

- an increase in bandgap (blue-shift in optical spectra)
- increasing separation of energy levels with decrease in crystal size

As the energy-level structure changes continuously with change in crystal size, a material of a particular fixed chemical composition can be made with varying and tunable physical properties - basic material properties are determined by size

# Quantum Confinement Effects

Physical and chemical properties depend on the size !!

The smaller the space in which the bound motion takes place, (i.e., the stronger the confinement) the larger the energy separation between the allowed energies becomes

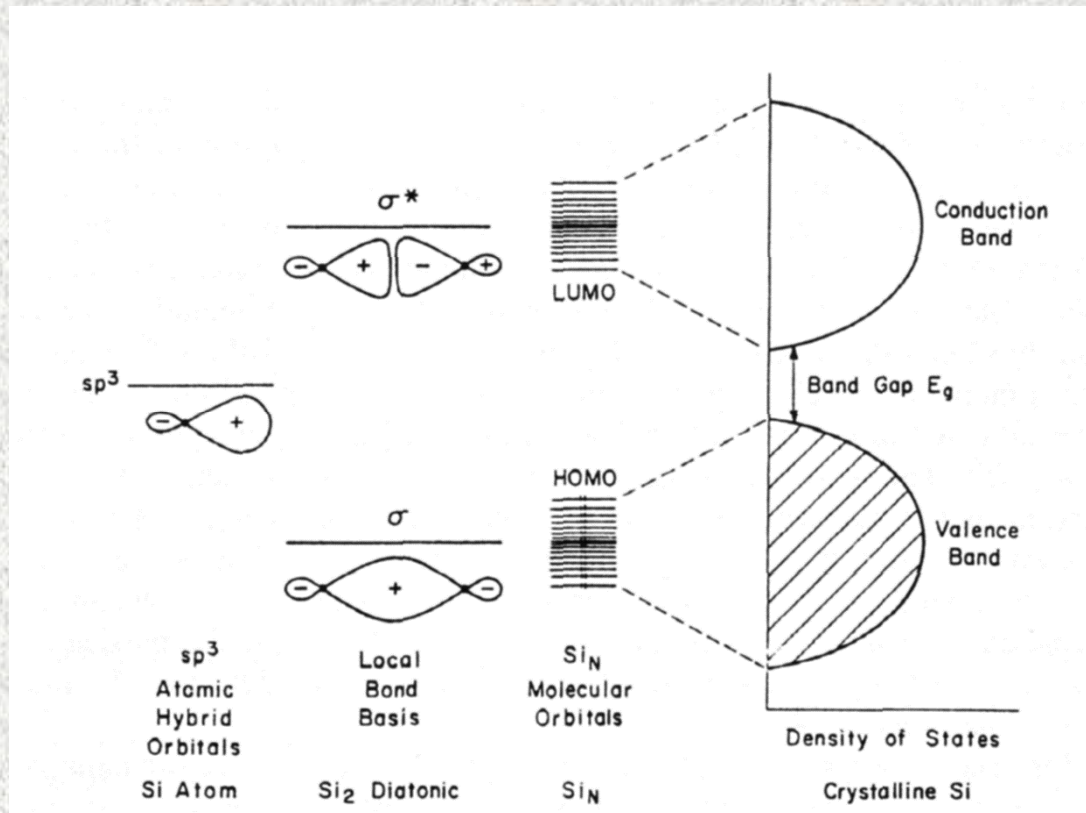

# Quantum Size Effects

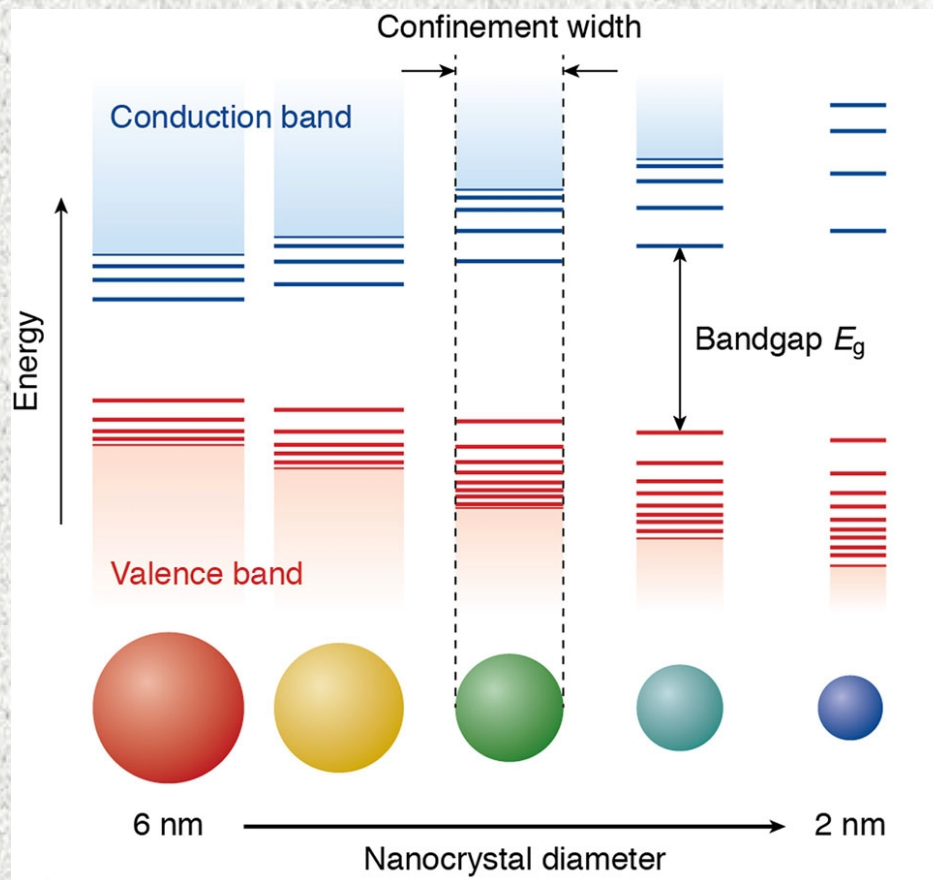

**Band gap dependency on the nanoparticle size**

**Smaller particles have a wider band gap = blue shift**

# Quantum Size Effects



**Room temperature optical absorption spectra of CdSe nanocrystallites dispersed in hexane and ranging in size from  $\sim 12$  to  $115 \text{ \AA}$**

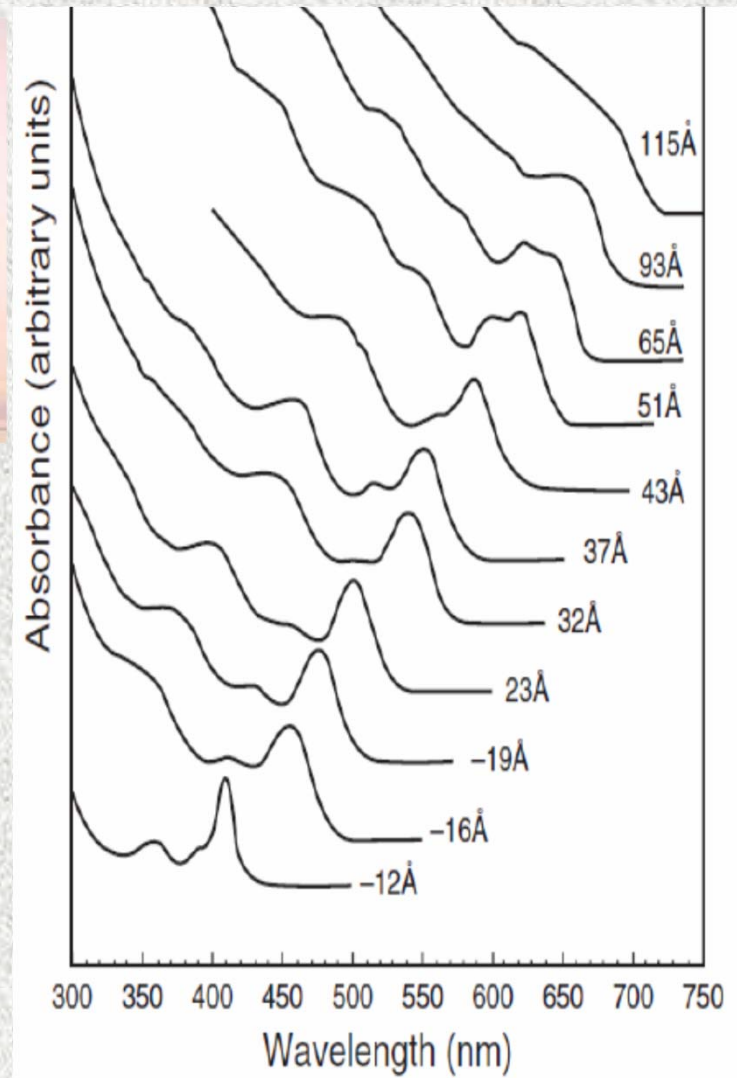

# Quantum Size Effects

## Metals

## Semiconductors

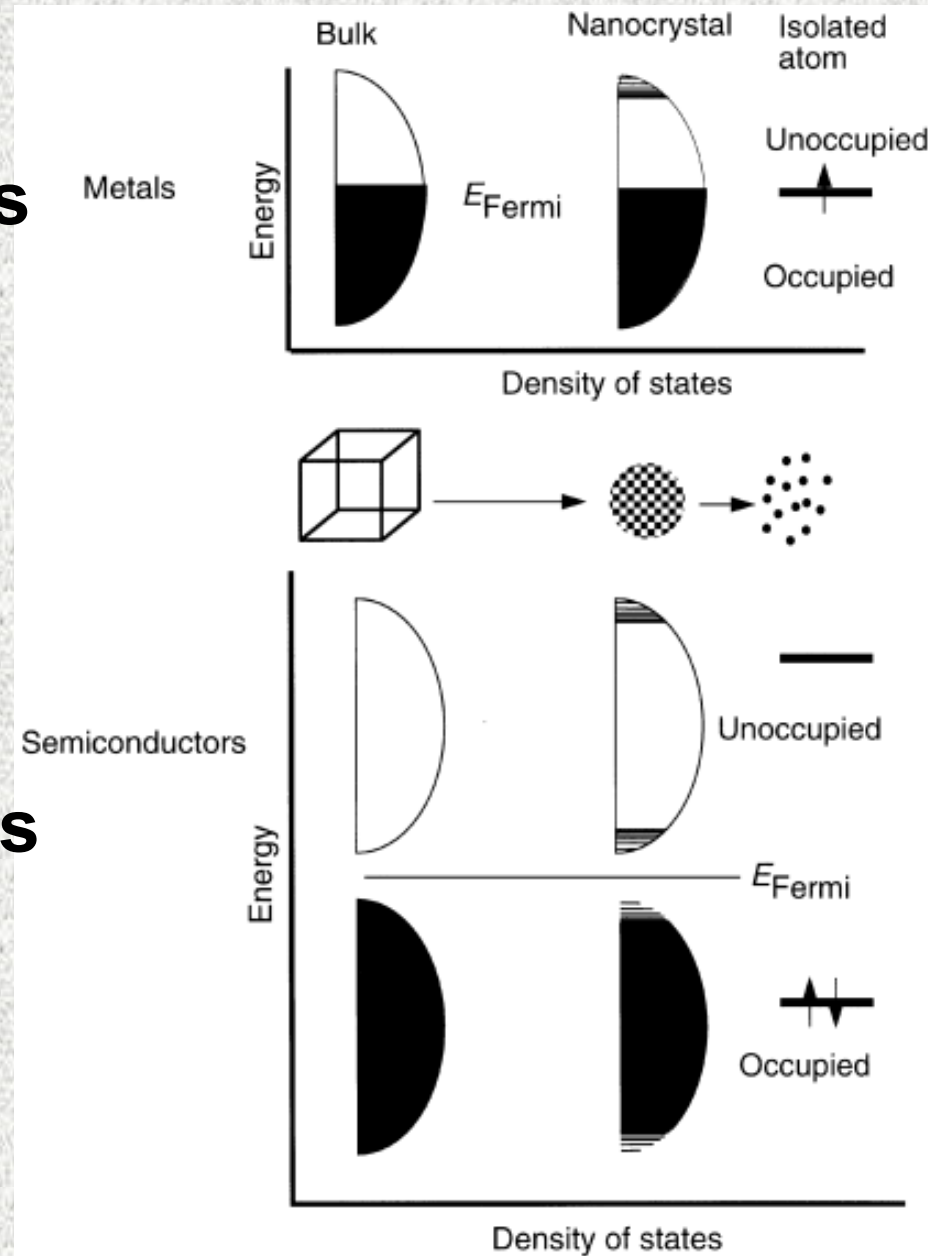

# Metal-to-Insulator Transition

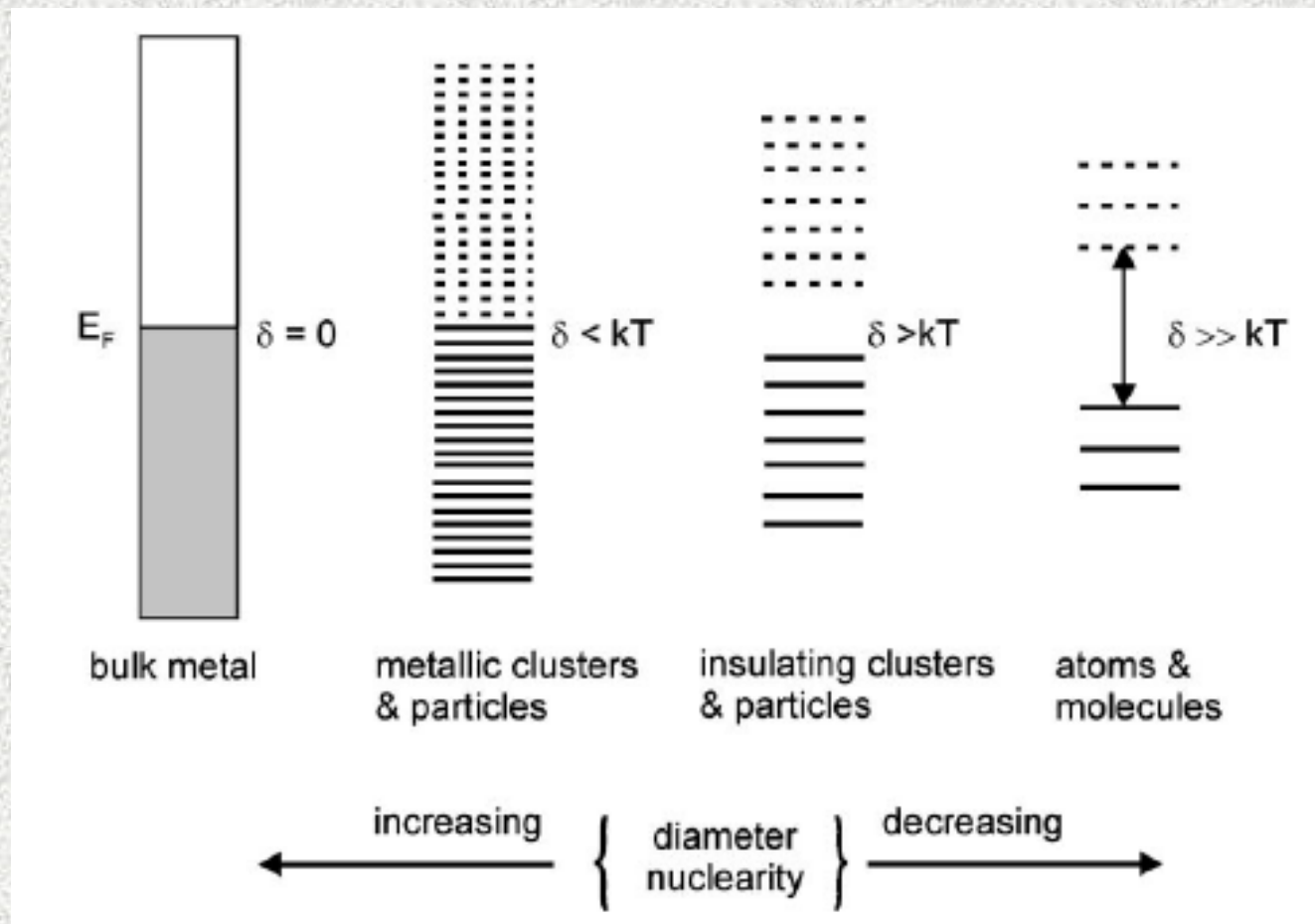



# Metal-to-Insulator Transition

Band gap increases with decreasing size

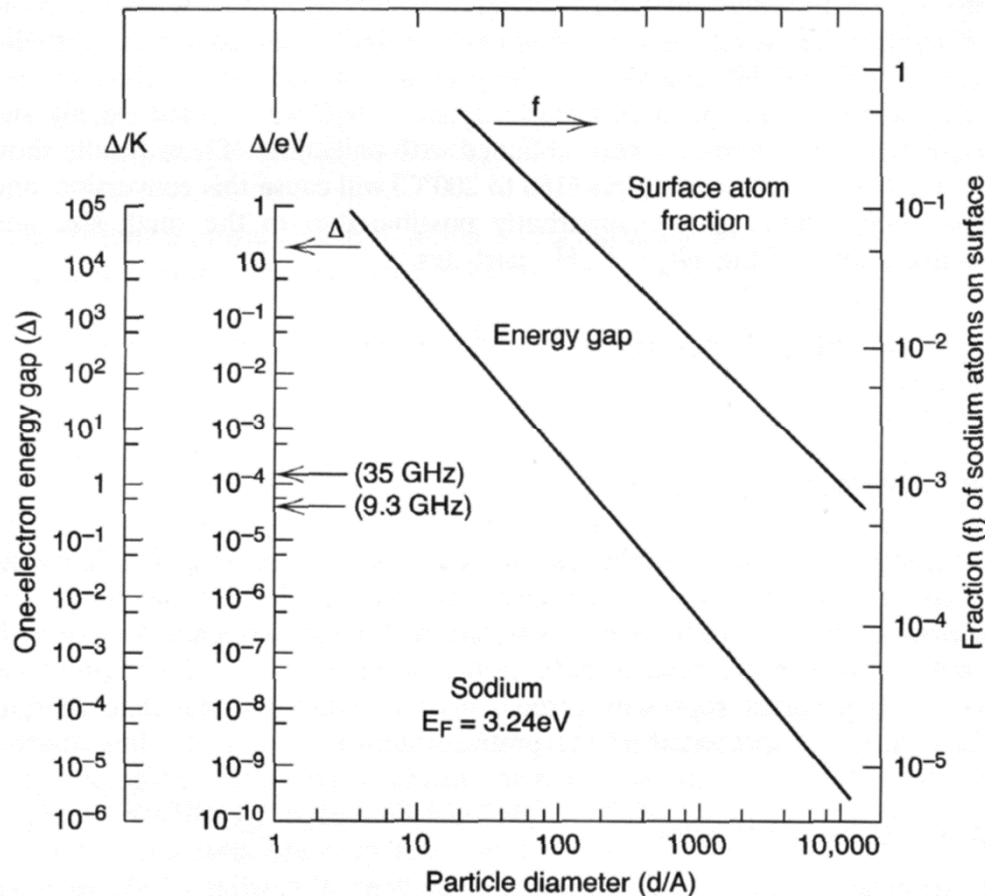

**Metallic behavior**  
Single atom cannot  
behave as a metal  
nonmetal to metal  
transition 100-1000 atoms

**Magnetic behavior**  
Single domain particles  
large coercive field

# Metal-to-Insulator Transition

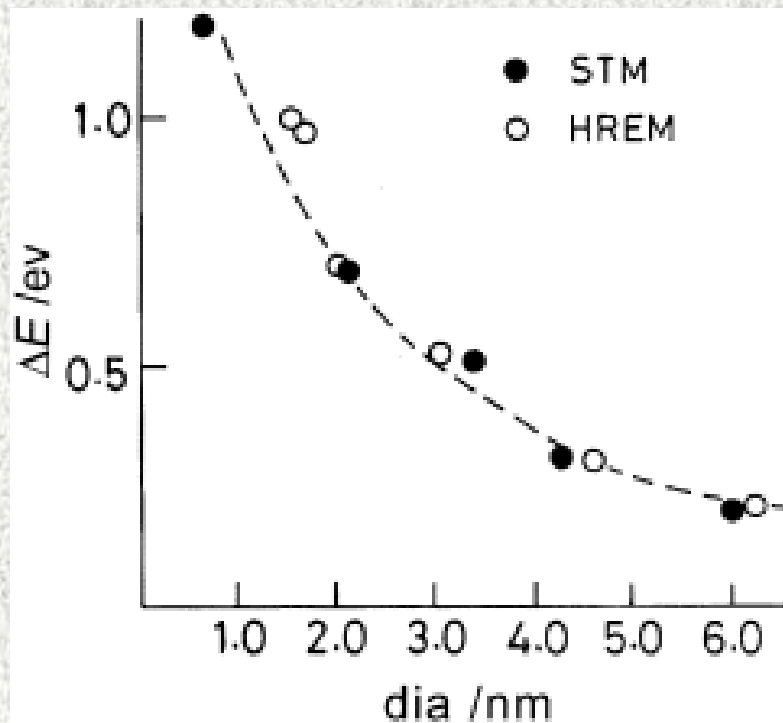

The increase in the core-level binding energy in small particles

Poor screening of the core charge

The size-induced metal-nonmetal transition in nanocrystals

Variation of the shift,  $\Delta E$ , in the core-level binding energy (relative to the bulk metal value) of Pd with the nanoparticle diameter

# Electrical Conductivity

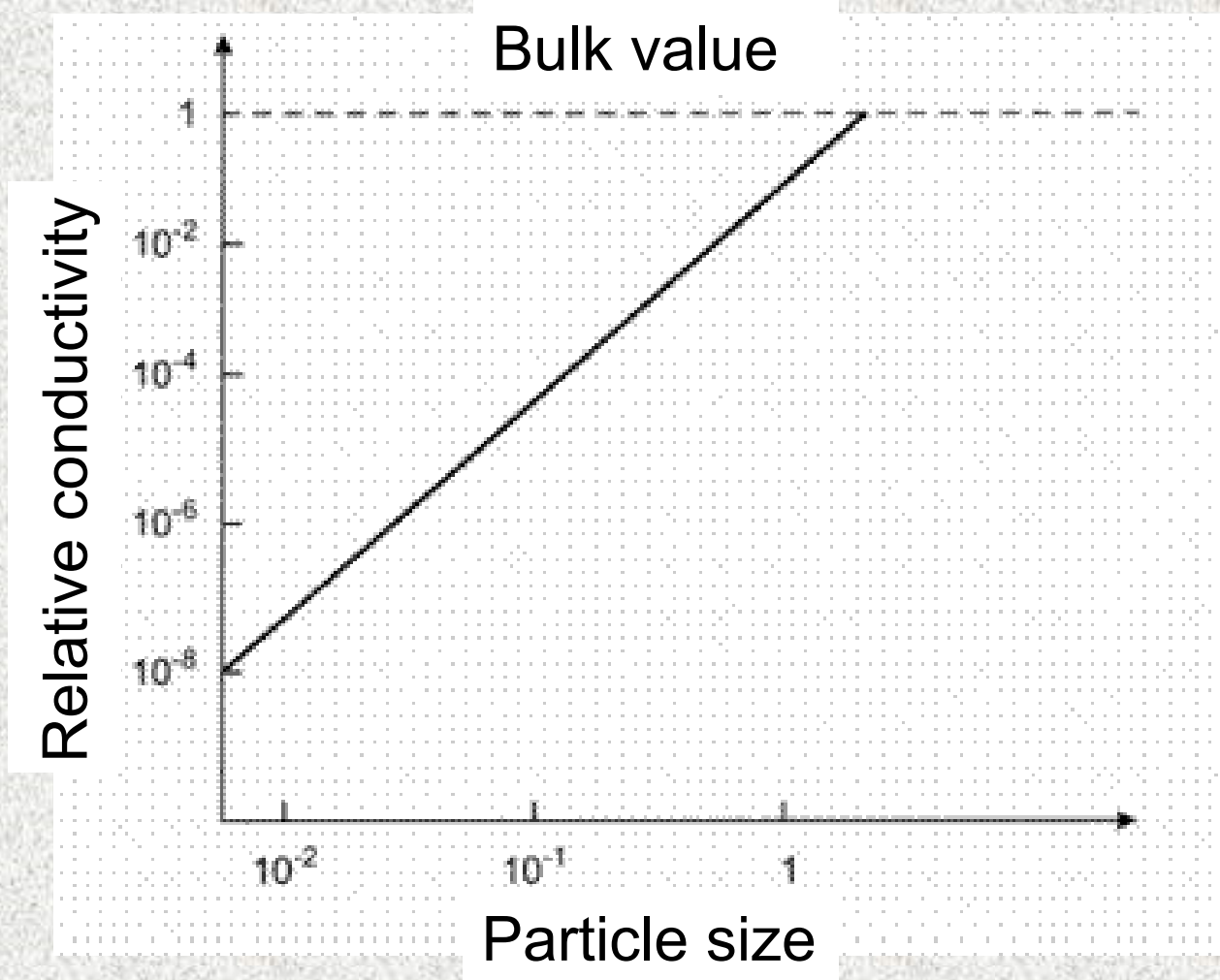

**Hg**  
Valence electron  
configuration?

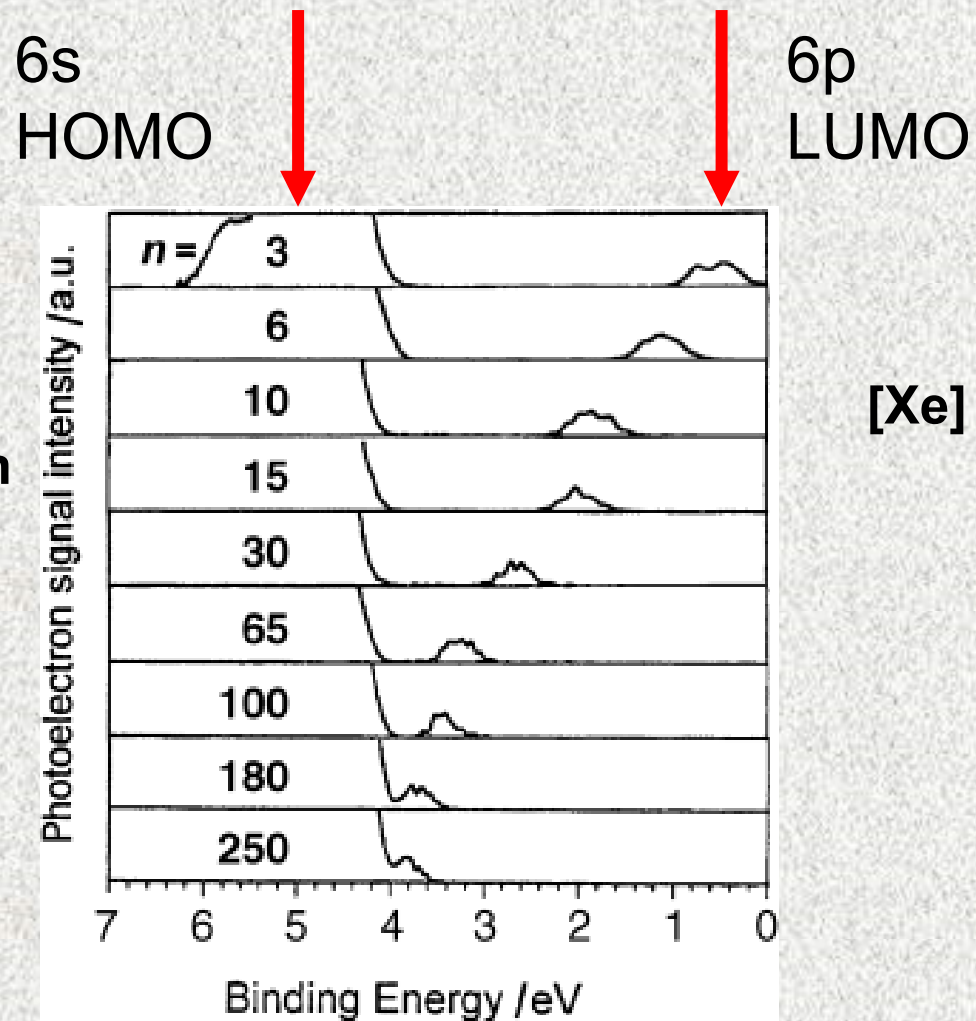

Photoelectron spectra of Hg clusters of nuclearity  $n$   
The 6p peak moves gradually towards the Fermi level  
The band gap shrinks with increase in cluster size

# Quantum Size Effects In Semiconductors

a) Absorption spectra of CdSe nanocrystals (at 10 K) of various diameters

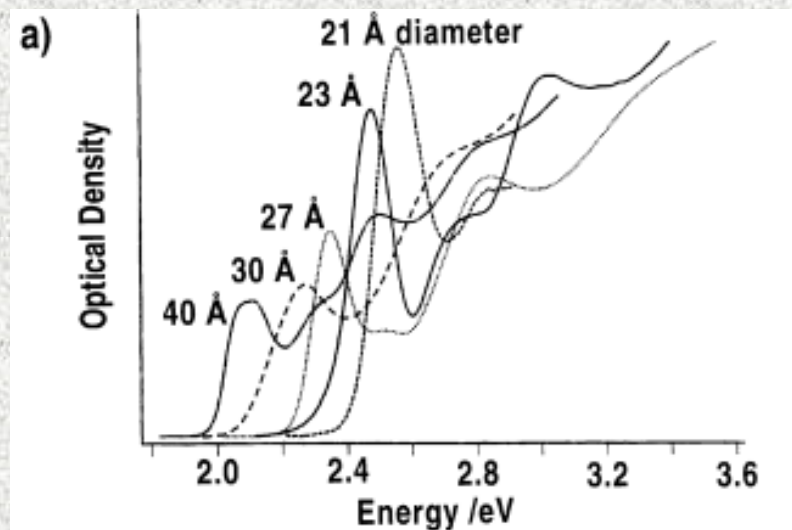

b) Wavelength of the absorption threshold and band gap as a function of the particle diameter for various semiconductors. The energy gap in the bulk state in parenthesis

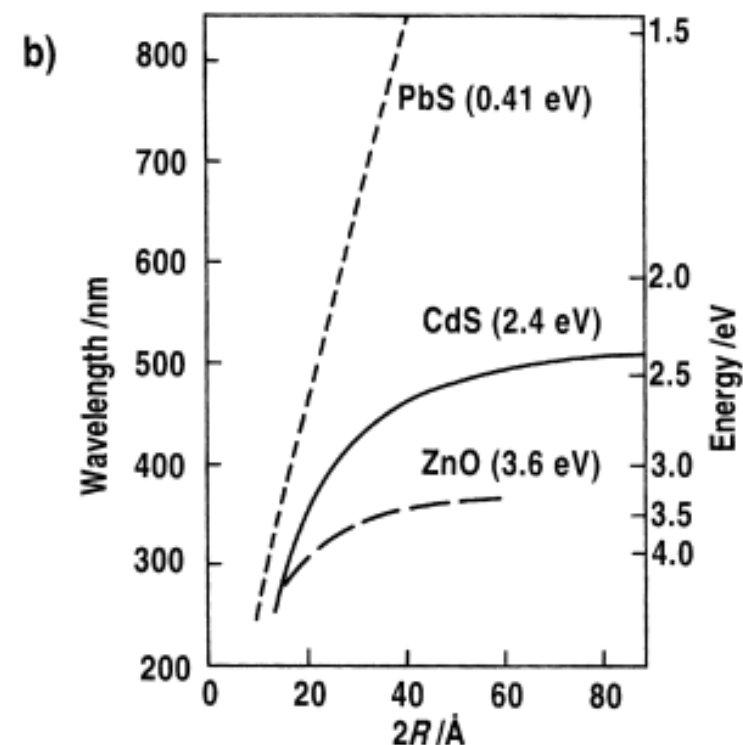

# Quantum Confinement Effects

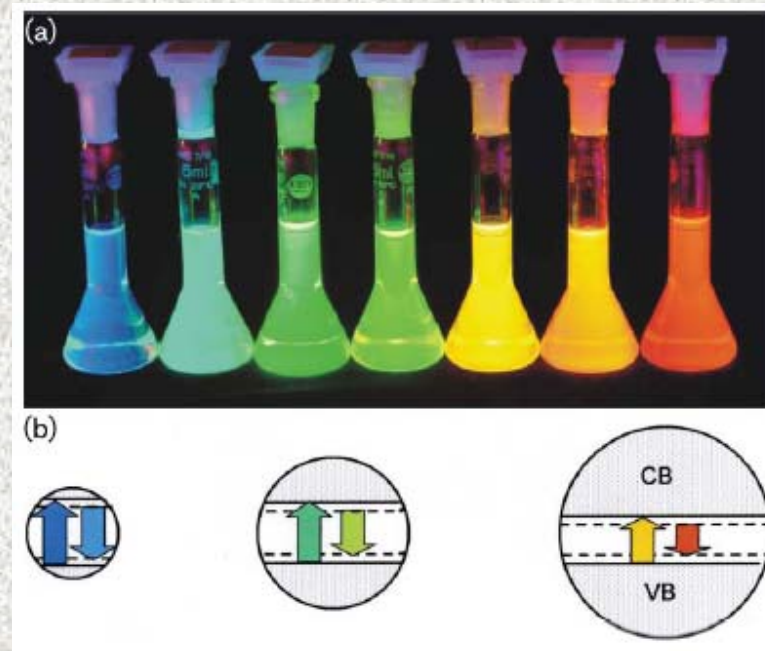

**Fluorescence of CdSe–CdS core–shell nanoparticles with a diameter of 1.7 nm (blue) up to 6 nm (red)**

**Smaller particles have a wider band gap**

# Bohr Radii

Quantum confinement - particles must be smaller than the Bohr radius  $r_B$  of the electron-hole pair (exciton)

$r_B$  = the spatial separation of the electron-hole pair

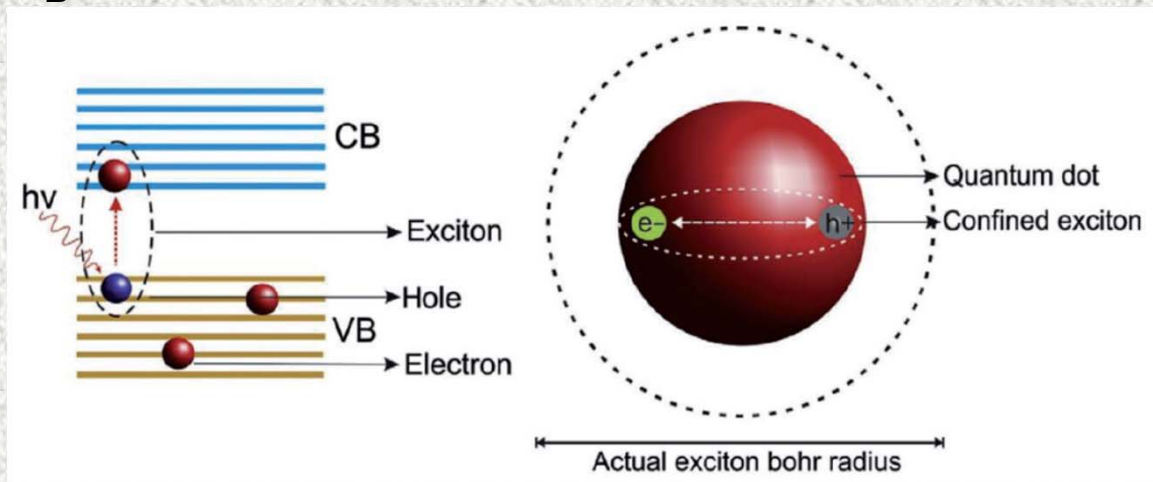

$$r_B = \frac{\hbar^2 \epsilon}{e^2} \left( \frac{1}{m_e} + \frac{1}{m_h} \right)$$

semiconductor	$r_B$ (Å)	$E_g$ (eV)
CdS	28	2.5
CdSe	53	1.7
CdTe	75	1.5
GaAs	124	1.4
PbS	180	0.41

# Quantum Confinement Effects

**Two regimes - strong and weak**

**The strong QC effect**

**the size of the crystal is reduced to much smaller than the Bohr radius for the material ( $\approx 3$  nm for  $\text{WO}_3$ )**

**This causes direct changes to the electron wavefunctions and hence significantly alters the  $E_g$**

**The weak QC effect**

**the crystal size is larger than the Bohr radius**

**This causes indirect perturbation of the electron wavefunction due to Coulomb effects and results in more subtle changes in the bandgap energy**



# Quantum Confinement Effects

**WO<sub>3</sub> films by radio frequency (RF) sputtering**

**The crystallite size is controlled by the substrate temperature (T<sub>s</sub>) during deposition**

**The crystallite sizes obtained ranged from 9 nm (100 °C) to 50 nm (500 °C)**

**The reduction in T<sub>s</sub>, and hence reduction in crystallite size, results in a blue shift of the transmission spectrum corresponding to a widening of E<sub>g</sub>**

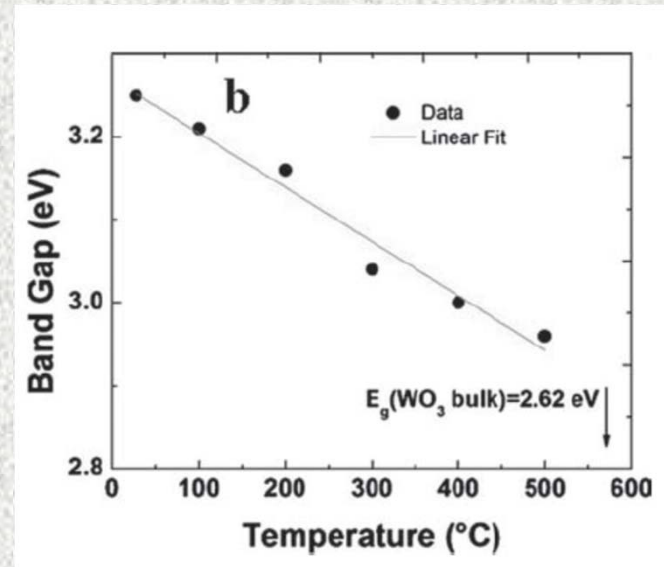

# Quantum Confinement Effects

## Optical properties

nc-TiO<sub>2</sub> is transparent - applications?

Blue shift in optical spectra of TiO<sub>2</sub> nanoparticles

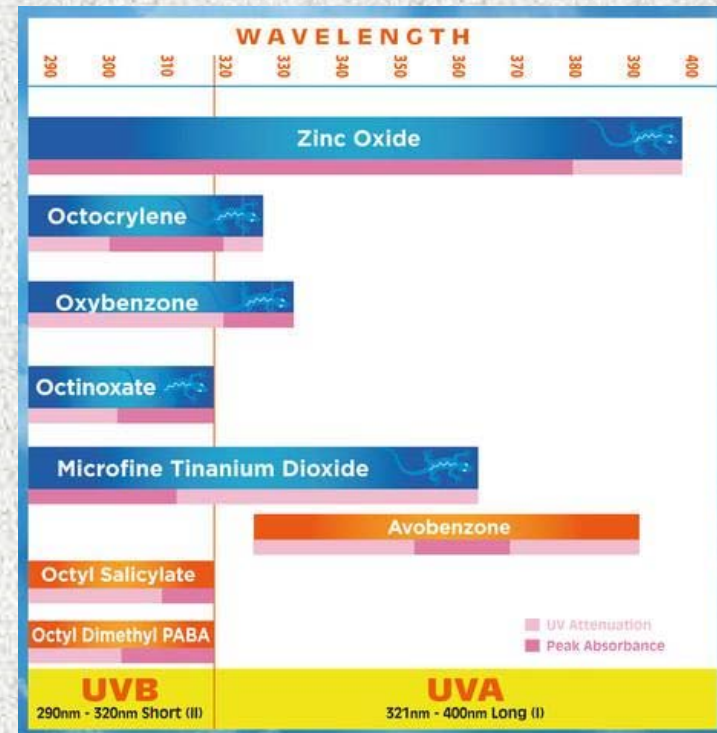
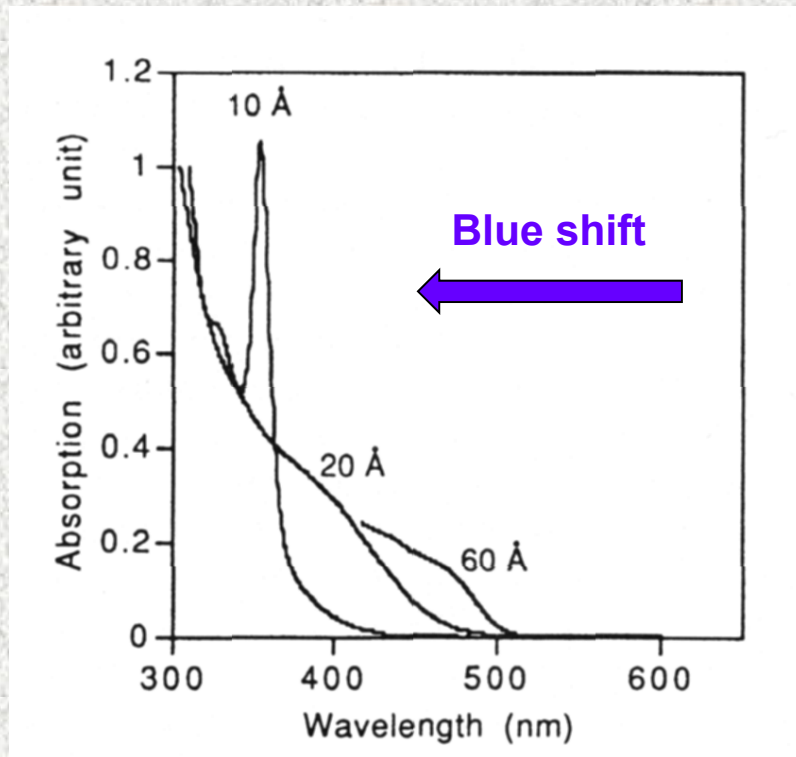

# Single-Electron Effects

Capacitance  $C$  - the ratio of the amount of electric charge stored on a conductor to a difference in electric potential (wrt ground)

$$C = U / q \text{ [Farad]}$$

The energy  $E$  needed to add a charge (electron) to an isolated structure (e.g., QD) is given by the charge  $q$  divided by twice the capacitance  $C$

If  $E$  is comparable to the thermal energy  $k_B T$  (26 meV at room T) - no effect on the operation of a device - thermal noise (cool to 4 K)

The capacitance  $C$  of a structure is dependent on the **size**  
Semiconductors - when size is less than about 20 nm, charging by a single charge will be clearly distinguishable above the background thermal energy at room temperature

Single-electron devices

- Single-electron transistors
- Single-electron memories

# Metastable Crystal Phases

High-pressure crystal phases that are normally unstable at atmospheric pressure can be obtained in nanocrystalline form and are stable under normal atmospheric conditions

Semiconductors Gr. 13/15

Four-coordinate cubic (sphalerite) or hexagonal (wurtzite) phases

High pressure - six-coordinate (rocksalt) phase

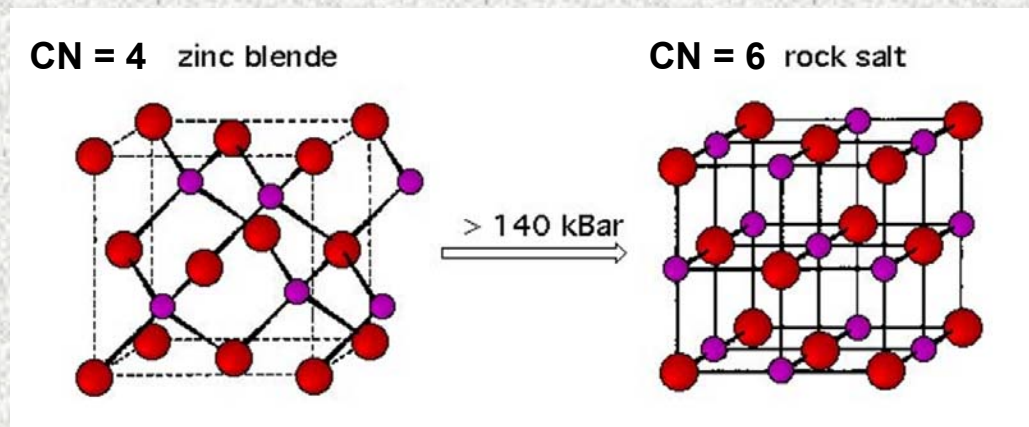

CdS – wurzite at normal pressure, rock salt above 3 GPa

But: **Rocksalt CdS stable at normal pressures for 2–100 nm crystals**

# Metastable Crystal Phases

When reducing the crystal size, phase transitions occur:

$\text{BaTiO}_3$  /  $\text{PbTiO}_3$  cubic  $\rightarrow$  tetragonal

Co hcp  $\rightarrow$  fcc

Ti hcp  $\rightarrow$  bcc

$\text{TiO}_2$  rutile  $\rightarrow$  anatase

$\text{CdSe}$  /  $\text{CdS}$  wurtzite  $\rightarrow$  rock salt

$\text{ZrO}_2\text{-Y}_2\text{O}_3$  tetragonal  $\rightarrow$  monoclinic

- a lack of nucleation sites
- the Gibbs–Thomson effect (i.e., an enhanced internal pressure as a result of high surface/interface curvature)
- surface-energy differences between allotropic phases

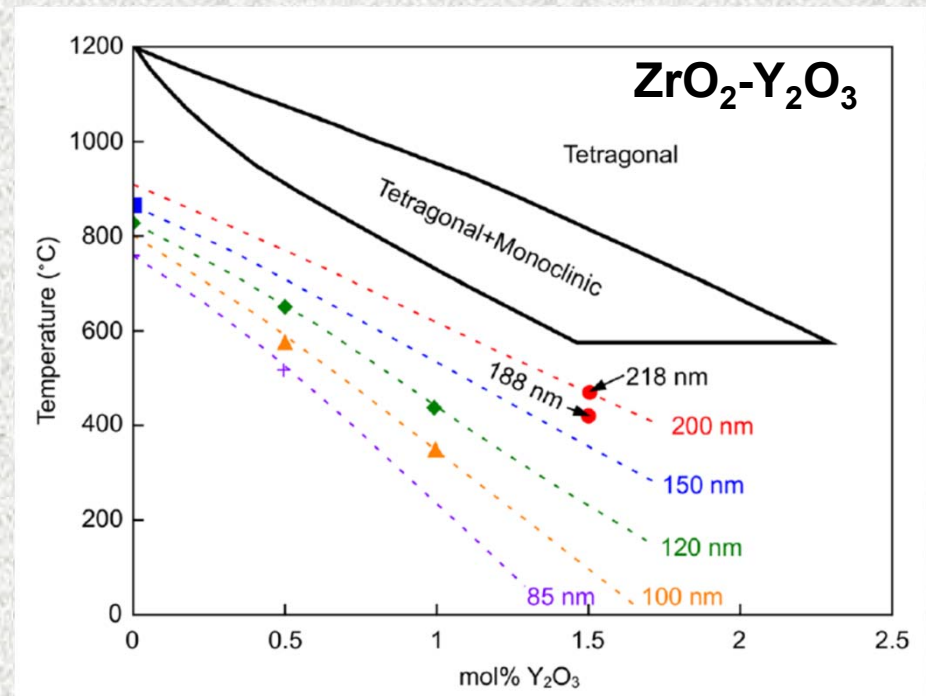

Decrease of tetragonal  $\rightarrow$  monoclinic phase-transition temperature with reducing the crystal size of YSZ

# Metastable Crystal Phases

## Ni fcc

in bulk, stable to mp 1726 K, no phase transitions up to 65 GPa, ferromagnetic

## Ni bcc

metastable, a film by rf-magnetron sputtering on a GaAs(100) substrate, above critical thickness 5 nm transforms to fcc

## Ni hcp

- A film by pulse plasma evaporation at  $2 \times 10^{-6}$  Torr, crystallites 25 nm, transform to fcc at 250 °C

- A film by UHV evaporation on (001) MgO, hcp Ni islands 2.5 nm thick transform to fcc when lateral size larger than 5 nm

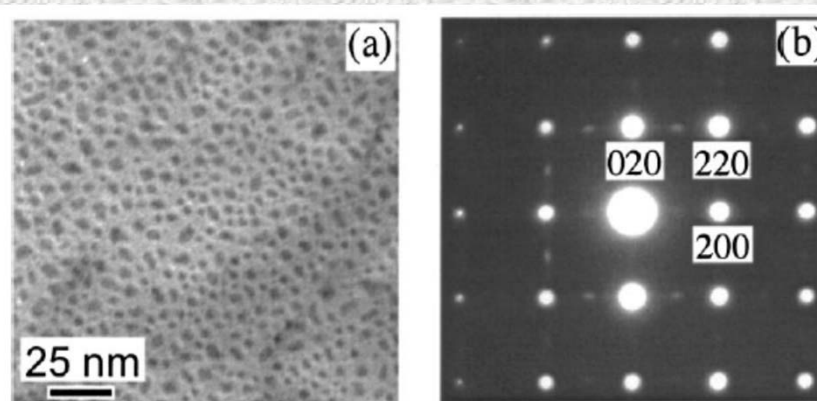

# Metastable Crystal Phases

## Thermodynamic factors

Surface-tension effects increase with decreasing crystal size, a compressive force (at atmospheric pressure) favor the high-pressure phase, the crystals try to adopt the phase with the lowest surface energy (each crystal face having a different surface energy)

## Kinetic factors

Phase transitions tend to be initiated at defects, small nanocrystals are often defect-free, a phase transition, which would occur thermodynamically, will be kinetically hindered

# Metastable Crystal Phases

Thermodynamic factors

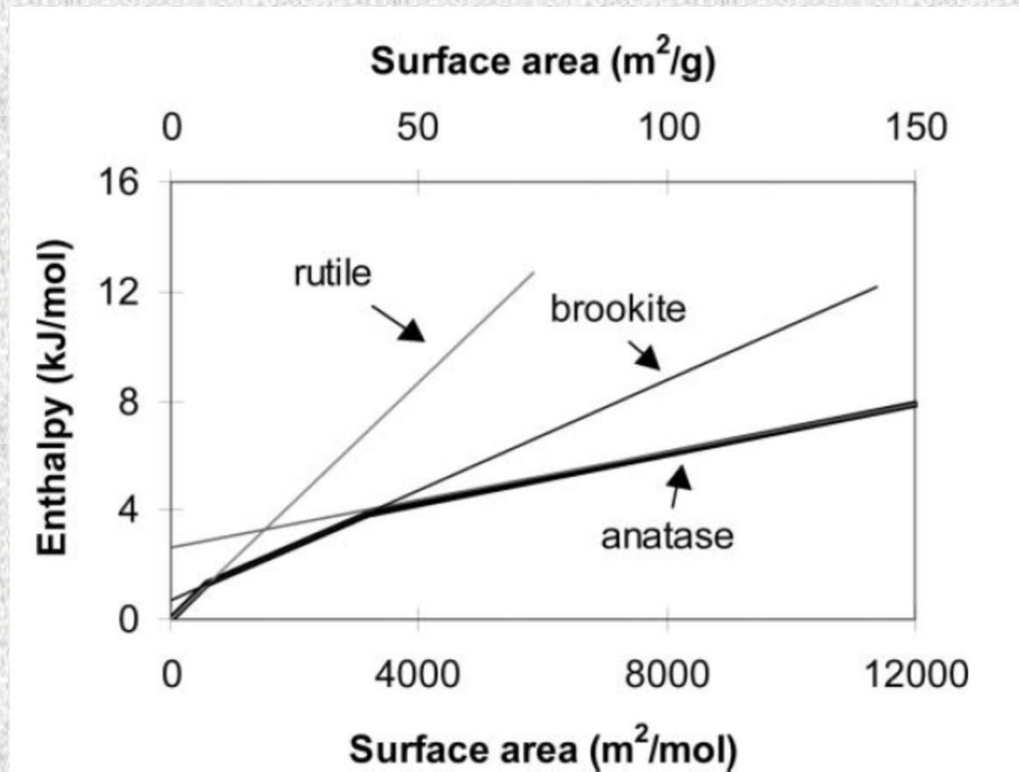



# Scattering/Interference of Light

**Scattering of light in random or ordered nanostructures resulting in stimulated emission (lasing)**

**The grain boundaries between nanocrystals**

- to confine excitons in the nanocrystals because of potential barriers at the grain boundaries
- form cavity mirrors, which are caused by changes in the refractive index at grain boundaries

**Constructive interference in random 'laser-ring cavities' (closed scattering circuits between elementary particles in a secondary particle)**

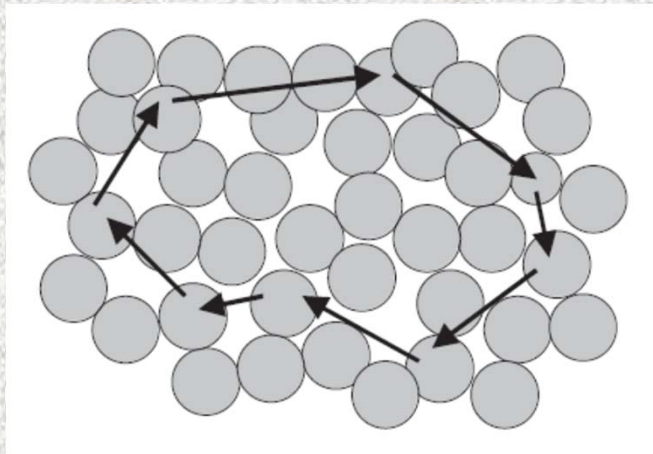

# Depletion of Charge

**Charge depletion - removal of free electrons, based on the screening length for electrons in a material**

**The electric fields of ions in conducting solids are reduced by the cloud of conduction electrons**

**Dye-sensitized solar cell (DSSC)**

**An absorber (an organometallic dye, a semiconductor) adsorbed onto a porous, high-bandgap semiconductor (TiO<sub>2</sub>), insulating, injection of electrons from the photoexcited absorber renders it conductive**

**Electron transport takes place in the porous oxide primarily by diffusion the size of the porous oxide particles 20 nm**

- **The high surface area of the oxide allows efficient absorption of light by even a monomolecular layer of dye, resulting in efficient electron transfer from the excited dye to the oxide**
- **Small particle size allows complete depletion of electrons from the individual particles by the electrolyte**

# Impurity (Dopants) Exclusion

**Doped bulk semiconductor - averaged throughout a macroscopic volume – typical doping density  $10^{18} \text{ cm}^{-3}$**

**Nanoparticles - often zero impurity and defect concentrations**

**Spherical nanoparticles of 5 nm size**

**1 nanoparticle with a doping density of  $10^{18} \text{ cm}^{-3}$  - less than one dopant atom on average!!**

**The energy of the dopant in NP is larger than in a bulk pieces of the semiconductor**

**Thermodynamically unfavorable for the dopant to remain in a NP**

**Excluded from the semiconductor NP volume onto the particle surface - surface segregation**

**Does not apply to a solid solution, e.g., (Cd, Zn)S**

# Defect Exclusion

**Bulk semiconductors – can only minimize defects**

**Defect formation is thermodynamically unfavorable for very small crystals (the upper limit from several nm to several tens of nm)**

**Very small nanocrystals are often structurally perfect**

# Ballistic Transport

**Ballistic transport of electrons - transport over distances with no scattering of the electrons (distances less than the mean free electron path)**

**Nanotubes and nanowires - the mean free path hundreds of nm greater than the dimension of devices made with these nanotubes/wires**

**Advantages of ballistic electron transport**

- less energy loss (as heating)**
- more speed**

**Rectification**

**Logic gating**

# Superparamagnetic Effect

The energy required to change the direction of magnetization of small magnetic nanoparticles is  $\leq kT$ , causing random reversal of magnetization

The mean critical domain diameters

Elemental Fe 10–20 nm

Magnetite 110–130 nm

Nanoparticles with dimensions less than the mean critical domain diameter have only **one magnetic domain** per particle

Above the **blocking temperature**, the magnetization of the nanoparticles thus follows the external field (negligible retentivity and coercivity)

The behavior corresponds to a paramagnetic atom, but with an absolute magnetization a factor of  $10^4$  larger

= **“Superparamagnetism”**

# Thermomagnetic Curves

M-T (a) and  $M^{-1}$ -T (b) curves of Ni nanoparticles

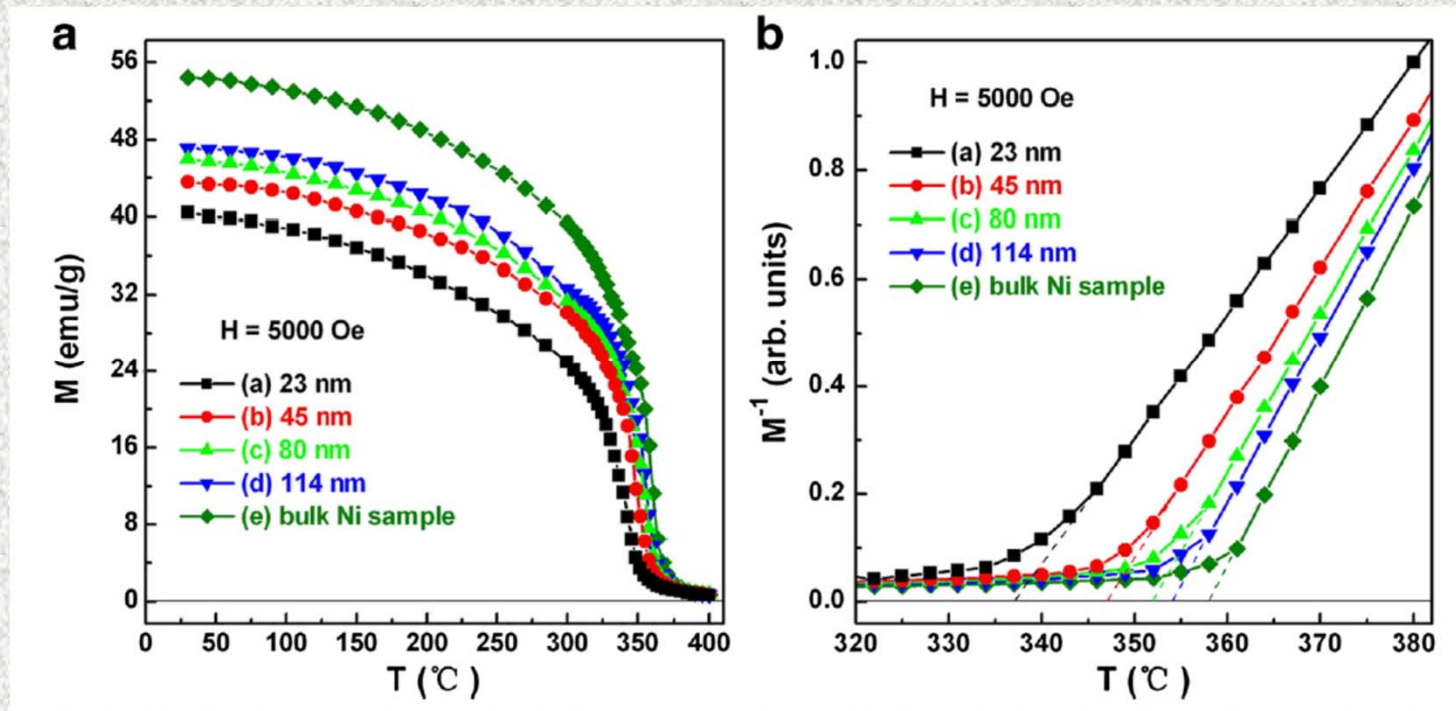

The horizontal axis intercept of  $M^{-1}$ -T curve is the Curie temperature  $T_C$  of ferromagnetic materials

# The Curie Temperature

The temperature at which a ferromagnetic element starts to lose its magnetism and becomes paramagnetic

Fe	768 °C
Co	1115 °C
Ni	362 °C (631 K)
Gd	19 °C

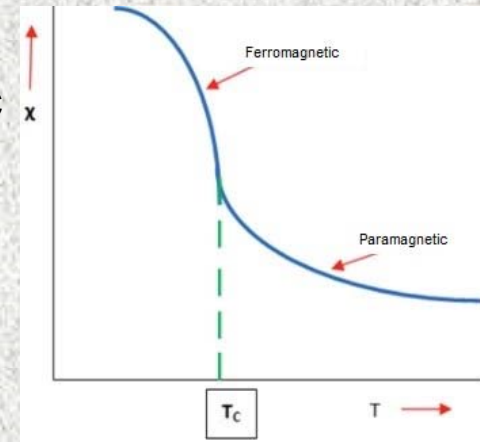

$$\frac{T_c(D)}{T_{c0}} = \exp\left(-\frac{2S_{vib}}{3R} \frac{1}{D/6h - 1}\right)$$

$T_c(D)$  = the Curie temp. of ferromagnetic nanomaterial with the average size  $D$

$T_{c0}$  = the Curie temp. of bulk

$S_{vib}$  = the vibrational part of the overall melting entropy  $S_m$  ( $S_m \sim S_{vib}$ )

$R$  = the ideal gas constant

$h$  = the atomic diameter

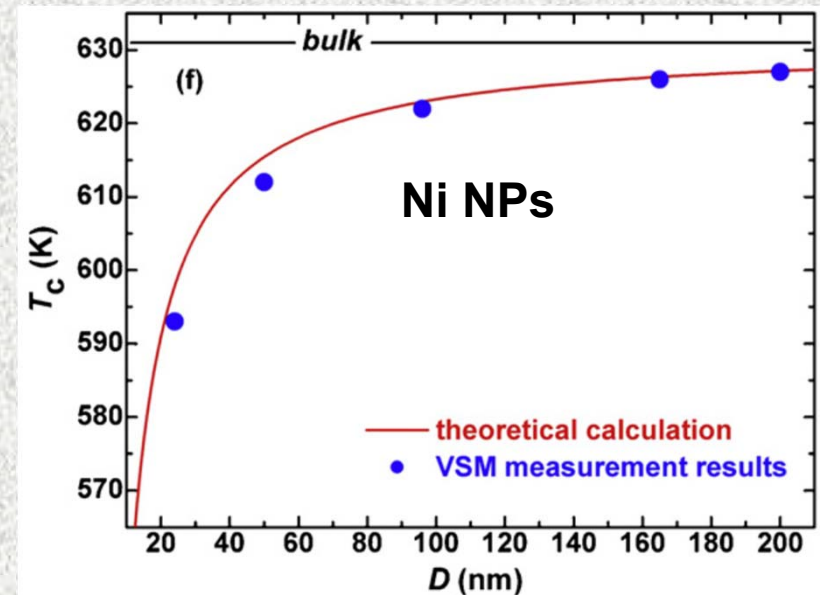



# The Curie Temperature

$$T_{Cn} = T_{Cb} \left( 1 - \frac{6\mu}{n^{1/3} C^{2/3} \pi k^2} \right),$$

$$n = \frac{\rho \frac{4}{3} \pi \left(\frac{D}{2}\right)^3}{M} N_A,$$

$T_{Cn}$  = the Curie temp. of ferromagnetic nanomaterial with the average size  $D$   
 $T_{Cb}$  = the Curie temp. of bulk  
 $n$  = number of atoms in a nanoparticle  
 $\mu$  = the shape factor (0.806 sphere)  
 $C$  = number of atoms in a unit cell (4 for fcc)  
 $k$  = ratio b/w atomic radius and cell parameter ( $\sqrt{2}/4$  for fcc)

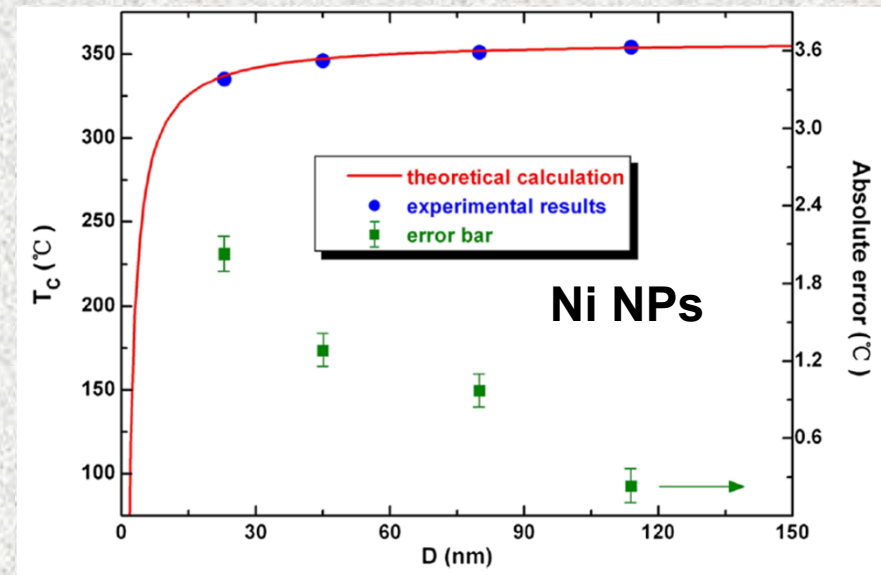

# Size Dependence of Magnetic Parameters

Room-temperature hysteresis loops of Ni nanoparticles

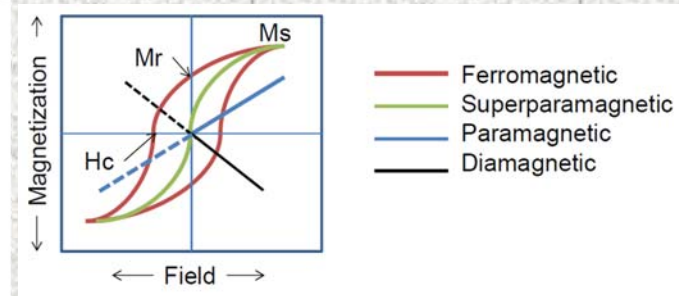
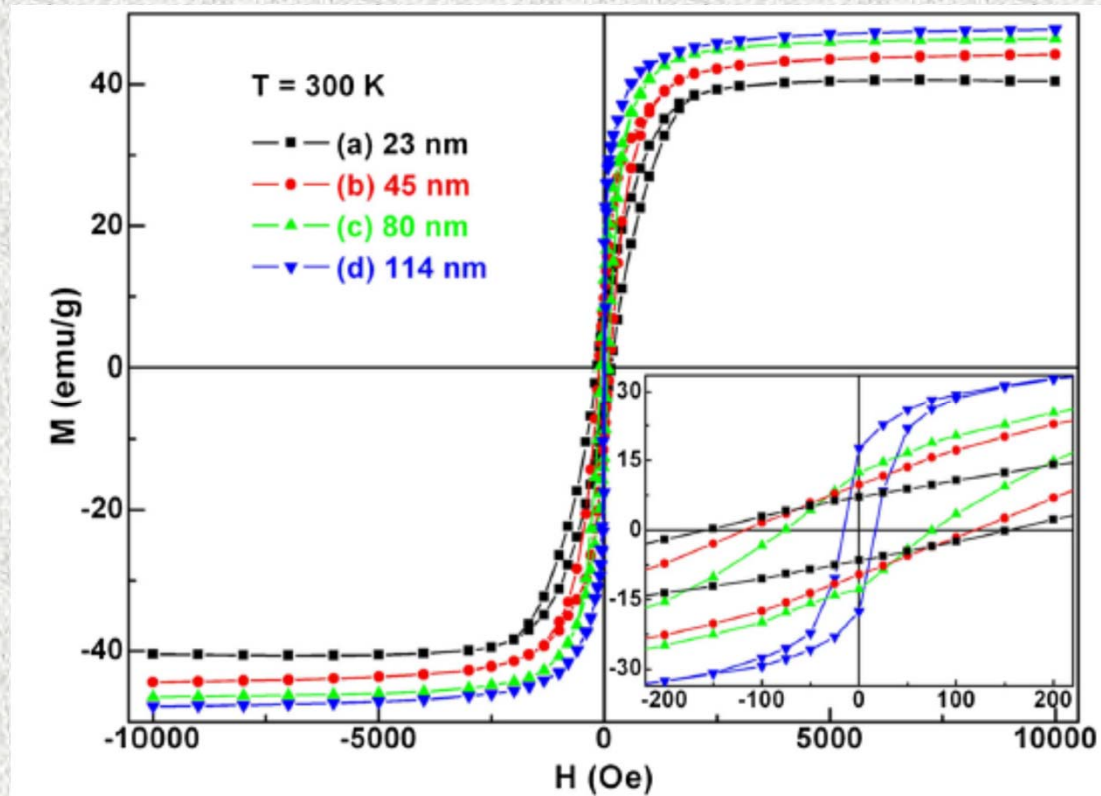

Saturation magnetization  $M_S$ , remanent magnetization  $M_r$ , and coercivity  $H_C$  of spherical Ni nanoparticles

# The Saturation Magnetization

Iron oxide  $\text{Fe}_3\text{O}_4$  nanoparticles hysteresis loops  
Mass magnetization values at 1.5 T

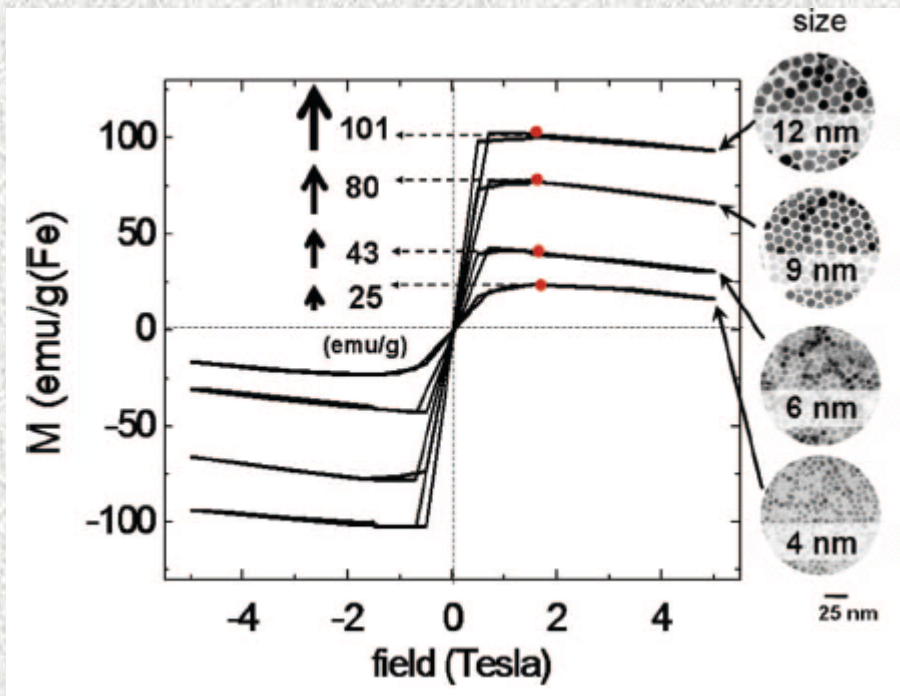

The saturation magnetization  $M_s$  decreases with decreasing particle size (increasing surface area)

As the surface-to-volume ratio increases with decreasing particle size, the magnetically dead layer fraction increases

# Size Dependence of Magnetic Parameters

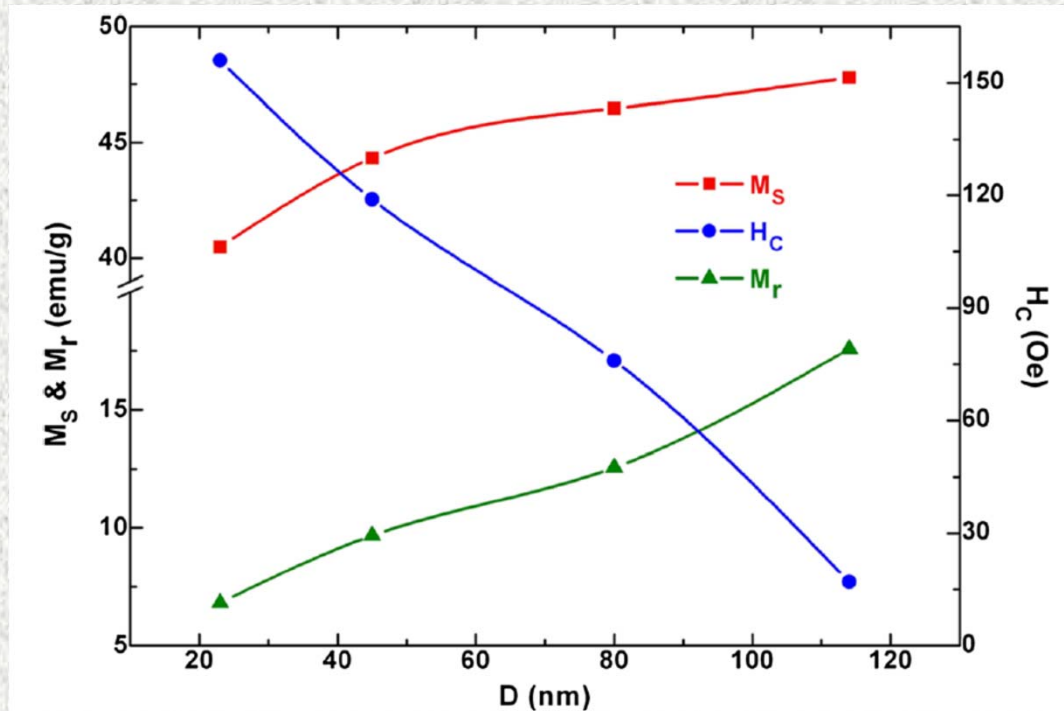

Saturation magnetization  $M_S$ , remanent magnetization  $M_r$ , and coercivity  $H_C$  of spherical Ni nanoparticles

# Dictionary of Used Terms

Transmission Electron Microscopy = prozařovací EM

Scanning Electron Microscopy = rastrovací /řádkovací EM