

F4280: Background information to PECVD-CCP laboratory exercise

Miroslav Michlíček, Lenka Zajíčková

michlicekm@mail.muni.cz, lenkaz@physics.muni.cz

Details of PECVD-CCP laboratory exercise

The goal of this exercise is to understand low pressure radio frequency (RF) capacitive coupled plasmas (CCP) that are used for PECVD (including plasma polymerization).

Here is the list of areas that you should understand:

- ▶ **Vacuum systems.** Useful hints can be found later in the presentation. If necessary check literature on vacuum technology - D. Smith book, chapter 2, uploaded to IS study materials.
- ▶ **What is plasma and how to generate it.**
- ▶ **Types of reactions occurring in plasma.**
- ▶ **What is plasma sheath.**
- ▶ **Generation and basic properties of RF capacitively coupled plasmas.** Important terms: RF generator, matching box, blocking capacitor, capacitive plasma sheath, capacitive voltage divider, dc self-bias
- ▶ **Plasma enhanced CVD.**

Experimental PECVD system

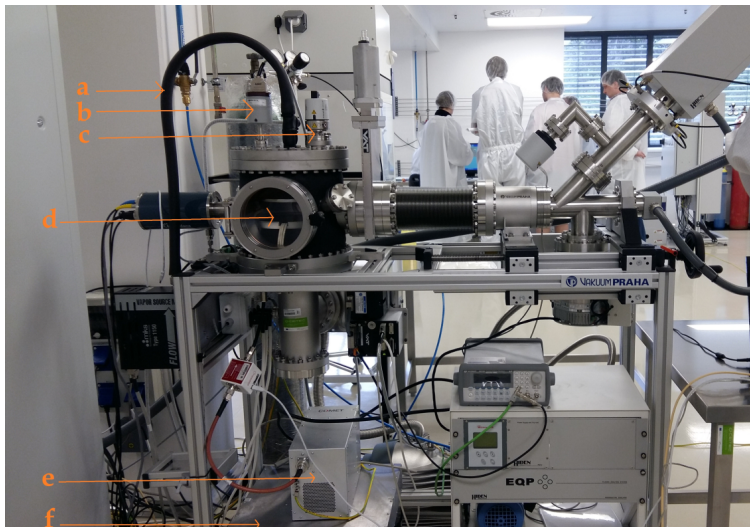

Chamber

- ▶ What will be the **pressure?** - LP - glass, PMMA, stainless steel... all with appropriate sealings - KF and CF standards, swagelok
- ▶ design is more of an engineering problem - size of samples, windows + much more
- ▶ geometry affects electric fields, gas flow patterns, possibly temperature distribution
- ▶ ⇒ Chamber itself influences process - standard - **GEC** reference cell

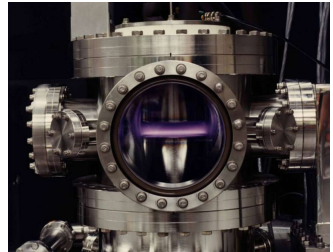
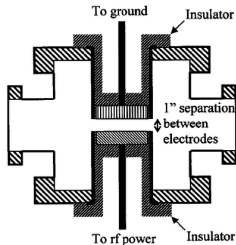
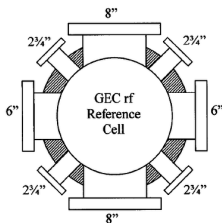

Vacuum sealing

- ▶ KF/QF/DN - Klein Flange (KF), Quick Flange (QF) - elastomer O-rign + clamp, lower vacuum
- ▶ CF - Conflat - single-use copper gasket - bakeable - UHV vacuum

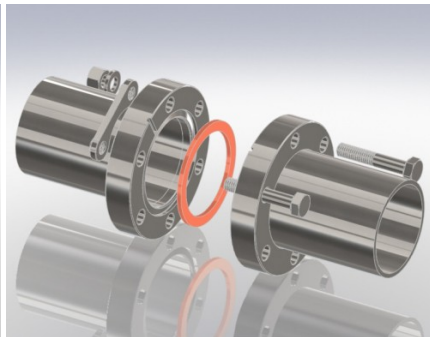
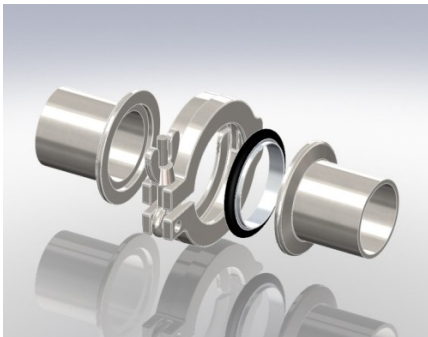

Vacuum sealing II

- ▶ Swagelok systems - mainly for gas delivery - beware of inch-related measures (Anglo-American)
- ▶ others - ISO flange, Wheeler flange

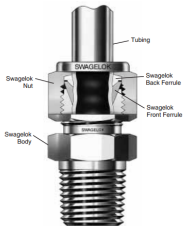

Pumping

- ▶ what types of pumps do we have? Which of them are relevant?
- ▶ oil vs dry pumps - tricks?
- ▶ it is rather useful to know principle and limitations of different types of pumps... there is not enough space for that.

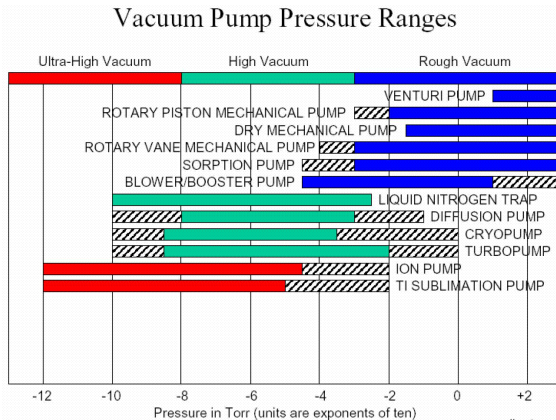

Pumping II example

- ▶ what type of pump is this?
- ▶ can it pump atmospheric pressure?

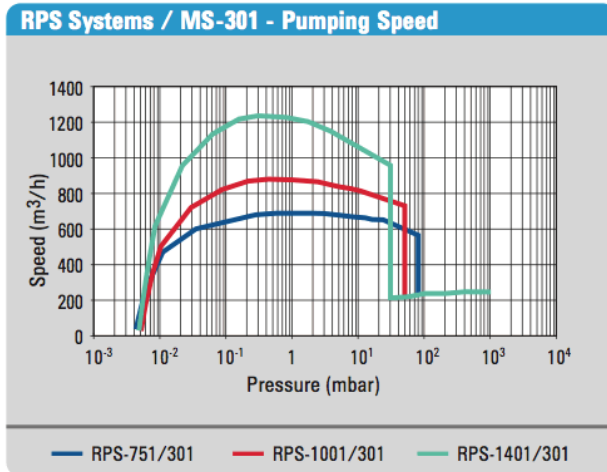

Pressure measurement

- ▶ U tube? Absolute vs relative gauges
- ▶ a single wide range gauge is often used (usually consists of Pirani + Ionization)
- ▶ additionally, absolute measurement by a capacitron (Baratron) - zero error

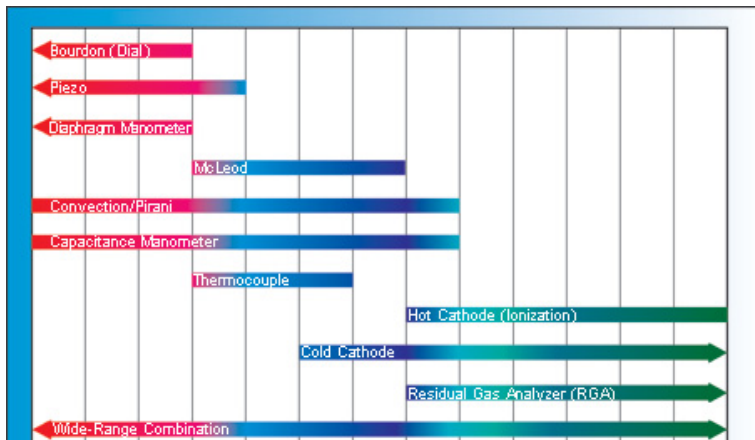

Gases

- ▶ how to deliver gases? gas bottle \approx 200 bar
- ▶ mass flow meters - **K-factors**

▶ Internal structure

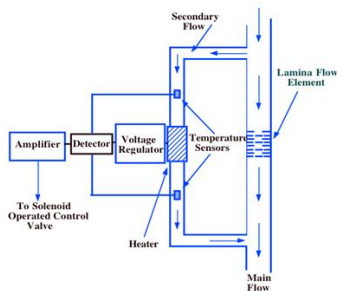
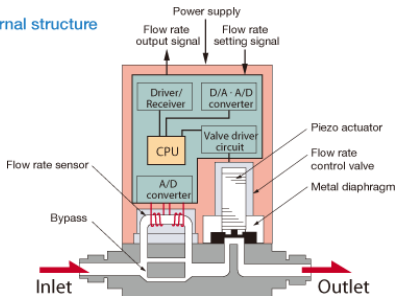

for a high flow - a floating ball flow meter

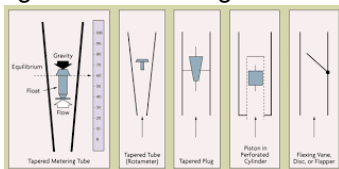

Gases II

- ▶ homogeneity of the gas mixture - gas mixers
- ▶ inlet of gases into the chamber - shower head
- ▶ depending on the gas, pressure and geometry we can distinguish degree of mixing
 - ▶ plug flow
 - ▶ back-mixing flow
 - ▶ well mixed flow
- ▶ Throttling valves to adjust pumping speed and working pressure

$$p = p_0 \exp\left(-\frac{S}{V}t\right) \quad (1)$$

For independent measurement of the gas flow (leak rate, liquid vapors):

$$Q = \frac{\Delta p}{\Delta t} \frac{V}{p_{\text{atm}}} \quad (2)$$

Electric Power

- ▶ Choosing a frequency - DC and AC

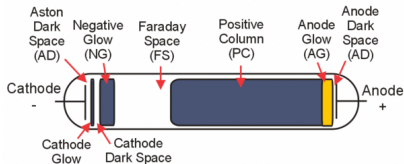

- ▶ At low frequency, discharge basically is still DC only with changing polarity of electrodes.
- ▶ how to choose frequency ω to get something new?
- ▶ important frequencies are $\omega_{p1,i}$ and $\omega_{p1,e}$
- ▶ capacitive and inductive coupling, microwave discharges

$$\omega_{pl}^2 = \frac{n_e e^2}{m \epsilon} \quad (3)$$

CCP discharges

- ▶ capacitive coupling via sheaths, most used frequency 13.56 MHz
- ▶ versatile, large area processing, **ion bombardment** esp. reactive ion etching (RIE)
- ▶ rather complicated for understanding - heating mechanisms, eedf
- ▶ potentials in CCP discharges - iedf, higher harmonics
- ▶ CCP discharge asymmetry - geometric/electric
- ▶ independent energy and ion flux - dual frequency and other tricks
- ▶ generator requires a matching unit (to achieve load of 50Ω)

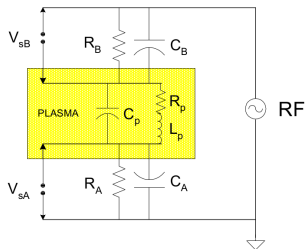
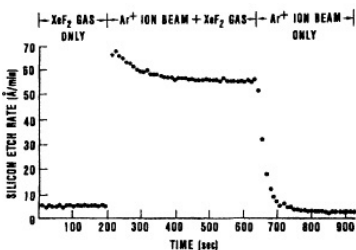

Potentials in CCP discharges

- ▶ Plasma must have higher potential than the most positive electrode
- ▶ usually there are only two, grounded tends to be naturally larger - with no net current \Rightarrow **self-bias**

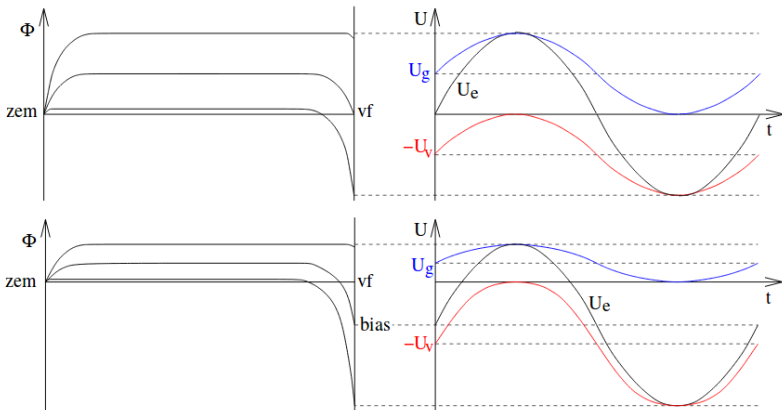

Optional accessories

- ▶ **Temperature control** - both cooling and heating + feedback
- ▶ **Leak detection**
- ▶ Various **characterization and process control** techniques
 - ▶ Light - spectroscopy using emission or absorption
 - ▶ Charged particles + electric fields -
 - ▶ Neutral species - mass spectrometry, laser induced fluorescence
 - ▶ Power signal
- ▶ Sample movement and manipulation - mechanical clamping and electrostatic chuck

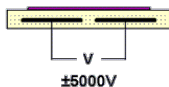
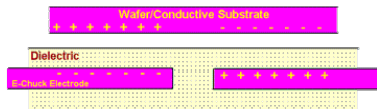

'D' Electrodes
(Thick Film)

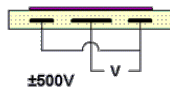

Concentric Rings
(Thin Film)

Additional reading and info:

Books covering similar topics:

- ▶ **General thin film deposition (easy)** - Thin-Film Deposition: Principles and Practise, D. Smith
- ▶ **General plasma (easy)** - Principles of Plasma Processing, F. Chen and J. Chang
- ▶ **General plasma (difficult)** - Principles of Plasma Discharges and Materials Processing, Lieberman M. and Lichtenberg A.
- ▶ **CCP (difficult)** - Physics of Radio-Frequency Plasmas, Pascal Chabert

Courses - Vakuová fyzika 1, 2 (Czech only), Fyzika plazmatu 3 (CCP mainly)