

# Astronomical Institute in the High Tatras

## Study, science and career path



Martin Vaňko

*Astronomical Institute, Slovak Academy of Sciences  
Tatranská Lomnica 059 60, Vysoké Tatry*



• *Lomnický štít, 2 632 m.*



• *Stará Lesná, 815 m.*



• *Skalnaté Pleso, 1 786m.*

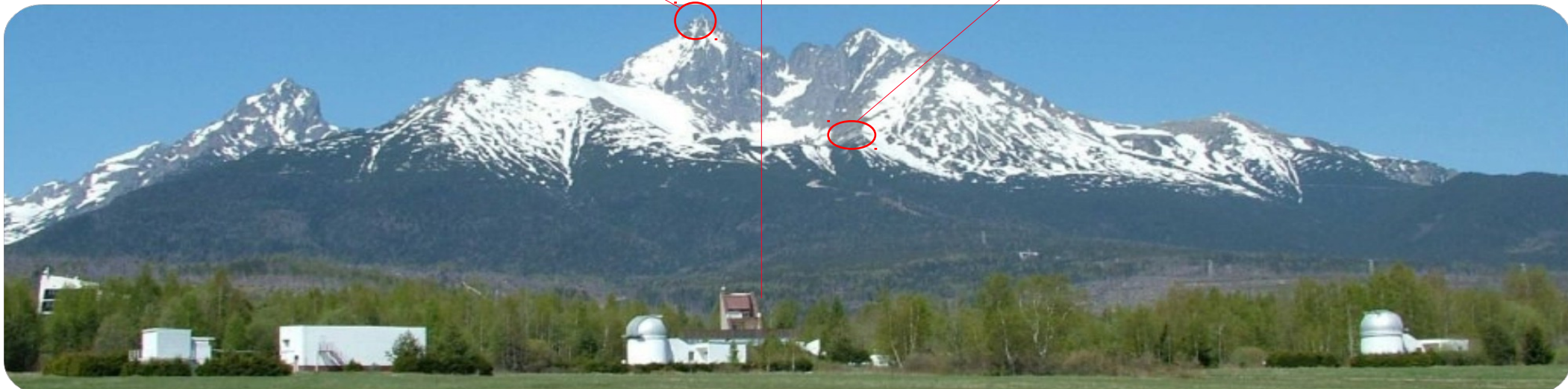



# The History of Institute

✓ Climatologist and Astronomer

\* *Stará Boleslav 1901 - † Brandýs n. Labem 1965*

✓ Building an observatory at Skalnaté Pleso  
(1941-1943).

✓ First observation at Skalnaté Pleso – solar  
photosphere – solar spots on **September 19th, 1943**

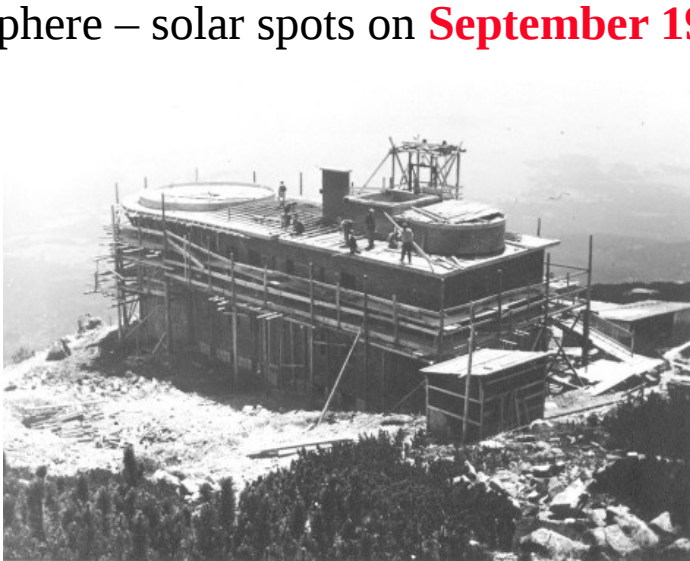
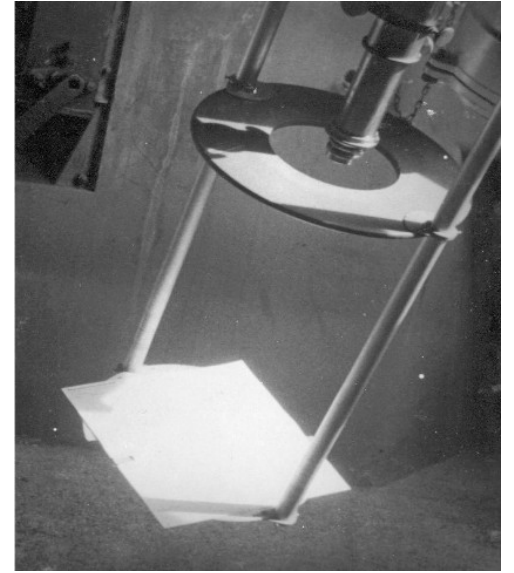
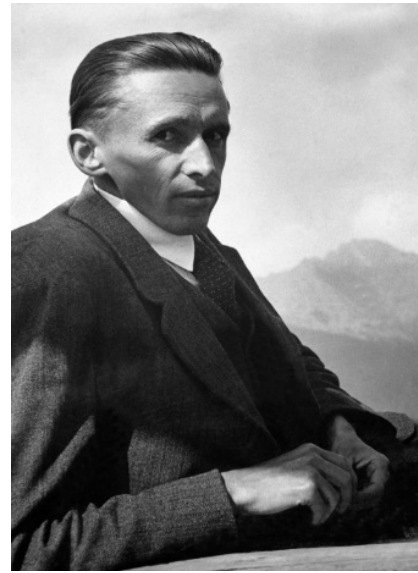

# The History of Institute

- ✓ *Atlas Coeli Skalnate Pleso (1951)*

published by *Sky Publishing Corporation* as the *Skalnate Pleso Atlas of the Heavens Skalnate Pleso (1951)*

- ✓ The next Atlases:

*Atlas Eclipticalis, 1950.0 (1958)*

*Atlas Borealis, 1950.0 (1962)*

*Atlas Australis, 1950.0 (1964)*

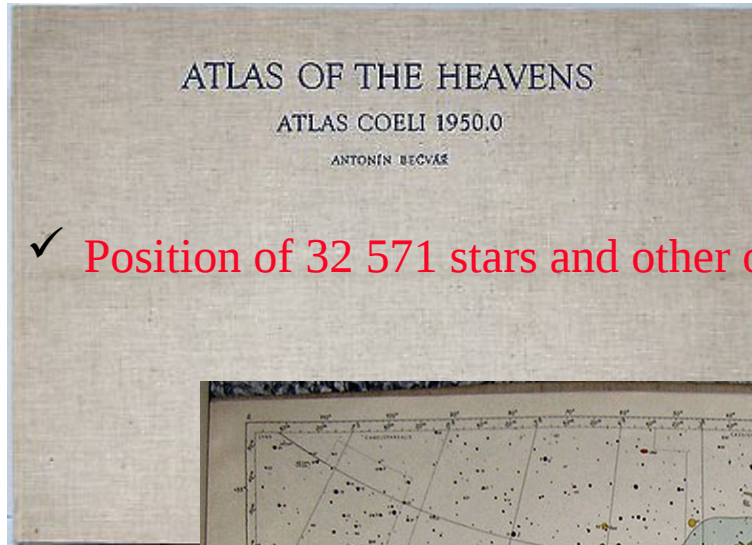

- ✓ Position of 32 571 stars and other objects (clusters, galaxies...)

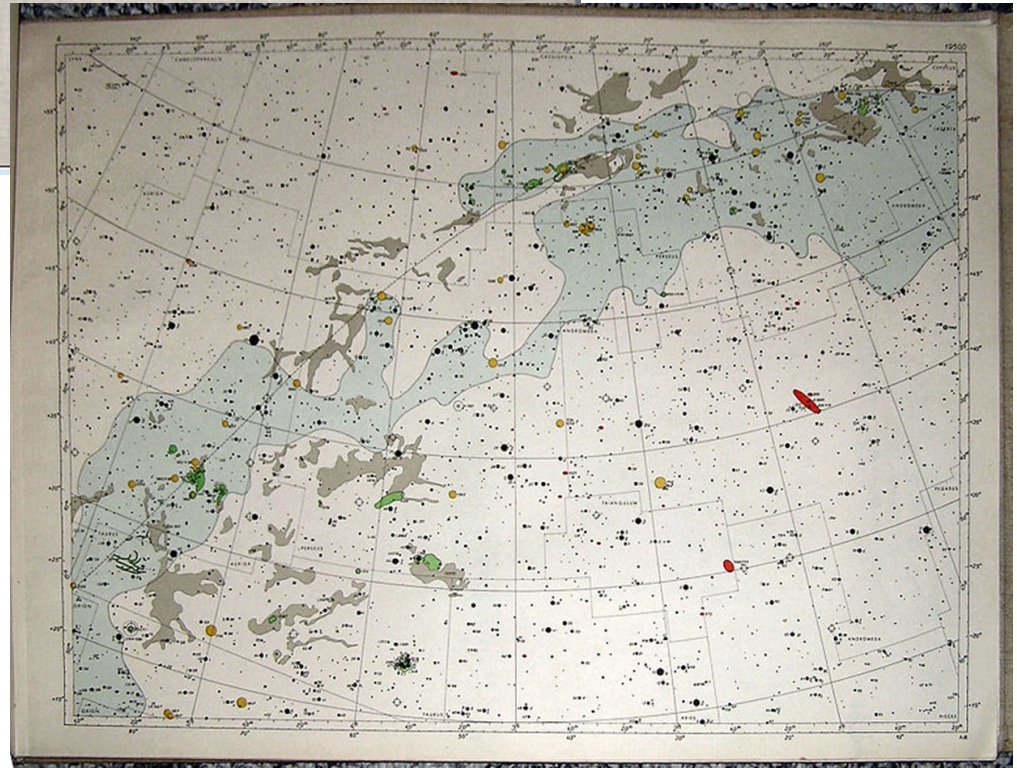



# The History of Institute

kométa		dátum objavu	Jasnosť pri objave (magn.)	maximálna jasnosť	vzdialenosť perihélia (a.j.)	obežná doba roky
1946 II	Pajdušáková-Rotbart-Weber	30.5.1946	7	6	1,02	dlhá
1947 III	Bečvář	27.3.1947	9	9	0,96	dlhá
1948 II	Mrkos	20.12.1947	9,5	9,5	1,50	7 000 000
1948 V	Pajdušáková-Mrkos	15.2.1948	10	8,5	2,11	5 000 000
1948 XII	P/Honda-Mrkos-Pajdušáková	3.12.1948	9	8	0,56	5,22
1951 II	Pajdušáková	4.2.1951	8,5	8	0,72	dlhá
1951 IV	P/Tuttle-Giacobini-Kresák	24.4.1951	10,5	9	1,12	5,47
1952 V	Mrkos	27.4.1952	10	8,5	1,28	600
1953 II	Mrkos	28.11.1952	10	7,5	0,78	dlhá
1953 III	Mrkos-Honda	12.4.1953	9	8,5	1,02	6 000
1954 II	Pajdušáková	3.12.1953	11	9,5	0,07	dlhá
1954 XII	Kresák-Peltier	26.6.1954	9	9	0,68	3 000 000
1954 VIII	Vozárová	28.7.1954	10	8,5	0,75	5 000 000
1955 III	Mrkos	12.6.1955	3,5	3,5	0,53	350
1955 VII	P/Perrine-Mrkos	19.10.1955	9	6	1,15	6,46
1956 III	Mrkos	12.3.1956	9	8	0,84	dlhá
1957 V	Mrkos	29.7.1957	3	0,5	0,35	11 000
1959 IX	Mrkos	3.12.1959	8	5	1,25	2 000 000



## Pozorovanie

## Dátum

## Poznámka

prvá kresba slnečnej fotosféry  
 prvá expozícia meteorickými kamerami  
 prvé skupinové pozorovanie meteorov  
 prvá snímka 0,24-m reflektorom  
 prvá snímka 0,60-m reflektorom

19.9.1943  
 24.9.1943  
 9.8.1944 Perzeidy  
 16.8.1944 hmlovina M17  
 16.10.1944 galaxia M31

# The History of Institute





# The History of Institute



- ✓ The highest place in Slovakia where people live and work (2632m a.s.l.)
- ✓ Building an observatory at Lomnický štít (1957-1962)
- ✓ 20/300 cm ZEISS coronagraph: The first observation of solar prominences in **1962** and the first observation of solar corona in **1964**.

# The History of Institute



- ✓ **1979-1985:** The main building of Astronomical Institute, Slovak Academy of Sciences
- ✓ **People:** 32 scientific fellows, 2 PhD. students, 57 people in total
- ✓ **Science:** The Sun, Variable stars, Exoplanets, Interstellar matter



# The History of InSTITUTE



# Departments and Infrastructure

**Stellar Department**

**Department of Interstellar Matter**

**Department of Solar Physics**

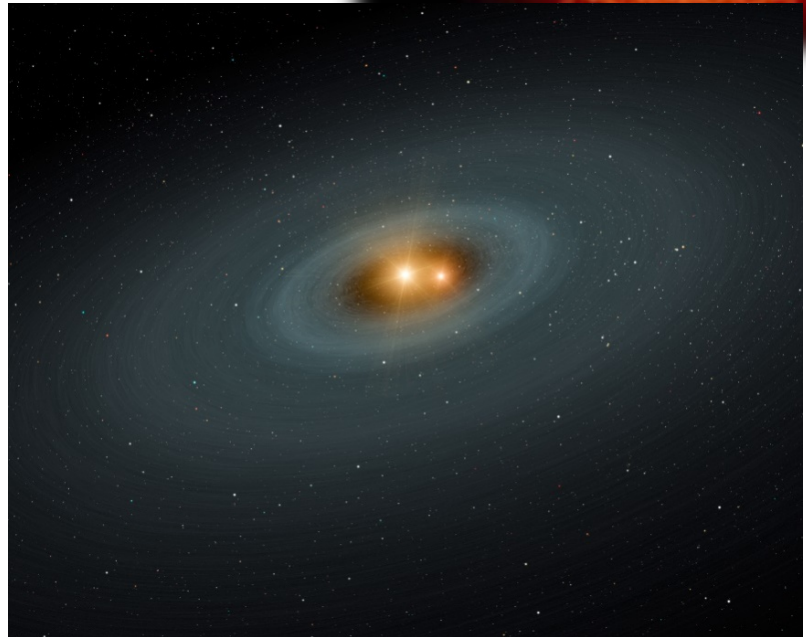



# Stellar Department

SD includes 12 scientific fellows and 3 technicians/observers

SD: fields of study:

## **A) Interacting binaries/Symbiotic stars**

Physical processes during different stages of symbiotic stars activity: mass accretion and outflow, bipolar jets, ionization and radiation scattering in the nebula.

## **B) Binaries and Multiple Stellar systems**

Close binary stars in general, Contact binaries, Active (spotted) binaries, short period group of RS CVn-like systems, Multiple systems of stars with an eclipsing component, Post-common-envelope binaries (with a SD or WD component), High-speed photometry-occultations

## **C) Exoplanets**

Observations: -radial velocities, -planetary transits, -timing convection, day-night heat transfer, chemistry of low temperatures, secondary eclipses, Brown dwarfs

# Department of Interstellar Matter

Here we have 11 researchers, 2 PhD. students and 2 technicians/observers

## Asteroids, Comets and Meteoroids

- Photometry of asteroids: leads to the search for double asteroids and the determination of their physical parameters (composition, sizes, shapes, rotation).
- Photometry of comets: activity of selected cometary nuclei at larger distances from the Sun its influence on the physical and dynamic evolution of these bodies is also carried out in order to understand the production of dust, the morphology of tails, etc.
- Investigation of near-Earth meteoroid populations, including the mass distribution of particles in meteoroid streams and their background, the internal structure of the streams, their age and evolution.
- The Earth's environment is mapped and the composition of meteoric particles entering the Earth's atmosphere is studied using observations from 4 stations of the European Bolide Network in Slovakia, including the spectral bolide camera in Stará Lesna.
- The origin and formation of the Oort cloud, # The dynamical evolution of the small bodies of the Solar system



# Department of Solar Physics

DSP has 10 people and 3 technicians/observers

## **Magnetism, the dynamics and variability of the solar atmosphere**

# the study of the solar photosphere and chromosphere and active phenomena

# using modern spectro-polarimetric, spectroscopic and photometric observations obtained with solar telescopes of the highest world level (Gregor, VTT, SST, THEMIS) and satellites as well

# the study of the solar corona and its structures (prominences, coronal holes, condensations) and

# the study of Sun-Earth relations using data obtained with modern infrastructure at Lomnický štít observatory

# the study of processes and propagation of energy during active phenomena in the solar atmosphere, mutual connections between large-scale manifestations of solar activity (eruptions, coronal mass ejections, EUV waves).

# Instrumentation – Stará Lesná observatory

**Telescope:** 61cm (24 inch) Zeiss Jena Cassegrain reflector ( $f = 750\text{cm}$ )

**Detector:** CCD kamera FLI ML 3041, filtre *UBVRI* (Bessell), chip  $2048 \times 2048$ , pixel size  $15 \times 15 \mu\text{m}$ , FoV  $14' \times 14'$ .

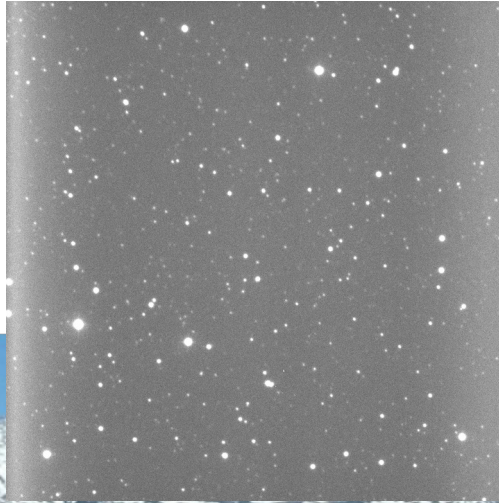



# Instrumentation – Stará Lesná observatory

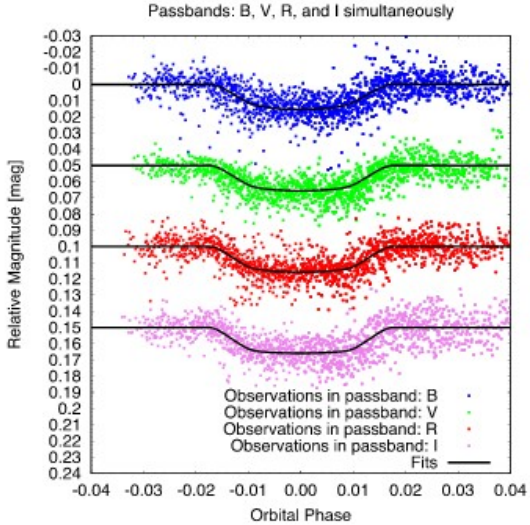
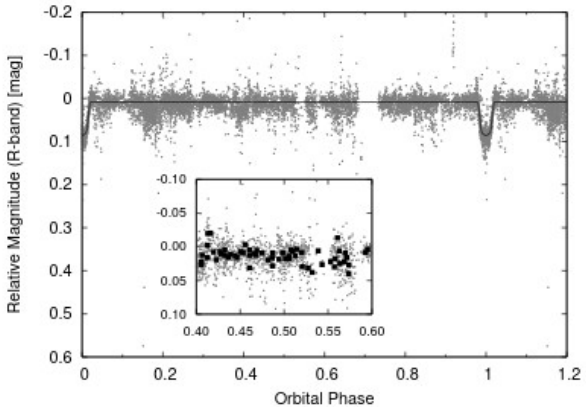
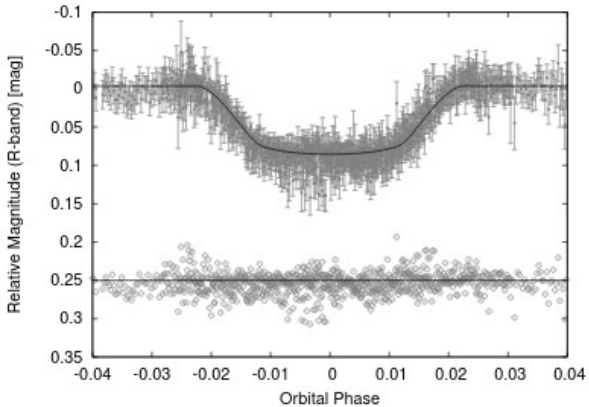
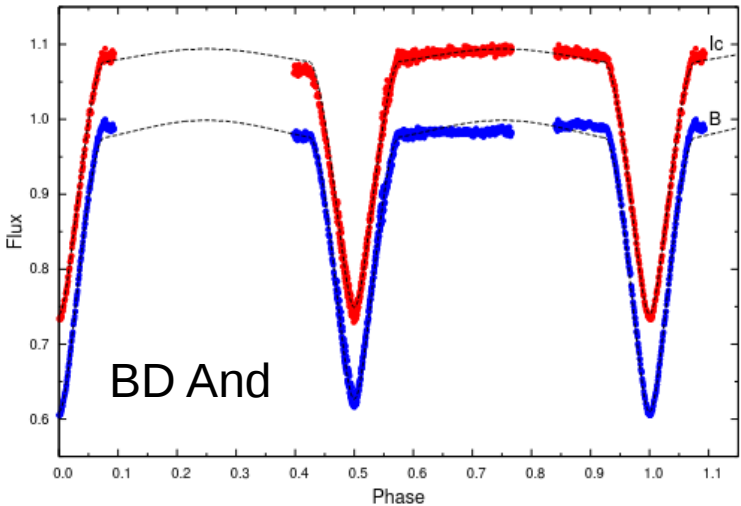
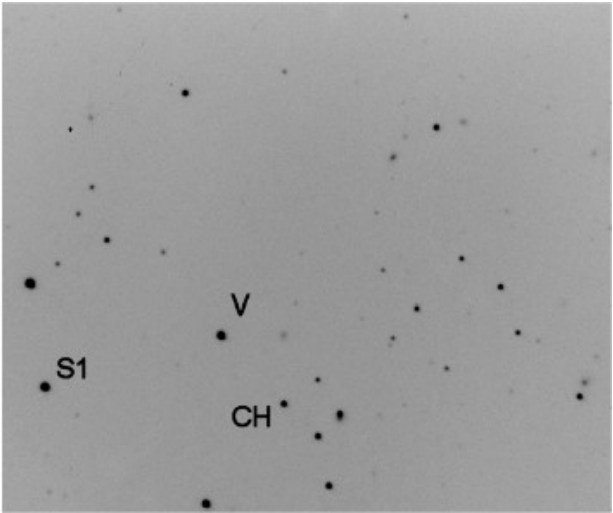
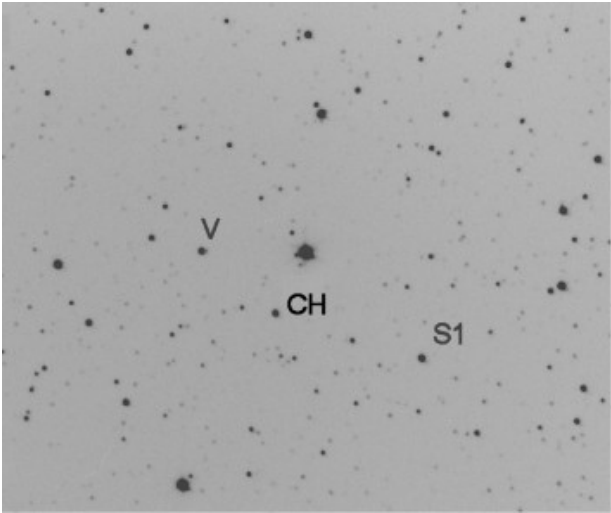

XO-6b

J221550.6+495611 in NGC 7243 - candidate

# Instrumentation – Stará Lesná observatory

**Telescope:** 61cm (24 inch) Zeiss Jena  
Cassegrain reflector ( $f = 750\text{cm}$ )

**eShel spectrograph** design & parameters



- **Littrow design with  $f/5$** , prism cross-disperser, 125mm collimator
- **fiber-fed, R2 échelle grating, 79 grooves/mm**, spectral resolution  **$R=11000$**
- useful spectral range: **24 orders covering 4100-7600 Å**, 50 micron object fiber, 200 micron calibration fiber,
- calibration lamps: **ThAr, Tungsten, blue LED**
- CCD detector: ATIK 460EX camera,  $f/6$  FIGU, WATEC 120n guiding cam.



# Instrumentation – Stará Lesná observatory



1 – calibration unit

2 – FIGU Fiber Injection and Guide Unit

3 – spectrograph

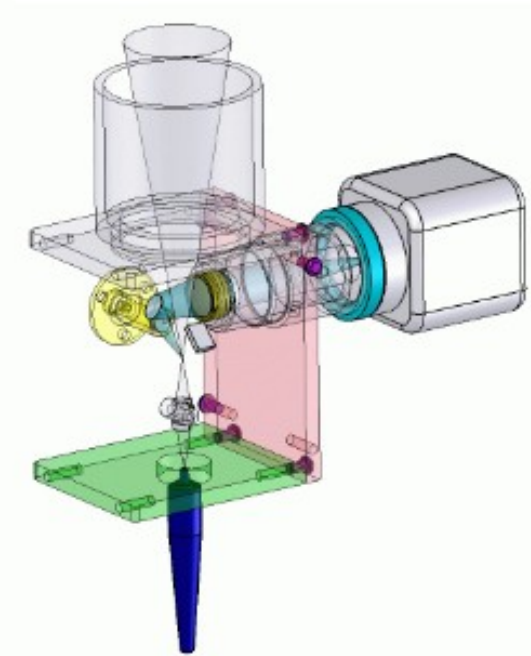
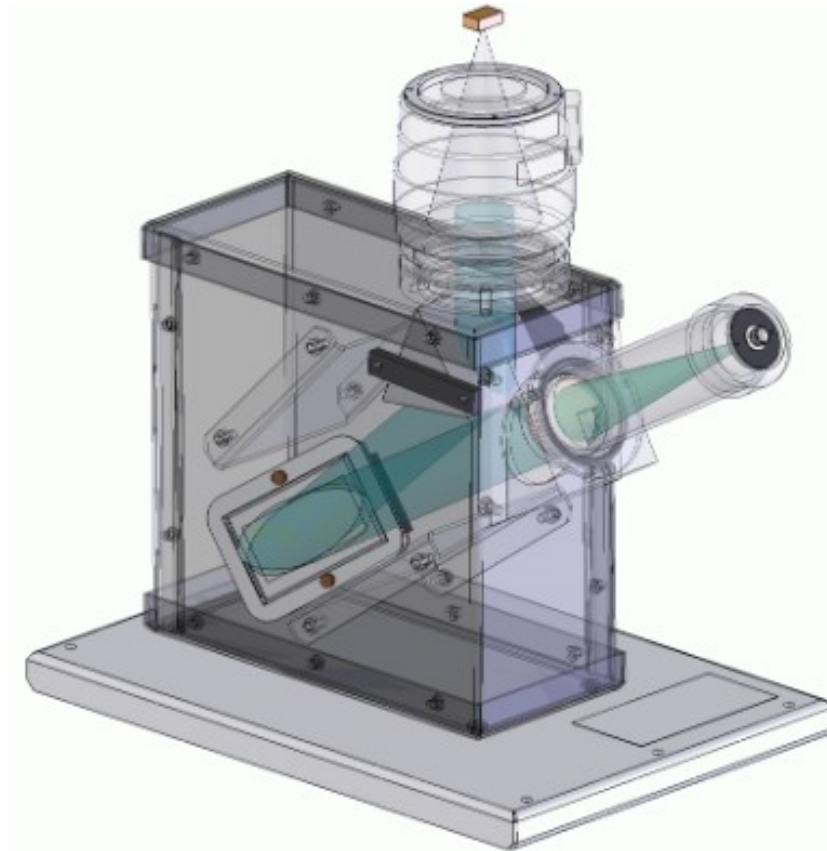

EShel and FIGU optical layout



# Instrumentation – Stará Lesná observatory

## Echelle orders layout

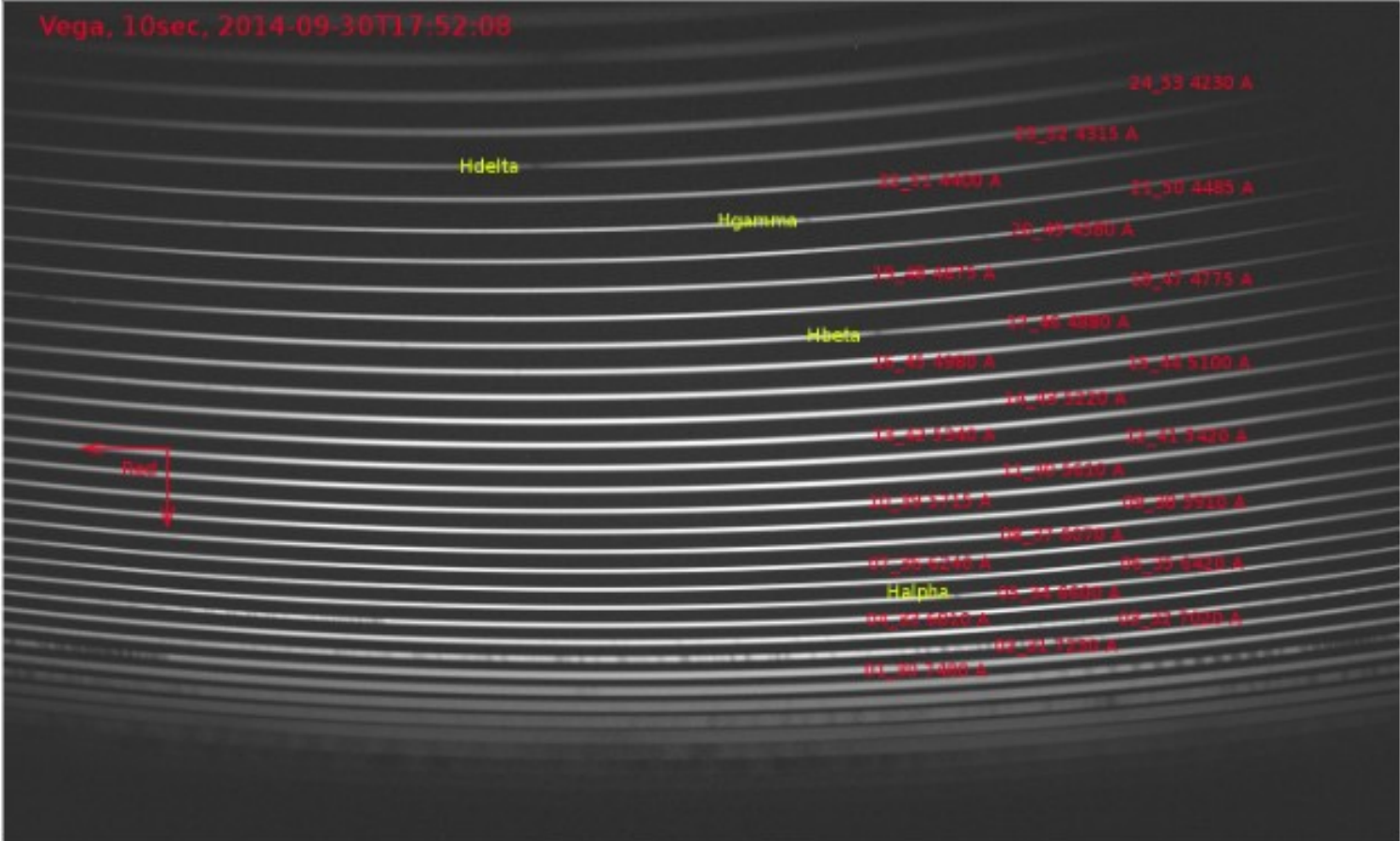

# Instrumentation – Stará Lesná observatory

## ThAr spectrum

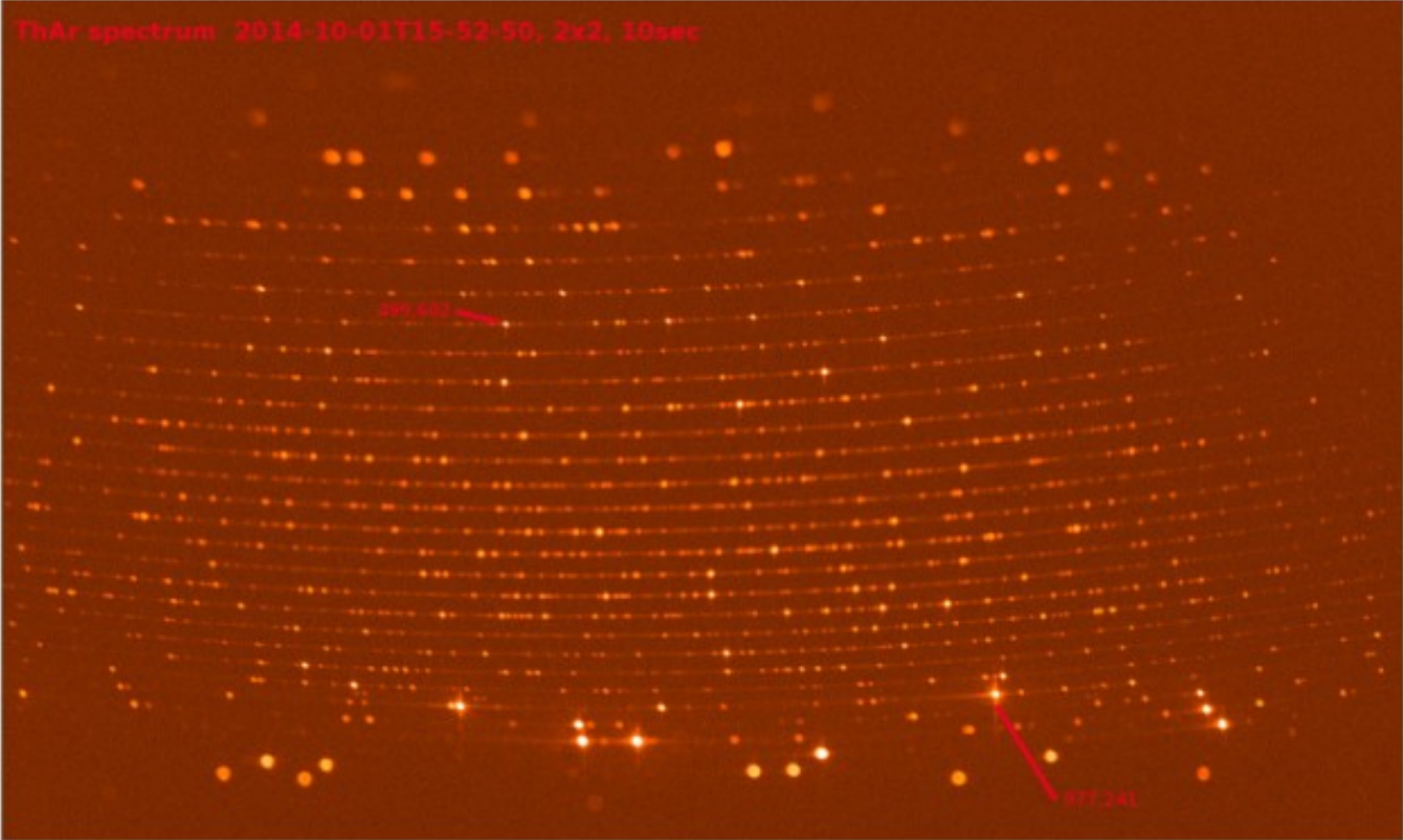

# Instrumentation – Skalnaté Pleso observatory

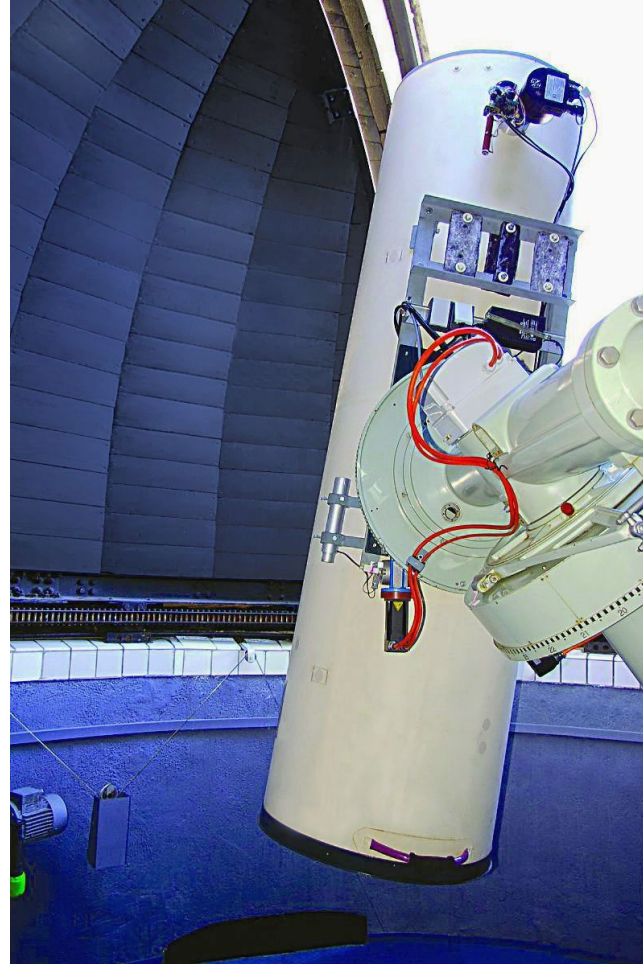

Cena d'alekohľadu: **1012 800 €**

Priemer väčšieho zrkadla: **130 cm**

Priemer menšieho zrkadla: **45 cm**

Hrúbka: **5 cm**

Váha prístroja: **7 ton**

Ďalekohľad kalibrovali na najbližšie jasné hviezdy, prvá hviezda bola Altajr v súhvezdí Orla (16,73 svetelného roka od Zeme).



Cena  
ďalekohľadu:  
**1 012 800 €**

Priemer  
väčšieho zrkadla:  
**130 cm**

Hrúbka:  
**5 cm**

Priemer  
menšieho  
zrkadla:  
**45 cm**

Váha prístroja:  
**7 ton**

Ďalekohľad kalibrovali na  
najbližšie jasné hviezdy, prvá  
hviezda bola Altajr v súhvezdí Orla  
(16,73 svetelného roka od Zeme).

Vacuum facility for coating mirrors (aluminium, silver, protective layers)



# Instrumentation – Skalnaté Pleso observatory

**Telescope:** 1.3m Nasmyth-Cassegrain reflector (f=10.4m); ASTELCO Systems GmbH, Germany

**Detector:** MUSICOS = Multi-Site COntinuous Spectroscopy, fiber-fed and optical bench-mounted

- Littrow design, FIGU, fibers & calibration lamps from Shelyak, 31.6 lines/mm, R2 échelle, 128x254mm
- 56 orders covering 4190-7200 Å (limited by the chip size), spectral resolution **R=38000**,
- magnitude limit **V=11**, **SNR=15** in **15 minutes exposure**.

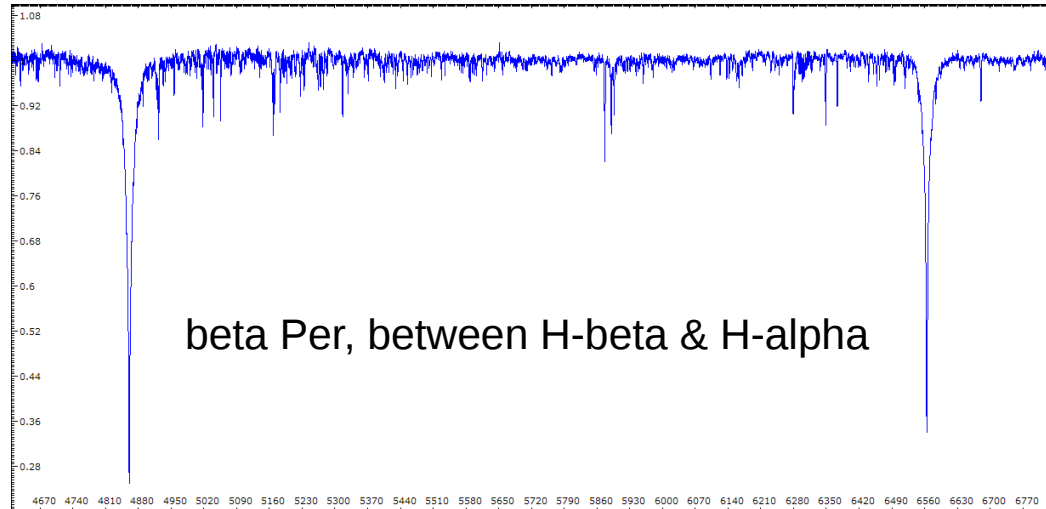

**Brightness-limited RV precision is about 20 m/s for MUSICOS while only 160 m/s for eShel for a 9 mag star**

# Instrumentation – Skalnaté Pleso observatory

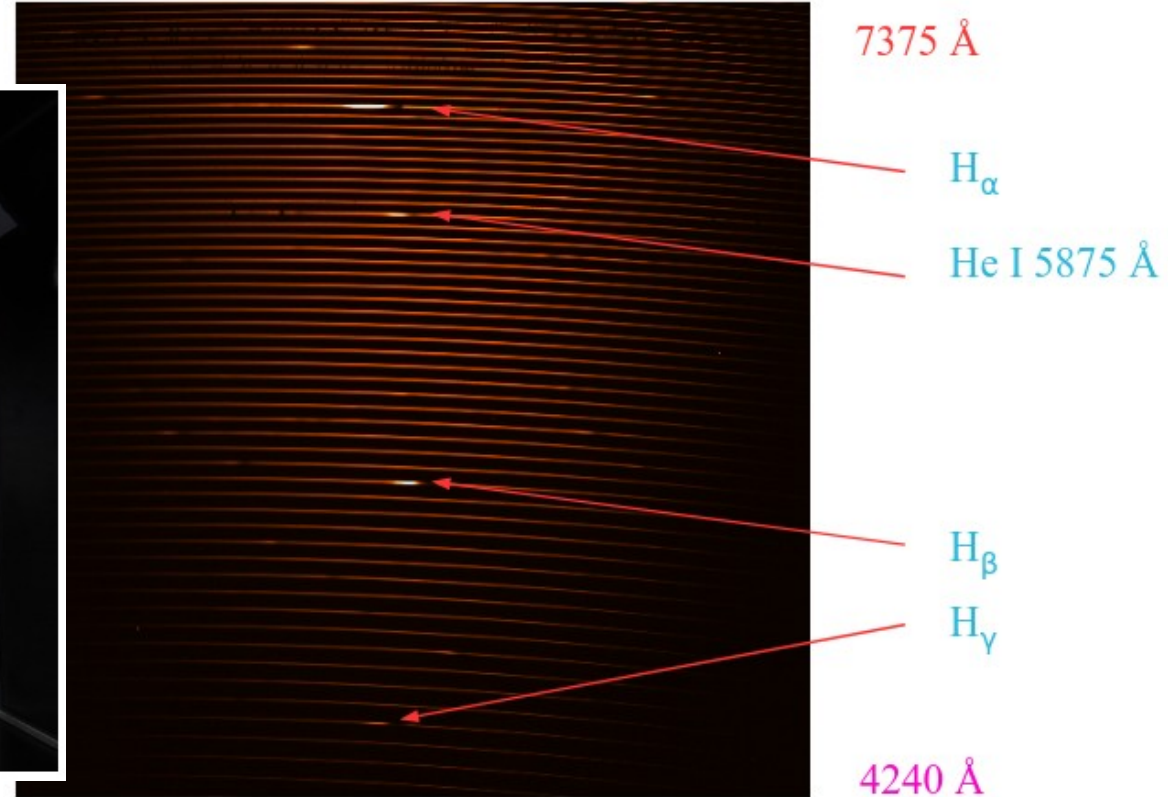
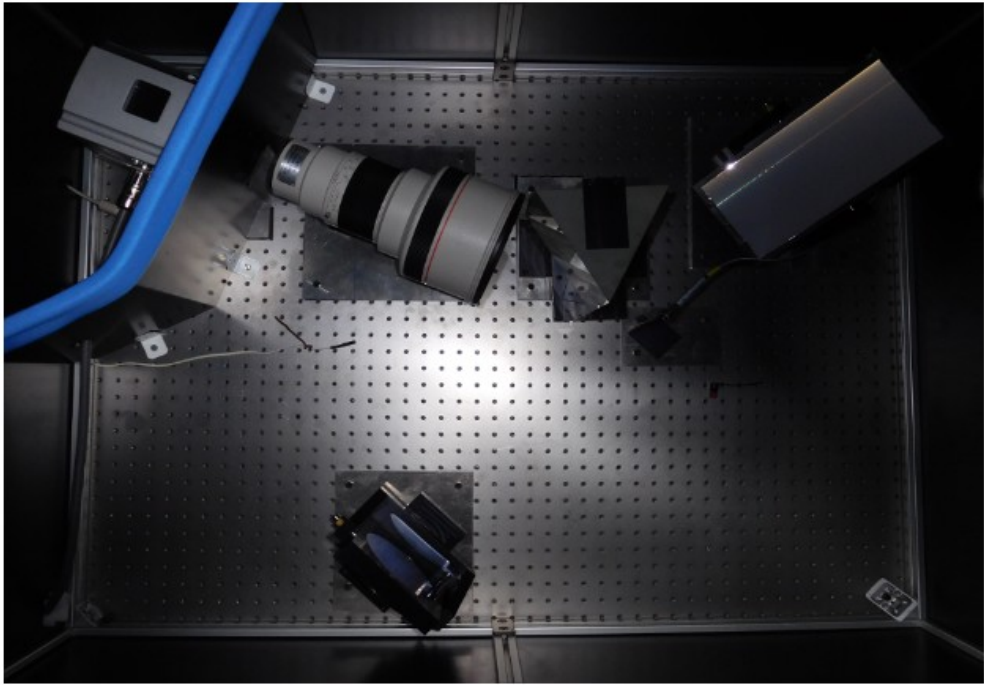

Format of echelle spectrum on the Andor 2k x 2k CCD (P Cygni, 90-sec exposure)



# Instrumentation – Skalnaté Pleso observatory

## Observing projects at both spectropgraphs:

- symbiotic stars and novae
- close binaries, multiple systems of stars
- T Tauri objects
- CP stars (mostly cooper. with Ernst Paunzen)
- exoplanet host stars
- follow-up observations for BRITE satellite object

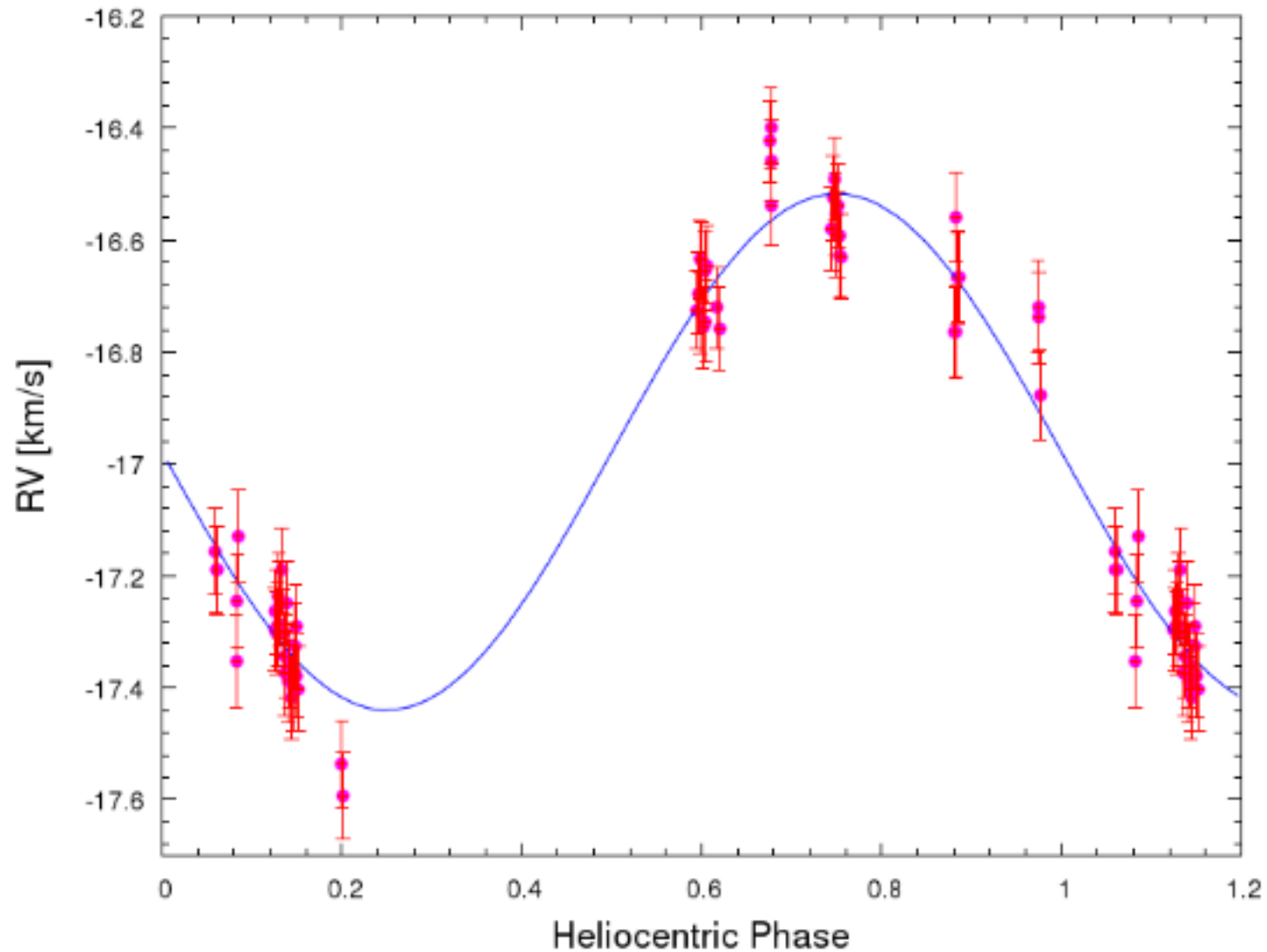

RV variability of  $\tau$  Boo

data between March  
13 and June 6, 2014

rms = 78 m/s

$K = 461.1$  m/s

$P = 3.312$  days

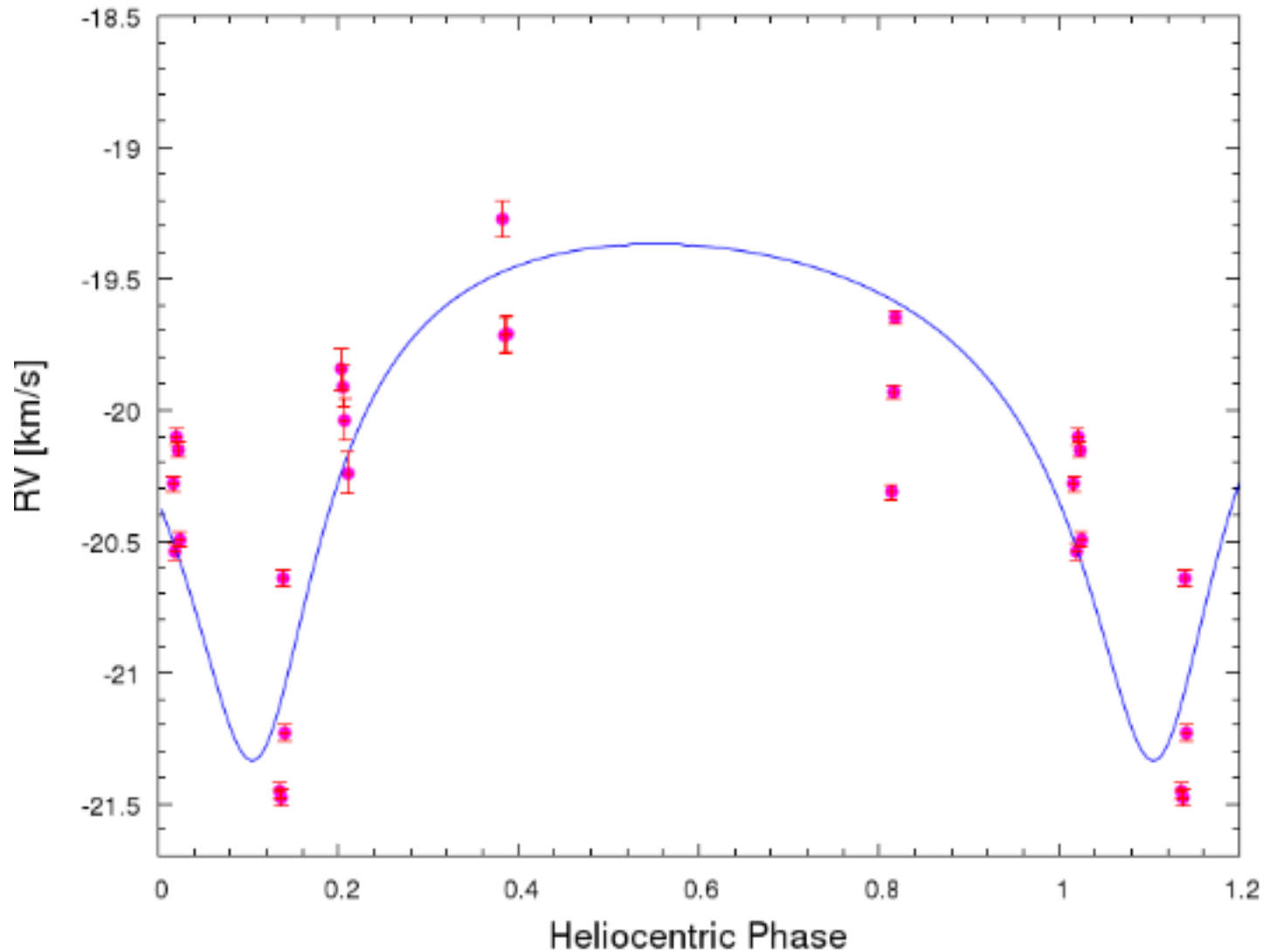

RV variability of HAT-P-2b  
data between March 14 and  
July 3, 2014

5 points between phases  
0.2 and 0.4

rms = 326 m/s  
K = 983.9 m/s  
P = 5.633 days



Easy to record emission lines but risk of saturation in H $\alpha$ , spectrophotometry

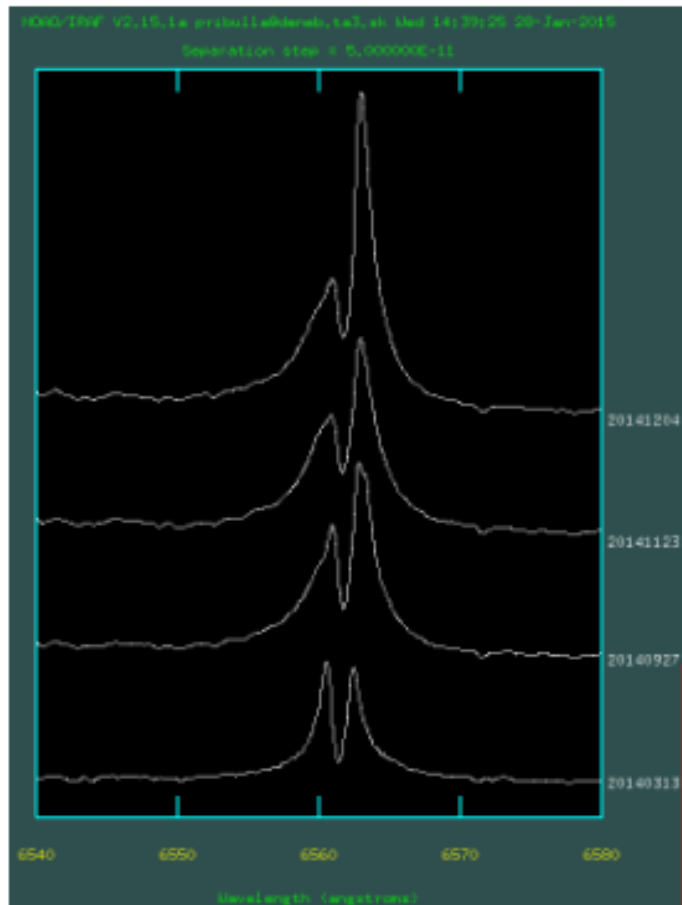

CH Cyg, H $\alpha$

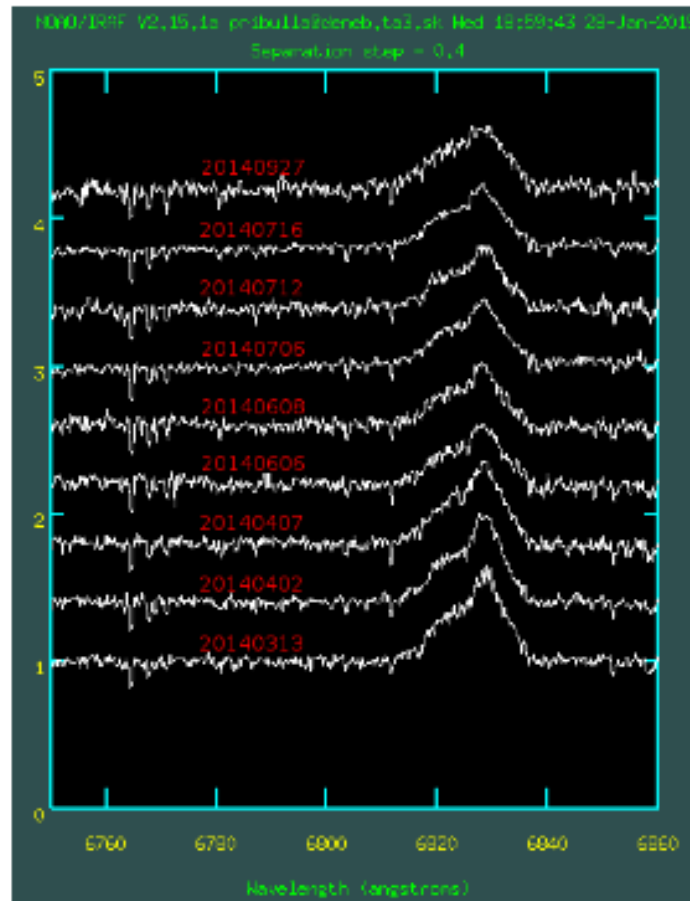

AG Dra, Raman-scattered line, 6826 Å

# Instrumentation – Skalnaté Pleso observatory

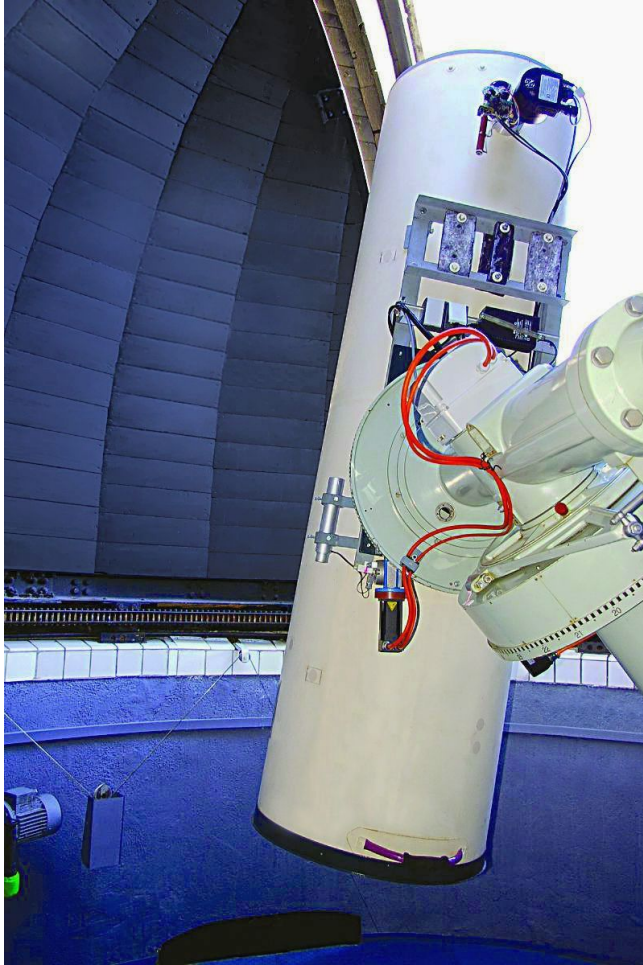

**Telescope:** 0.61-m f/4.3 Newtonian reflector

**Detector:** CCD SBIG ST-10XME + Johnson-Cousins *UBVRI*

- size of CCD pixels&chip 6.8 microns square, 2184 x 1472 pixels
- dark Current 0.5e<sup>-</sup>/pixel/sec at 0 °C
- A/D Gain 1.3e<sup>-</sup>/ADU
- read Noise 8.8e<sup>-</sup> RMS
- field of view 19.5' x 13.1', resolution 0.535"/px (1x1 binning), 1.069"/px (2x2 binning)

**Photometry of comets and asteroids**

# Instrumentation – Skalnaté Pleso observatory

## Low amplitude of PHA asteroid 1981 Midas

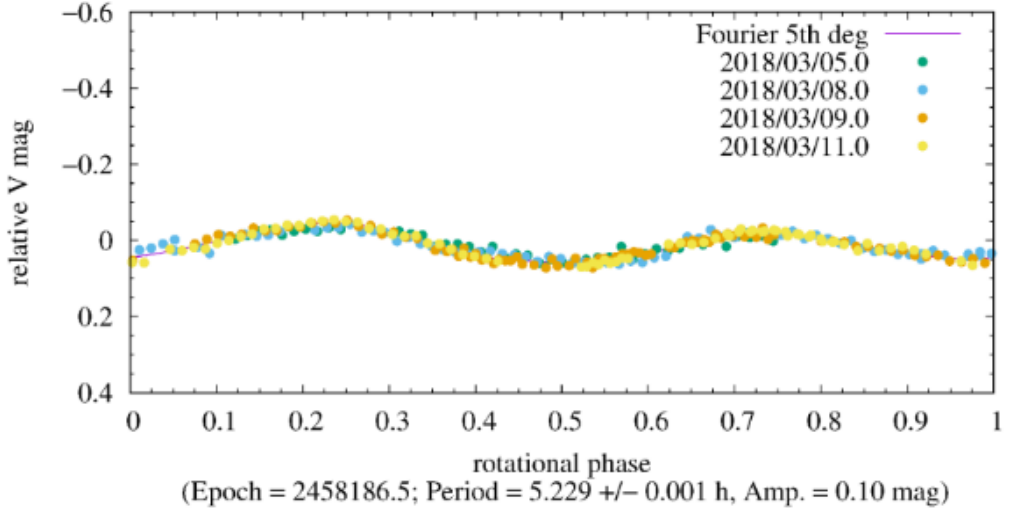
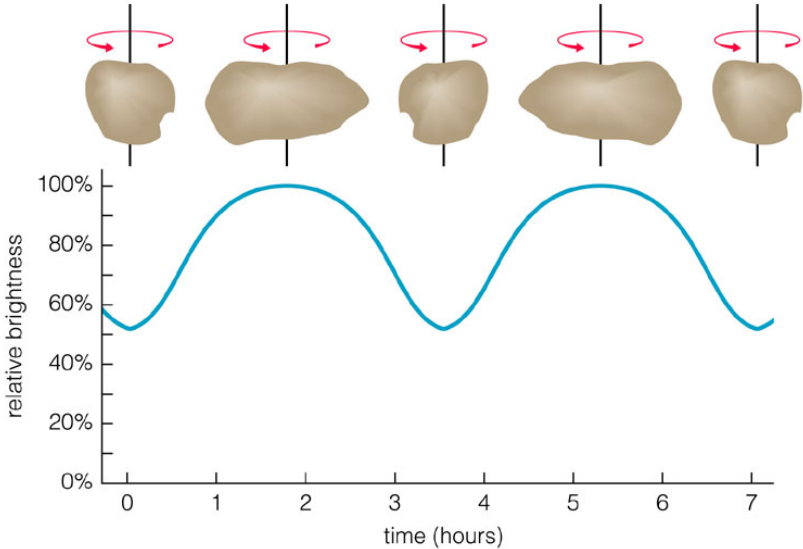



# Instrumentation – Skalnaté Pleso observatory



Comet C/2020 F3 NEOWISE and its structures close to the nucleus

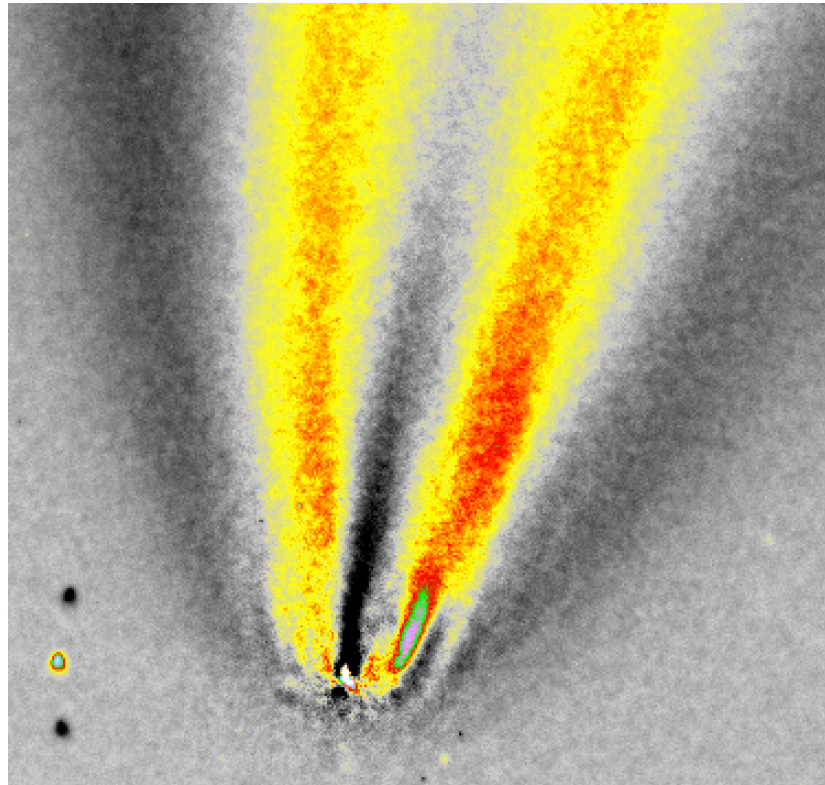

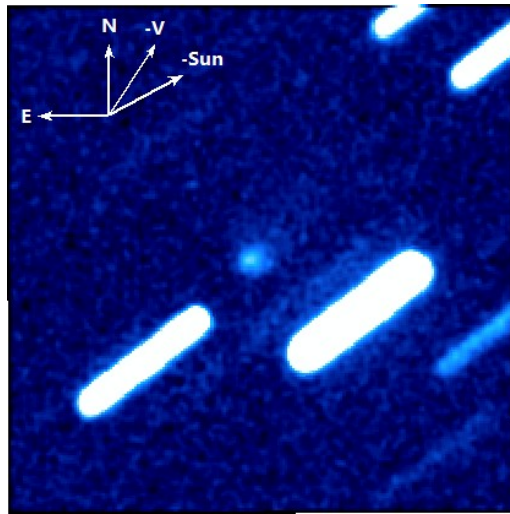

0.61-m, R filter, 2019 09 13

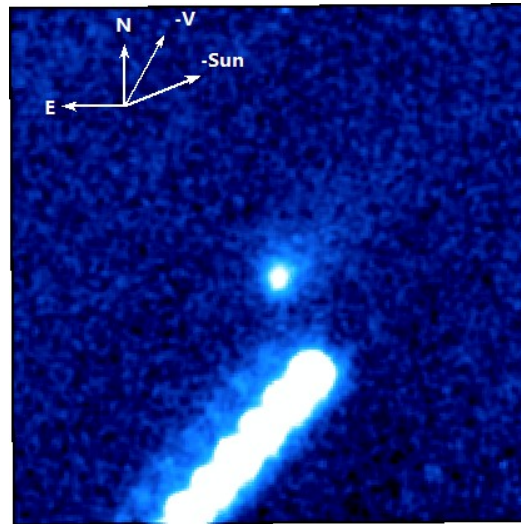

1.3-m, R filter, 2019 10 18

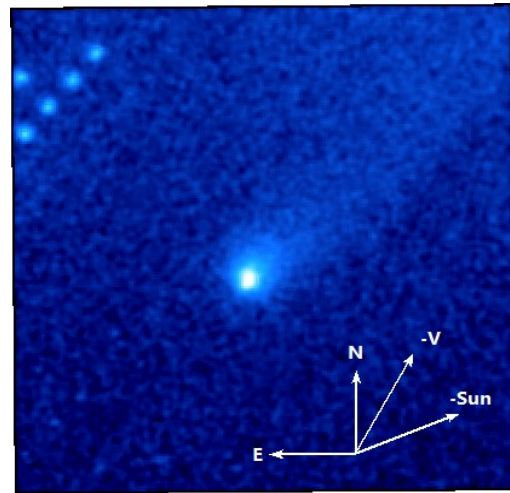

1.3-m, R filter, 2019 10 20

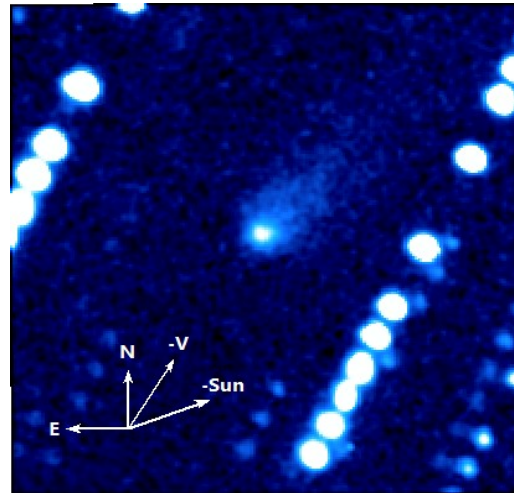

0.61-m, R filter, 2019 12 09

Faint interstellar  
comet 2I/Borisov



# Instrumentation – Lomnický štít observatory

**Telescope(s):** two coronagraphs: ZEISS 200/3000 :  $D=20$  cm,  $f=4$  m

**Detectors:** Coronal Multi-channell Polarimeter (CoMP-S)

Solar Chromospheric Detector (SCD)

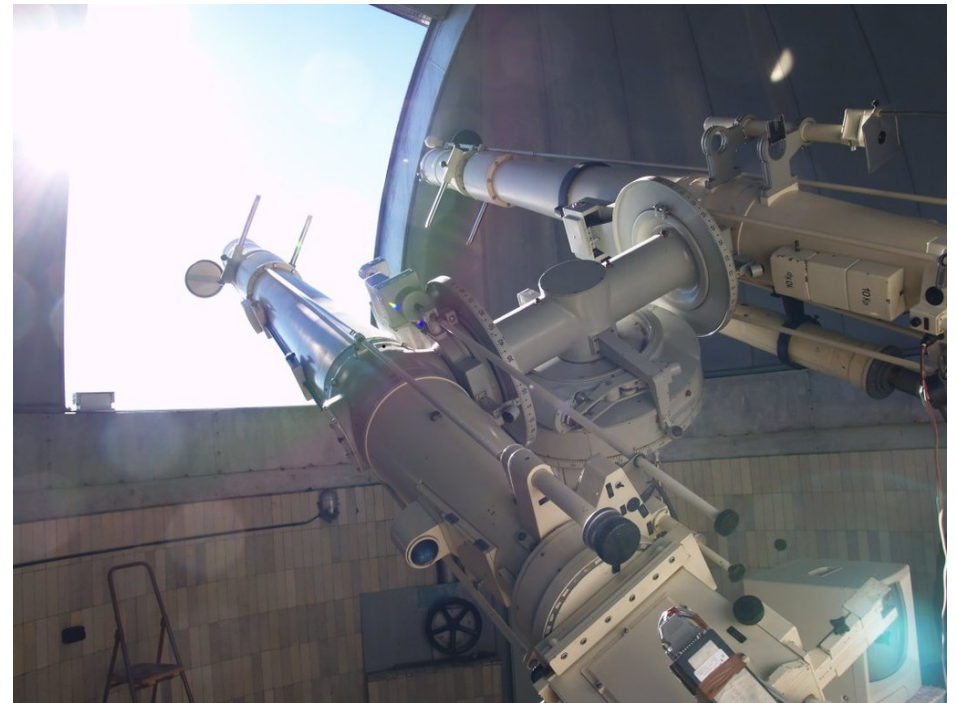
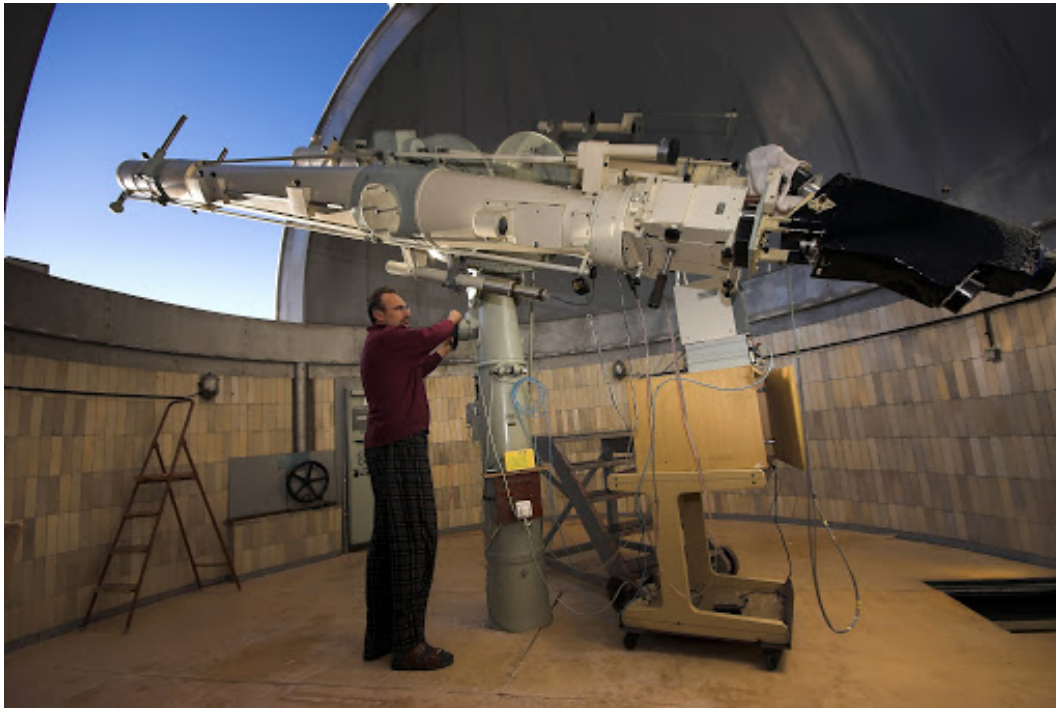



# Instrumentation – Lomnický štít observatory

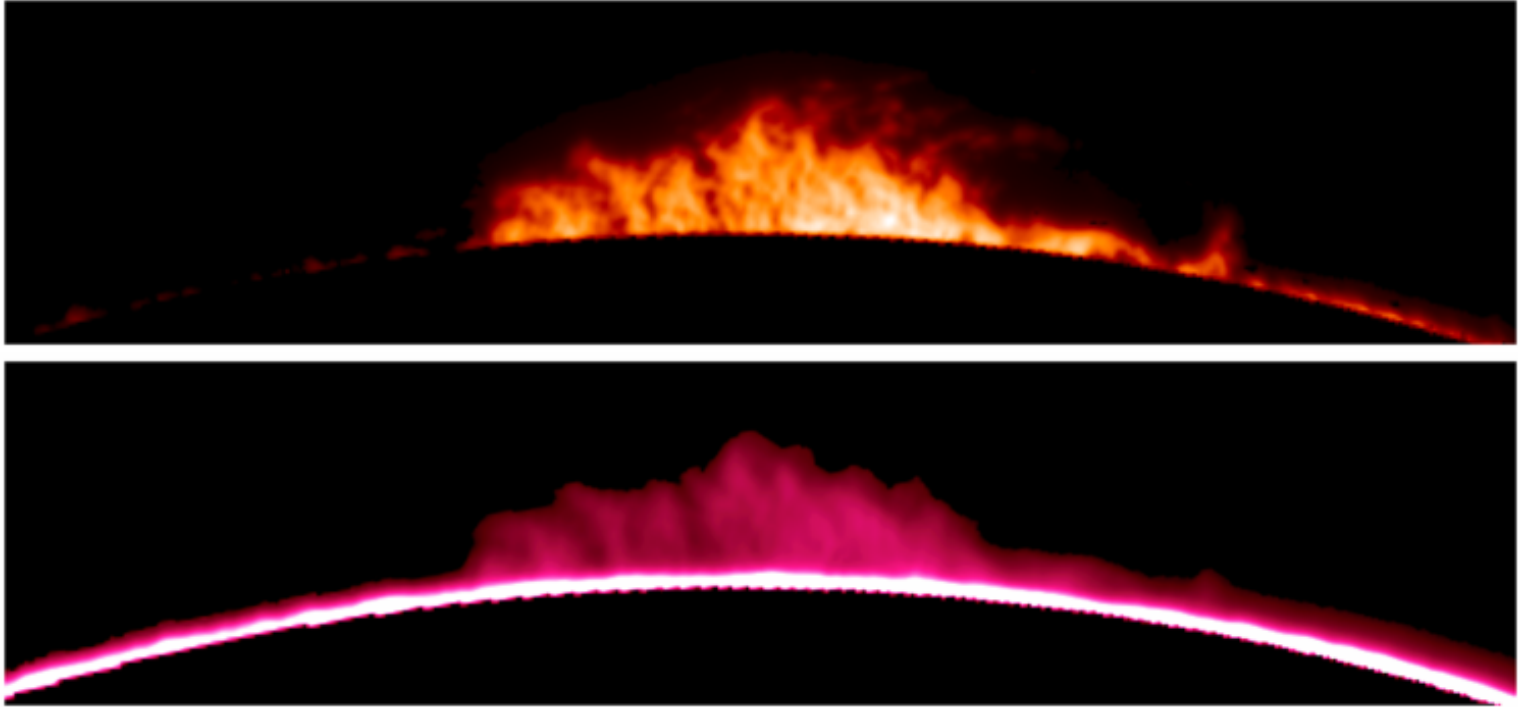

An example of a quiescent prominence, observed on October 20, 2012 near the south pole of the Sun sequentially in the spectral lines of H I 656 nm and Ca II 854 nm (top - H I 656 07:08:40 UT, bottom Ca II 854 nm 07:04:43 UT).

# Instrumentation – Lomnický štít observatory

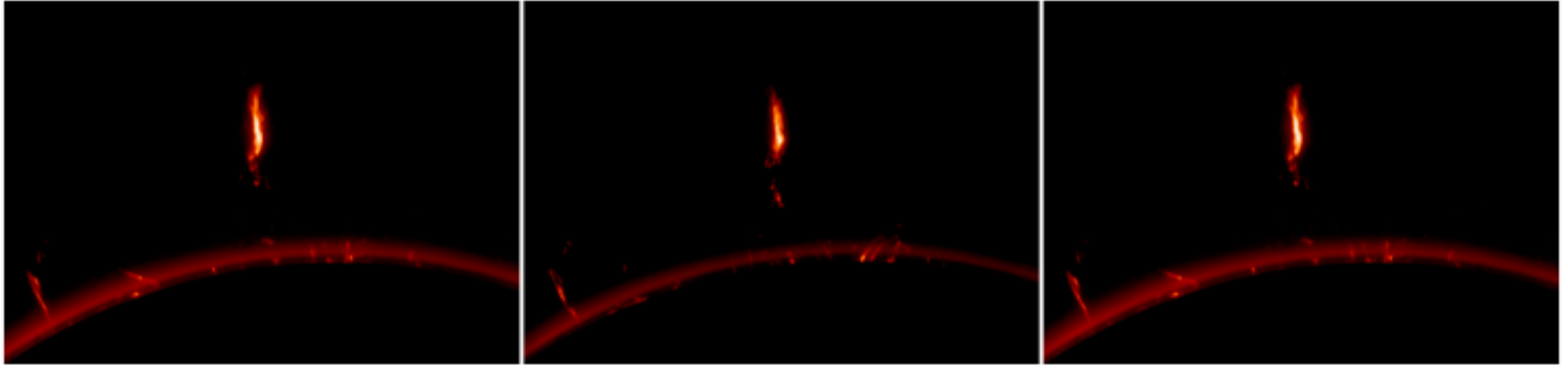

Evolution of an eruptive prominence, observed on March 10, 2014 above the southeast limb of the Sun (AR 11991) in the spectral lines H I 656 nm (06:58:22, 07:24:12, 08:04:49 UT - left to right).

# Instrumentation – Lomnický štít observatory

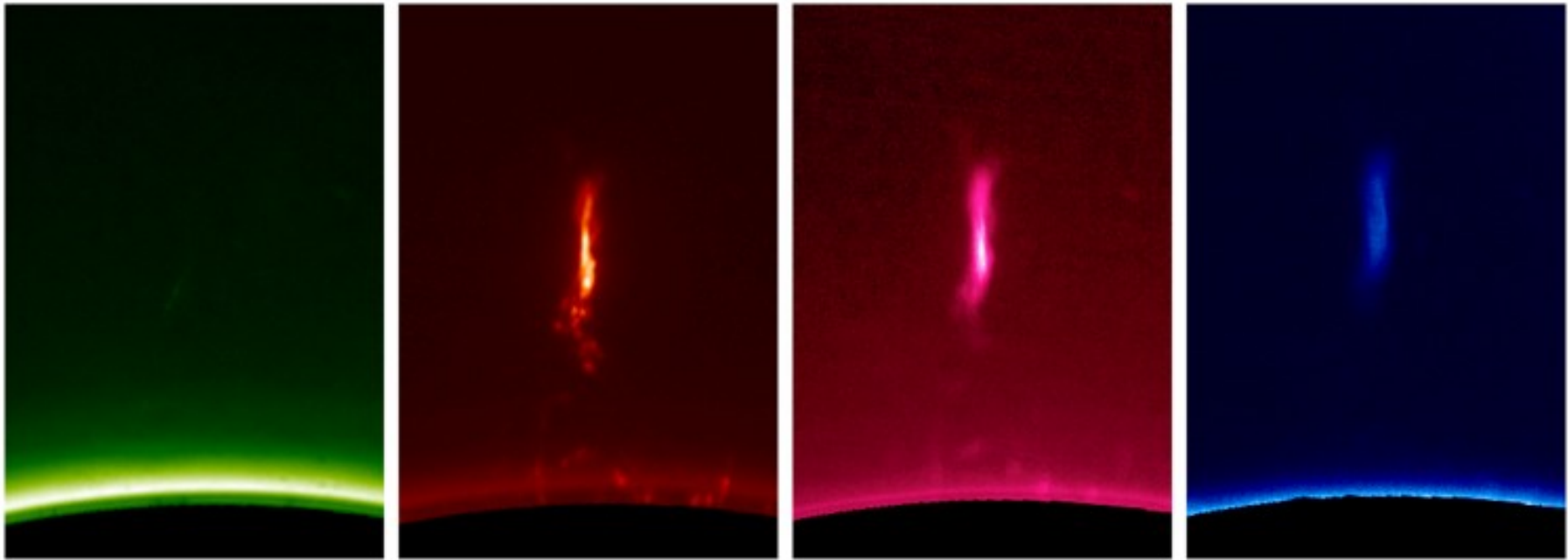

Example of an eruptive prominence, observed on March 10, 2014 above the southeast limb of the Sun (AR 11991) in the 10 minute time interval sequentially in 4 spectral lines: Na I 587 nm (08:25:17 UT), H I 656 nm (08:21:53 UT), Ca II 854 nm (08:19:35 UT), and He I 1083 nm (08:15:59 UT) - top to bottom.



# Instrumentation – Lomnický štít observatory

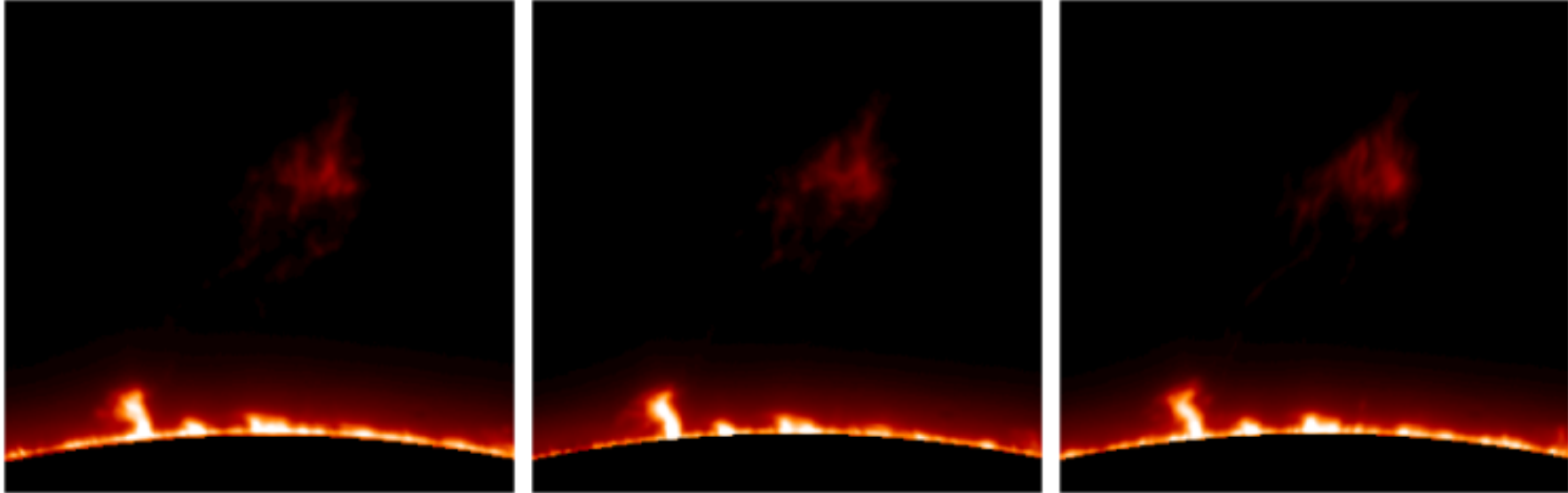

Evolution of an eruptive prominence, observed on July 13, 2014 above the southeast limb of the Sun (near AR 12107) high above the solar limb together with an apparent 'solar tornado' close to the solar limb in the spectral line H I 656 nm (05:09:42, 05:18:30, 05:27:02 UT - left to right).

# Cooperation

- ✓ D. Dunlap Observatory, Canada
- ✓ Ondřejov Observatory – Czech Republik
- ✓ Masaryk Uni. Brno – Czech Republik
- ✓ University Graz - Austria
- ✓ Astrophysical Institute Jena, Germany
- ✓ European Northern Observatory, Canaries, Spain
- ✓ Astrophysical Institute, Potsdam, Germany
- ✓ Observatory Tautenburg, Germany
- ✓ ...and others

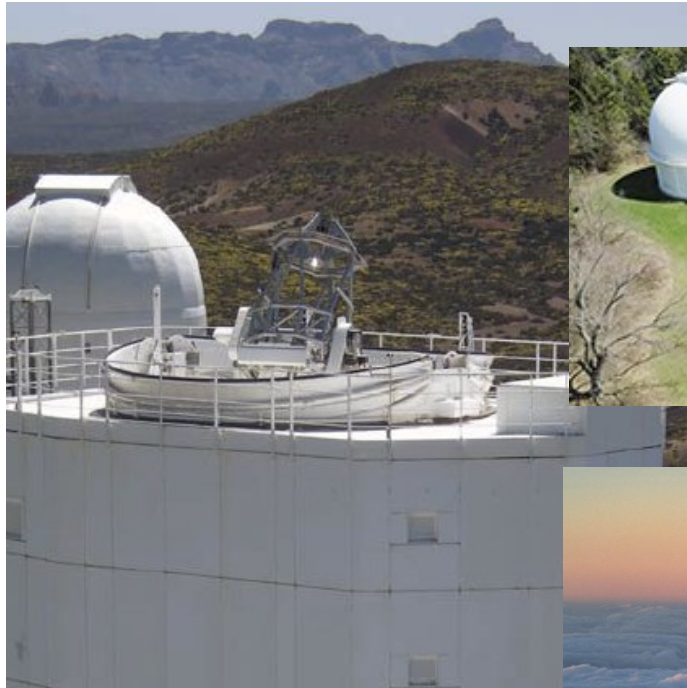

# PhD. study

- Registration for each semester of PhD study is at Comenius University, Faculty of Mathematics, Physics and Informatics in Bratislava.
- Astronomical Institute is in this case a training workplace
- Duration of the PhD study is four years
- Stipendium ~ 950-1000 EUR/month
- The possibility to work in the field of observing and also theoretical astrophysics.
- Institute can provide also accommodation in Vila Tatra – Tatranská Lomnica)



# Academic year 2023/2024: PhD. topics

## Stellar Physics and Exoplanets

### 1. Doubly and multiply eclipsing systems

**Supervisor:** Dr. Theodor Pribulla (pribulla@ta3.sk)

**Objectives:** Detection and modeling doubly and multiply eclipsing systems. Determination of the orbital and absolute parameters of the components. Including fine light-curve effects in the modeling of eclipses.

### 2. Exoplanets transiting early-type stars

**Supervisor:** Dr. Theodor Pribulla (pribulla@ta3.sk)

**Objectives:** Detection of transiting exoplanets showing transit duration changes (TDV). Realistic modeling of exoplanet transits in rapidly rotating stars including fine light-curve effects (exact stellar and planetary shapes, Doppler beaming, gravity darkening). Finding the wavelength effects on the transit light curves relevant for the upcoming mission ARIEL.

# Academic year 2023/2024: PhD. topics

## Stellar Physics and Exoplanets

### 3. Formation of young stars of T Tauri type and their planetary systems

**Supervisor:** Dr. Martin Vaňko (vanko@ta3.sk)

**Objectives:** Follow-up observations for candidate T Tauri stars and modelling of binary components containing a few Myr young stars to determine their physical parameters, rotational periods, character and nature of the observed photometric variability. Acquiring of multicolour photometry (including much desired U-band) of selected T Tauri stars.

## Solar physics

### 4. Solar activity cycles – empirical implications for the solar dynamo modelling

**Supervisor:** Dr. Ján Rybák (choc@ta3.sk)

**Objectives:** An expected output of the research is determination of the temporal evolution of the time-latitude asymmetry of the solar activity for time period of several solar activity cycles and an analysis of its importance for different periods together with searching for probable periodicities of the activity.

# Academic year 2023/2024: PhD. topics

## Interstellar matter

### 5. Distribution of the orbits of sporadic meteoroids

**Supervisor:** Dr. Mária Hajduková (Maria.Hajdukova@savba.sk@ta3.sk)

**Objectives:** The aim of this work is to map the sporadic background, based on models and the synthesis of observations obtained by different techniques. Observations from Earth of the sporadic background (and its representation in a coordinate system centered at the Earth's apex) have revealed six apparent sources in which enhanced meteor densities are observed: the so-called helion and antihelion sources, the northern and southern apex sources, and the northern and southern toroidal sources. The distribution of radiants is geometrically determined, but different types of comets or asteroids can be found associated with different regions of enhanced density.



# Academic year 2023/2024: PhD. topics

## Interstellar matter

### 6. Modelling of asteroid activity in terms of rotation, 3D shape and tail morphology changes

**Supervisor:** Dr. Marek Husárik (mhusarik@astro.sk)

**Objectives:** Analysis of the activity of a normally inactive body with respect to the orientation of the rotation axis in space, with respect to its shape, possible precession or surface albedo variegation. Computational modelling of tail formation and morphology based also on own observations.

### 7. The origin and formation of the inner Oort cloud

**Supervisor:** Dr. Marián Jakubík (mjakubik@astro.sk)

**Objectives:** The main aim of this work is detailed description of the origin and formation of inner Oort cloud with main emphasis on models describing the formation of the Oort cloud in its birth star cluster. In more detail, we will solve open questions of this process using numerical simulations with respect of recent observations. Among answers on various open questions, we will find the solution of particular problem related to high number of objects (in the inner Oort cloud) revolving around Sun on retrograde orbits resulting from previous numerical simulations.

# Academic year 2023/2024: PhD. study

Application deadline:	<b>May 15th 2023</b>
Address:	<b>Astronomicky ustav SAV, v. v. i. Tatranska Lomnica, 059 60 Vysoke Tatry</b>
Interviews:	<b>during June of 2023</b>
PhD study (start):	<b>September 1st 2023</b>

<https://www.astro.sk/en/study/phd-study/>

# Thank you !



SLOVAK RESEARCH  
AND DEVELOPMENT  
AGENCY

**Acknowledgement:** This work was supported by the Slovak Research and Development Agency under contract No. APVV-20-0148