

MUNI
SCI

Bi4025en

Molecular Biology

Mgr. Jiří Kohoutek, Ph.D.

Lecture 12

- Basic principals of genetic engineering

Genetic engineering – definition

- Definition by International Union of Pure and Applied Chemistry (IUPAC):
- Process of inserting new genetic information into existing cells in order to modify a specific organism for the purpose of changing its characteristics
- Also Known as Recombinant DNA technology, gene modification, and gene therapy.

- Genetic engineering is a term that was first introduced into our language in the 1970s to describe the emerging field of **recombinant DNA technology**.

- The recombinant DNA technology started with pretty simple things - **cloning very small pieces of DNA and growing them in bacteria**.

- In a broad view the genetic engineering, is more defined as an entire **field of recombinant DNA technology, genomics, and genetics**.

Gene – Genetic engineering

- Genetic engineering is targeted construction of cells/organisms carrying such **gene and protein variants and a combination of genes that do not exist** in the nature.
- Methods to propagate new molecule of DNA in new variant of the protein:
 - Joining DNA fragments isolated from different species, genera, families, etc...
 - Creation of completely new DNA molecules.
 - Transfer of modified molecules into cells and organisms.
 - Direct mutational interventions in the genome of cells and organisms.

Gene – Genetic engineering

- DNA manipulation *in vitro*, DNA amplification, gene cloning and their targeted modifications, transfer to cells / organisms (heterologous expression).
- Targeted changes in genetic information may also be carried out *in vivo* (genome editing, chromosome engineering).

Key discoveries

- Restriction endonucleases and other enzymes for DNA manipulation:
 - DNA cutting in a precisely defined location.
 - Ligation of two foreign DNA (originating from different organisms).
 - DNA synthesis in a test tube ("artificial bacteria").
- DNA sequencing:
 - Determination of the molecular structure of the gene and regulators sequences.
- Gene cloning:
 - Use of the universal genetic code and the method of expression of genetic information.
 - Introduction of the gene into the unrelated organisms (overcoming interspecies barriers).
 - Gene amplification to the unlimited quantities.
 - Targeted introduction of mutations into the gene (function improvement).
 - Study of the manifestation of altered genes (mutation x function).

Key discoveries

- 1965 - Discovery of plasmids.
- 1970 - isolation of the first restriction enzyme.
- 1972 - Preparation of the first recombinant DNA molecules *in vitro*.
- 1973 - the beginning of gene cloning.
- 1975 – The [Asilomar Conference](#) on recombinant DNA.
- 1977 - First recombinant DNA molecules carrying mammalian genes.
- 1977 - DNA sequencing.
- 1978 - [preparation of human insulin in bacteria](#) (since 1982 produced commercially).

Key discoveries

- 1980 - First attempts of gene therapy.
- 1983 - Discovery and introduction of PCR, an alternative to gene cloning in vectors.
- 1997 - animal cloning, Polly the sheep (injection of genomic DNA into the nucleus the human blood clotting factor, exogen present, but not expressed).
- after 2000 - genome editing - recombinant DNA nucleases - meganucleases recognizing long target sequences, CRISPR/Cas.

Use of genetic engineering

- Basic Research:
- Study of the structure and function of genes and genomes.
- Elucidation of basic processes of gene expression - recombinant DNA, reporter genes, etc.
- Characterization of regulatory mechanisms of gene expression.

Use of genetic engineering

- Applied Research:
- Production of medical, agriculture and industry relevant substances:
 - Introduction of foreign genes into unrelated organisms and obtaining products in large quantities - overcoming reproductive barriers.
- Preparation of substances with new properties:
 - Modification of existing genes or creating new ones - enzymes, antibodies, vaccines, etc.
 - Improving the properties of therapeutic substances.
- Alteration and improvement of the characteristics of organisms:
 - Preparation of microorganisms for biotechnology (e.g. Enhanced production).
 - Increased yields of cultural plants and livestock performance (resistance to diseases, pests or external influences, production of foreign substances in the bodies of plants and animals).
- Gene therapy - treatment of genetic diseases.

Particular steps of genetic engineering

- 1) Insertion of the gene into the plasmid – **Gene cloning**.
- 2) **Transfer of vector** into the given organism – bacteria, plant, yeast, eukaryotic cells, etc. By transformation/transfection, electroporation, transduction, infection, microinjection, shooting gene.
- 3) **Expanding** of bacteria.
- 4) Basic or Applied Research.

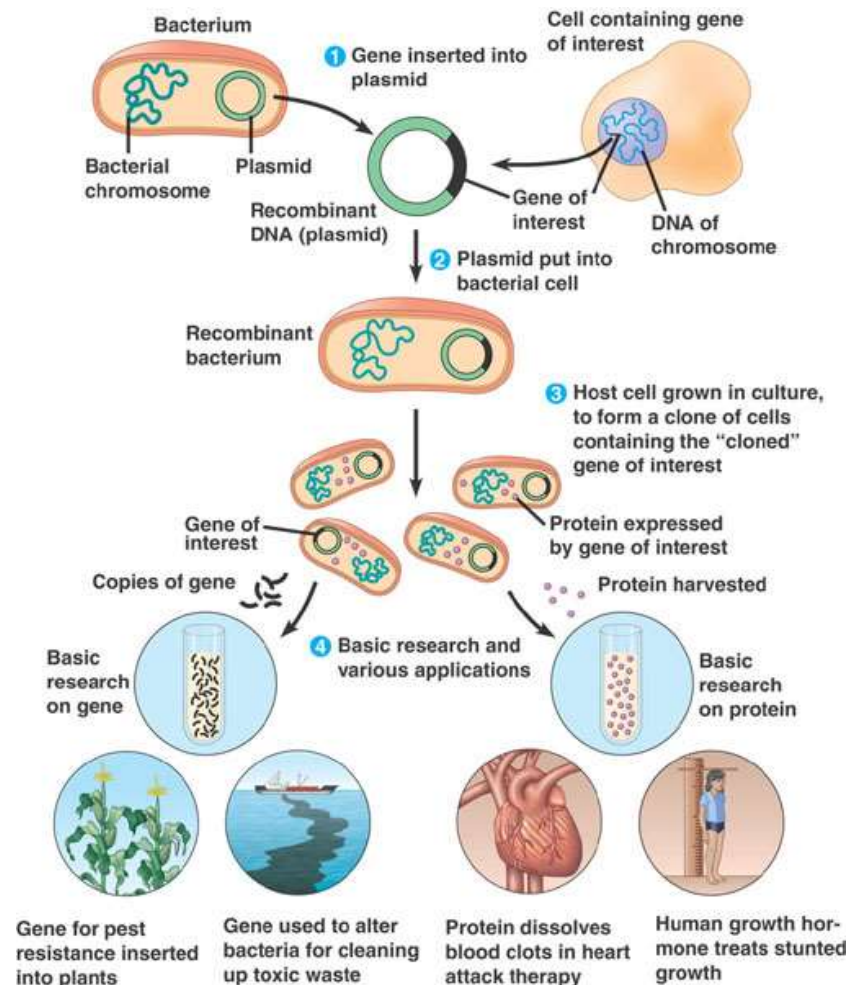

Gene cloning

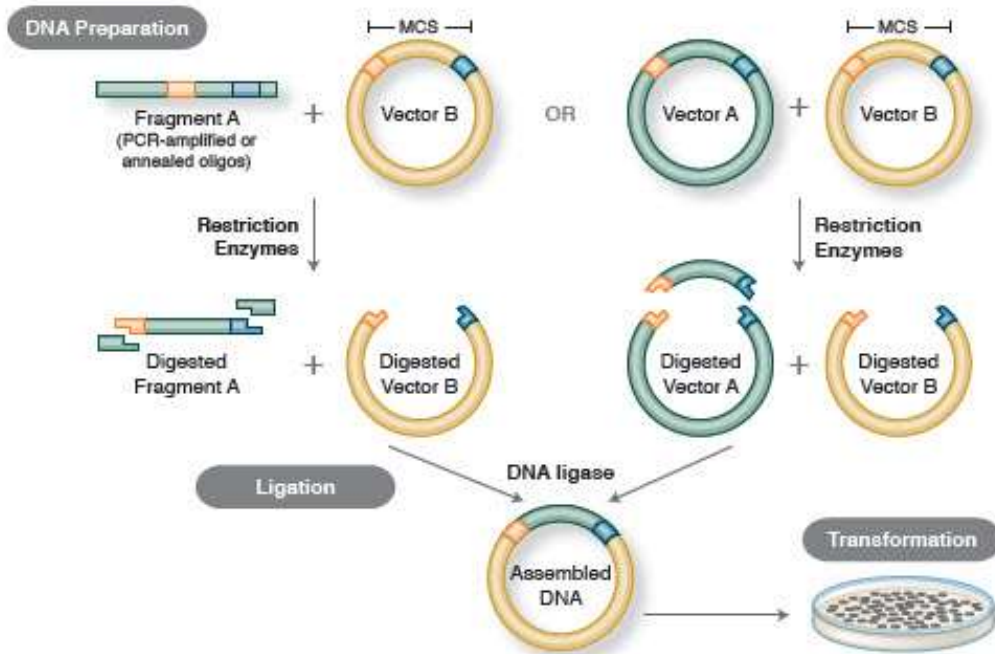

- Restriction sites at the DNA and plasmids are digested by the corresponding restriction enzymes (RE).
- The cleaved DNA is then ligated to a plasmid vector possessing compatible ends.
- DNA fragments can also be moved from one vector into another by digesting with REs and ligating with compatible ends of the target vector.
- Assembled construct is then transformed into *Escherichia coli* (*E. coli*).

Plasmid selection

- A plasmid typically contains an **antibiotic resistance gene**, which allows bacteria to **survive** in the presence of a specific **antibiotic**.
- Thus, bacteria that took up the plasmid can be selected on nutrient plates containing the antibiotic.
- Bacteria **without a plasmid will die**, while bacteria carrying a plasmid can live and reproduce.
- Each surviving bacterium will give rise to a small, dot-like group, or **colony**, of identical bacteria that all carry the **same plasmid**.

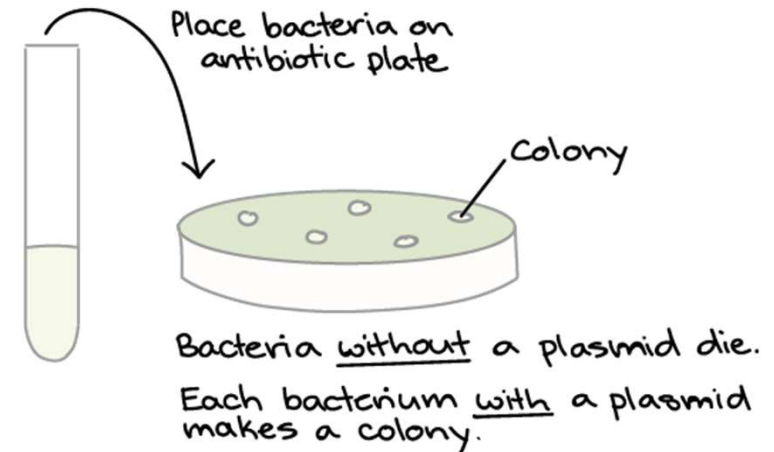
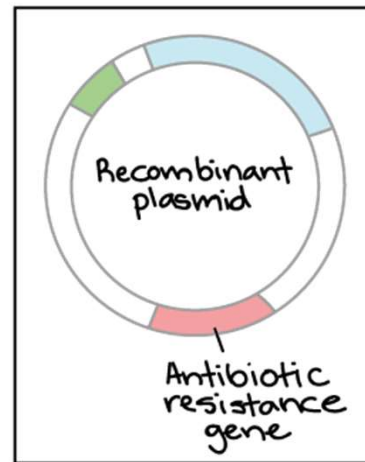

Production of cloned gene

- Once the bacterial colony with the right plasmid is verified.
- After specific induction the large culture of plasmid is then grown.
- The bacteria serve as miniature “factories” churning out large amounts of protein.

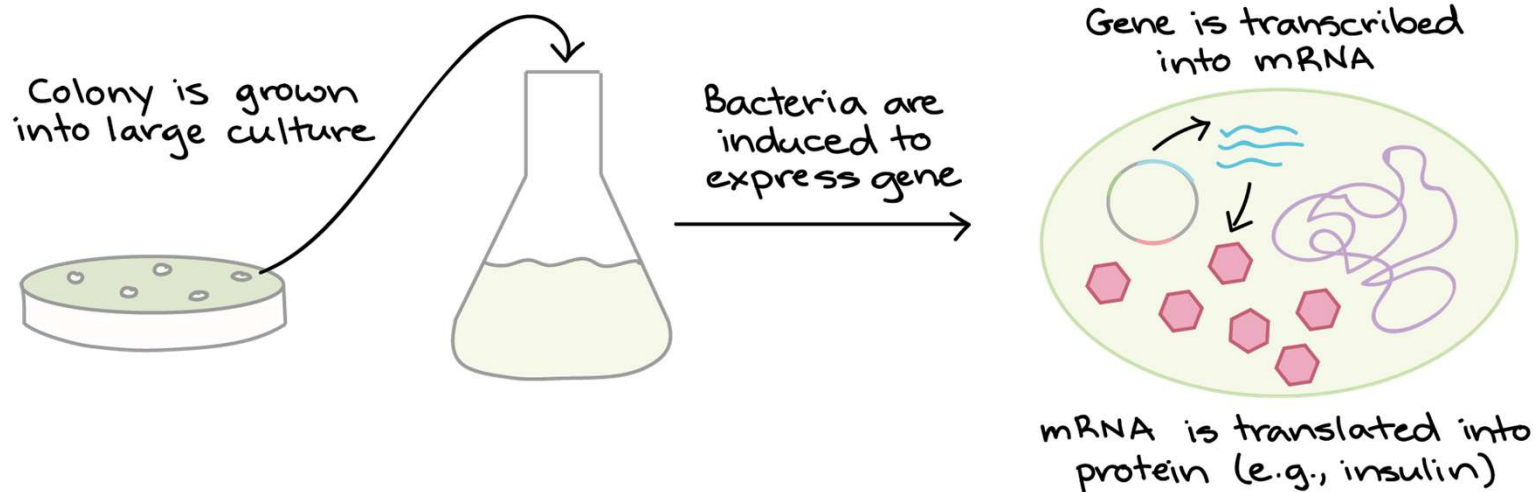

Cloning of genomic library

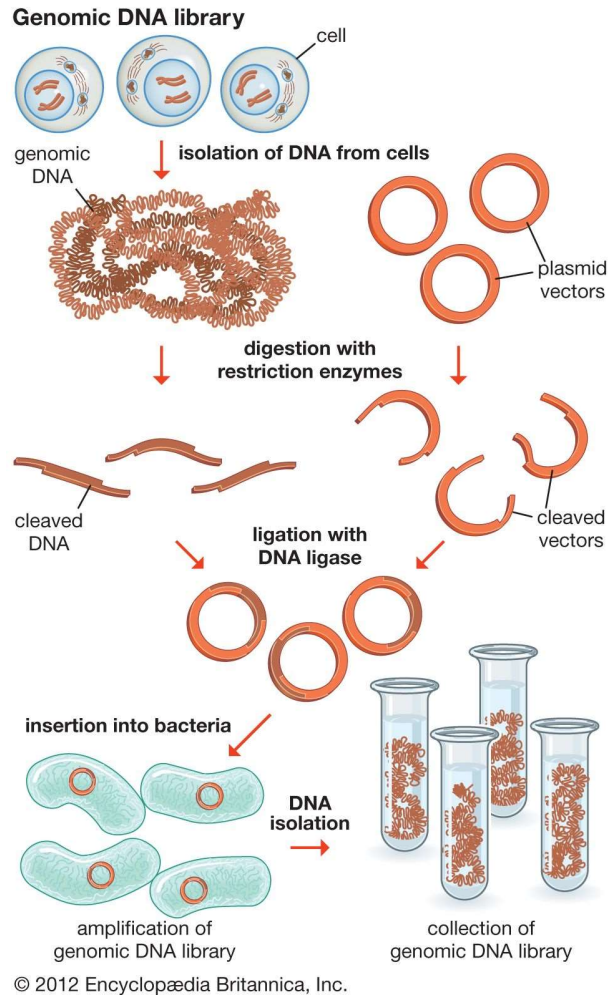

- A **genomic DNA library** is a collection of DNA fragments that make up the full-length genome of an organism.
- A genomic library is created by isolating DNA from cells and then amplifying it using DNA cloning technology.

Mutagenesis *in vitro*

- „Site - Directed Mutagenesis“.
- Aims:
 - Analysis of the relationship between structure and function of nucleic acids.
 - Clarification of gene function and regulatory regions.
 - Targeted changes in amino acids in proteins.
 - Controlled evolution (bioinformatics tools, domain modeling, gene preparation, cloning and function test) - protein preparation with new properties (protein engineering).
 - Preparation of transgenic organisms
- Procedure:
 - DNA isolation – change in DNA *in vitro* – transfer to the cell – evaluation of the effect.
- Types of mutations: substitution, deletion, insertions.

Mutagenesis *in vitro*

- Random

- Handling of restriction points.
- Chemical mutagenesis
- Incorporation of erroneous bases.
- Gene search, or functional areas on DNA.

- Targeted

- Oligonucleotides mutagenesis (placement of mutations in a specific gene site).
- Cassete mutagenesis (gene synthesis).
- Substitution of bases or codons targeted changes in the structure of proteins.

Restriction enzyme mediated mutagenesis *in vitro*

- Overhanging ends are:
 - removed by S1 nuclease.
 - synthesized by DNA-polymerase – also just limited synthesis by chosen nucleotides.
- Generation of **deletions** or **insertions** within the genome.

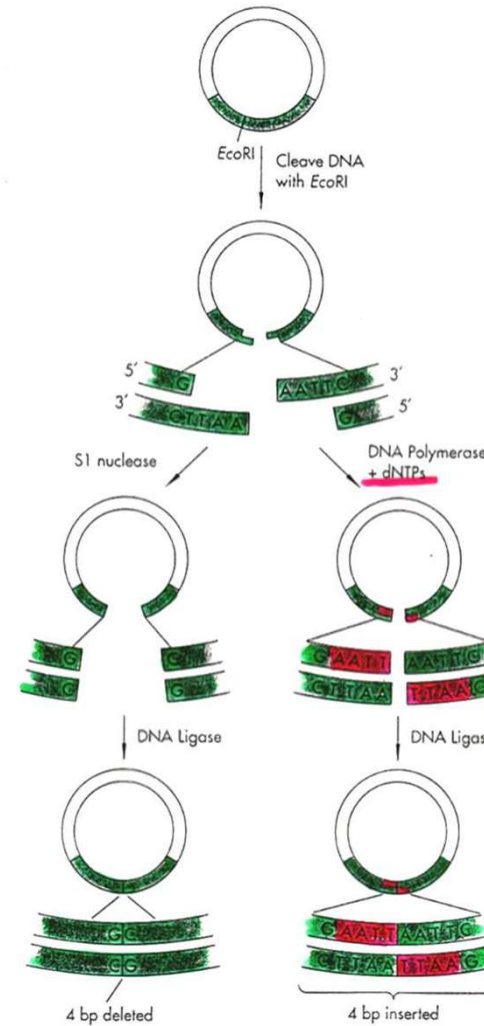

Oligonucleotide mediated mutagenesis

- Parental strand

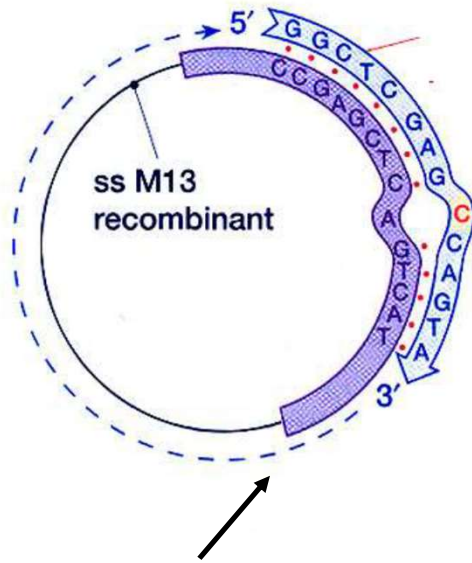

- Newly synthesized strand

- Mutagenic primer

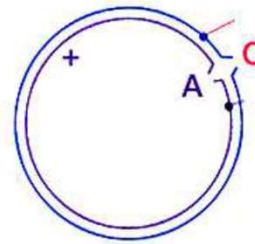

- Heteroduplex DNA

- *E. Coli* transformation

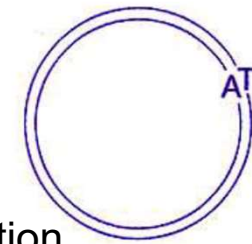

- Parental homoduplex

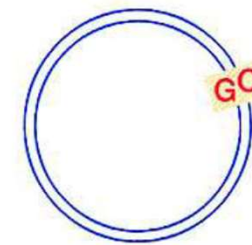

- Mutated homoduplex

Oligonucleotide mediated mutagenesis

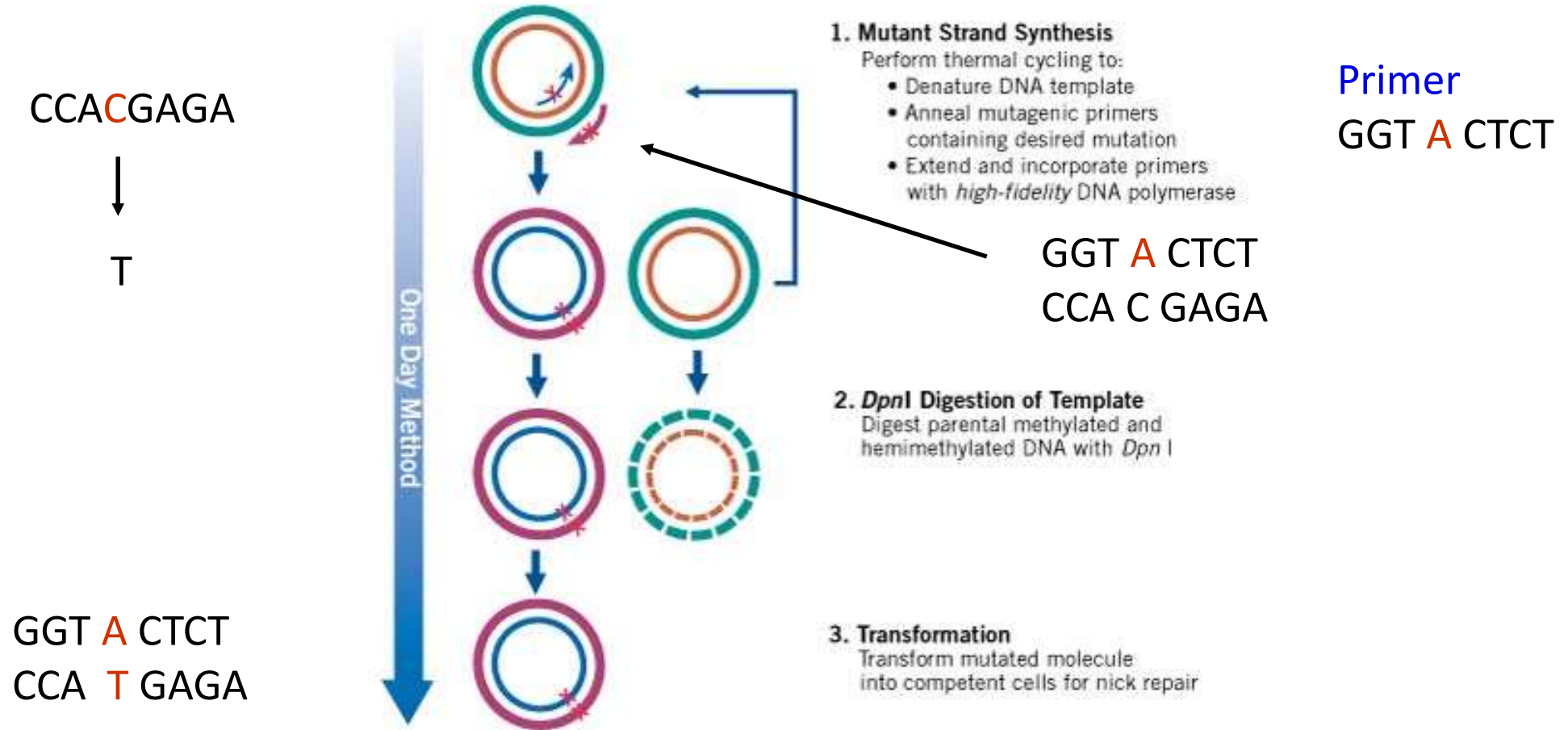

Cassette mutagenesis

- Generally nearly 100% of the mutant clones.
- The limitation is presence of unique, conveniently spaced restriction endonuclease recognition sites.

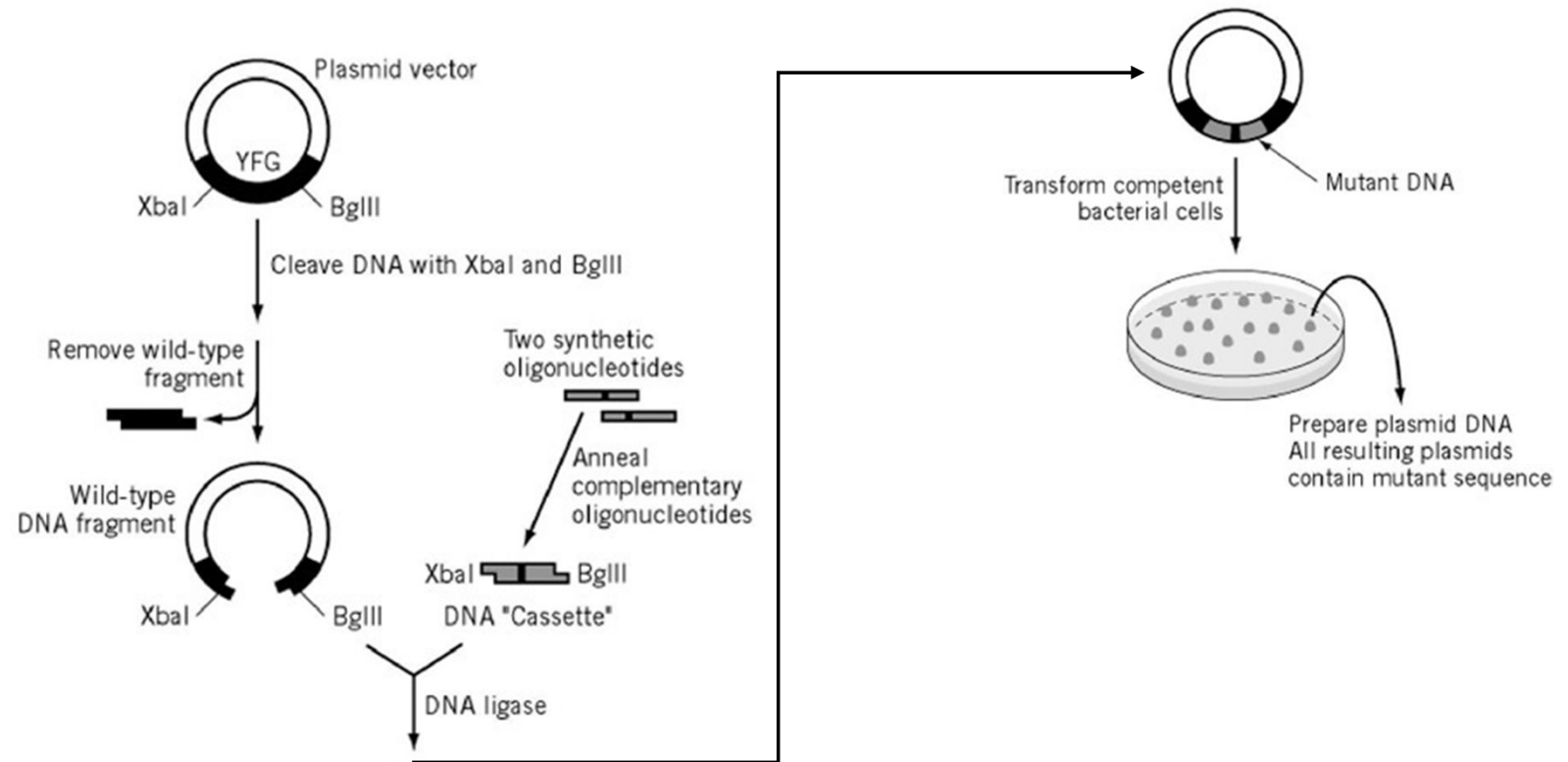

In vivo mutagenesis - gene editing

- Genome editing with engineered nucleases.
- Since 2000.
- Targeted changes to any gene in any organism *in vivo*.
- **Artificially prepared nuclease** introduces insertions, deletions, or replacement of the existing sequence at selected location within the genome.
- Nucleases generates double-stranded breaks at designated points in the genome, thereby stimulating natural **repair mechanisms** in cells based on:
 - **Homology-directed recombination** – HDR – HR
 - **Non-homologous end-joining** - NHEJ.

In vivo mutagenesis – Endonucleases



-Molecular scissors- Genome Editing Tools

- Meganucleases
- Zinc-finger nucleases – ZFN
- Transcription Activator-Like Effector Nuclease – TALEN
- Clustered Regulatory Interspaced Short Palindromic repeats - CRISPR

Meganuclease



ZFN



ZF modules

FokI nuclease

TALEN



RVD modules

FokI nuclease

CRISPR/Cas9

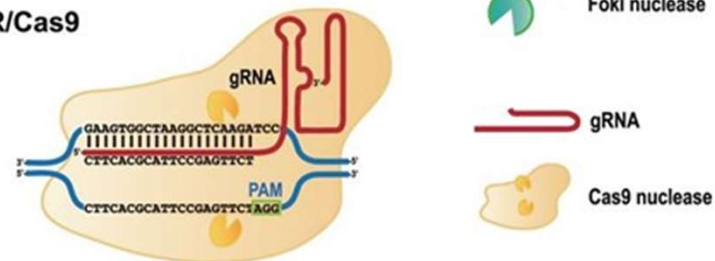

In vivo mutagenesis – Repair Mechanism

- Double strand break can be repaired by:
- NHEJ – insertions, deletions.
- HDR – integration of new sequences.

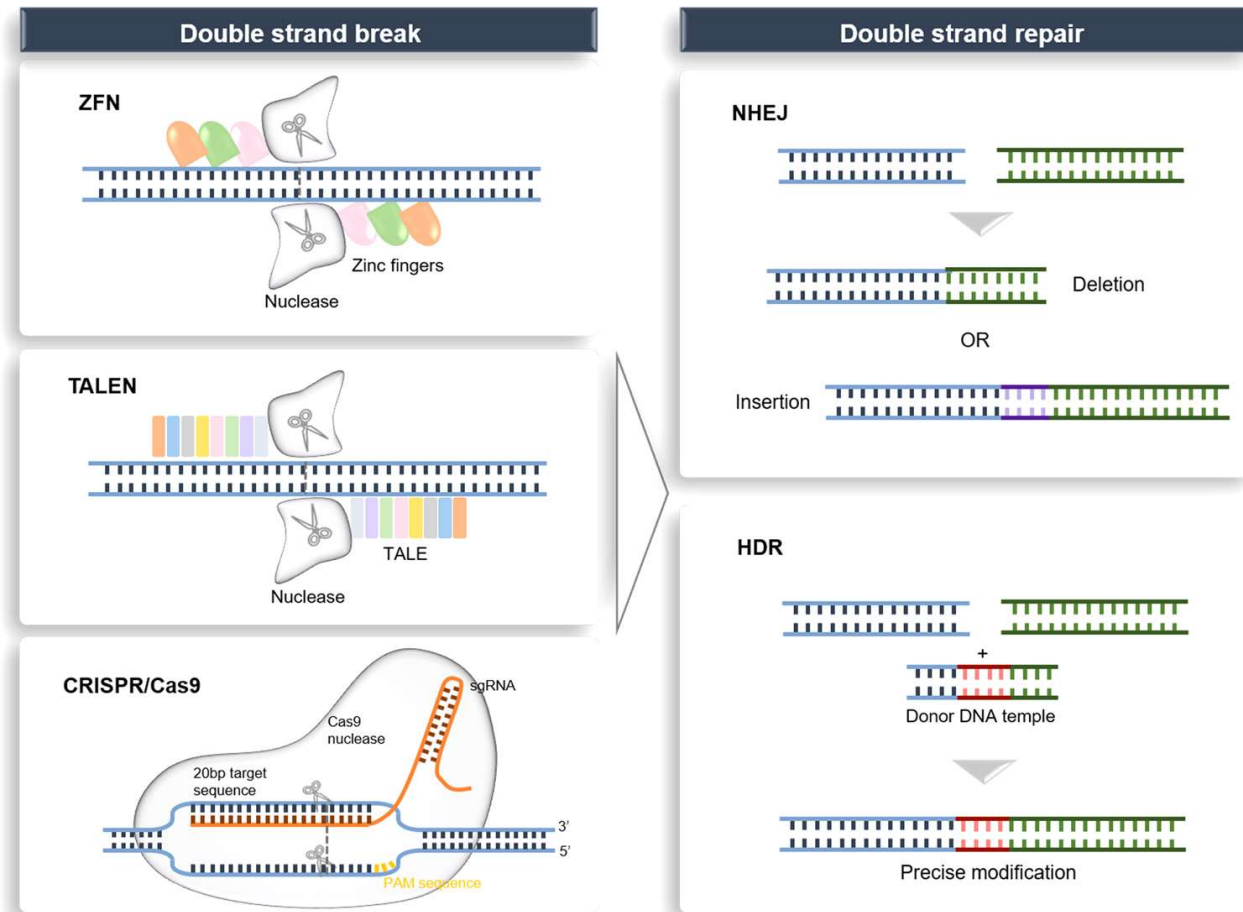

Meganucleases

- There are present in archaeobacteria, bacteria, yeast, fungi and plants.
- Meganucleases identify approximately 14-40 base pairs in the target sequences.
- 5 families of meganucleases are known. The most widespread of them "LAGLIDADG family".
- Meganuclease I - Sce I - recognizes the 18 nucleotide sequence "TAGGGATAACAGGGTAAT", cleaves 4 nucleotides and leaves an end with overlap.
- Complications – the 18 nucleotide sequence recognized by the I-SceI meganuclease would hypothetically require a genome 20 times larger than the human genome for the sequence to occur randomly in the genome.
- The off-target activities induced by meganucleases are affected by the structure of meganucleases, and the delivery methods.

Meganucleases

- Meganucleases form dimer at the target site.
- Each monomer can form $\alpha\beta\alpha\beta\alpha$ fold, with four-stranded antiparallel β -sheets to recognize and combine with target sequence.
- I-OnuI meganuclease - 290 residues and is bound to a 22 base pair DNA target site.
- The N- and C-terminal domains of the endonuclease recognize and interact with the 5' and 3' half-sites of the DNA target site.
- The interface between the target 5' half-site and the protein N-terminal domain is indicated by the oval.

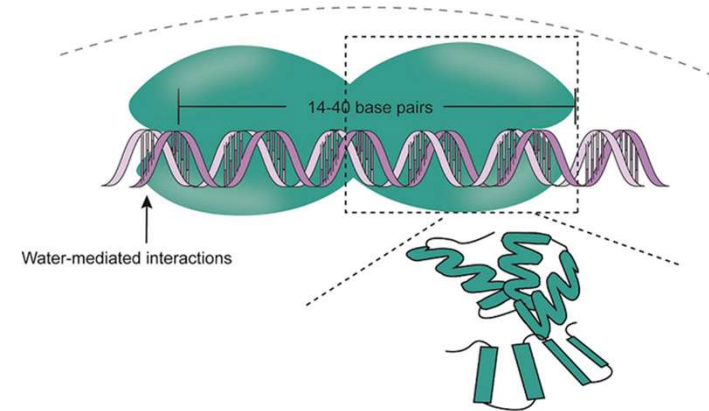

I-OnuI

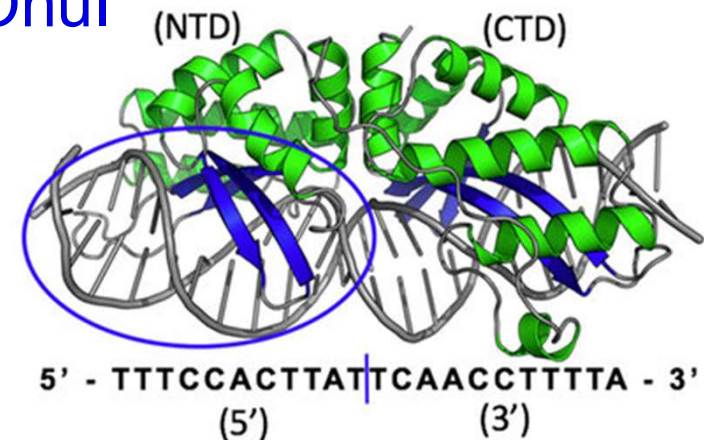

Zinc-finger nucleases – DNA binding domain

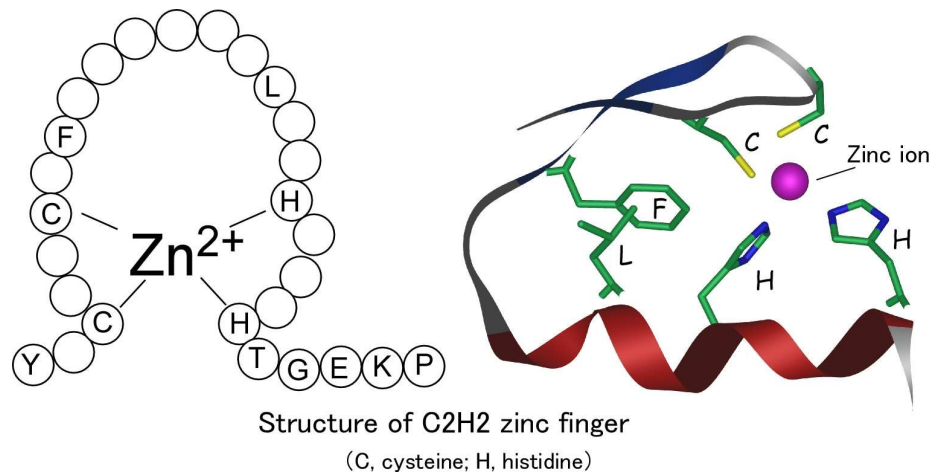

- The C2H2 zinc finger protein (ZFP) is one of the most common DNA binding motifs in multicellular organisms. The zinc binding coordinated by the amino acids Cysteine or Histidine.
- It is capable of binding DNA/RNA/Proteins.
- Individual fingers contain about 30 amino acids and these units typically occur as tandem repeats of two or more fingers.
- Fusing the nonspecific DNA cleavage domain of the Type II restriction enzyme, FokI, to a ZFP allows the resulting zinc finger nuclease (ZFN) to cleave DNA at a sequence determined by the ZFP.

Zinc-finger nucleases – DNA binding domain

- Structure of the Zif268-DNA complex.
- Fingers are spaced at 3-bp intervals.
- The structure and primary DNA contacting residues of zinc finger 2 (ZF2) are indicated to the right **blue rectangle**.
- A sequence alignment of the 3 fingers of Zif268. The zinc binding Cys2-His2 motif is indicated with blue bold font; the canonical DNA-contacting residues are indicated by arrows in the **red rectangle**.

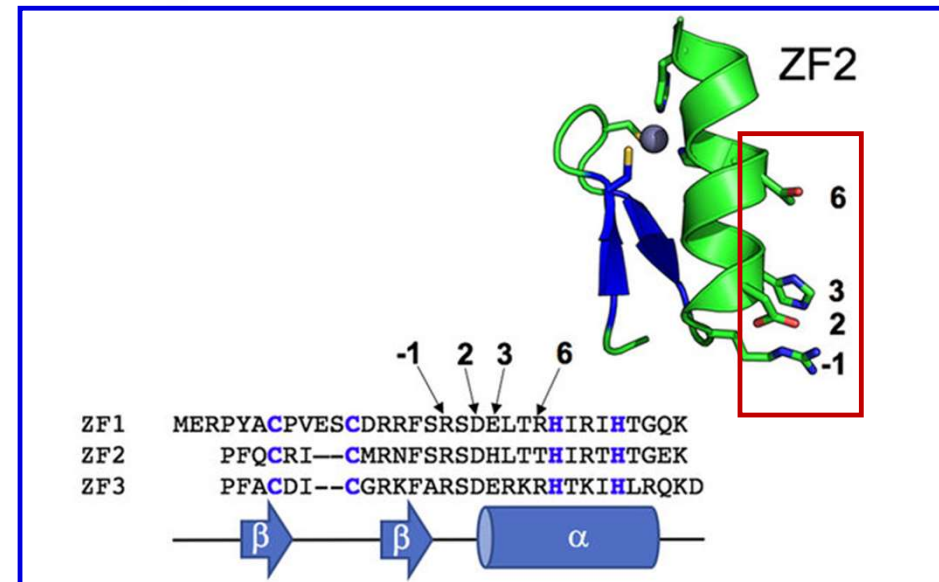
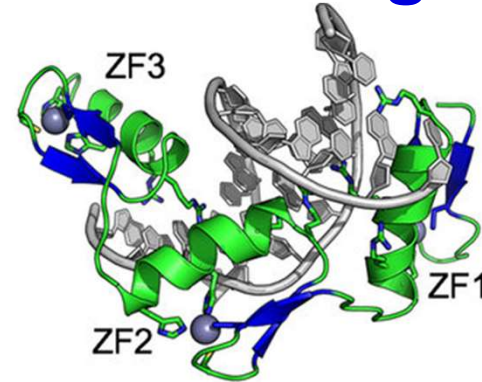

Zinc-finger nucleases – FokI endonuclease

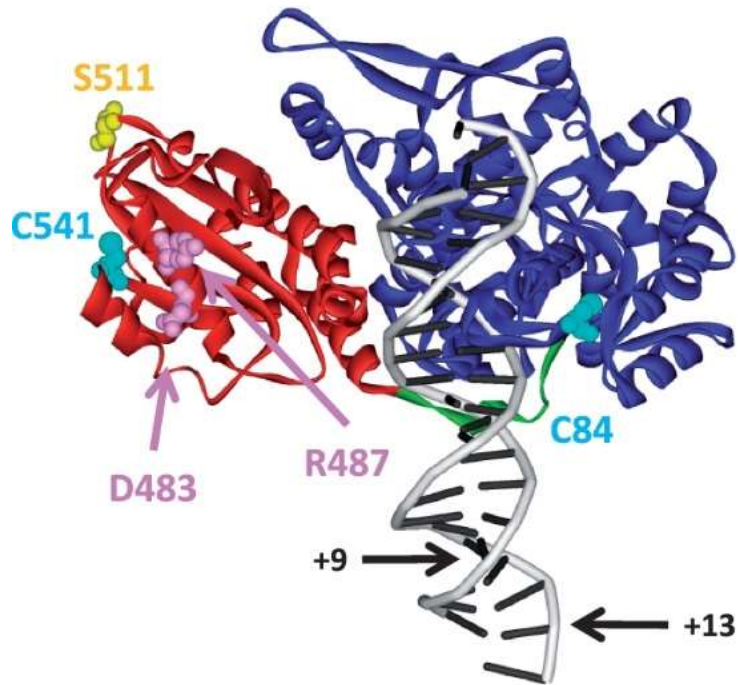

- FokI endonuclease occurs naturally in *Flavobacterium okeanoikoites*.
- Consists of an N-terminal DNA-binding domain distinguishing a 5' GGATG 3' binding site and a C-terminal domain capable of non-specific DNA cleavage.
- After binding to double-helix DNA, a domain capable of cutting is activated, which subsequently cuts:
 - 9 nucleotides per 5' → 3' string
 - 13 nucleotides per 3' → 5' chain.

Zinc-finger nucleases

- To generate a ZFP with specificity for the sequence GGGGGTGAC, three fingers are identified that each bind a component triplet. These fingers are then linked.

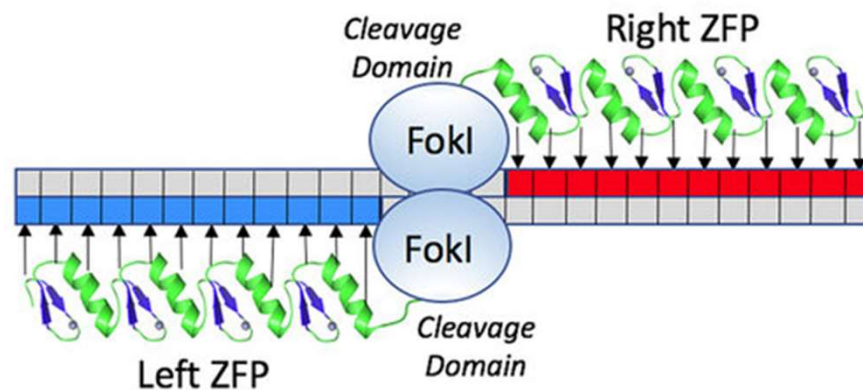
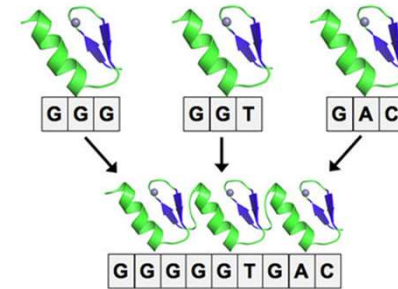

- Sketch of a pair of zinc finger nuclease (ZFN) subunits bound to two halves of a DNA target.
- Each ZFN contains the cleavage domain of FokI linked to an array of three to six zinc fingers to specifically recognize sequences that flank the cleavage site.
- The FokI nuclease domains transiently dimerize across those central bases and cleave each DNA strand to generate a double strand break with 5 overhangs averaging 4 bases in length.

Transcription Activator-Like Effector Nuclease

- TAL: Transcription Activator-Like.
- A group of proteins capable of specific binding to DNA.
- It is used by plant bacteria of the genus *Xantomonas* and affects the DNA of the guest/recipient.
- RVD: Repeat-variable di-residues, these are **amino acids** found in the TAL at **position 12 & 13** that **determine the specificity** to the target nucleotide.

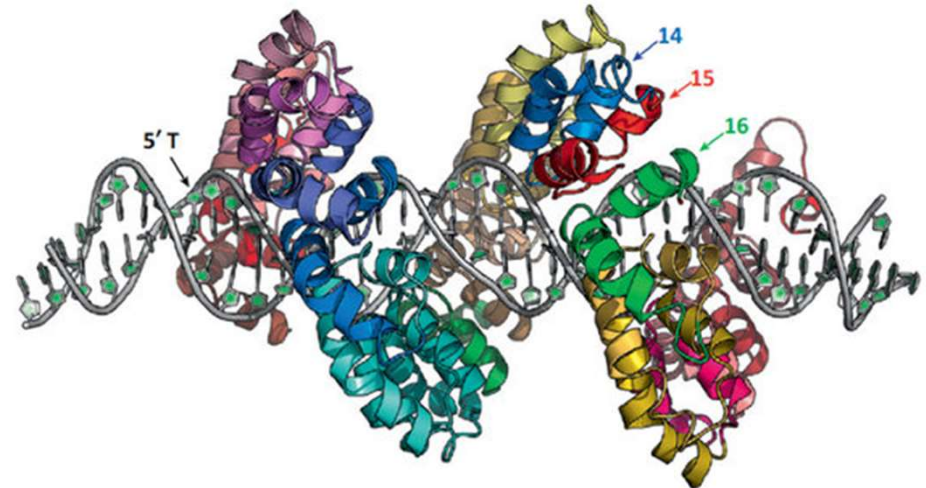

PthXo1 binding region



Transcription Activator-Like Effector Nuclease

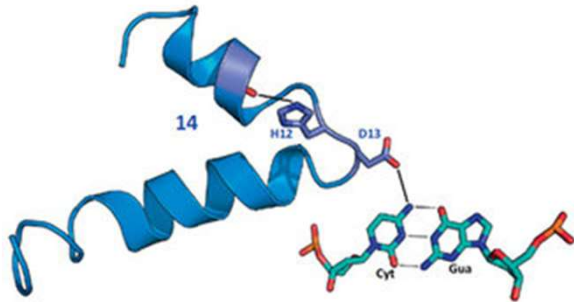

- The histidine at position 12 in the repeat number 14 forms a hydrogen bond to the backbone carbonyl oxygen of residue 8 in the first α -helix, while the aspartate at position 13 forms a hydrogen bond to the extracyclic amino nitrogen of the **cytosine base**.

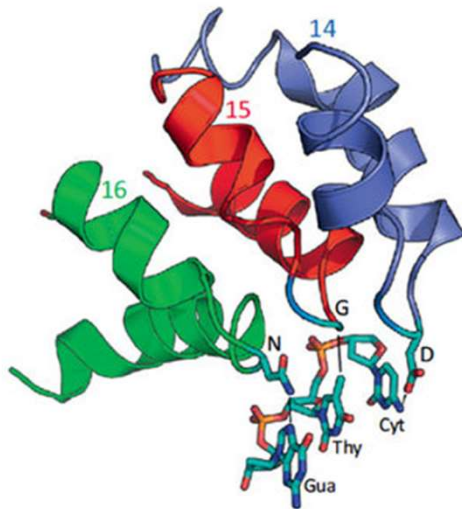

- Repeats 14, 15 and 16 interacting with the DNA, illustrating that consecutive RVDs (HD, NG and NN, respectively in these repeats) contact consecutive bases (in this case **cytosine, thymine, and guanine**) on the same DNA strand.

Transcription Activator-Like Effector Nuclease

- RVD: Repeat-variable di-residues are amino acids in position 12 and 13 determine specificity to the target nucleotide - T, C, A and G.

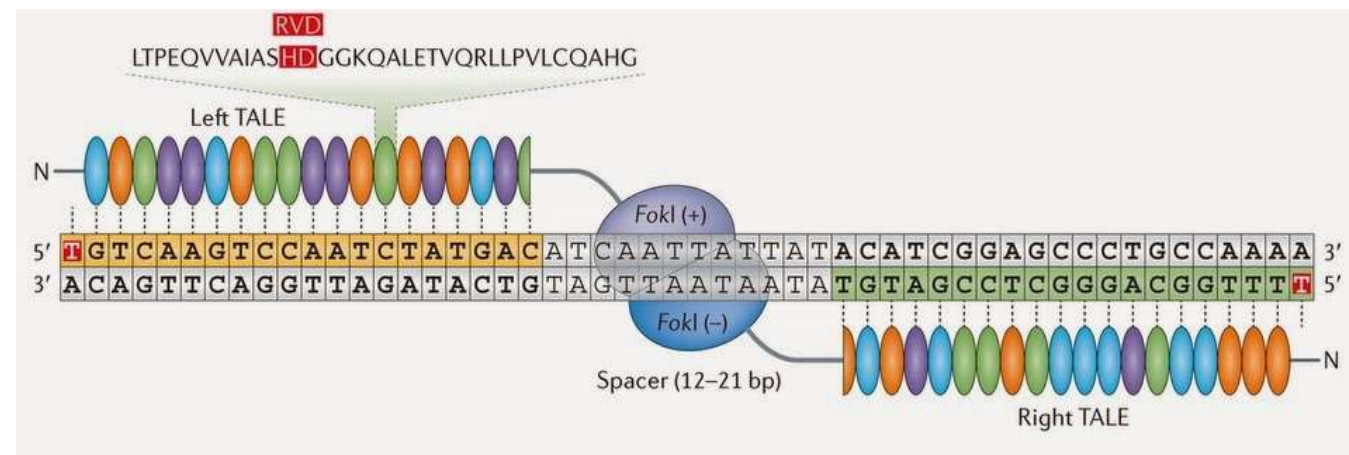
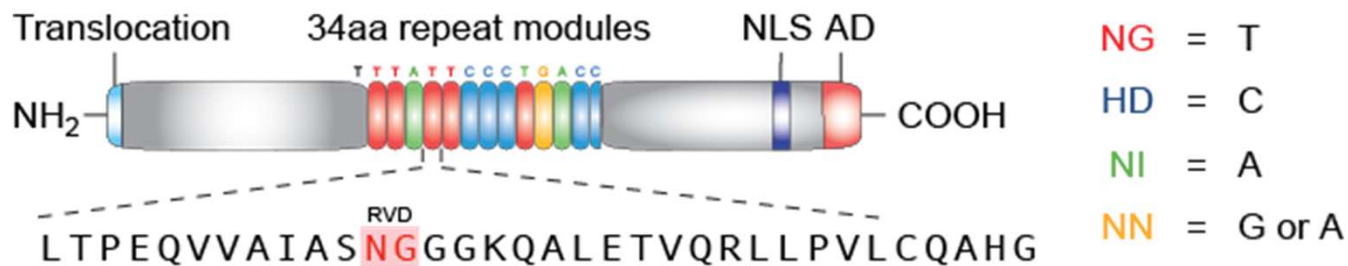

Clustered regularly interspaced short palindromic repeats

- (A) The host is invaded by phage DNA during infection.
- (B) The invading DNA is processed by various Cas genes into small DNA fragments (protospacer). The selection of protospacer depends in part on the specific recognition of protospacer adjacent motif (PAM) present within the viral genome.
- (C) The small DNA fragments is then incorporated into the CRISPR locus of the bacterial genome as a new spacer, flanked by a repeat sequence.
- (D) the CRISPR locus is transcribed into a long precursor CRISPR RNA (pre-crRNA).

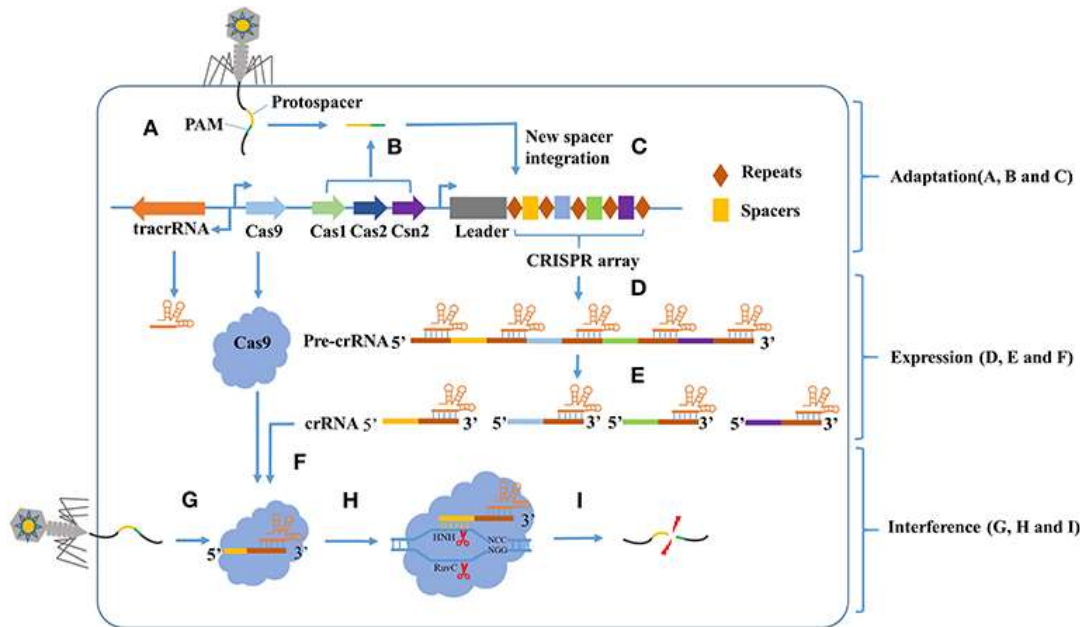

Clustered regularly interspaced short palindromic repeats

- (E) The dual RNA hybrid, tracrRNA with pre-crRNA, is recognized and cut by RNase III.
- (F) The mature crRNA will combine to Cas9 protein and guide the DNA cleavage.
- (G) Phage invades again bacteria.
- (H) The Cas9:crRNA complex identifies a sequence that is complementary to the spacer and adjacent to the PAM.
- (I) Finally, the invading DNA is cleaved by Cas9 protein to prevent infection.

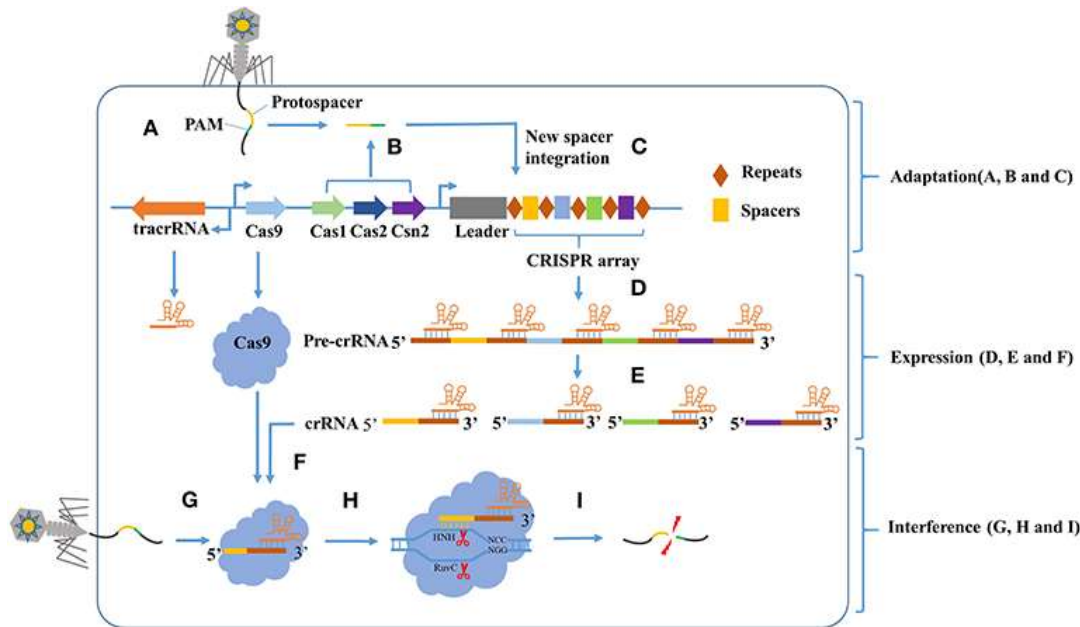

Discovery of tracrRNA

CRISPR RNA maturation by *trans*-encoded small RNA and host factor RNase III

Elitza Deltcheva^{1,2}, Krzysztof Chylinski^{1,2*}, Cynthia M. Sharma^{3*}, Karine Gonzales², Yanjie Chao^{3,4}, Zaid A. Pirzada², Maria R. Eckert², Jörg Vogel^{3,4} & Emmanuelle Charpentier^{1,2}

31 MARCH 2011 | VOL 471 | NATURE | 605

Emmanuelle Charpentier : CRISPR Therapeutics

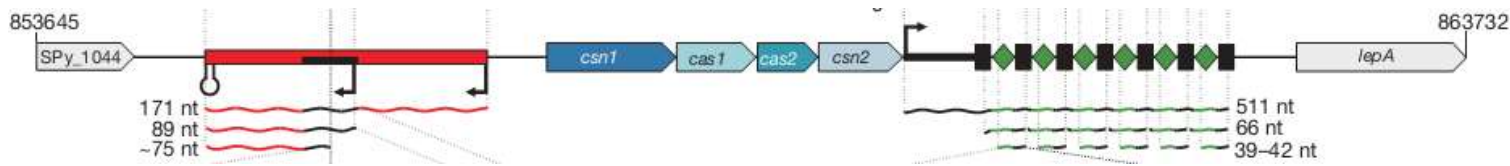

tracrRNA, *trans*-activating CRISPR RNA

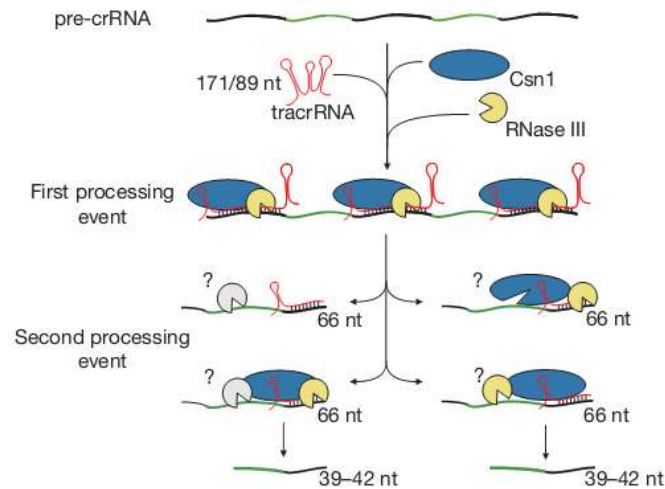

Structure of Cas9

Jennifer Doudna : Intellia Therapeutics & Caribou Biosciences

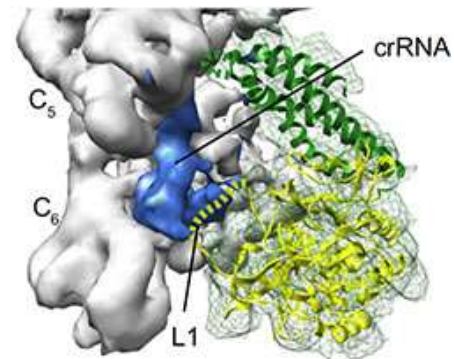
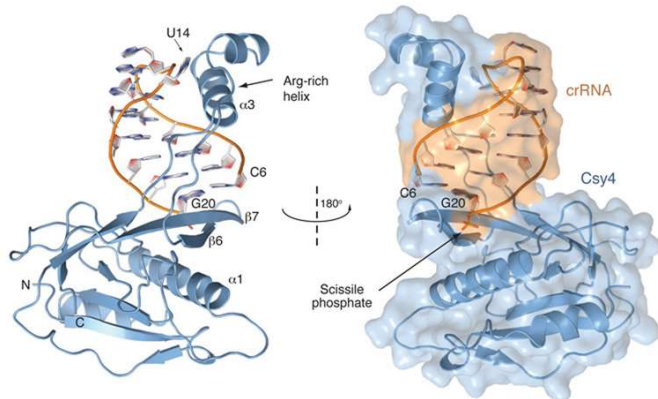
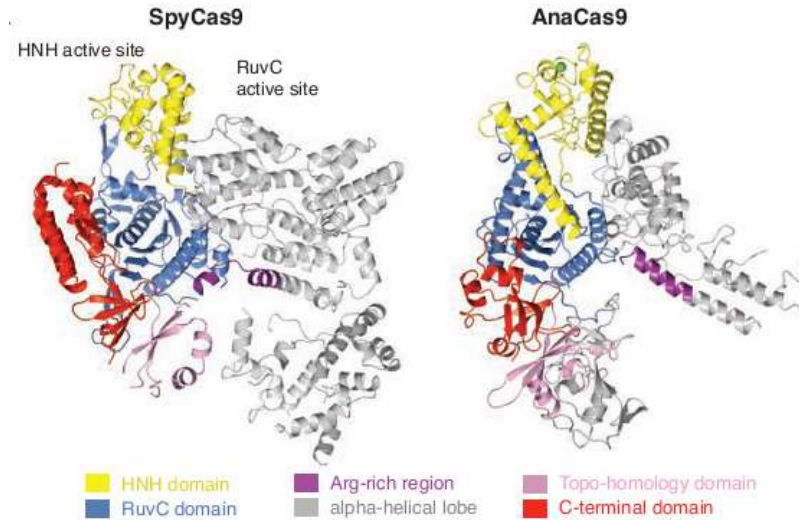

Preparation of dual tracrRNA-crRNA into gRNA

A Programmable Dual-RNA-Guided DNA Endonuclease in Adaptive Bacterial Immunity

Martin Jinek,^{1,2*} Krzysztof Chylinski,^{3,4*} Ines Fonfara,⁴ Michael Hauer,^{2†}
Jennifer A. Doudna,^{1,2,5,6‡} Emmanuelle Charpentier^{4‡}

17 AUGUST 2012 VOL 337 SCIENCE

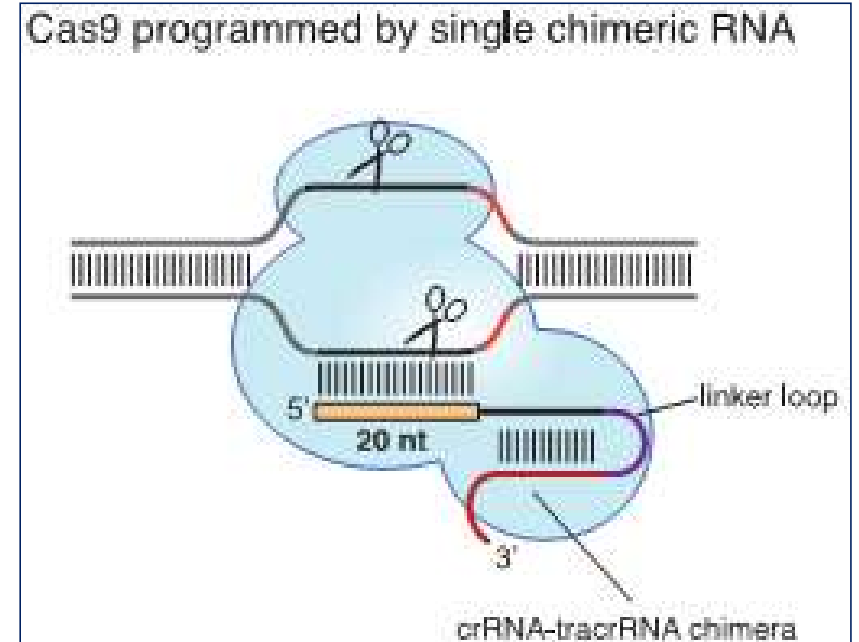

CRISPR/Cas9 system

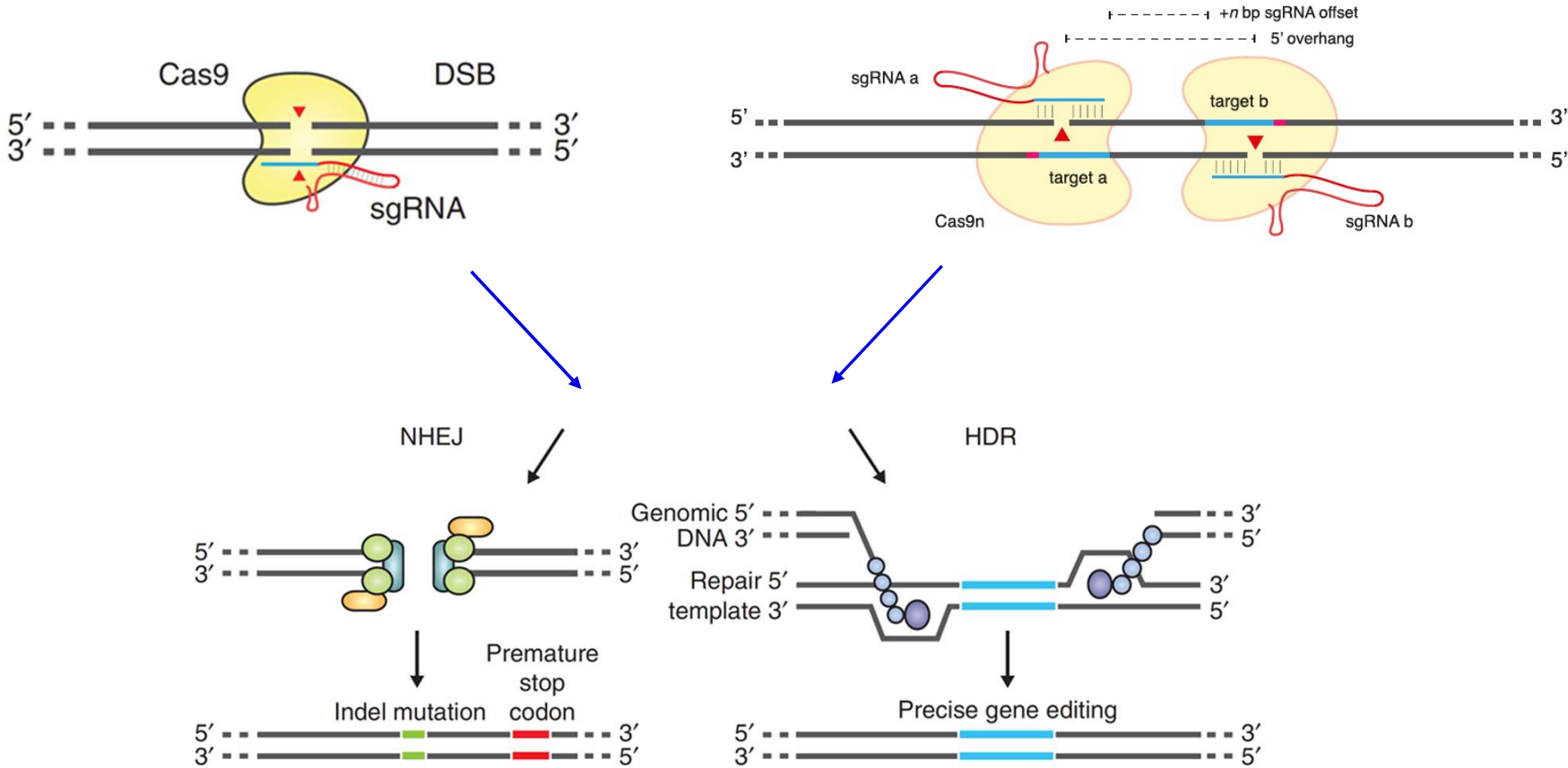

Protein engineering

- **Protein engineering** is the conception and production of **unnatural polypeptides**, often through **modification of amino acid sequences that are found in nature**. Synthetic protein structures and functions can now be designed entirely on a computer or produced through directed evolution in the laboratory.
- **Objective**: to change the structure and function of proteins through recombinant DNA technology:
 - Changes in protein binding regions.
 - Thermostability.
 - Speed and substrate specificity of reactions.
 - Sensitivity to oxidation and toxic substances.

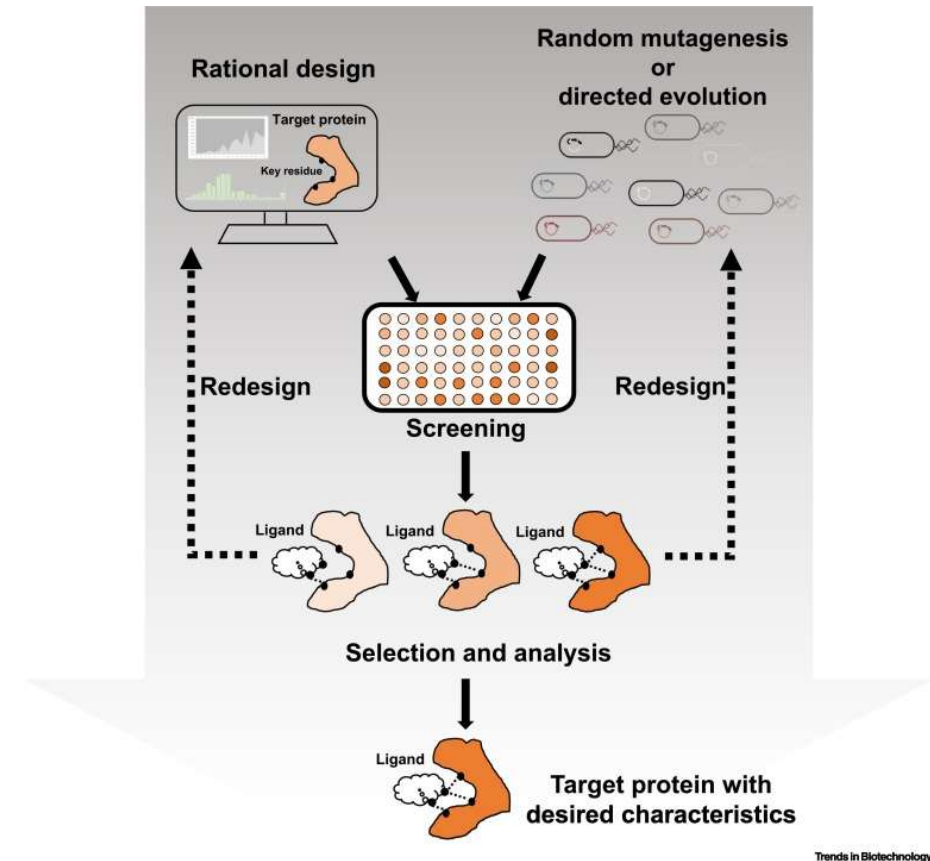

Protein engineering - enzymes in washing powders

- Enzymes in washing powders are strongly genetically modified in order to require traits achieved by genetic modification:
 - Water softening.
 - Detergent for removing impurities (proteins, dyes, polysaccharides, etc.).
 - Efficiency at high and low temperature.
 - Whitening effect.
- **Subtilisin** – is a protease produced by *Bacillus subtilis* into the extracellular space, **decomposes substrates** and their products use as source of nutrients.
 - Lysis a number of substrates.
 - Modified to withstand high temperatures.
 - Expansion for substrates spectrum.
 - Resistance to bleach.
 - All changes were done by successive/step by step amino acid substitutions.



Protein engineering – Industrial application of enzymes

Sector	Enzymes	Applications
Pharmaceuticals	Nitrile hydratase, transaminase, monoamine oxidase, lipase, penicillin acylase	Synthesis of intermediates for production of active pharmaceutical ingredients
Food Processing	Trypsin, amylase, glucose isomerase, papain, pectinase	Conversion of starch to glucose, production of high fructose corn syrup, production of prebiotics, debittering of fruit juice
Detergent	Protease, lipase, amylase, cellulase	Stain removal, removal of fats and oils, color retention,
Biofuels	Lipase, cellulase, xylanase	Production of fatty acid methyl esters, decomposition of lignocellulosic material for bioethanol production
Paper and Pulp	Lipase, cellulase, xylanase	Removal of lignin for improved bleaching, improvement in fiber properties

Insulin

- Insulin is produced by B cells of the islets of Langerhans of the pancreas and released in the blood.
- Insulin lowers blood sugar levels (antagonizes glucagon function).
- Used for the treatment of diabetes.
- In humans composed of two polypeptides A and B connected by two disulfide bonds.

Processing of insulin in mammals

- In mammals - **preproinsulin** (inactive as a hormone) is first translated from the insulin mRNA.
- Proteolytic processing is necessary to make biologically active insulin.
- (A) The linear protein preproinsulin contains a **signal sequence**, which is cleaved after the protein enters the ER, an A chain, a B chain, and a C-peptide.
- (B) Inside the ER, the proinsulin (insulin precursor) folds and **disulfide bonds form between cysteines**.
- (C) Finally, **two cleavages release the C peptide**, which leaves the **A and B chains attached by the disulfide bonds**. This is now active insulin.

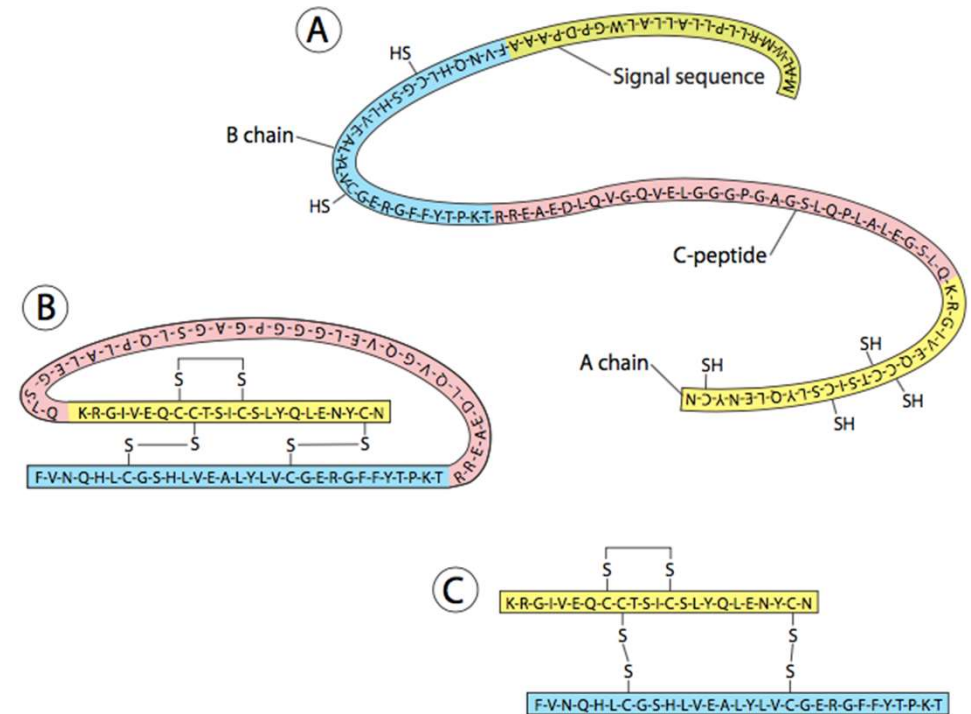

Industrial production of recombinant insulin

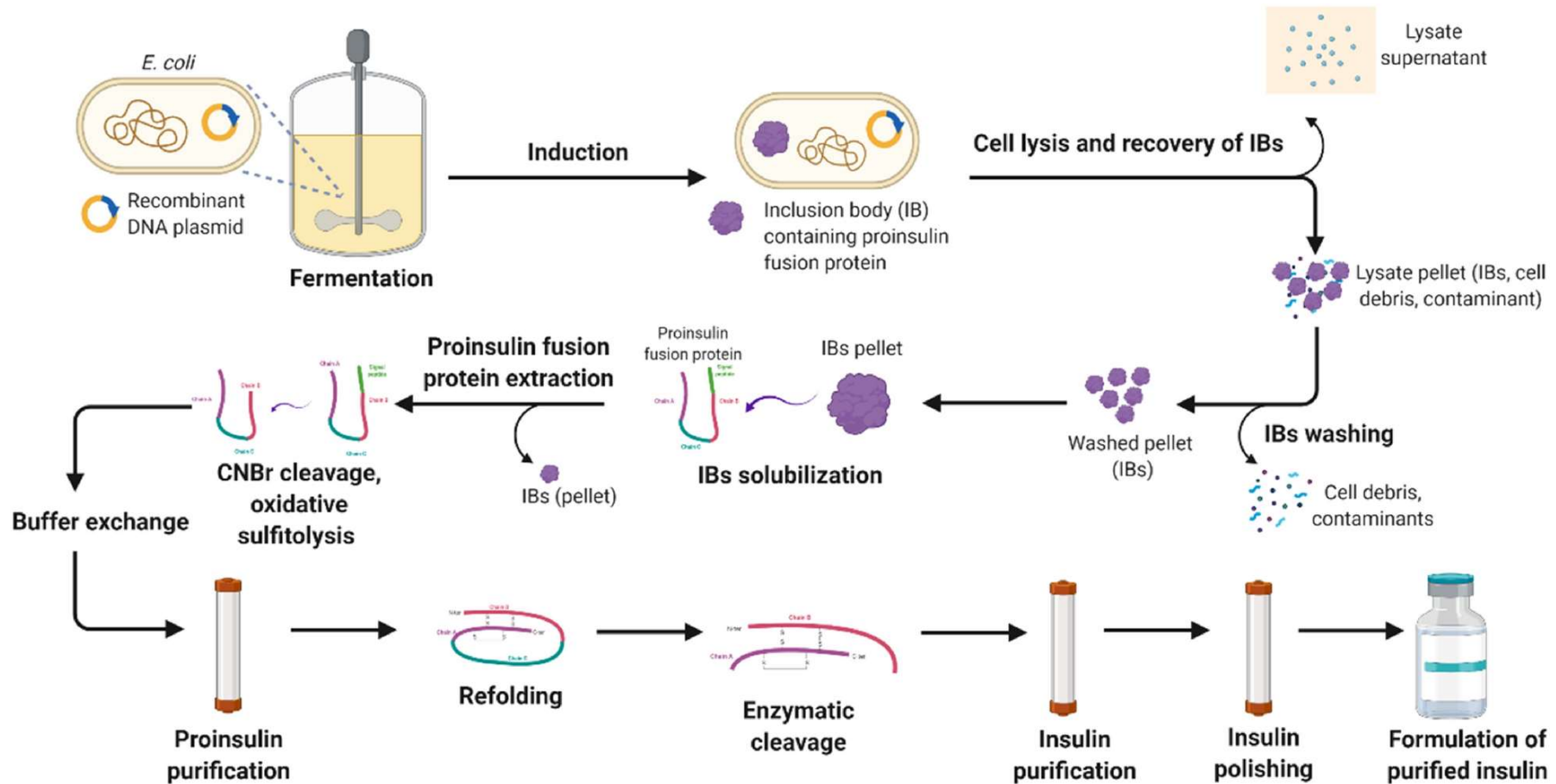

Plant transformation by *Agrobacterium tumefaciens*

- Gene transfer from bacteria to plants occurs naturally.
- *Agrobacterium tumefaciens* is a soil pathogen, a gram-negative bacterium which infects many species of plants causing a disease known as “crown gall”.
- It has two common species:
 - *A. tumefaciens*
 - *A. rhizogenes*



Plant transformation by *Agrobacterium tumefaciens*

- The oncogenic activity of *Agrobacterium* is due to the presence of a large (200-kb) tumor inducing **plasmid (pTi)** and tumor formation results from its infection into the host plant (dicotyledonous plants).
- Upon infection of the wounded plant, the **bacterium transfers a small segment of DNA**, the so-called T-DNA from the Ti **plasmid into the plant cell**.
- The **T-DNA** is then translocated into the plant nucleus and **stably integrated into the chromosome**.
- In the Ti-plasmid itself, the T-DNA is flanked by 25-bp imperfect direct repeats known as border sequences.

Plant transformation by *Agrobacterium tumefaciens*

- The wild type T-DNA encodes a specific set of **oncogenic (*onc*)** genes that when it is **expressed in the host cell**, leads to the formation of a **tumor**.
- T-DNA carries genes for **phytohormone** (auxin and cytokinin) and opines.
- The overproduction of phytohormones at the site of infection is responsible for the **proliferation of wound cells into a gall** (tumor) that can harbor a population of bacteria.

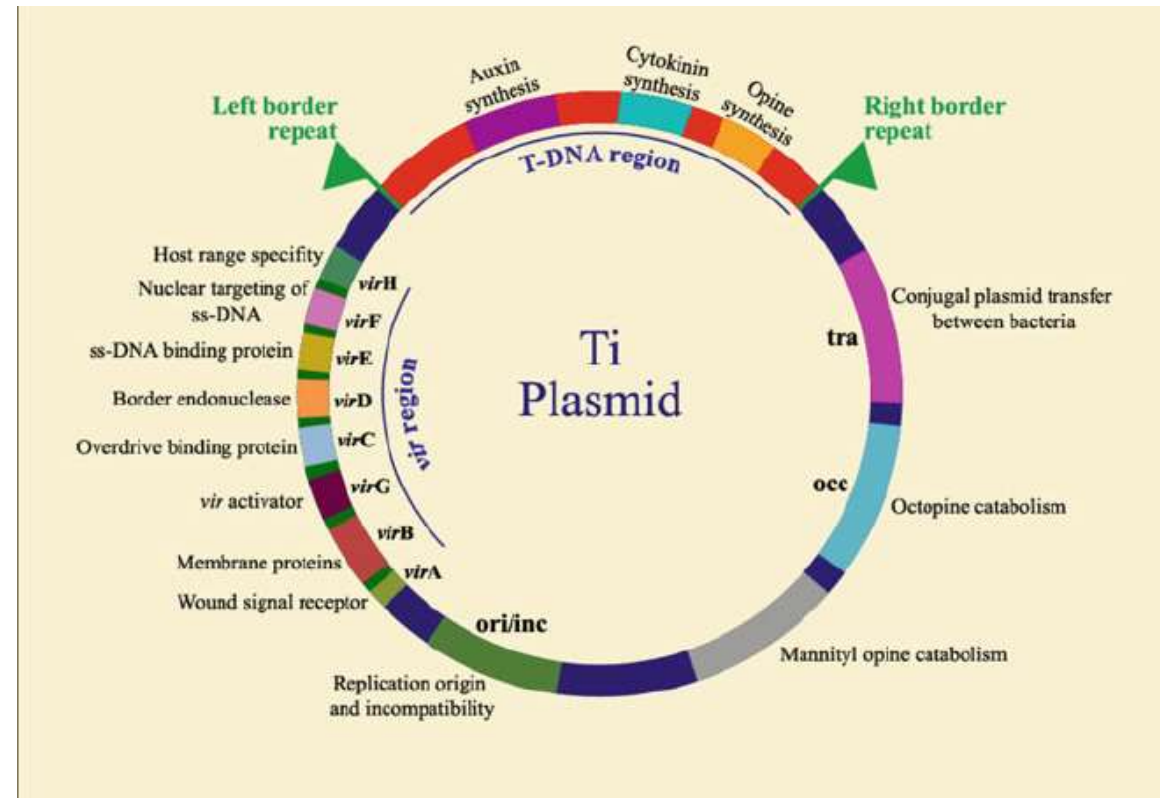

Plant transformation by *Agrobacterium tumefaciens*

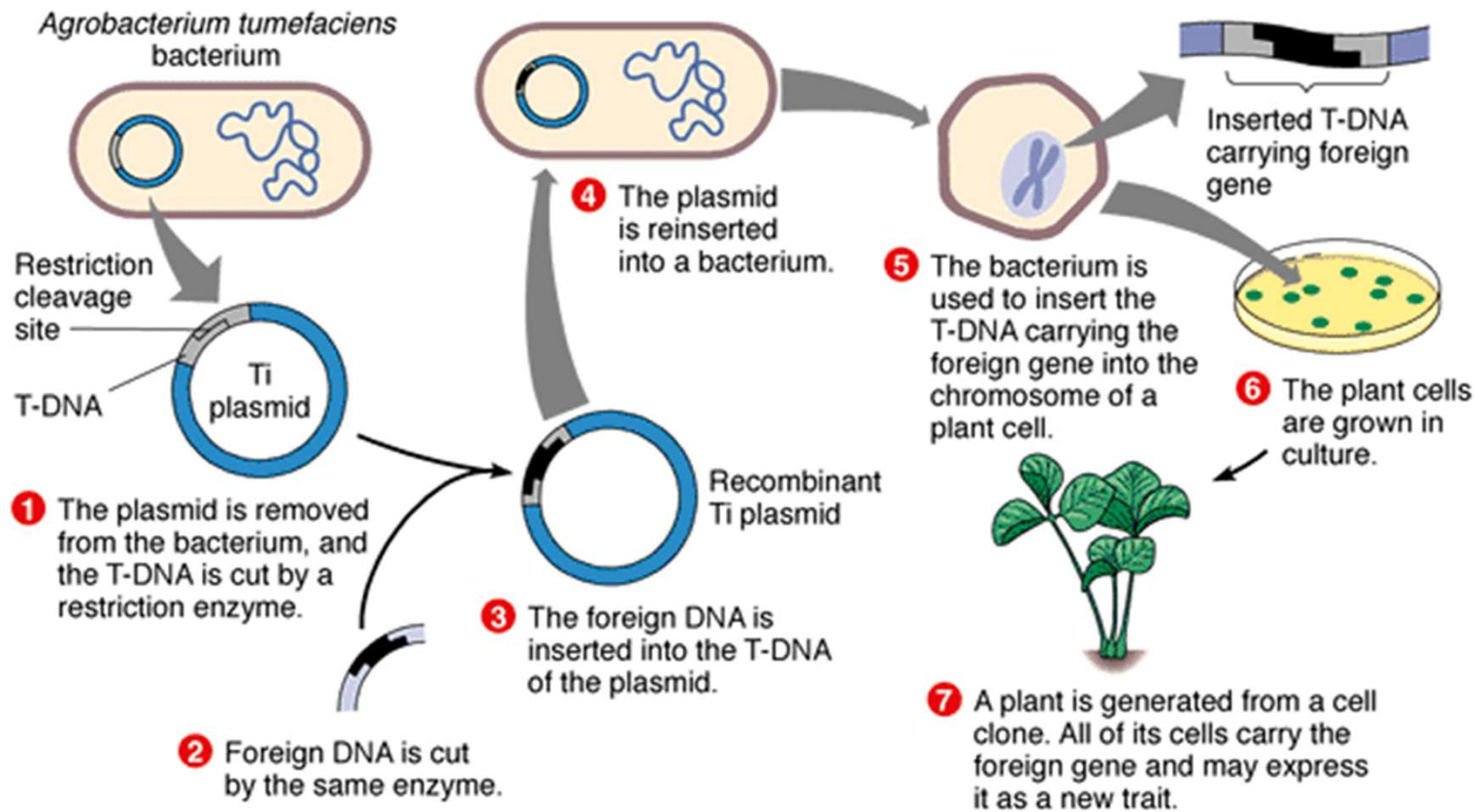

© BENJAMIN/CUMMINGS

Plant transformation by *Agrobacterium tumefaciens*

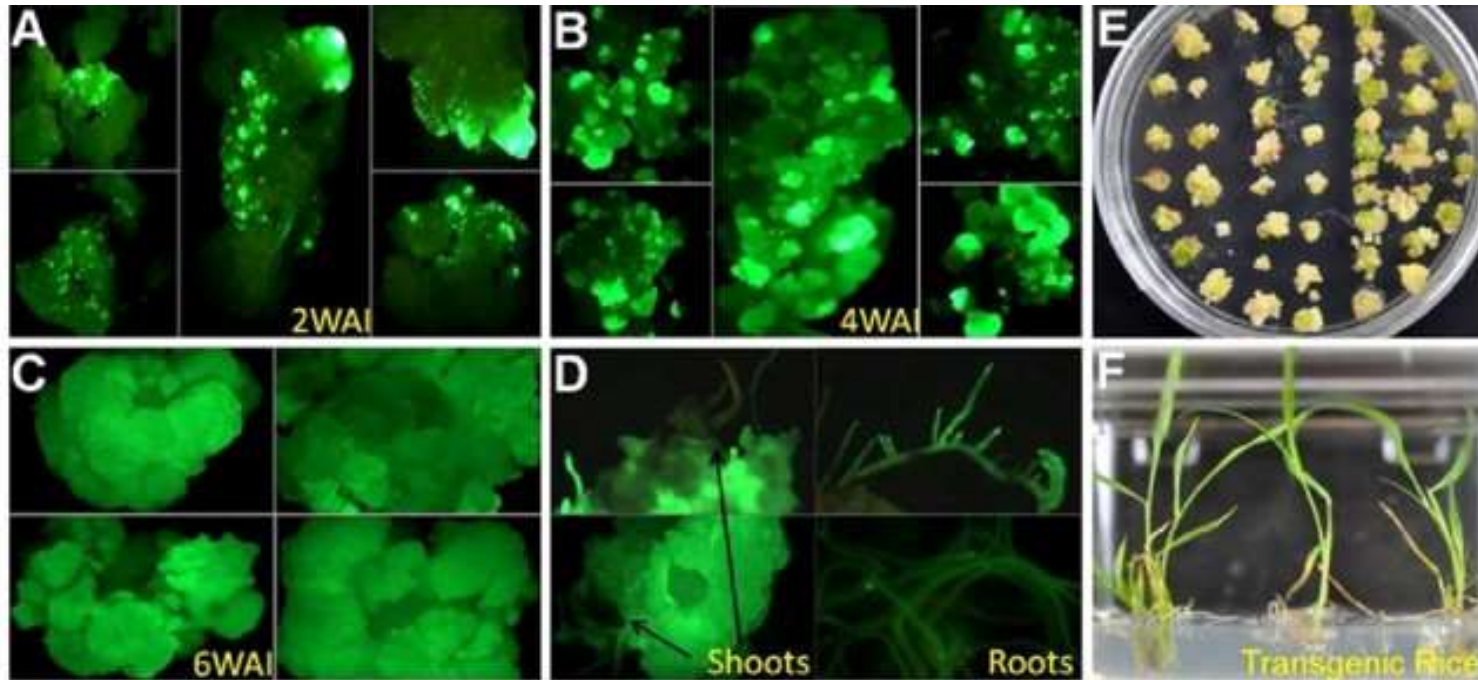

- Schematic presentation of rice transformation.
- GFP expression in callus 2 weeks after infection (A), 4 weeks after infection (B), 6 weeks after infection (C), and in regenerating shoots and roots (D).

Use of genetic engineering in the plants

- Food and feed.
- Influencing agronomic properties:
 - Herbicide resistance.
 - Resistance to pathogens (insects, viruses, fungi, etc.).
 - Tolerance to stress (water stress – drought, temperature –frost; osmotic stress – salinization of soils).
- Modification of post-harvest properties:
 - Extended shelf-life.
 - Slowing down maturation and inducing resistance to shelf storage diseases.
 - Refine nutritional value and taste.

Use of genetic engineering in the plants

- Production of secondary metabolites:
 - Pharmacological preparations.
- Technical crops:
 - Production of starch and oils for industrial use.
 - Biodegradable plastics.
- Phytoremediation:
 - Use of green plants to remove polluting substances from the environment.

Transgenic plants

- Resistance to insect pests.
- The spores of bacterium *Bacillus thuringiensis* produce protein with toxic effects on insects Delta endotoxin = δ -endotoxin.
- δ -endotoxin is highly poisonous to some groups of insects, but completely harmless to mammals and humans. δ -endotoxin changes to a toxic form, the only in the intestine of insects.
- Previously bacteria *Bacillus thuringiensis* cultured in large volumes and as spraying applied to plants .
- Later the gene for δ -endotoxin transferred to plants directly - transgenic potatoes, corn, rice, tobacco, tomato, broccoli, cotton.
- Indirect way – cloning the gene for toxin into bacteria colonizing plants (leaves, roots)– e.g. *Pseudomonas fluorescens*.

Bacillus thuringiensis (Bt)

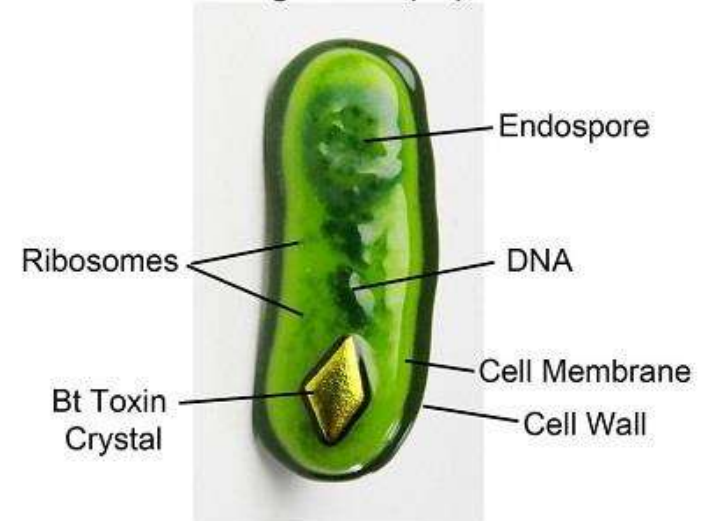

Transgenic BT-Maize

- In addition, it contains 3 genes:
 - Gene for plant **resistance to insect pests**.
 - δ -endotoxin from *B. thuringiensis*.
 - Gene for **resistance to the herbicide Basta**.
 - Basta is a short-lived herbicide, that is environmentally friendly.
 - The gene for resistance comes from the bacterium *Streptomyces*.
 - Gene for **resistance to the antibiotic ampicillin**.
 - Selection marker used for selection of transgenic plants (cells).
 - The gene is of bacterial origin.



Transgenic plants

- Herbicide resistance:
- Weeds negatively affect the yield and quality of the crop (competition for nutrients, light, pest source).
- Herbicides are chemicals that disrupt certain metabolic processes in the plant and damage it.
- Selective weed elimination is a problem, a number of herbicides are total - they also destroy cultural crops.
- Only after the introduction of herbicide insensitivity transgenes into the genome of cultural crops is achieved its selectivity.

Transgenic plants

- Resistance to the herbicide glyphosate (Roundup).
- **Glyphosate** – non-selective, total herbicide.
- Effective on 76 of the 78 most important weeds.
- Inhibits enzymes providing the synthesis of essential amino acids.
- This enzyme is not present in animals – the herbicide does not harm them.
- Strategy:
 - Introduction of a gene for the formation of the target enzyme into agricultural plants (a larger amount of enzyme will improve the resistance of plants).
 - Introduction of a gene for the formation of altered - more active enzyme.
 - Introduction of a gene for the formation of an enzyme that inactivates the herbicide.



Transgenic plants

- Improvement of nutritional values of fruits and seeds or plant products used industrially.
- **FlavrSavr** tomato from company Calgene.
- The tomato was made **more resistant to rotting**, by adding an **antisense RNA** which interferes with the production of the **enzyme polygalacturonase**. This enzyme is normally responsible for cell walls softening during the fruit ripening.
- Unmodified tomatoes are picked before fully ripened and artificially ripened using **ethylene gas** which acts as a plant hormone - easier handling and extended shelf-life.
- FlavrSavr tomatoes could be allowed to ripen on the vine, without compromising their shelf-life.

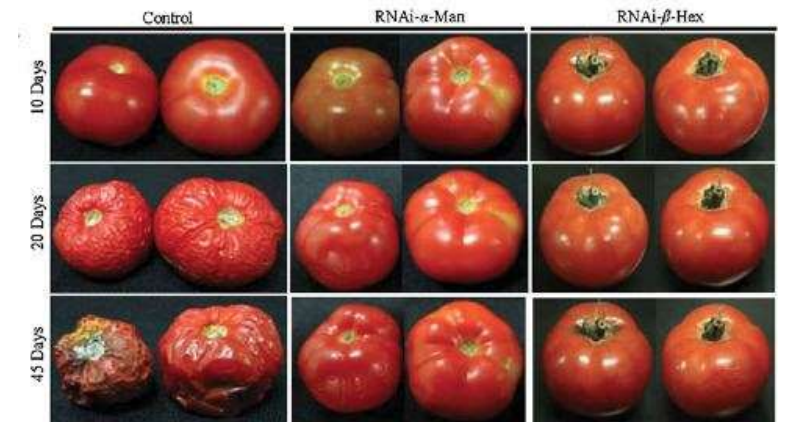

Transgenic plants

- Improvement of nutritional values of fruits and seeds or plant products used industrially.
- Rice with provitamin A (carotene):
- Solves vitamin A deficiency in poor countries (consequence of night blindness, blindness).
- Three genes introduced into the rice genome, the expression of which leads to the formation of provitamin A.
- Further modification of rice aims to increase the iron content.

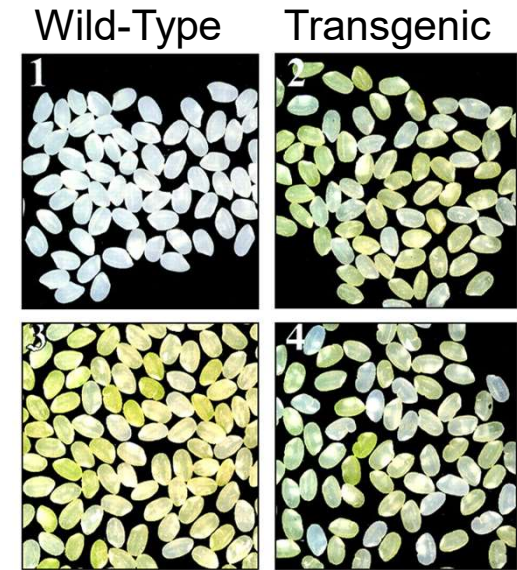

Transgenic plants

- Improvement of nutritional values of fruits and seeds or plant products used industrially.
- *Brassica napus* var. *Napus*, rapeseed - seed oil containing an increased proportion of acid. Lauric (soaps and detergents).
- *Rapeseed* – seed oil rich in myristate (cosmetics), or erucic acid (lubricants and nylon production).
- *Arabidopsis* and *rapeseed* – formation of biodegradable polymers in chloroplasts usable as plastics (polyhydroxybutyrate, polyester-like polymers in cotton fibers).
- *Decaffeinated coffee plant* - due to spontaneous mutations a rare variant found in which a key enzyme for caffeine formation is absent.

Transgenic plants – vaccine production

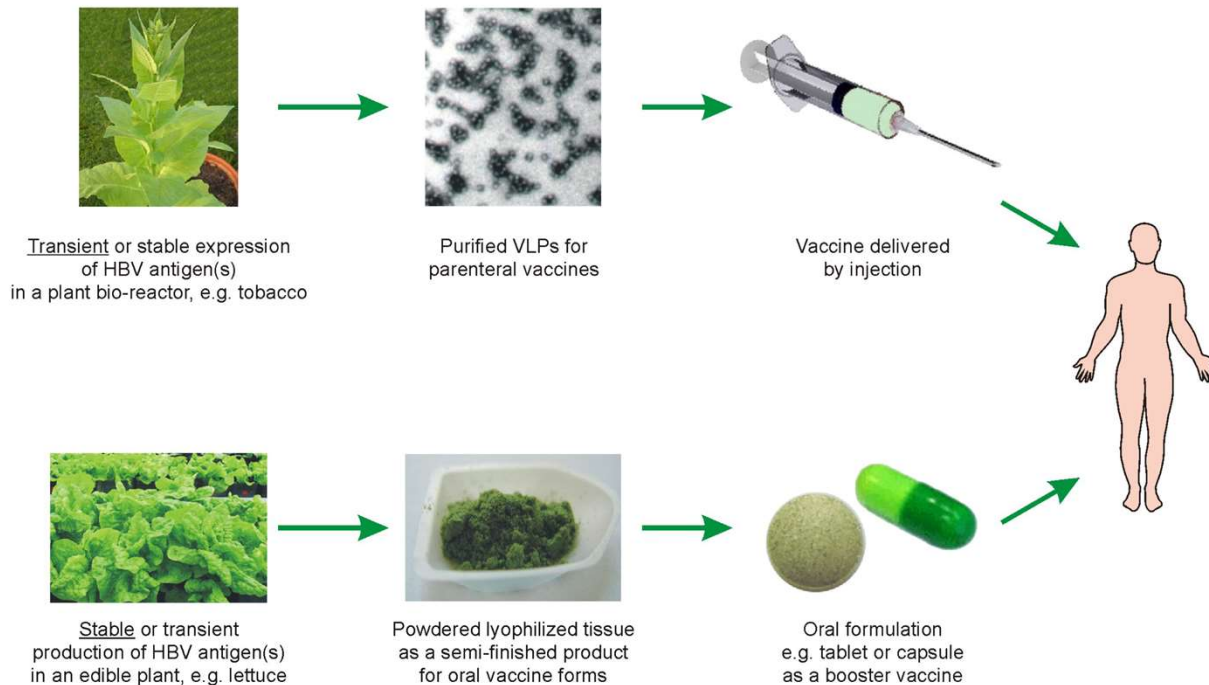

- Plants are suitable for **passive immunization** (eating transgenic plants containing fragments of antibodies) and **active immunization** (antibody induction).
- Immunization by eating raw vegetables containing antigen (vaccine), which induces the production of immunoglobulins **mucosal immune system in the digestive tract**.
 - Hepatitis B virus surface antigen.
 - Subunit B toxin cholera.

Transgenic plants

- Developmental status of edible vaccines in clinical trials.

Pathogen	Antigen	Host	Use	Clinical trial status
Enterotoxigenic <i>E. coli</i>	LT- B	Potato	Diarrhoea	Early phase 1
Enterotoxigenic <i>E. coli</i>	LT- B	Maize	Diarrhoea	Early phase 1
Norwalk Virus	CP	Potato	Diarrhoea	Early phase 1
Rabies Virus	GP/ NP	Spinach	Rabies	Early phase 1
HBV	HBsAg	Lettuce	Hepatitis B	Early phase 1
HBV	HBsAg	Potato	Hepatitis B	Phase 1
<i>Vibrio cholerae</i>	CTB	Rice	Cholera	Phase 1
HBV	HBV	<i>Saccharomyces cerevisiae</i>	Chronic HBV	Phase 2

Transgenic animals

- Instrumental tool to:
- Study of the functioning of genes in the context of the whole organism.
- Improving the performance characteristics of livestock.
- Formation of foreign proteins.
- Models of study of genetic diseases.
- Searching for possibilities for gene therapy of human diseases.

Transgenic animals – mouse

- *Mus musculus* – mouse
- Reproduction:
 - 5-10 litters / year
 - 5-10 pups / litter
 - 19-21 day gestation
 - Sexually mature at 7 weeks
 - 4-5 generations per year



Transgenic animals – transgenic mouse

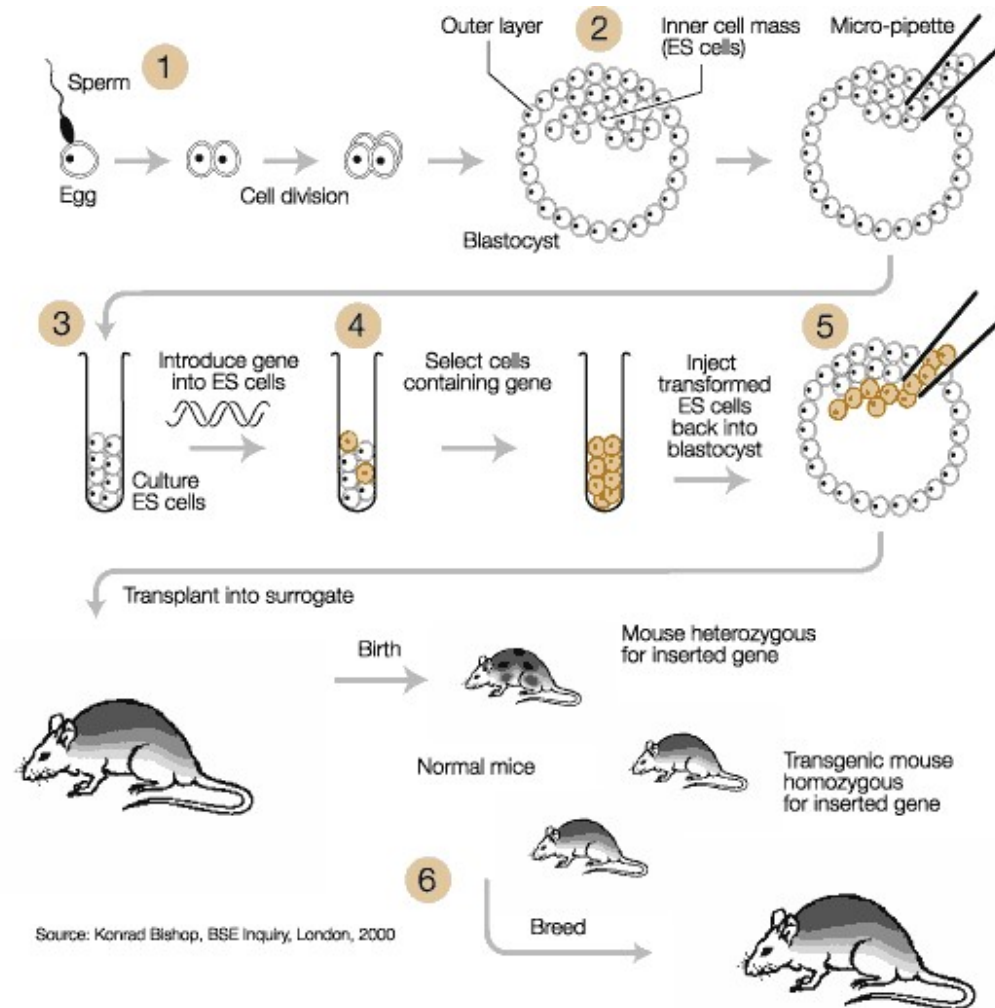

Transgenic mouse – gene of interest insertion

- **Microinjection** of cloned gene into nucleus of newly fertilized egg.
- **Transfection** incubate ES cells in solution that makes them take up the DNA, very inefficient need to identify cells that took up the DNA with reporter such as drug resistance.
- **Electroporation** – a high voltage pulse “pushes” DNA into cells.
- **Retroviruses** – a more natural way of getting genes into cells.

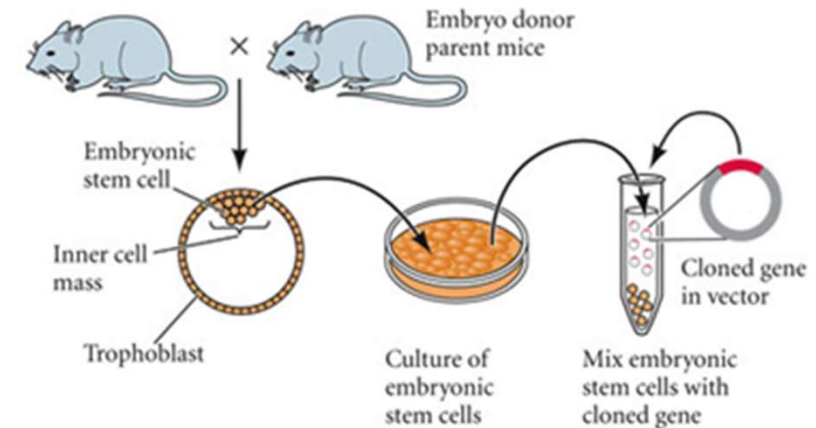

Transgenic mouse – gene of interest insertion

- Method used in producing transgenic mice by the microinjection of exogenous DNA into the pronuclei of fertilized eggs.

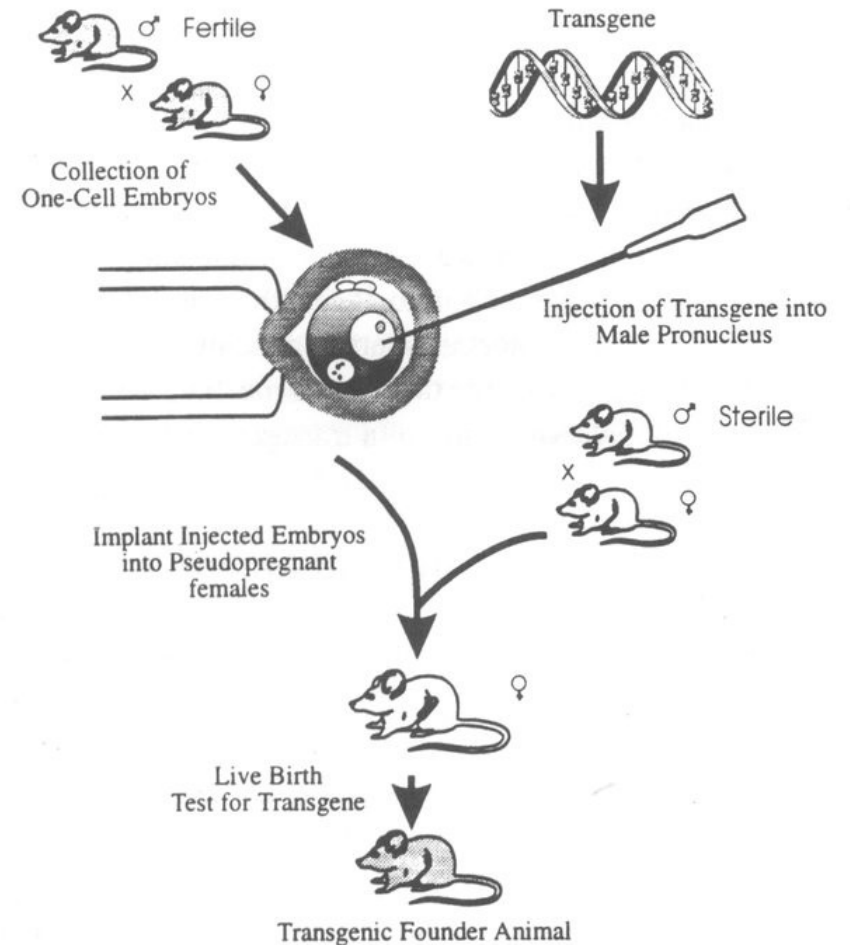
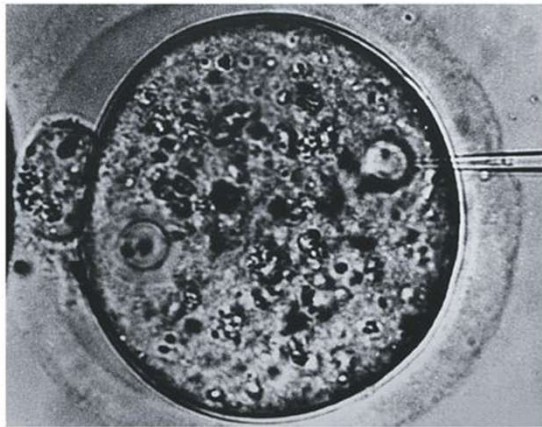

Transgenic mouse – gene of interest insertion

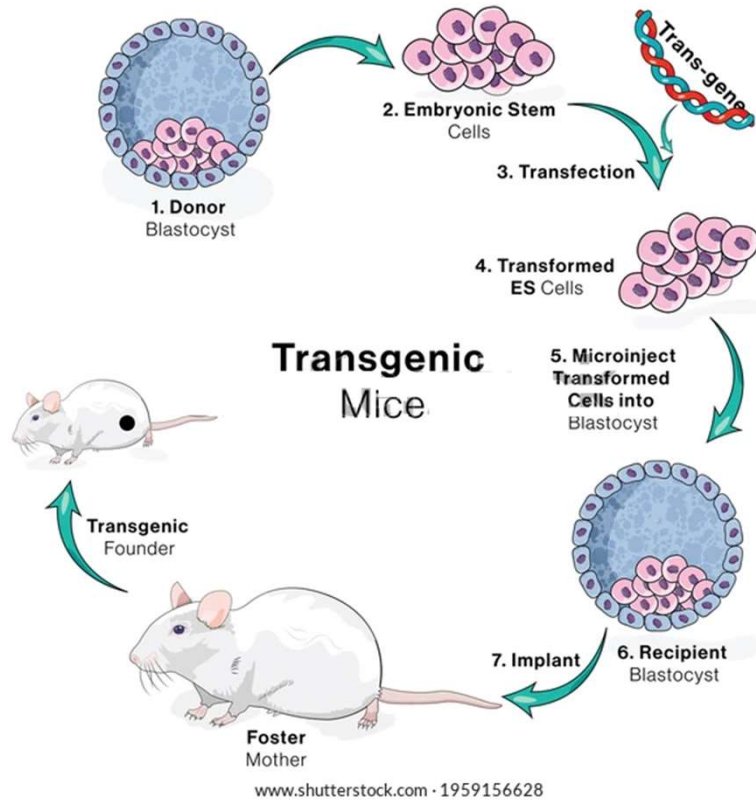

- Embryonic stem cells are cultured and subjected to **DNA-mediated gene transfer** or other manipulations.
- Cells with the desired genetic alteration are then **inserted into blastocyst cavities**, whereupon they resume normal development and produce a **genetically mosaic mice**, with some cells derived from the ES line, and the others from the injected blastocyst.
- **Founders**, usually males, are then bred to pass on the gene, provided the ES cells differentiate into sperm. The **F1 hybrid** then carries the new gene in all cells.

Transgenic mouse – gene of interest insertion

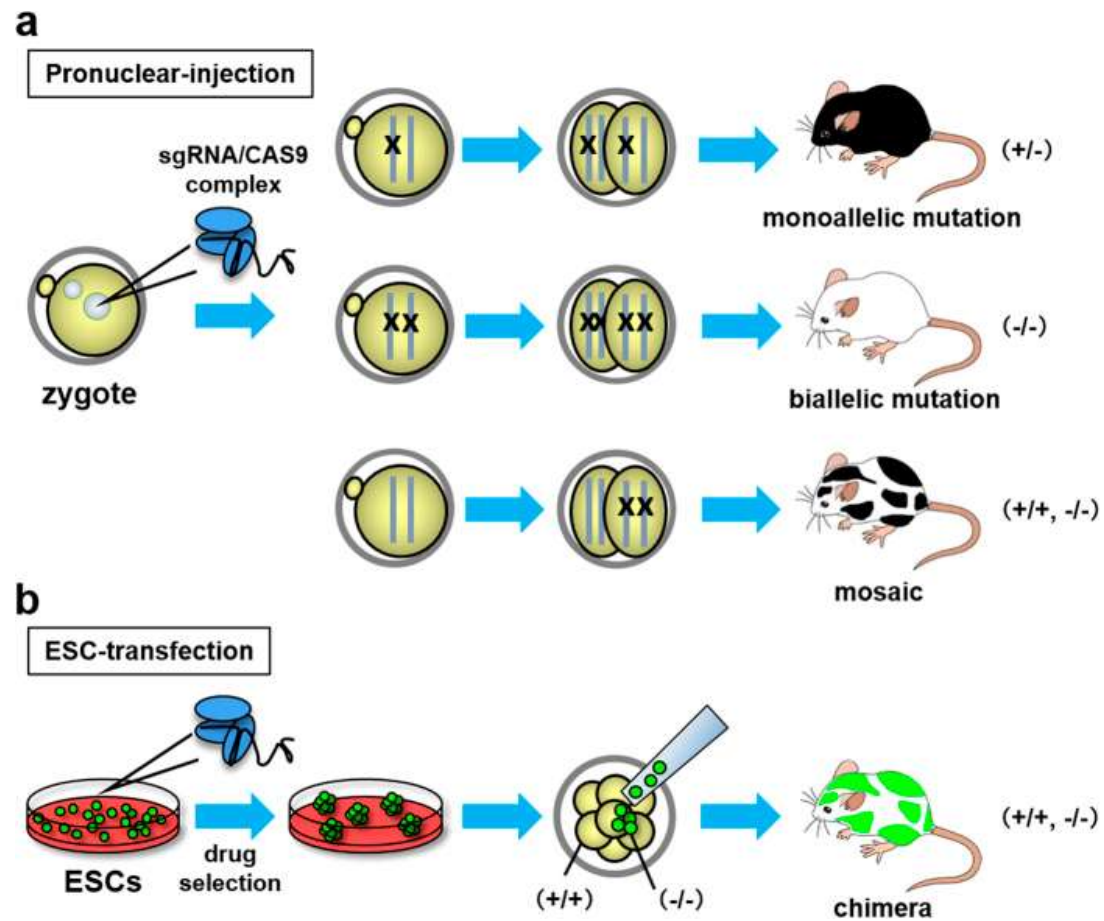

Transgenic mouse – gene of interest insertion

- Chimeric mice generated from ESCs carrying a biallelic mutation in *Cetn1* gene (em51/em52). Highly chimeric animals have darker coat color.
- Testes of B6D2F1 (wt) and chimeric mice (chi) were photographed under bright and fluorescent field.

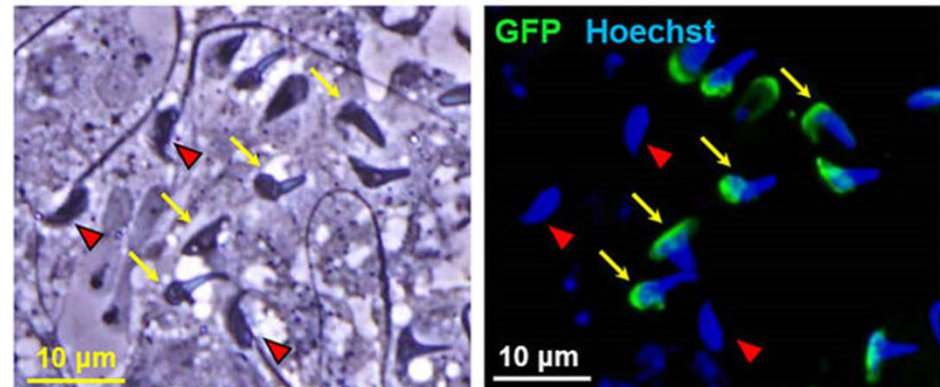
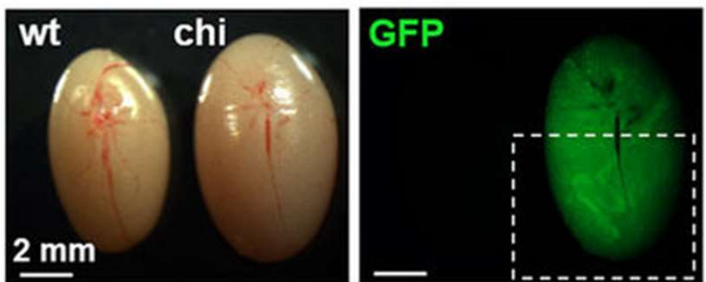

Transgenic salmon

- AquAdvantage Salmon has been genetically engineered.
- It contains an rDNA construct that is composed of the growth hormone gene from Chinook salmon under the control of a promoter from ocean pout.



<https://www.fda.gov/animal-veterinary/aquadvantage-salmon/qa-fdas-approval-aquadvantage-salmon>

<https://www.soilassociation.org/blogs/2017/august/theres-something-fishy-about-genetically-engineered-salmon/>

Transgenic animals

Protein	Source	Against
Antithrombin III	Goat	Thrombosis
Tissue plasminogen activator	Sheep, pig	Thrombosis
á-antitrypsin	Sheep	Emphysema
Factor VIII, IX	Sheep, pig, cow	Hemophilia
á –Glucosidase	Rabbit	Pompe's disease
Fibrinogen	Cow, sheep	Wound healing
Glutamic acid decarboxylase	Goat	Type 1 diabetes
Human serum albumin	Cow, sheep	Maintenance of blood volume
Human protein c	Goat	Thrombosis
Monoclonal antibodies	Chicken, cow, goat	Vaccine production
Pro 542	Goat	HIV
Lactoferrin	Cow	GI tract infection and infectious arthritis.

Cloning of animals

- Cloning is a controversial process that involves creating a genetically identical organism, or clone, from the genetic material of an individual.
- Clones are created by inserting a nucleus from an individual into an unfertilized egg. The egg will develop as if it had been fertilized to create a new living organism.
- In 1996, scientists were able to successfully clone the first mammal, a sheep, after 276 attempts.
- The successful clone was named Dolly. Since Dolly, scientists have successfully cloned other animals, such as, cats, cows, dogs, and rabbits.



Ian Wilmut
University of Edinburgh

Cloning of animals

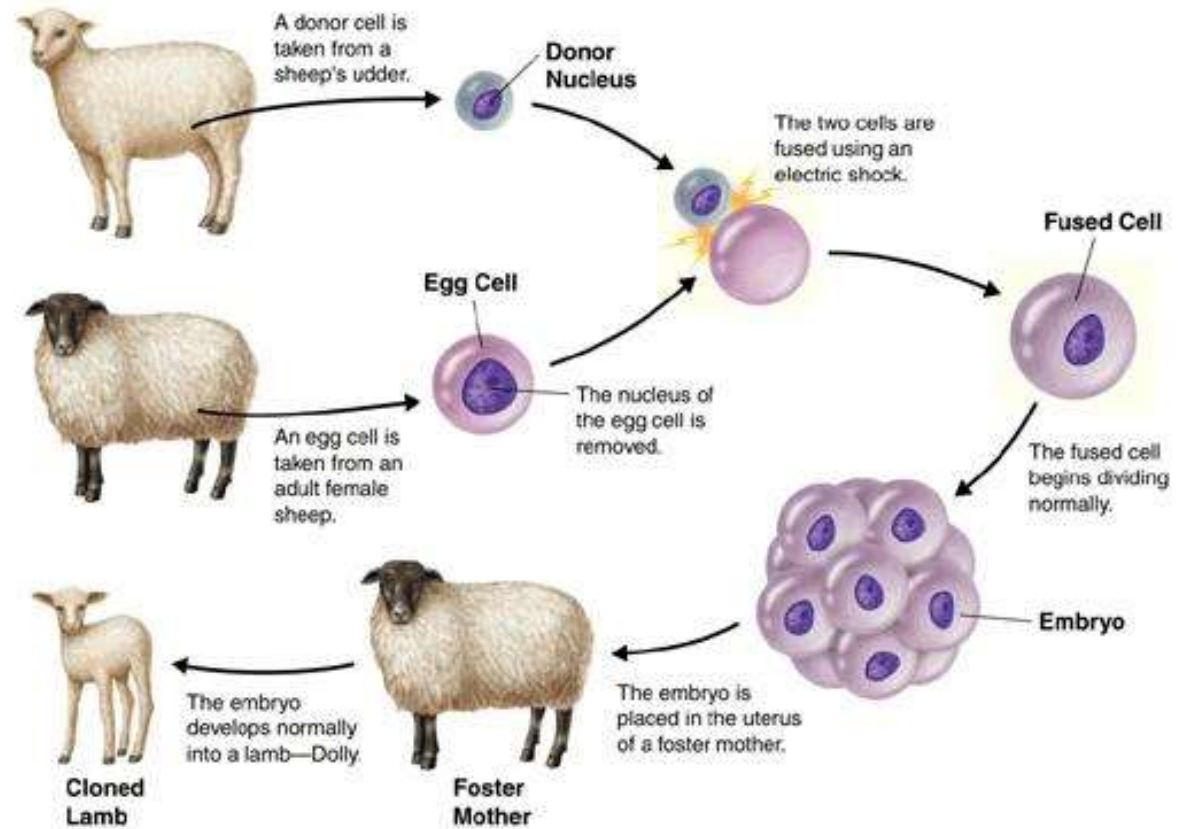

Gene therapy

- **Gene therapy** is a technique that modifies a person's genes to treat or cure disease. Gene therapies can work by several mechanisms:
 - Replacing a disease-causing gene with a healthy copy of the gene.
 - Inactivating a disease-causing gene that is not functioning properly.
 - Introducing a new or modified gene into the body to help treat a disease.
- Gene therapy products are being studied to treat diseases including cancer, genetic diseases, and infectious diseases.

Road Map of Gene therapy

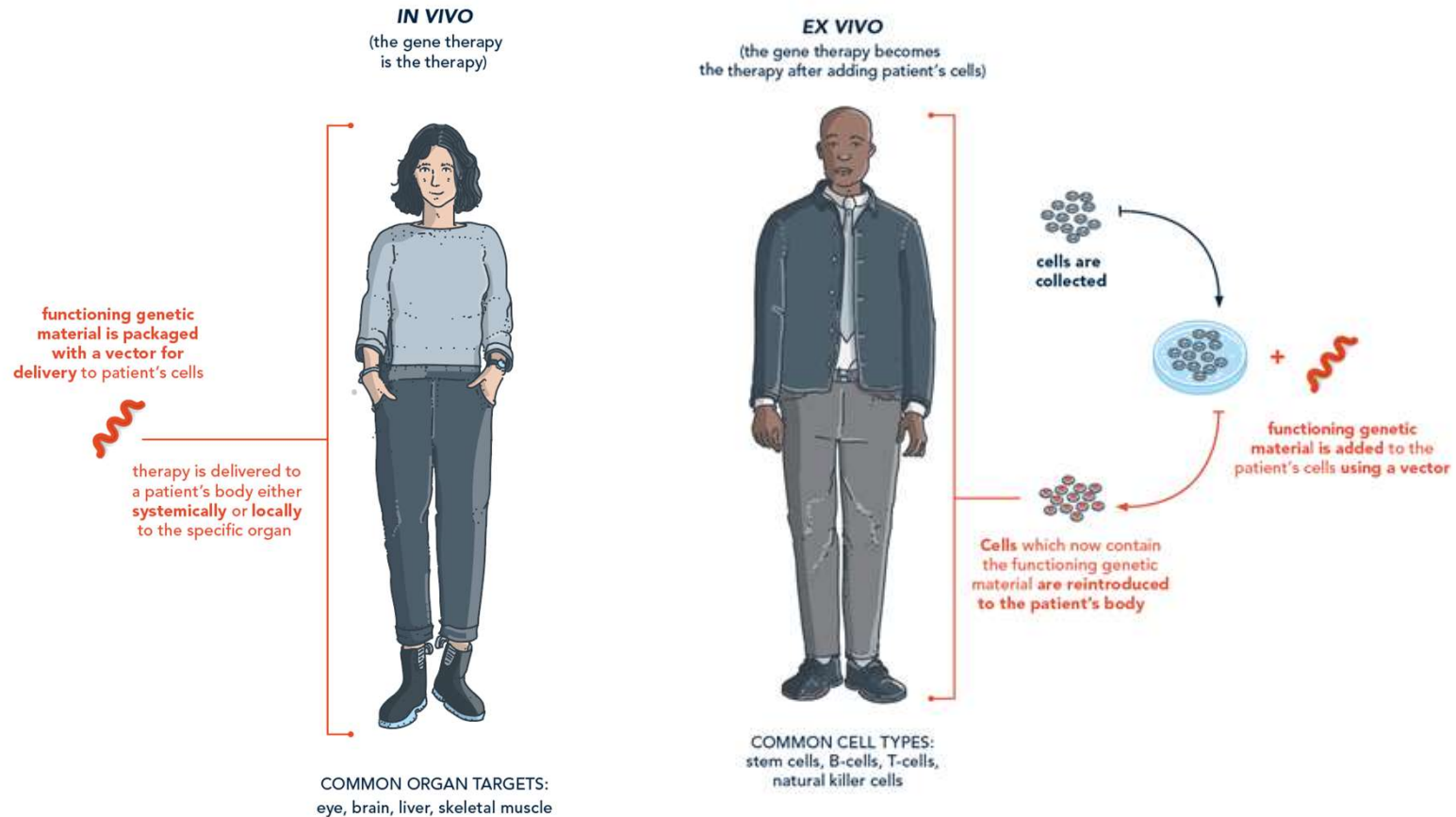

Road Map of Gene therapy

- **In vivo delivery**
- *In vivo* gene therapy refers to **direct delivery of genetic material either intravenously** (through an intravenous) or **locally** to a specific organ (eg, directly into the eye).
- *In vivo* gene therapy works through the **help of a vector**, which directly inserts functional copies of a gene into target cells to treat a mutated or missing gene.
- *In vivo* delivery of gene therapy has been proven in many areas of research. Some of the currently approved gene therapies deliver genetic material *in vivo*. Targeted *in vivo* gene therapy will continue to evolve as scientists continue to refine methods of gene delivery.

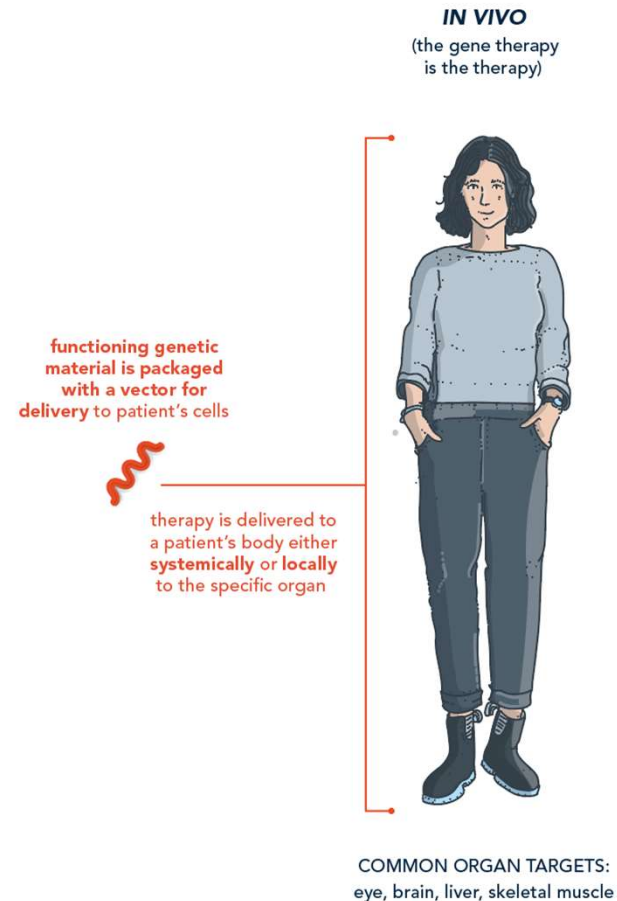

Road Map of Gene therapy

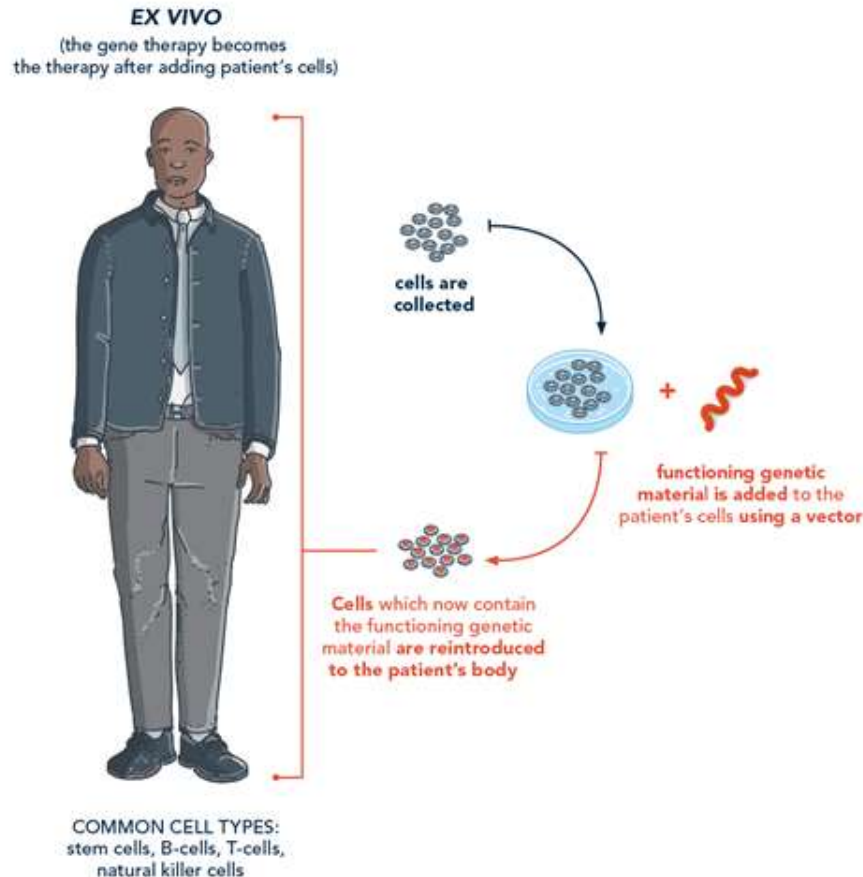

- Ex vivo delivery
- *Ex vivo* gene therapy refers to the process of removing specific cells from a person, genetically altering them in a laboratory, and then transplanting them back into the person.
- *Ex vivo* gene therapy works by genetically modifying a patient's stem cells, which then replace target cells that have a missing or malfunctioning gene.
- Today, *ex vivo* gene therapy is most frequently applied to hematopoietic stem cells (HSCs); this is used to treat blood and immunological diseases as well as genetic diseases that affect tissues and organs that can be reached by blood cells.

Induced pluripotent stem cells – iPSC

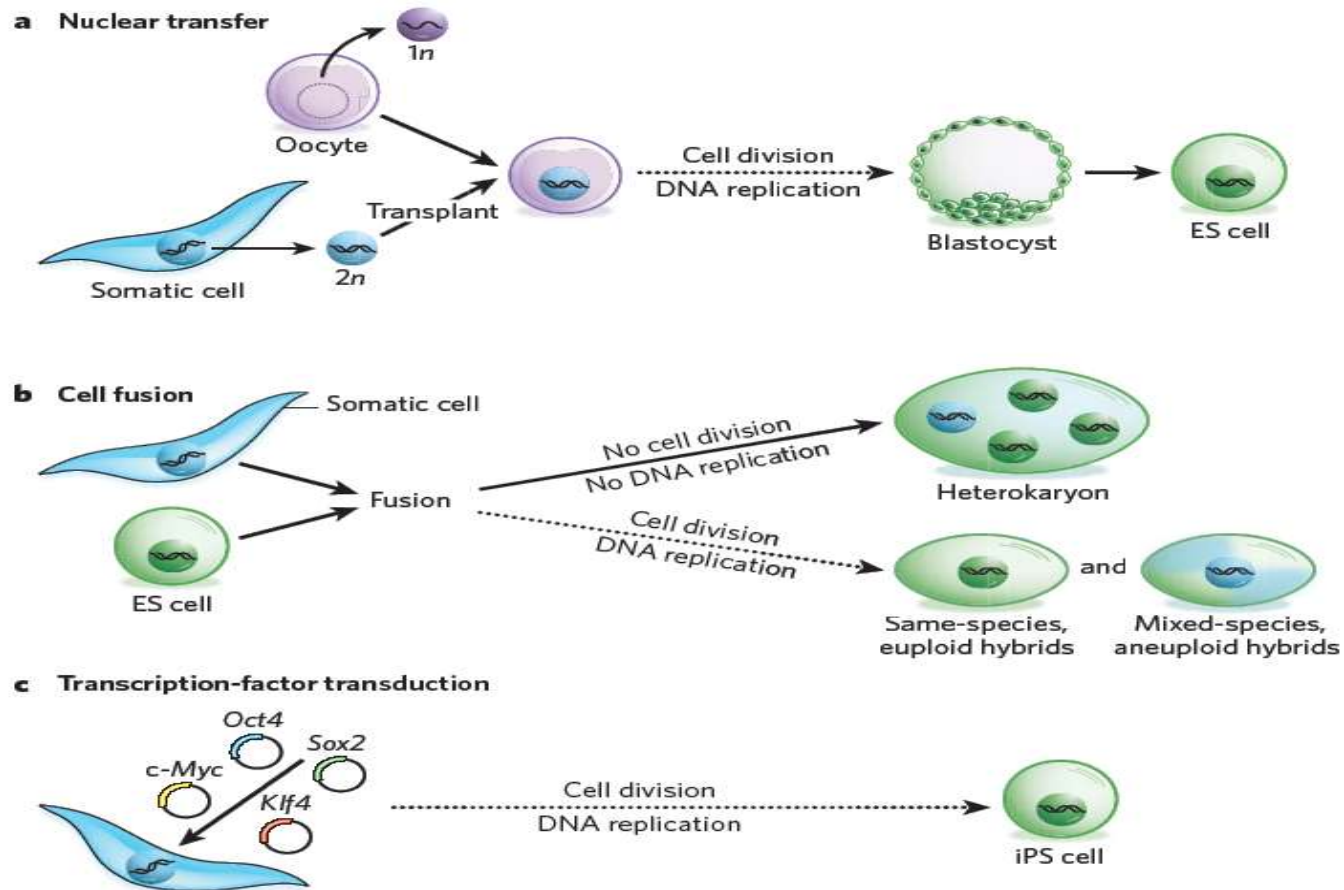

Induced pluripotent stem cells – iPSC

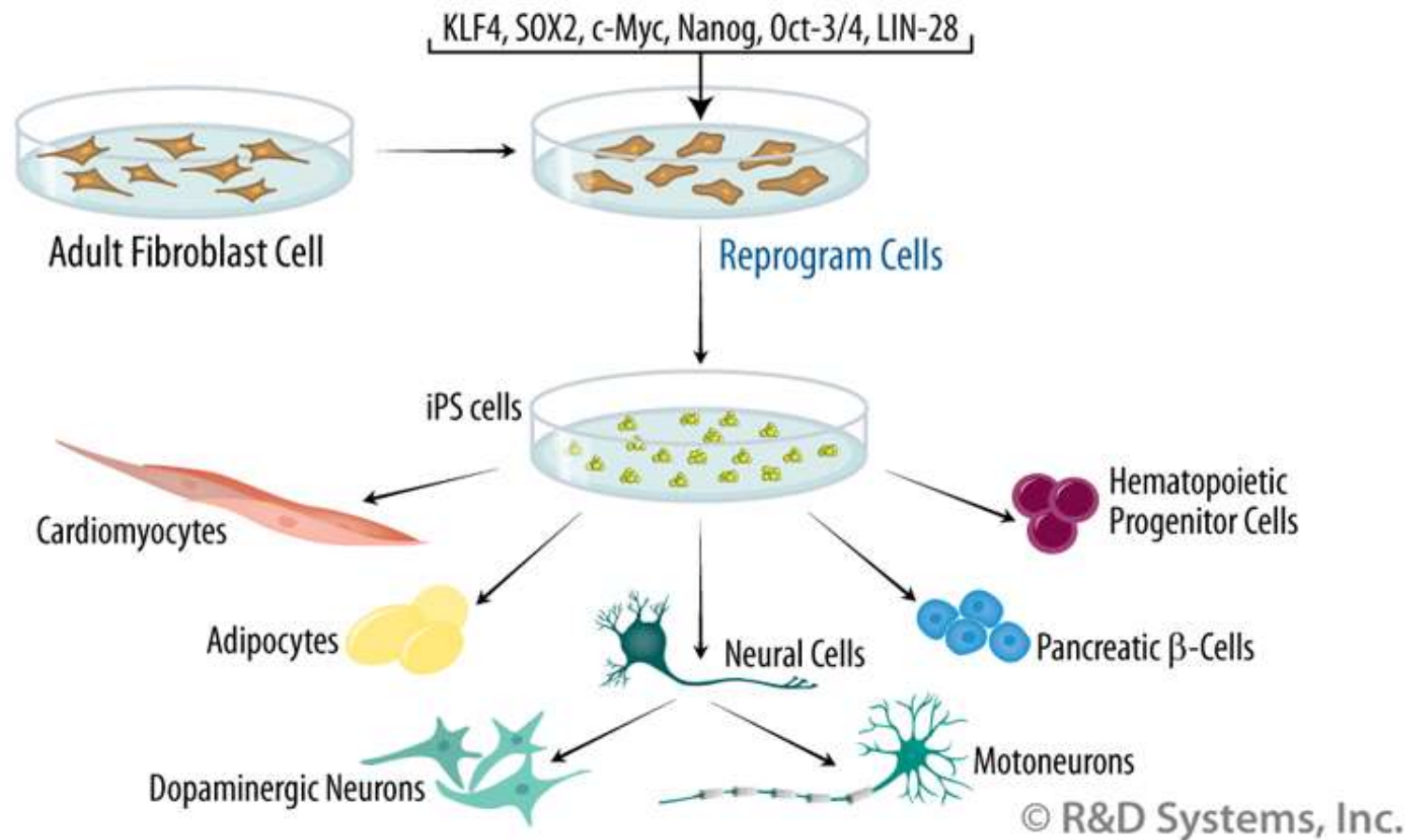

Gene therapy – delivery

- Direct Delivery
- The therapeutic gene is transferred directly to target cells in the body.
- Cell-Based
- Cells are extracted from the patient, modified with the therapeutic gene, and injected back into the patient.

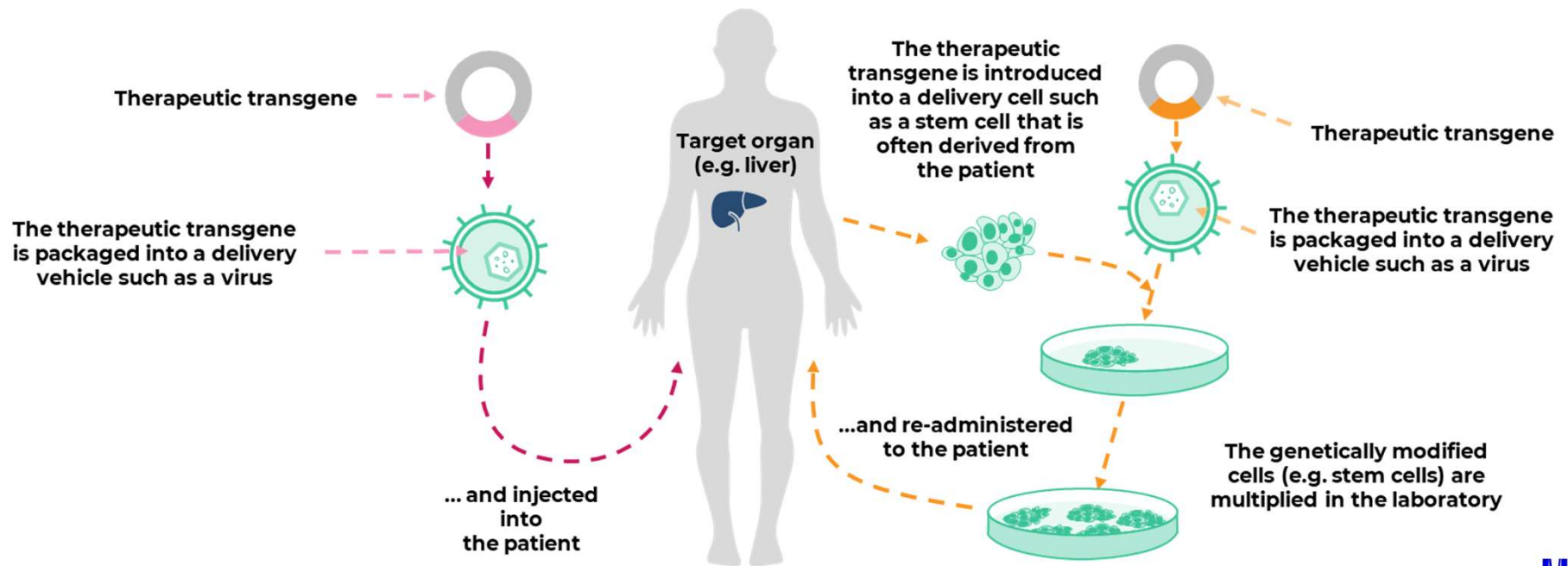

Gene therapy – Approach I

- Gene Replacement Therapy
- For monogenic diseases; involves replacing a mutated gene that causes disease with a healthy gene.

- Gene Addition
- For complex and infectious diseases; introduces a new gene into the body to help fight a disease, often to supplement a targeted therapeutic agent.

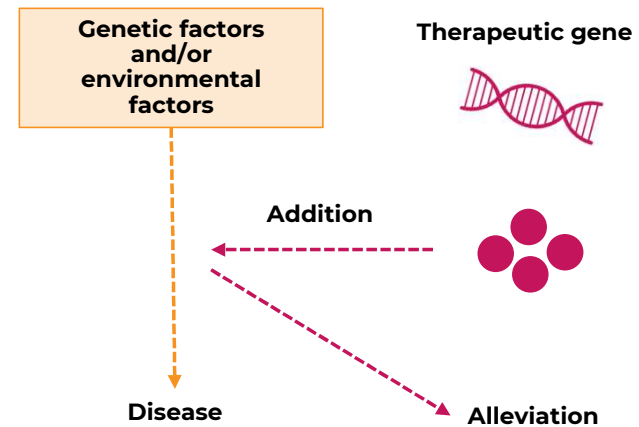
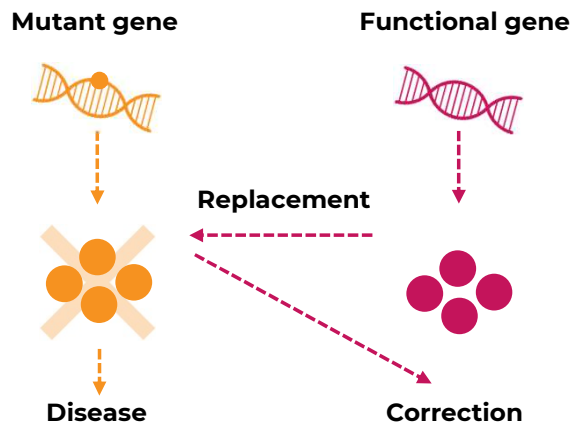

Gene therapy – Approach II

- Gene Inhibition or “Knockdown”
- Inactivating a mutated gene that is over-producing its product by targeting RNA.

- Gene Editing
- Making a targeted change to the gene sequence.

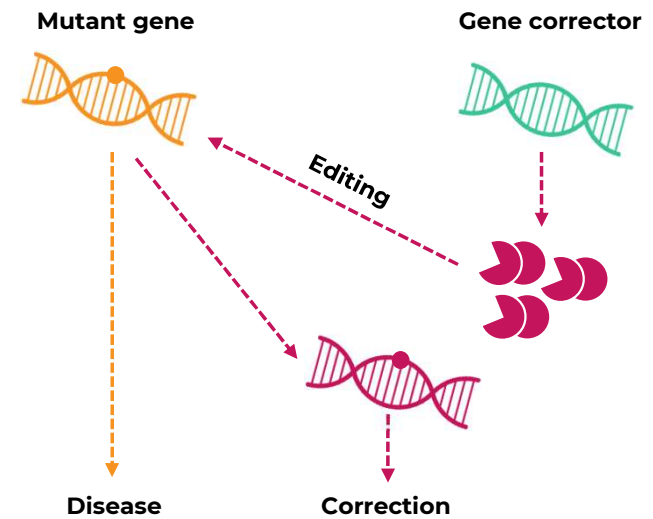
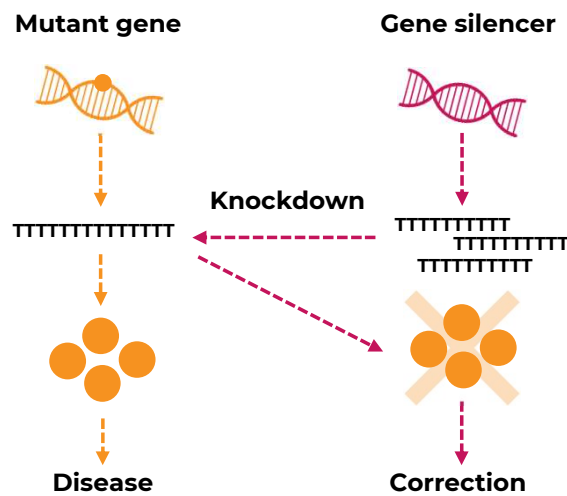

Current approaches of advanced therapies of 2023

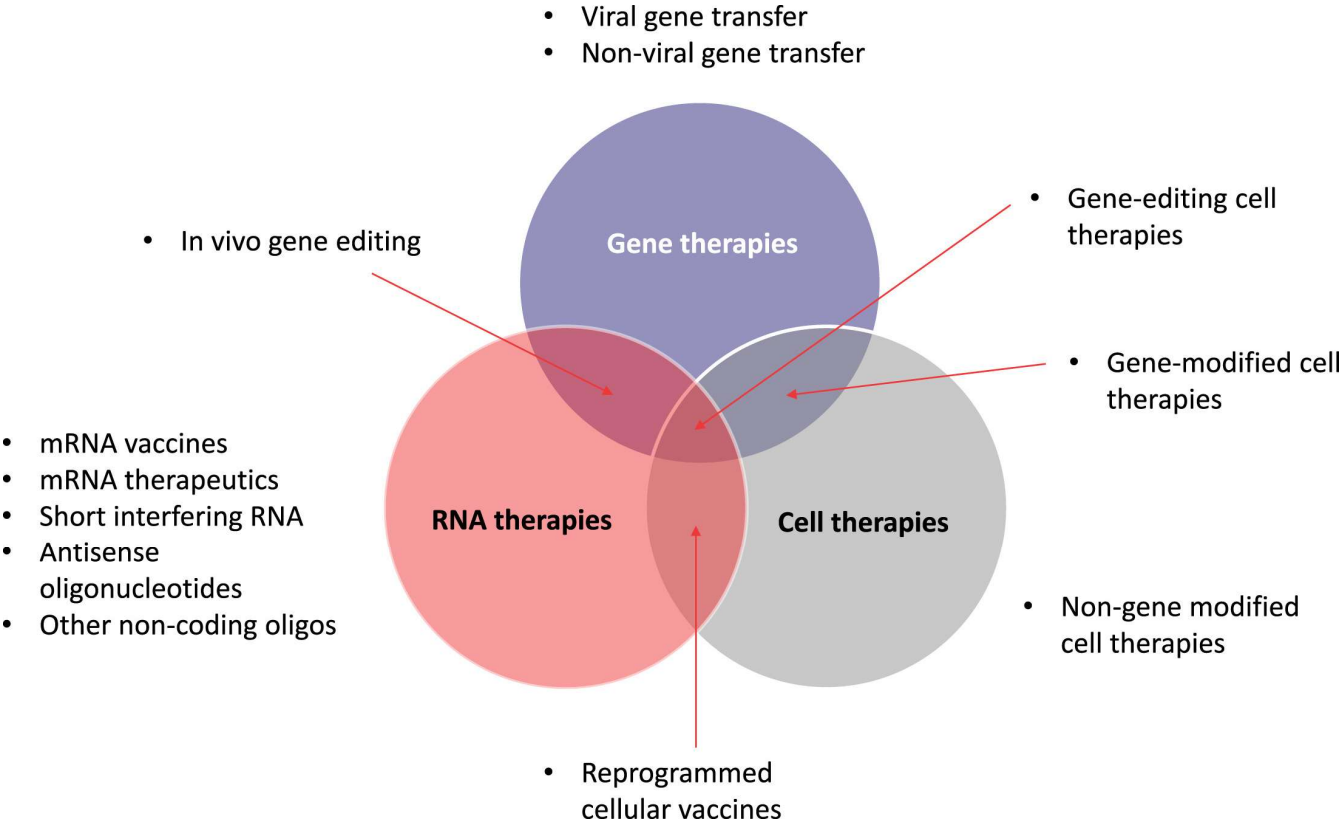

• In 2023 there were more than 100 different approved gene, cell, and RNA therapies throughout the world, with over 3,700 more in clinical and preclinical development.

Gene replacement therapy

- The aim of Gene Replacement Therapy - GRT - is to provide sufficient gene expression in enough targeted cells to ameliorate or correct dysfunctional phenotype.
- **Suitable for:**
 - Recessive disorders, single gene mutations, and X-linked diseases.
- **Generally unsuitable for:**
 - Dominant disorders where an errant gene codes for destructive or interfering proteins.
- **Gene therapy:**
 - Either directly *in vivo* or through *ex vivo* cell therapy.
 - Vehicle/vector used to deliver therapeutic transgene.

Gene therapy – viral vectors

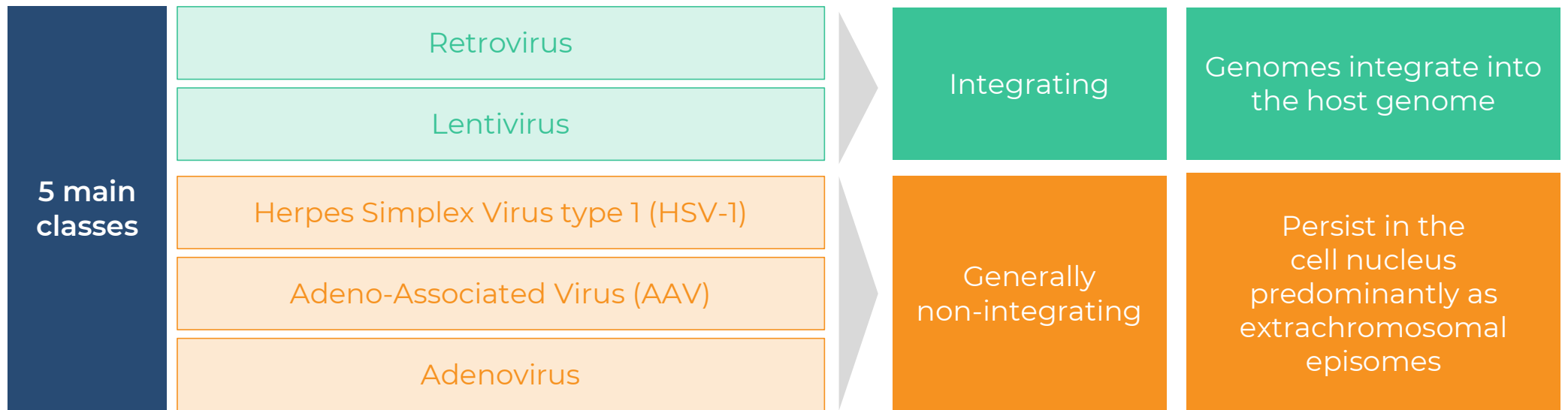

Gene targeted therapy – in vivo approach

- Three key components:
- the **vector**, or vehicle, which is injected into the patient and by which a transgene is delivered to the targeted cells
- the **transgene**, which is a sequence of complementary DNA (cDNA) coding the replacement gene
- the **promoter**, which is the DNA sequence that acts as a “turn on” switch and modulates the expression of the transgene.
- Also typically includes, either:
- A **termination signal** to end gene transcription.
- **Inverted terminal repeats** (ITRs) at either end of the cassette to allow for synthesis of complementary DNA.

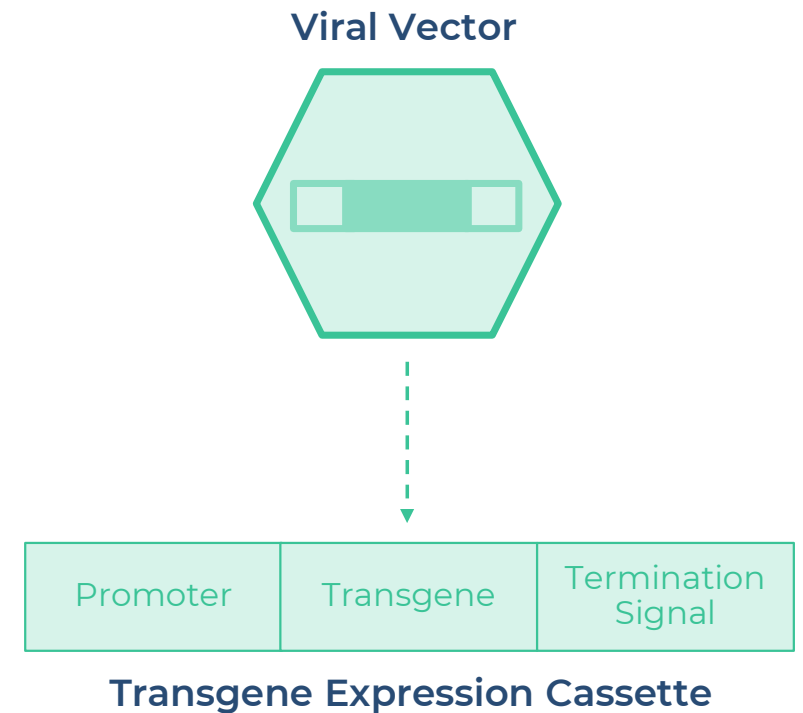

Gene targeted therapy – AAV

- **Adeno-associated virus** – AAV is a member of the *parvovirus* family of single-stranded small DNA viruses.
- **Requires a helper virus** such as adenovirus or herpes simplex virus for replication¹
- Considered a Risk Group 1 microorganism – infection with AAV is not associated with disease in humans.
- Has several serotypes that impact tropism (susceptible tissues), but all appear to be nonpathogenic.
- rAAV - based vectors used in GRT have wild-type viral genes removed and typically exist as extrachromosomal episomes.
- AAV can efficiently **infect both non-dividing and dividing cells**.
- AAV is typically transmitted by **respiratory** and **gastrointestinal** routes.

Gene targeted therapy – AAV

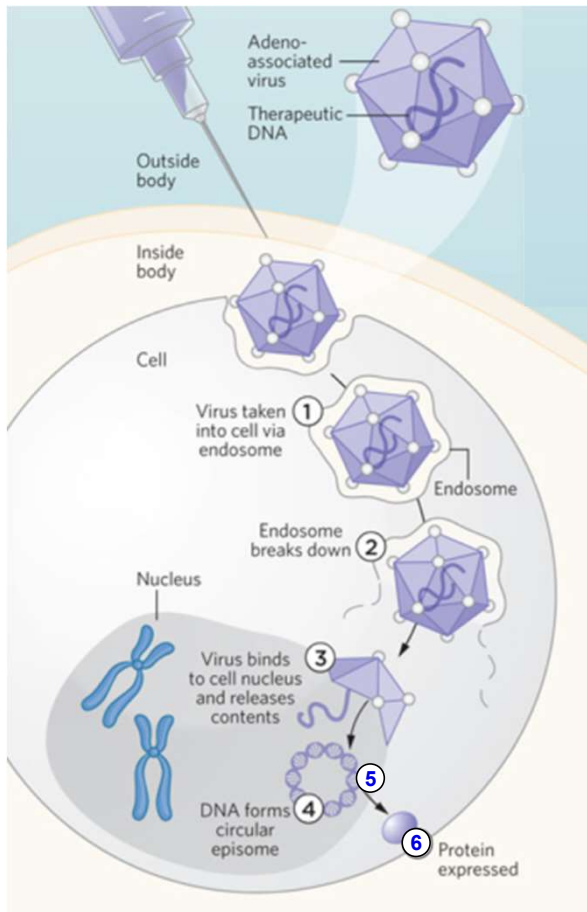

- AAVs deliver genes without integrating them into the genome:
- 1) Virus is taken into the cell via the endosome.
- 2) The endosome breaks down.
- 3) Therapeutic DNA enters cell nucleus as a double-stranded molecule ready for transcription.
- 4) Therapeutic DNA forms a circular episome.
- 5) Upon promoter activation, transcription occurs.
- 6) The resulting transcript leaves the nucleus and travels to the ribosome for translation (protein synthesis).

Gene targeted therapy – - AAV production overview

- The AAV production process is complex and sophisticated.

1. Transgene Development 2. AAV GRT Production 3. Concentration & Purification
4. Quality Assurance

- cDNA is reverse transcribed from human mRNA (no introns).

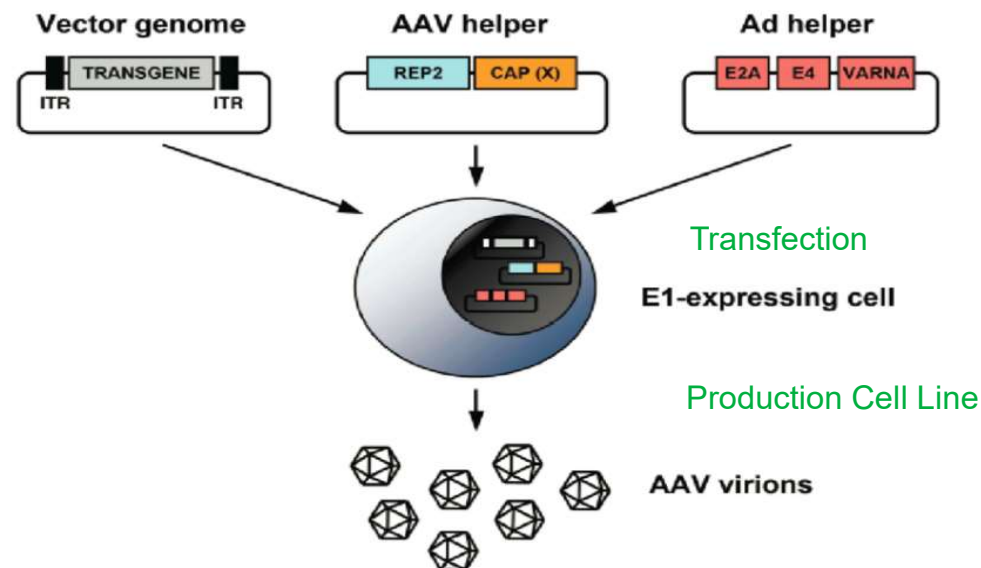

Gene therapy – history of delivery vectors

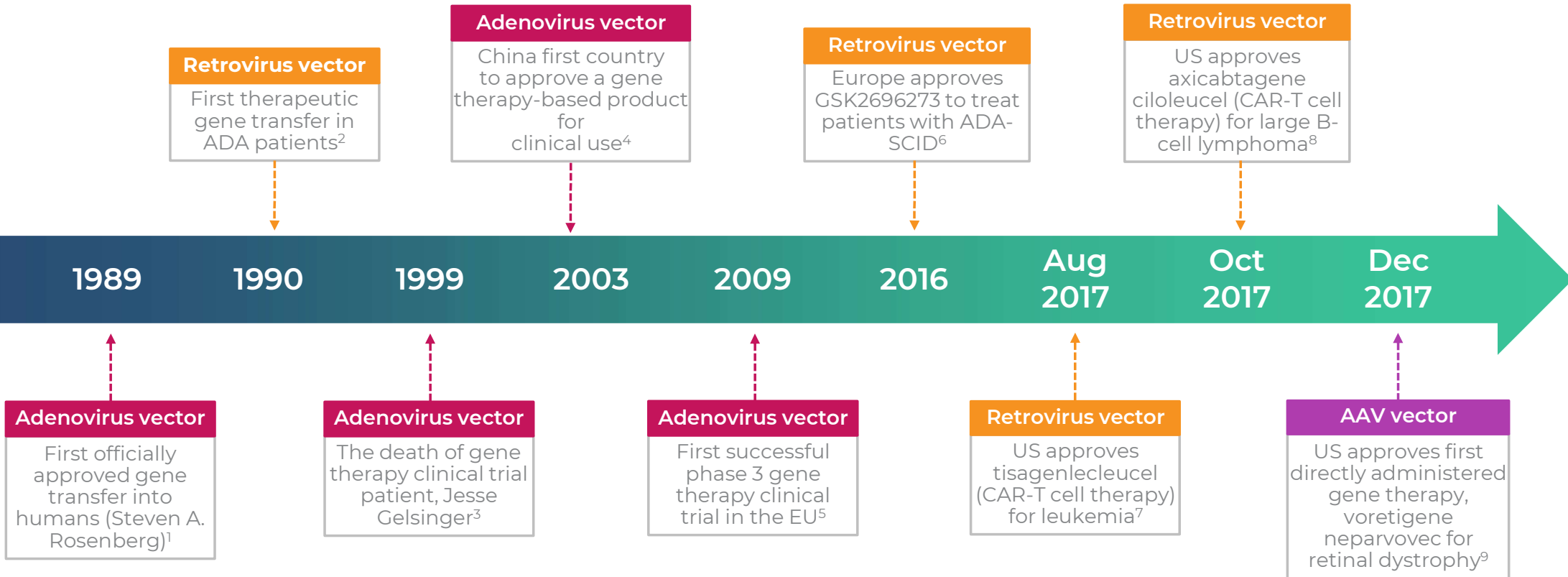

Gene therapy - Approved genes therapies

FDA-approved therapy	Indication (approval date)	Delivery	Viral vector
Imlygic (talimogene laherparepvec)	Melanoma (2015)	<i>In vivo</i>	HSV-1
Kymriah (tisagenlecleucel)	B-cell precursor acute lymphoblastic leukemia (2017); diffuse large B-cell lymphoma (2018)	<i>Ex vivo</i>	Lentivirus
Yescarta (axicabtagene ciloleucel)	Large B-cell lymphoma (2017)	<i>Ex vivo</i>	Retrovirus
Luxturna (voretigene neparvovec-rzyl)	Biallelic RPE65 mutation-associated retinal dystrophy (2017)	<i>In vivo</i>	AAV
EMA-approved therapy	Indication (approval date)		
Imlygic	Melanoma (2015)	<i>In vivo</i>	HSV-1
Strimvelis	ADA-SCID (2016)	<i>Ex vivo</i>	Retrovirus
Zalmoxis	Adjunctive treatment in HSCT in high-risk blood cancer (2016)	<i>Ex vivo</i>	Retrovirus

THANK YOU FOR YOUR ATTENTION



GENE THERAPY