

MUNI
SCI

Bi4025en

Molecular Biology

Mgr. Jiří Kohoutek, Ph.D.

Lecture 2

- Nucleic acids: primary, secondary and tertiary structure of nucleic acids, conformation of DNA and RNA, different conformations of DNA and their significance for biological systems, genetic information and genetic code.

Hunt for the structure of DNA

- Watson and Crick restricted themselves to what they saw as chemically and biologically reasonable in terms of DNA structure.
- A breakthrough occurred in 1952, when **Erwin Chargaff** visited Cambridge and inspired Crick with a description of experiments, he had published in 1947.
- Chargaff had observed that the proportions of the four nucleotides vary between one DNA sample and the next, but that for particular pairs of nucleotides

- adenine and thymine

- guanine and cytosine

- the two nucleotides are always present **in equal proportions**.

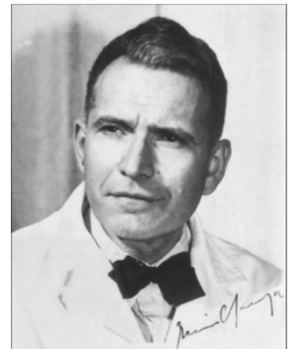
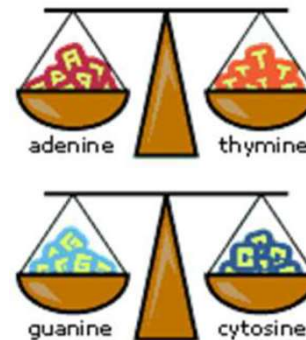

Discovery of DNA structure

- 1953: James Watson and Francis Crick derived the structure of DNA based on the following data:
- Chemical data: Erwin Chargaff principles:
 - the concentration of thymine and adenine is the same
 - the concentration of cytosine and guanine is the same.
- Physical data: Maurice Wilkins and Rosalind Franklin after exposure of purified DNA molecules to X-rays, there is a characteristic scattering of rays that signal method of arranging DNA components into a helix.



Structure of DNA

Levene's tetranucleotide theories

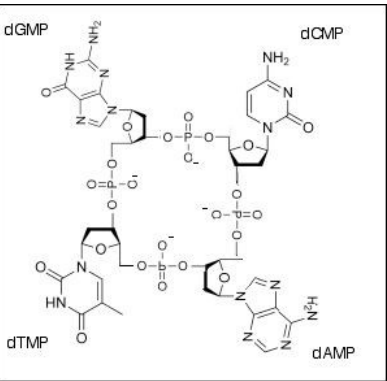

- Features of the proposed DNA structure allow:
 - **encoding** genetic information in the form of **ordered bases** (denial of Levene's tetranucleotide theories)
 - **replication** of DNA molecule is based on complementary pairing of bases.

DNA molecule

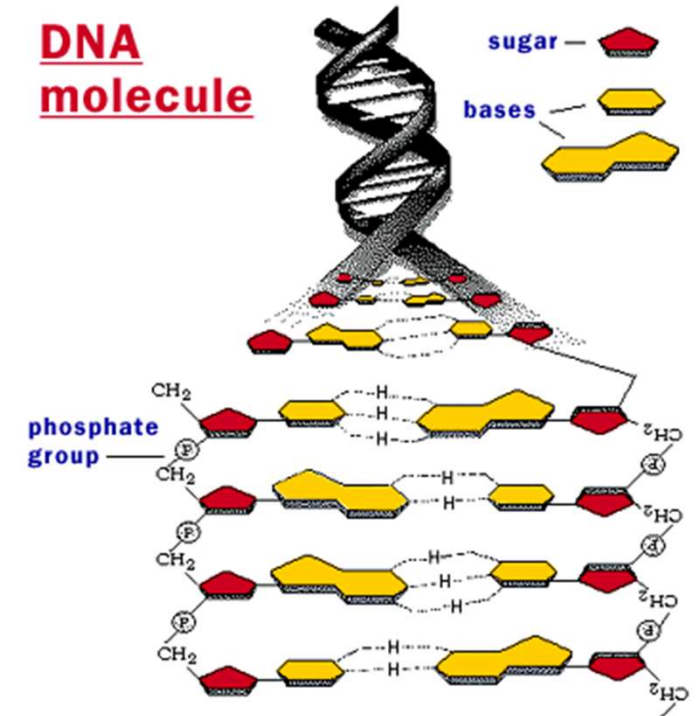

Structure of DNA

- Chemical properties of bases:
- Spontaneous **mutation** of DNA bases can also occur by **tautomerization**:

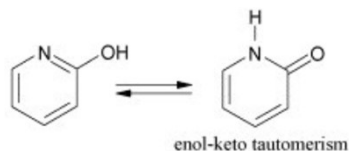

○ enol / keto

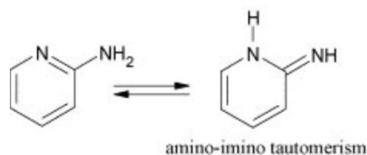

○ amino / imino

- Tautomerization is a net process by which protons are transferred from one site to another by a series of steps in which the solvent is an intermediary.

(A) Standard base pairing arrangements

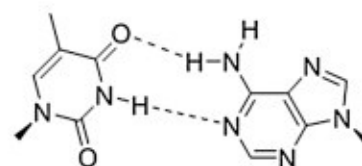

Thymine (keto) Adenine (amino)

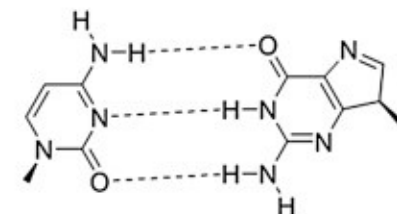

Cytosine (amino) Guanine (keto)

(B) Anomalous base pairing arrangements

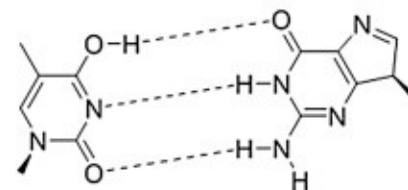

Thymine (enol) Guanine (keto)

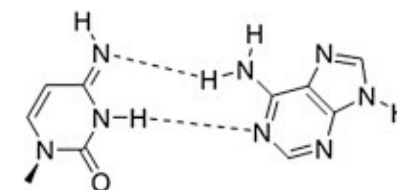

Cytosine (imino) Adenine (amino)

Types of Nucleic acids – DNA

- DNA forms the genome of prokaryotes, eukaryotes and DNA-viruses.
- gDNA – genomic, mtDNA - mitochondrial, cpDNA –chloroplast, pDNA - plasmid, recDNA - recombinant, rDNA -ribosomal, aDNA – ancient.
- cDNA (copy DNA, complementary DNA).
- dsDNA – double-stranded , ssDNA – single-stranded, cccDNA – covalently closed circular, ocDNA - open circle, linDNA – linear.
- A-DNA, B-DNA, Z-DNA - conformation influenced by sequence and environment.
- Special forms of DNA – C-DNA, D-DNA and E-DNA.

Types of Nucleic acids – RNA

- RNA - forms the genome of RNA-viruses, in cellular organisms it is a component of ribosomes and perform various functions in the transmission and realization of genetic information.
- mRNA - mediator, hnRNA - heteronuclear, tRNA - transfer, rRNA -ribosomal, tmRNA – transfer-messenger RNA
- snRNA – small-nuclear, snoRNA - small nucleolar, scRNA - small cytoplasmic, gRNA - guide, crRNA – CRISPR RNA
- miRNA, siRNA, shRNA, piRNA
- ribozyme: an RNA molecule capable of acting as an enzyme
 - RNA splicing cleavage (or ligation) of RNA and DNA
 - Ribosome – peptide bond formation
 - Viral replication

Nucleotide

Nucleotides

- phosphatic acid (**PHOPHATE**)
- pentose (**SUGAR**)
 - ribose
 - deoxyribose
- organic base (**BASE**)
 - *purine base*
 - adenine
 - guanine
 - *pyrimidine base*
 - cytosine
 - thymine
 - uracil

NUCLEOTIDES

A nucleotide consists of a nitrogen-containing base, a five-carbon sugar, and one or more phosphate groups.

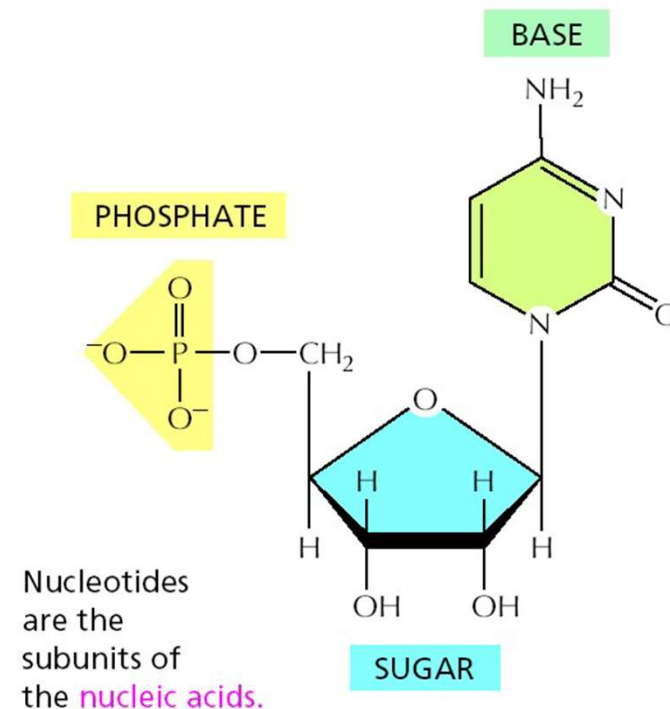

Sugar - Pentose in Nucleic acids

Sugar – Pentose

- **ribose** in ribonucleic acids (**RNA**)
- **deoxyribose** in deoxyribonucleic acid (**DNA**)
- the difference is in the **presence** or **absence** of hydroxyl groups on 2'-carbon.

SUGARS

PENTOSE
a five-carbon sugar

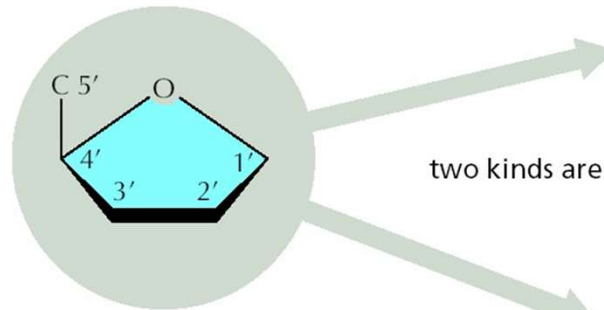

two kinds are used

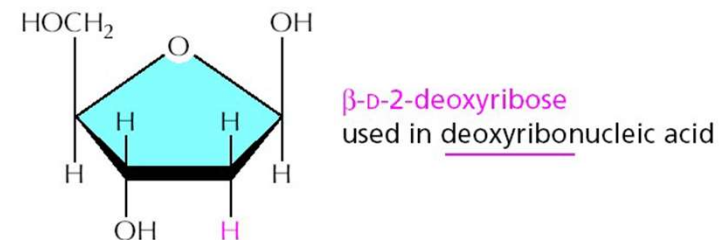
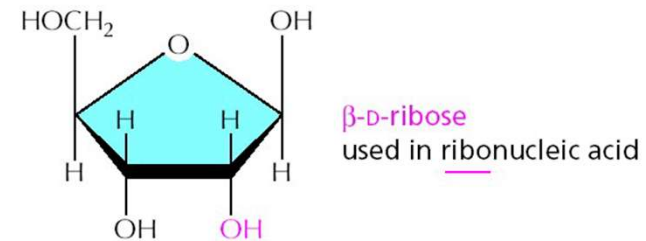

Each numbered carbon on the sugar of a nucleotide is followed by a prime mark; therefore, one speaks of the "5-prime carbon," etc.

β -N-glycosidic bond in Nucleic acids

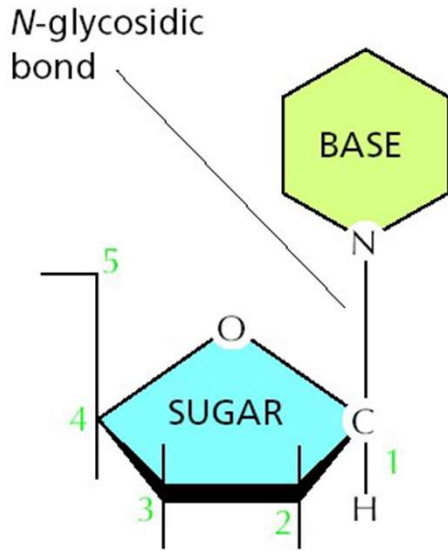

The base is linked to the same carbon (C1) used in sugar-sugar bonds.

Sugar – Pentose

- bases are attaching to sugar by β -N-glycosidic bond which is a nitrogen-carbon linkage between the 1' nitrogen of pyrimidine bases or 9' nitrogen of purines bases and the 1' carbon of the sugar group.

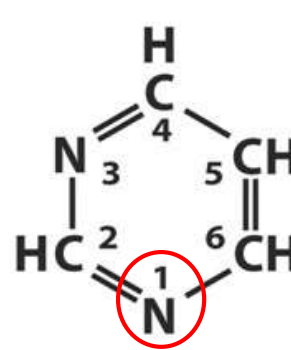

Pyrimidine

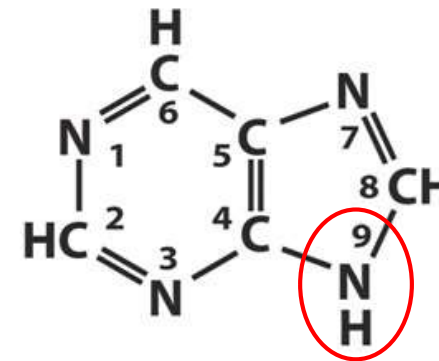

Purine

Pyrimidine and Purine bases in Nucleic acids

Bases

- **pyrimidine** (cytosine, thymine, uracil)

Bases

- **purine** (adenine, guanine)

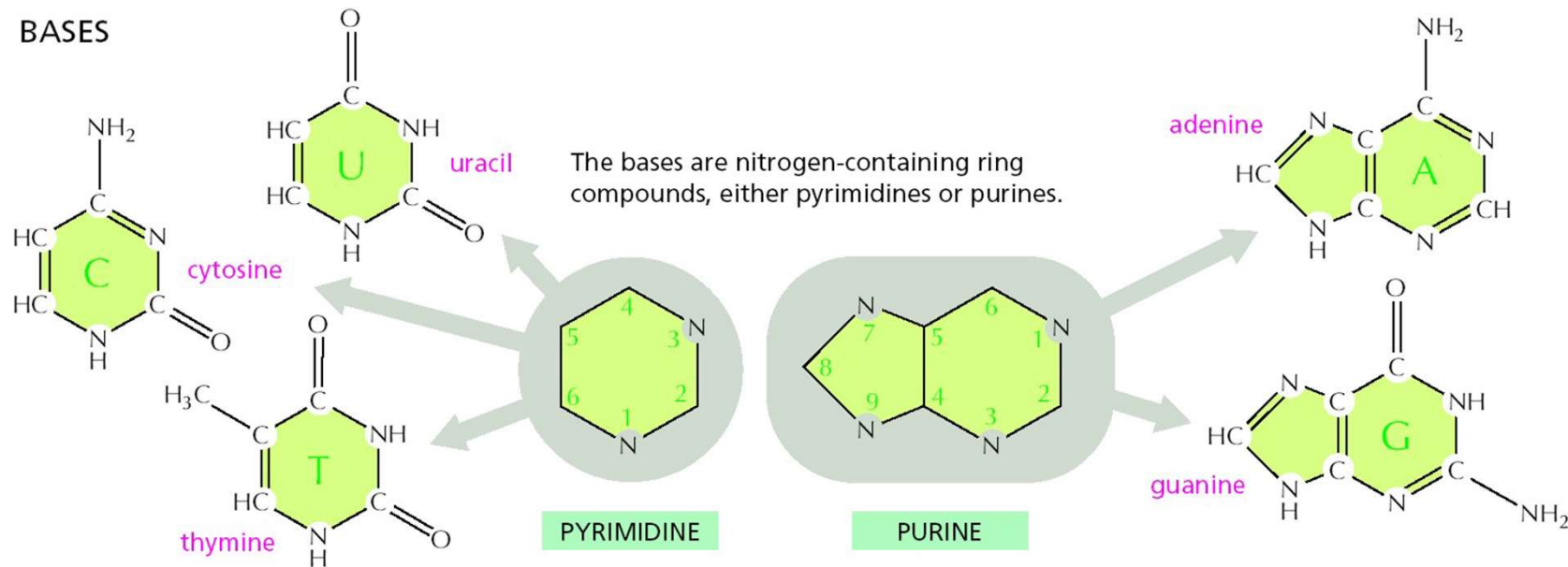

Phosphates in Nucleic acids

PHOSPHATES

The phosphates are normally joined to the C5 hydroxyl of the ribose or deoxyribose sugar (designated 5'). Mono-, di-, and triphosphates are common.

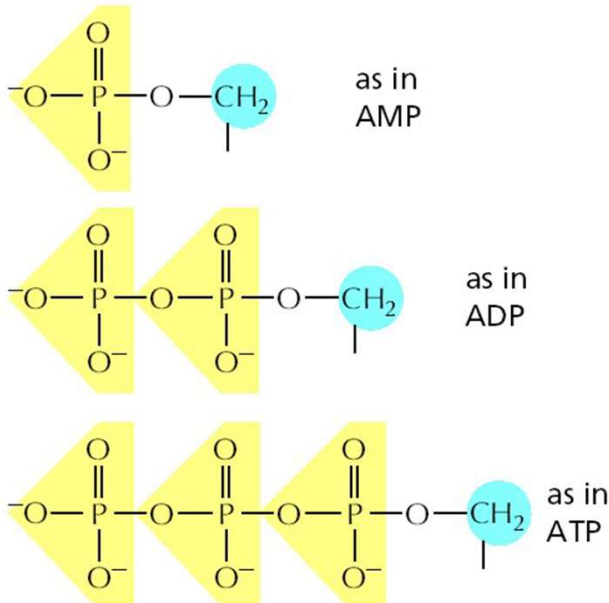

The phosphate makes a nucleotide negatively charged.

Phosphates

- attached to 5' sugar carbon by **ester bond**,
- provides the nucleotides with negative charge.

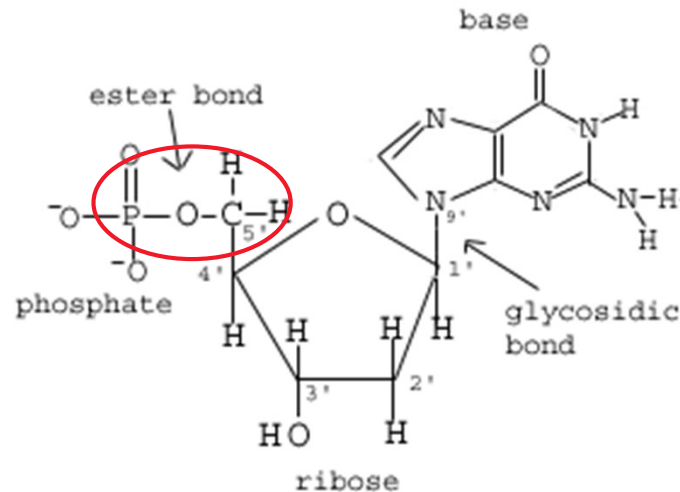

<https://www.sparknotes.com/biology/molecular/structureofnucleicacids/section1/>
Alberts et al.: Molecular biology of the cell. Garland Sci. 2008, 2015

Phosphates in Nucleic acids

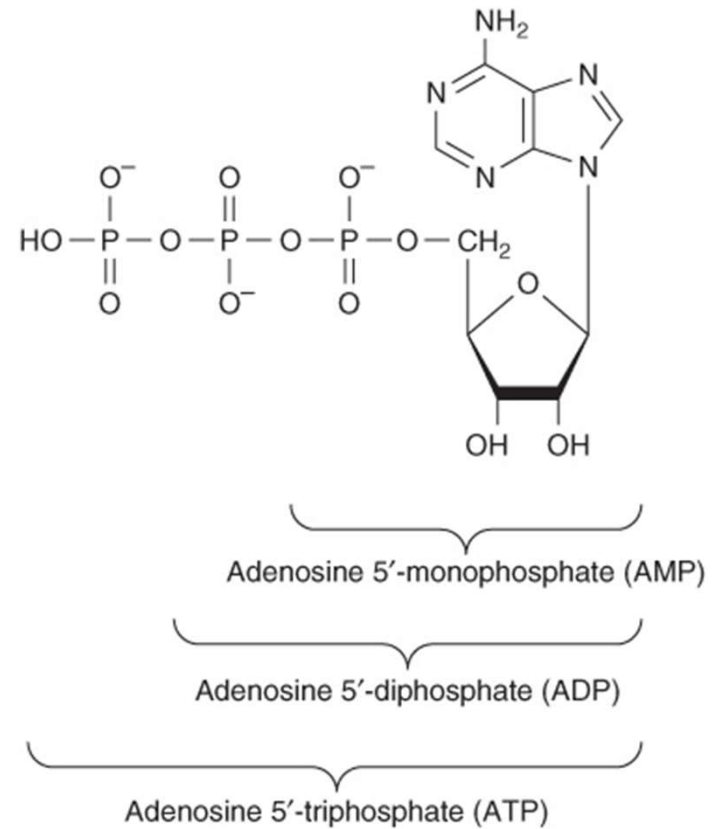
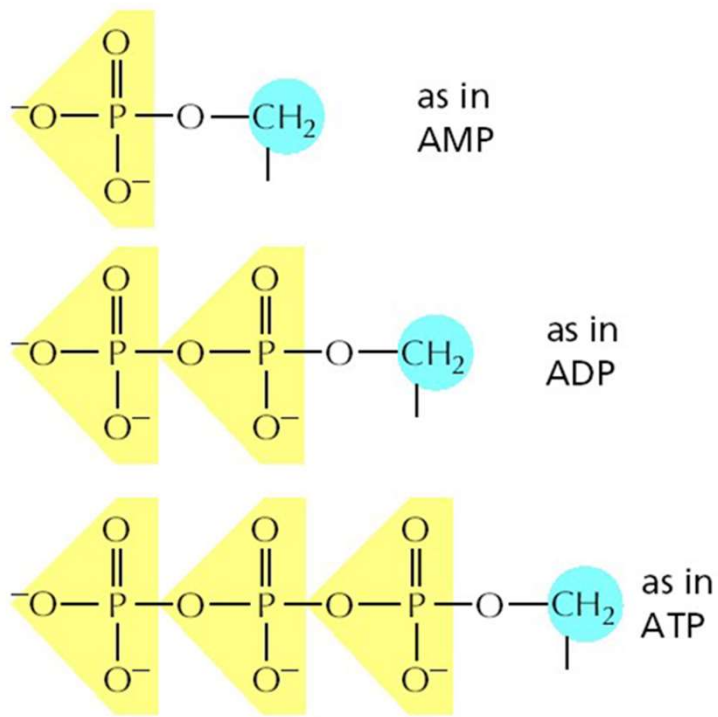

Nucleosides and Nucleotides in Nucleic acids

- Nucleotides are phosphorylated Nucleosides.

NOMENCLATURE

A nucleoside or nucleotide is named according to its nitrogenous base.

BASE	NUCLEOSIDE	ABBR.
adenine	adenosine	A
guanine	guanosine	G
cytosine	cytidine	C
uracil	uridine	U
thymine	thymidine	T

Single letter abbreviations are used variously as shorthand for (1) the base alone, (2) the nucleoside, or (3) the whole nucleotide—the context will usually make clear which of the three entities is meant. When the context is not sufficient, we will add the terms “base”, “nucleoside”, “nucleotide”, or—as in the examples below—use the full 3-letter nucleotide code.

AMP = adenosine monophosphate
 dAMP = deoxyadenosine monophosphate
 UDP = uridine diphosphate
 ATP = adenosine triphosphate

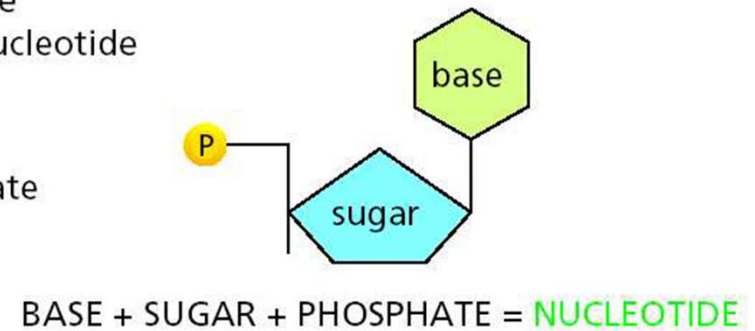
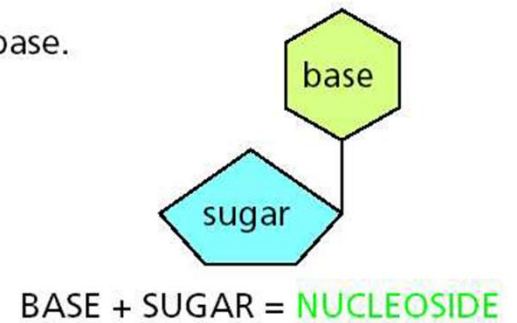

Nucleosides and Nucleotides in Nucleic acids

TABLE 8-1		Nucleotide and Nucleic Acid Nomenclature	
Base	Nucleoside	Nucleotide	Nucleic acid
Purines			
Adenine	Adenosine	Adenylate	RNA
	Deoxyadenosine	Deoxyadenylate	DNA
Guanine	Guanosine	Guanylate	RNA
	Deoxyguanosine	Deoxyguanylate	DNA
Pyrimidines			
Cytosine	Cytidine	Cytidylate	RNA
	Deoxycytidine	Deoxycytidylate	DNA
Thymine	Thymidine or deoxythymidine	Thymidylate or deoxythymidylate	DNA
Uracil	Uridine	Uridylate	RNA

Note: "Nucleoside" and "nucleotide" are generic terms that include both ribo- and deoxyribo- forms. Also, ribonucleosides and ribonucleotides are here designated simply as nucleosides and nucleotides (e.g., riboadenosine as adenosine), and deoxyribonucleosides and deoxyribonucleotides as deoxynucleosides and deoxynucleotides (e.g., deoxyriboadenosine as deoxyadenosine). Both forms of naming are acceptable, but the shortened names are more commonly used. Thymine is an exception; "ribothymidine" is used to describe its unusual occurrence in RNA.

Table 8-1

Lehninger Principles of Biochemistry, Fifth Edition

© 2008 W. H. Freeman and Company

Deoxyribonucleotides

- Nucleotide is composed of a base (adenine, guanine, cytosine, thymine) attached to a sugar (deoxyribose) to form a **nucleoside**.
- The nucleoside with an attached phosphate group makes it **nucleotide**.
- The name of the nucleoside containing the base adenine is deoxyadenosine and if the phosphate group is attached at the carbon numbered 5' (five prime) then the formal name of the nucleotide is 2'-deoxyadenosine 5'-monophosphate (dAMP).

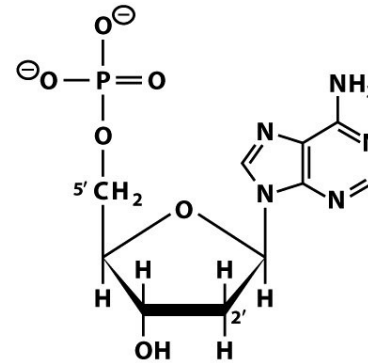

2'-Deoxyadenosine 5'-monophosphate
(Deoxyadenylate, dAMP)

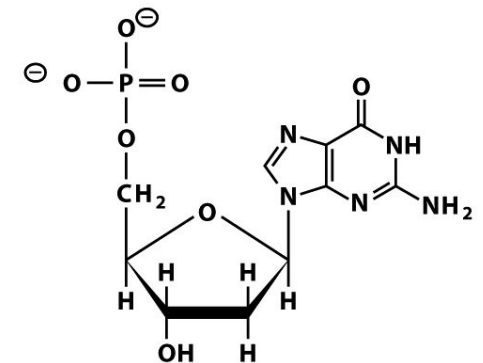

2'-Deoxyguanosine 5'-monophosphate
(Deoxyguanylate, dGMP)

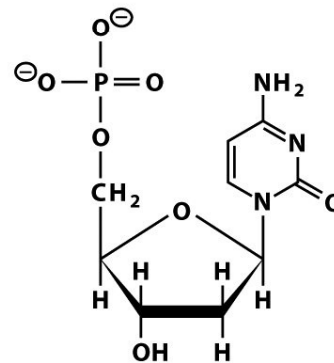

2'-Deoxycytidine 5'-monophosphate
(Deoxycytidylate, dCMP)

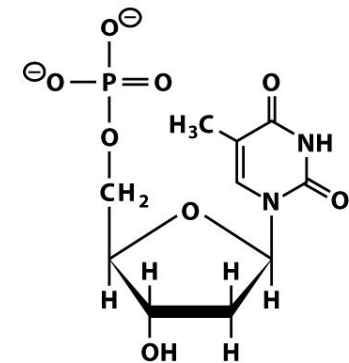

2'-Deoxythymidine 5'-monophosphate
(Thymidylate, dTMP)

Figure 19-9 Principles of Biochemistry, 4/e
© 2006 Pearson Prentice Hall, Inc.

Molecule DNA – synthesis

- **Phosphodiester bonds** form between the phosphate group attached to the 5' carbon of one nucleotide and the hydroxyl group of the 3' carbon in the next nucleotide.
- Regular alternation of the sugar-phosphate-sugar-phosphate motif forms the backbone of the polynucleotide: sugar-phosphate (pentose phosphate) backbone.
- Chains have chemical polarity: 1 end contains **phosphate** (5'-end), the other contains **hydroxyl** group (3'-end).
- **Elongation (synthesis) of polynucleotide chain** always runs in the direction 5' – 3'.

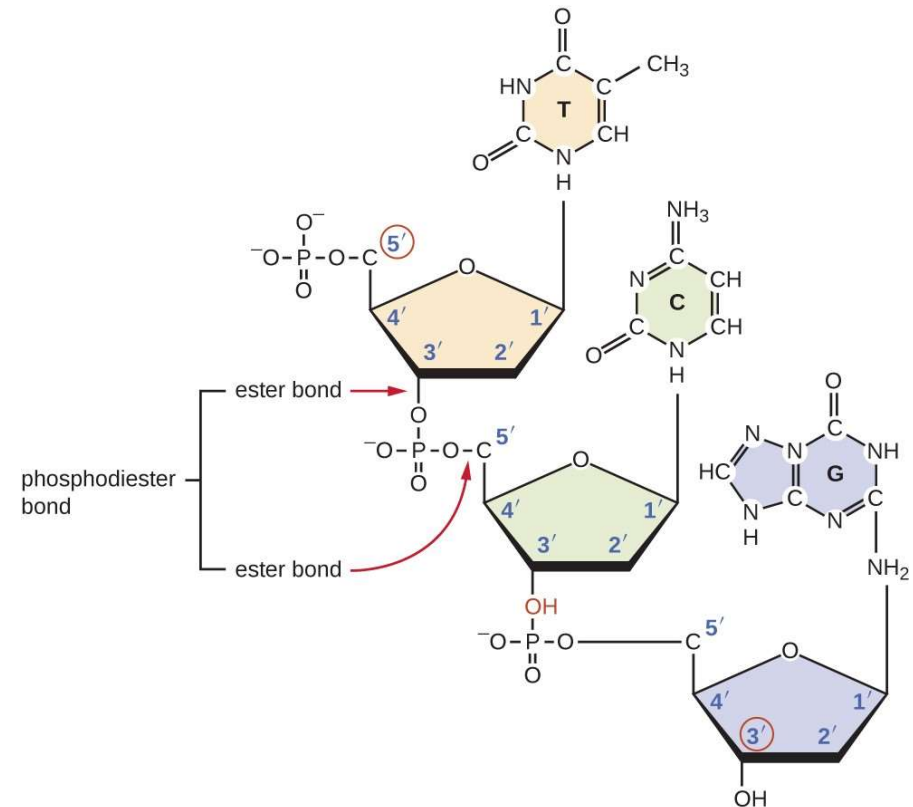

Two types of nucleic acid

- **DNA**
- usually double-stranded molecule
- Strands are bond by hydrogen bonds between base pairs
 - adenine - thymine
 - guanine - cytosine
- **RNA**
- usually single-stranded molecule
- instead of thymine there is uracil.

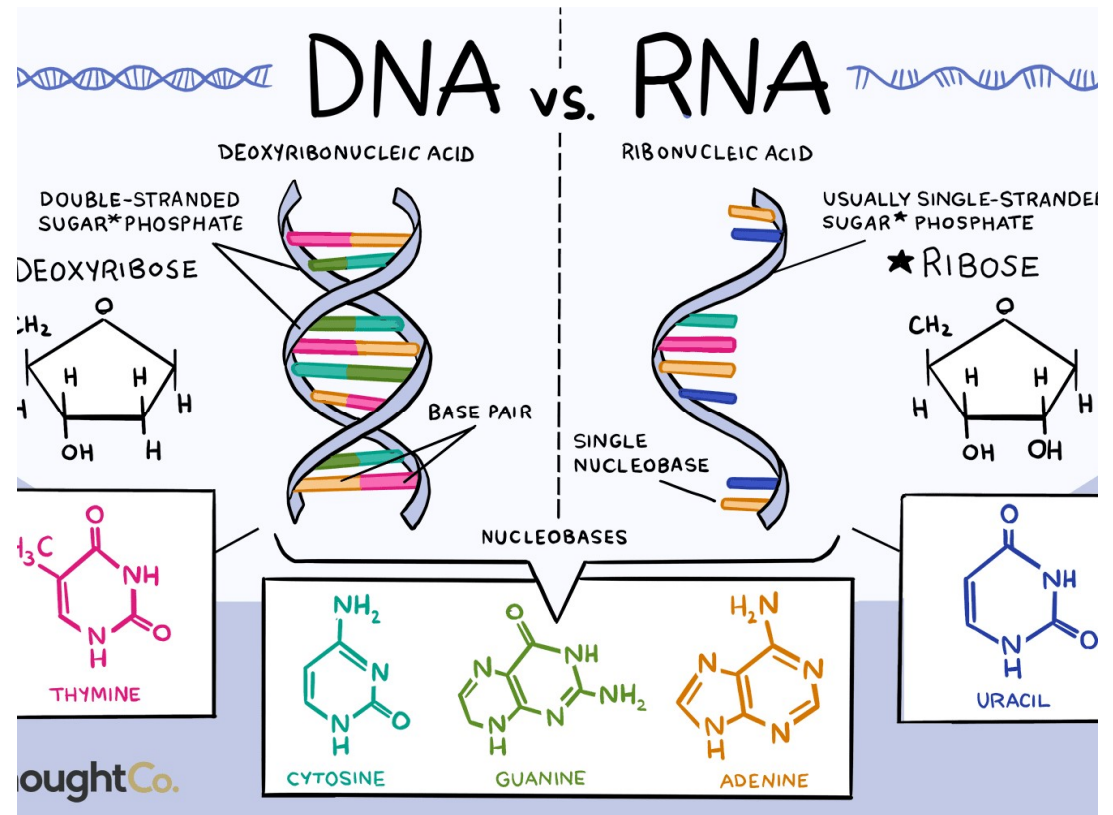

Differences between DNA and RNA

Comparison	DNA	RNA
Full Name	Deoxyribonucleic Acid	Ribonucleic Acid
Function	DNA replicates and stores genetic information. It is a blueprint for all genetic information contained within an organism.	RNA converts the genetic information contained within DNA to a format used to build proteins, and then moves it to ribosomal protein factories.
Structure	DNA consists of two strands, arranged in a double helix. These strands are made up of subunits called nucleotides. Each nucleotide contains a phosphate, a 5-carbon sugar molecule and a nitrogenous base.	RNA only has one strand, but like DNA, is made up of nucleotides. RNA strands are shorter than DNA strands. RNA sometimes forms a secondary double helix structure, but only intermittently.
Length	DNA is a much longer polymer than RNA. A chromosome, for example, is a single, long DNA molecule, which would be several centimetres in length when unravelled.	RNA molecules are variable in length, but much shorter than long DNA polymers. A large RNA molecule might only be a few thousand base pairs long.
Sugar	The sugar in DNA is deoxyribose, which contains one less hydroxyl group than RNA's ribose.	RNA contains ribose sugar molecules, without the hydroxyl modifications of deoxyribose.

Differences between DNA and RNA

Full Name	Deoxyribonucleic Acid	Ribonucleic Acid
Sugar	The sugar in DNA is deoxyribose, which contains one less hydroxyl group than RNA's ribose.	RNA contains ribose sugar molecules, without the hydroxyl modifications of deoxyribose.
Bases	The bases in DNA are Adenine ('A'), Thymine ('T'), Guanine ('G') and Cytosine ('C').	RNA shares Adenine ('A'), Guanine ('G') and Cytosine ('C') with DNA, but contains Uracil ('U') rather than Thymine.
Base Pairs	Adenine and Thymine pair (A-T) Cytosine and Guanine pair (C-G)	Adenine and Uracil pair (A-U) Cytosine and Guanine pair (C-G)
Location	DNA is found in the nucleus, with a small amount of DNA also present in mitochondria.	RNA forms in the nucleolus, and then moves to specialised regions of the cytoplasm depending on the type of RNA formed.
Reactivity	Due to its deoxyribose sugar, which contains one less oxygen-containing hydroxyl group, DNA is a more stable molecule than RNA, which is useful for a molecule which has the task of keeping genetic information safe.	RNA, containing a ribose sugar, is more reactive than DNA and is not stable in alkaline conditions. RNA's larger helical grooves mean it is more easily subject to attack by enzymes.
Ultraviolet (UV) Sensitivity	DNA is vulnerable to damage by ultraviolet light.	RNA is more resistant to damage from UV light than DNA.

Base pairing

- Base pairing is due to hydrogen bonds of opposite bases.
- between two strings = duplex
- between three strings = triplex
- between four strings = quadruplex.

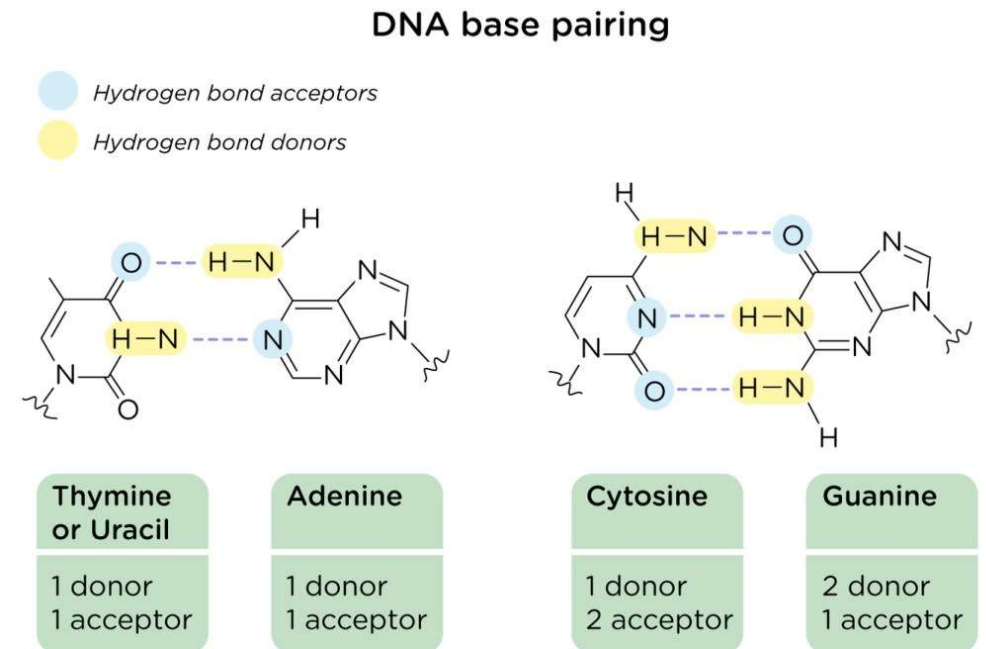

Jack Westin

Base pairing- tautomerization

(a) Standard base-pairing arrangements

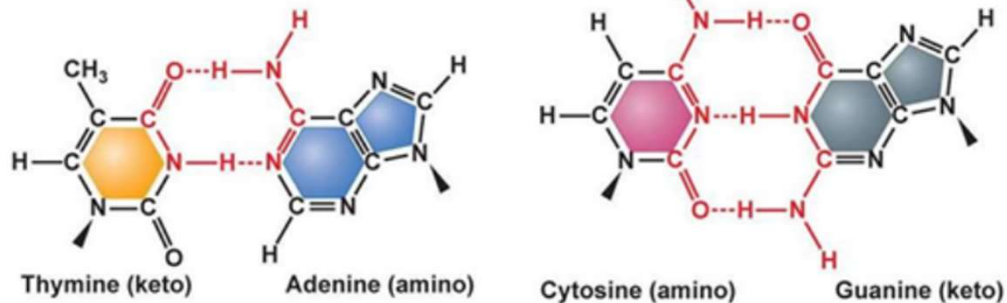

(b) Anomalous base-pairing arrangements

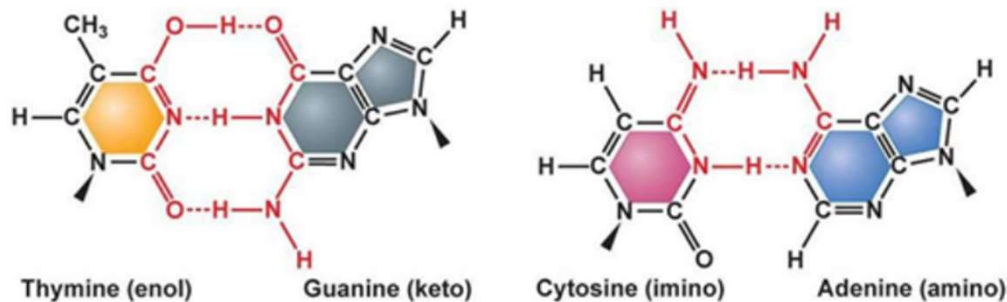

- Standard base-pairing arrangements of the canonical nucleotide isomers.
- Anomalous base-pairing arrangements of the tautomers.
- Tautomerization - process when a nonstationary proton tunnels from a common location to a less-common position within the aromatic ring.
- When tautomerization occurs during replication, the DNA sequence will be “misread”, and anomalous base-pairing will occur: such as C* with A, or T*.

Nucleic Acid is a polymer - macromolecules



B-DNA



Hairpin

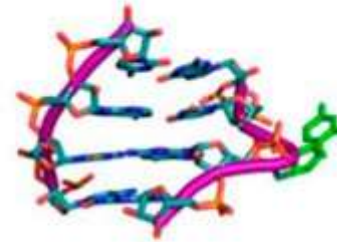

Bulge



Triplex DNA

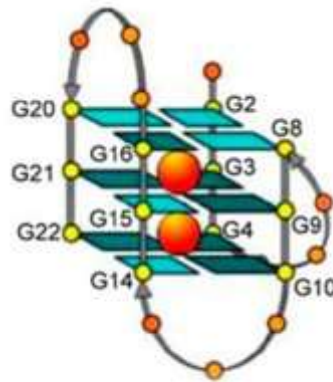

Hybrid G-quadruplex

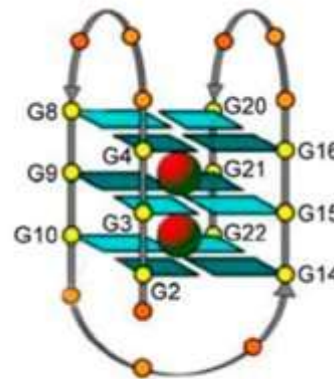

Anti-parallel G-quadruplex

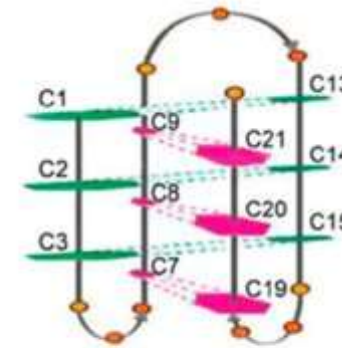

I-motif

Watson – Crick pairing rules

DNA

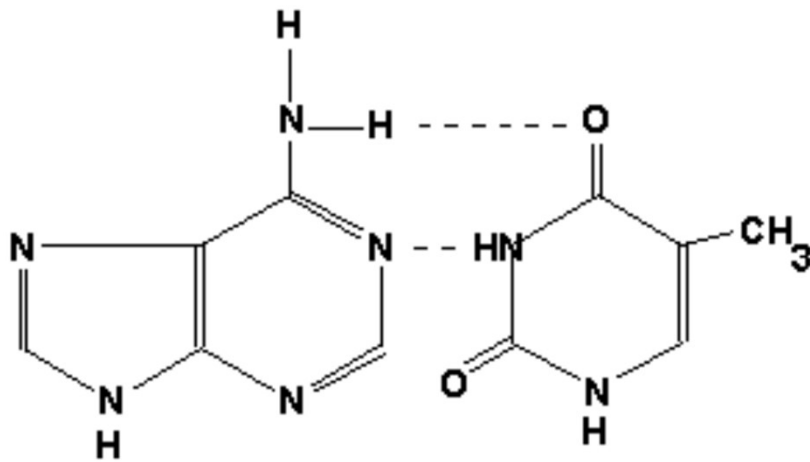

Adenine
(amino form)

Thymine
(keto form)

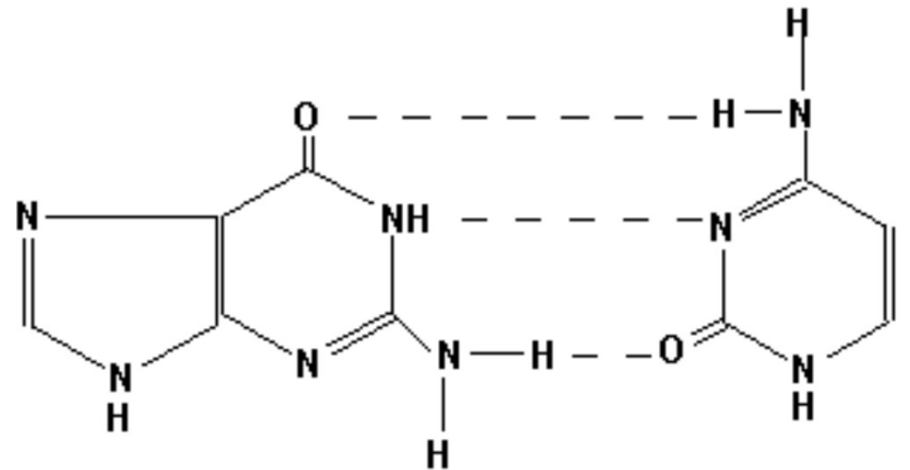

Guanine
(keto form)

Cytosine
(amino form)

Watson – Crick pairing

RNA

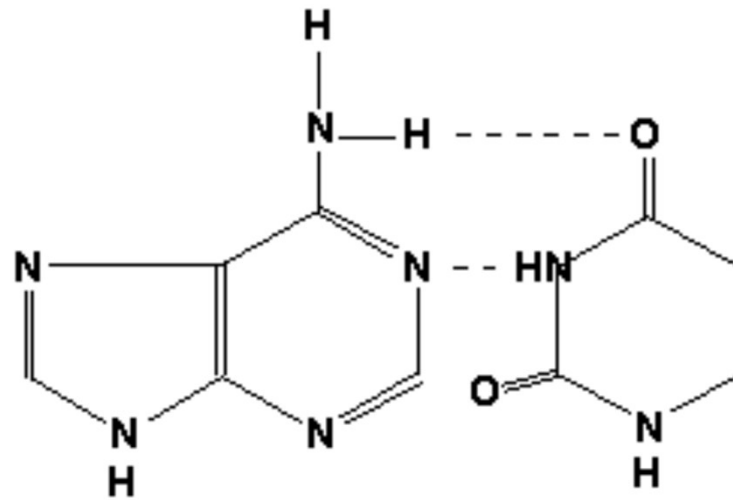

Adenine
(amino form)

Uracil
(keto form)

Chargaff's rules

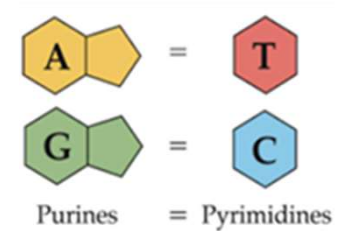

Rule 1:

- The amount of Adenine ~ equals the amount of Thymine
- The amount of Guanine ~ equals the amount of Cytosine
- The amount of purine = the amount of pyrimidine

Rule 2:

- The amount of A+T \neq amount of G+C
- This ratio varies among different organisms, but same in different tissues of the same organism.

$$\frac{A + G}{T + C} = 1 \qquad \frac{T + A}{C + G} \neq 1$$

A G G G G G G G A A G G
 | | | | | | | | | |
 T C C C C C C C T T C C

purines $\frac{3 + 9}{3 + 9} = \frac{12}{12} = 1$ $\frac{9 + 9}{3 + 3} = \frac{18}{6} = 3$
 pyrimidines

(%GC) is different

Abundance of nucleotides in different organisms

- Erwin Chargaff's Data (1950 – 1951)

	Base composition, mole percent				Base ratios			Asymmetry ratio
	A	G	C	T	A/T	G/C	Pu/Py	$\frac{A+T}{G+C}$
Animals								
Man	30.9	19.9	19.8	29.4	1.05	1.00	1.04	1.52
Sheep	29.3	21.4	21.0	28.3	1.03	1.02	1.03	1.36
Hen	28.8	20.5	21.5	29.2	1.02	0.95	0.97	1.38
Turtle	29.7	22.0	21.3	27.9	1.05	1.03	1.00	1.31
Salmon	29.7	20.8	20.4	29.1	1.02	1.02	1.02	1.43
Sea urchin	32.8	17.7	17.3	32.1	1.02	1.02	1.02	1.58
Locust	29.3	20.5	20.7	29.3	1.00	1.00	1.00	1.41
Plants								
Wheat germ	27.3	22.7	22.8	27.1	1.01	1.00	1.00	1.19
Yeast	31.3	18.7	17.1	32.9	0.95	1.09	1.00	1.79
<i>Aspergillus niger</i> (mold)	25.0	25.1	25.0	24.9	1.00	1.00	1.00	1.00
Bacteria								
<i>E. coli</i>	24.7	26.0	25.7	23.6	1.04	1.01	1.03	0.93
<i>Staphylococcus aureus</i>	30.8	21.0	19.0	29.2	1.05	1.11	1.07	1.50
<i>Clostridium perfringens</i>	36.9	14.0	12.8	36.3	1.01	1.09	1.04	2.70
<i>Brucella abortus</i>	21.0	29.0	28.9	21.1	1.00	1.00	1.00	0.72
<i>Sarcina lutea</i>	13.4	37.1	37.1	12.4	1.08	1.00	1.04	0.35
Bacteriophages								
T7	25.0	24.0	24.0	25.0	1.00	1.00	1.00	1.08
λ	21.3	28.6	27.2	22.9	0.92	1.05	1.00	0.79
ϕ X174, viral	24.6	24.1	18.5	32.7	0.75	1.30	0.95	1.34
ϕ X174, replicative	26.3	22.3	22.3	26.4	1.00	1.00	1.00	1.18

Abundance of nucleotides in different organisms

Organism	%A	%G	%C	%T	A/T	G/C	%GC	%AT
φX174	24.0	23.3	21.5	31.2	0.77	1.08	44.8	55.2
Maize	26.8	22.8	23.2	27.2	0.99	0.98	46.1	54.0
Octopus	33.2	17.6	17.6	31.6	1.05	1.00	35.2	64.8
Chicken	28.0	22.0	21.6	28.4	0.99	1.02	43.7	56.4
Rat	28.6	21.4	20.5	28.4	1.01	1.00	42.9	57.0
Human	29.3	20.7	20.0	30.0	0.98	1.04	40.7	59.3
Grasshopper	29.3	20.5	20.7	29.3	1.00	0.99	41.2	58.6
Sea Urchin	32.8	17.7	17.3	32.1	1.02	1.02	35.0	64.9
Wheat	27.3	22.7	22.8	27.1	1.01	1.00	45.5	54.4
Yeast	31.3	18.7	17.1	32.9	0.95	1.09	35.8	64.4
<i>E. coli</i>	24.7	26.0	25.7	23.6	1.05	1.01	51.7	48.3

- *Plasmodium falciparum*
(GC% = ~20%)
- *Streptomyces coelicolor*
(GC% = 72%)

Structure of DNA

- B-form dsDNA
- Complementarity of both strands.
- Distance of the backbone from the axis = 1 nM.
- Distance of bases is 0,34 nM.
- Antiparallelism = direction of phosphodiester bonds 5'-3' and 3'-5'.
- Planar character of bases.
- Smaller and larger groove = places of protein binding to DNA.

Schematic diagram DNA

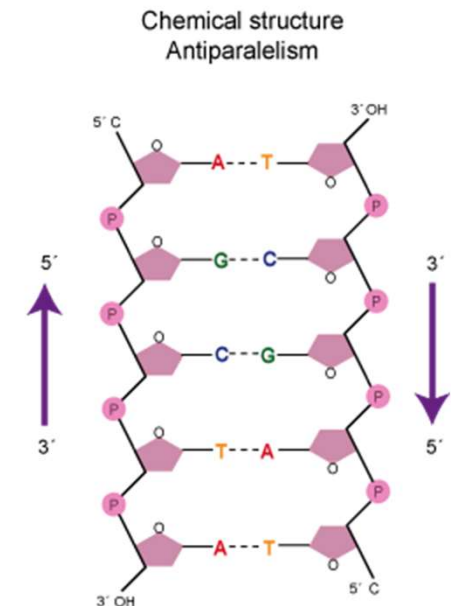
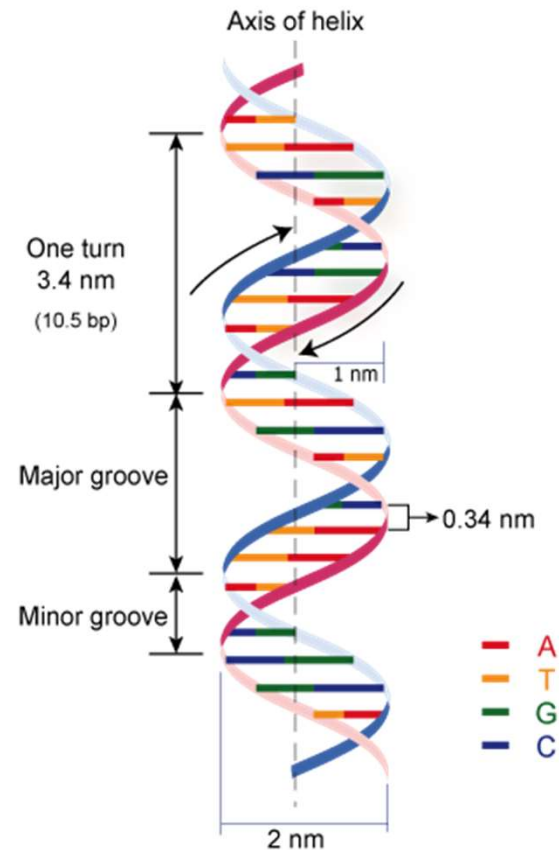

Structure of DNA

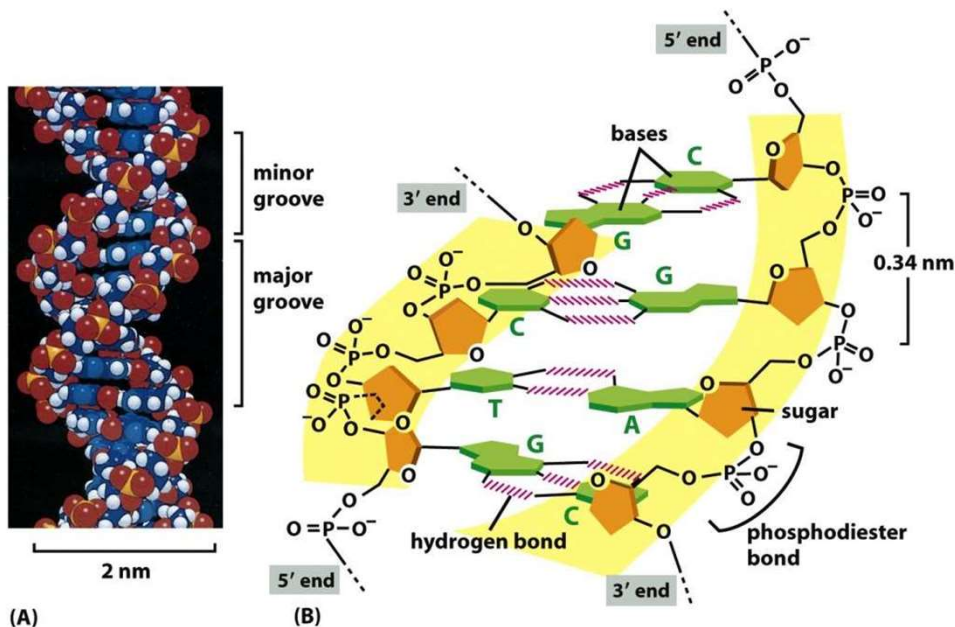

- The bases are oriented inside the double helix to the energetically most advantageous arrangement.
- One helix turn accounts for **10.5 base pairs**.
- The diameter 2 nm.
- Winding creates a large and small groove in the helix.
- Both twin helix strands are **antiparallel** and fully **complementary**.

Minor and Major groove of DNA

- The major and minor grooves are opposite each other.
- Each runs continuously along the entire length of the DNA molecule.
- They arise from the antiparallel arrangement of the two backbone strands.
- The grooves are important in the attachment of DNA Binding Proteins involved in replication and transcription.

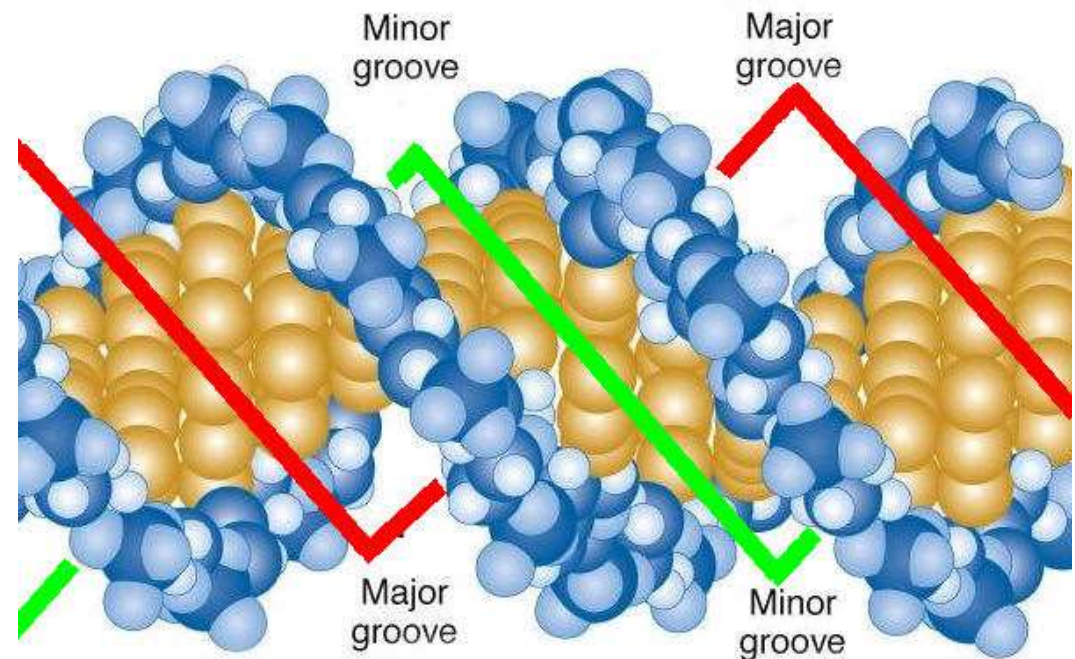

DNA recognition code

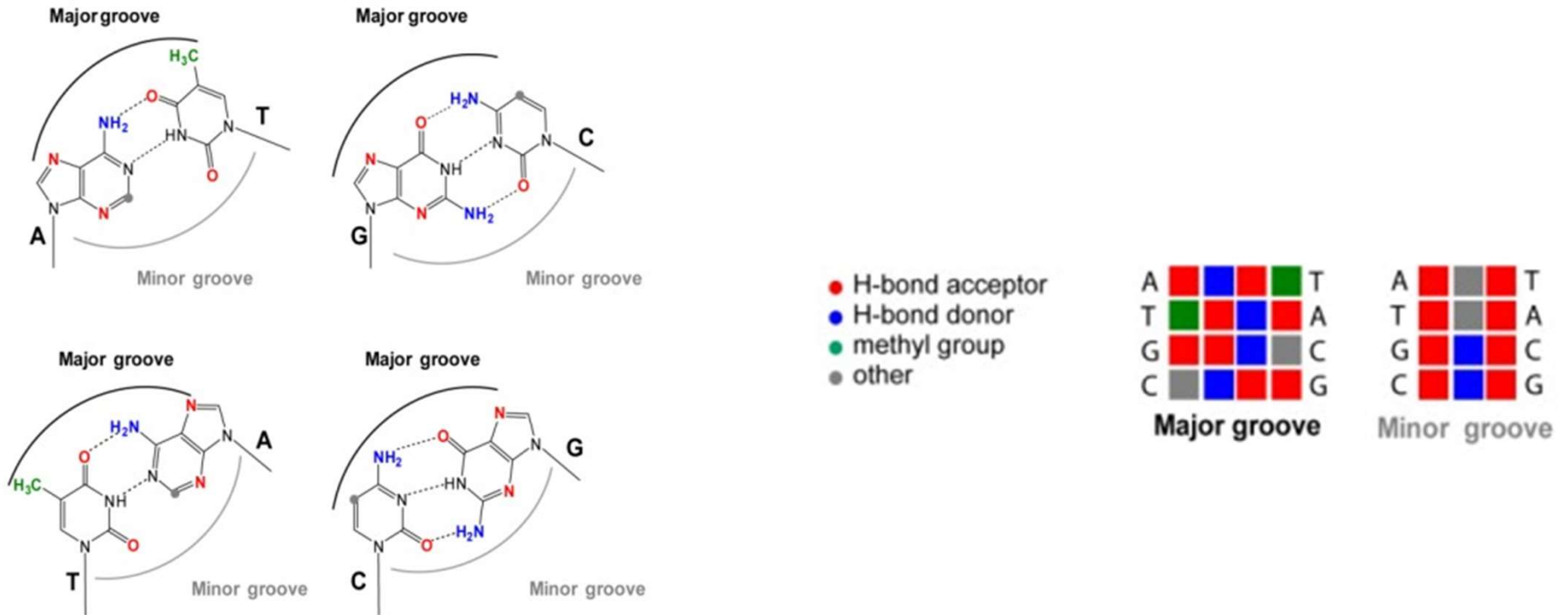

Strands in DNA helix are in antiparallel orientation

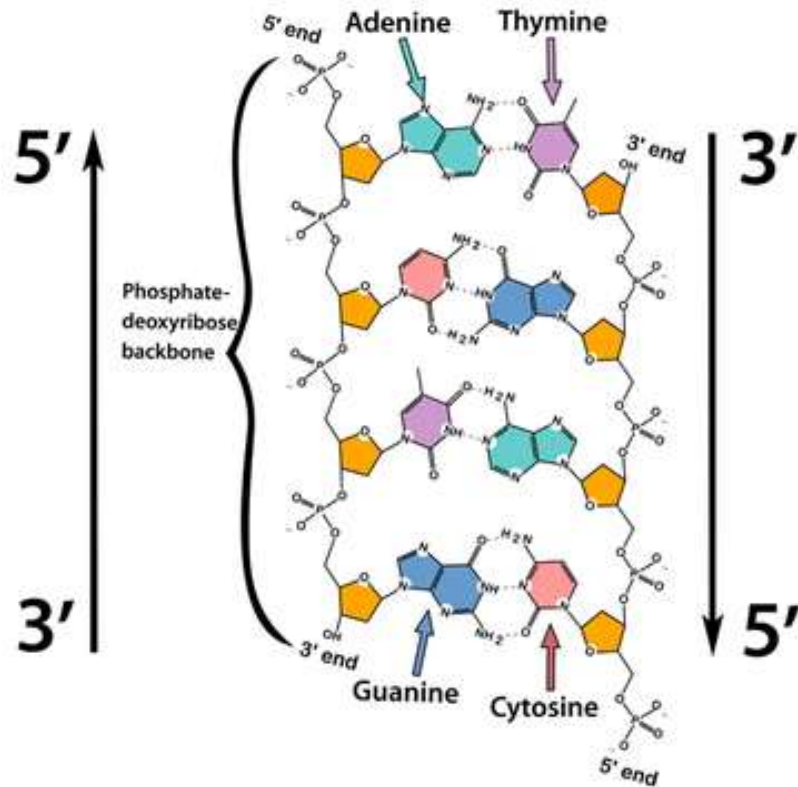

- Two strands of DNA have the same helical geometry however base pairing holds the strands together with opposite polarity.
- The 5' end of a strand is paired with the base of the end of the other strand 3'.
- This is called anti-parallel orientation, the consequence that adenine and thymine pair with each other and guanine and cytosine pair with each other.

Winding of DNA

- Rosypal (1998): "If we place the thumb of right hand in the direction of the Double helix axis, and other fingers point direction of its ascent/climbing – it is a right-handed double helix. Left-handed double helix corresponds to a similar rule of the left hand.,,"
- There is an experiment proving the principle underlying the Vester-Ulbricht hypothesis that the primarily left-handed spinning electrons in cosmic rays could have preferentially destroyed left-handed precursors of DNA, leaving only right-handed DNA. The sculpture illustrates DNA's right-handed double helix.

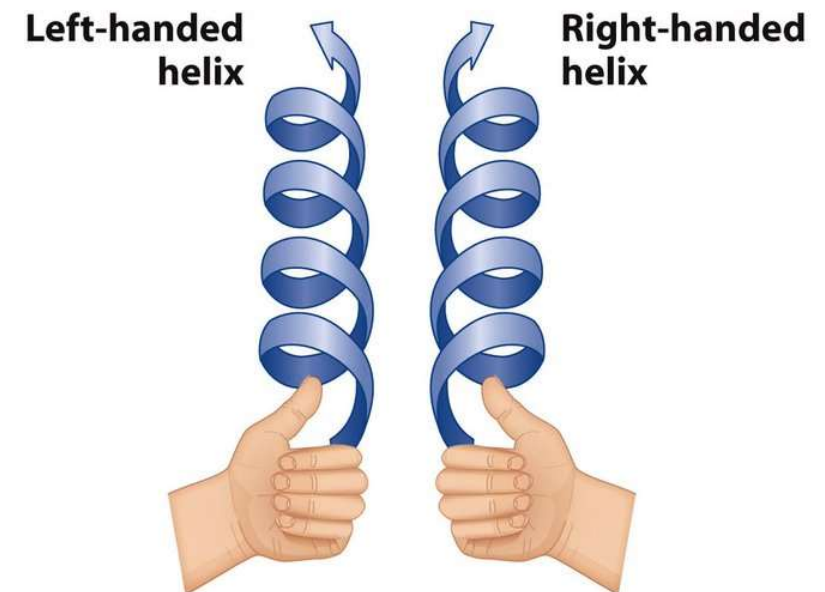

Box 4-1
Lehninger Principles of Biochemistry, Fifth Edition
© 2008 W.H. Freeman and Company

Conformation of dsDNA or dsRNA

- Conformation = spatial arrangement of the biomacromolecule into a structure, which is the most energy-efficient under the given conditions.
- DNA conformation depends on:
 - nucleotide sequence
 - water content in the environment
 - ion force of the environment.



Forms of DNA

FORMS

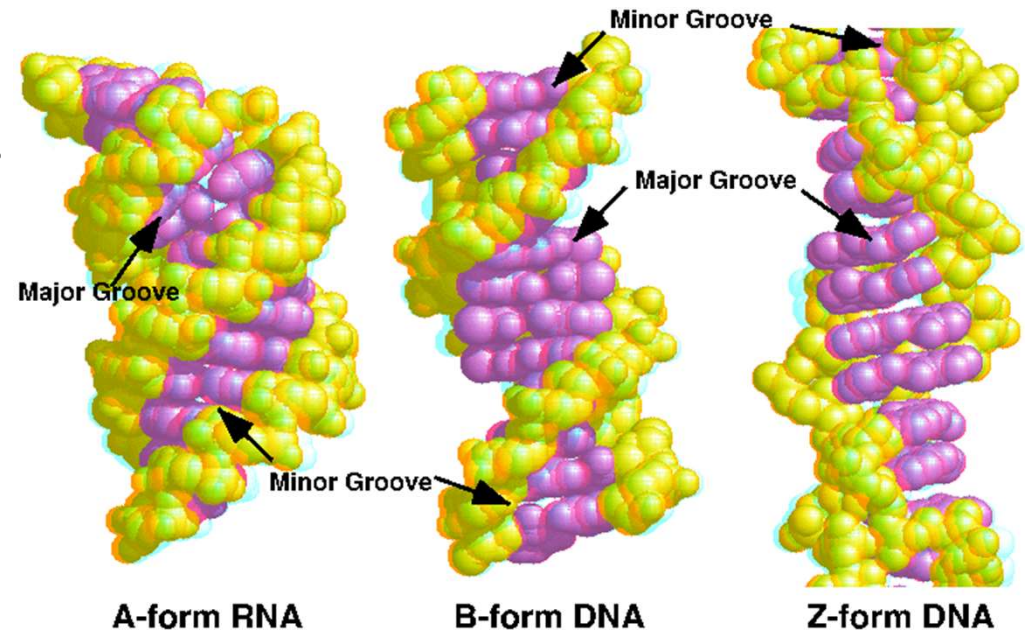
- B-DNA: right-handed, in aqueous solutions and at normal salt concentrations.
- A-DNA: right-handed, with 11 bp per turn, in dehydrated samples.
- Z-DNA: left-handed, with 12 pb per turn, occurrence in double helixes GC-rich, function unclear in living systems.



Forms of DNA

	B form DNA	A form DNA	Z form DNA
Helical sense	Right handed	Right handed	Left handed
Major groove	Present	Present	Absent
bp/helical tern	10.5	11	12
Glycosyl bond conformation	Anti	Anti	Anti (for pyrimidines) and syn (for Purines)
Helix rise/bp	3.4Å	2.6Å	3.7Å
Base tilt	6°	20°	7°
Structure			

A-form of DNA



A-form

- Most RNA and RNA-DNA duplex in this form.
- Shorter, wider helix than B.
- Deep, narrow major groove not easily accessible to proteins.
- Wide, shallow minor groove accessible to proteins, but lower information content than major groove.
- Favored conformation at low water concentrations.
- Base pairs tilted to helix axis.

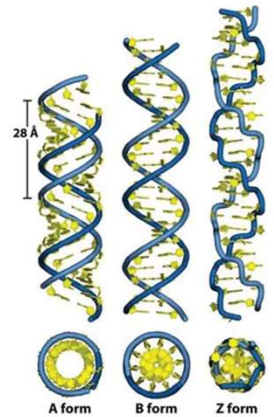

B-form of DNA



B-form

- Most common DNA conformation *in vivo*.
- Narrower, more elongated helix than A.
- Wide major groove easily accessible to proteins.
- Narrow minor groove.
- Favored conformation at high water concentrations (hydration of minor groove seems to favor B-form).
- Base pairs nearly perpendicular to helix axis.

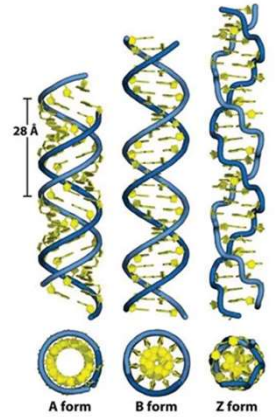

Z- form of DNA

Z-form

- Helix has left-handed sense.
- Can be formed in vivo, given proper sequence and superhelical tension, but function remains obscure.
- Narrower, more elongated helix than A or B.
- Major "groove" not really groove.
- Narrow minor groove.

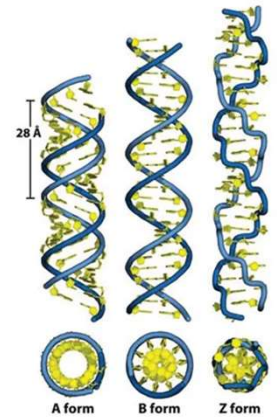

Z- form of DNA



Z-form

- Conformation favored by high salt concentrations, some base substitutions, but requires alternating purine-pyrimidine sequence.
- Base pairs nearly perpendicular to helix axis.
- GpC repeat, not single base-pair.
- Zigzag backbone due to C sugar conformation compensating for G glycosidic bond conformation.

Forms of DNA

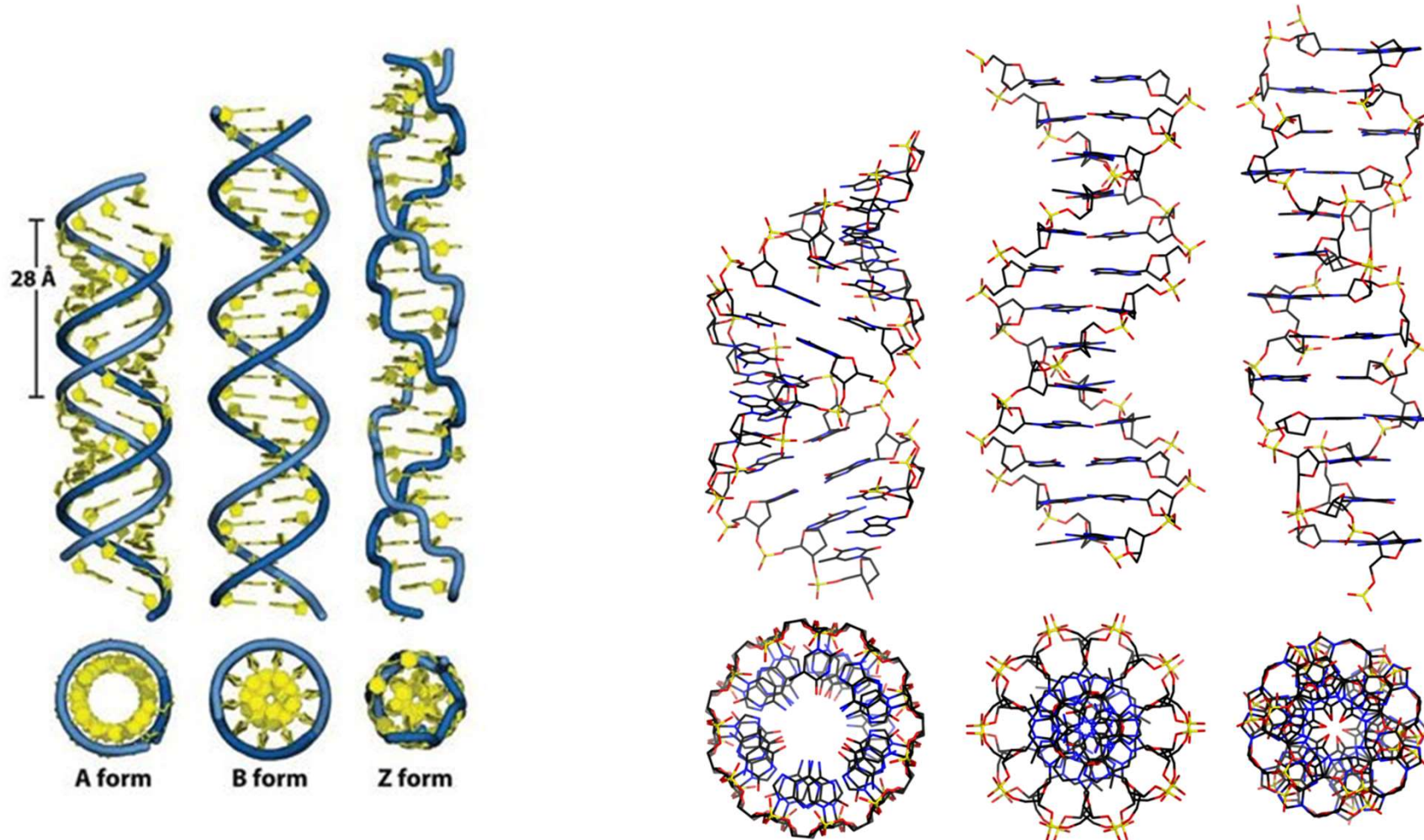

DNA organization

- Primary

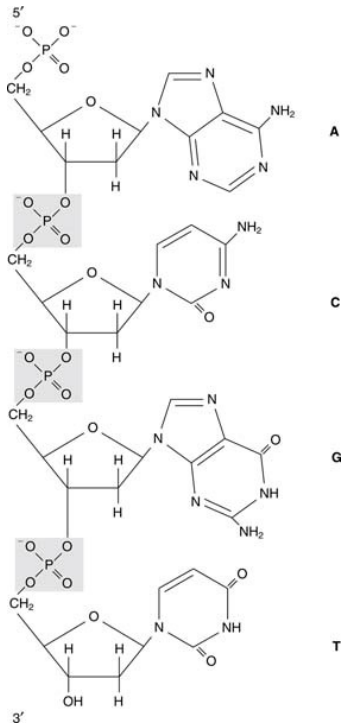

- Secondary

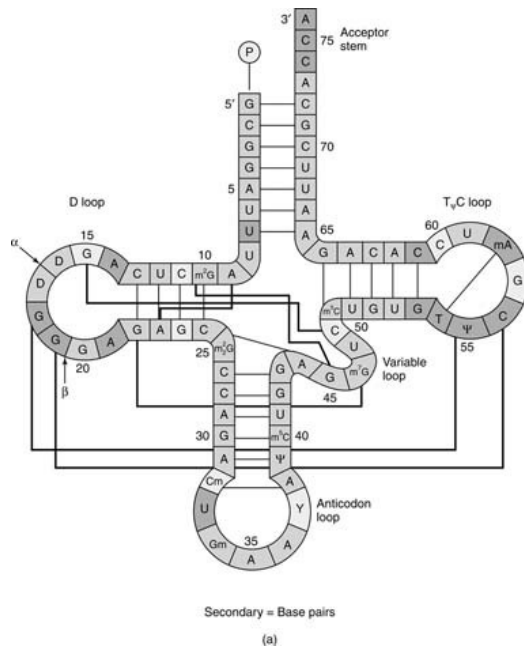

- Tertiary

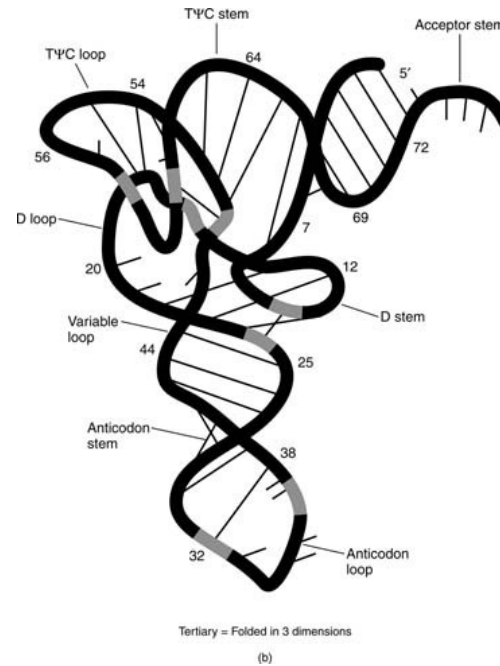

- Quaternary

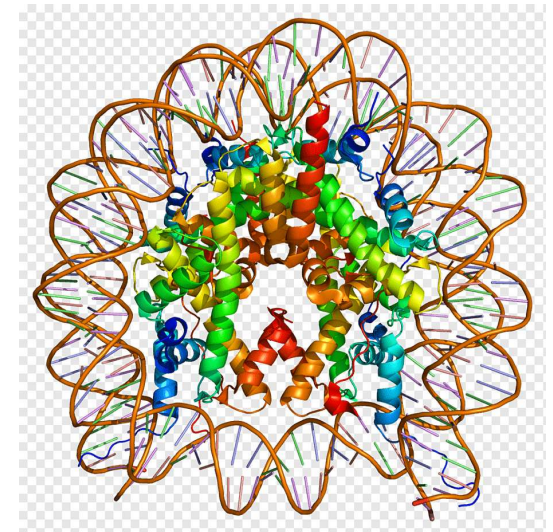

Primary structure of DNA

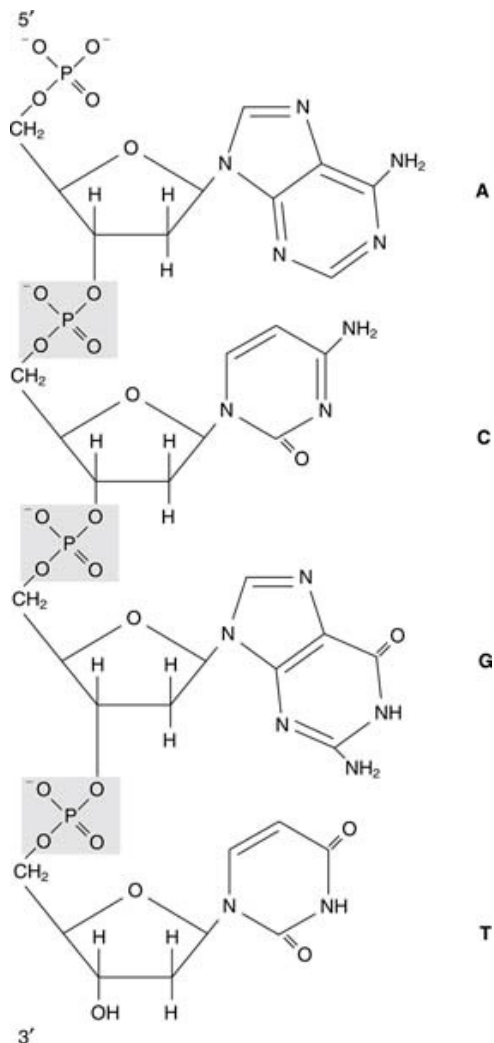

- Primary structure is sequence of bases in the **nucleic acid chain** gives the primary structure of DNA or RNA.
- The sequence of bases is read in a **5' → 3' direction**, so that you would read the structure in the figure as ACGT.

Secondary structure of DNA

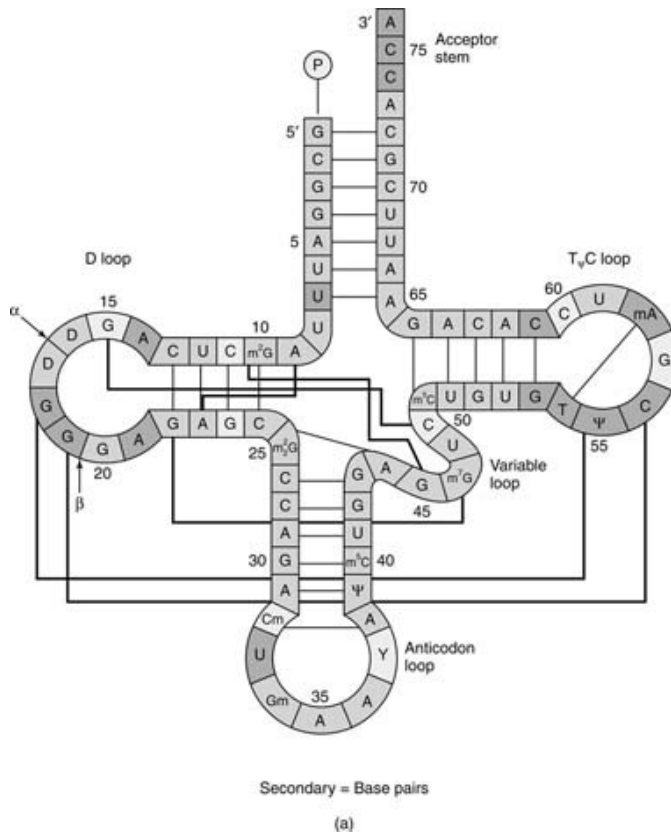

- The base-pairing of complementary nucleotides gives the secondary structure of a nucleic acid.
- In a double-stranded DNA or RNA, this refers to the Watson-Crick pairing of complementary strands.
- In a single-stranded RNA or DNA, the intramolecular base pairs between complementary base pairs determines the secondary structure of the molecule.

Tertiary structure of DNA

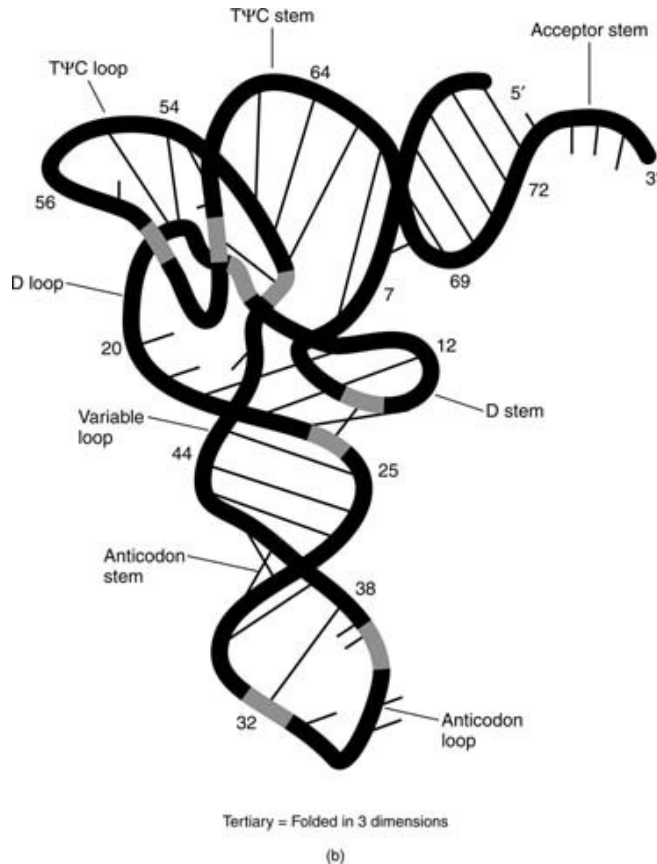

- The tertiary structure of a nucleic acid refers to the three-dimensional arrangement of the nucleic acid - that is, the arrangement of the molecule in space, as in the tertiary structure of tRNA.

Quaternary structure of DNA

- Quaternary structure refers to the large shapes and structures that can be made by nucleic acids.

DNA – histone
= nucleosome

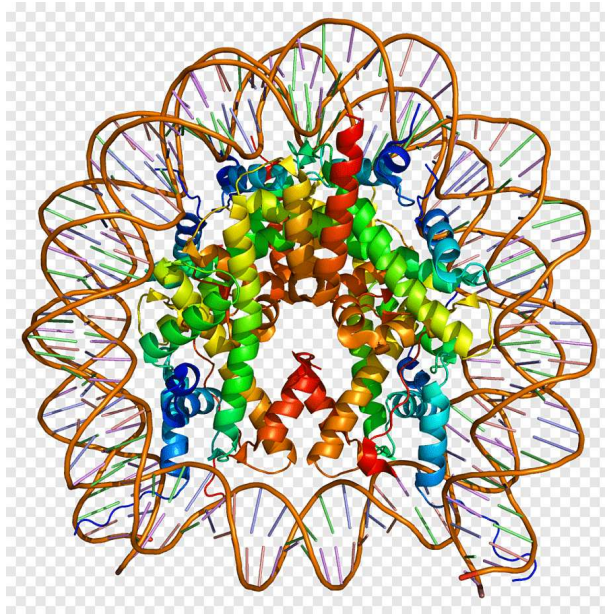

RNA – protein
= ribosome

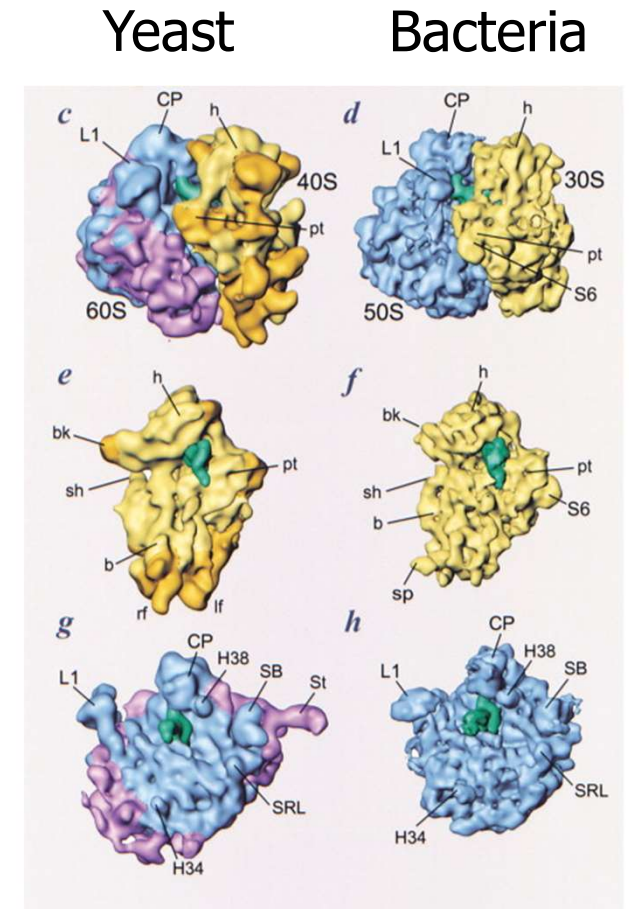

Organization of dsDNA

- The DNA double helix may be arranged in space, in a tertiary arrangement of the strands.
- The two strands of DNA wind around each other. In a covalently closed circular DNA (cccDNA), this means that the two strands can't be separated.

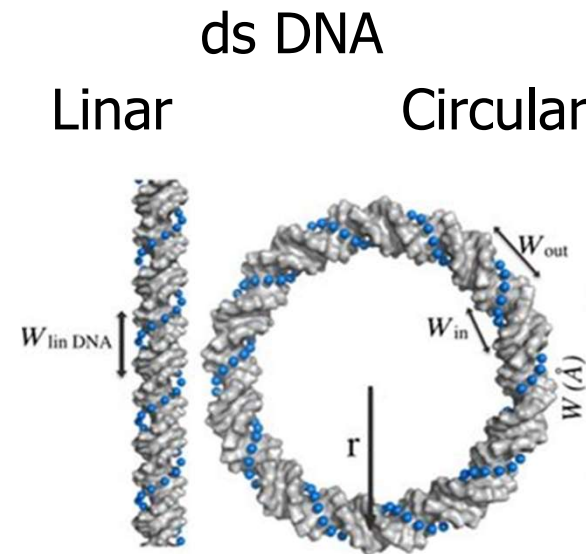
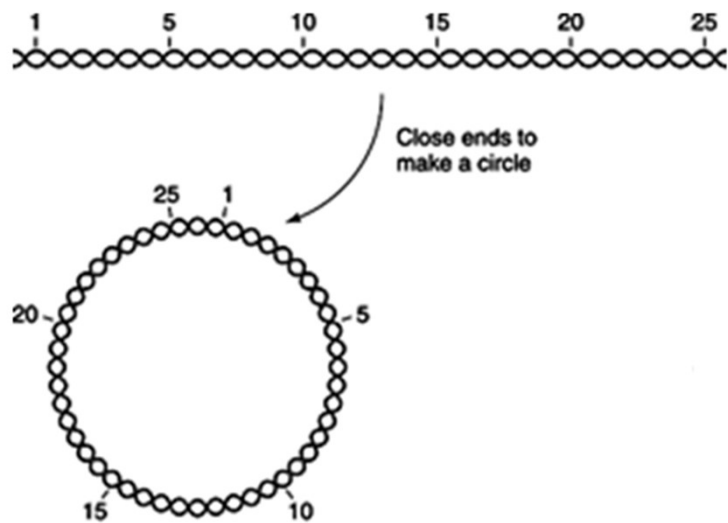

Organization of dsDNA

Open circular (OC) dsDNA Super colied (SC) dsDNA

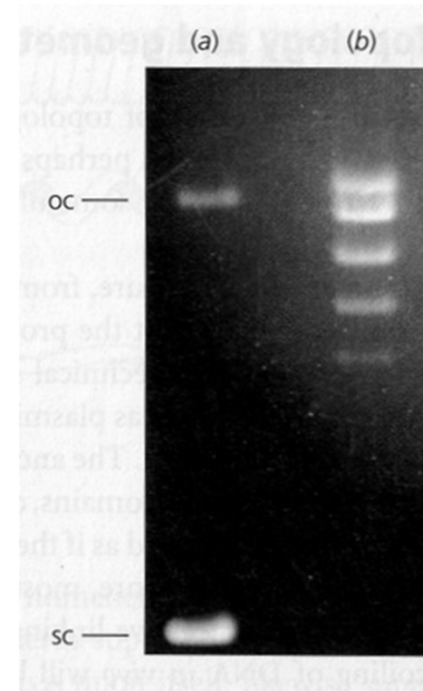
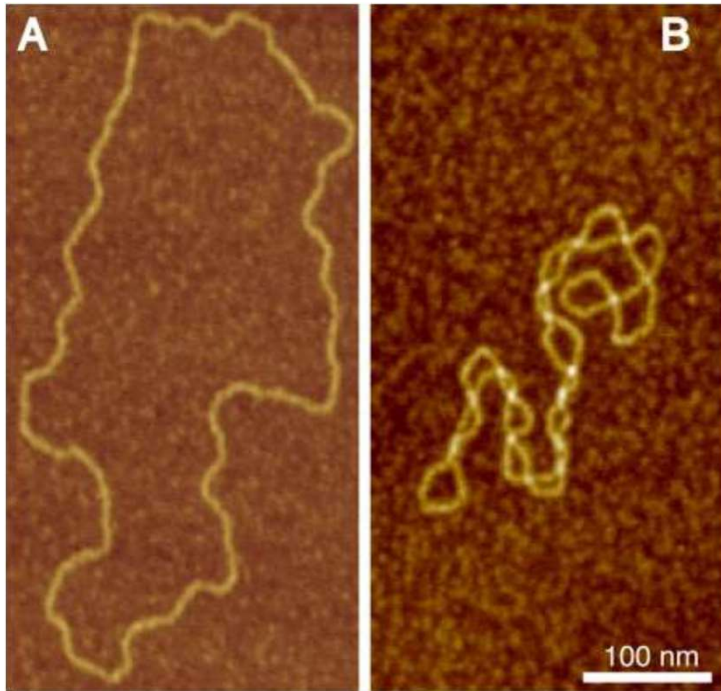

Organization of dsDNA

- In closed circular DNA the strands can't be separated, the total number of turns in a given molecule of cccDNA is a constant, called the **Linking Number**, or Lk.
- The linking number of a DNA is an integer and has two components,
- **Twist (Tw)**, or number of helical turns of the DNA.
- **Writhe (Wr)**, number of times the double helix crosses over on itself (these are the supercoils).

- Because Lk is a constant, the relationship can be shown by the equation: $Lk = Tw + Wr$

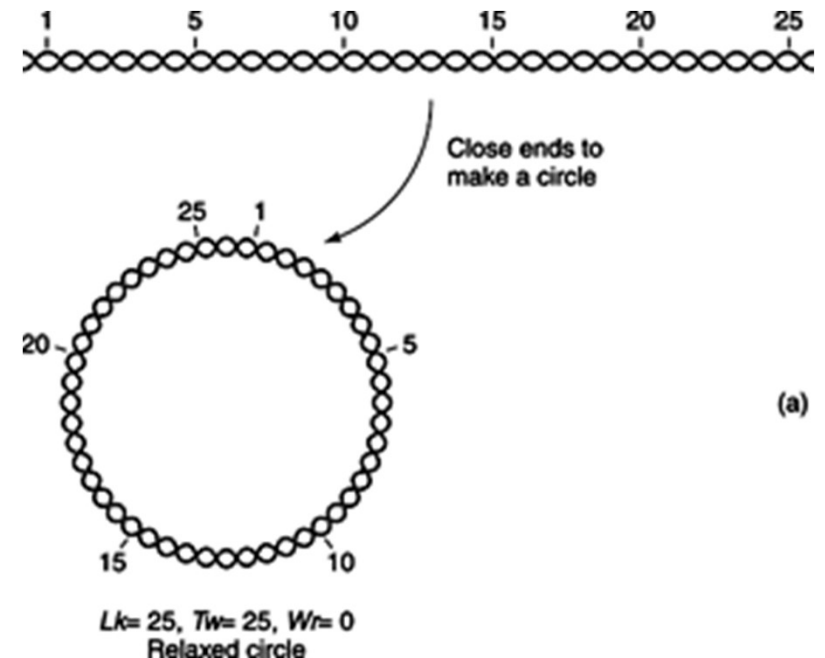

Organization of dsDNA

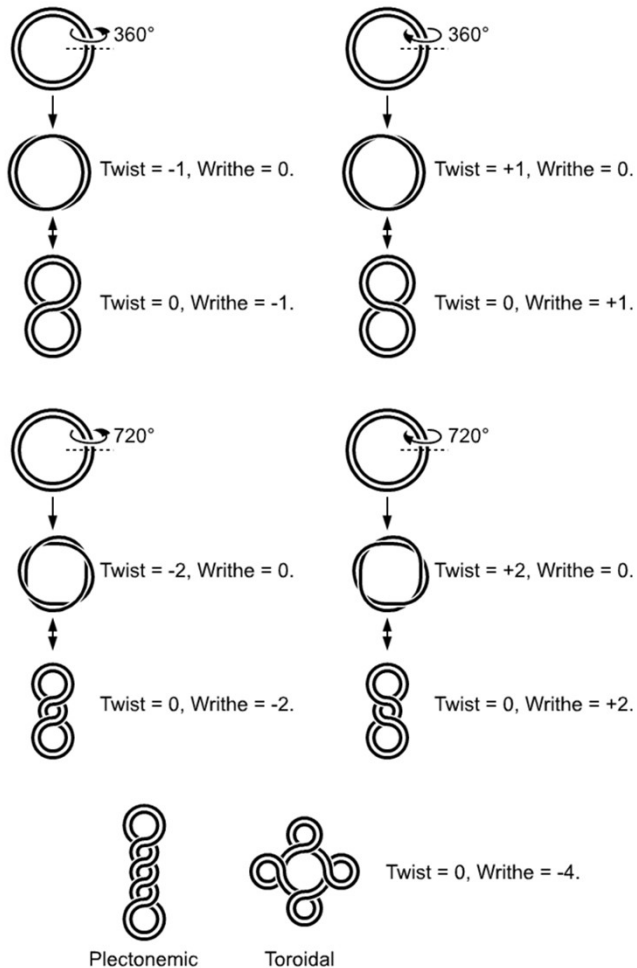

- The simplest supercoil (writhe), is the shape a circular DNA assumes to accommodate one too many or one too few helical twists. The two lobes of the figure eight will appear rotated either clockwise or counterclockwise with respect to one another, depending on whether the helix is over or underwound.
- Twist and writhe are interconvertible.
- Extra helical twists are positive and lead to positive supercoiling, while subtractive twisting causes negative supercoiling.

Organization of dsDNA

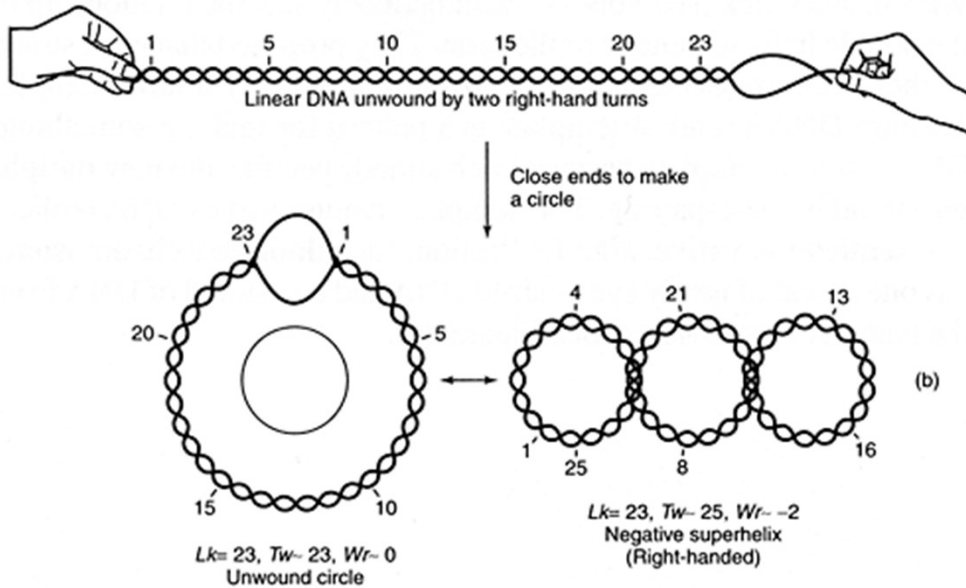

- Normally, this DNA would have a linking number equal to 25, so it is underwound.
- The DNA double helical structures have the same value of Lk ; however, the DNA can be supercoiled, with the two “underwindings” taken up by the negative supercoils.
- This is equivalent to two “turns'-worth” of single-stranded DNA and no supercoils.

Organization of dsDNA

- As a general rule, the DNA of most organisms is **negatively supercoiled**.

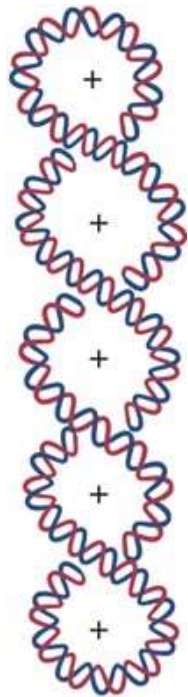

Positive superhelix

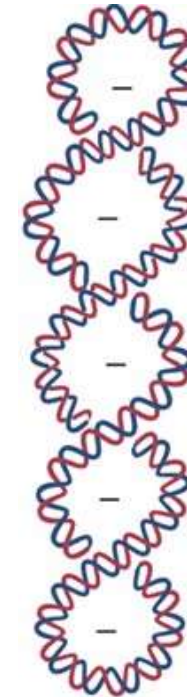
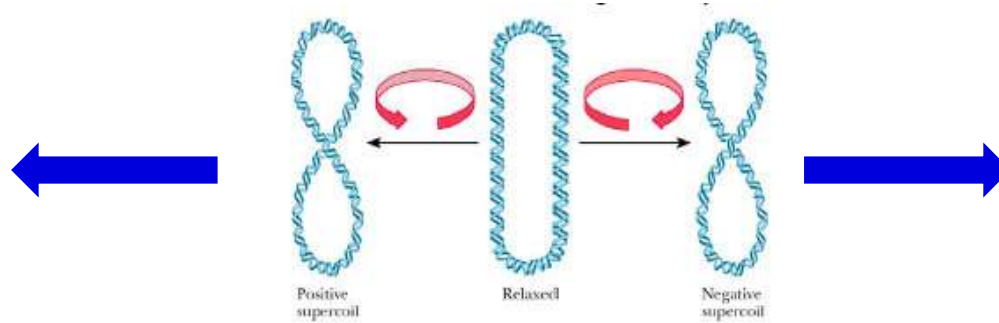

Negative superhelix

Organization of dsDNA

- Increasing number of superhelixes of plasmid DNA.

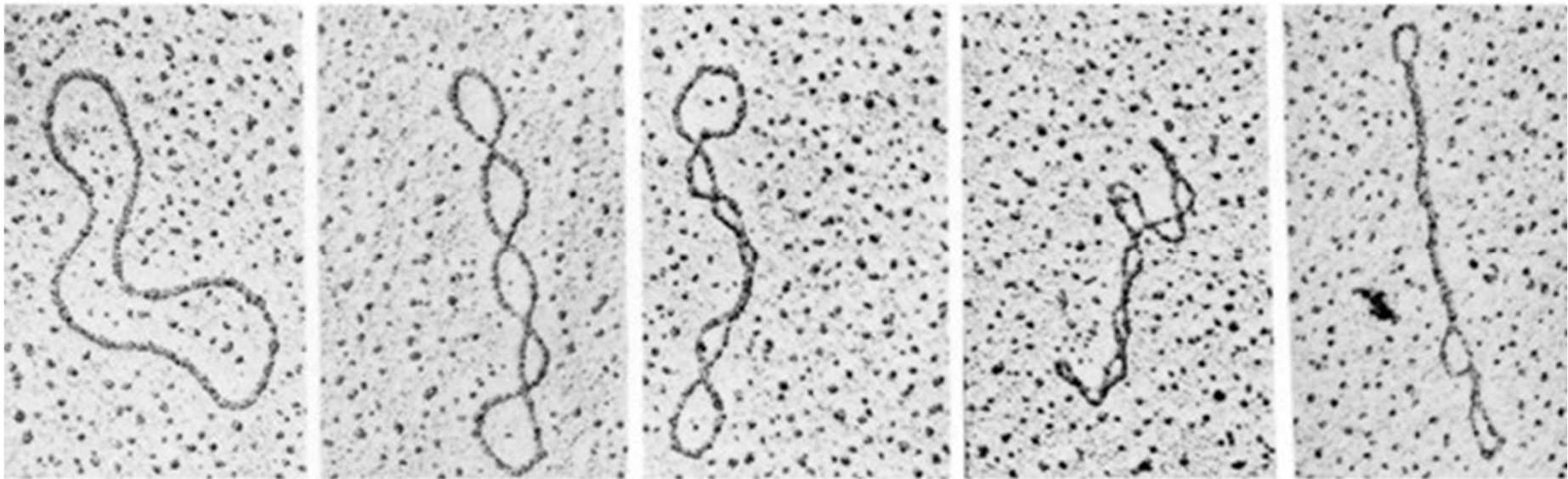

Electron micrographs by Lauren Foster. From Norberg, A. and Baker, T.A., DNA Replication (2nd ed.), p. 36, W.H. Freeman (1992). Used with permission.

DNA – topoisomerases

- DNA – topoisomerases - alter Lk, the linking number of a DNA, by a bond breaking and rejoining process.
- Catalyze the formation of transitional breaks in DNA
- Break ("nick") = breaking of the phosphodiester bond between neighboring bases.

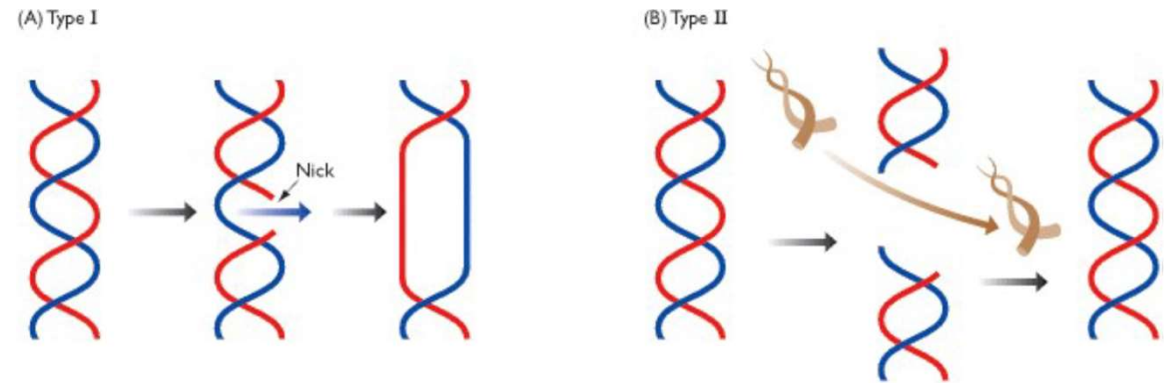

- Cut in **one** DNA strand is catalyzed by topoisomerase I.
- Cuts in **both** DNA strands are catalyzed by topoisomerase II = DNA-gyrase.

DNA – topoisomerase I

- **Type I topoisomerases** (sometimes called “nicking-closing enzymes”) carry out the conversion of negatively supercoiled DNA to relaxed DNA in increments of one turn.
- Type I, increases Lk by increments of one to a final value of zero.
- Type I topoisomerases are energy independent, because they **don't require ATP** for their reactions.
- Anti-tumor drugs, including Camptothecin, target the eukaryotic topoisomerase I.

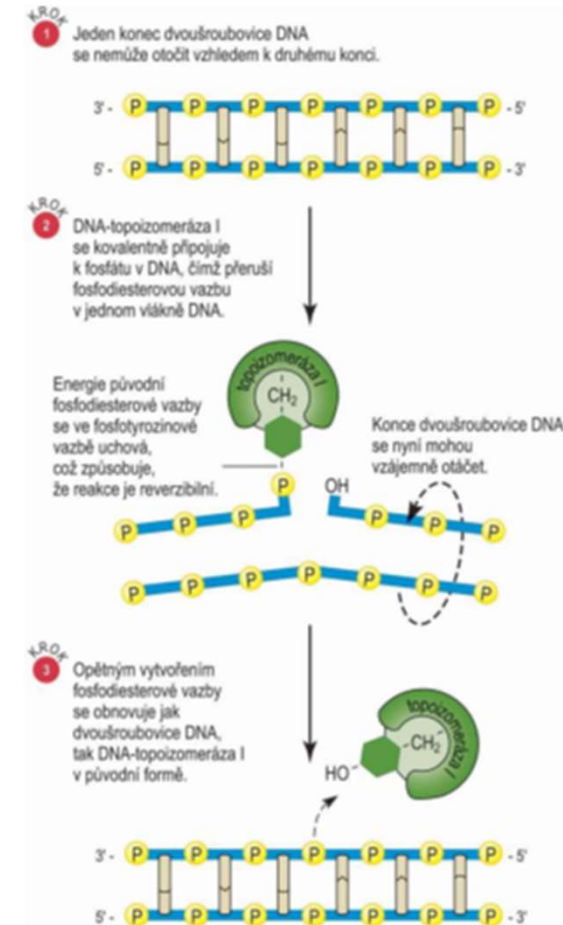

DNA – topoisomerase I

- Releases superhelix tension from the superhelix DNA.
- Topoisomerase covalently attaches to one of the phosphates in DNA,
 - cuts DNA strand can rotate around its longitudinal axis,
 - the strand tension/pressure is relieved,
 - double helix restoration and enzyme is released.

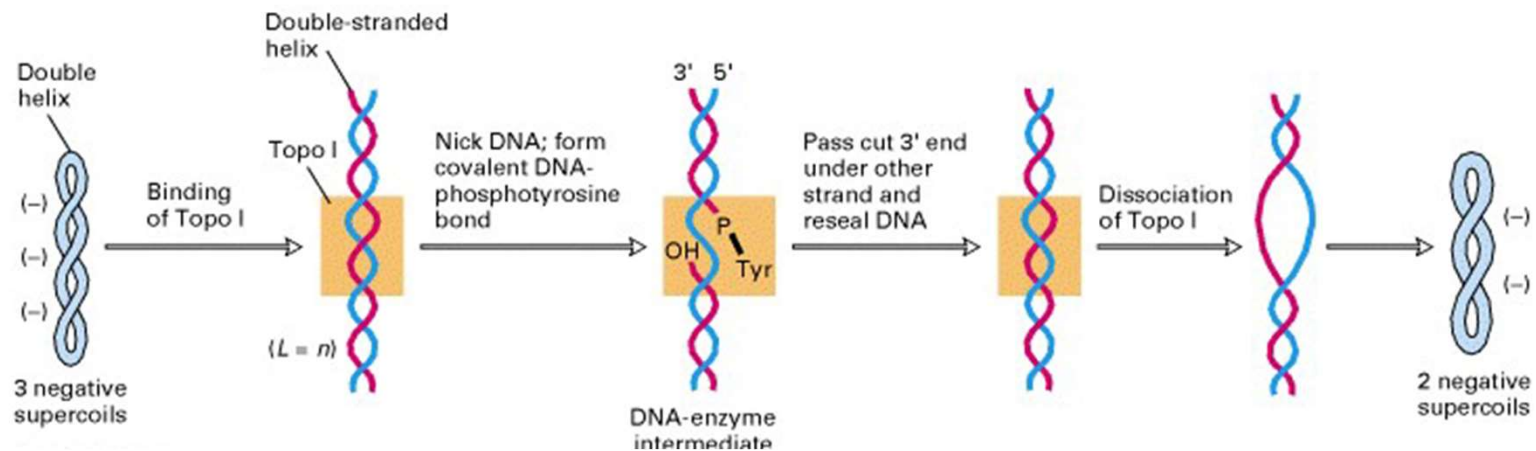

DNA – topoisomerase II (DNA Gyrase)

- Type II topoisomerases (sometimes called DNA gyrases) reduce Lk by increments of two.
- These enzymes are **ATP-dependent** and will alter the linking number of any closed circular DNA.
- TOP2 functions by relieving supercoils generated as a function of the double stranded nature of DNA.
- Type II topoisomerases act on naturally occurring DNAs to make them supercoiled.

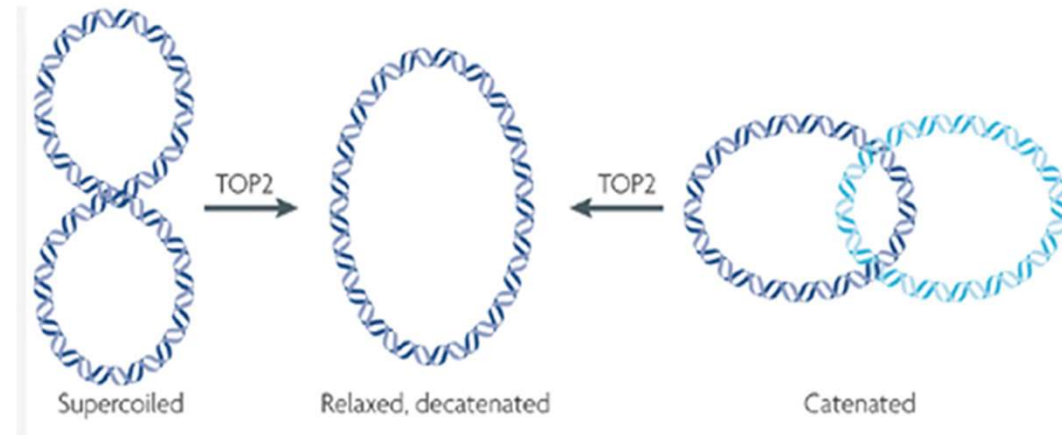

DNA – topoisomerase II (DNA Gyrase)

- Type II topoisomerases mechanism of action.
- The enzyme unknots and untangles DNA by passing an intact helix through a transient double-stranded break that it generates in a separate helix.

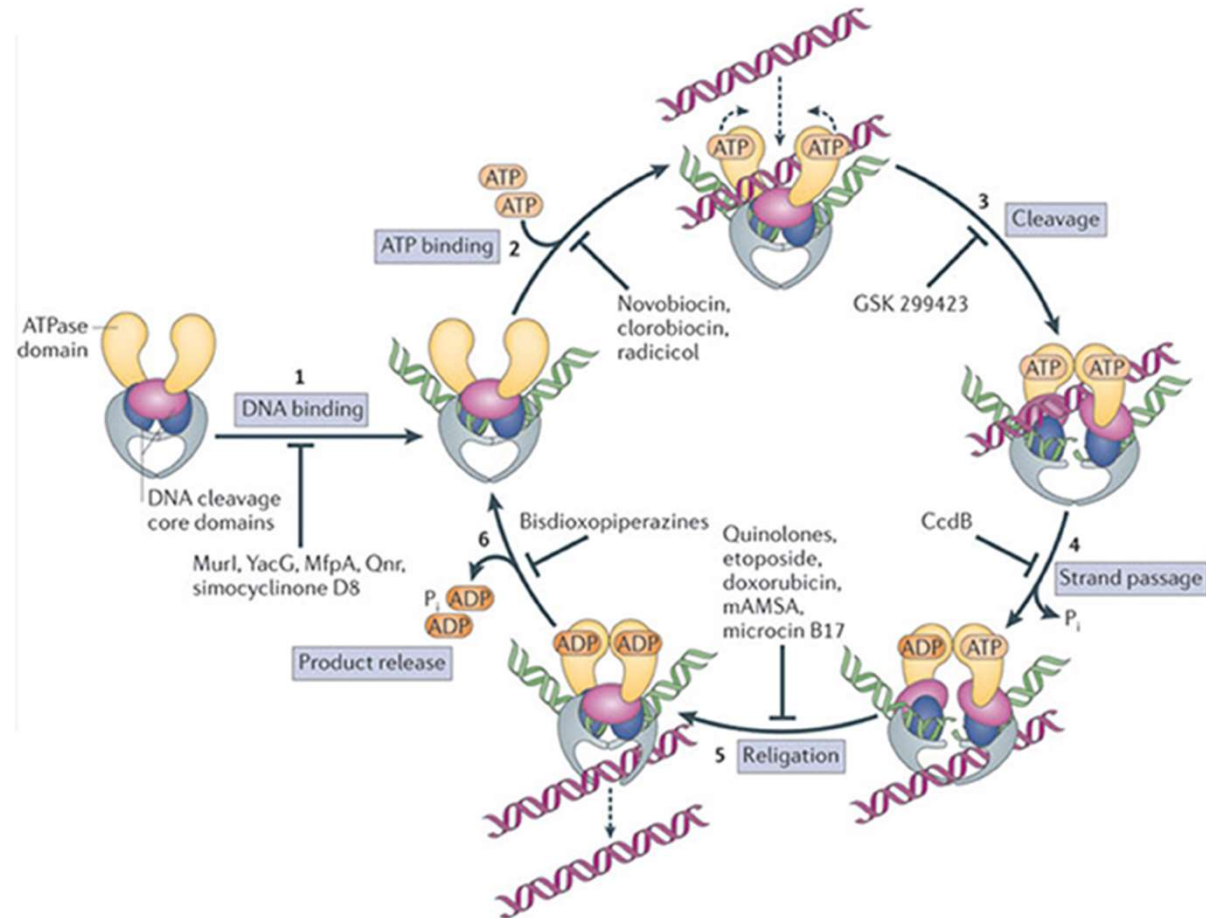

Differences between topoisomerases I and II

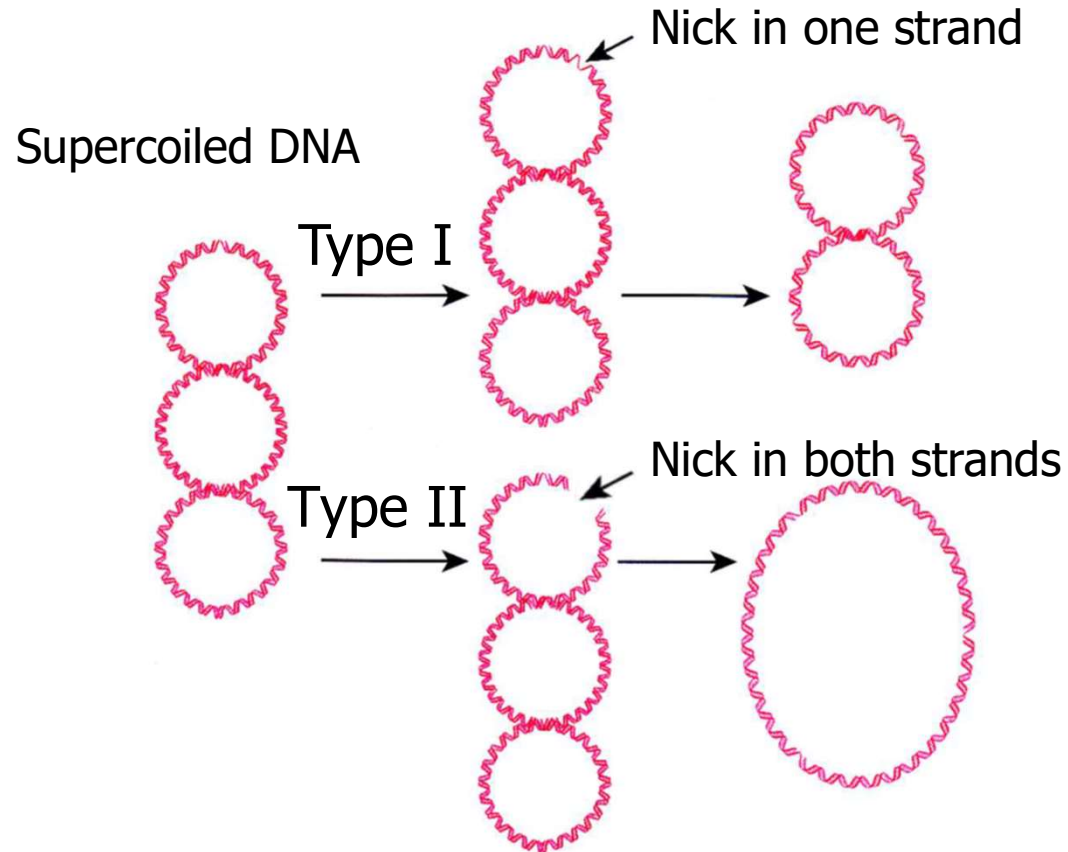

- the one strand moves above the other one in the cut and merges:
- L is reduced by 1
- both strands move above the break and merges:
- + ATP for function
- L is reduced by 2

Differences between topoisomerases I and II

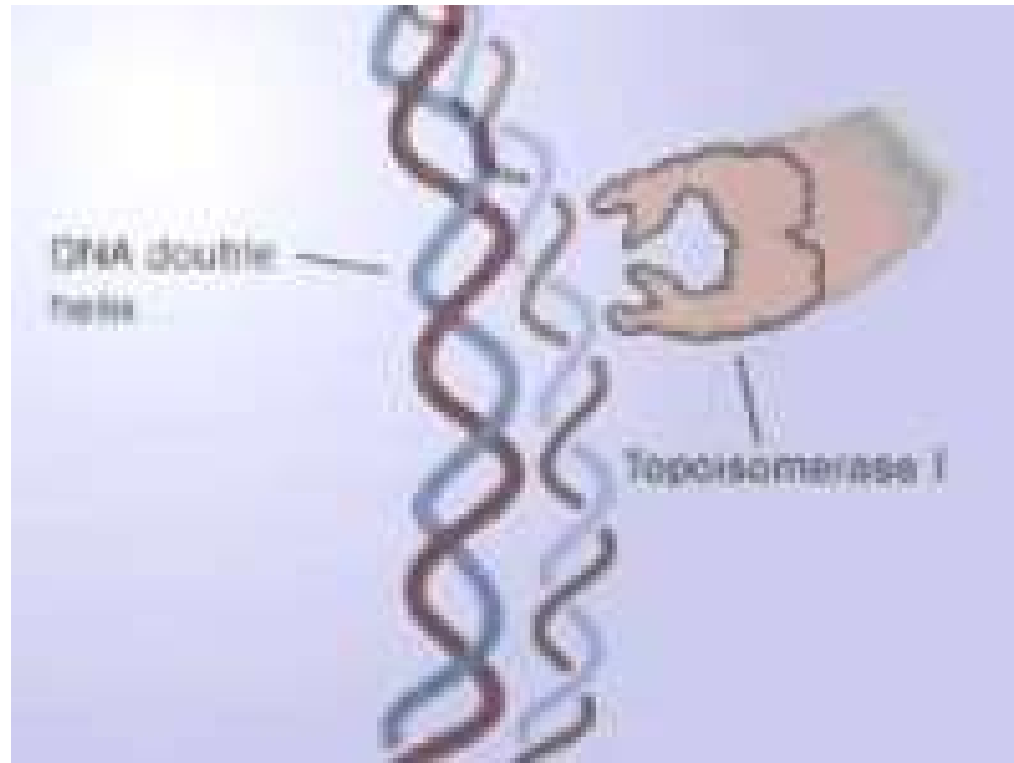

DNA organization in regulation of transcription

- Eukaryotic DNA is linear and double-stranded.
- It binds to protein scaffolding.
- Generates superhelixes, solenoid loops and relaxed areas.

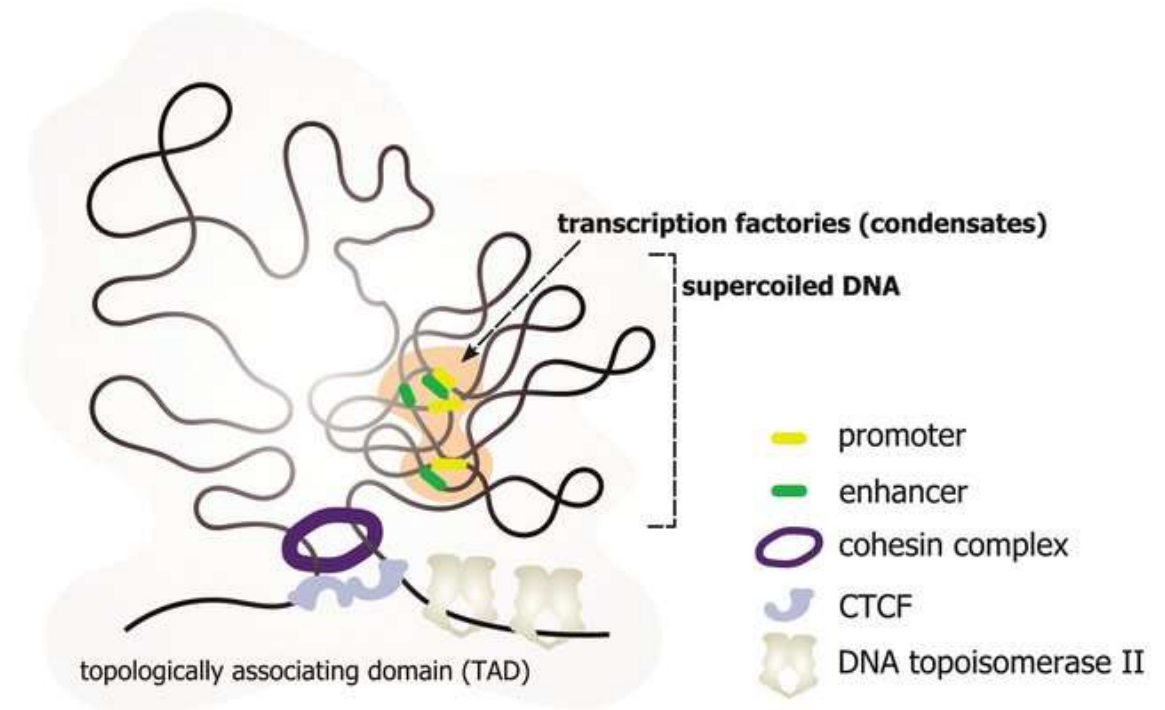
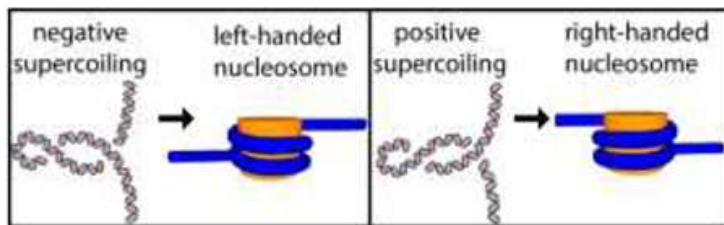

DNA sequences adopting alternative structures

- Unique DNA sequence:AATGCTGATGTCTGACTCGGA...
- Repetitive sequences or repeat.
- Terms: unit of repetition, length of unit of repetition, frequency of repetition.
- Example: ATG... ATG....ATG....ATG...unit = ATG, length = 3 nucleotides, frequency = 4x.
- **Tandem** repeats – tied tightly to each other "head to toe"..
ATGCATGCATGC..
- **Direct** repetition ($5' \dots \text{ATGC} \dots \text{ATGC} \dots 3'$) repeats on the same strings in the same direction ($5' 3'$).

DNA sequences adopting alternative structures

- Inverted repetition: repeated on the second string in the reverse direction - potential for creating a hairpin or hairpin with a loop.

5' ...ATGCGCAT...3'
3' ...TACGCGTA...5'

palindrome (hairpin/hairpin with loop)

5' ...ATGCXXXXXGCAT...3'
3' ...TACGYYYYYCGTA...5'

hairpin with loops (within dsDNA the cross structure is established)

LTR - long terminal repeat

5'-ATGC...GCAT.....ATGC...GCAT-3'
3'-TACG...CGTA.....TACG...CGTA-5'

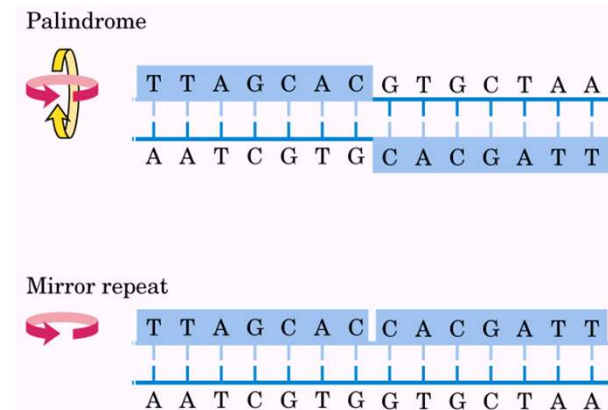

Scheme of hairpin structure

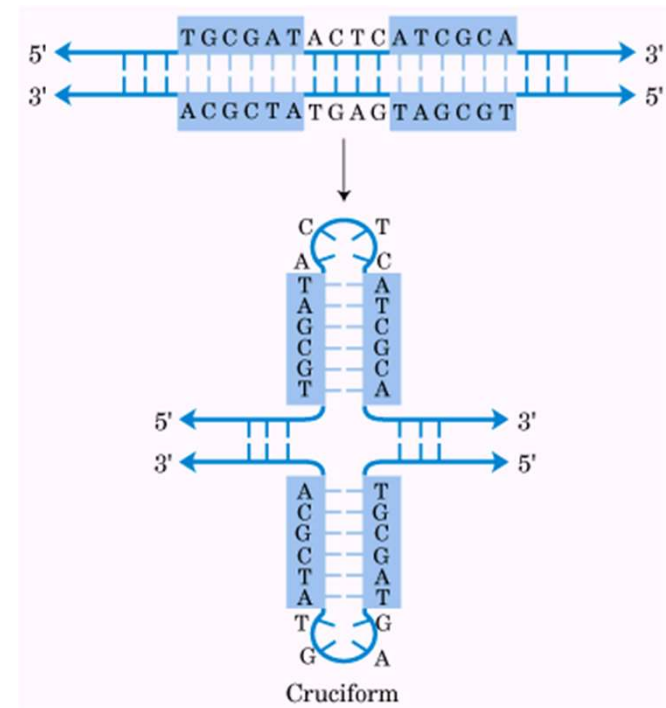
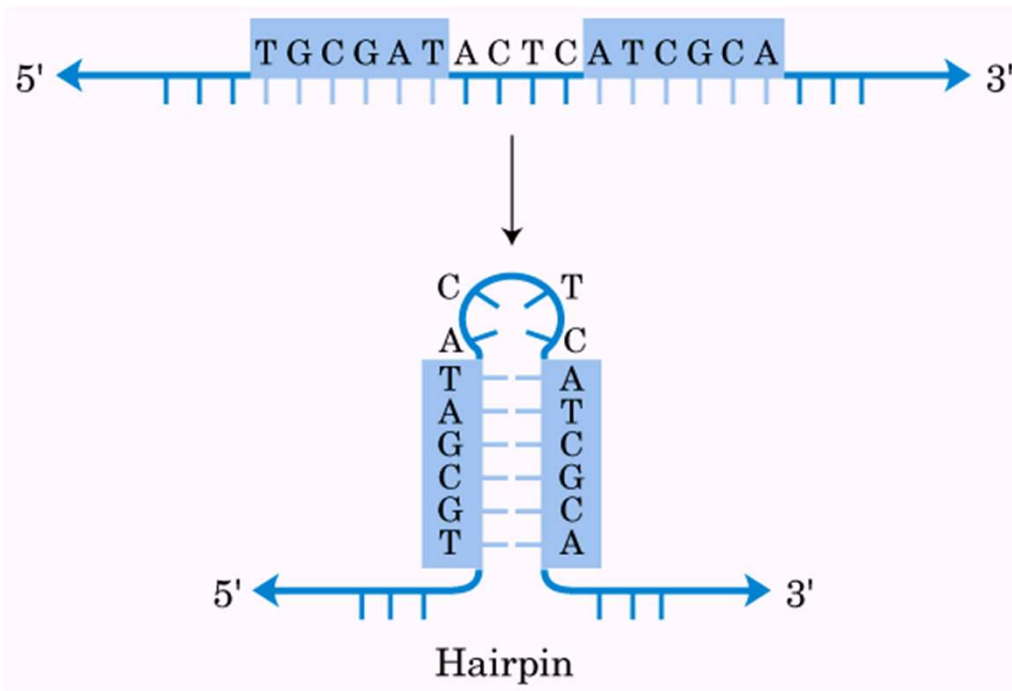

Denaturation and Renaturation of DNA and RNA

- DNA is a highly stable molecule.
- Non-covalent hydrogen bonds between the 2 complementary strands can be broken. The DNA strands can be separated.
- This is called denaturation.

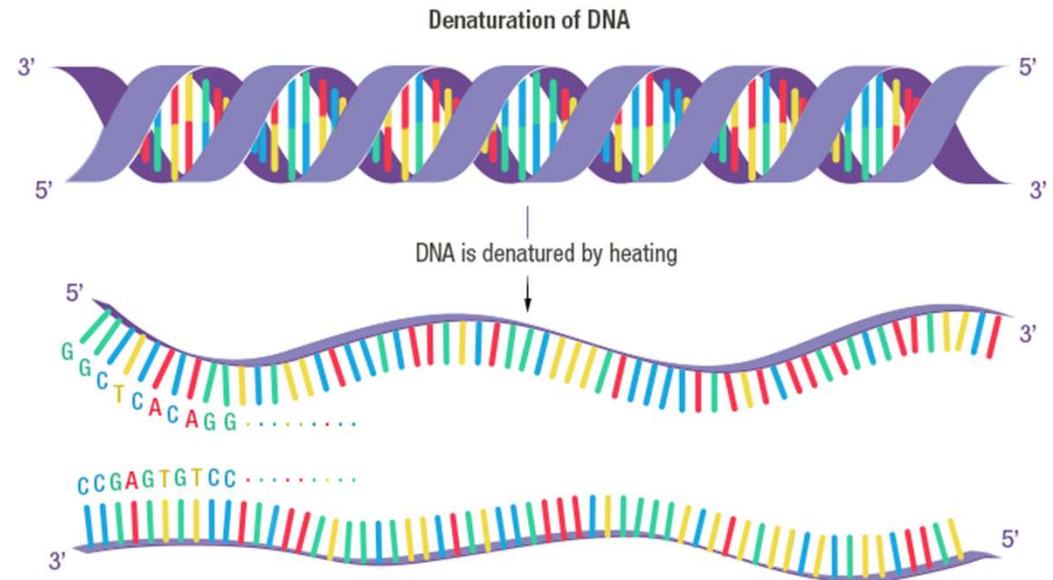

Denaturation and Renaturation of DNA and RNA

- **Denaturation** of dsDNA = transformation of dsDNA into ssDNA.
- **Renaturation** of ssDNA = transformation of ssDNA into dsDNA.
- Induction of denaturation:
 - by increasing the temperature of the solution,
 - by changing the pH from neutral to alkaline or acidic.
- Occurs *in vitro* and naturally also *in vivo*.

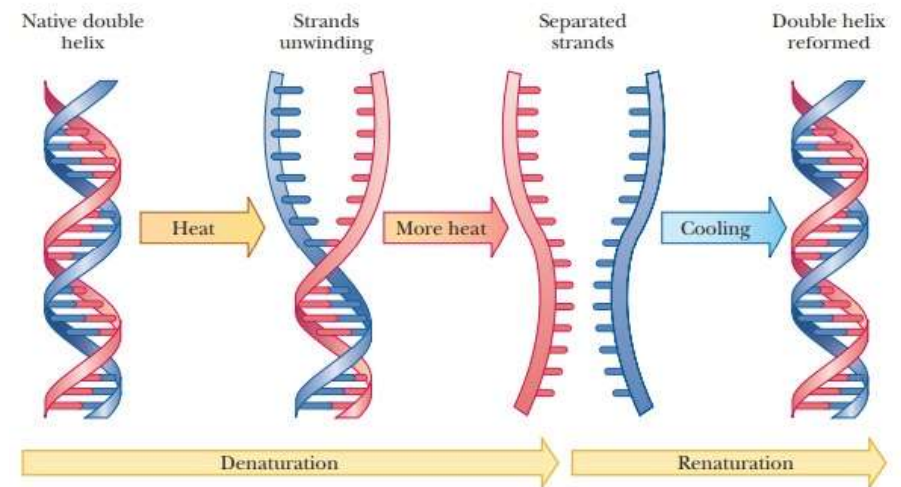

■ **FIGURE 9.19 Helix unwinding in DNA denaturation.** The double helix unwinds when DNA is denatured, with eventual separation of the strands. The double helix is re-formed on renaturation with slow cooling and annealing.

Denaturation and Renaturation of DNA and RNA

- dsDNA denaturation is manifested by hyperchromic effect, which means increased absorbance of UV-light with a wavelength 260 nm.
- Value T_m or melting point = temperature, in which 50% of dsDNA molecules are denatured.
- T_m depends on the content of the bases.

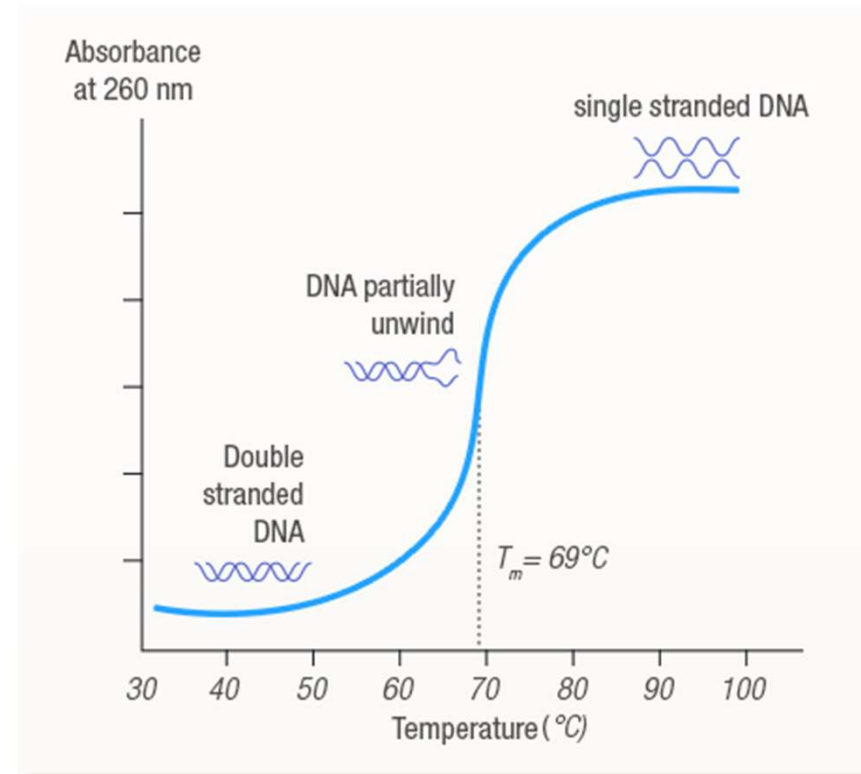

Denaturation curve

Other options for determining %GC:

- Ultracentrifugation in CsCl
- HPLC.

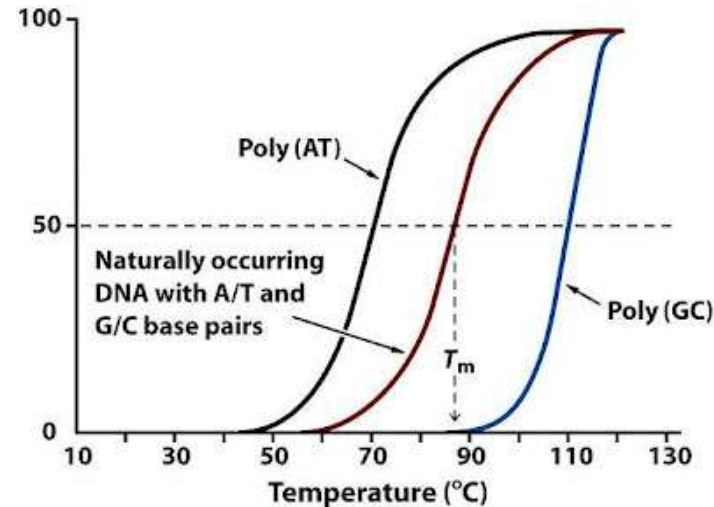

$$T_m = 69,3 + 0,41 (GC).$$

$$GC = \frac{T_m - 69,3}{0,41}$$

- GC = molar fraction of guanine and cytosine in DNA,
- 69.3 and 0.41 are empirically the coefficients laid down,
- pro poly(AT) $T_m = 69,3$.

Hybridization of DNA and RNA

- Hybridization is the process of combining two complementary single-stranded DNA or RNA molecules and allowing them to form a single double-stranded molecule through base pairing.
- The more hybridizing molecules coincide in sequences, or the higher their sequential homology, the greater it is the probability of their hybridization.

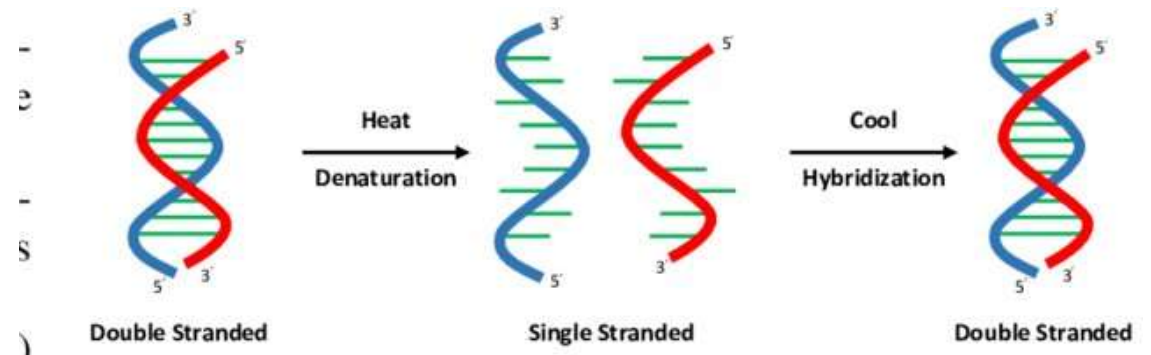

Hybridization of DNA and RNA

- Use for evaluation of the degree of sequential/structural similarity of DNA without sequencing.

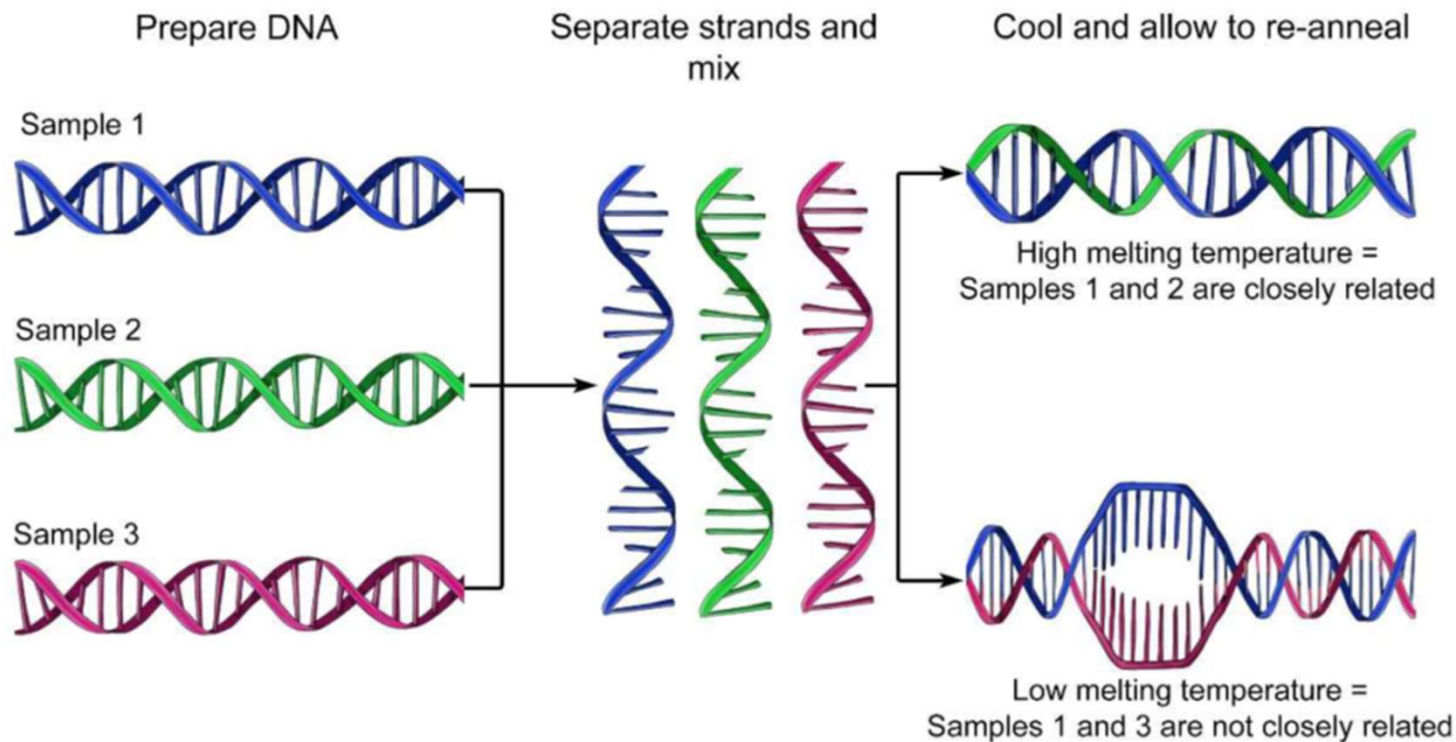

Hybridization of DNA and RNA

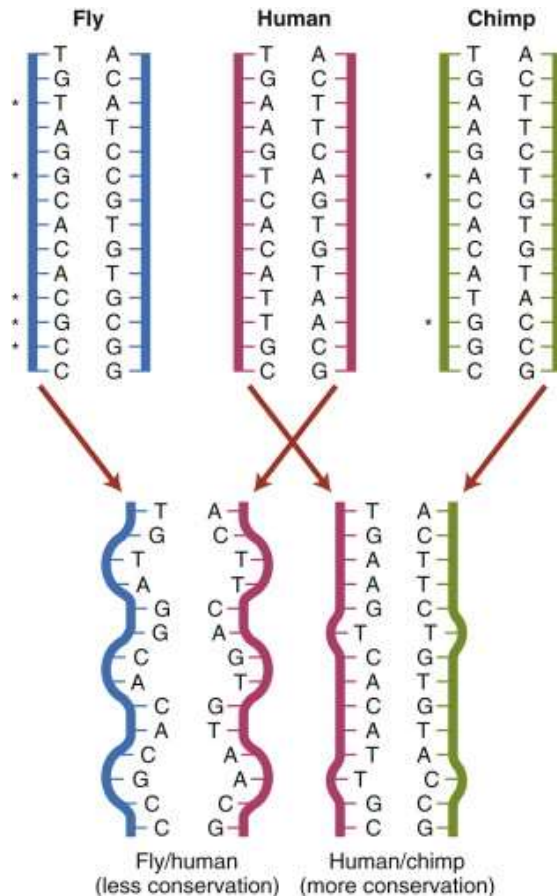

- Double-helical DNA from two species is unwound (denatured), cut, and mixed.
- Complementary pieces bind (called reannealing), forming some hybrid DNAs—one strand from each species.
- Then the temperature is raised and the rate of interspecies double-helix separation determined.
- The higher the temperature needed to separate the hybrid DNA, the more similar the DNA sequences must be.

Usage of Hybridization in the reasearch

- Identification of specific DNA a RNA sequences.
- Estimation of their structural similarity.
- PCR.
- Transcription *in vitro*.
- FISH.

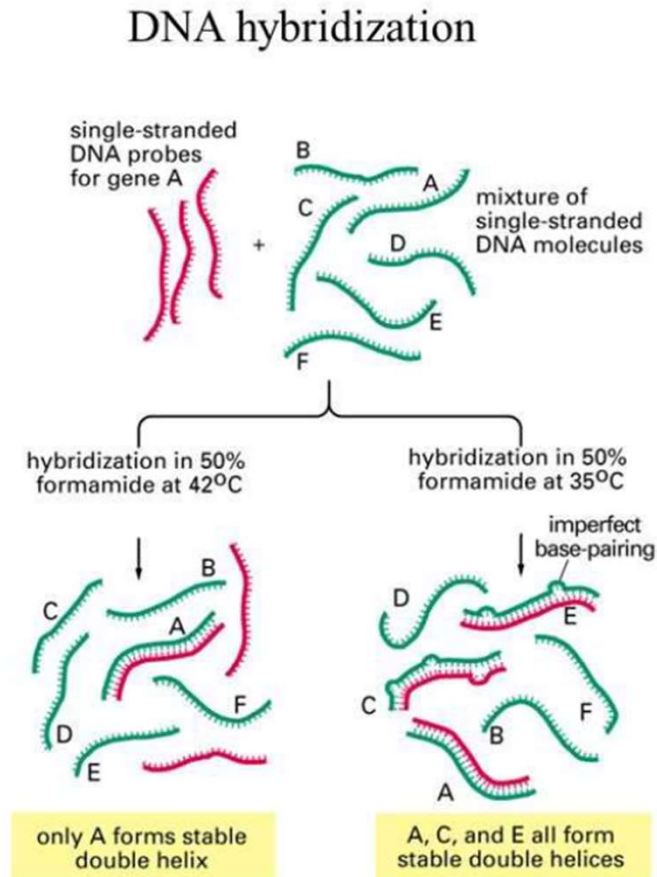
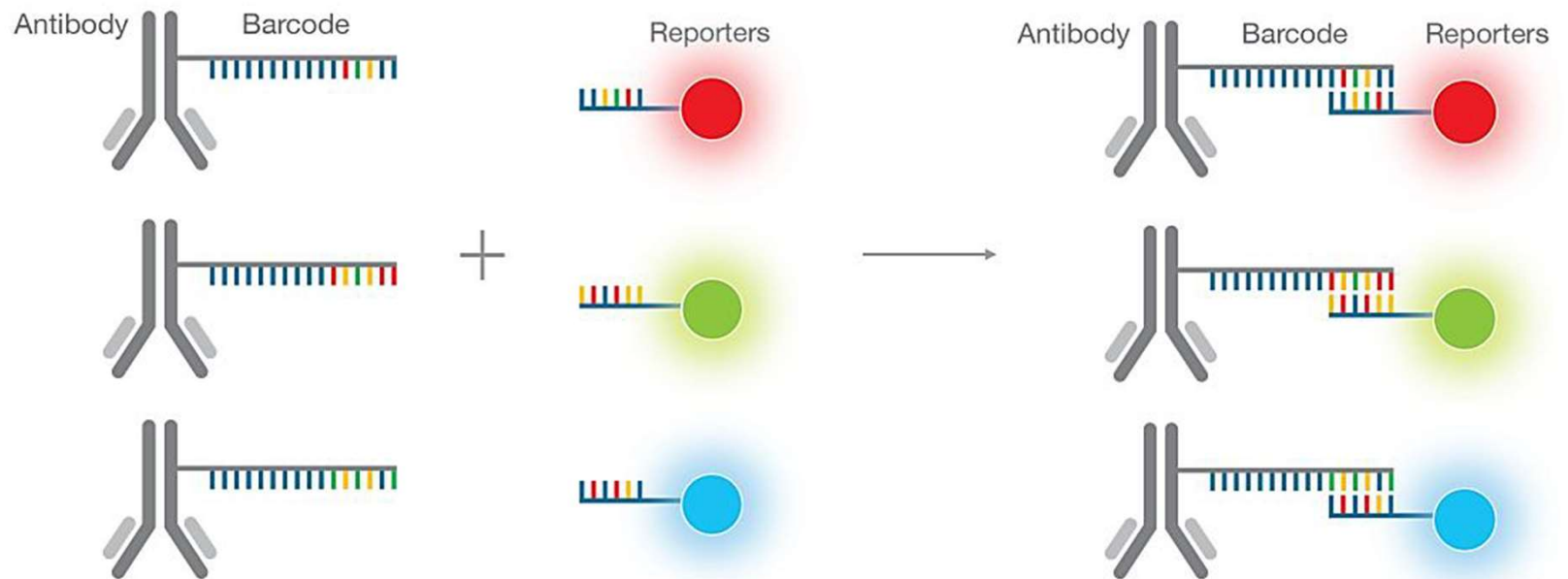
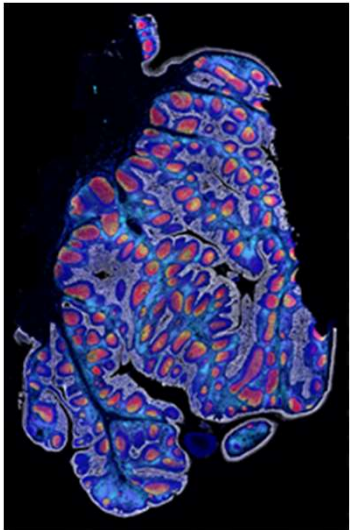

Figure 8-25. Molecular Biology of the Cell, 4th Edition.

Usage of Hybridization in the reasearch

Codex System



Akoya Biosystems

THANK YOU FOR YOUR ATTENTION

