

MUNI
SCI

Bi4025en

Molecular Biology

Mgr. Jiří Kohoutek, Ph.D.

Lecture 3

- Molecular structure and replication of procaryotic and eukaryotic genomes.

Order versus chaos

- Cells maintain a high degree of orderliness in a disordered universe.
- This property is largely due to their capabilities to **duplicate** their **genetic information** with great **precision**.
- The same genetic information divided into daughter cells ensures their similarity.
- Reproduction of the chemical information in DNA – replication.

Replication of nucleic acids

- **Replication** is a biological **process of duplicating or producing an exact copy**, such as a polynucleotide strand of DNA. Creation of replicas (copies).
- It is a molecular process taking place in dividing cells, by which the **DNA creates a copy of itself**.
- Human speed of replication: 3 000 nucleotides/min.
- Bacterial speed of replication: 30,000 nucleotides/min.
- Accuracy: one error per 10^9 embedded nucleotides.

Stability of the genome

- Individual survival requires a high degree of genetic stability.
- If the **change** occurs **in the DNA** and the repair mechanisms do not correct it, then, it becomes permanent – referred to as **mutation**.
- If the **mutation** is located within some area of DNA important for life, it **can cause disease** of the organism or even its death.

Frequencies of mutations in bacteria

LOW

Can be determined experimentally:

- *E. coli* in laboratory conditions divides once every 30 minutes.
- One cell in less than a day creates a population of several billion cells.
- Only a fraction of cells in which a mutation has occurred in a certain nonessential gene can be found .

- Conclusion:
- A gene of average size (about a thousand nucleotide pairs) is affected approximately 1x in 10^6 bacterial generations.
- Mutation rate in bacteria: about 3 nucleotide changes per 10^{10} nucleotides per 1 cell generation.

Frequencies of mutations in humans

- The **mutation rate** adjusted to one round of DNA replication is **extremely low** in both **bacteria** and **humans**.

Table 6–1 Error Rates

US Postal Service on-time delivery of local first-class mail	13 late deliveries per 100 parcels
Airline luggage system	1 lost bag per 200
A professional typist typing at 120 words per minute	1 mistake per 250 characters
Driving a car in the United States	1 death per 10^4 people per year
DNA replication (without mismatch repair)	1 mistake per 10^7 nucleotides copied
DNA replication (including mismatch repair)	1 mistake per 10^9 nucleotides copied

Principles of DNA replication

- **Strands** in DNA helix duplexes are **complementary**: after separation, each of them can serve as template for the synthesis of new strand.
- **New strands** are created through gradual **integration of nucleotides** based on base **pairing** rules.
- DNA replication is catalyzed by an **enzymes**.
- Once replication is finished, each template strand is paired with a newly synthesized strand.

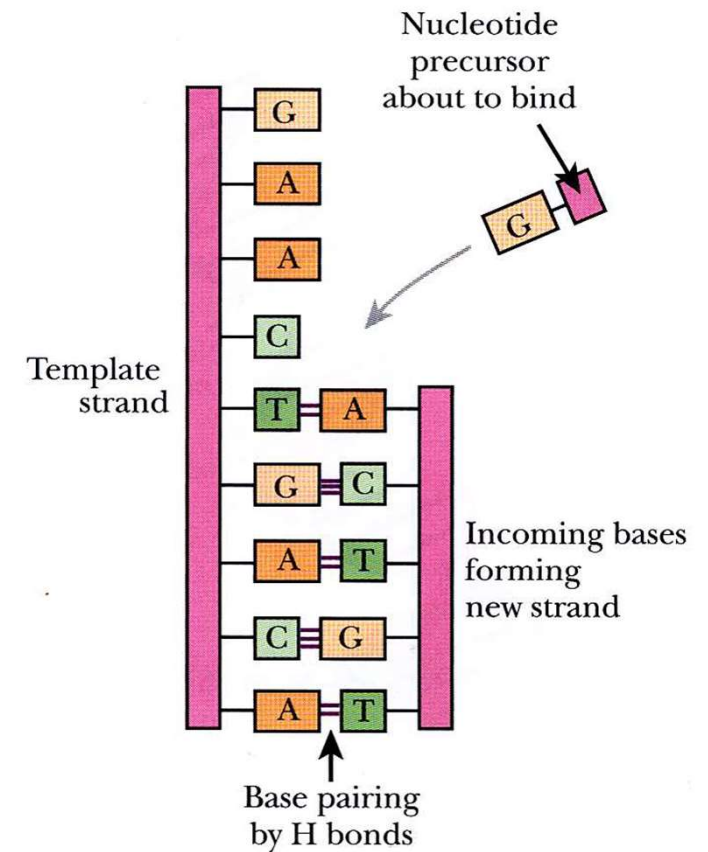

Replication occurs in the S-phase of cell cycle

- Replication cannot occur repeatedly within one cell cycle (similar to other phases).
- DNA must be replicated before the cell divides in Mitosis to ensure the new cells have DNA.
- DNA is replicated during the S-phase of the cell cycle.

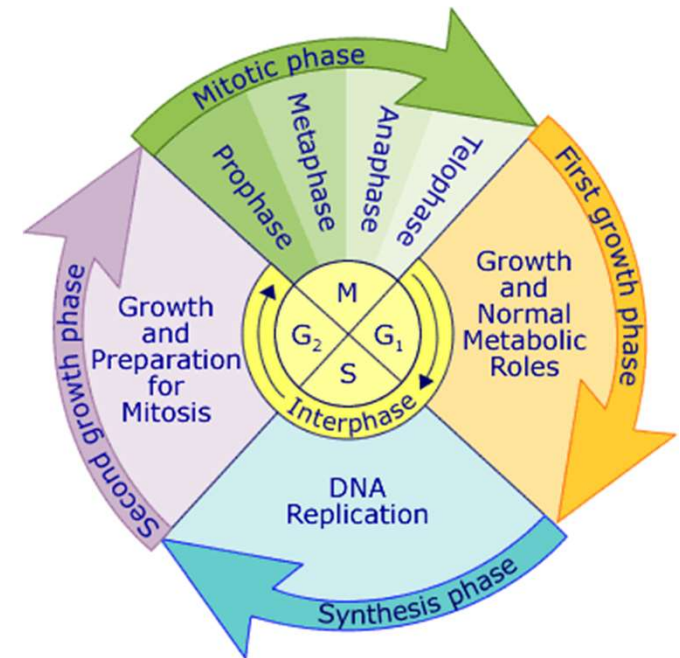

Models of DNA replication

- In the **conservative model**, the parental molecule directs synthesis of an entirely new double-stranded molecule, such that after one round of replication, **one molecule is conserved as two old strands**.
- This is repeated in the second round.

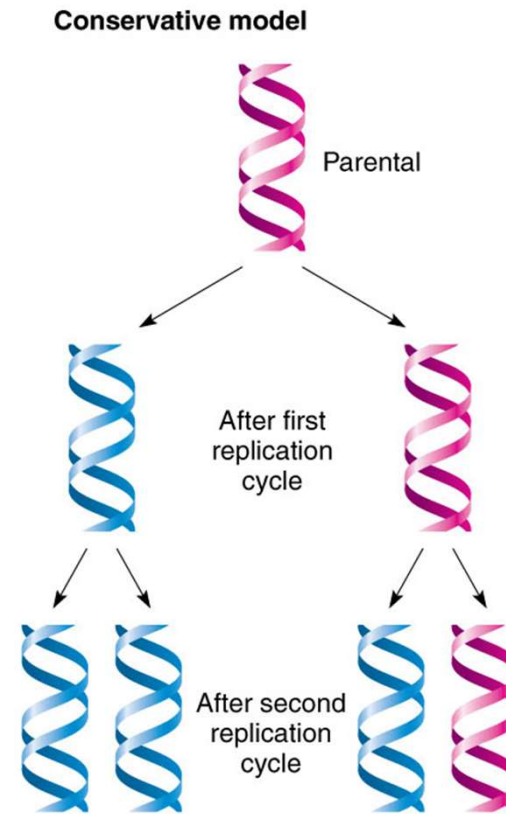

Models of DNA replication

- In the **dispersive model**, material in the two parental strands is distributed more or less randomly between two daughter molecules.
- In the model shown here, old material is distributed symmetrically between the two daughters molecules, yet other distributions are possible.

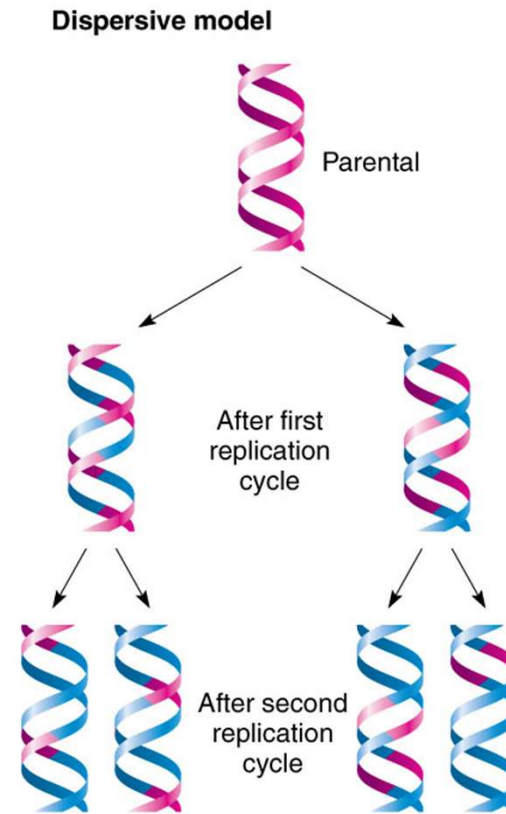

Models of DNA replication

- In the **semi-conservative** model, the two parental strands separate and each makes a copy of itself.
- After one round of replication, the two **daughter molecules** each comprises **one old and one new strand**.
- Note that after two rounds, two of the DNA molecules consist only of new material, while the other two contain one old and one new strand.

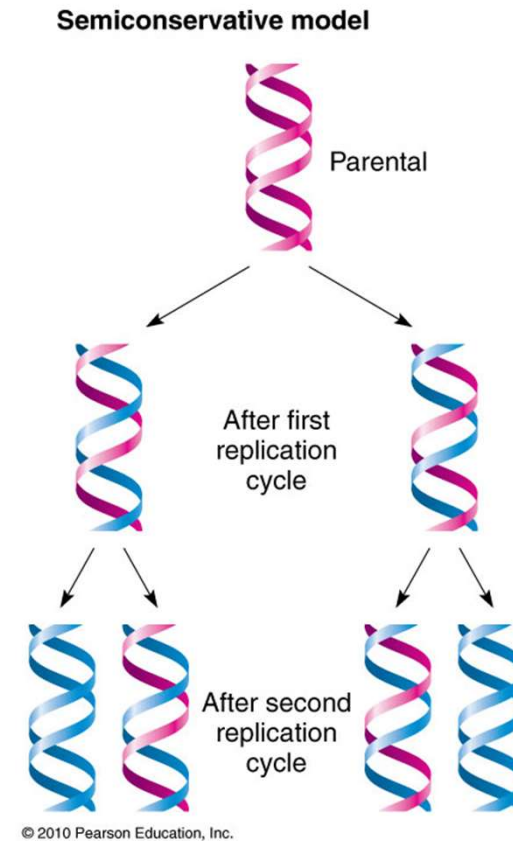

DNA replication is semi-conservative process

- In 1958 the **semi-conservative model of replication**, proposed by Watson and Crick in 1953, was proved.
- Evidence based on the study of DNA density after marking with heavy nitrogen N^{15} .



Matthew Meselson

Franklin Stahl

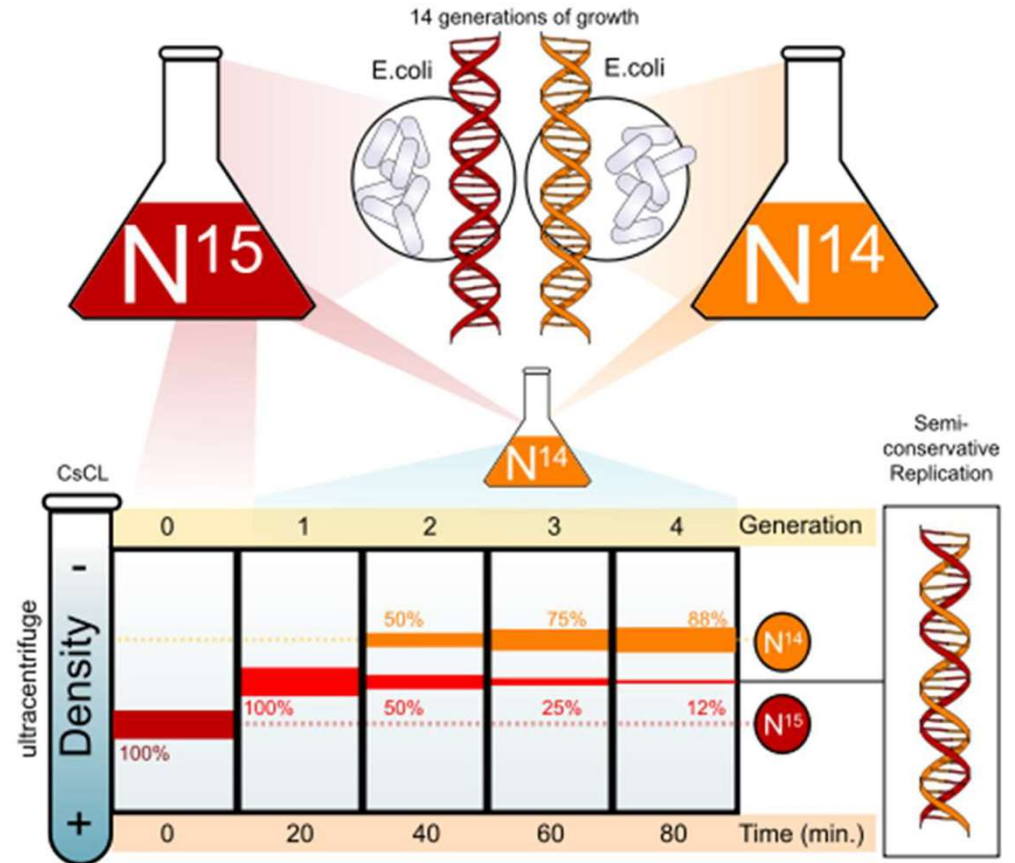

DNA replication is semi-conservative process

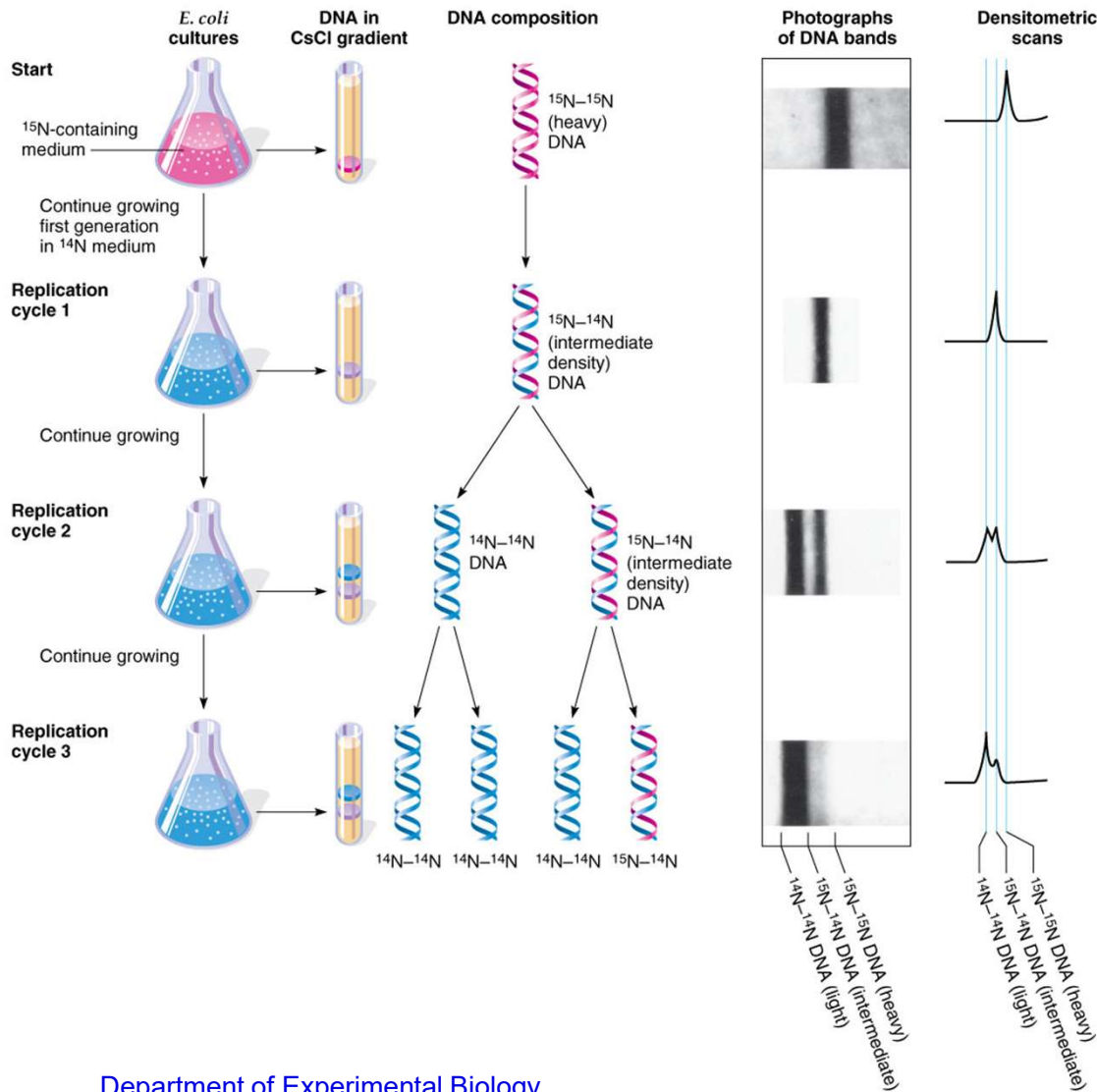
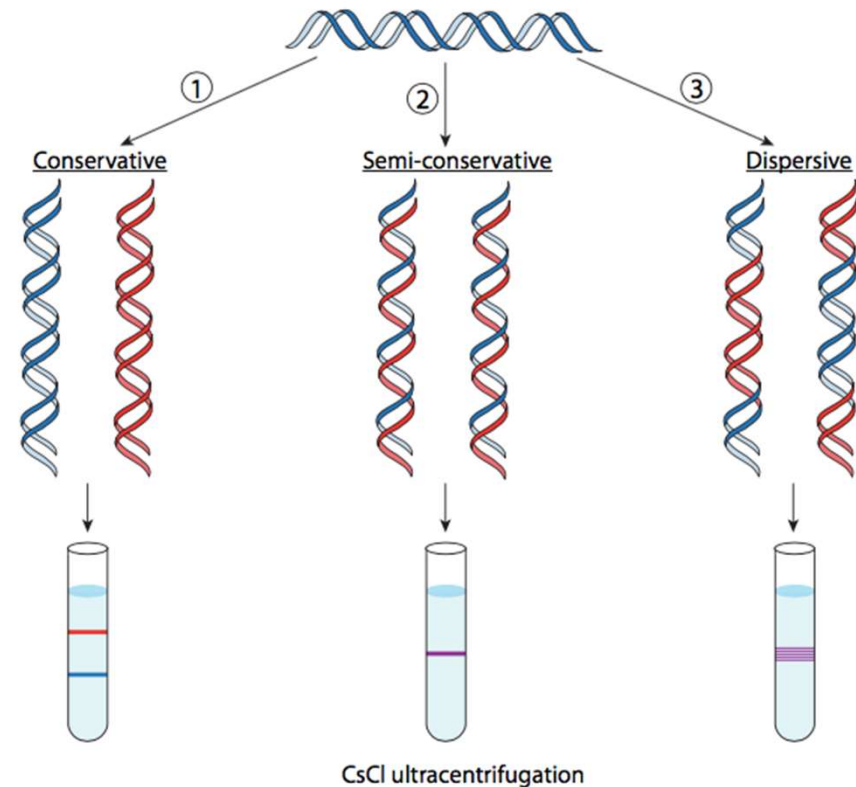

FIGURE 9-3. (Left) Matthew Meselson (b. 1930). (Right) Franklin W. Stahl (b. 1929). [Courtesy of M. Meselson.]

https://www.mun.ca/biology/scarr/iGen3_03-02.html

DNA replication is semi-conservative process

- 1) Conservative:
 - no molecules with hybrid density.
- 2) Semi-conservative:
 - there is hybrid density.
- 3) Dispersive:
 - gradually decreasing hybrid density.



Basic characteristics of DNA replication

- DNA replication is **Semi-conservative**.
- Both dsDNA strands serve as templates.
- The result of DNA replication is a **double helix** containing **one original** and **one newly synthesized** strand.
- Each parental strand remains preserved.
- The original strands remain intact for many generations.

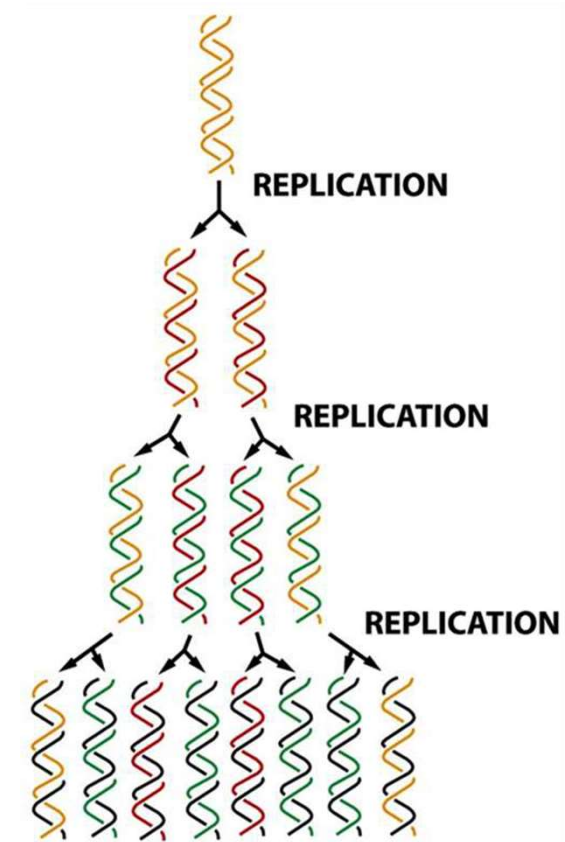

DNA replication – biochemical view

- **Replication** is a process of **producing an exact copy** of polynucleotide strand of DNA.
- New strands are created through gradual integration of nucleotides based on base pairing rules.
- DNA polymerase is the key enzyme catalyzing the synthesis of the DNA strand.

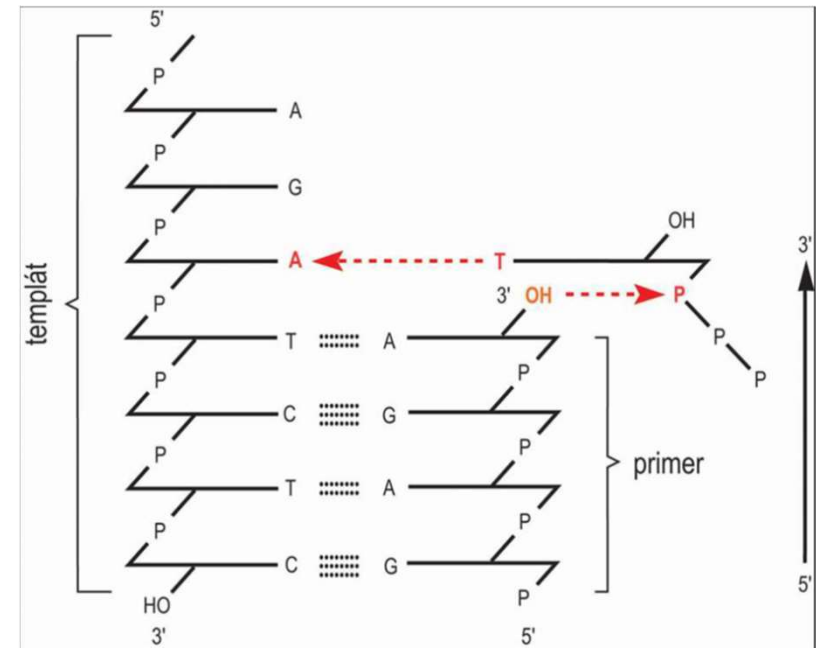

Basic characteristics of DNA replication

- DNA replication is **Semi-discontinuous**.
- Continuous Replication:
 - It occurs on the **leading strand**.
 - Progresses from 5' end to 3' end in the direction of the replication fork.
 - *In vivo* no need for RNA primer.
- Discontinuous Replication:
 - It progresses opposite to the leading strand on the **lagging strand** from 3' end to 5' end.
 - It starts somewhere in the DNA and away from the replication fork.
 - Needs **RNA primers**.

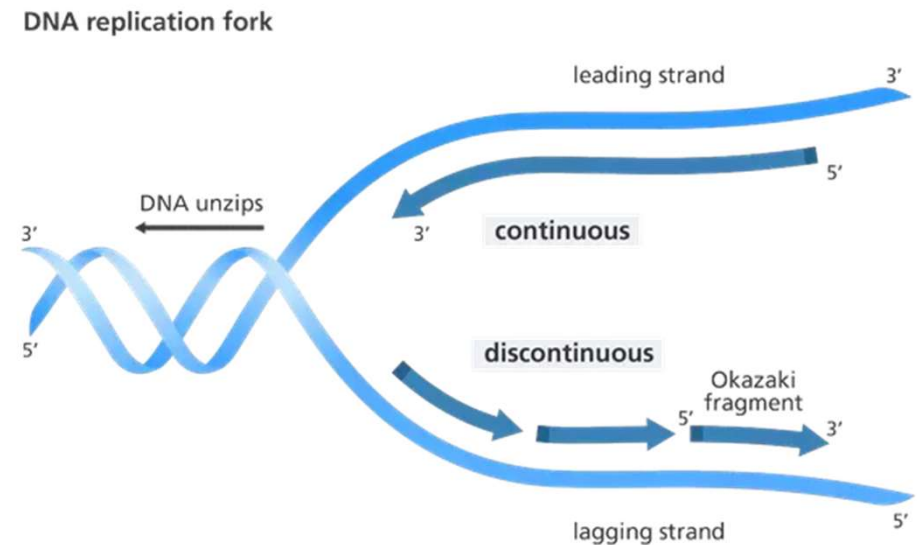

Okazaki's fragments

- Explorers:
- Reiji Okazaki (1930-1975) and his wife Tsuneko Okazaki (*1933).
- Nagoya University, Japan.
- Reiji died prematurely of leukemia- The result of the radiation exposure of the Hiroshima bombing.
- Tsuneko – first woman professor in Nagoya University.



Basic characteristics of DNA replication

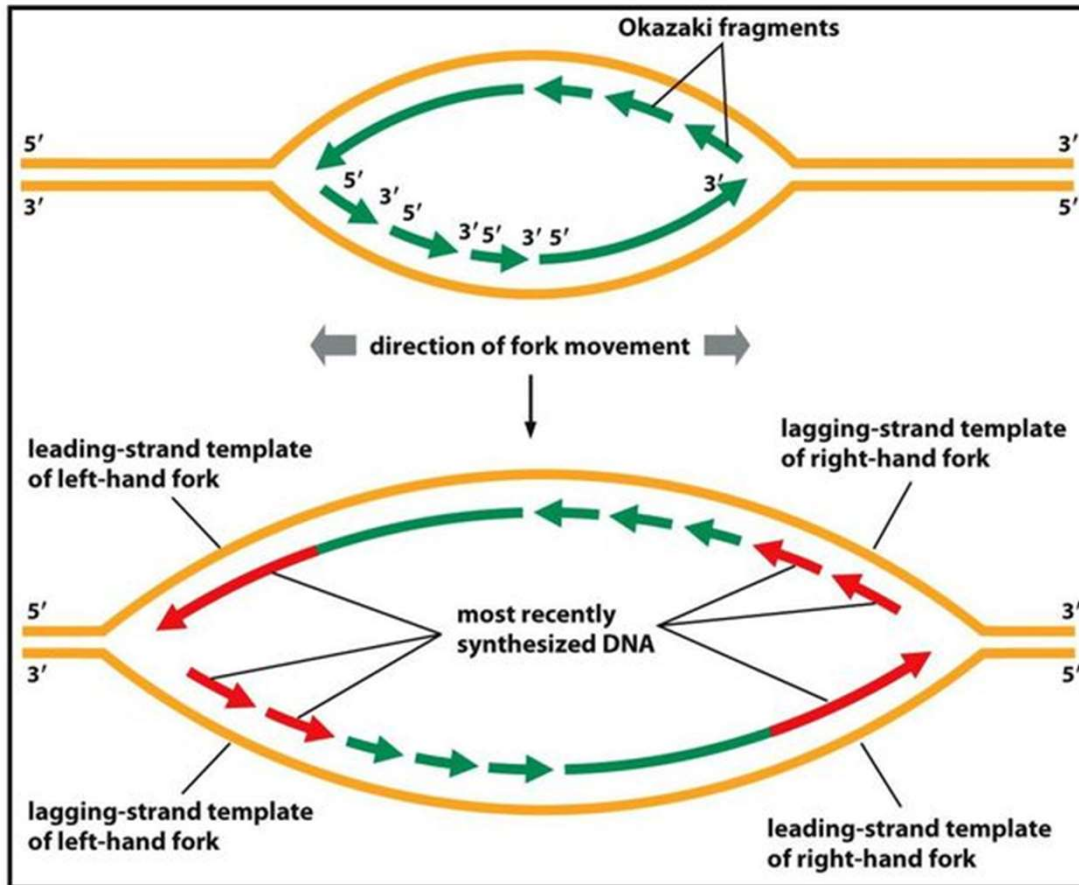

- DNA polymerase catalyzes the growth of the new DNA strand in 5' to 3' direction.
- Thus DNA replication is **asymmetrical**, due to **continuous** and **discontinuous** synthesis of new DNA strand at the tip of replication fork.

Beginning of DNA replication

- Initiation of DNA replication takes place in specific places – „origins of replication“.
- From the beginning DNA replication takes place in **both directions** (always in the direction of 5′ - 3′).
- Each beginning ensures replication of a stretch of DNA called a „**replicon**“.
- In bacteria and viruses, there is usually **1 origin** per chromosome (prokaryotic chromosomes form a single replicon).
- In large eukaryotes chromosomes, there are **many origins** of replication (many replicons).

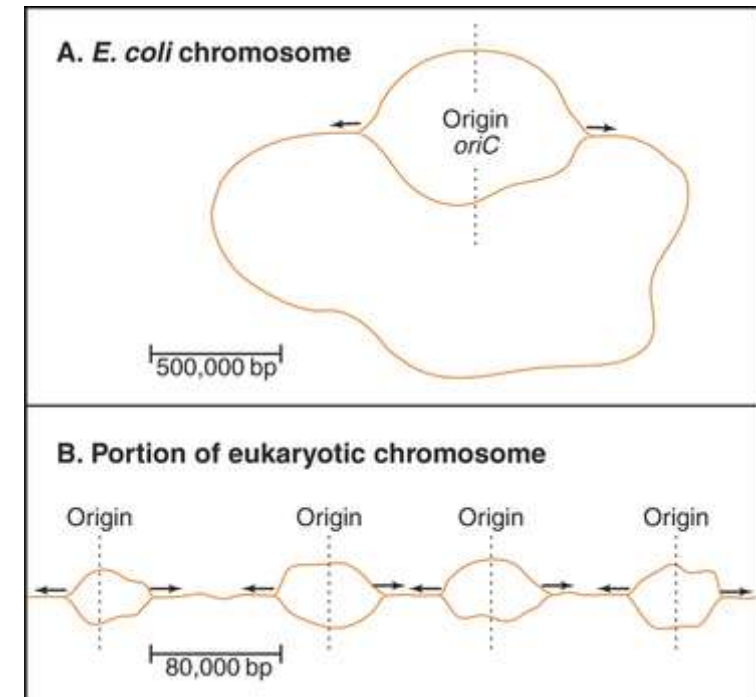

Beginning of DNA replication

- Once DNA is released at the *ori* (origin of replication) site by the action of **helicases**, the template strands are continuously separated and a **replication bubble** is formed.
- Replication **proceeds** from this point **in both directions** and a structure of "Y- shape" is formed and is called **replication fork**.
- Movement of the replication fork is coordinated with metabolic processes responsible for the synthesis of dNTPs.

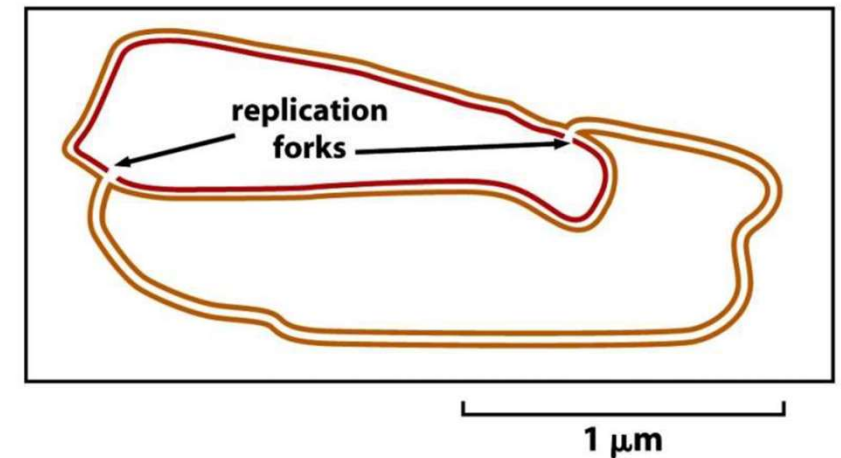
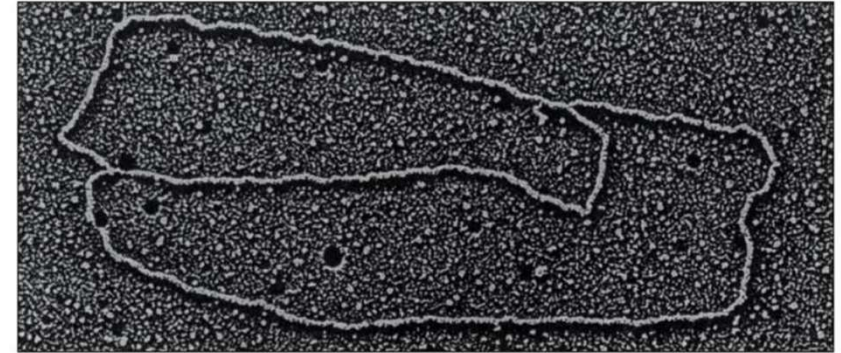

Beginning of DNA replication

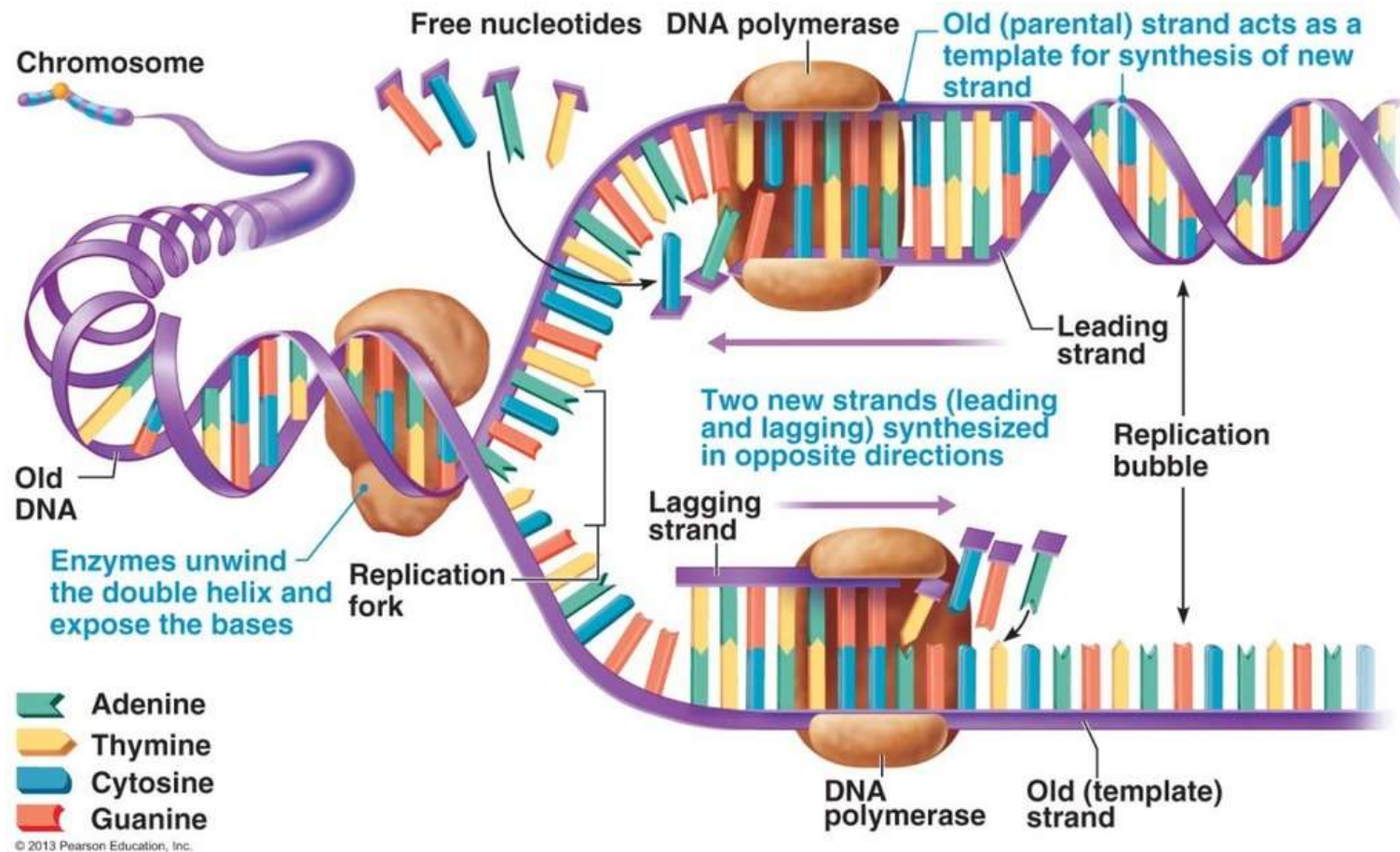

Replisome

- The **replisome** is a large protein complex that carries out DNA replication, starting at the replication origin.
- It contains several proteins with enzymatic activities:
 - Helicase
 - Primase
 - DNA polymerase
 - Exonuclease
 - Topoisomerase

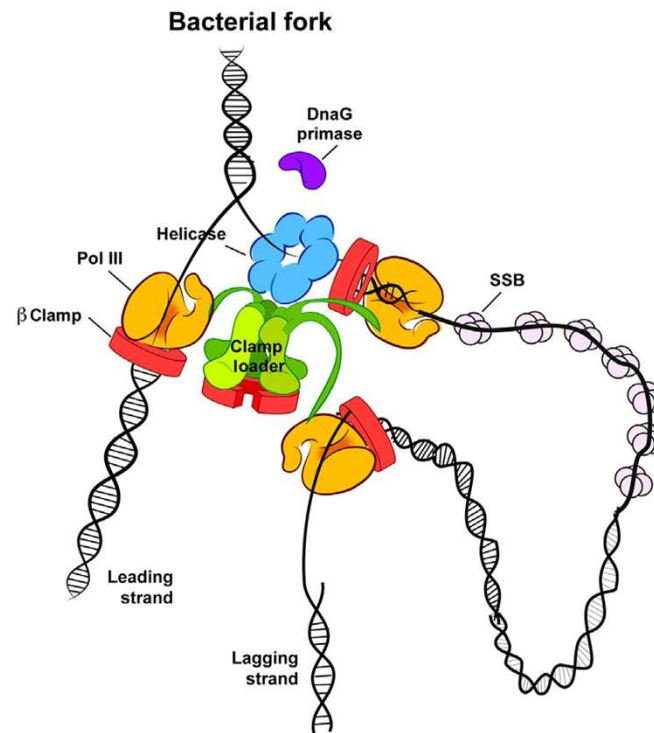

Parts of DNA replication complex

- Template (matrix strand) = parent molecule.
- Nucleotides (dNTP).
- Primer = short oligoribonucleotide with free 3'-OH end.
- Enzymes catalyzing the joining of nucleotides
 - Primase
 - Polymerase
 - Ligase.

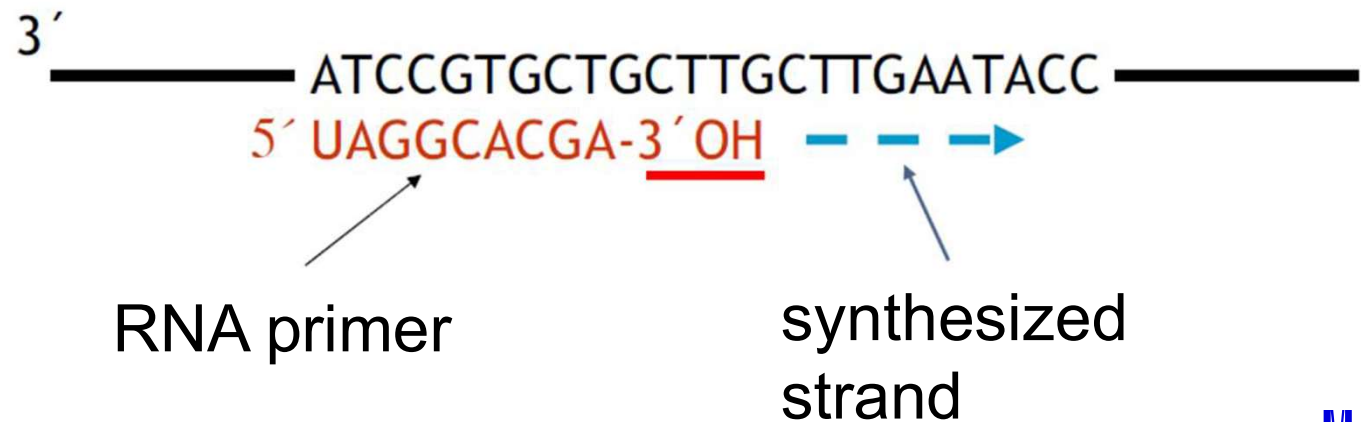

DNA replication phases

- Steps involved in DNA replication:
- Initiation
- Elongation
- Termination.

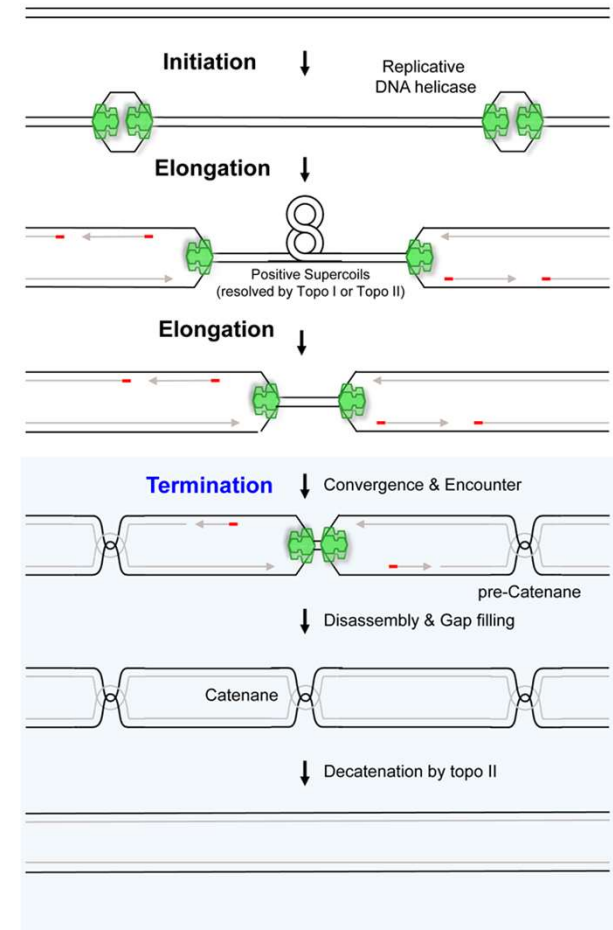

- Prokaryotic DNA replication

Initiation phase - origin of DNA replication

- The specific sequence called *oriC* in bacteria is recognized by a *DnaA* factor.
- Size 245 pb.
- Present in the genome 1x.
- Two types of repeating Sequences:
 - sequence 13 pb (repeated 3 times, rich in AT, place of loosening),
 - sequence 9 pb (repeated 4 times, binding region of proteins, which are necessary for the formation of a replication bubble).

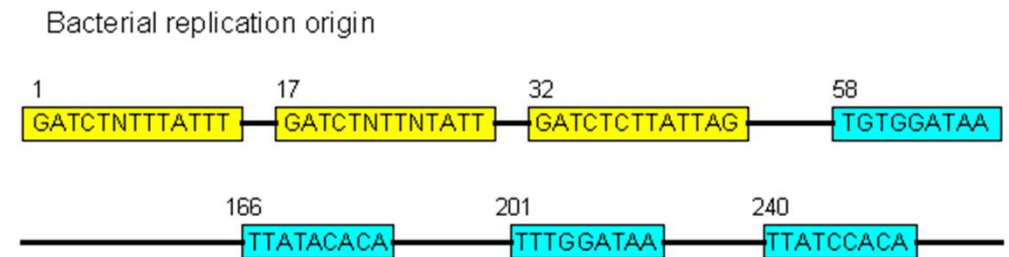

Initiation phase – unwinding

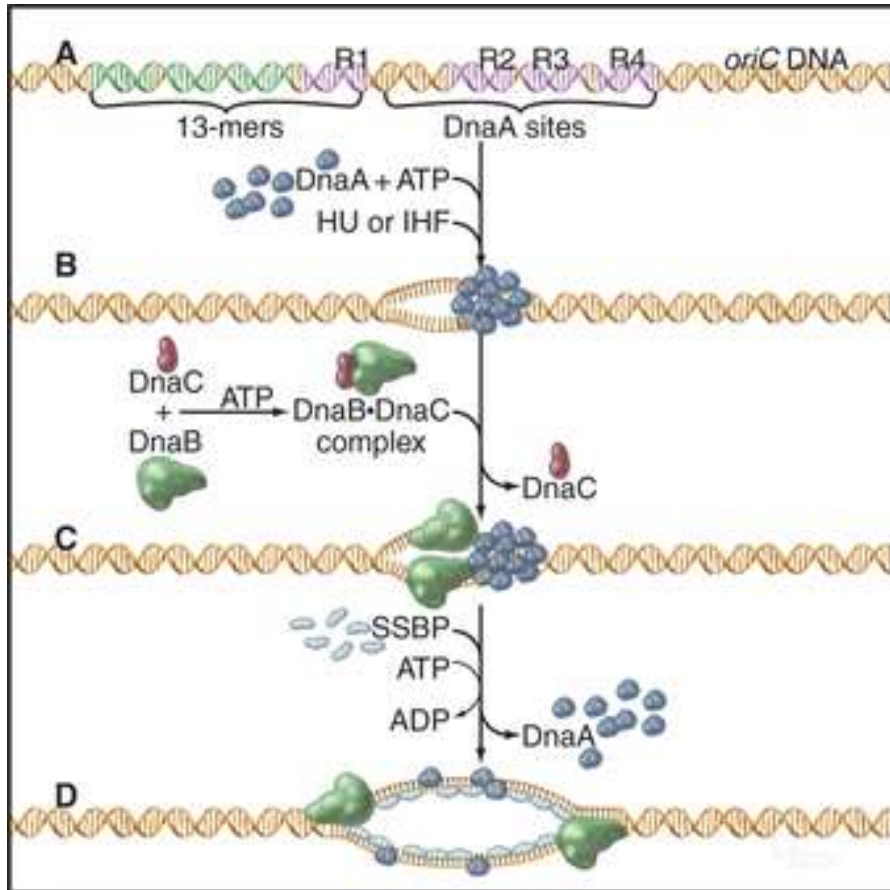

- An initiator protein (product of the *E. coli* *DnaA* gene) binds to this origin and either directly or indirectly.
- **DnaA promotes melting** of the DNA duplex, giving the replication machinery access to two single strands of DNA.
- **DnaB / helicase unwinds** *oriC* (origin of replication) and extends the single stranded region for copying.

Initiation phase – binding of SSB proteins

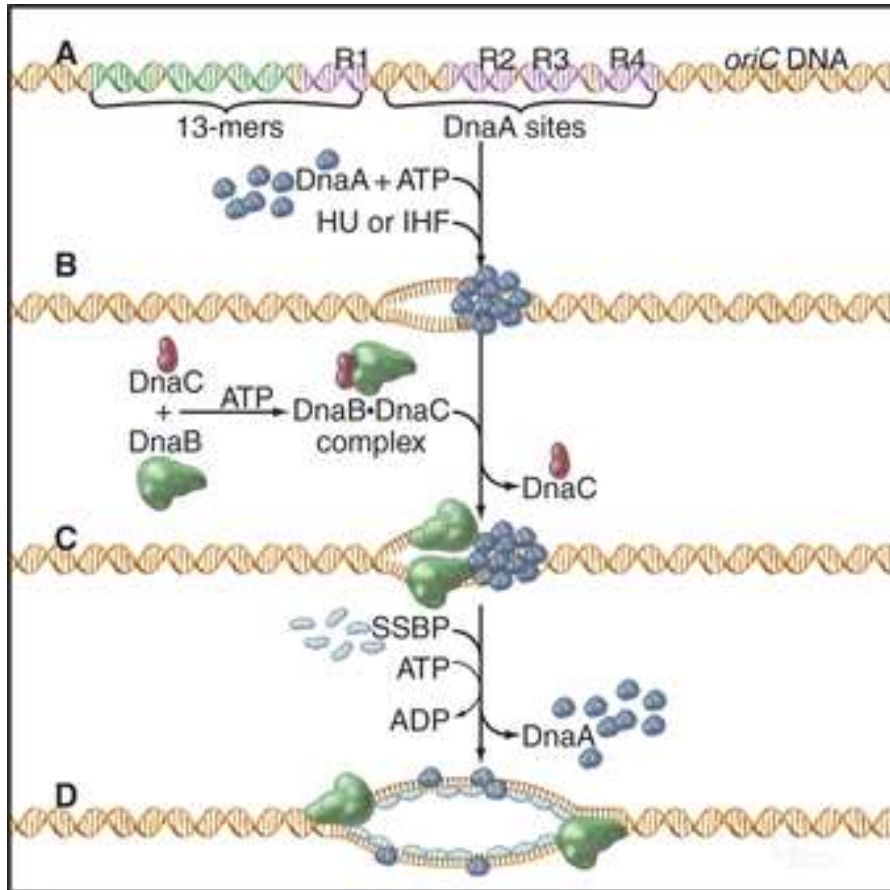

- Single strand binding protein (SSB) binds to this single stranded region to **protect it from breakage** and to prevent it from renaturing.
- Other factors bind to the initiator, and their concerted action produces a wave of DNA replication proceeding outward in both directions along the DNA (a replication “bubble”).
- As the parental DNA is unwound by DNA helicases and SSB (travels in **5'-3' direction**).

Initiation phase – DNA twisting issue

- DNA rotates in front of the replication fork due to unwinding of DNA helix. The unwinding of DNA leads to the formation of „positive supercoiled loops“.
- The resulting positive supercoiling (torsional stress) is relieved by **topoisomerase I and II** (DNA gyrase) by inducing transient single or double stranded breaks.

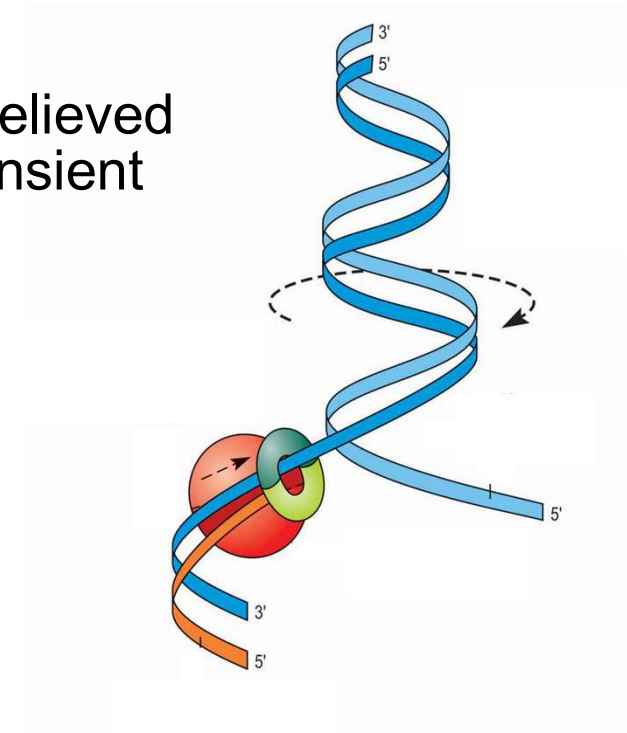
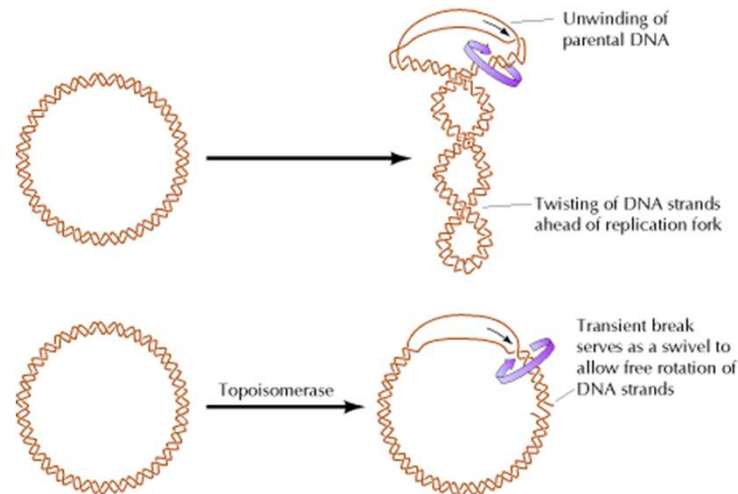

Elongation phase – Leading strand

Leading strand synthesis:

- On the template strand with 3'-5' orientation, new DNA is made continuously in **5'-3' direction** towards the replication fork. The new strand that is continuously synthesized in 5'-3' direction is the **leading strand**.
- **DNA polymerase III extends the RNA primer made by primase.** DNA polymerase possesses separate catalytic sites for polymerization and degradation of nucleic acid strands.

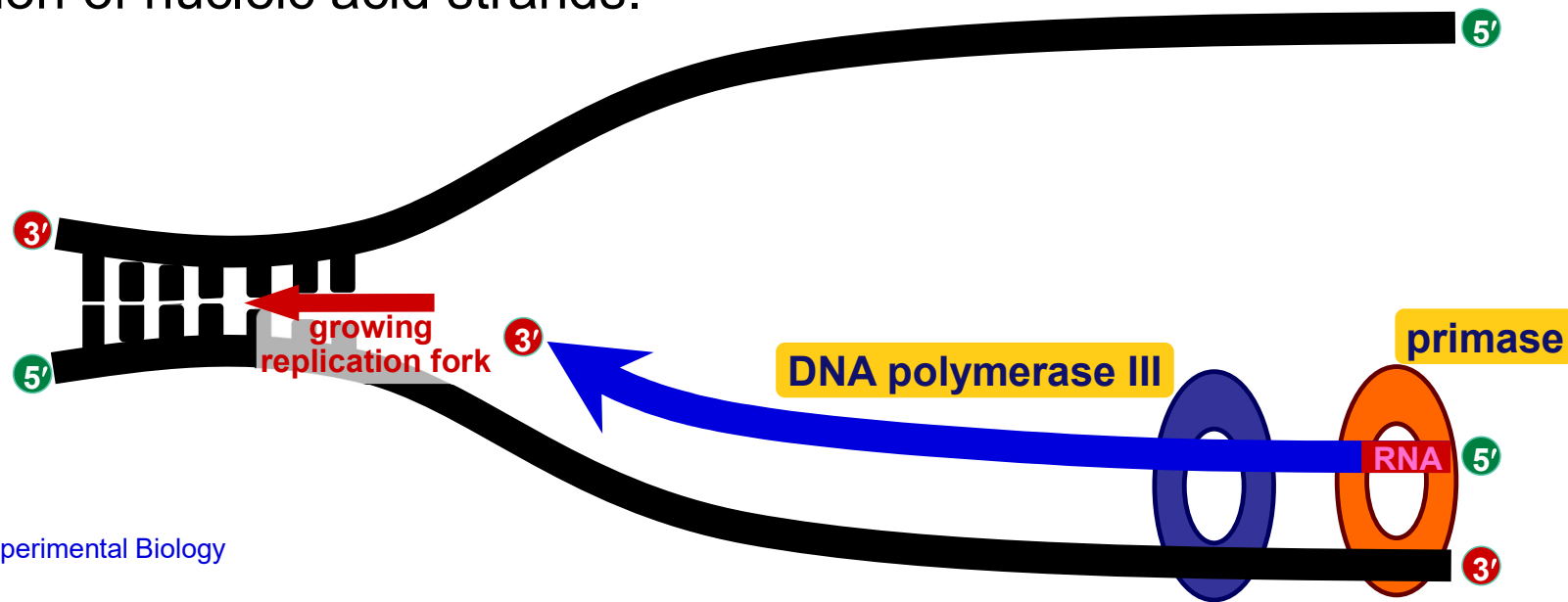

Elongation phase – Lagging strand

Lagging strand synthesis:

- On the template strand with 5'-3' orientation, multiple RNA primers are synthesized at specific sites by primase (primosome complex).
- DNA pol III synthesizes short pieces of new DNA (about 1000 nucleotides long) new DNA is in 5'-3' direction.
- The new strand which is discontinuously synthesized in small, Okazaki's fragments, fragments is called the lagging strand.

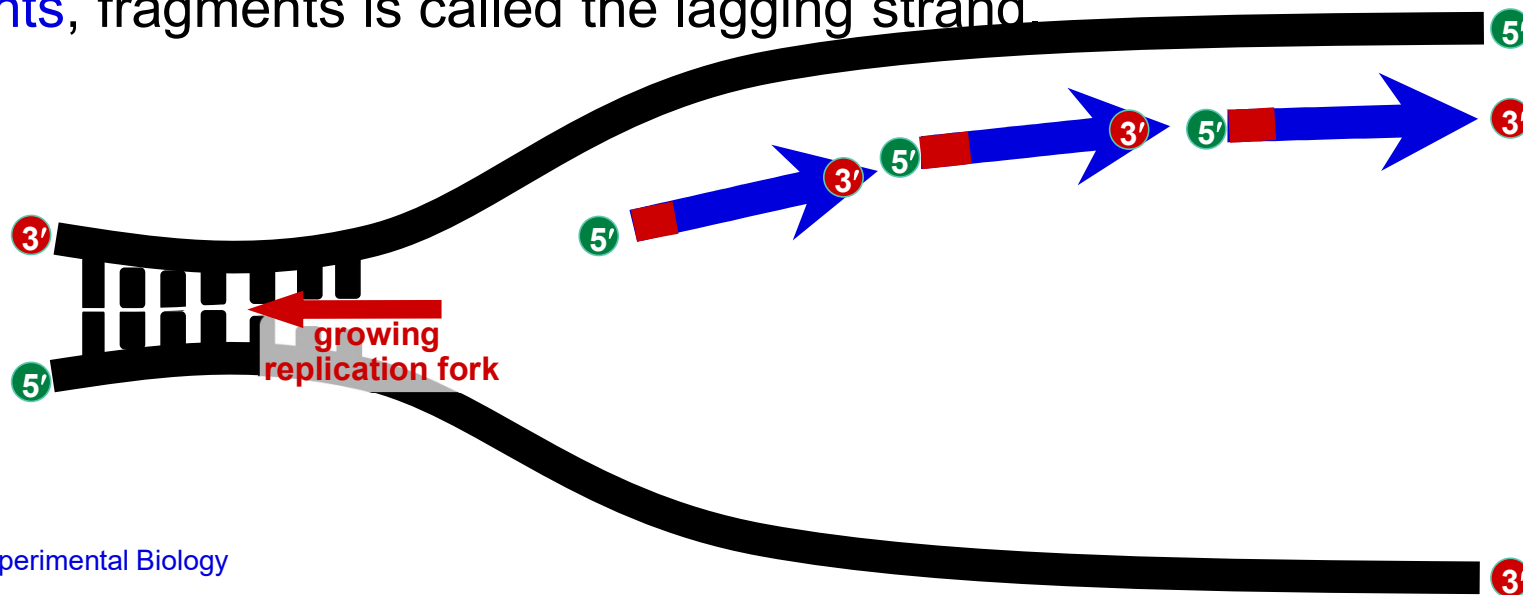

Elongation phase – RNA primers degradation and ligation

- DNA polymerase III synthesizes DNA for both leading and lagging strands.
- After DNA synthesis by DNA pol III, DNA polymerase I uses its 5'-3' exonuclease activity to remove the RNA primer and fills the gaps with new DNA.
- Finally DNA ligase joins the ends of the DNA fragments together.

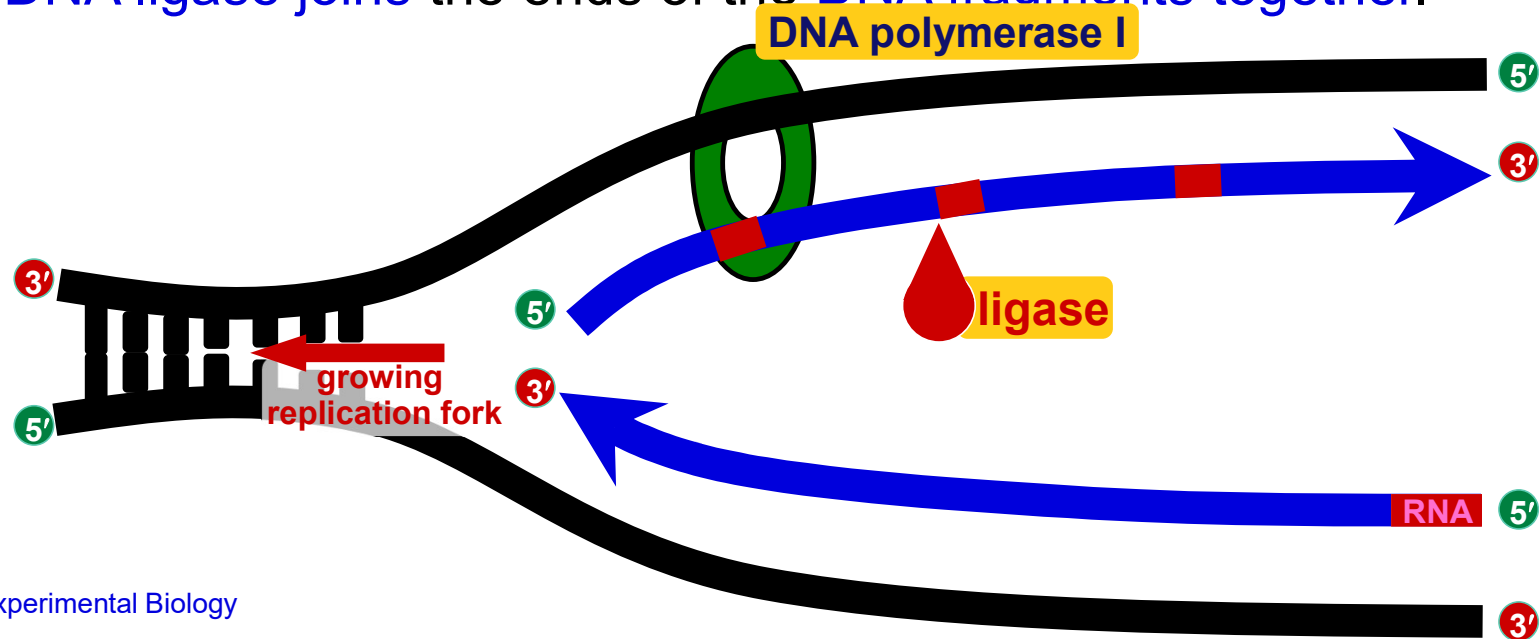

Termination phase

- The two replication forks meet approximately 180 degree opposite to *oriC*, as DNA is circular in prokaryotes.
- There are several terminator sites - *ter* (typically 10 sites) which form termination zone. These sites arrest the movement of forks by binding to the terminus site-binding protein (Tus), an inhibitor of helicase (DnaB).
- The *ter* sites are oriented such that the leftward fork can pass the first five *ter* sites it encounters (red arrowheads), but stalls at the five blue sites. Conversely, the rightward fork passes through the *ter* sites marked as blue arrowheads but stalls at the red sites.

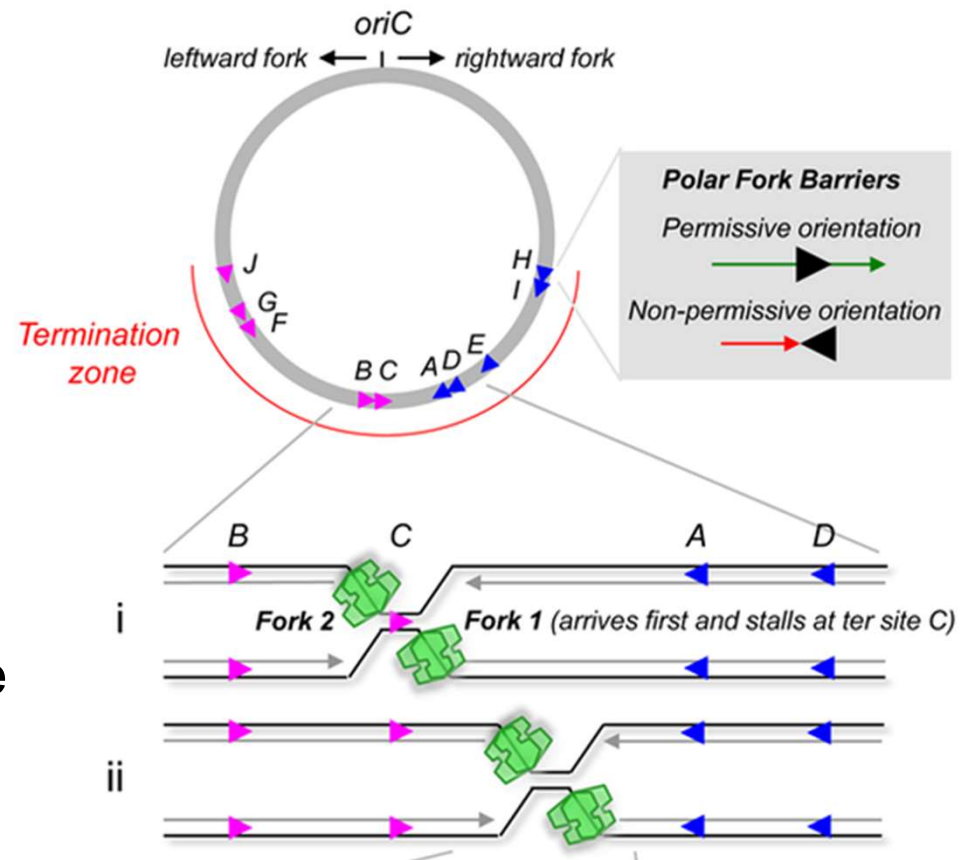

Termination phase

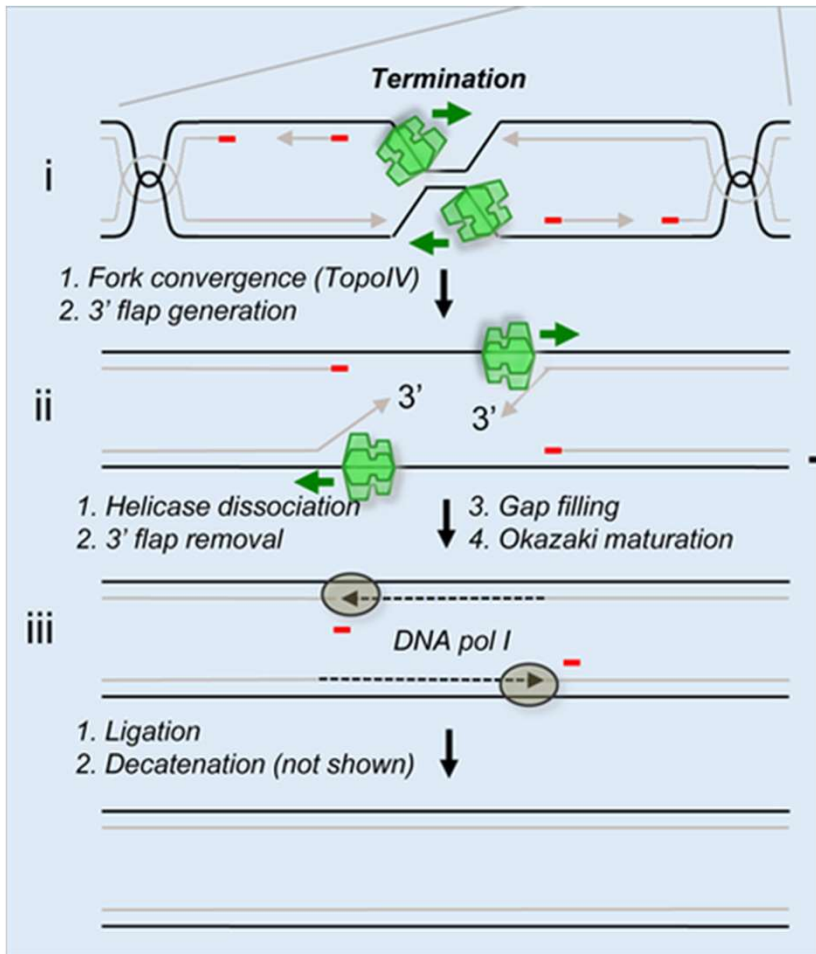

- In this way, forks can enter but not leave the termination zone.
- **Topoisomerase IV** - TopoIV induces fork convergence and 3' flap is generated.
- The flap is normally degraded or remodeled and the gap is subsequently filled.
- Polymerase I may use its 5' to 3' exonuclease activity to remove the RNA primer of the last Okazaki fragment.
- Once **replication is complete**, the two double stranded **circular DNA molecules** (daughter strands) **remain interlinked**. **Topoisomerase II** **unlink** these molecules.

DNA Polymerase in prokaryotes

- DNA polymerases are a group of enzymes that are used to make copies of DNA.
- They are not used for initiating the synthesis of new strands, but in the extension of already existing DNA or RNA strands which are paired with a template strand.
- They catalyze the formation of the phosphodiester bonds between nucleotides., extending the 3' end of the template strand.
- Polymerase uses a magnesium ion (Mg^{2+}) in catalytic activity to balance the charge from the phosphate group.

DNA Polymerase in prokaryotes

- The addition of a nucleotide to a growing DNA strand forms a **phosphodiester bond** using the high-energy phosphate bond of hydrolysis and two distal phosphates known as **pyrophosphate**.

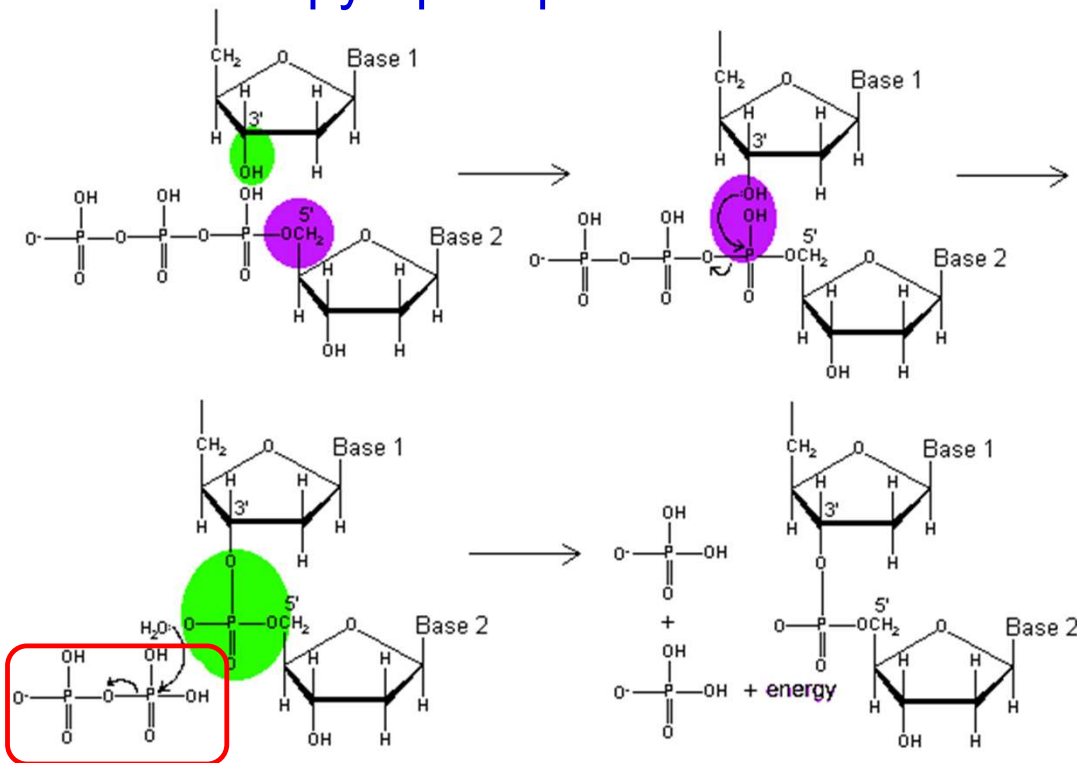





- The 3' hydroxyl group (green oval) attacks the triphosphate group on the incoming nucleotide (violet circle).
- A new phosphodiester bond is formed with the pyrophosphate.
- Pyrophosphate is cleaved to two phosphates and the energy is released from breaking down a the high energy phosphate group.

DNA Polymerase in prokaryotes

- DNA polymerases are very accurate in their mechanism with minimal errors of less than one error for every 10^7 nucleotides.
- Some types of DNA polymerase have the ability to **proofread** and remove unmatched bases of nucleotides and correct them.
- They also correct post-replication mismatches by monitoring and repairing the errors, by distinguishing mismatches of the new strand from the template strand sequences.

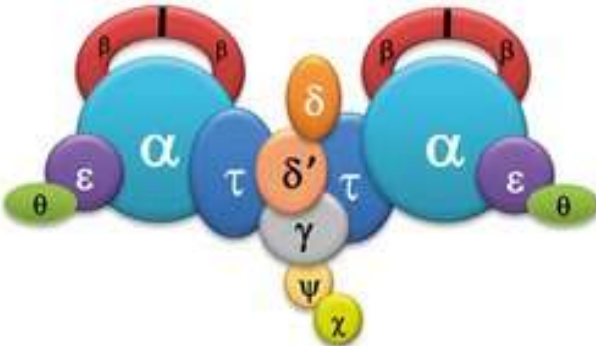
DNA Polymerase in prokaryotes

	Pol I	Pol II	Pol III	Pol IV	Pol V
DNA polymerase family	A	B	C	Y	Y
Activity	5'-3' polymerase 3'-5' exonuclease 5'-3' exonuclease	5'-3' polymerase 3'-5' exonuclease	5'-3' polymerase 3'-5' exonuclease	5'-3' polymerase	5'-3' polymerase
					
Number of molecules/cell					
- SOS	400	50 - 75	10 - 20	150 - 250	< 15
+ SOS	400	350 - 1000	10 - 20	1200 - 2500	200
Biological functions in the cell	DNA replication, Okazaki fragment maturation, DNA repair	DNA replication (backup DNA polymerase), DNA repair, TLS	DNA replication DNA repair	TLS	TLS

DNA Polymerase III

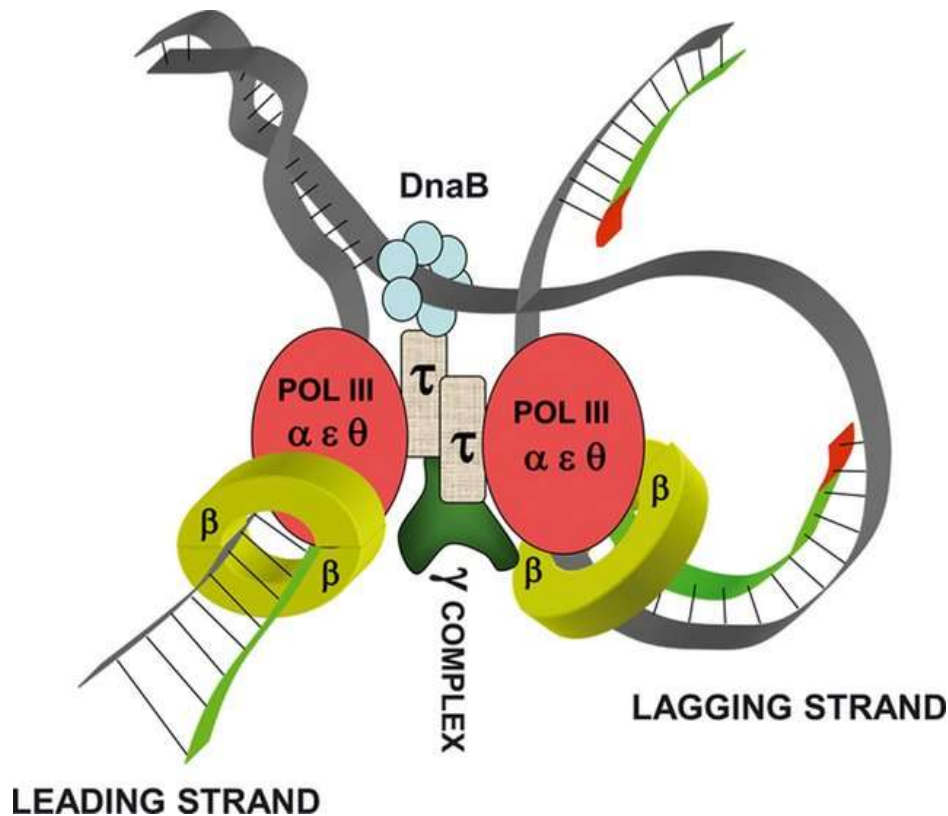

- This is the primary enzyme that is used by prokaryotic cells in DNA replication.
- Is able to synthesize long stretches of template DNA.
- It is responsible for the **synthesis** of new strands, **5'-3' orientation**, by adding nucleotides to the 3'-OH group of the primer.
- It has a **3'-5' exonuclease** activity hence it can also **proofread** the errors that may arise during DNA strand replication.

DNA Polymerase III - composition

- DNA polymerase III is multisubunit complex.
- Core polymerization activity – α , ϵ and θ subunits.
- β –dimer (clamp) prevents premature release of DNA-polymerases III from the template.

Subunits of DNA polymerase III

- α - polymerase – 5' - 3'
- ϵ - 3' - 5' - exonuclease activity
- θ – stimulation of ϵ -subunit
- γ , δ , - connection to β -clamps
- β - clamp
- τ - dimerization of enzymes core units α .

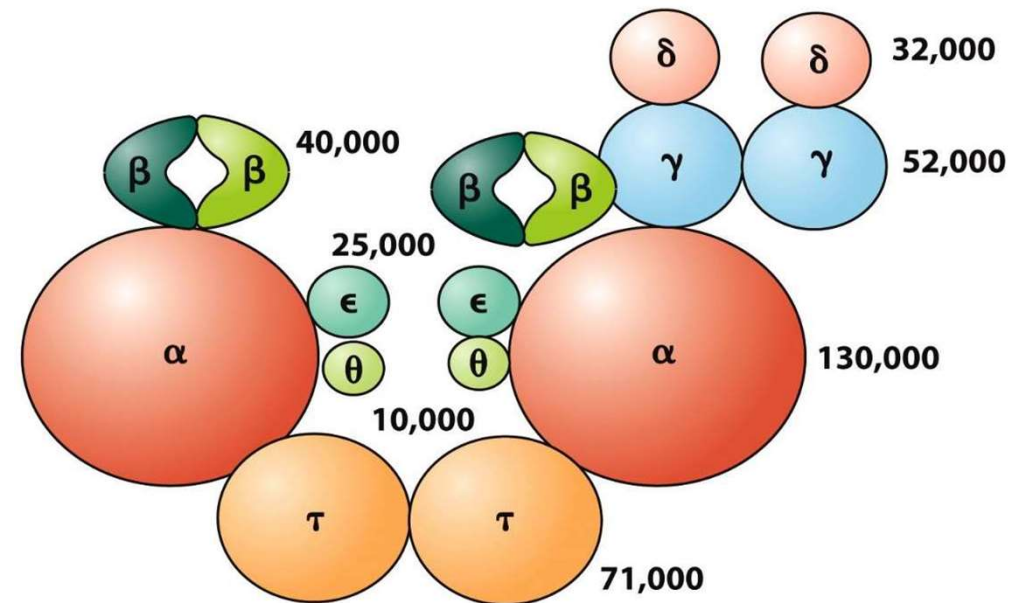

© 2009 John Wiley & Sons, Inc. All rights reserved.

DNA Polymerase III – enzymatic activities

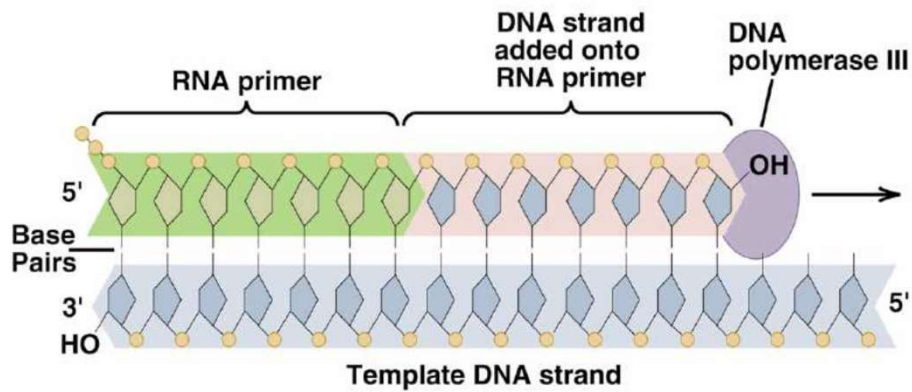

- 5'-3' synthesis of new strands from the RNA primer.

- 3'-5' exonuclease activity in order to proofread the errors that may arise during DNA strand replication.

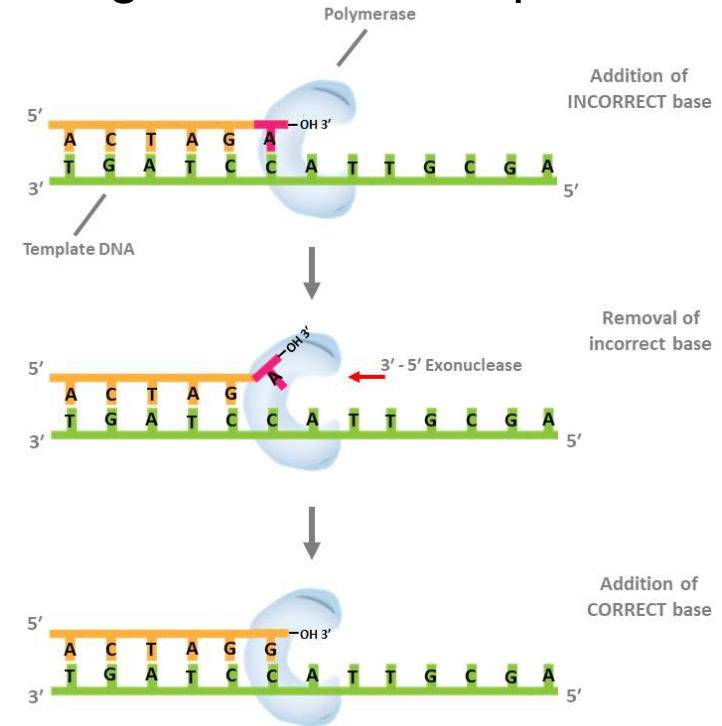

DNA Polymerase I

- Its main function is **excision** repair of DNA strands from the **3'-5' direction** and the **5'-3' direction**, as an exonuclease.
- Its role during replication is the **removal** of the ribonucleotides of the RNA primer, it moves along the **5'-3' direction**.
- It also helps with the maturation of Okazaki fragments, which are short DNA strands that make up the lagging strand during DNA replication.

5' - 3' synthesis

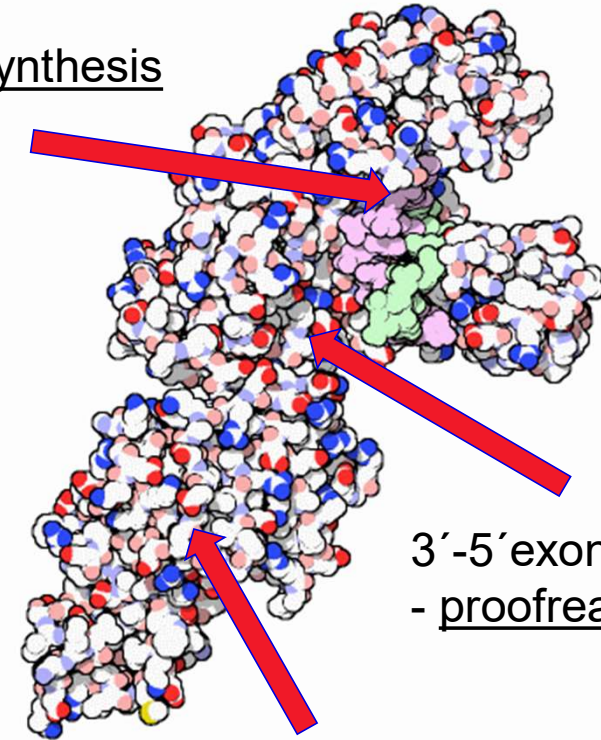

3' - 5' exonuclease
- proofreading

5' - 3' exonuclease
- RNA primer removal

DNA Polymerase I

- 1st ribonucleotide of RNA primer is triphosphated (NTP)

- 5'-3' exonuclease activity

- 5'-3' polymerase activity

- 3' - 5' exonuclease proofreading activity to correct the errors that may arise during DNA replication.

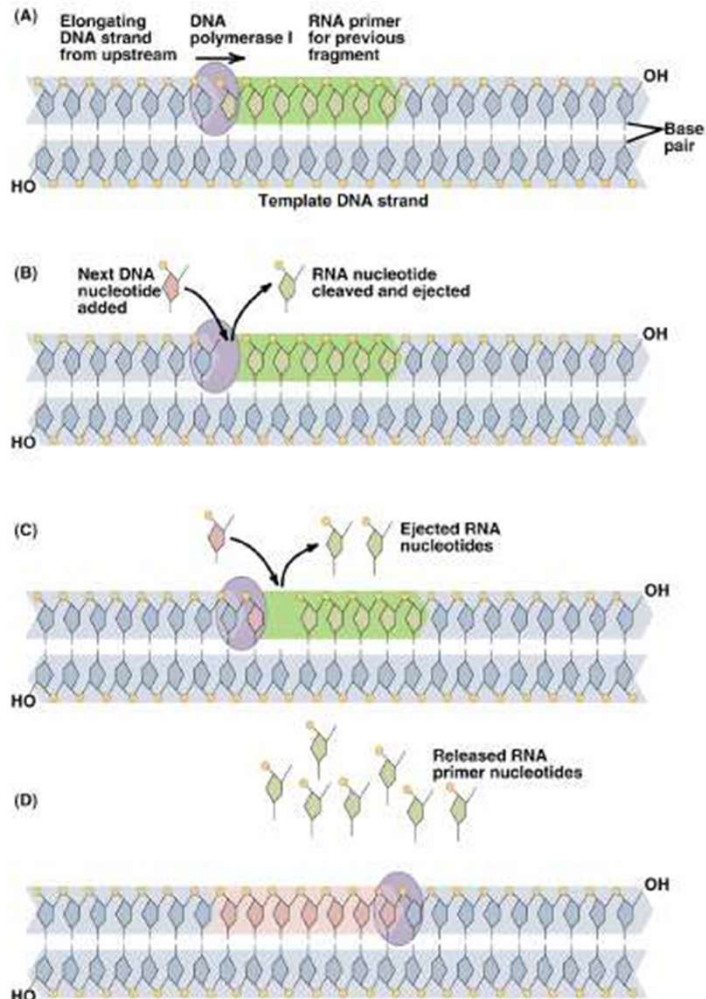

Differences between DNA polymerase III and I

- DNA polymerase III
- DNA polymerase I

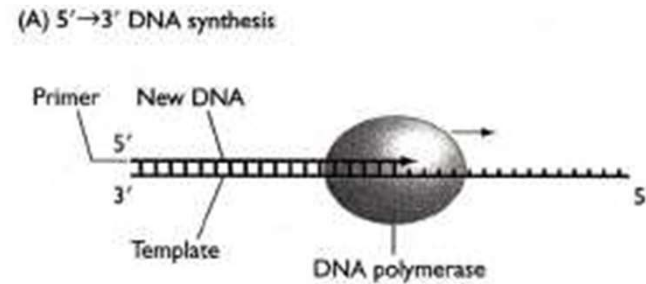

- 5' - 3' synthesis of new strands

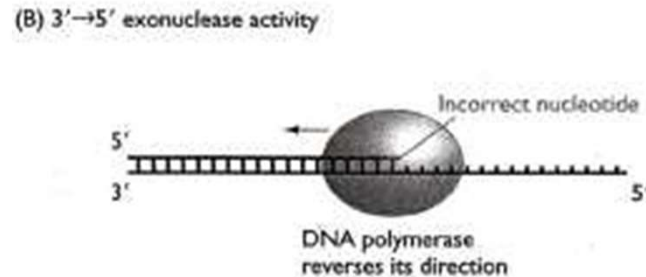

- 3' - 5' exonuclease activity

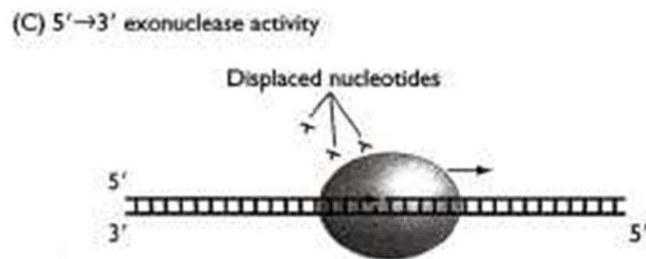

- 5' - 3' exonuclease activity

- DNA polymerase III
- DNA polymerase I

- DNA polymerase I

Discovery of DNA polymerase

- In 1956 he isolated the **DNA-polymerase I** from *E. coli*, for the first time.
- 1959 - Nobel Prize in Physiology or Medicine for discovery of DNA synthesis.

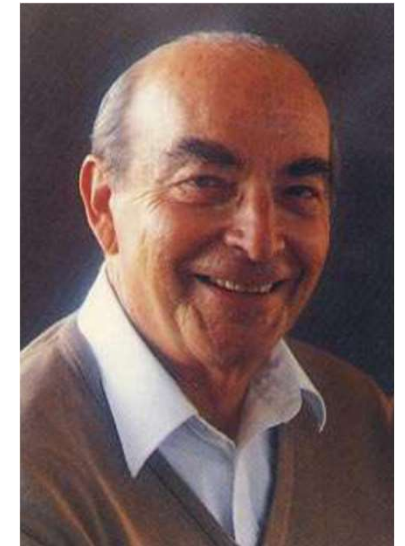

Arthur Kornberg
(1918 – 2007)

Roger Kornberg (*1947 -

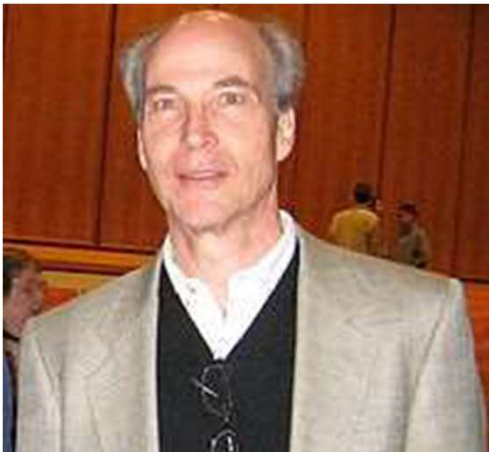

◀ Stanford university ▶

- He isolated the **DNA-polymerase III** from *E. coli*, for the first time.
- 2006 - Nobel Prize in Physiology or Medicine for discoveries of mechanism of DNA replication.

Unwinding of DNA double helix

- The condition for the replication is the availability of unpaired nucleotides in the DNA strand = loosening of the double helix.
- However, the double helix is stable (for denaturation the temperature close to the water boiling point is needed).
- The opening of the double helix is enabled by 3 types of replication proteins:
 - DNA-helicase
 - Single strand binding (SSB) proteins
 - DNA-topoisomerase.

DNA Helicase

- Unwinding of parallel DNA strands is a condition for their separation.
- The one turn of the Helicase subunits at the time.
- 1 turn of helicase - 10 pb: 360° rotation for every 10 nucleotides.
- *E. coli*: replication rate of 30,000 nucleotides per minute. What is the speed of DNA rotation in turns/twists per minute?
 - 3,000 turns/twists per minute.

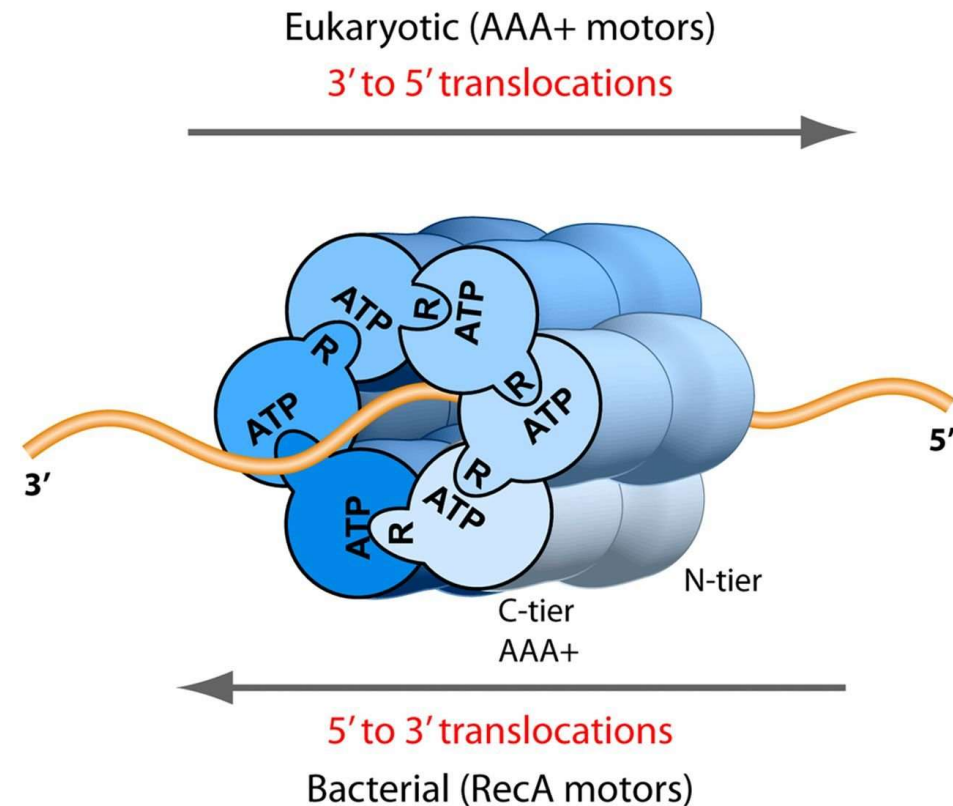

DNA Helicase

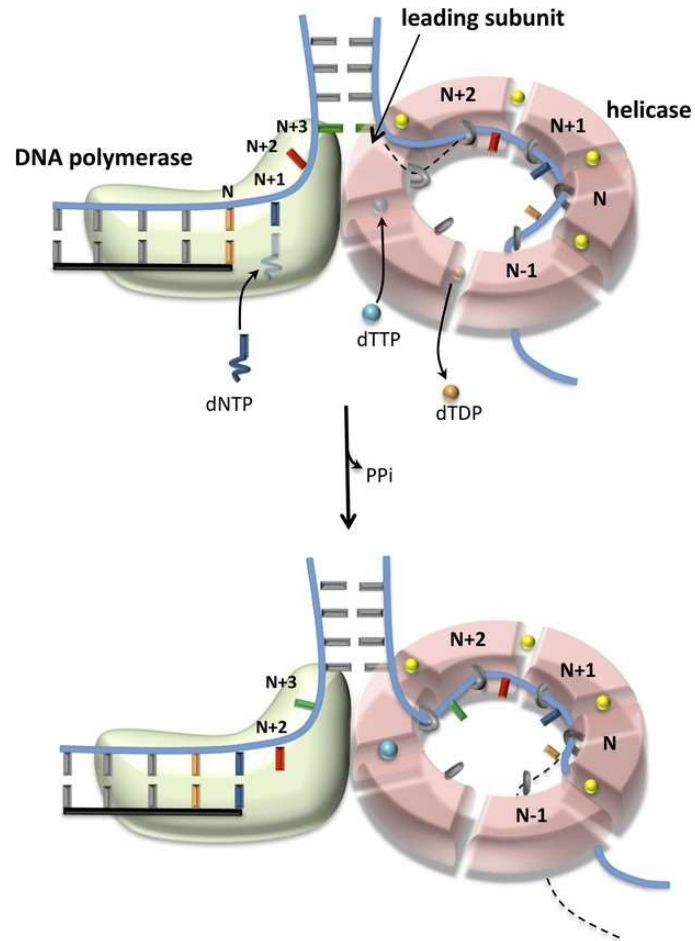

- Six-compartment cylinders, that surround single-strand DNA.
- **Binds and hydrolyze ATP** and thus move along single-strand DNA.
- Once it encounters the double stranded region of DNA, Helicase continues its movement and separates bound strands from each other.

TTP (2'-deoxythymidine 5'-triphosphate)

SSB proteins

- Single-stranded DNA-binding proteins (SSBs) **bind to single-stranded DNA (ssDNA)** by wrapping the single DNA strand around the tetrameric protein core **to protect it from degradation and prevent secondary structure formation**.
- They bind to DNA in a cooperative way (binding one monomer stimulates the bond of the other).
- Bind tightly to the single stranded sections of DNA formed by the action of helicases, without blocking the bases, which thus remain available for pairing.

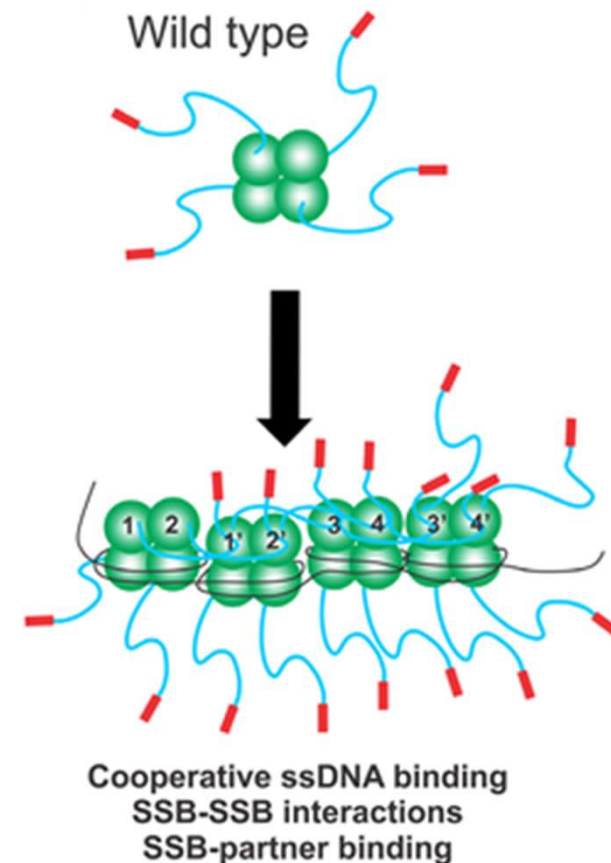

SSB proteins

- *E. coli* SSB is a **homotetramer**.
- Each monomer features a structured
 - DNA-binding domain (residues 1–112)
 - Long and disordered C-terminal tail (residues 116–177) containing a highly acidic tip.

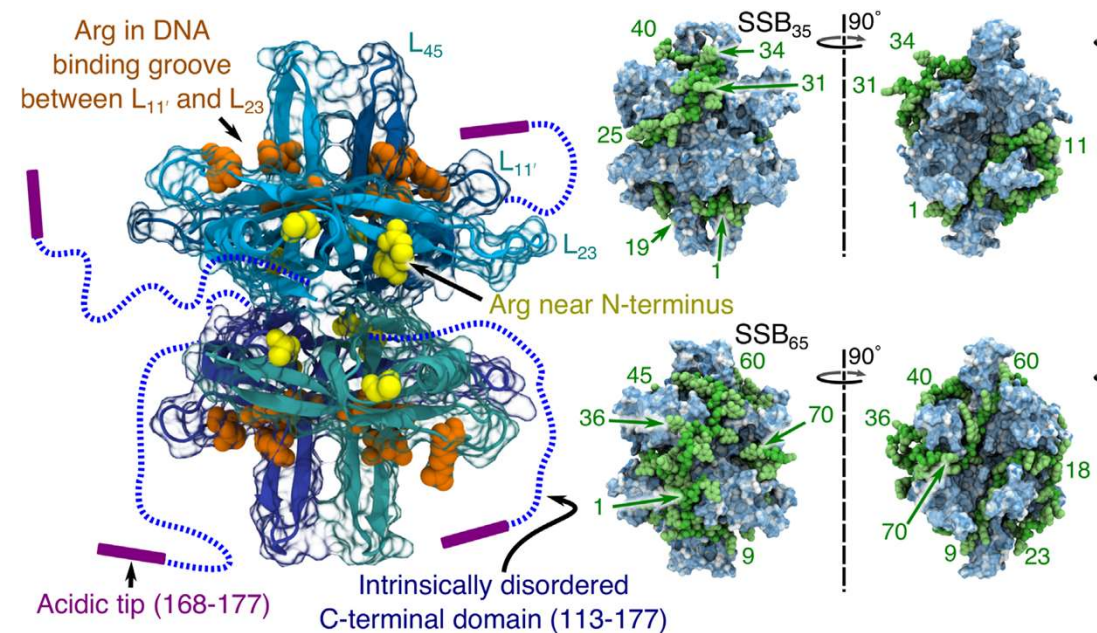

Topoisomerase

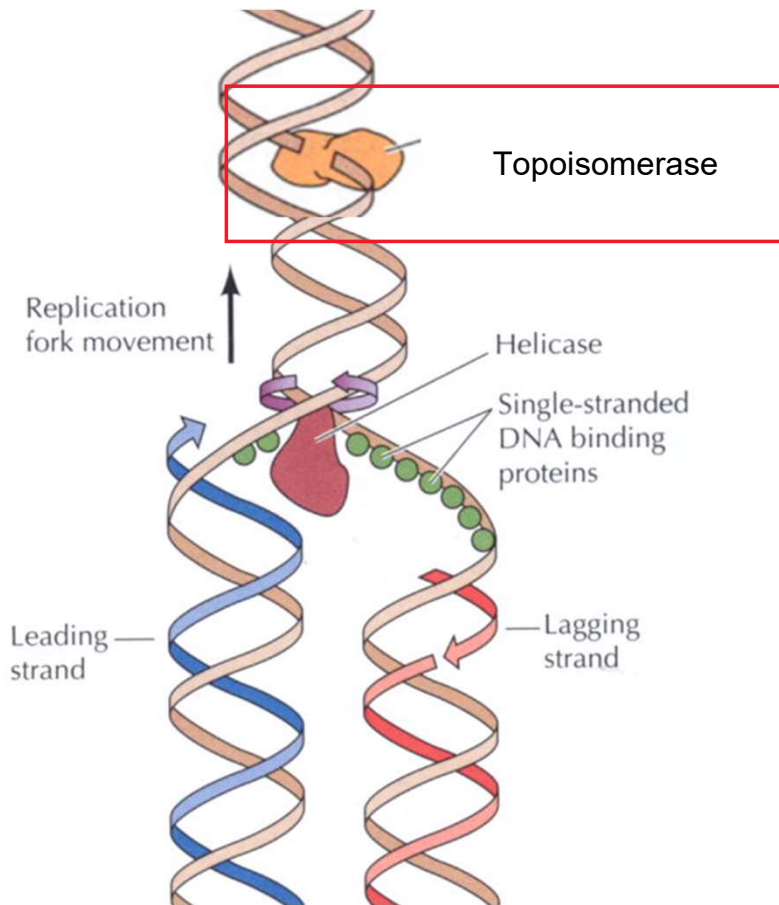

Topoisomerase:

- helps with prevention of DNA strand twisting - 'swivels'.

Two types

- Topoisomerase I - Break one strand only and then rejoin.
- Topoisomerase II (Gyrase) - Break both strands and then rejoin.

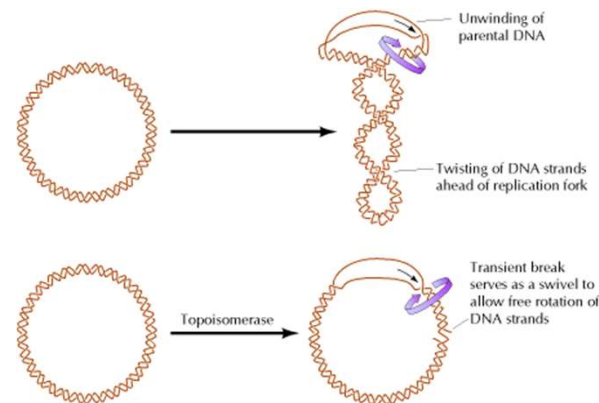

Topoisomerase

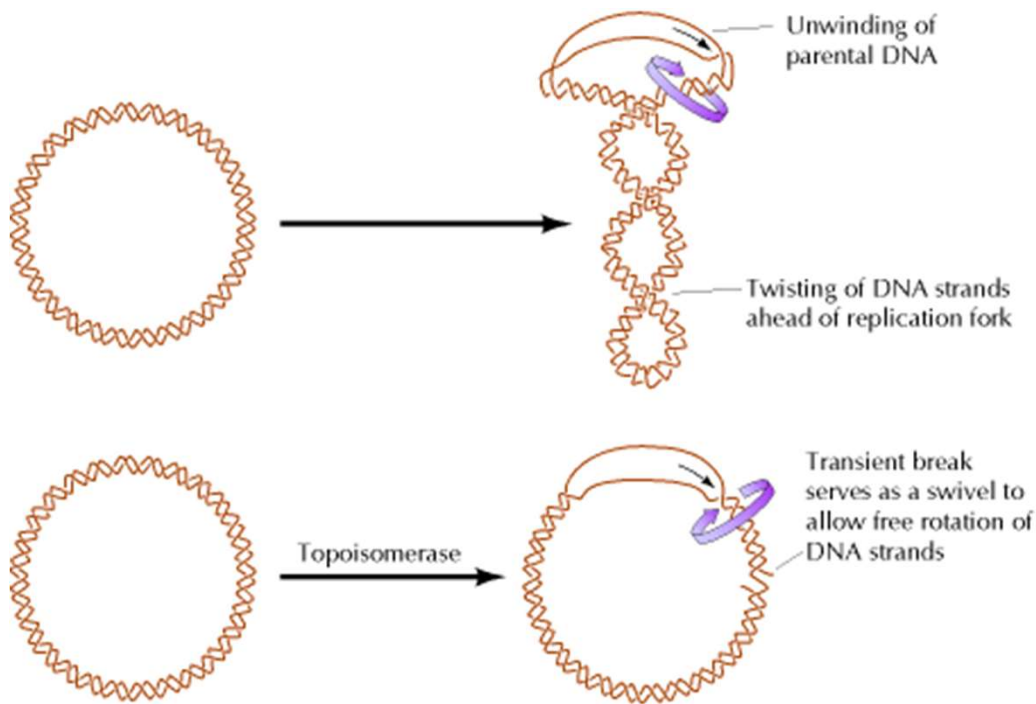

- DNA rotates in front of the replication fork by developing a helix.
- Without the interruption of DNA strands by topoisomerases, the development of DNA leads to the formation of the positive supercoiled threads

RNA primase

- After unfolding DNA at the site of ori by DNA-helicase the RNA-polymerase (primase) synthesizes special short sections of RNA.
- RNA-primers are complementary to the template strand.
- Primase (dnaG) synthesizes short stretches of RNA nucleotides, providing a 3'-OH group to which DNA polymerase can add DNA nucleotides in the direction of 5'-3'.
- 10-60 nucleotides for prokaryotes.
- 10 nucleotides for eukaryotes.

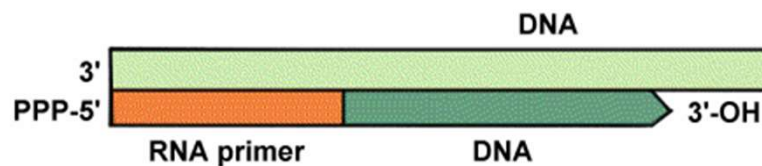
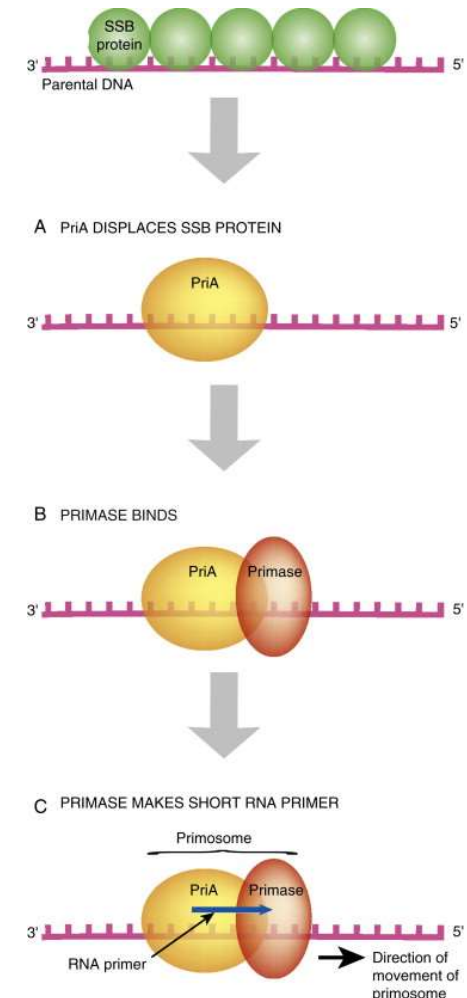

Primosome

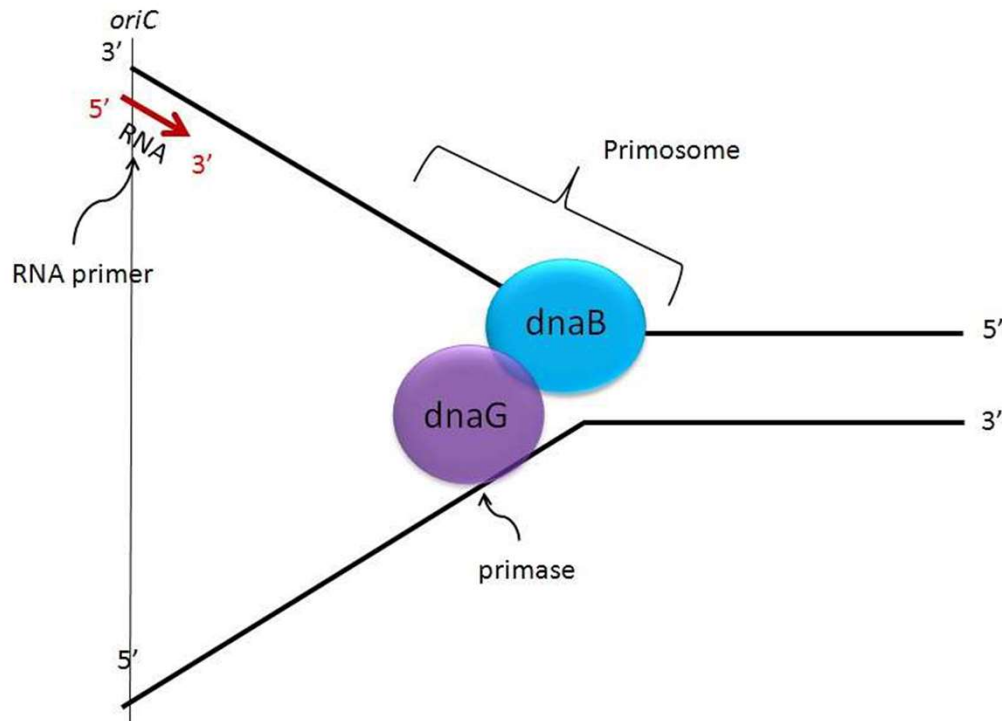

- DNA-helicase (dnaB) and DNA-primase (dnaG) complex form Primosome.
- Ensures the release of single strands from the dsDNA and the synthesis of RNA-primers.
- Moves along a DNA molecule powered by ATP energy.

Ligase

- DNA-ligase corrects "notches" in the sugar-phosphate skeleton of DNA
 - DNA replication,
 - DNA Repair.
- DNA-ligase is **activated by ATP** binding and temporarily joins the free 5' P at the notch site (P-P is released).
- Release of ASF restores covalent bond in the strand.

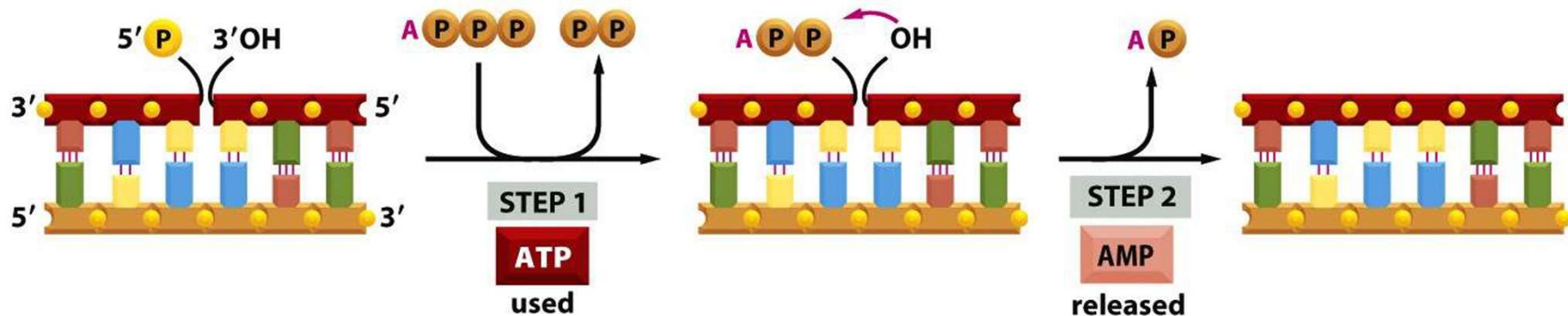

Replisome

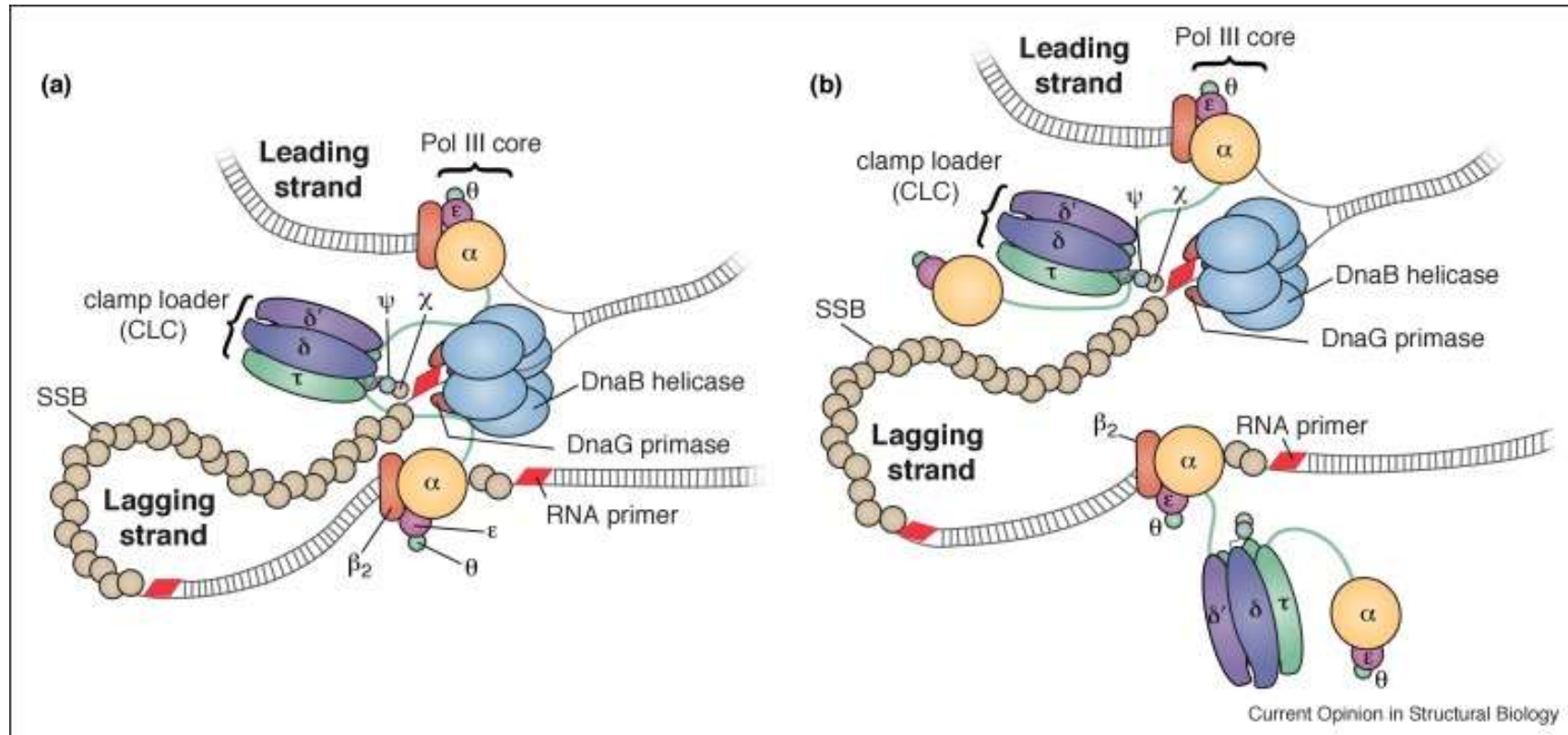

DNA replication in prokaryotes – overview



Organization of dsDNA

- Organization of prokaryotic chromosome and plasmids.

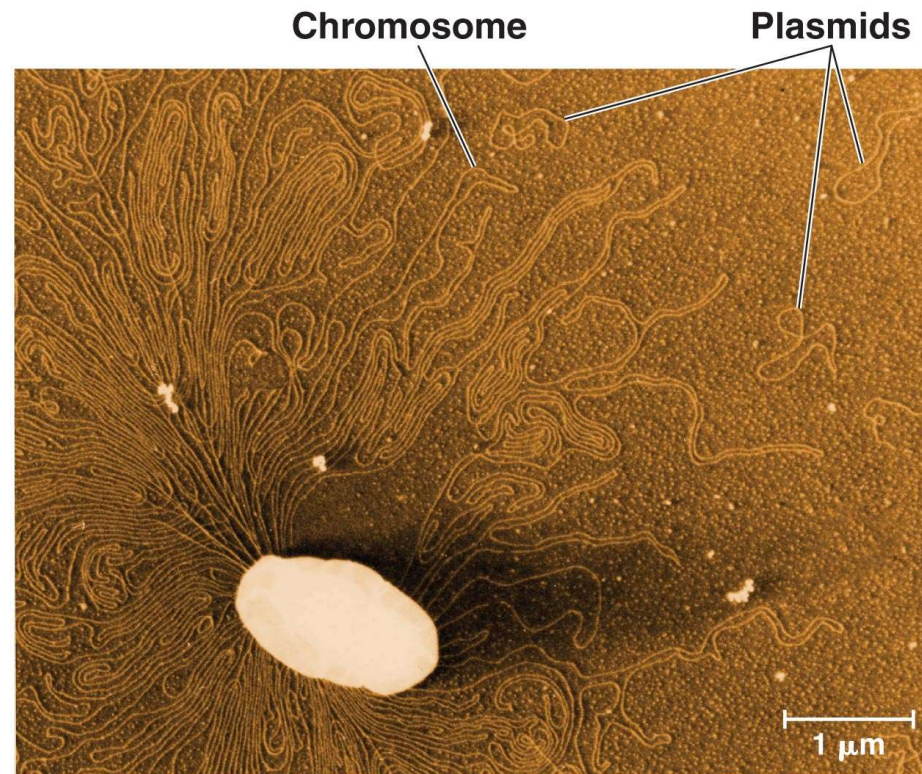

Copyright © 2008 Pearson Education, Inc., publishing as Pearson Benjamin Cummings.

Models of DNA replication

- Theta
- Rolling circle
- Linear

Theta model of DNA replication

- Two **replication forks** can proceed independently around the DNA ring and when viewed from above the structure resembles the Greek letter "**theta**" (θ).
- Originally discovered by John Cairns, it led to the understanding that **bidirectional DNA replication** could take place.
- Theta replication is a type of common in *E. coli* and other organisms possessing circular DNA.

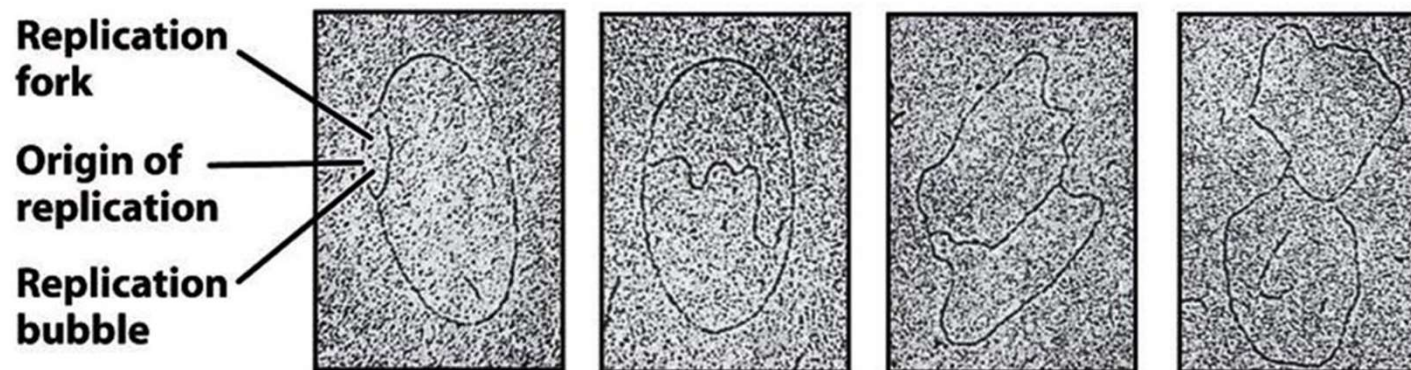
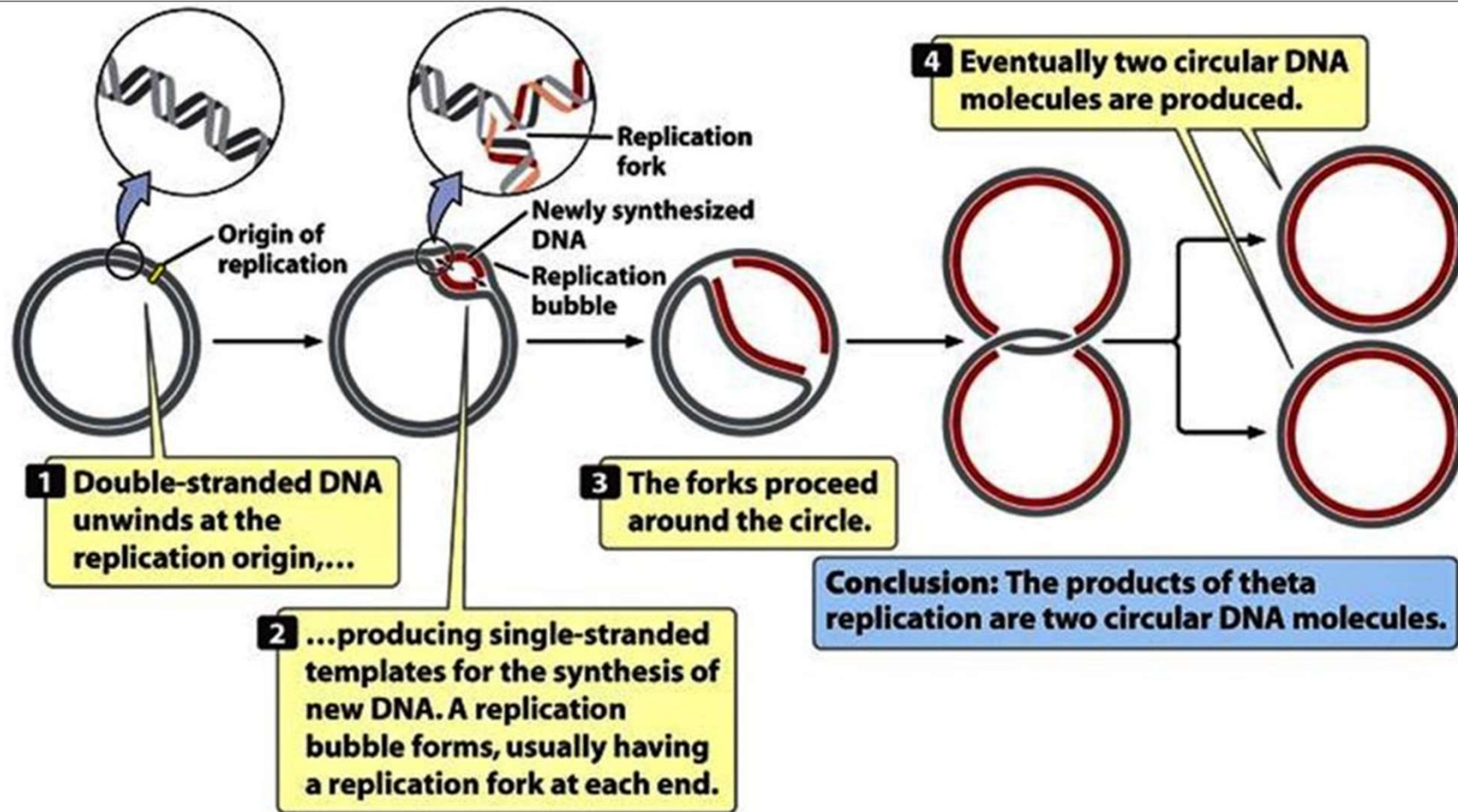

Figure 12.4b
Genetics: A Conceptual Approach, Fifth Edition
© 2014 W. H. Freeman and Company

Theta model of DNA replication



Rolling-circle replication

- Rolling circle replication (RCR) is a process which a circular DNA or RNA molecule is replicated in one direction.
- RSR is associated with replication of the
 - genomes of bacteriophages,
 - plasmids of Gram-positive and Gram-negative bacteria,
 - archaeal plasmids,
 - eukaryotic viruses,
 - the circular RNA genome of viroids.

Rolling-circle replication

- In this step the linear copies of the original DNA molecule are converted into 3'-OH at the nick is the growing point where DNA synthesis begins. The inner strand is used as a template.
- The 3' end grows around the circle giving rise to the name rolling-circle model.

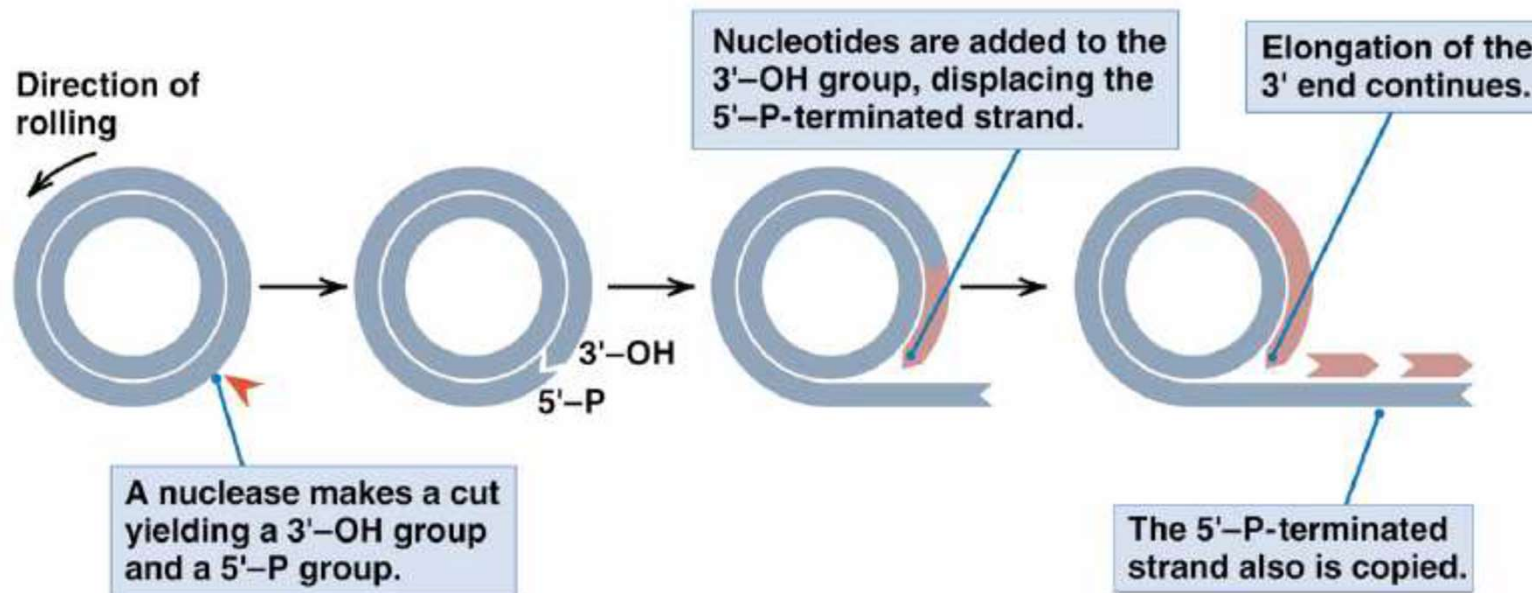

Rolling-circle replication

(A) One complete revolution

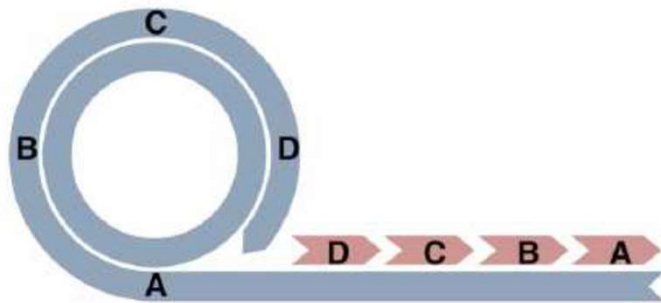

- Continued DNA synthesis can produce multiple **single stranded DNA** copies of the original DNA in a continuous Head To Tail series called **Concatemer**.

(B) Two complete revolutions

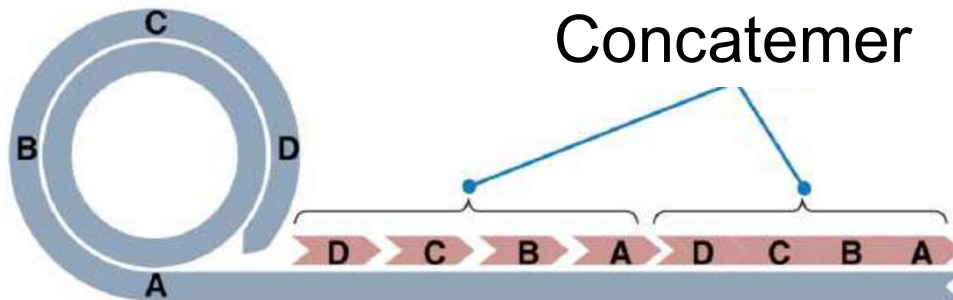

- Eukaryotic DNA replication

Cell division and reproduction

- Every cell needs a complete set of genes, therefore, **duplication** of the whole genome must occur before cell division.
- Each **chromosome** needs to be **accurately duplicated** and one copy of the chromosome transferred into each daughter cell.
- Estimation, there is around 65 trillion cells (6.5×10^{13}) in the body, and there is the same number of replications of the genome.

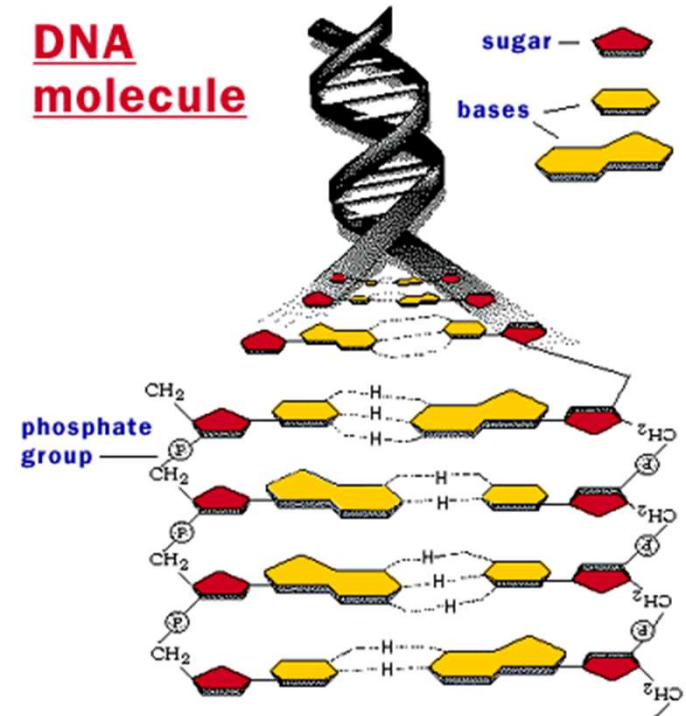

Eukaryotic DNA replication

- The basic principles of the eukaryotic DNA replication are the same as in the prokaryotes.

Differences:

- DNA synthesis takes place only at a **certain stage of the cell cycle (S-phase)**.
- Replication takes place in the **nucleus**.
- Multiple replication beginnings— around 10,000.
- RNA-DNA primers at the Okazaki fragments.
- At least 15 types of DNA-polymerases.
- Helicases in on the **leading strand**.
- **RNAse cleaves the RNA primer**.
- DNA components of chromatin.

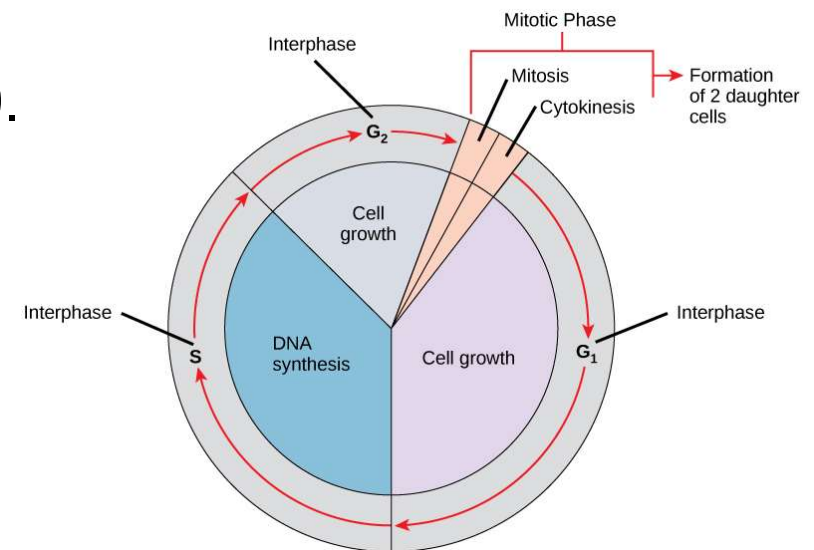

Eukaryotic DNA replication

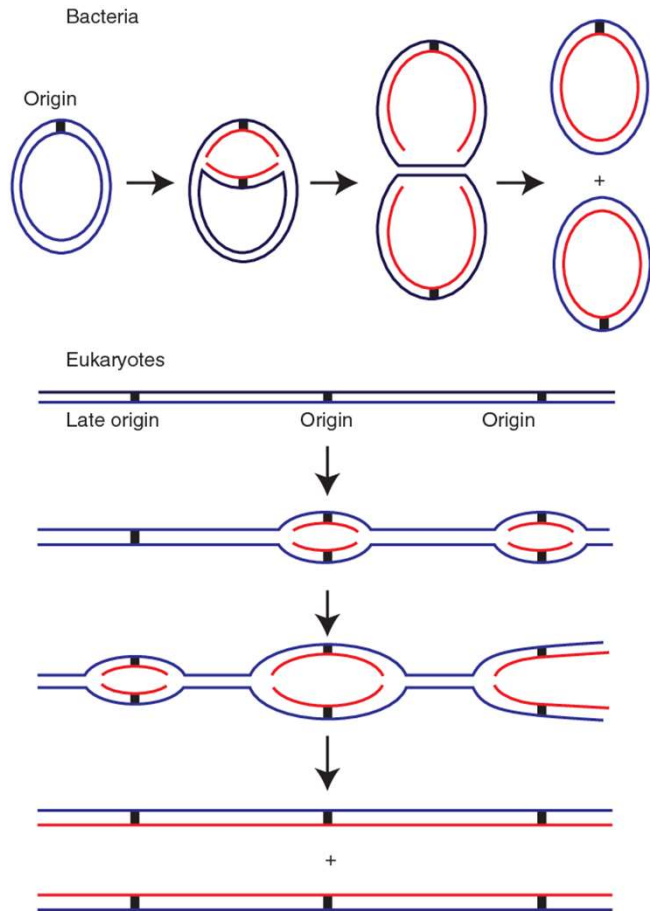

- The **origins** of replication are present in **many copies** in the genome (thousands).
- The size of the site *ori* of higher eukaryotes reaches up to several thousand pair base, with proper DNA topology.
- Before the DNA replication is started the **RLF (replication licensing factor)** binds near the *ori* site before replication begins.
- RLF coordinates replication initiation from many *ori* sites in order to avoid multiple duplication of DNA within one cycle.

Eukaryotic DNA replication

- Replication licensing factor (RLF) is present in the nucleus before beginning of replication.
- Once the replication starts, the RLF is inactivated by degradation or translocation to the cytoplasm to prevent reinitiation of replication.
- RLF is loaded on DNA only when the nuclear membrane is disrupted during mitosis.

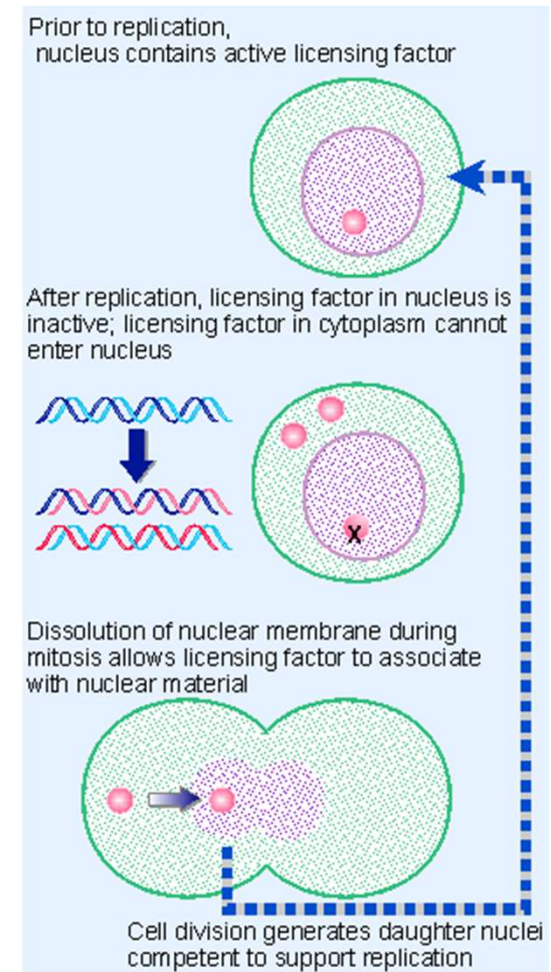

Eukaryotic DNA replication

- In eukaryotes the origin recognition complex (ORC) is highly conserved six-subunit.
- ORC recognizes origins of replications and binds them in ATP-dependent manner.
- The Cdc6 and Cdt1 proteins are synthesized exclusively in phase G1.
- Together they bind to ORC (origin recognition complex) associated with the *ori* sites.
- The MCM2 – 7 helicase is recruited to the origins.
- The DNA is unwound.

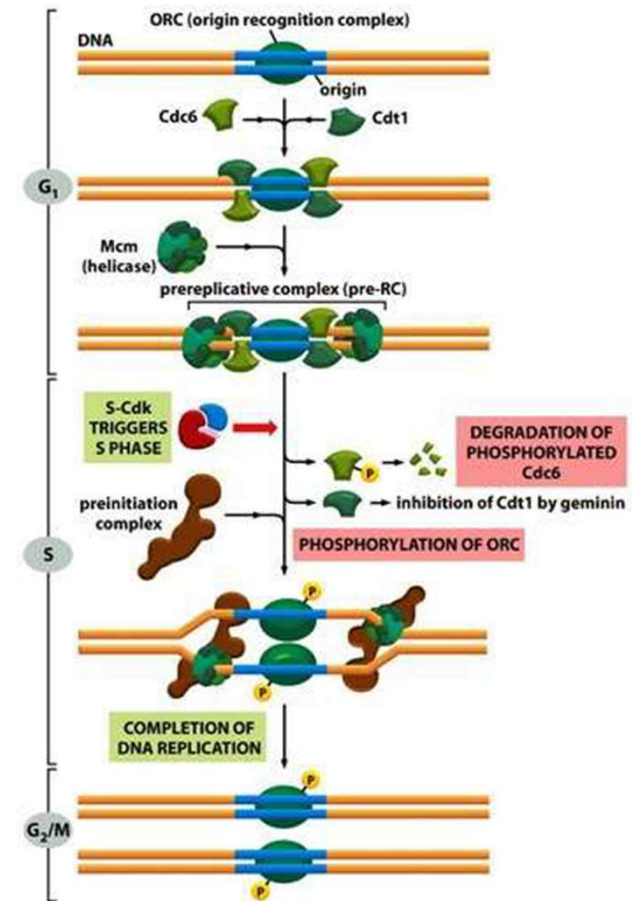

Figure 17-23 Molecular Biology of the Cell 5/e (© Garland Science 2008)

Eukaryotic DNA replication

- Cdc6 leaves the complex and is phosphorylated and degraded (yeast) or exported from the nucleus due to phosphorylation by CDKs (higher eukaryotes).
- Other proteins are attached, which are necessary for binding of DNA-polymerases.
- Cdt1, is released from the complex and inhibited by binding of Gemnin.
- The cell enters the S-phase.
- Since Cdc6 and Cdt1 factors can't be activated again in the same cycle, thus these factors establish DNA replication licensing.

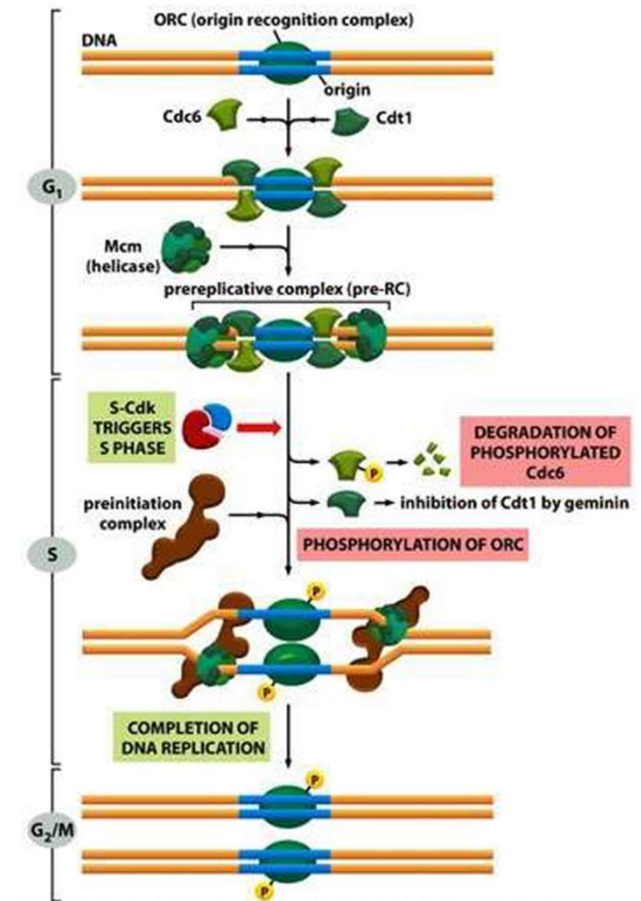
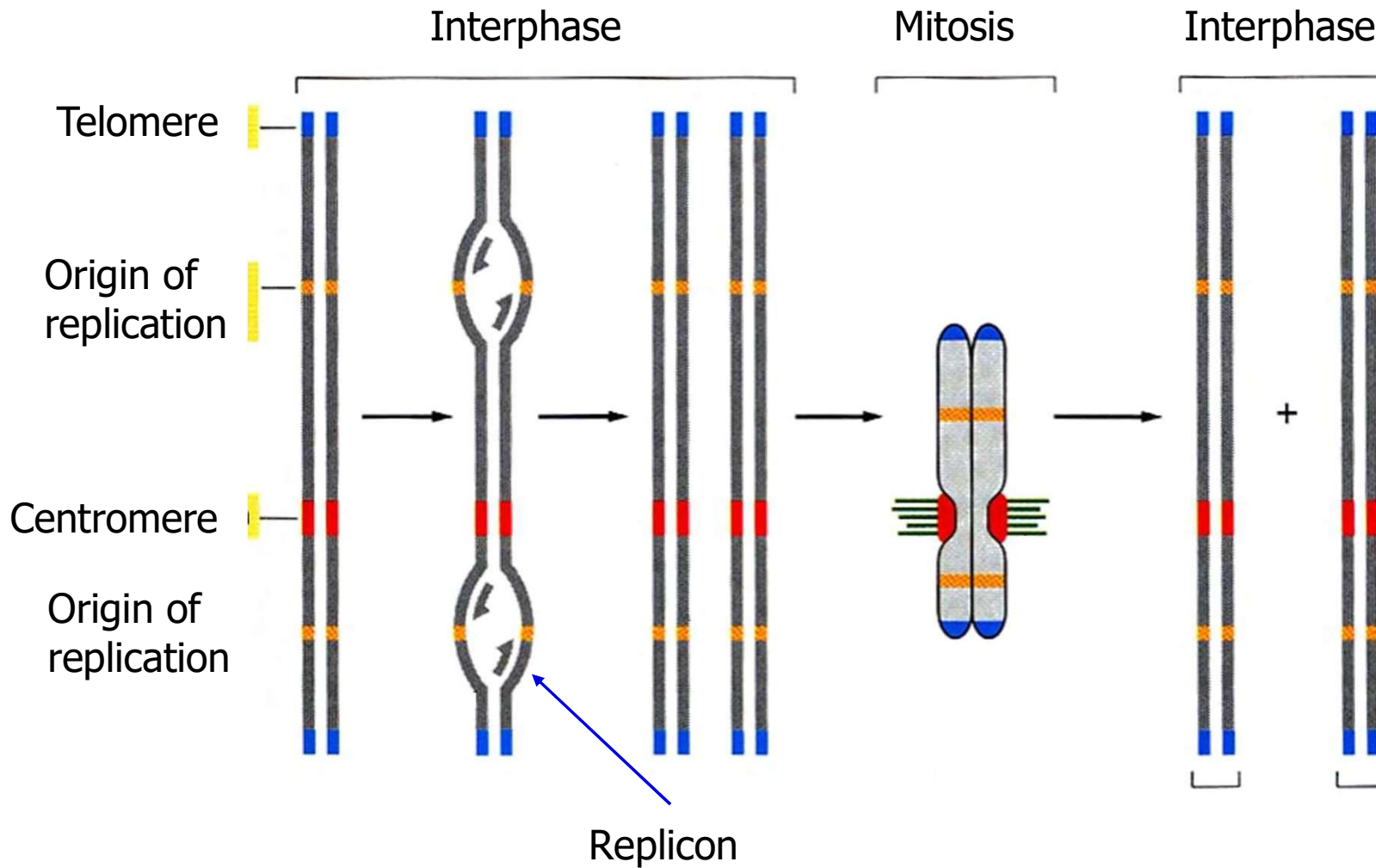

Figure 17-23 Molecular Biology of the Cell 5/e (© Garland Science 2008)

Eukaryotic DNA replication



Origins of replications

Organism	Number of replicons	Size of replicons	<u>Fork movement</u>
<i>E. coli</i>	1	4600 kb	30 000 bp/min
<i>S. cerevisiae</i>	500	40 kb	3 600 bp/min
<i>D. melanogaster</i>	3 500	40 kb	2 600 bp/min
<i>X. laevis</i>	15 000	200 kb	500 bp/min
<i>M. musculus</i>	25 000	150 kb	2 200 bp/min
<i>V. faba</i>	35 000	300 kb	

Differences in speed of DNA synthesis.

Eukaryotic DNA polymerases

- Pol α - in a stable complex with DNA-primase, synthesis of Okazaki's fragments, 3'-5' exonuclease, absence of 5'-3' exonuclease activity for the removal of RNA-primers.
- Pol γ - mitochondrial DNA synthesis/replication.
- Pol δ - synthesis of the leading strand and completion of the synthesis of the lagging strand, high processivity, 3'-5' exonuclease.
- Pol ϵ - synthesis of the leading strand.

Eukaryotic DNA polymerases

Polymerase ^a	Family	Catalytic subunit				Associated activities	Proposed functions
		Molecular mass (kDa) ^b	Human gene (alias)	Chromosomal location ^c	Yeast gene ^d (alias)		
α (alpha)	B	165	<i>POLA</i>	Xp22.1-p 21.3	<i>POL1 (CDC17)</i>	Primase	chromosomal replication, S-phase checkpoint, DSB repair
β (beta)	X	39	<i>POLB</i>	8p11.2	-	dRP & AP lyase	BER, single strand break repair
γ (gamma)	A	140	<i>POLG</i>	15q25	<i>MIP1</i>	3'→5' exonuclease, dRP lyase	mitochondrial replication, mitochondrial BER
δ (delta)	B	125	<i>POLD1</i>	19q13.3	<i>POL3 (CDC2)</i>	3'→5' exonuclease	chromosomal replication, NER, BER, MMR, DSB repair
ε (epsilon)	B	255	<i>POLE</i>	12q24.3	<i>POL2</i>	3'→5' exonuclease	chromosomal replication, NER, BER, MMR, DSB repair, S-phase checkpoint
ζ (zeta)	B	353	<i>POLZ (REV3)</i>	6q21	<i>REV3</i>		TLS, DSB repair, ICL repair?, SHM
η (eta)	Y	78	<i>POLH (RAD30, RAD30A, XPV)</i>	6p21.1	<i>RAD30</i>		TLS, SHM
θ (theta)	A	198	<i>POLQ</i>	3q13.33	-		ICL repair?
ι (iota)	Y	80	<i>POLI (RAD30B)</i>	18q21.1	-	dRP lyase	TLS?, BER?, SHM
κ (kappa)	Y	76	<i>POLK (DINB1)</i>	5q13	-		TLS
λ (lambda)	X	66	<i>POLL</i>	10q23	<i>POLA (POLX)</i>	dRP lyase	DSB repair, BER?
μ (mu)	X	55	<i>POLM</i>	7p13	-	TdT	DSB repair
σ (sigma)	X	60	<i>POLS (TRF4-1)</i>	5p15	<i>TRF4</i>		sister chromatid cohesion
REV1	Y	138	<i>REVI</i>	2q11.1-q11.2	<i>REVI</i>	TdT (for dC)	TLS

Eukaryotic Replisome

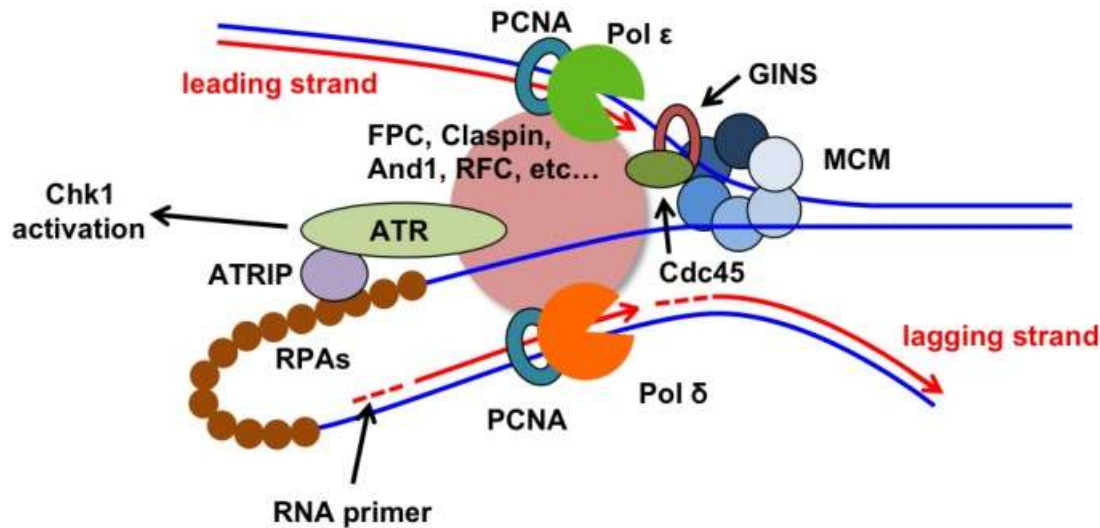

- DNA-helicases and DNA topoisomerases unwind dsDNA.
- PCNA (proliferating cell nuclear antigen) ~ β -clamp increases processivity of polymerase.
- Unwind strands are surrounded by Replication protein A (RPA).

- DNA-polymerase of pol α , pol δ and pol ϵ .
- Two polymerases are present in a single replication fork.
- Pol α is in a stable complex with DNA-primase.

Elongation of Eukaryotic DNA replication

- DNA-polymerases α , δ and ϵ have 3'-5' exonuclease activity for the correction function, but do not have 5'-3' exonuclease activity, they cannot remove RNA-primers like DNA-polymerase I in *E. coli*.
- Primers are removed by Rnase H1 (FEN1 and DNA2).
- The gaps are filled by Polymerase δ and DNA-ligase connects the synthesized strand.

Initiation of Eukaryotic DNA replication

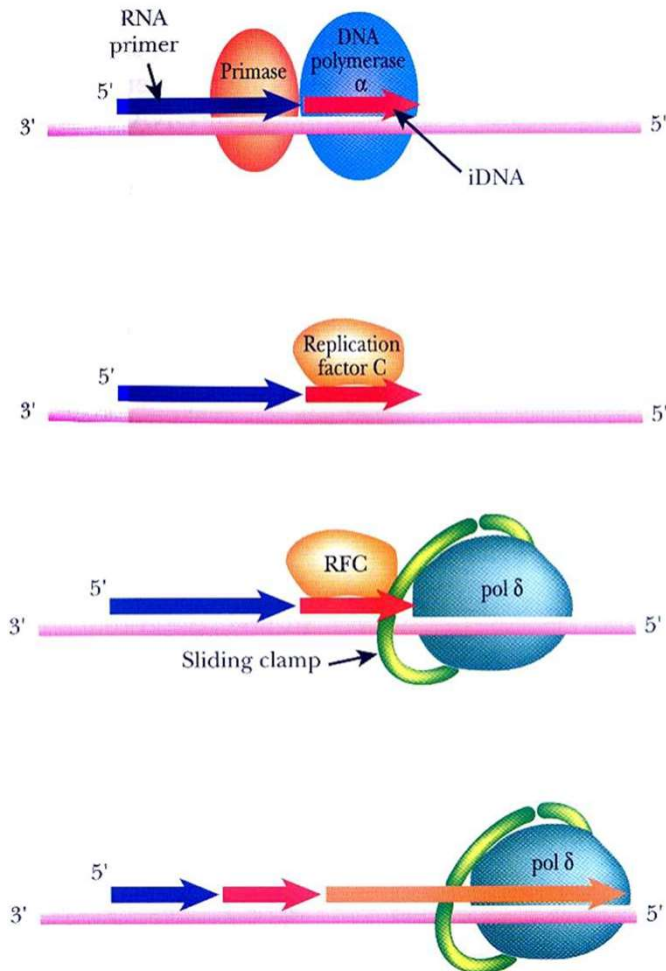

- Primase synthesizes RNA-primer ~ 10 nucleotides.
- DNA-polymerase α then add ~ 20 nucleotides of iDNA (initiator DNA).
- Replication Factor C (RFC) binds to iDNA and recruits PCNA.
- RFC via PCNA allows binding of DNA-polymerase δ .
- DNA-polymerase δ then synthesizes the new DNA strand.

Difference in Prokaryotic and Eukaryotic replication

Difference between Prokaryotic and Eukaryotic Replication		
Property	Prokaryotes	Eukaryotes
Origin of replication	Single	Multiple
Rate of replication	1000 nucleotides/s	50 to 100 nucleotides/s
DNA polymerase types	5	14
Telomerase	Not present	Present
RNA primer removal	DNA pol I	RNase H
Strand elongation	DNA pol III	Pol α , pol δ , pol ϵ
Sliding clamp	Sliding clamp	PCNA

Prokaryotic and Eukaryotic replisome

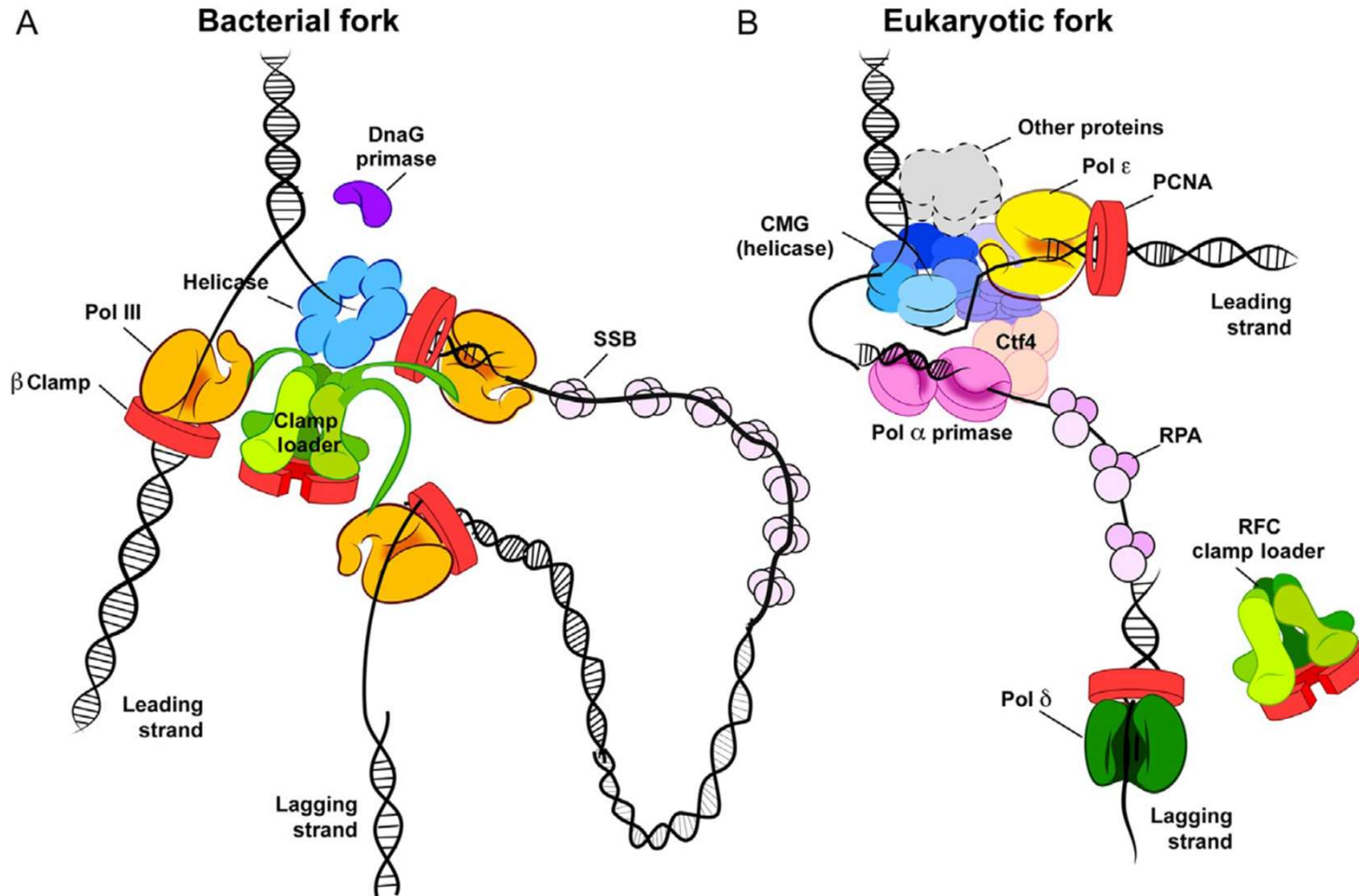

Replication of ends of chromosome

- Limitations of DNA polymerase create problems for the linear DNA of eukaryotic chromosomes (remember that bacteria and viruses replicate circular DNA and do not suffer from this dilemma).
- The usual replication machinery provides no way to complete the terminal 5' end of a DNA strand.
- As DNA polymerase has no primer to start off at, repeated rounds of replication produce shorter and shorter progeny DNA strands, effecting the cell.

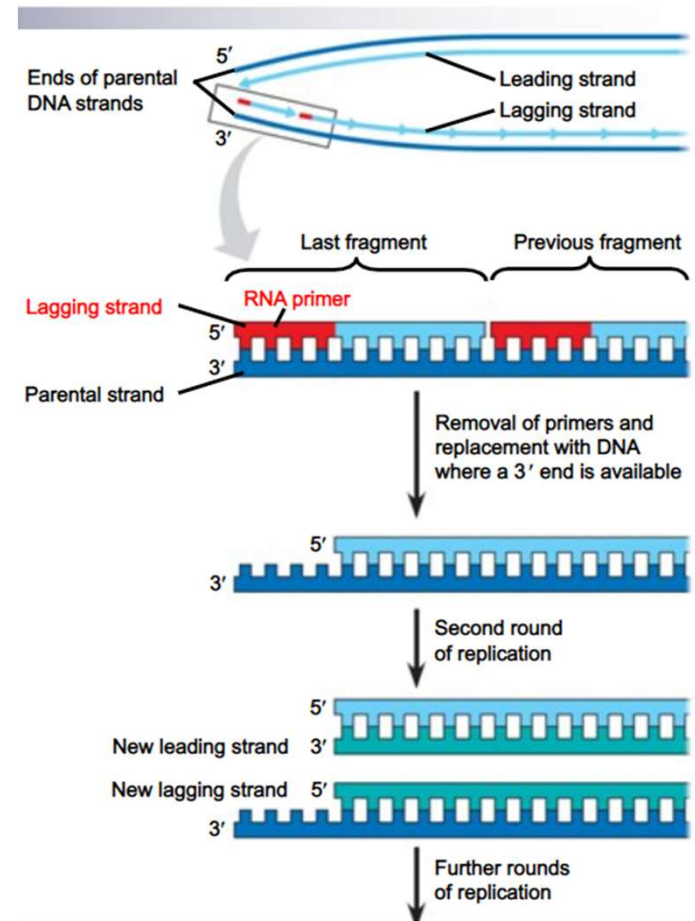

Telomeres

- Telomeres are distinctive structures made of DNA sections found at the ends of each of our chromosomes.
- They consist of the same sequence of bases repeated over and over.
- In humans the telomere sequence is TTAGGG.
- This sequence is usually repeated about 3,000 times and can reach up to 15,000 base pairs in length.

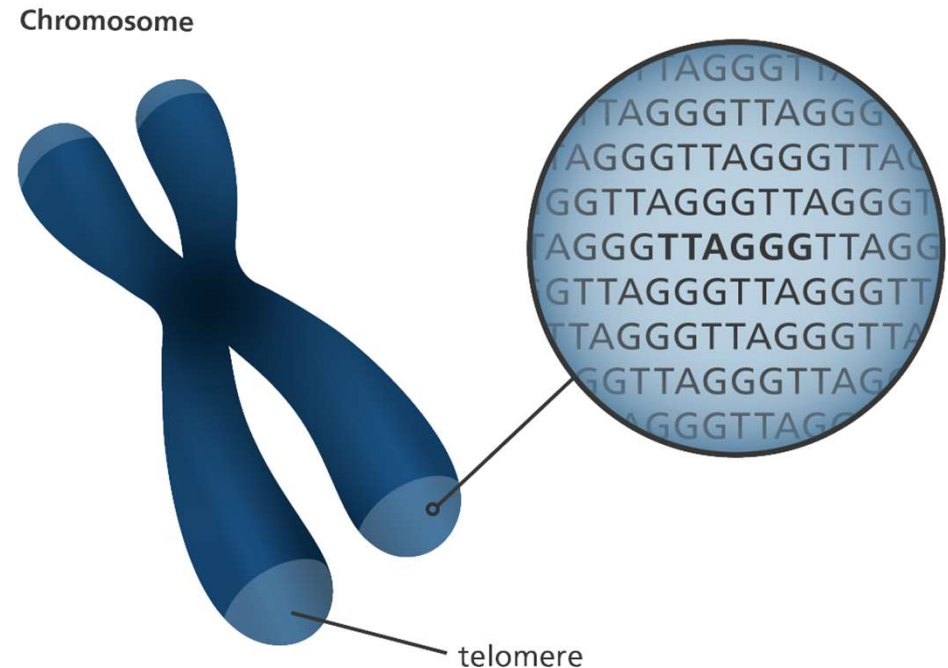
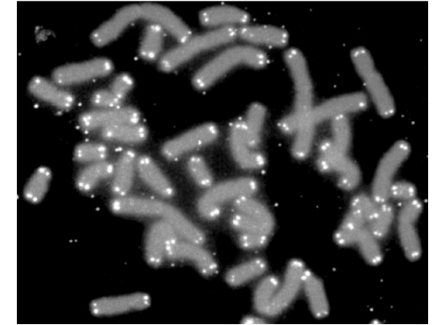

Telomerase

- Ribonucleoprotein, which prevents shortening of DNA ends by adding telomeres – telomeric sequences.
- TERT = telomerase reverse transcriptase.
- TR (TERC) = telomerase RNA component.
- Copies its own small RNA fragment that acts as a template.
- Requires 3' - end as primer.
- Synthesis takes place in the direction of 5' - 3'.

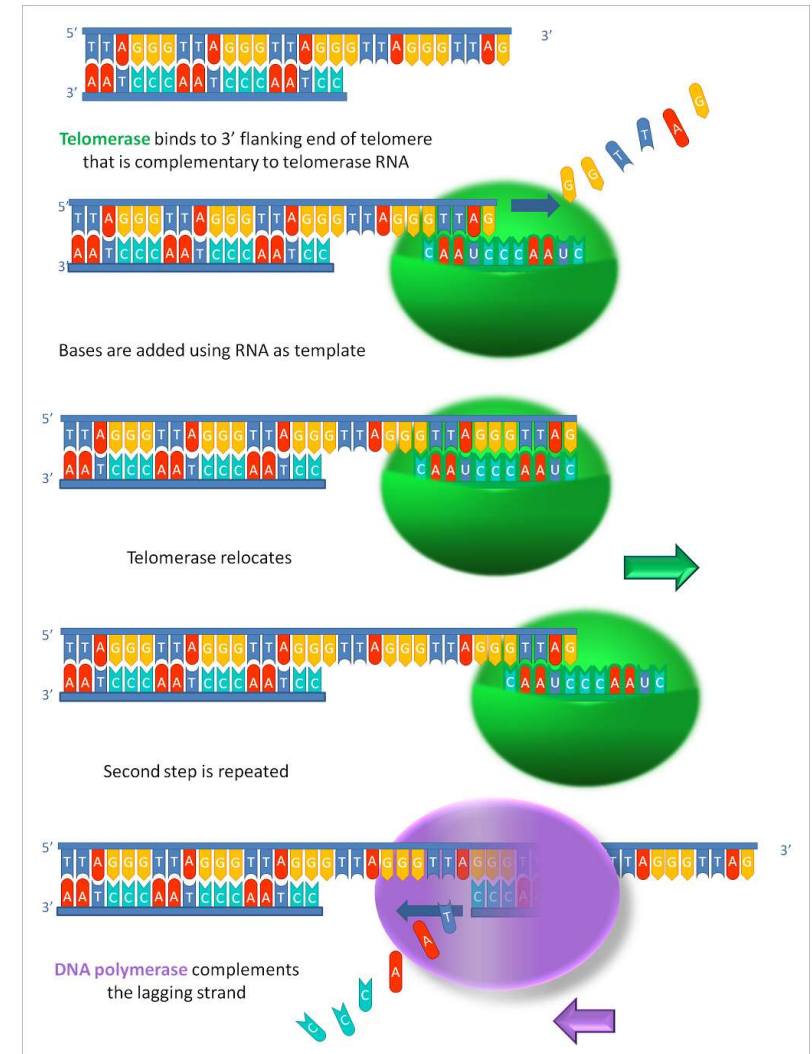

Replication of ends of chromosomes

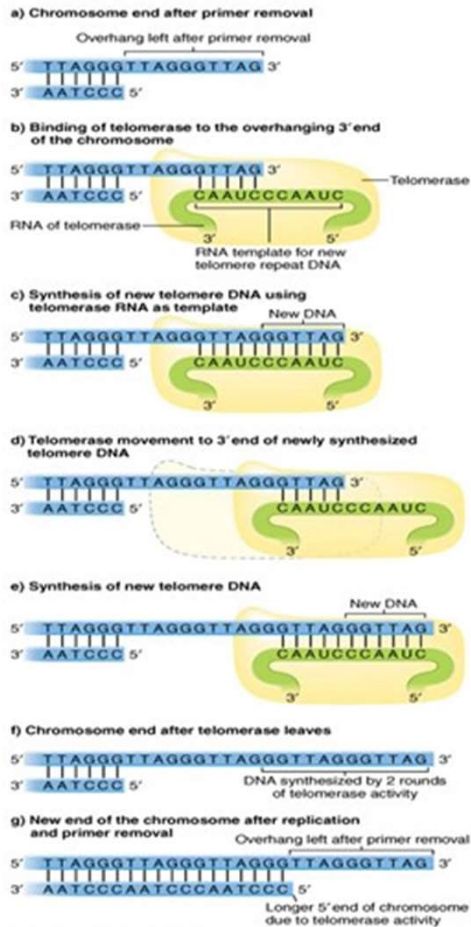

© 2010 Pearson Education, Inc.

- The RNA component of Telomerase (451 bases in humans) includes an 11 base template RNA sequence that is used for the synthesis of new telomere repeat DNA. Thus, telomerase acts as a reverse transcriptase (TERT).
- The 3'CAAUC5' sequence on RNA interacts with the 5'GTTAG3' sequence on DNA.
- The remaining 3'CAAUC5' sequence on RNA acts as a template to fill in the 5'GGTTAG3' sequence on DNA. The process repeats.
- The alternative strand of DNA gets filled in using DNA as a template.
- Complementary strand is synthesized by DNA-polymerase.

Function of Telomerase

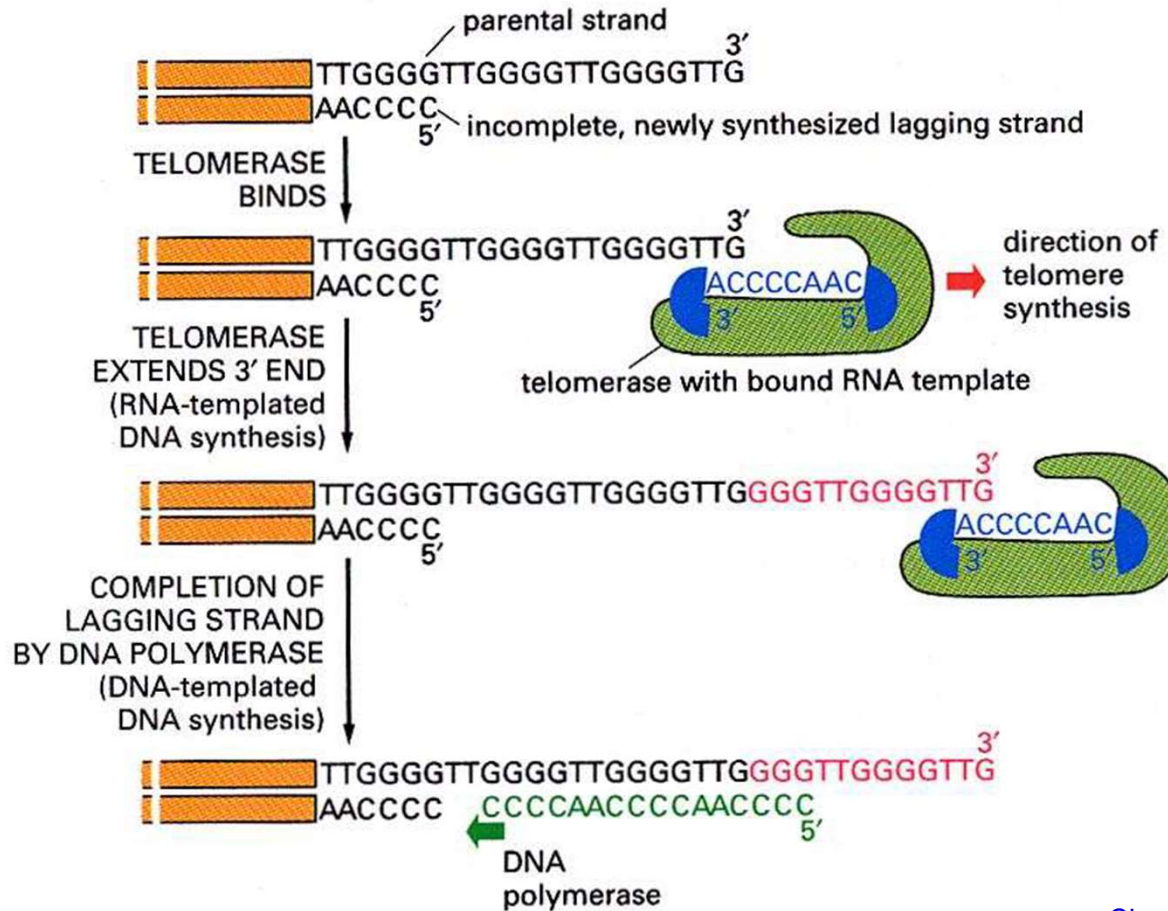

- Telomerase enzymatic activity summary.

[Clear view of telomerase at last \(acs.org\)](https://acs.org)

Telomerase structure

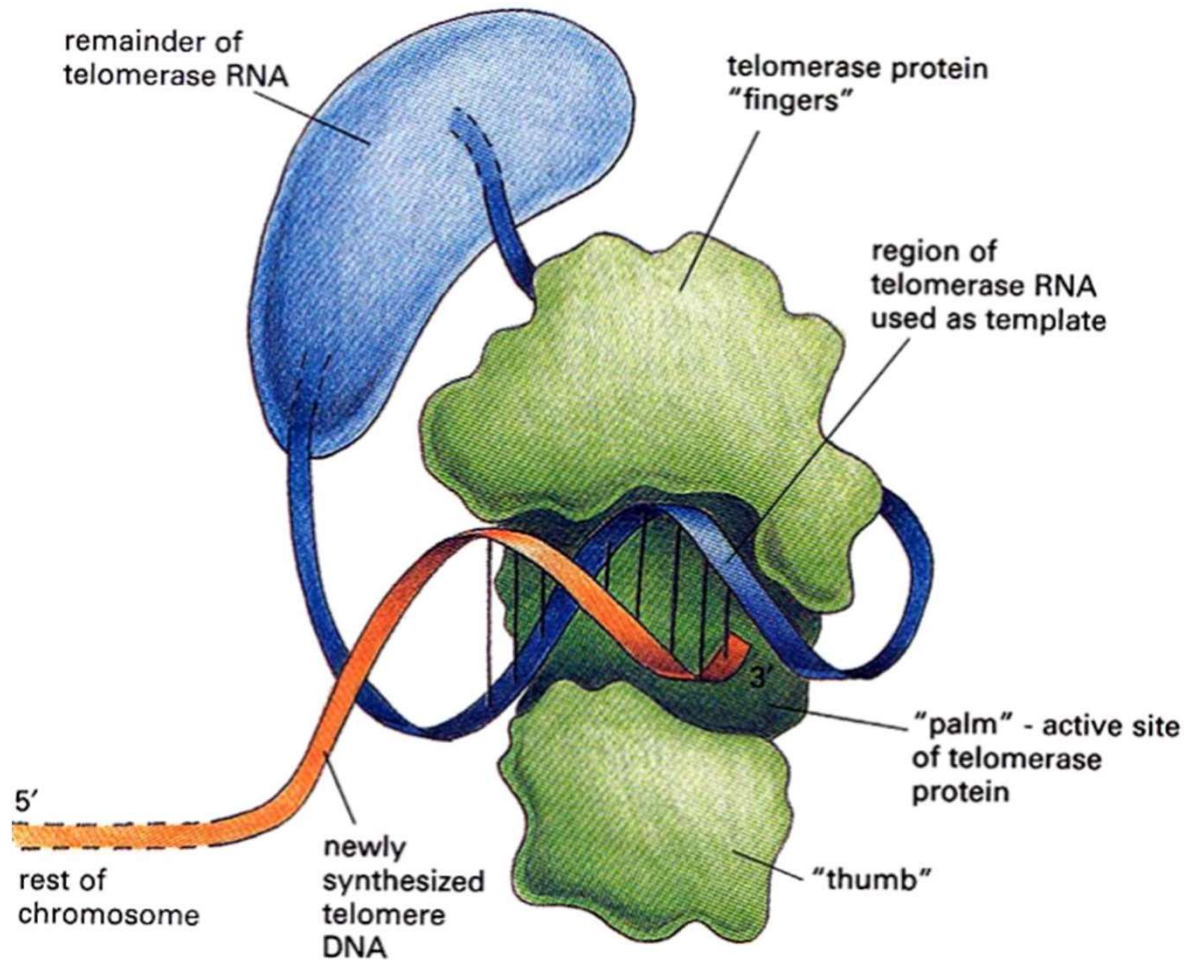

- „fingers“

- The enzyme is composed of protein and RNA.

- „palm“

- „thumb“

Telomeric sequences in various organisms

- **TTGGGG** - T_2G_4 u *Tetrahymena thermophila* a *Glaucoma chattoni*
- **TTTTGGGG** - T_4G_4 u *Euplotes aediculatus* a *Oxytricha nova*
- **TTTAGGG** - $T_3A_1G_3$ u *Arabidopsis thaliana*
- **TGGG** - TG_3 u *Saccharomyces cerevisiae*
- **TTAGGG** - $T_2A_1G_3$ man and mouse, a *Trypanosoma brucei*

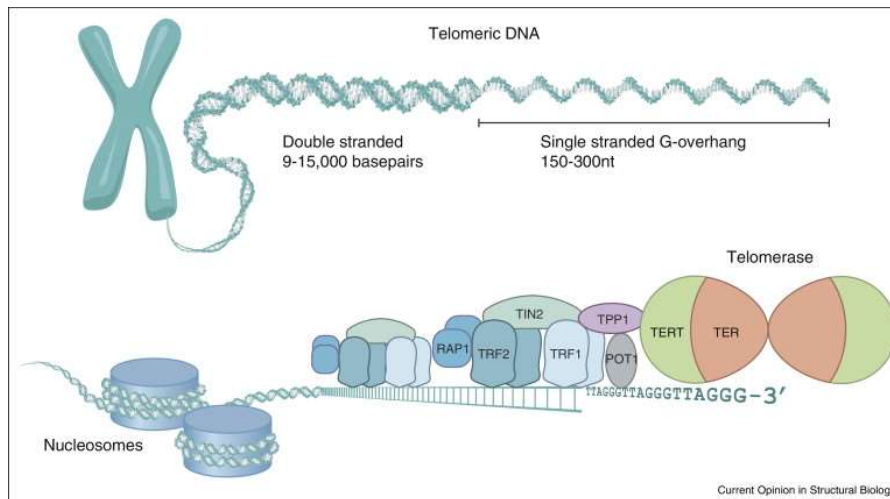

Telomeric repeats – control of the cell cycle

- In 1984, Blackburn co-discovered telomerase, the enzyme that replenishes the telomere.
- For this work, she was awarded the 2009 Nobel Prize in Physiology or Medicine.

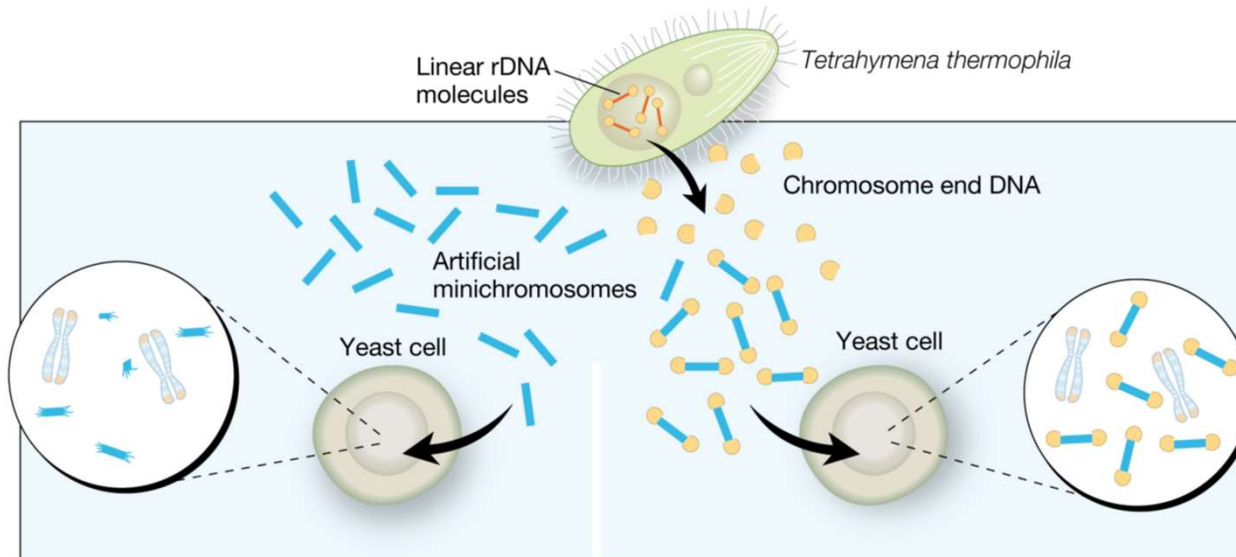

Elisabeth Blackburn
(1948 -

Shelterins

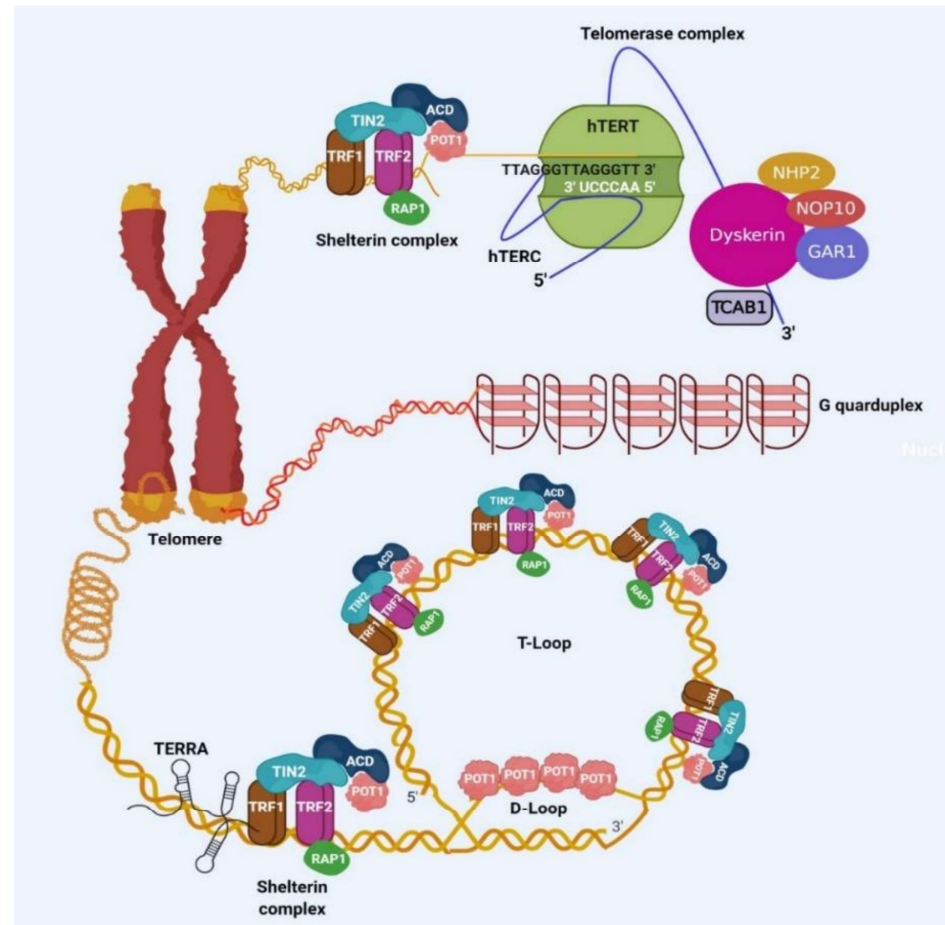

Length of telomerase and aging

- Most somatic cells do not have telomerase activity (unlike stem or tumor cells) - telomeres are gradually shortened.
- Human somatic cells grown in culture pass only to a limited extent the number of divisions (50 - 70 generations) - then the division stops, occurs aging and death (replicative cell senescence).
- Correlates the length of telomeres and the number of cell divisions through which the cell passed, which indicates her old age and nearness of death.

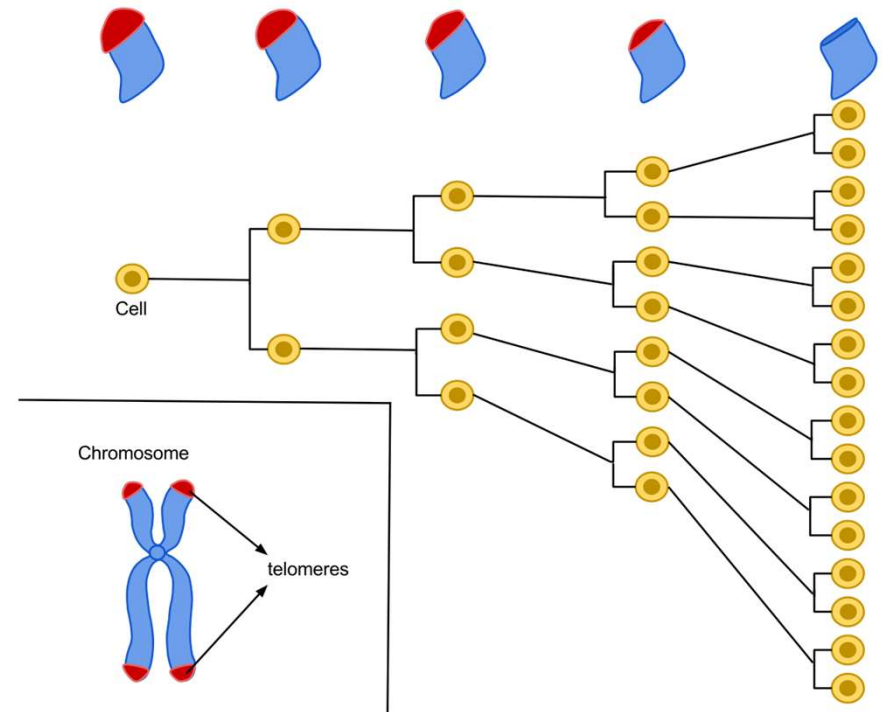

Hyiflick's limite - molecular clock



- Leonard Hayflick, 1961: 3 phases of cell growth.
- Phase 1: Rapid Division.
- Phase 2: Slow division.
- Phase 3: Stopping division followed by aging and cell death.
- Human cells stop after 50 divisions.

Chromatin

- DNA strands in eukaryotic cells arrange themselves in higher conformational structures with help of specialized proteins.
- Interphase DNA: regular winding by nucleosomes.

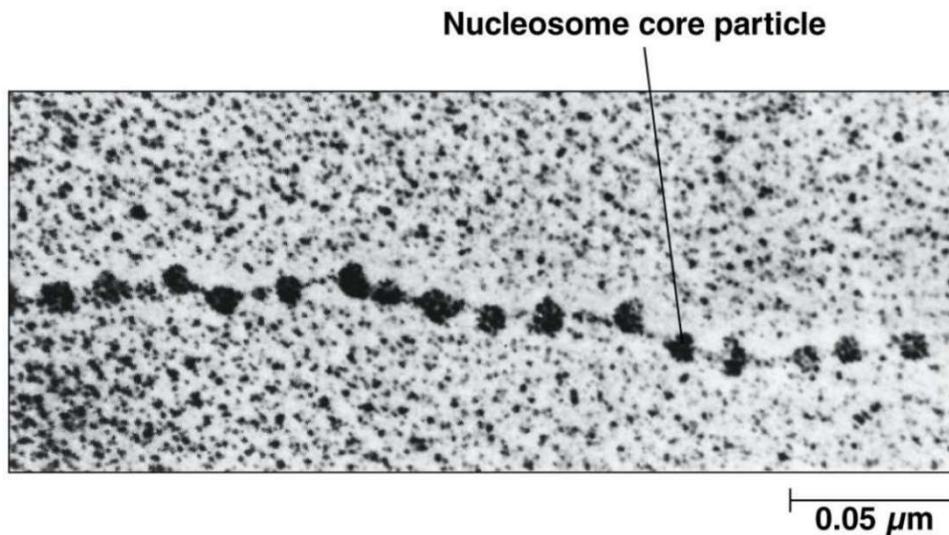
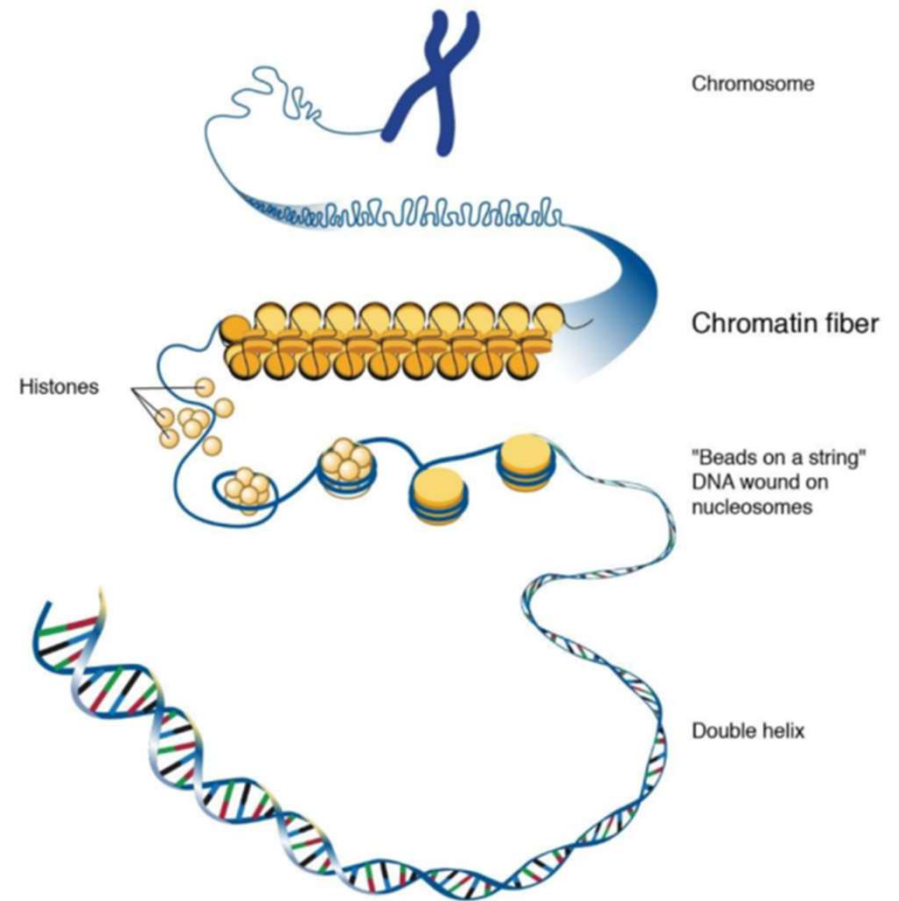

© 2012 Pearson Education, Inc.

Structure of nucleosome

- The core of nucleosome is formed by octamer of histones:
 - 2xH2A (2x)
 - 2xH2B (2x)
 - 2xH3 (2x)
 - 2xH4(2x)
- Complete nucleosome is formed by attachment of one molecule of histone H1.
- Interactions between nucleosomes mediated by H1 and DNA results in formation of compact structures (30 nm fiber).
- Protects DNA from nucleases.

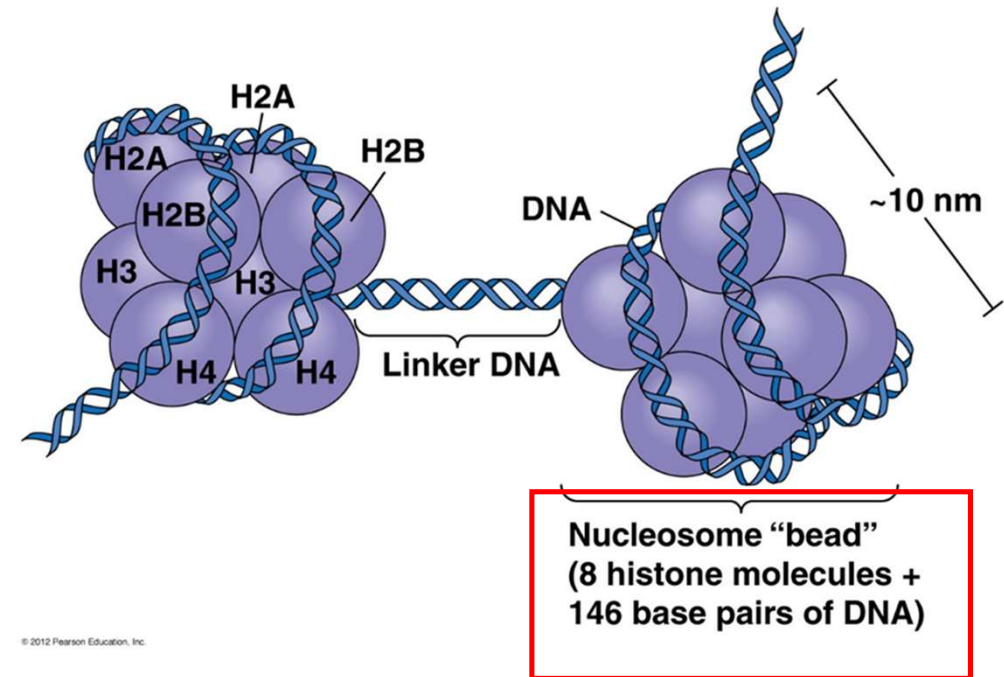

Structure of nucleosome

- Each cell exhibits a specific arrangement of heterochromatin and euchromatin.

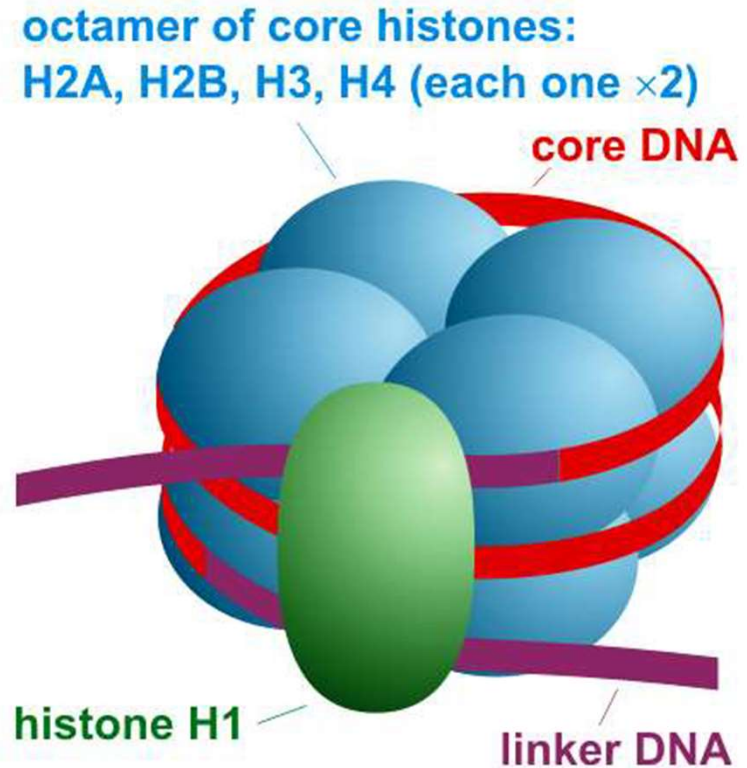
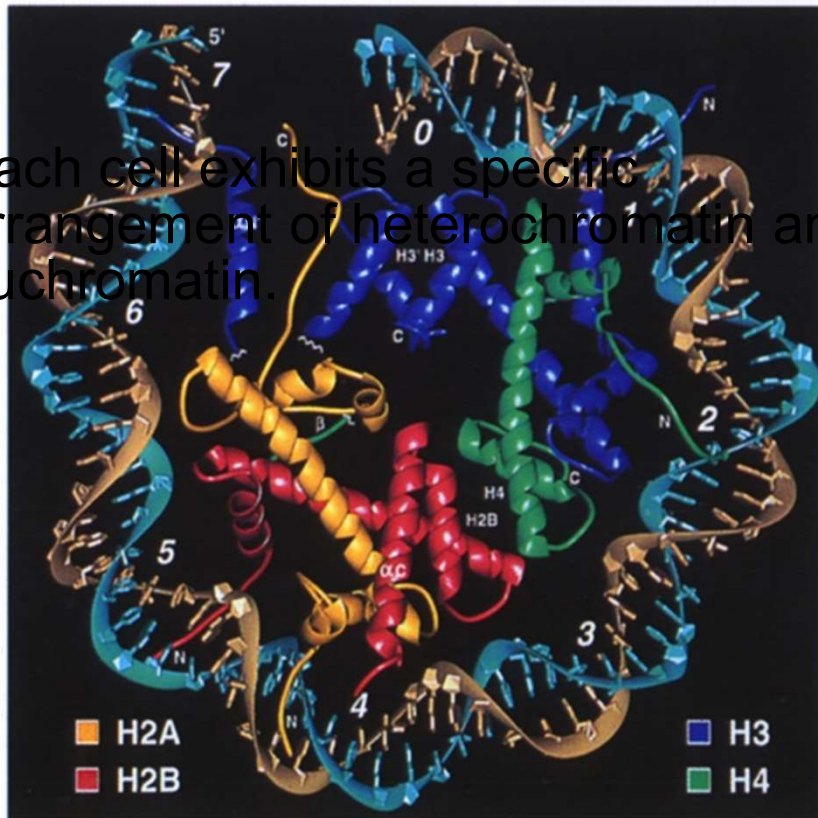

Levels of chromosome organization

- Eukaryotic genomic DNA associates with histones into the chromatin.
- **Heterochromatin** (highly condensed, transcriptionally inactive) areas.
- **Euchromatin** (relaxed and available for binding, transcriptionally active).
- Each cell exhibits a specific arrangement of heterochromatin and euchromatin.

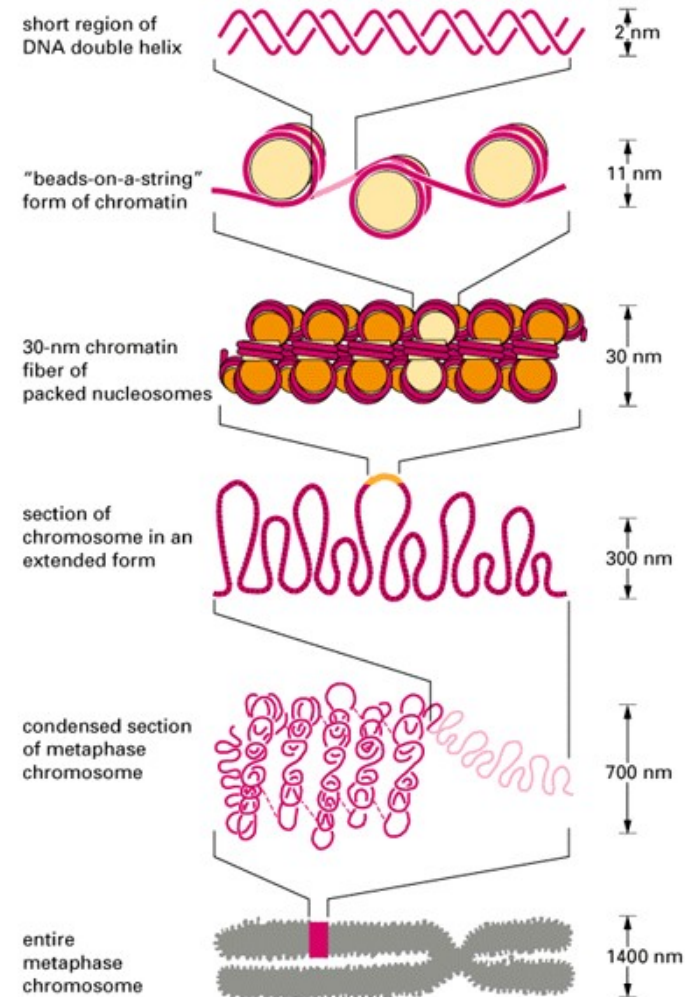

Duplication of nucleosome in replication forks

- EM: nucleosomes maintain their structure and distance from each other on both sides of the replication fork.

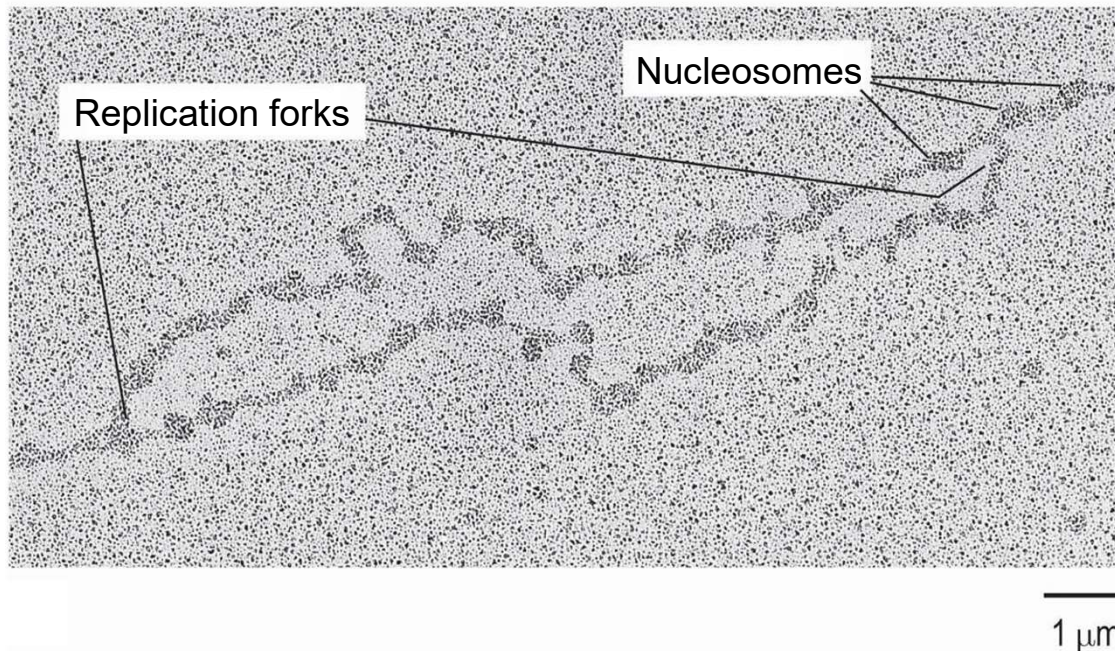

- Nucleosomes decay and fold quickly to allow proper DNA replication.
- Histones are synthesized preferably during the S-phase.

Nucleosome replication

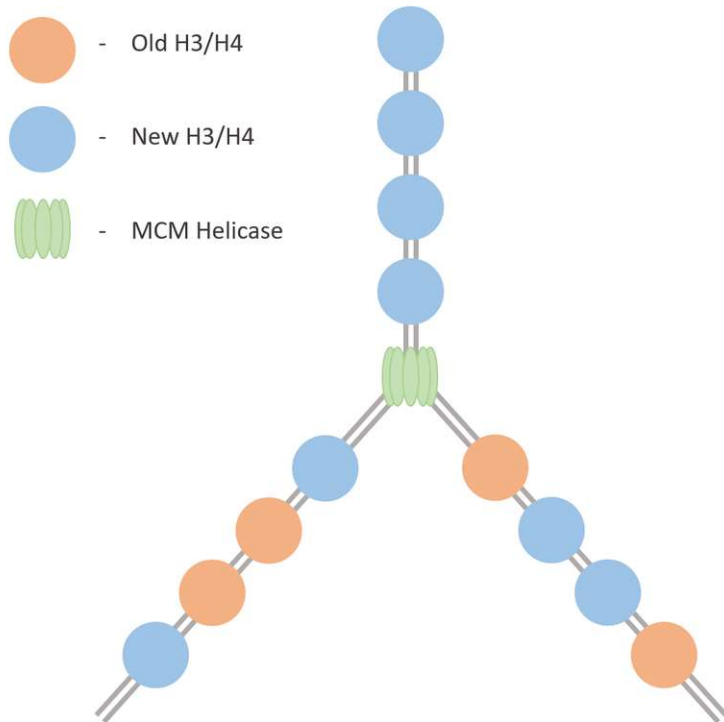

- Translocation of MCM helicase along the leading strand disrupts parental nucleosome octamers, resulting in the release of H3-H4 and H2A-H2B.
- Reassembly of nucleosomes behind the replication fork is mediated by chromatin assembly factors (CAFs).
- Labeling experiments indicate that nucleosome duplication is predominantly conservative.
- “Old” and “New” histones are assigned to each daughter strand semi-randomly, resulting in equal division of regulatory modifications.

Nucleosome replication

- When eukaryotic DNA is replicated, it complexes with histones. This requires the synthesis of histone proteins and the assembly of new nucleosomes.
- Transcription of histone genes is initiated near the end of the G1 phase and the translation of histone proteins occurs throughout S phase.
- An H3/H4 tetramer is reused in 1 new strand.
- H2A/H2B is broken down to 2 dimers which are reused arbitrarily.

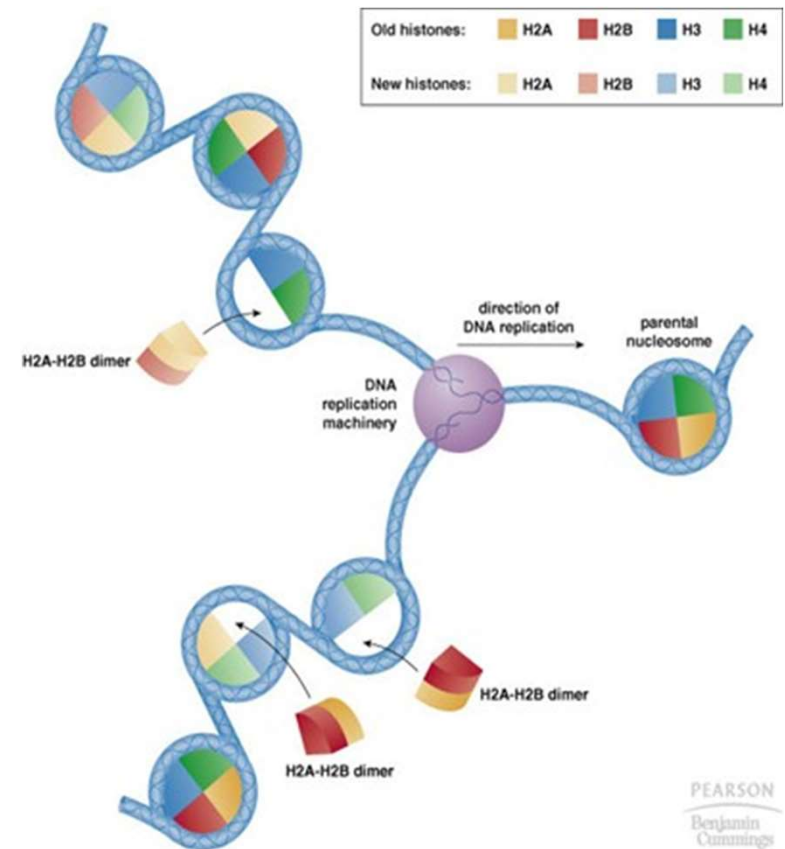

Nucleosome replication

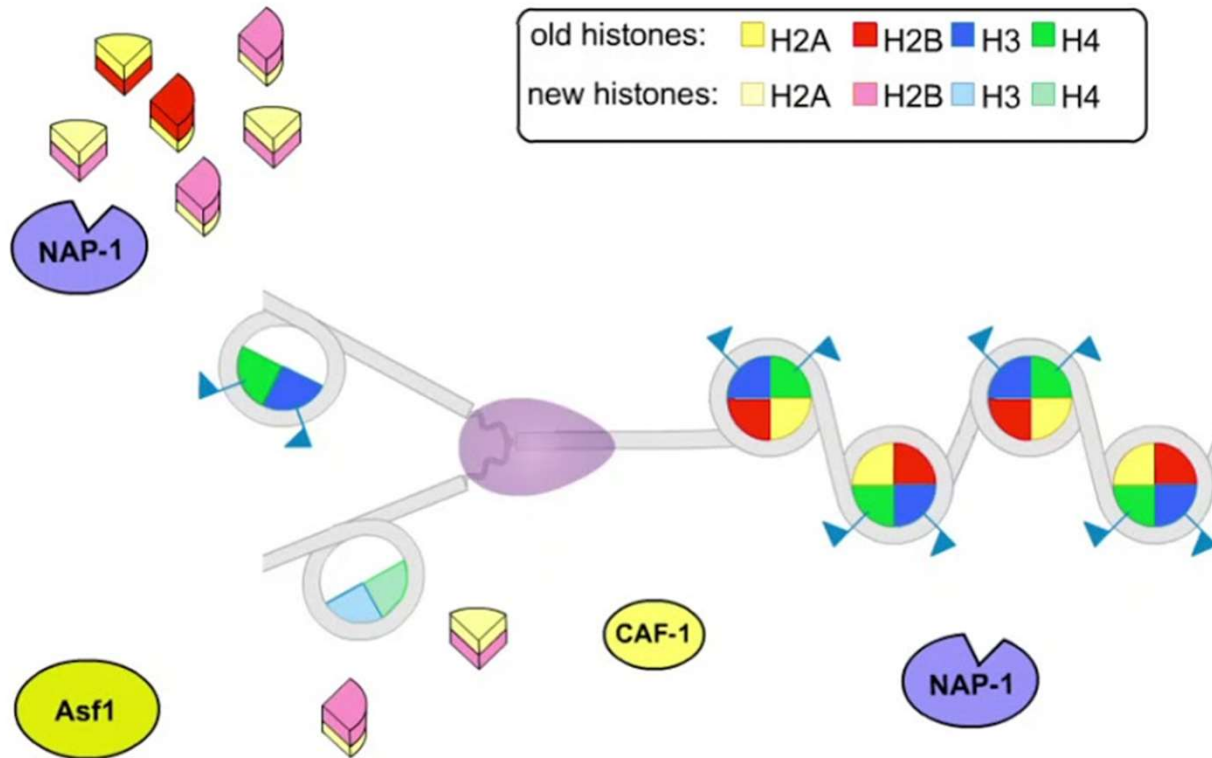

- Participation of specific proteins:
- Nap-1 (nucleosome assembly protein 1): is responsible for transfer of histones from the site of their synthesis in the cytoplasm to the nucleus.
- CAF-1 (chromatin assembly factor 1): ensures the transfer of histones to the site of DNA replication, where nucleosomes are assembled, it also binds to PCNA.

THANK YOU FOR YOUR ATTENTION

Paramecium Parlor

