

# *Analysis of*

# *Biological Data*

Stano Pekár

# Content

- 1) R Environment  
Exploratory Data Analysis  
Regression models
- 2) The first example  
Systematic components
- 3) Stochastic components  
Analyses of continual measurements
- 4) Analyses of continual measurements II  
Analyses of counts
- 5) Analyses of counts II  
Analyses of proportions

# Literature

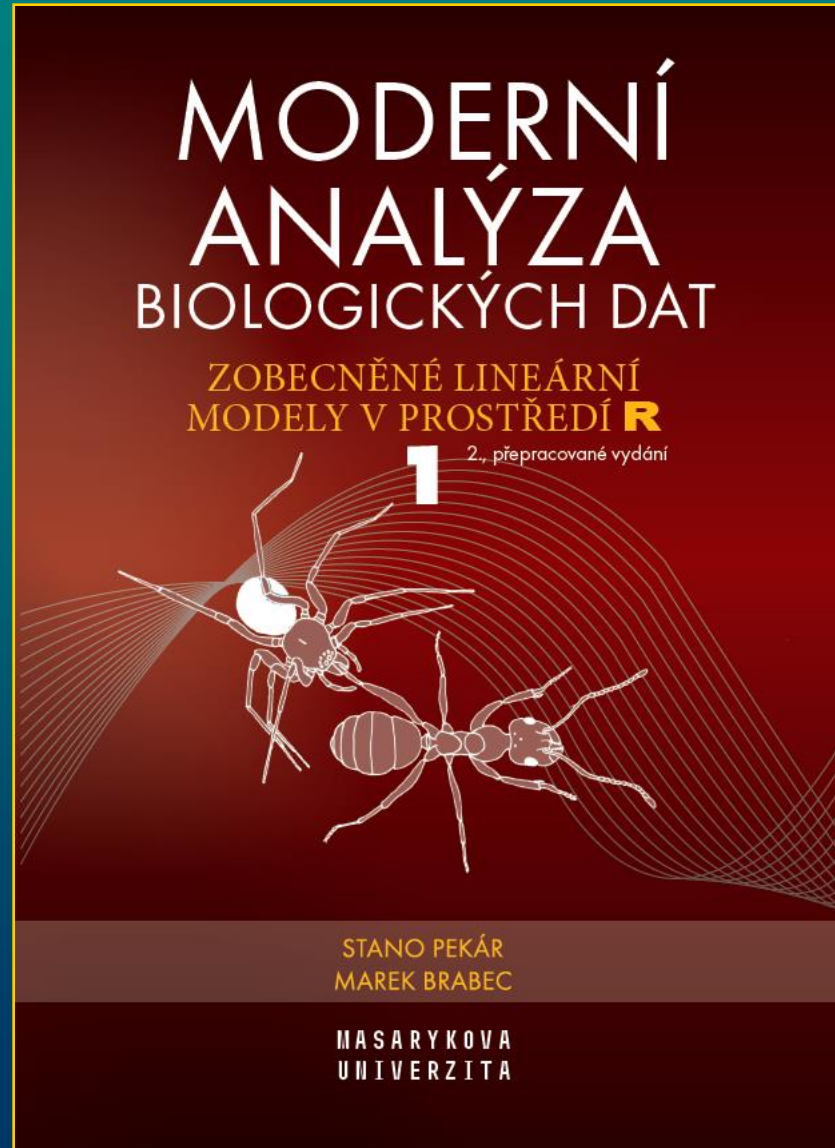
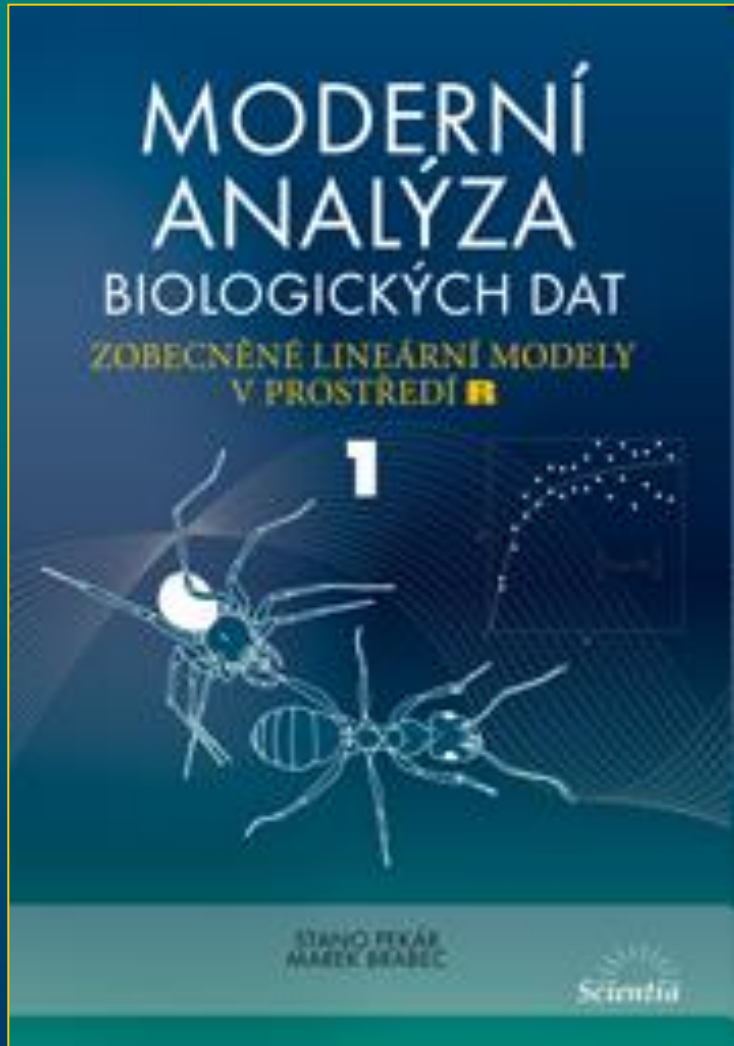

# Statistical analysis

- very fast due to use of computers
- chose statistical models that approach data characters

## This course

- focuses on regression models in a broad sense
- only on linear models
- with only one response variable (**univariate** methods)
- with independent observations

# Variables

## Response variable

- (dependent) is the variable whose variation we aim to understand, the variable that we measure, it goes on ordinate
  - continuous measurement, count, proportion ( $y$ )

## Explanatory variable

- (independent) is the variable that we manipulate (select levels), interested to what extent is variation in response associated with variation in explanatory variables, displayed on abscissa
  - numeric: continuous or discrete measurements ( $x$ ) .. covariate
  - categorical .. a factor ( $A, B$ ) with two or more levels ( $A_1, A_2, .. B_1, B_2, ..$ )

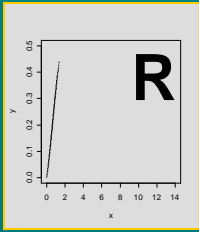

# *Statistical* *Statistical* **Software**

Stano Pekár

# Software

- software packages that include GLM



# What is R ?

- environment for the manipulation of objects
  - data manipulation, calculation and graphical display
  - a high-level programming language
- combination of S (developed at AT&T Bell Laboratories and forms the basis of the S-PLUS systems) and Scheme languages
- initially written by Gentleman & Ihaka (1996), nowadays with many contributors (R Development Core Team)
  - includes about 30 standard packages
  - available 2000 additional packages
- user-unfriendly (limited pull-down menus)
  - based on commands
  - pull-down menus only for basic commands



# Why R ?

## Pros

- freeware
- one of the largest statistical systems
- open environment with more dynamic development than other systems
- whereas Statistica or SAS will give copious output, R will provide minimal output
- makes you think about the analysis

## Cons

- no warranty
- user-unfriendly

# Instalation

- software available from [www.r-project.com](http://www.r-project.com)
- data from
- <https://www.press.muni.cz/edicni-rady-munipress/moderni-analyza-biologickych-dat-1>

# Basic operations

+ - \* / > <

== equal

!= not equal

<= less than or equal

^ power

- logical values **T** .. TRUE, **F** .. FALSE

## Functions

- trigonometric

**sin, cos, tan, asin, acos, atan**

- logarithmic: **log, log2, log10**

- **sqrt, exp, abs, sum, prod**

- **seq, c, which, length, cbind, xbind, matrix**

- names are case sensitive
  - “\_” is not allowed to use
  - vectors: numeric, character, logical
  - arguments (in parentheses): use their names or without at specified order
- 
- centring: to subtract mean
  - scaling: to divide by SD

```
> mean(y)
[1] 6
> var(y)
[1] 11
> y2 <- scale(y); y2
```

```
attr(,"scaled:center")
[1] 6
attr(,"scaled:scale")
[1] 3.316625
> mean(y2)
[1] 0
> var(y2)
      [,1]
[1,]     1
```

# Data frames

## Created in R:

- use `data.frame`, `rep`, `factor`, `levels`, `relevel`
- export: `write.table`

## Imported:

- from Excel via clipboard

```
dat <- read.delim("clipboard")
```

- data matrix:
  - number of columns = number of variables
  - first row contains names of variables (names without blank spaces)

- each row corresponds to an observation (trial, etc.)
- factors levels can be names or coded as numbers
- all columns must have the same number of rows
- missing data are assigned as **NA**

- `is.na`

- `$`

`attach(dat)`

`names(dat)`

soil	field	distance	amount
moist	pasture	12	0.22
moist	pasture	22	0.11
moist	pasture	43	0.29
moist	pasture	23	0.33
moist	rape	32	0.19
moist	rape	67	0.39
moist	rape	54	0.18
moist	rape	NA	0.29
dry	pasture	11	1.16
dry	pasture	33	1.03
dry	pasture	45	1.11
dry	pasture	NA	1.33
dry	rape	55	1.02
dry	rape	41	1.23
dry	rape	14	1.05
dry	rape	27	1.12

```
> size <- rep(c("small","medium","large"), c(4,3,4)); size
[1] "small" "small" "small" "small" "medium" "medium" "medium"
[8] "large" "large" "large" "large"
> dat <- data.frame(x, y, size); dat
  x y size
1 1.0 1 small
2 1.1 2 small
3 1.2 3 small
```

```
> is.factor(size)
[1] FALSE
> size <- factor(size)
```

```
> levels(size)
[1] "large" "medium" "small"
> size1 <- relevel(size, ref="medium"); levels(size1)
[1] "medium" "large" "small"
```

*Exploratory*

*Exploratory*  
*Data Analysis*



# EDA

- a visual (tabular or graphical) analysis of the data

Important to

- check errors
  - get an idea of the result
  - suggest a model
  - check assumptions for use of desired methods
  - set hypotheses
  - look for unexpected trends
- 
- use expected values and variation

# Expected value

- $E(y)$ ,  $\mu$ : theoretical long-term average of a variable
  - one of a few characteristics of a distribution
  - for discrete distributions  $E(y)$  might not be a possible value
  - estimate of  $E(y)$  is **mean ... mean**
  - a robust estimate for asymmetric distributions is **median: ... median**
  - another robust estimate is **trimmed mean**: mean where  $\alpha * n$  observations are removed from each tail ... **mean(y, trim=)**

## Example

Find mean, median, and mean trimmed by 10% of the *amount* variable.

```
> mean(amount)
[1] 0.690625
> median(amount)
[1] 0.705
> mean(amount, trim=0.1)
[1] 0.6864286
```

# Variance

- $\text{Var}(y)$ ,  $\sigma^2$ : a theoretical measure of the variability
- minimum and maximum ... **range**, **min**, **max**
- quantiles (0, 25, 50, 75, 100%) ... **quantile**
- estimate of  $\text{Var}(y)$  is  $s^2$ ... **var**
- standard deviation ( $s$ ) ... **sd**
- standard error of the mean ...

$$SEM = \frac{s}{\sqrt{n}}$$

## Example

Find variance, standard deviation, range and standard error of the mean for *amount*.

```
> var(amount)
[1] 0.2162996
> sd(amount)
[1] 0.4650802
> sem <- sd(amount)/sqrt(length(amount)); sem
[1] 0.1162700
```

# Confidence Intervals

- of a parameter (mean): if large number of samples is taken from a population then  $\alpha\%$  of intervals will contain mean
- based on quantiles of the t distribution **qt**

- lower  $CI_{95}$

$$\bar{y} - t_{0.975, \nu} \times SEM$$

$$\nu = n - 1$$

- upper  $CI_{95}$

$$\bar{y} + t_{0.975, \nu} \times SEM$$

- for asymmetric distributions  $CI_{95}$  is estimated on transformed values  $\rightarrow$  asymmetric intervals

## Example

Find 95% confidence intervals of mean for *amount*.

```
> mean(amount) + sem*c(qt(p=0.0255,df=15), qt(p=0.975,df=15))  
[1] 0.4428013 0.9384487
```

# Tabular analysis

- basic summaries (min, max,  $Q_{25}$ ,  $Q_{75}$ , median, mean) for all variables.. **summary**
- summary table for data with explanatory variable(s) .. **tapply**
- to count frequencies .. **table**

## Example

Make a table of means for *SOIL* and *FIELD*, and table of SEM for *FIELD*.

```
> tapply(X=amount, INDEX=list(soil,field), FUN=mean)
      pasture  rape
dry      1.1575 1.1050
moist    0.2375 0.2625
> tapply(amount, soil, function(x) sd(x)/(sqrt(length(x))))
      dry      moist
0.03776986 0.03223795
```

# Graphics

- see `demo (graphics)` or `demo (image)`
- graphs
  - basic: `plot`
  - advanced: `xyp1ot` (library *lattice*)
- to get all graphic parameters: `?par`
- to split window to subplots: `par (mfrow)`
- to add legend .. `legend`
- graph window size: `x11`

# plot

<u>Argument</u>	<u>Values</u>
<b>type=</b>	Style: "n" (empty), "p" (scatter), "l" (lines), "b" (both), "h" (vertical)
<b>las=</b>	Style of axes values: 0 (parallel), 1 (horizontal) 2 (perpendicular), 3 (vertical)
<b>xlab, ylab=</b>	Text of axes labels: "..."
<b>cex.lab=</b>	Size of axes labels: 1, ..
<b>xlim, ylim=</b>	Range of axes: <b>c(min, max)</b>
<b>cex.axis=</b>	Size of axes values: 1, ..
<b>log=</b>	Logarithmic scale of <b>x</b> , <b>y</b> or <b>xy</b>
<b>main=</b>	Text of title: "..."
<b>main.cex=</b>	Size of title: 1, ..

# points

<u>Argument</u>	<u>Values</u>
<b>pch=</b>	Type of symbols: 0, ..., 18, "letters"
<b>cex=</b>	Size of symbols: 1, ...
<b>col=</b>	Colour: 1, 2, 3, 4, 5, 6, 7, 8
<b>font=</b>	Font type: 1, 2, 3, 4

1	□		
2	○	16	■
3	△	17	●
4	+	18	▲
5	×	19	◆
6	◇	20	▼
7	▽		



# Distribution plots

- to study distribution of a numeric (response) variable
- histogram .. **hist**
- stem-and-leaf plot .. **stem**
- q-q plots to compare distribution of two variables
  - compare a single variable with normal: **qqnorm**
  - compare distributions of two variables: **qqplot**
  - to add diagonal line: **qqline**

## Example

Make q-q plot of data from normal distribution.

```
> y1 <- rnorm(n=10, mean=0, sd=1)
> y2 <- rnorm(20,0,1)
> y3 <- rnorm(50,0,1)
> y4 <- rnorm(100,0,1)
> qqnorm(y1); qqline(y1)
> qqnorm(y2); qqline(y2)
> qqnorm(y3); qqline(y3)
> qqnorm(y4); qqline(y4)
```

# Deviations from normal distribution

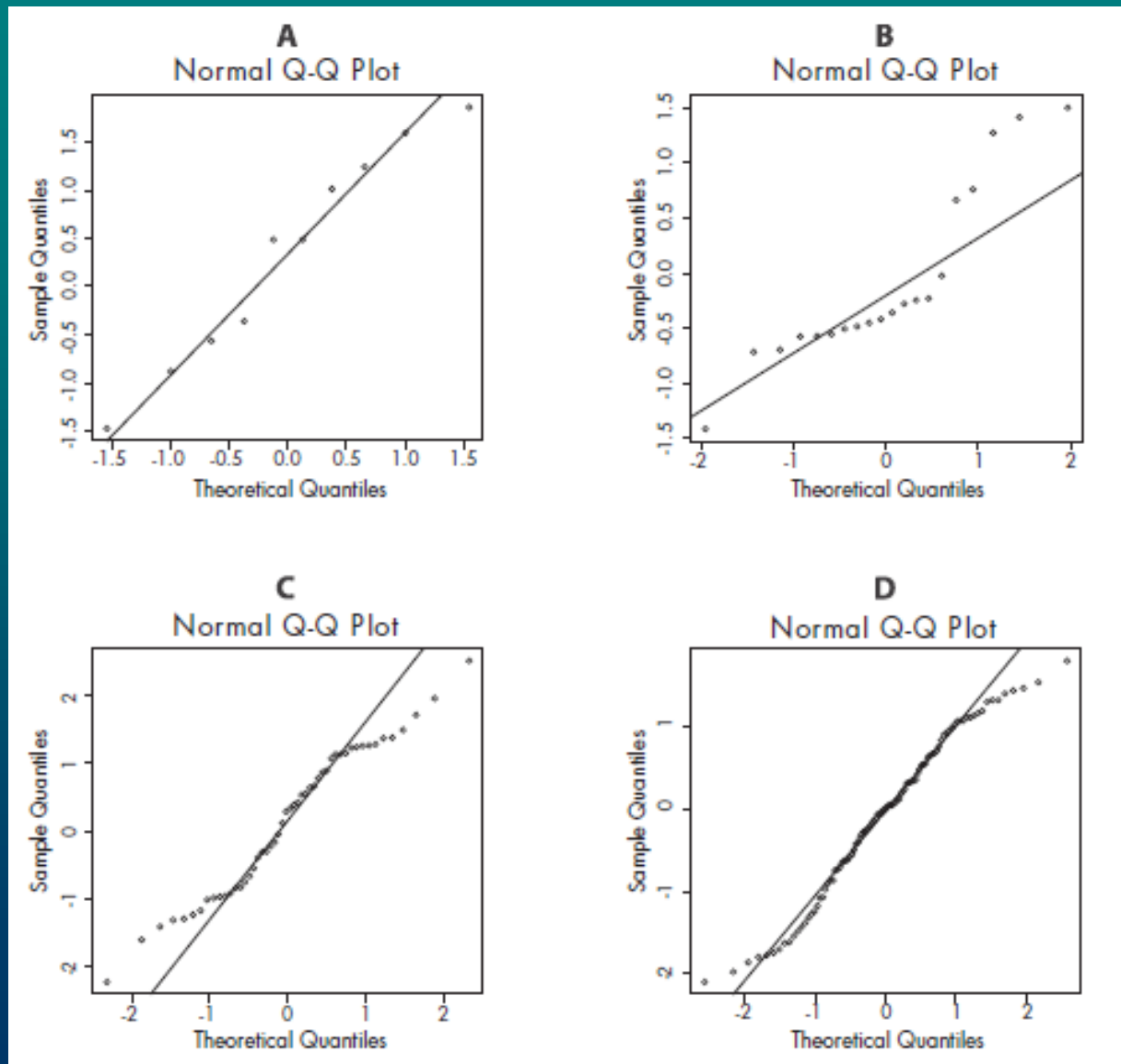

# Scatter plots

- for data with continuous explanatory variables
- to produce plots with points: `plot`

## Example

Make scatterplot of *distance* on *amount* without and with different points for two levels of *SOIL*.

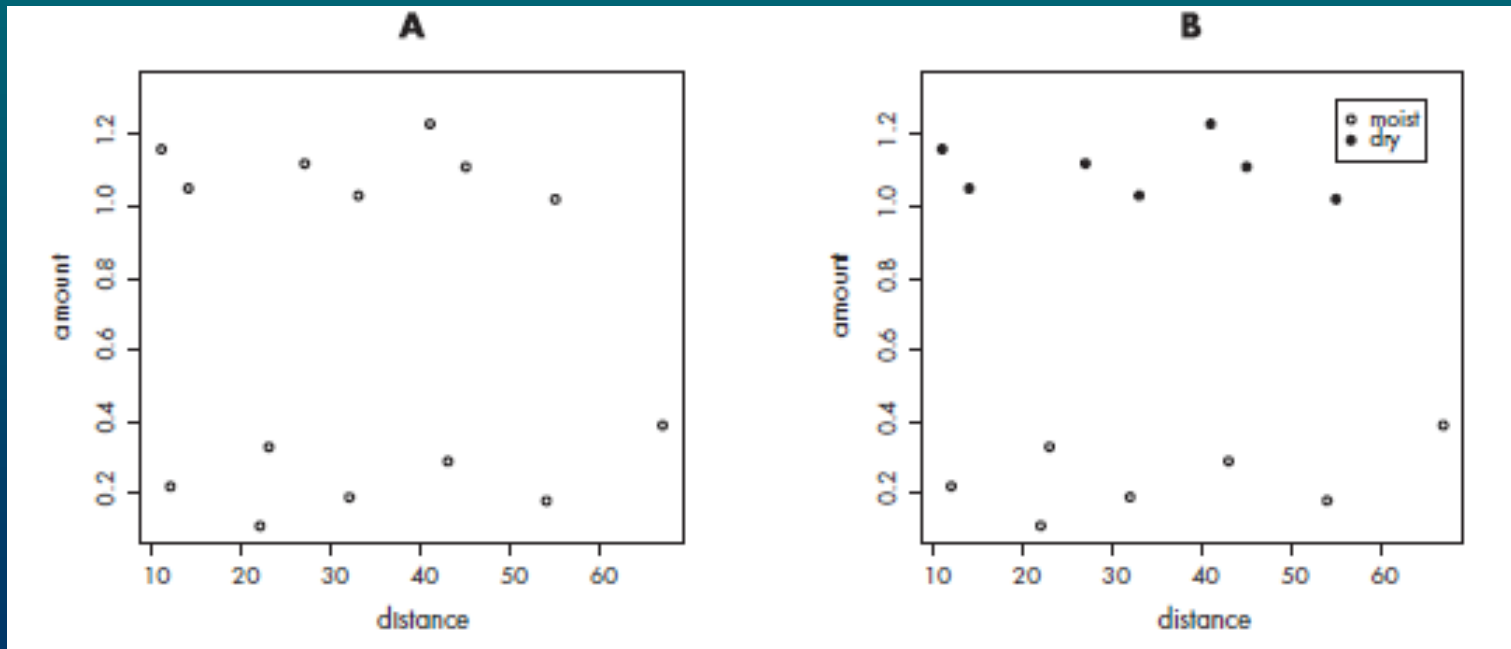

# Box plots

- when there are categorical explanatory variables
- argument **notch** for boxes with  $CI_{95}$  for median

## Example

Make boxplot of *amount* for *SOIL* without and with notches.

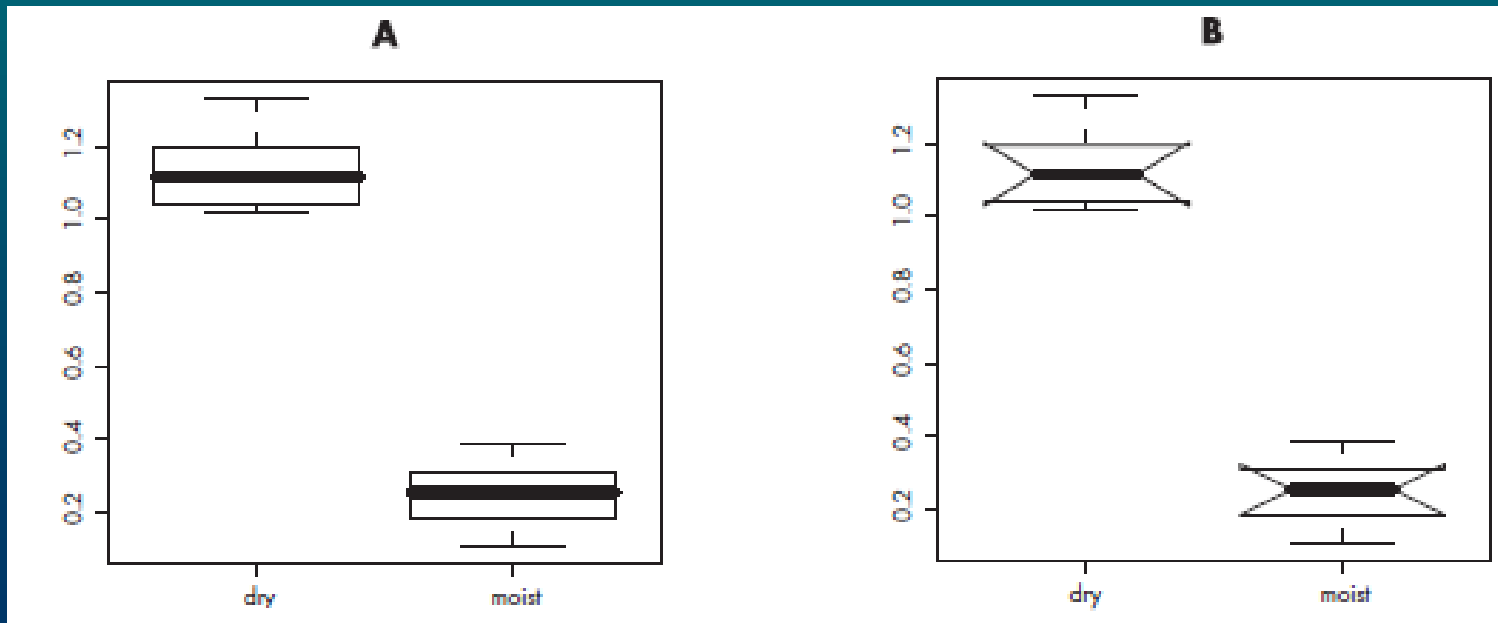

# Panel plots

- for data with both categorical and continuous explanatory variables
- `xypLOT` from library *lattice*

## Example

Make panel scatterplot regression plot of *distance* against *amount* for *SOIL*.

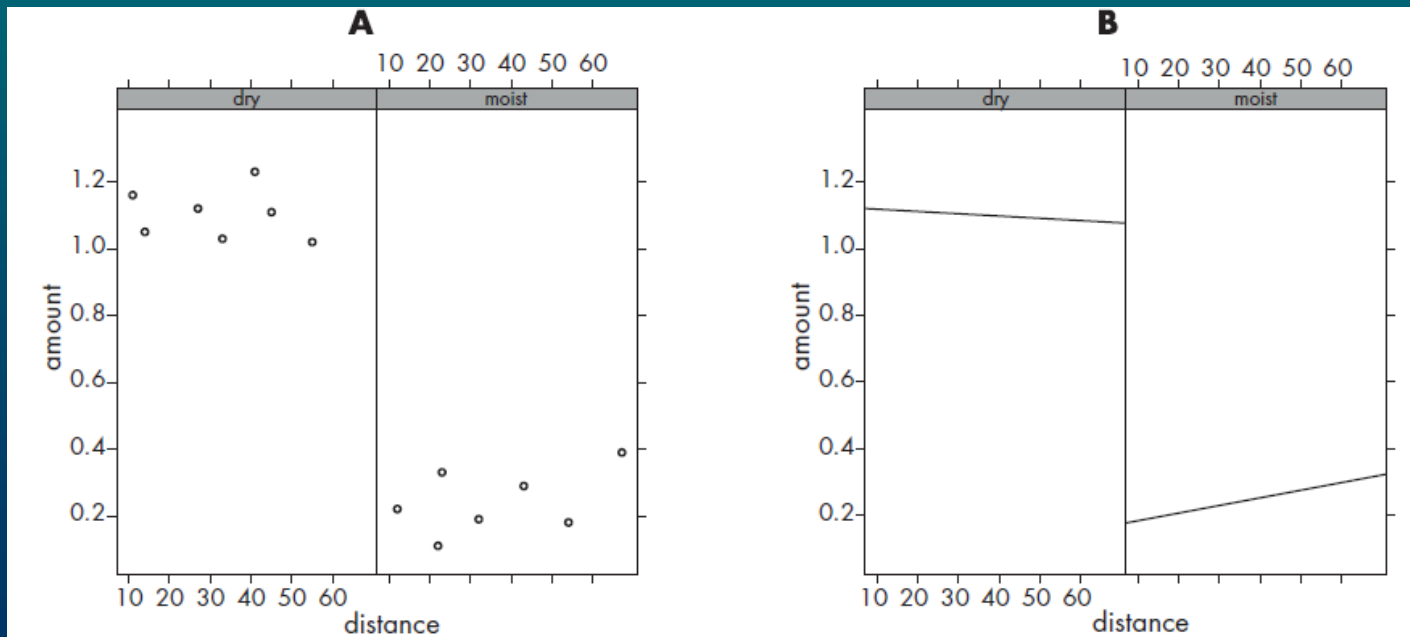

# Interaction plot

- for data with two categorical explanatory variables
- to plot means of two factors ( $A$ ,  $B$ ) connected by lines

`.. interaction.plot`

## Example

Make interaction plot of *SOIL* and *FIELD* for *amount*.

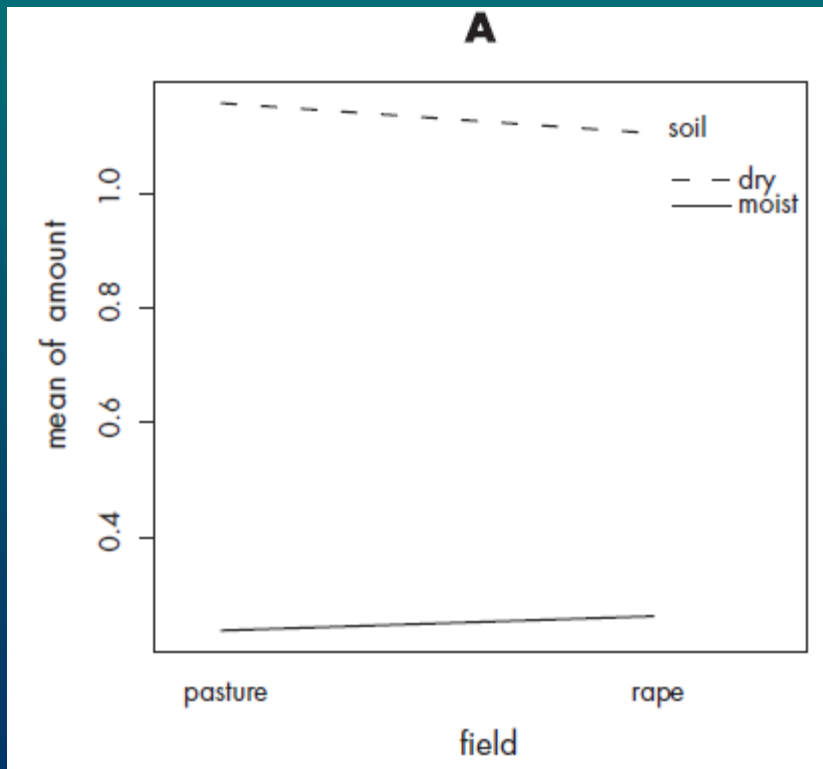

# Bar plot

- when data are counts or proportions
- data are arranged in a matrix or table
- **barplot: beside, legend**

## Example

Make barplot of *SOIL* and *FIELD* for *amount*.

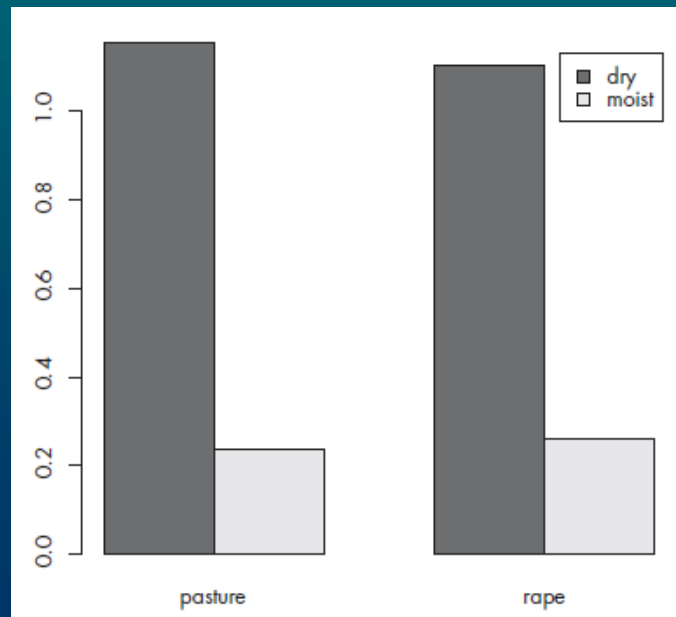

# Paired plots

- when data include several continuous explanatory variables
- **pairs** produces matrix of all possible plots

# 3-dimensional plots

- when data include 2 continuous explanatory variables
- **wireframe** (*lattice*) produces 3-dimensional plot



# Elegant plots

- use *ggplot2* package
- `ggplot`

## Example

Make violinplot of *SOIL* and *amount* and dotplot of *SOIL* and *amount* .

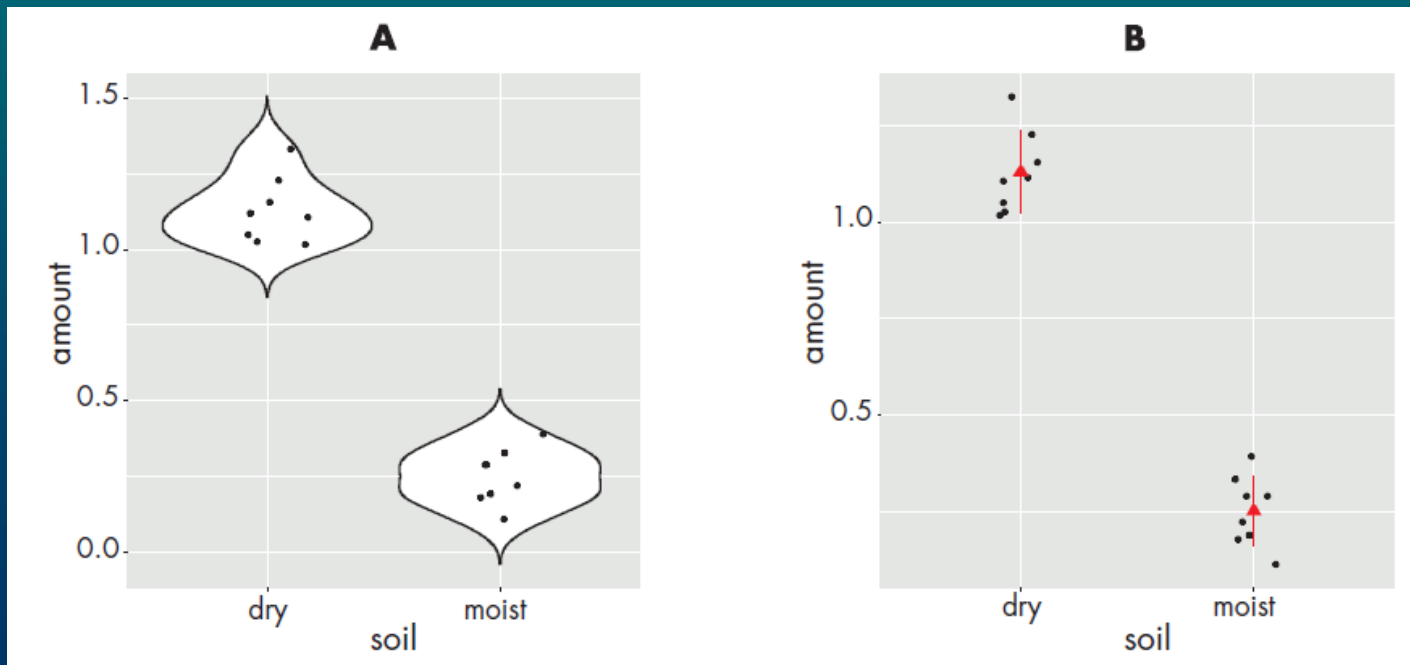

# Graphs with functions

- final plot of estimated models  
use *visreg* package

- **lines** connects points specified by coordinates
- **abline** produces line specified by intercept and slope

## lines

Argument	Values
<b>x, y=</b>	Coordinates: <b>c</b> ( .., ..)
<b>lty=</b>	Line type: 1, ..., 6
<b>col=</b>	Colour: 1, 2, 3, 4, 5, 6, 7, 8
<b>lwd=</b>	Width: 1, ..

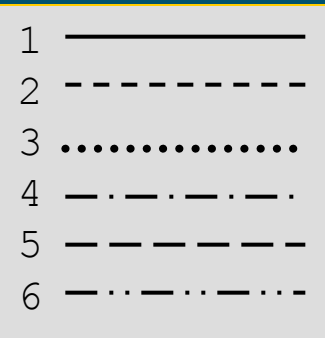

## Example

Make lineplots for the following models:

inverse

$$y = \frac{1}{x}$$

exponential

$$y = e^x$$

logarithmic

$$y = \log(x)$$

power

$$y = x^3$$

logistic

$$y = \frac{1}{1 + e^{-0.3x}}$$

squareroot

$$y = \sqrt{x}$$

quadratic

$$y = 0.6 - 0.1x + 0.006x^2$$

inverse squareroot

$$y = \frac{1}{\sqrt{x}}$$

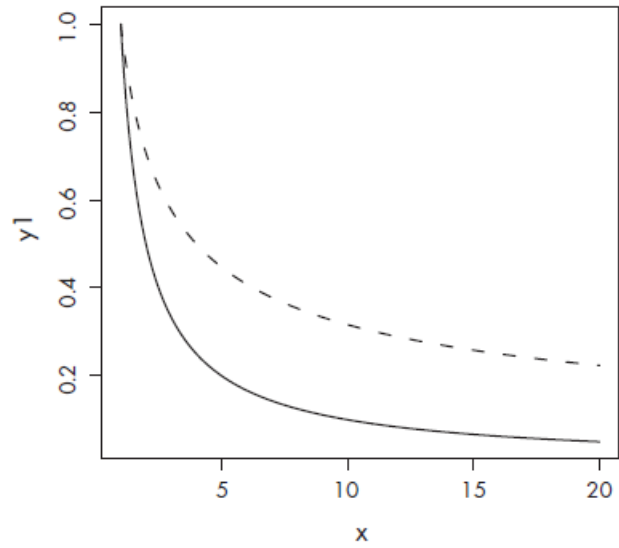
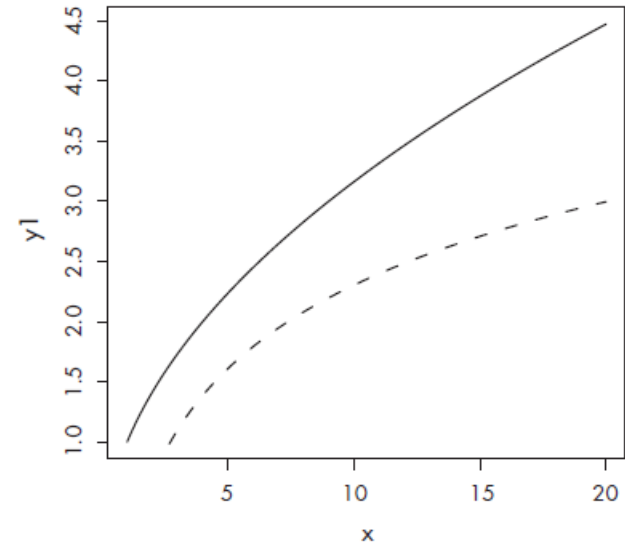
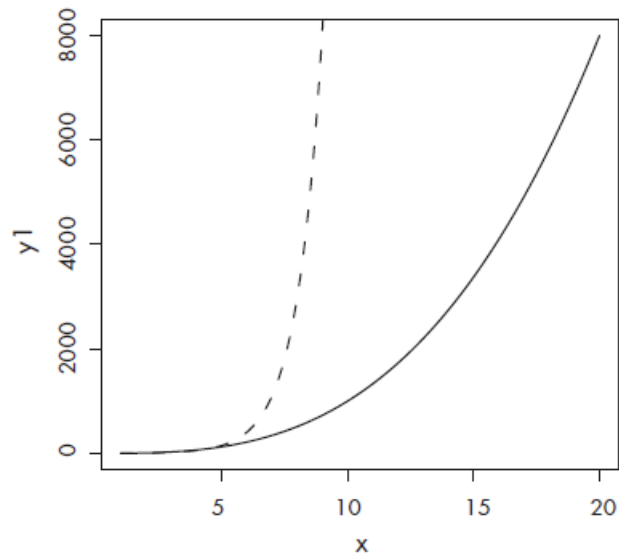
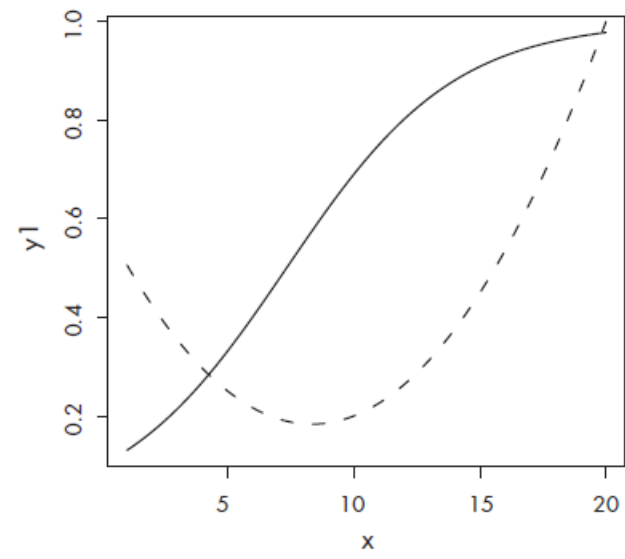
**A****B****C****D**

# *Statistical* *Modelling*

# Regression model

- includes systematic and stochastic components

$$y_i = \alpha + \beta x_i + \varepsilon_i$$

*Deterministic model*

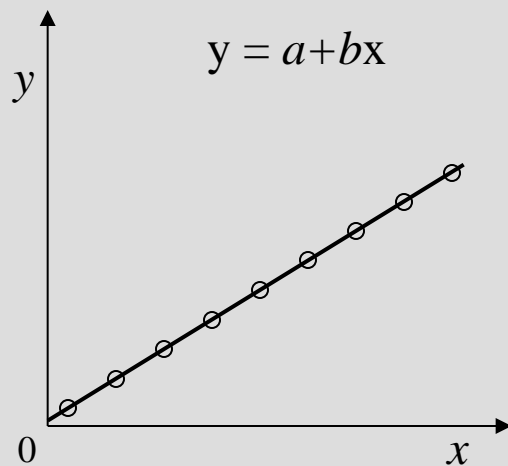

*Statistical model*

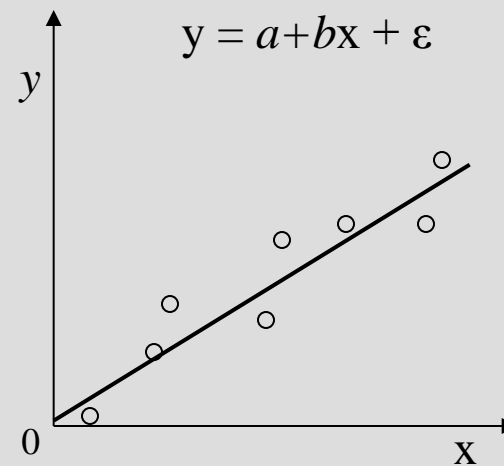

- assumptions of the stochastic component:

$$\varepsilon_i \sim N(0, \sigma^2)$$

$$\text{cor}(\varepsilon_i, \varepsilon_{i'}) = 0, i \neq i'$$

= variance is equal = **homoscedastic** model

To find real model we need to estimate its parameters:  $\alpha, \beta, \sigma^2$

as  $a, b, s^2$  so that we get

$$\hat{y}(x_0) = a + bx_0$$

# General Linear Model

- extension of the systematic component

Simple regression

$$y_i = \alpha + \beta x_i + \varepsilon_i$$



$$\beta = 0$$

$$y_i = \alpha + \varepsilon_i$$

1-way ANOVA

$$y_{ij} = \alpha + \beta A_j + \varepsilon_{ij}$$



$$\beta = 0$$

$$y_i = \alpha + \varepsilon_i$$



**Linear model (LM)** has a general form

$$y = \alpha + \beta_1 x_1 + \beta_2 x_2 + \dots + \beta_k x_k + \varepsilon$$

linear predictor

$x$  can include:  $u^2$ ,  $u^{1/2}$ ,  $\log(u)$ ,  $\exp(u)$ ,  $\sin(u)$ , factors

= model is linear in parameters when it includes only linear combinations of parameters

Some nonlinear relationships can be linearised

- log-transformation of both sides:

$$y = e^{a+bx_i} + e^\varepsilon \rightarrow \log(y) = a + bx + \varepsilon$$

$$z = \log(y) \rightarrow z = a + bx + \varepsilon$$

- $e^\varepsilon$  has lognormal distribution while  $\varepsilon$  has normal distribution
- $y$  has heterogenous variance  $z$  has homogenous variance
- $e^\varepsilon$  is multiplicative while  $\varepsilon$  is additive
- curved relationship becomes linear

Other nonlinear relationships can not be linearised

$$y = \alpha(1 - \beta e^{-\gamma x})$$

use **Nonlinear regression**

# Generalised Linear Model

- extension of the stochastic component
- we model transformed expected value of  $y$

$$f(\mu) = \alpha + \beta_1 x_1 + \beta_2 x_2 + \dots + \beta_k x_k$$

$$y \sim \text{distribution}$$

$f(\mu)$  .. link function

For example,

$$\mu = \alpha + \beta_1 x_1 + \beta_2 x_2 + \dots + \beta_k x_k$$

$$y \sim N(\mu, \sigma^2)$$

$$\varepsilon = y - \mu \sim N(0, \sigma^2)$$

**GLM** has 3 components:

- link function
- linear predictor
- distribution family
  - Gaussian (normal), Gamma, Inverse Gaussian, Poisson, Quasipoisson, Binomial, Quasibinomial, Quasi
- measure of fit is deviance not sum of squares
  - null deviance = SST
  - residual deviance = SSE
  - ANODEV table = ANOVA table

Rozdělení	Jméno linku	Link funkce	Rozptyl
Gaussovo (normální)	identity	1	$\mu$
Gama	inverse	$\frac{1}{\mu}$	$\mu^2$
Inverzní Gaussovo		$\frac{1}{\mu^2}$	$\mu^3$
Poissonovo	log	$\log(\mu)$	$\mu$
Quasipoissonovo	log	$\log(\mu)$	$\varphi\mu$
Binomické	logit	$\log\frac{\mu}{1-\mu}$	$\frac{\mu(1-\mu)}{n}$
Quasibinomické	logit	$\log\frac{\mu}{1-\mu}$	$\frac{\varphi\mu(1-\mu)}{n}$
Quasi	libovolné v rámci přípustných funkcí	libovolná v rámci přípustných funkcí	odpovídající

# Good model

- a useful simplification of the reality
    - should include important aspects for which it is being made and ignore aspects that we are not interested in
  - **Principle of parsimony:** Simpler model is better if it explains study phenomenon as good as complicated model.
- G. E. P. Box: „All models are wrong. But some of them are useful.“

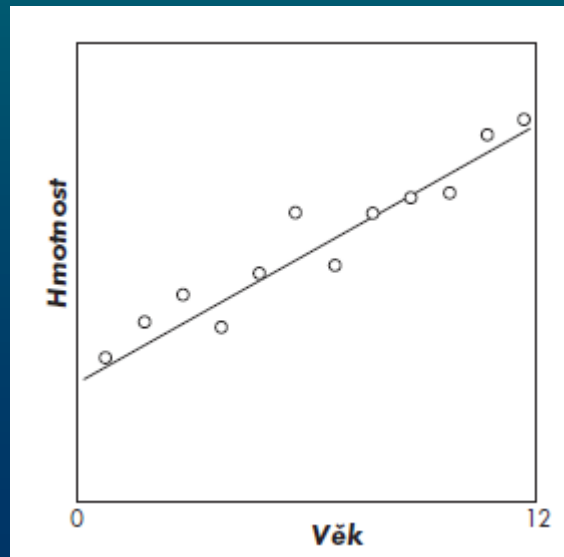

# Modelling procedure

## Bottom -up or forward selection

- building up a model by adding available variables

## Top-down or backward selection

- reducing maximal (saturated) model

1. Fit maximal model- all main effects and interactions
2. Remove insignificant interactions and main effects
3. Group together similar factor levels
4. Check diagnostic plots
5. Alter model if necessary
6. Achieve minimal adequate model
  - contains only terms in which all parameters are significantly different

# Model criticism

- to assess model quality and assumptions
- study of both systematic and stochastic components
- we can never prove that model is adequate

Residuals

$$\varepsilon_i \sim N(0, \sigma^2)$$

$$\text{cor}(\varepsilon_i, \varepsilon_{i'}) = 0, i \neq i'$$

should not

- make trends when plotted against explanatory or response variables
- be heteroscedastic
- have unusual distribution
- be interdependent

Checking assumptions

- informal using plots - `plot` produces 6 plots
- formal using tests



# Predictor's adequacy

- raw (LM) or deviance (GLM) residuals against fitted values
- curved pattern suggests lack of polynomial term

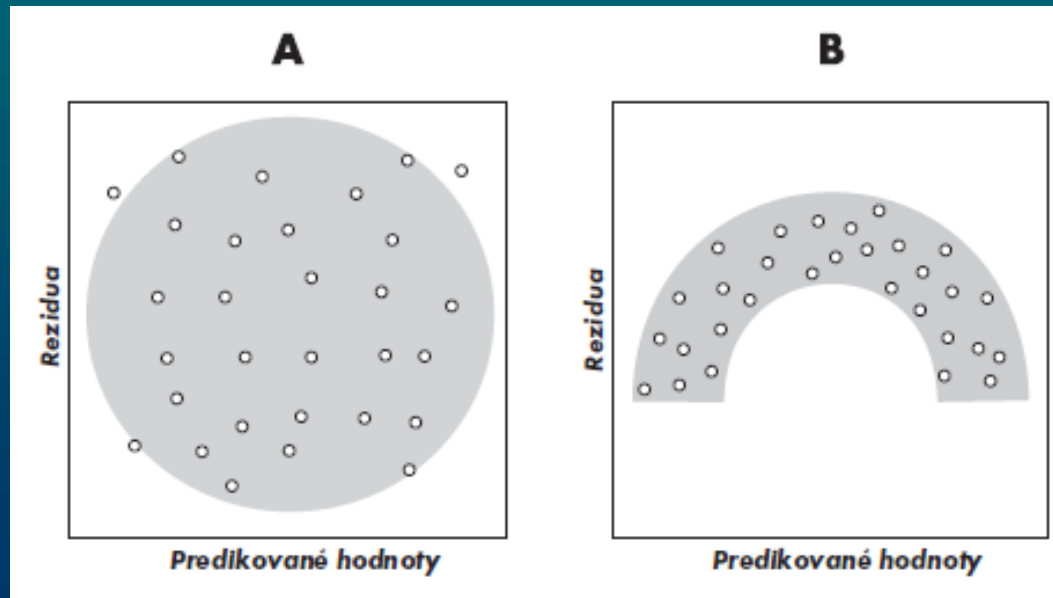

# Normality

- q-q plot of standardised (LM) standardised deviance (GLM) residuals
- data from other than normal distribution can not have normally distributed residuals
- when the pattern is “J” or “S” shaped change link function or transform the variable

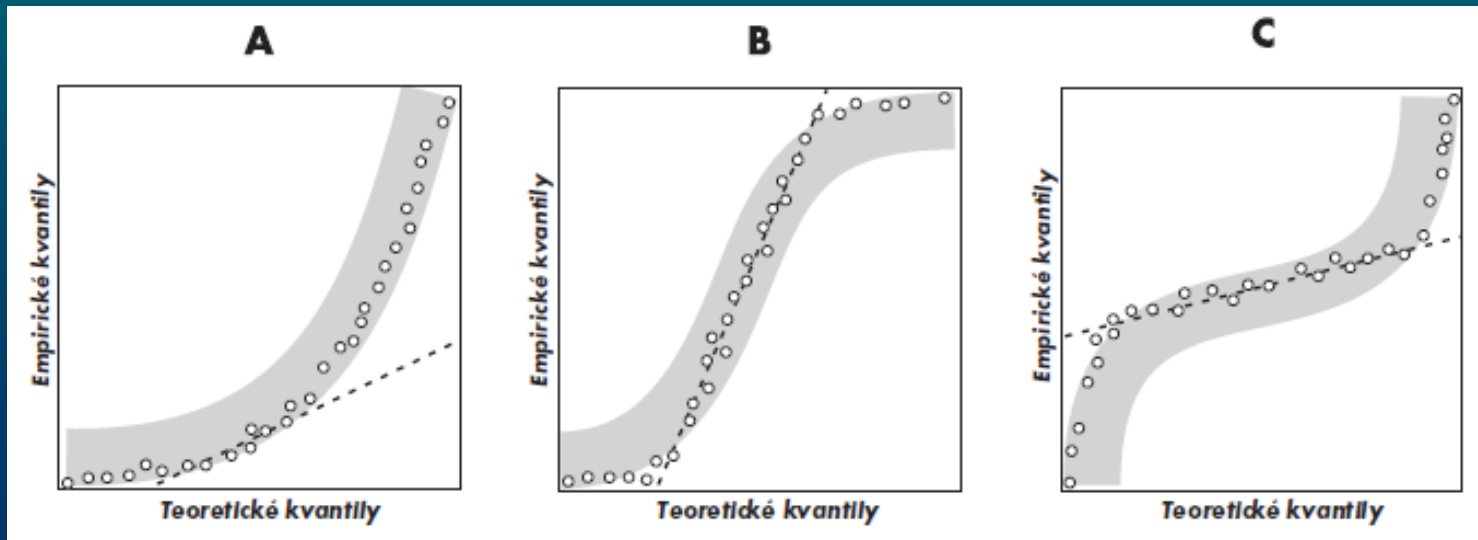

# Variance homogeneity

- plot of standardised (LM) standardised deviance (GLM) residuals against fitted/predicted values
- when variance increases with the mean use Poisson or gamma distribution or log transformation

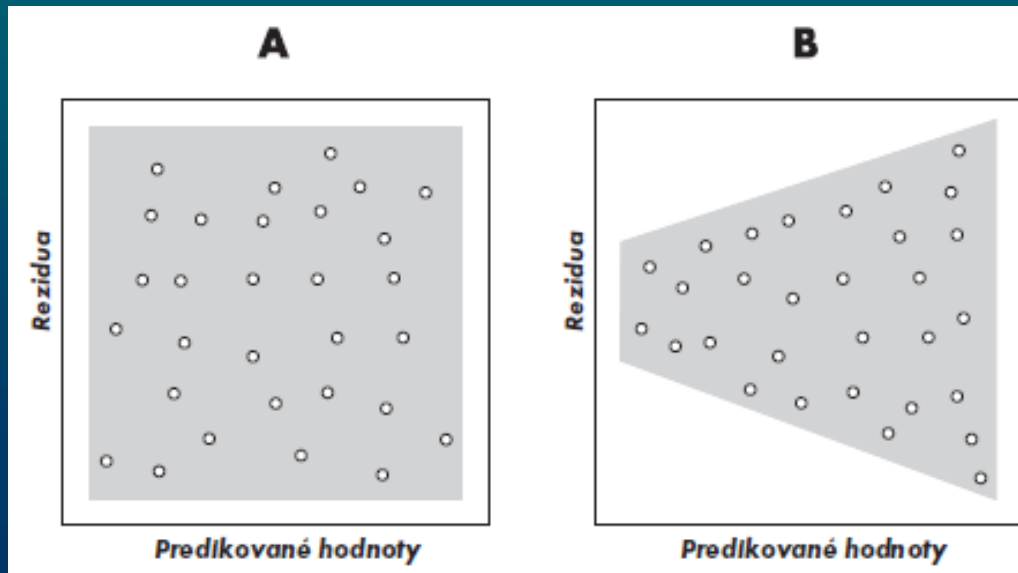

# Influence

- plot of Cook's distance for each observation shows the influence of individual observations on the model fit
- values of influential observations are close to 1 and higher
- residuals versus leverage
- omit influential observations or transform the explanatory variables (using log, power, reciprocal)

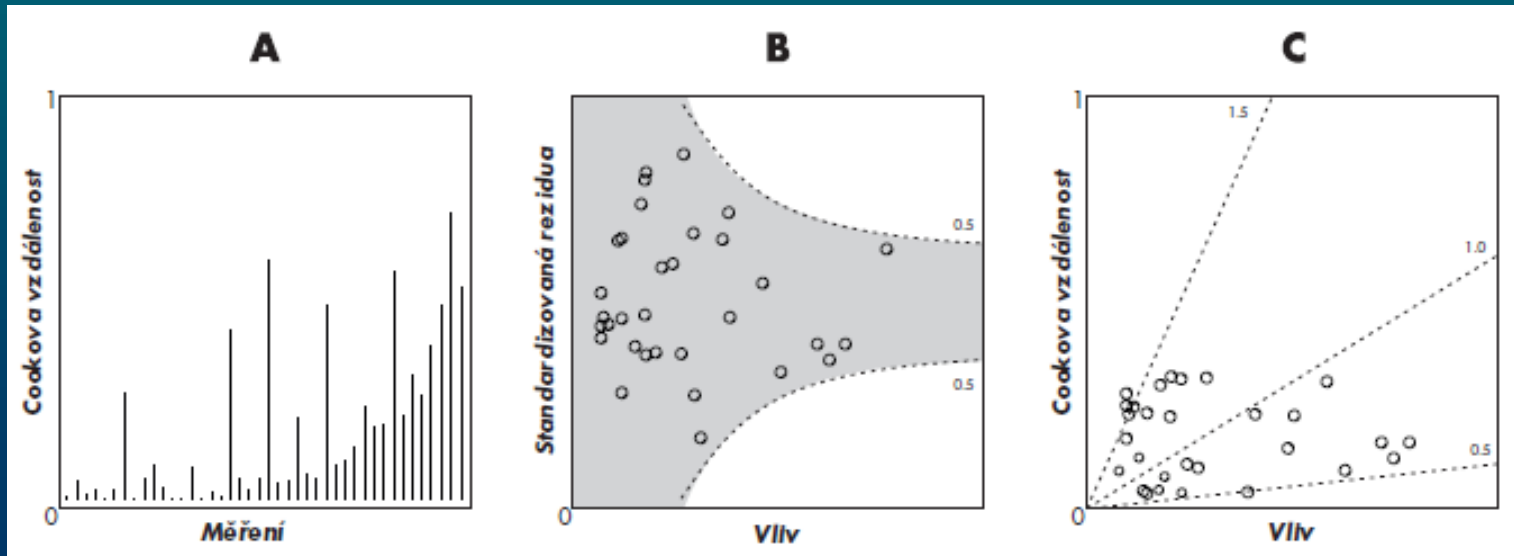

# Independence

- dependence on continual explanatory variable
  - using standardised (LM) or Pearson residues (GLM)
- serial dependence if explanatory variable is time or space

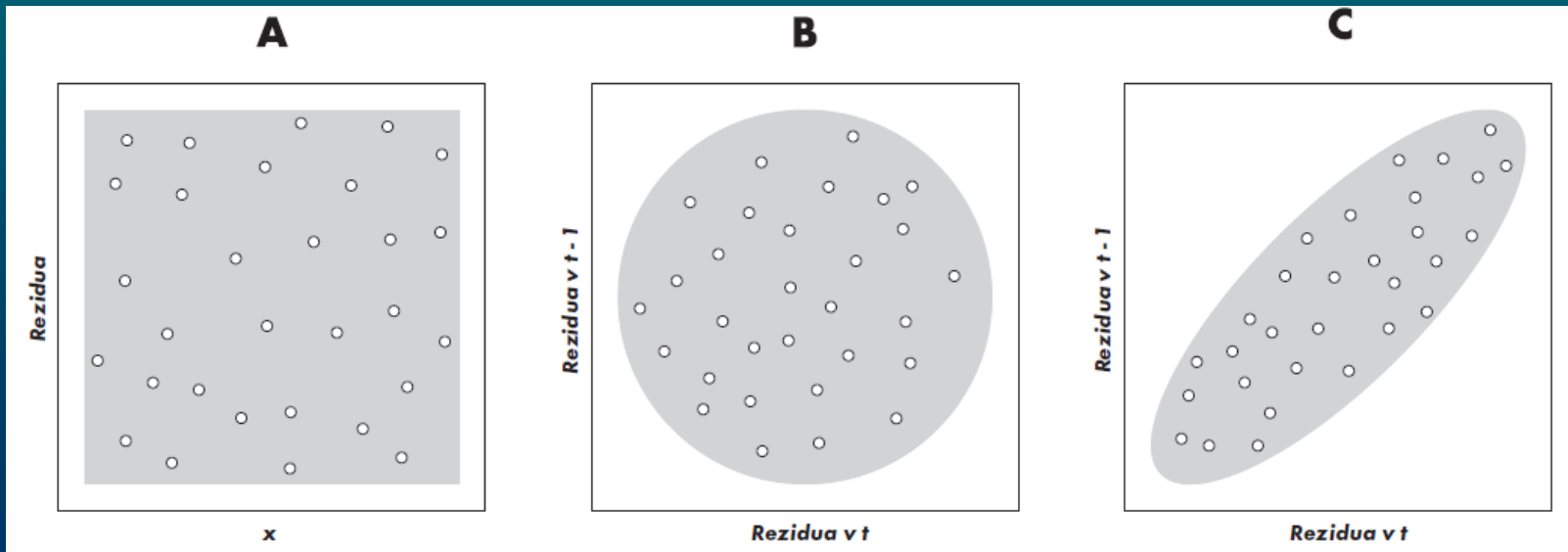

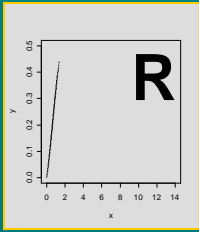

# The *first trial*

Stano Pekár

# 1-way ANOVA

## Background

Nutritional quality of the diet affects growth of organisms in various ways. To find optimal diet for cockroaches the following experiments was performed.

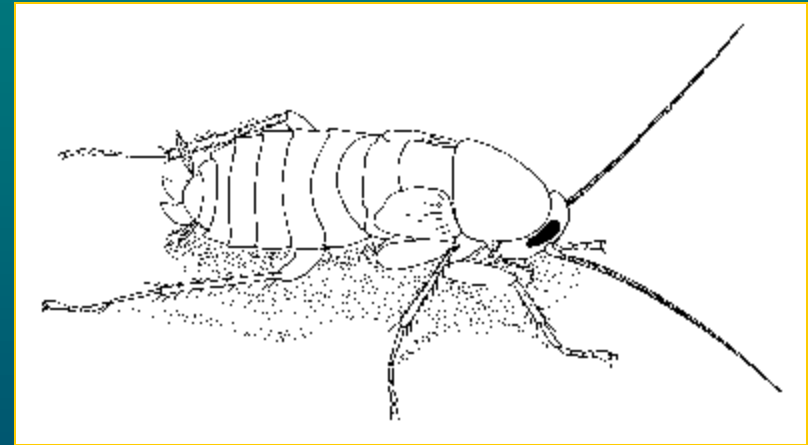

## Design

Effect of five diet types (control, lipid1, lipid2, protein1, protein2) was tested on body weight [g] of cockroaches. For each diet type there were 17 observations.

## Biological hypothesis

Is nutritional quality of the diet affecting size of organisms?

## Statistical hypotheses

H<sub>0</sub>: Weight is similar among diet groups.

H<sub>A</sub>: Weight is significantly different among diet groups.

## Prediction:

Protein-enriched diet should lead to highest weight.

## Variables

*DIET*: control, lipid1, lipid2, protein1, protein2

*weight*



EDA:

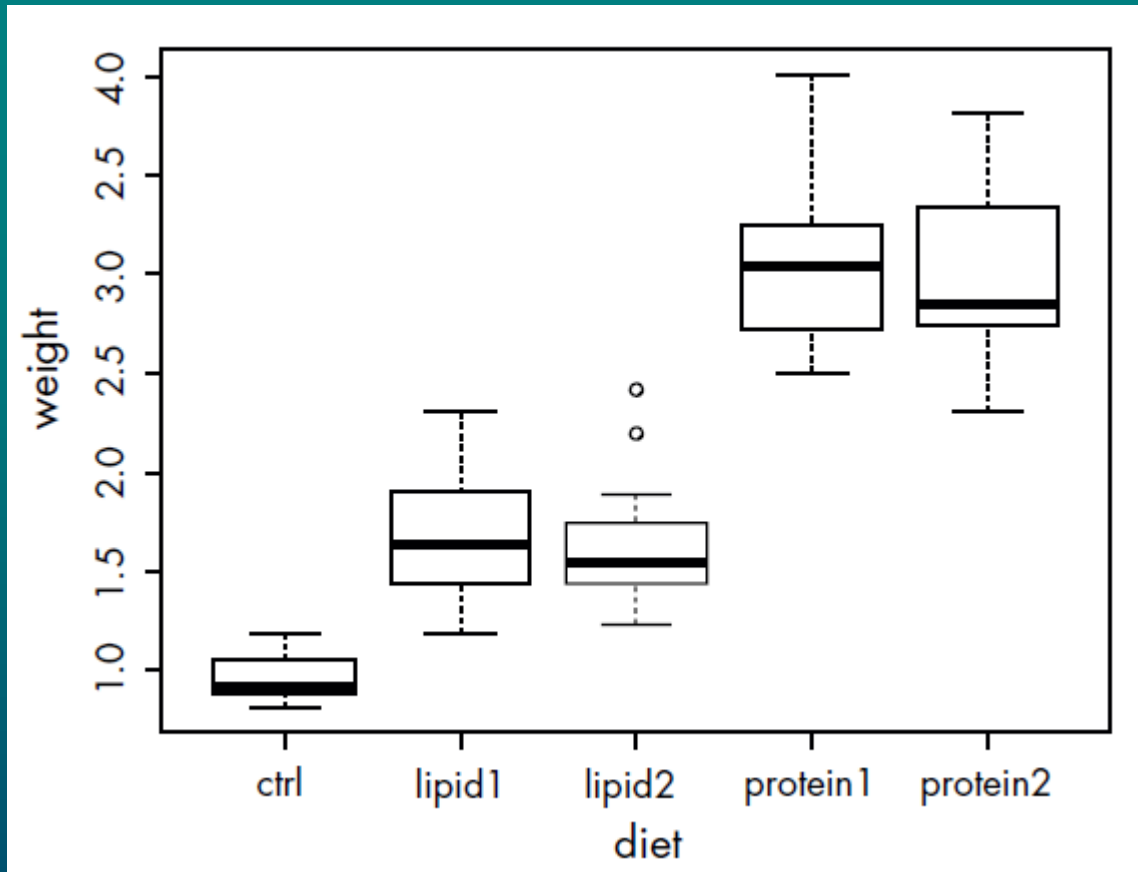

Model:

$$weight_{ij} = DIET_j + \varepsilon_{ij},$$

kde  $\varepsilon_{ij} \sim N(0, \sigma^2)$ , nezávisle pro jednotlivá měření.

## Analysis:

```
> m1 <- lm(weight~diet)
```

```
> anova(m1)
```

```
Analysis of Variance Table
```

```
Response: weight
```

	Df	Sum Sq	Mean Sq	F value	Pr(>F)
diet	4	58.484	14.621	116.55	< 2.2e-16 ***
Residuals	80	10.036	0.125		

```
---
```

```
Signif. codes:  0 '***' 0.001 '**' 0.01 '*' 0.05 '.' 0.1 ' ' 1
```

# Comparisons

- compare individual differences between factor levels
- comparisons are valid only if a factor is significant

## Options:

- *Apriori* contrasts (before analysis)
- *Posteriori* simplification (after analysis)
- Multiple comparisons (after analysis)
  
- *apriori* contrasts are preferred to avoid excess of significant results

# Contrasts

For a model

$$y_{ij} = A_j + \varepsilon_{ij}$$

a contrast will be

$$K = \sum_{j=1}^J w_j A_j$$

where  $A_j$  .. mean value of a level,  $w_j$  .. contrast coefficient

Creating contrasts

- levels lumped together get the same sign
- levels contrasted get opposite sign
- levels excluded get 0

.. so that sum of each contrast

$$\sum_{j=1}^J w_j = 0$$

Contrasts are arranged in a matrix

- only  $k-1$  ( $k$  .. number of levels) contrasts are orthogonal, i.e. each level (combination) is compared only once
- ... products of any two contrasts = 0

- specified by function **contrasts** prior to analysis

Pre-specified contrasts:

- **Treatment** (default in R) - compare specific level with the reference level
- **Helmert** - compare specific level with the average of previous levels
- **Sum** - compare specific level with the grand mean
- **Textbook** - compare each level with 0

```
> summary(m1)
```

```
Call:
```

```
lm(formula = weight ~ diet)
```

```
Residuals:
```

Min	1Q	Median	3Q	Max
-0.66471	-0.18294	-0.05294	0.16706	0.91706

```
Coefficients:
```

	Estimate	Std. Error	t value	Pr(> t )	
(Intercept)	0.9547	0.0859	11.114	< 2e-16	***
dietlipid1	0.7282	0.1215	5.994	5.59e-08	***
dietlipid2	0.6682	0.1215	5.501	4.41e-07	***
dietprotein1	2.1382	0.1215	17.601	< 2e-16	***
dietprotein2	2.0100	0.1215	16.545	< 2e-16	***

```
---
```

```
Signif. codes:  0 '***' 0.001 '**' 0.01 '*' 0.05 '.' 0.1 ' ' 1
```

```
Residual standard error: 0.3542 on 80 degrees of freedom
```

```
Multiple R-Squared: 0.8535,    Adjusted R-squared: 0.8462
```

```
F-statistic: 116.6 on 4 and 80 DF,  p-value: < 2.2e-16
```

```

> contrasts(diet) <- cbind(c(1,-1/4,-1/4,-1/4,-1/4),c(0,-1/2,-1/2,1/2,1/2),
+ c(0,0,0,1/2,-1/2),c(0,-1/2,1/2,0,0))
> contrasts(diet)
      [,1] [,2] [,3] [,4]
ctrl    1.00  0.0  0.0  0.0
lipid1  -0.25 -0.5  0.0 -0.5
lipid2  -0.25 -0.5  0.0  0.5
protein1 -0.25  0.5  0.5  0.0
protein2 -0.25  0.5 -0.5  0.0

```

```

> summary(lm(weight~diet))

```

Coefficients:

	Estimate	Std. Error	t value	Pr(> t )	
(Intercept)	2.06365	0.03842	53.718	<2e-16	***
diet1	-1.10894	0.07683	-14.433	<2e-16	***
diet2	1.37588	0.08590	16.017	<2e-16	***
diet3	0.12824	0.12148	1.056	0.294	
diet4	-0.06000	0.12148	-0.494	0.623	

```

---

```

```
> contrasts(diet) <- 'contr.helmert'  
> summary(lm(weight~diet))
```

Coefficients:

	Estimate	Std. Error	t value	Pr(> t )	
(Intercept)	2.06365	0.03842	53.718	< 2e-16	***
diet1	0.36412	0.06074	5.994	5.59e-08	***
diet2	0.10137	0.03507	2.891	0.00495	**
diet3	0.41819	0.02480	16.864	< 2e-16	***
diet4	0.22526	0.01921	11.727	< 2e-16	***

---

```
> contrasts(diet) <- 'contr.sum'  
> summary(lm(weight~diet))
```

Coefficients:

	Estimate	Std. Error	t value	Pr(> t )	
(Intercept)	2.06365	0.03842	53.718	< 2e-16	***
diet1	-1.10894	0.07683	-14.433	< 2e-16	***
diet2	-0.38071	0.07683	-4.955	3.96e-06	***
diet3	-0.44071	0.07683	-5.736	1.66e-07	***
diet4	1.02929	0.07683	13.396	< 2e-16	***

---



# Simplification

- levels of a factor are compared using Wald statistics from output
- similar factor levels are grouped together
- test each grouping by **anova**
- compare the final model with the first one

```
> levels(diet1)[4:5] <- "prot"
> levels(diet1)
[1] "ctrl" "lipid1" "lipid2" "prot"
> contrasts(diet1) <- 'contr.treatment'
> m2 <- lm(weight~diet1)
```

```
> anova(m1, m2)
Analysis of Variance Table

Model 1: weight ~ diet
Model 2: weight ~ diet1
  Res.Df    RSS Df Sum of Sq    F Pr(>F)
1     80 10.0357
2     81 10.1755 -1   -0.1398 1.1142 0.2943
```

```
> diet2 <- diet1
> levels(diet2)[2:3] <- "lipid"
> m3 <- lm(weight~diet2)
> anova(m2, m3)
Analysis of Variance Table

Model 1: weight ~ diet1
Model 2: weight ~ diet2
  Res.Df    RSS Df Sum of Sq    F Pr(>F)
1     81 10.1755
2     82 10.2061 -1   -0.0306 0.2436 0.623
```

```

> diet3 <- diet2
> levels(diet3)[2:3] <- "other"
> m4 <- lm(weight~diet3)
> anova(m3, m4)
Analysis of Variance Table

Model 1: weight ~ diet2
Model 2: weight ~ diet3
  Res.Df    RSS Df Sum of Sq    F    Pr(>F)
1      82  10.206
2      83  42.388 -1   -32.182 258.56 < 2.2e-16 ***
---

```

```

> anova(m3,m1)
Analysis of Variance Table

Model 1: weight ~ diet2
Model 2: weight ~ diet
  Res.Df    RSS Df Sum of Sq    F Pr(>F)
1      82  10.206
2      80  10.036  2    0.17038 0.6791  0.51

```

# Multiple comparisons

- *post hoc* tests
- Bonferroni correction – applied to non-orthogonal contrasts
- Dunn test, Scheffe test, Tukey HSD test
- comparison by means of confidence intervals

```
> library(multcomp)
> m4 <- glht(m1, linfct = mcp(diet = "Tukey"))
> summary(m4)
```

### Simultaneous Tests for General Linear Hypotheses

Multiple Comparisons of Means: Tukey Contrasts

Fit: lm(formula = weight ~ diet)

Linear Hypotheses:

	Estimate	Std. Error	t value	Pr(> t )	
lipid1 - ctrl == 0	0.7282	0.1215	5.994	<1e-05	***
lipid2 - ctrl == 0	0.6682	0.1215	5.501	<1e-05	***
protein1 - ctrl == 0	2.1382	0.1215	17.601	<1e-05	***
protein2 - ctrl == 0	2.0100	0.1215	16.545	<1e-05	***
lipid2 - lipid1 == 0	-0.0600	0.1215	-0.494	0.988	
protein1 - lipid1 == 0	1.4100	0.1215	11.606	<1e-05	***
protein2 - lipid1 == 0	1.2818	0.1215	10.551	<1e-05	***
protein1 - lipid2 == 0	1.4700	0.1215	12.100	<1e-05	***
protein2 - lipid2 == 0	1.3418	0.1215	11.045	<1e-05	***
protein2 - protein1 == 0	-0.1282	0.1215	-1.056	0.828	

---

Signif. codes: 0 '\*\*\*' 0.001 '\*\*' 0.01 '\*' 0.05 '.' 0.1 ' ' 1  
(Adjusted p values reported -- single-step method)

```
> plot(m4)
```

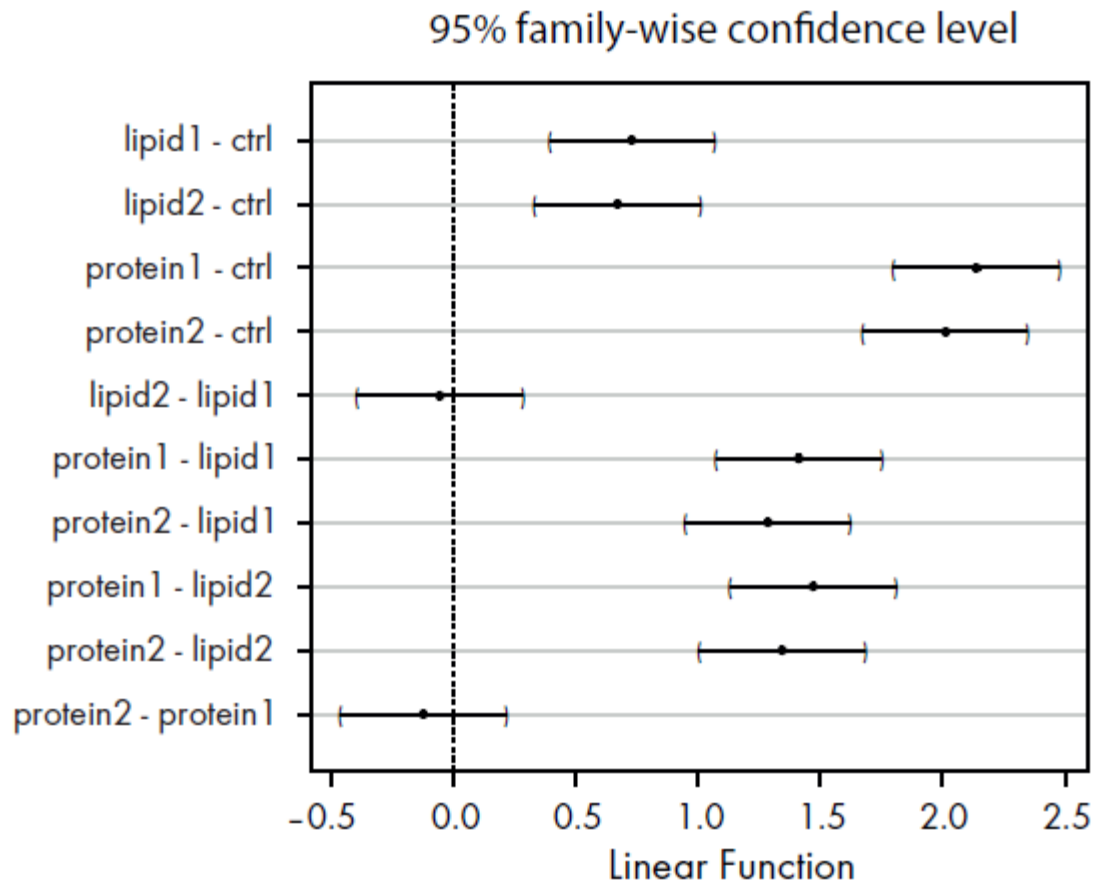

## Diagnosis:

We should check as many aspects as possible

- use diagnostic plots
- use formal tests:
  - Bartlett test to compare variances
  - Shapiro-Wilk test of normality

```
> bartlett.test(weight ~ diet2)

      Bartlett test of homogeneity of variances

data:  weight by diet2
Bartlett's K-squared = 24.2178, df = 2, p-value = 5.51e-06
```

```
> shapiro.test(resid(m3))

      Shapiro-Wilk normality test

data:  resid(m9)
W = 0.9685, p-value = 0.0356
```

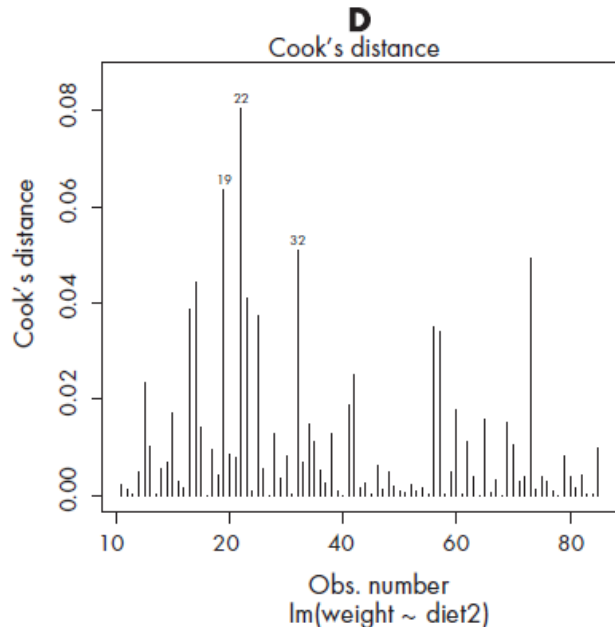
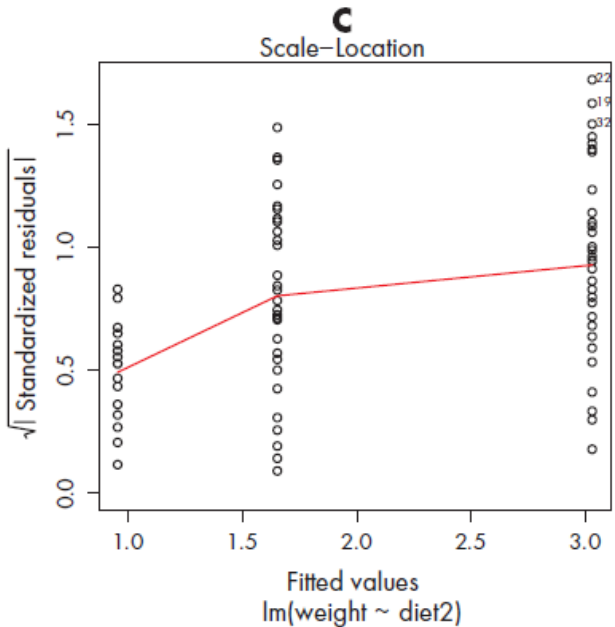
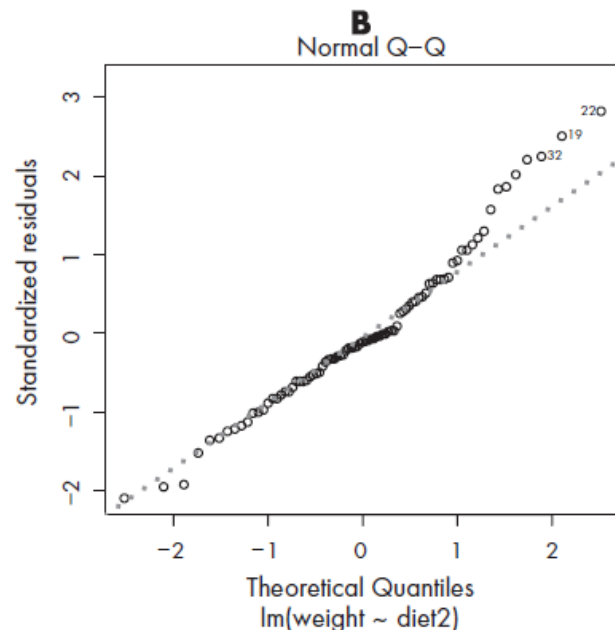
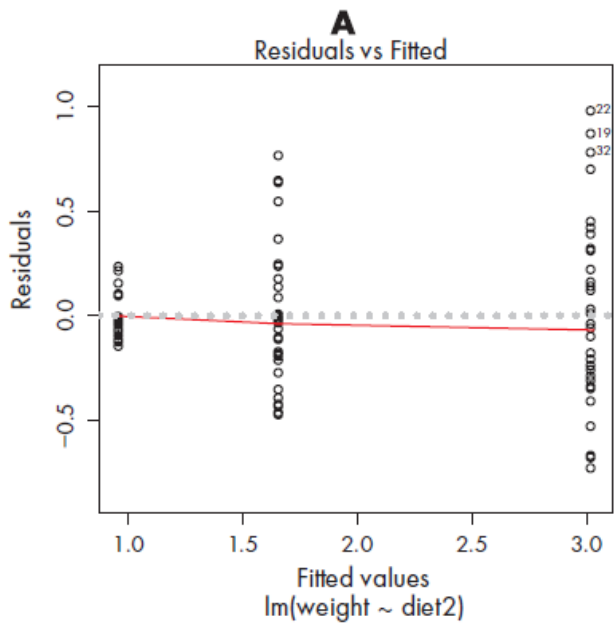



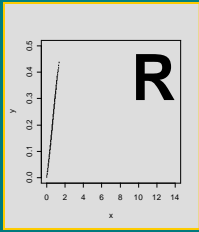

# *Systematic* *Systematic* **component**

# Analytical methods

$$y_i = a + bx_i + \varepsilon_i$$

- the same explanatory variable can be taken once as continuous other time as categorical: e.g. two levels of concentration
- continuous variable allows interpolation and extrapolation

Key to methods:

<u>Explanatory variable(s)</u>	<u>Method</u>
Continuous	Regression
Categorical	ANOVA
Continuous and categorical	ANCOVA

Linear predictor can include various terms:

- intercept ..  $\alpha$  estimated as  $a$
- linear term ..  $\beta x$  with  $b$  as coefficient of linear trend
- quadratic term ..  $\gamma x^2$  with  $c$  as coefficient of quadratic trend
- cubic term ..  $\tau x^3$  with  $t$  as coefficient of cubic trend
- main effect ..  $A$
- interaction between factors ..  $A:B$
- interaction between continuous variables  $x_1:x_2$
- linear interaction ..  $A:x$
- quadratic interaction ..  $A:x^2$

# Regression

- **simple regression** ... 1 explanatory variable
- **multiple regression** .. 2 and more explanatory variables

**General** linear predictor of multiple regression

$$\alpha + \beta_1 x_1 + \beta_2 x_2 + \dots + \beta_k x_k$$

$\alpha$  .. intercept

$\beta_k$  .. linear coefficients of  $x_k$

$x$  .. may represent polynomial functions ( $x^3$ ), interactions ( $x_1 \cdot x_2$ )

- rule of thumb: less than  $n/3$  parameters in model at any time
- number of combinations of explanatory variables will often exceed the number of data so we can not include all terms

## Simplification

- linear predictor with 2 explanatory variables ( $x_1, x_2$ ) should include all main effects, all interactions, and quadratic terms

$$\alpha + \beta_1 x_1 + \beta_2 x_2 + \gamma_1 x_1^2 + \gamma_2 x_2^2 + \delta x_1 x_2$$

with estimates  $a, b_1, b_2, c_1, c_2, d$

**Nested models are:**

- 5 parameters ( $a, b_1, b_2, c_1, c_2$ ), at least  $c_1$  and  $c_2$  are significantly different

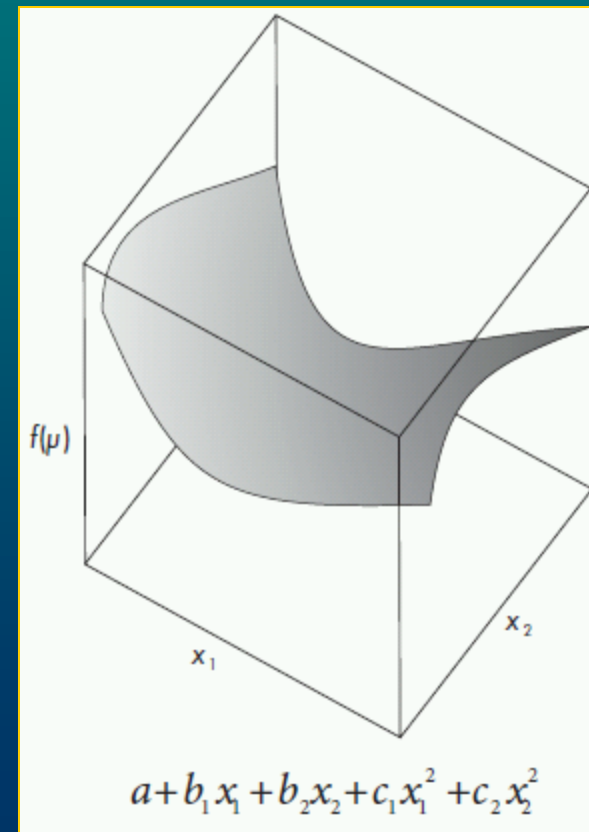

- 4 parameters ( $a, b_1, b_2, c_1$ ), at least  $c_1$  is significantly different
- 3 parameters ( $a, b_1, b_2$ ), at least  $b_1$  and  $b_2$  are significantly different

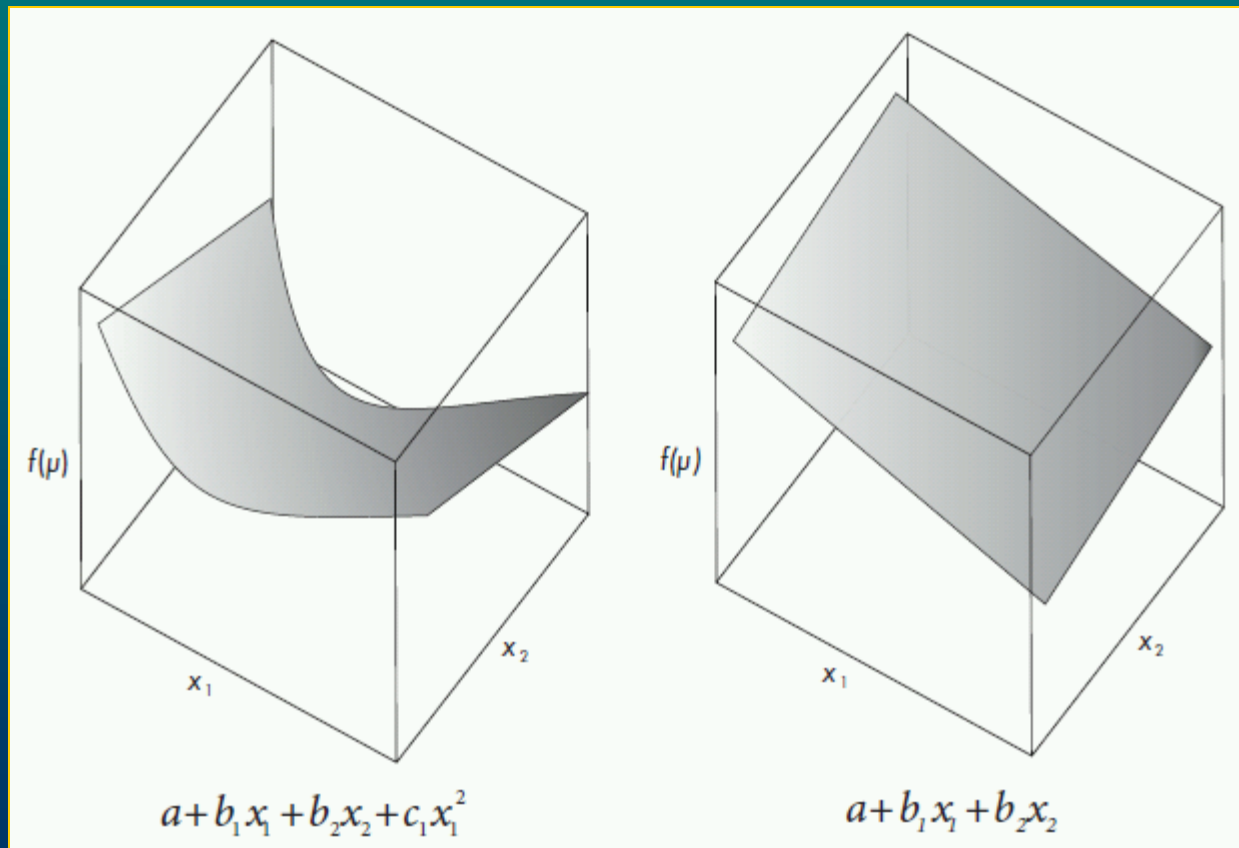

If one explanatory variable ( $x_2$ ) turns out to be insignificant:

- 3 parameters ( $a, b, c$ ), at least  $c$  is significantly different
- 2 parameters ( $a, b$ ), at least  $b$  is significantly different
- 1 parameter ( $a$ ) that is significantly different

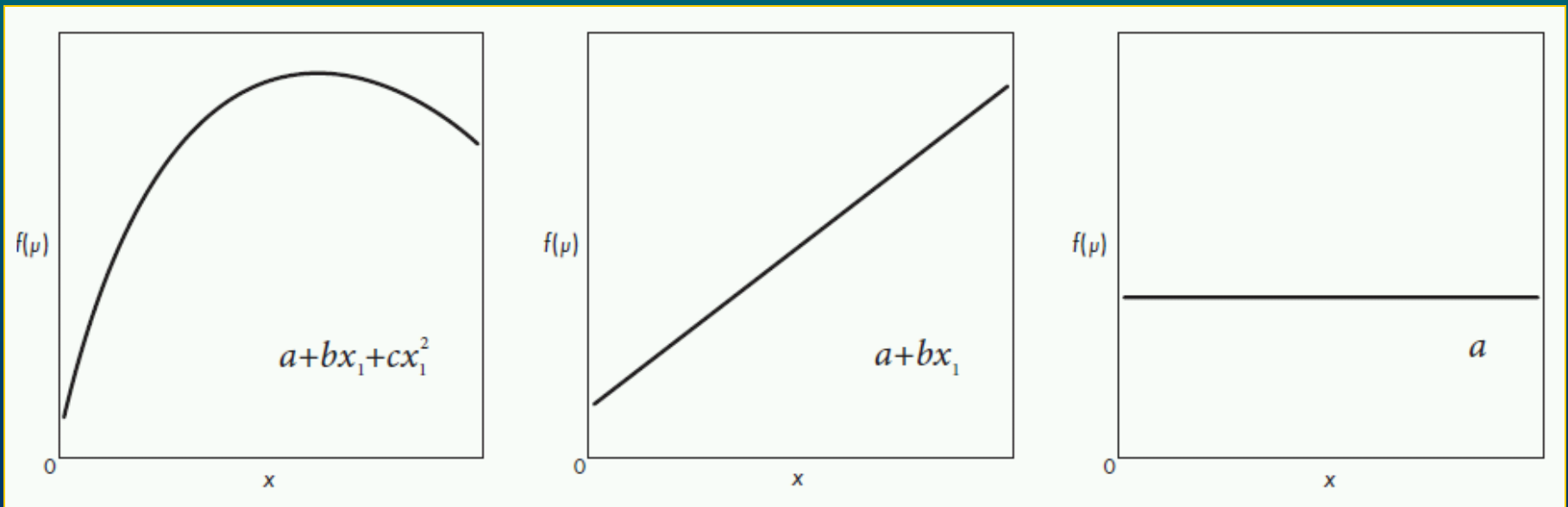

# ANOVA

- 1-way ANOVA .. 1 factor
- 2-way ANOVA .. 2 factors
- k-way ANOVA .. k factors
  
- k-way ANOVA might be with or without interactions

Given 2 categorical variables  $A$  and  $B$  each with 2 levels ( $A_1, A_2$ , and  $B_1, B_2$ ) model with treatment contrasts is

$$\alpha + A_i + B_j + A:B_{ij}$$

$\alpha$  .. mean of  $A_1B_1$ ,  $A_i$  and  $B_j$  .. main effects,  $A:B_{ij}$  .. interaction



- 4 parameters ( $A_1B_1$ ,  $A_2B_1 - A_1B_1$ ,  $A_1B_2 - A_1B_1$  a  $A_2B_2 - A_1B_2$ ): interaction is significant
- 3 parameters ( $A_1B_1$ ,  $A_2B_1 - A_1B_1$ ,  $B_2 - B_1$ ): only  $A$  and  $B$  are significant
- 2 parameters ( $B_1$ ,  $B_2 - B_1$ ): only  $B$  is significant
- 1 parameter (grand mean): null model

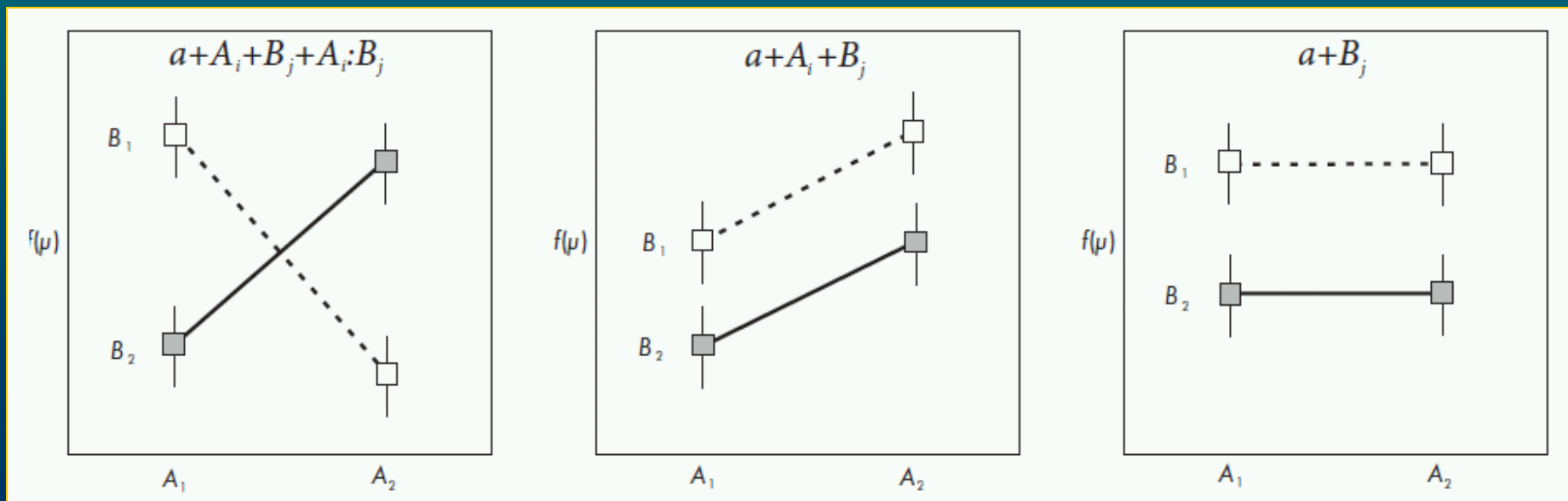

# ANCOVA

- combination of regression and ANOVA
- continuous variable = covariate

Given 1 factor ( $A_j$ ) and 1 covariate ( $x$ ) linear predictor is:

$$\alpha + A_j + \beta x + \delta_j x$$

$\alpha$  .. intercept,  $A_j$  .. effect of factor,  $\beta$  .. slope,  $\delta$  .. effect of interaction

Given 1 categorical variable  $A$  with 2 levels ( $A_1, A_2$ ) and 1 continual  $x$ , the linear predictor will be

$$\alpha + A_j + \beta x + \delta_j x + \gamma x^2 + \omega_j x^2$$

- 6 parameters - 2 intercepts ( $a_1, a_2 - a_1$ ), 2 slopes ( $b_1, b_2 - b_1$ ), 3 quadratic ( $c_1, c_2 - c_1$ ) - interaction  $A:x^2$  is significant
- 4 parameters - 2 intercepts ( $a_1, a_2 - a_1$ ), 2 slopes ( $b_1, b_2 - b_1$ ) - interaction  $A:x$  is significant, but quadratic terms are not significant

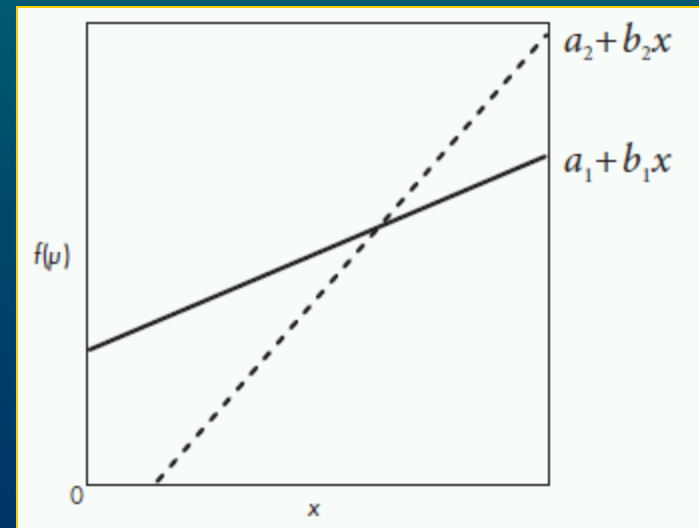
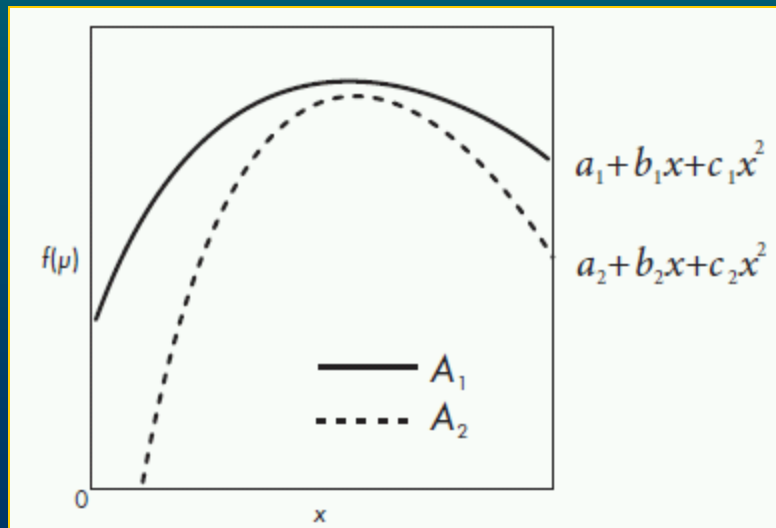

- 4 parameters - 2 intercepts ( $a_1, a_2 - a_1$ ), 1 slope ( $b$ ), 1 quadratic ( $c$ ) - interactions  $A:x^2$  and  $A:x$  are not significant, but  $A$  and quadratic terms are significant
- 3 parameters - 2 intercepts ( $a_1, a_2 - a_1$ ), 1 slope ( $b$ ) - only main effects ( $A$  and  $x$ ) are significant
- Further simplification  $\rightarrow$  1-way ANOVA or simple regression

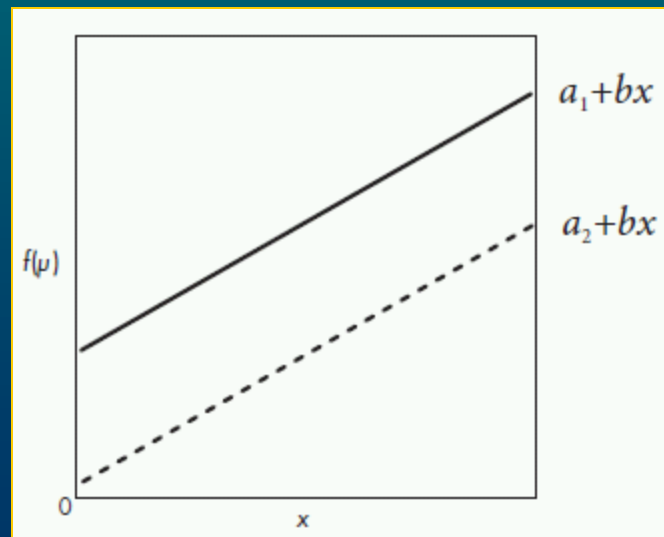
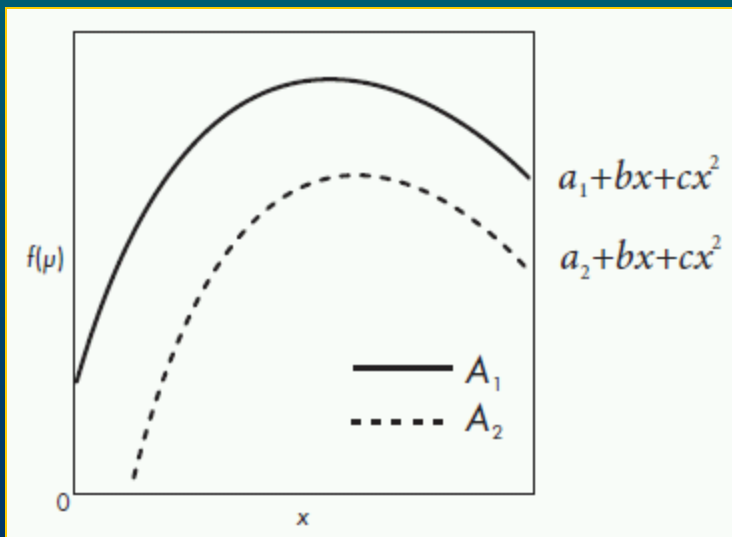

# Model formulae

*response variable ~ explanatory variable(s)*

- Operators:

- on left side any mathematical operator can be used

- on the right side only few:

- + .. add

- .. delete

- : .. interaction

- \* .. all terms

- 1 .. intercept

- $\mathbb{I}$  .. interpreter that translates operators into mathematical meaning

- / .. nested

- | .. conditioned

Model formula	Description	
$\mathbf{y} \sim 1$	Null model	$f(\mu_i) = \alpha$
$\mathbf{y} \sim \mathbf{x}$	Linear model with 1 explanatory variable	$f(\mu_i) = \alpha + \beta x_i$
$\log(\mathbf{y}) \sim \mathbf{x} - 1$	Linear model with 1 explanatory variable, without intercept and with log-transformed response	$\log(\mu_i) = \beta x_i$
$\mathbf{y} \sim \mathbf{x} + \mathbf{I}(\mathbf{x}^2)$ $\mathbf{y} \sim \text{poly}(\mathbf{x}, 2)$	Quadratic model with 1 explanatory variable	$f(\mu_i) = \alpha + \beta x_i + \gamma x_i^2$
$\mathbf{y} \sim \mathbf{x}_1 + \mathbf{x}_2$	Linear model with 2 explanatory variables	$f(\mu_i) = \alpha + \beta_1 x_{1i} + \beta_2 x_{2i}$

Model formula	Description	
$\mathbf{y} \sim \mathbf{A}*\mathbf{B}*\mathbf{C}$	3-way ANOVA with	$f(\mu_{ijk}) = \alpha + A_i + B_j + C_k + A:B_{ij} + A:C_{ik} + B:C_{jk} + A:B:C_{ijk}$
$\mathbf{y} \sim \mathbf{A} + \mathbf{B} + \mathbf{C} + \mathbf{A}:\mathbf{B} + \mathbf{A}:\mathbf{C} + \mathbf{B}:\mathbf{C} + \mathbf{A}:\mathbf{B}:\mathbf{C}$	three main effects, two 2-way interactions and one 3-way interaction	

$\mathbf{y} \sim (\mathbf{A} + \mathbf{B} + \mathbf{C})^2$	3-way ANOVA with only three 2-way interactions	$f(\mu_{ijk}) = \alpha + A_i + B_j + C_k + A:B_{ij} + A:C_{ik} + B:C_{jk}$
------------------------------------------------------------	------------------------------------------------	----------------------------------------------------------------------------

$\mathbf{y} \sim \mathbf{x}*\mathbf{A}$	1-way ANCOVA	$f(\mu_{ij}) = \alpha + A_j + \beta x_i + \delta_j x_i$
-----------------------------------------	--------------	---------------------------------------------------------

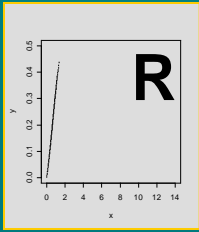

# *Stochastic* *component*

Stano Pekár



$$y_i = a + bx_i + \varepsilon_i$$

- choose distribution if using GLM
- there are many distributions but only some are available for GLM
- decision should be based upon theoretical models or previous experience

**Response variable can be**

- continuous measurements
- counts
- proportions

# Continuous measurements

- measurements that can be made with infinite precision

## Gauss (normal) distribution

- bell-shaped, symmetric around mean
- mean = median = modus
- parameters:  $\mu$ ,  $\sigma^2$
- $s^2$  is independent of mean

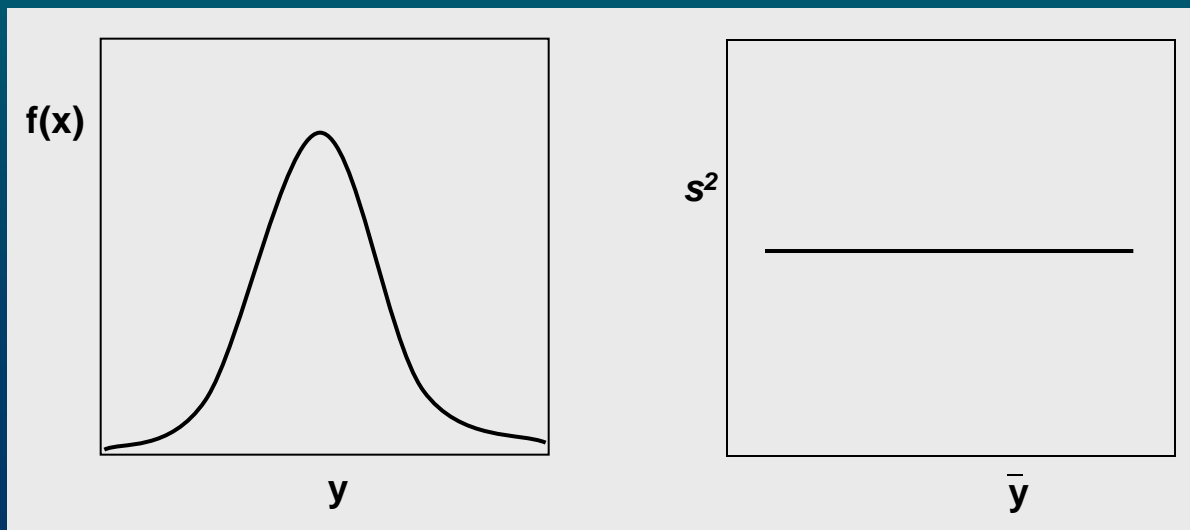

# Lognormal distribution

- positive real values
- asymmetric, skewed to the right
- variance increases with mean at quadratic trend
- after logarithmic transformation variances are similar

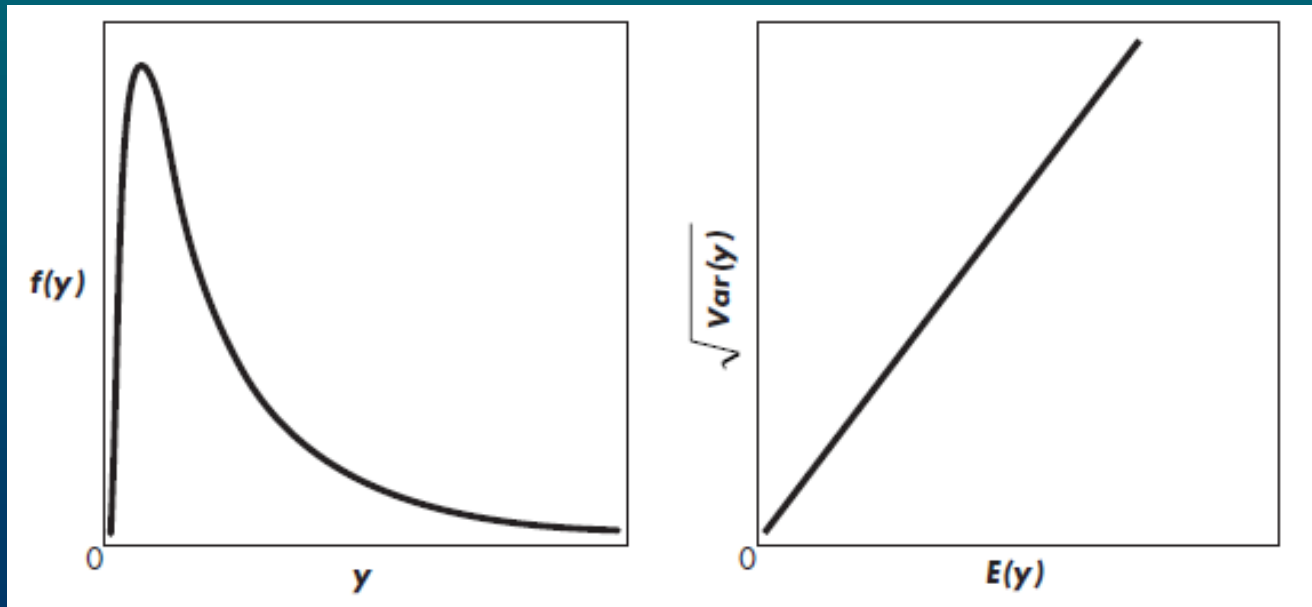

# Gamma distribution

- positive real values
- asymmetric, skewed to the right
- variance increases with mean at a quadratic trend

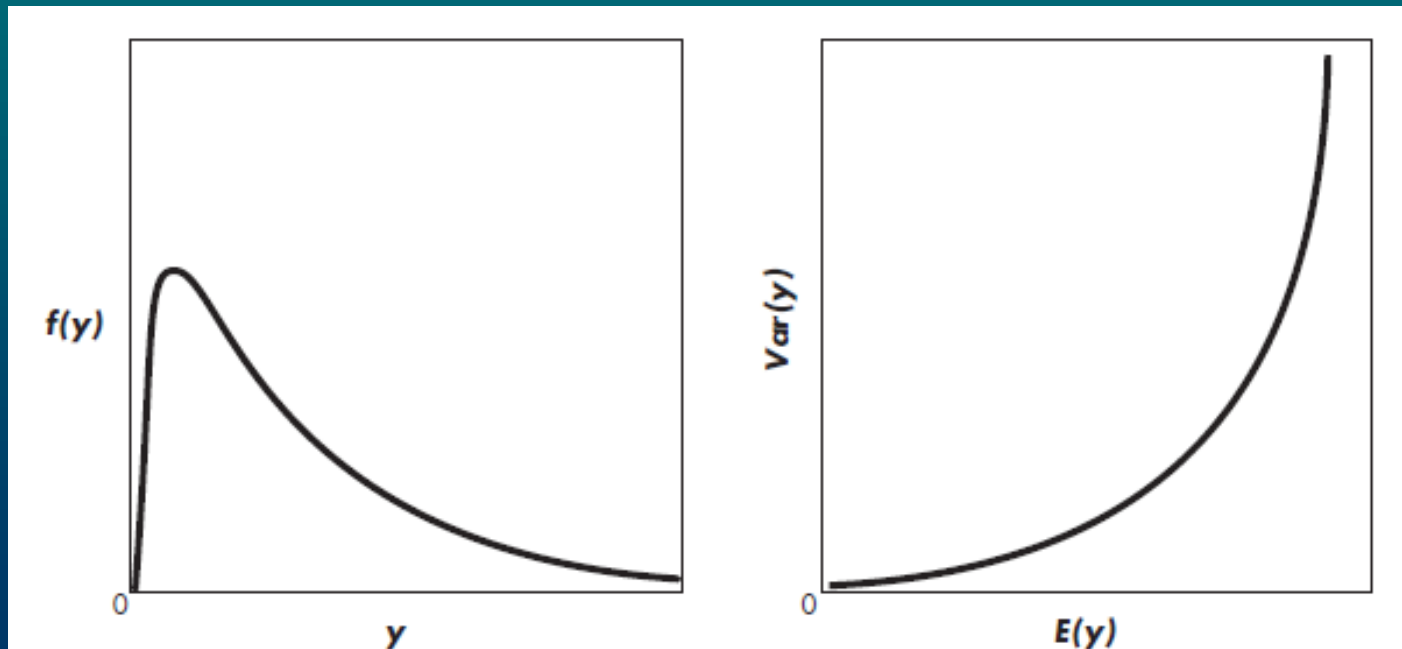

# Inverse Gaussian distributions

- positive real values
- used to model diffusion processes, dispersion in ecology
- variance increases steeply with mean

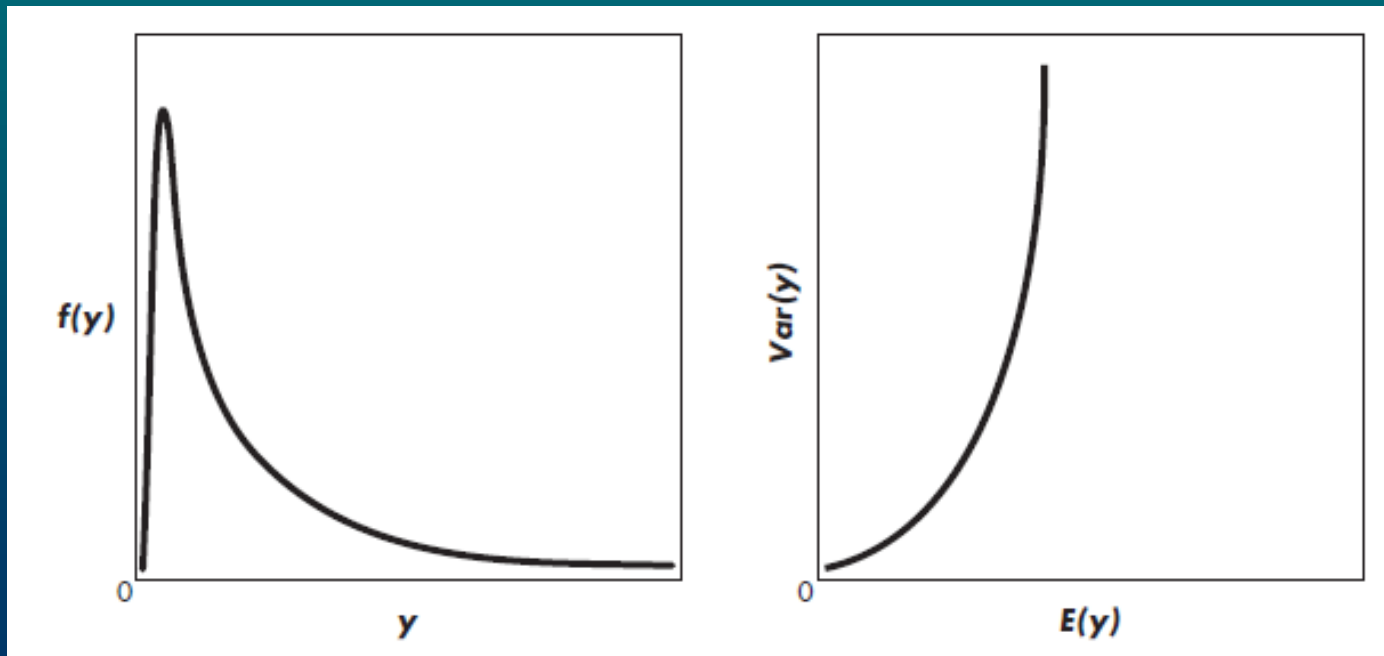

# Counts

# Poisson distribution

- discrete values, made of integers
- asymmetric, skewed to the right
- variance is equal to expected value
- variance increases with mean

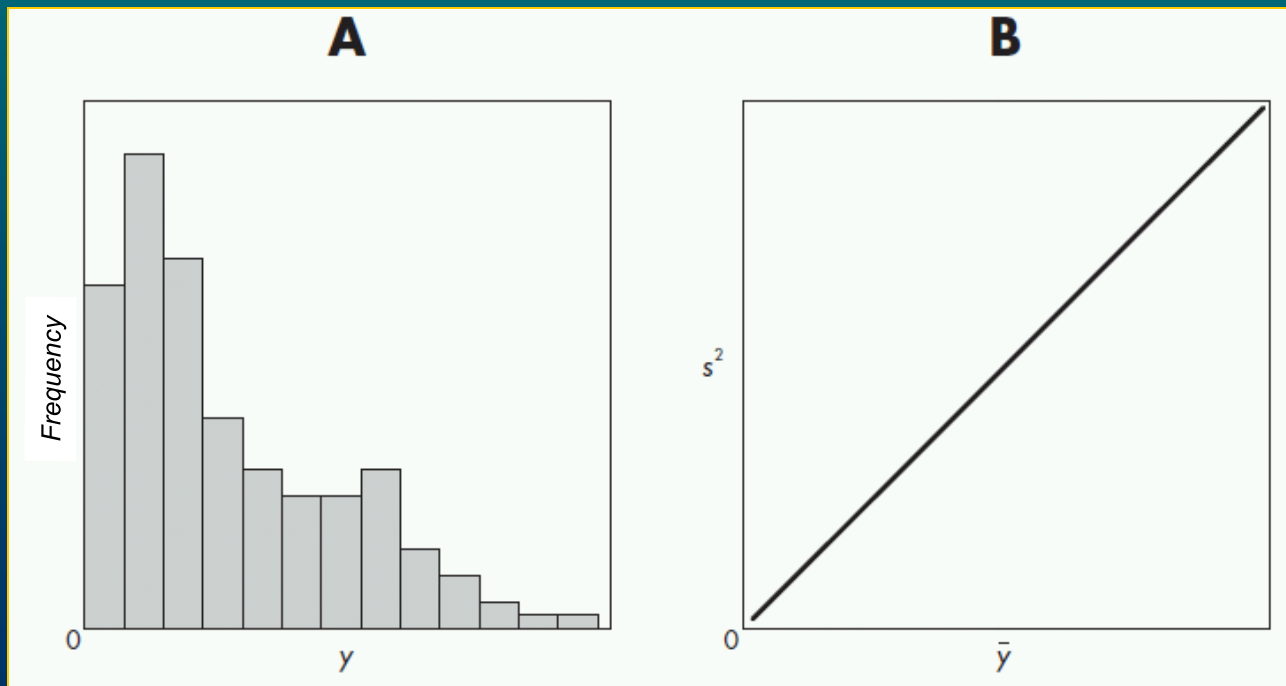

# Negative-binomial distribution

- discrete values, made of integers
- asymmetric, strongly skewed to the right
- variance is larger than expected value
- variance increases with mean at a parabolic trend

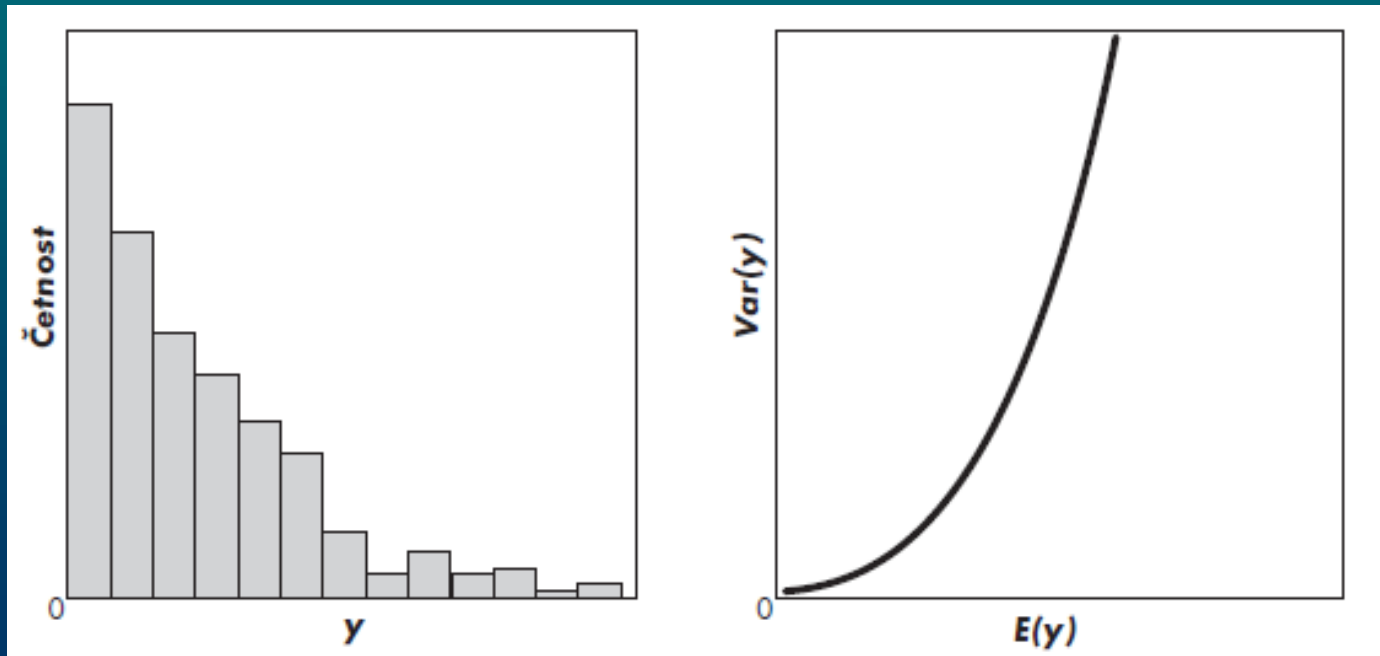

# Proportions

- arise when we counts events ( $y$ ) from a whole population ( $n$ )
- $p$  .. relative frequency =  $y/n$
- we study only qualitative character of an event not its quantitative aspect
- $p$  is an estimate of a theoretical value  $\pi$
- based on logit transformation

$$\log\left(\frac{p}{1-p}\right)$$



# Binomial & Binary distributions

- measurements ( $y$ ) are integers of  $n$  independent trials
- $\pi$  .. a single parameter showing probability of event occurrence
- $0 \leq \pi \leq 1$
- variance of  $\pi$  is maximal at 0.5

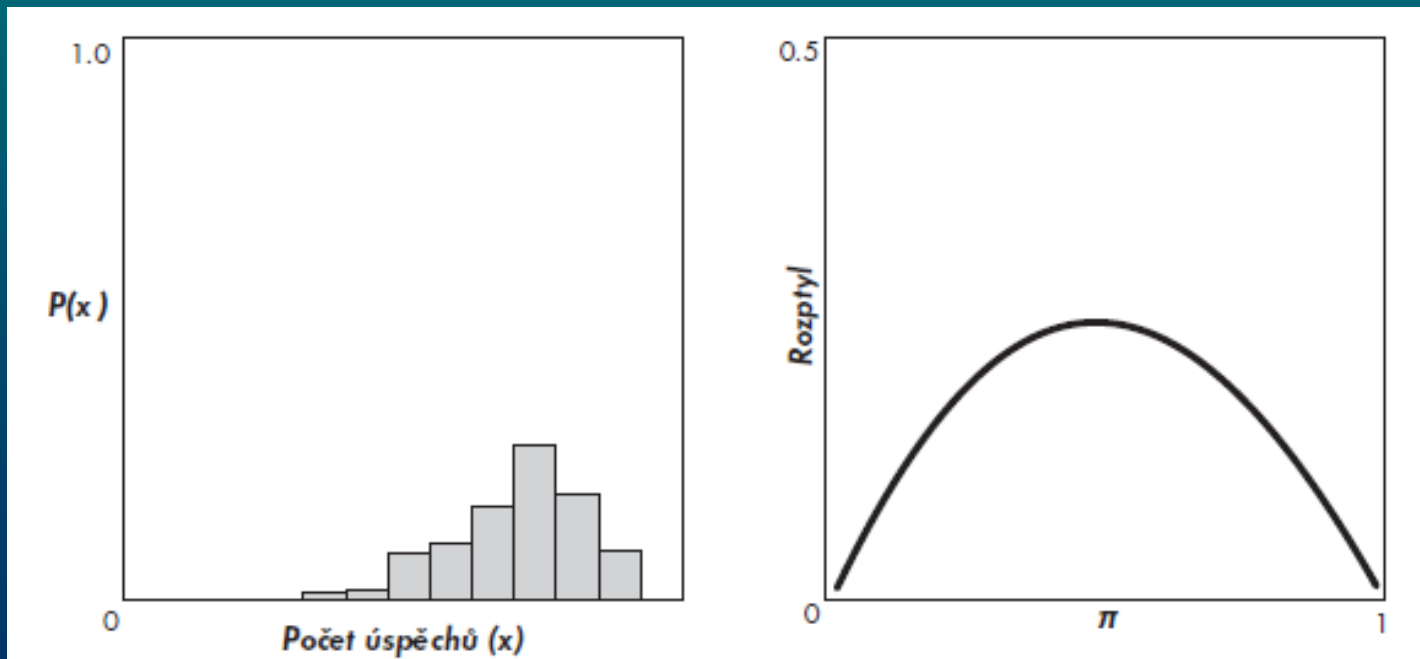

# Quasi “distribution”

- is not any distribution
- specifies expected value and the relationship between expected value and variance
- mixture of available settings

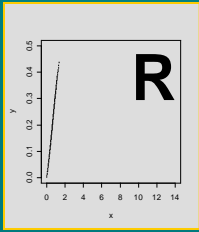

# *Analyses of* *Analyses of* **continuous \**

# Gaussian (normal) distribution

- response variable is continuous
  - measurements of length, width, distance, concentration, pH, etc.
  - data are real numbers
  - distribution is symmetric  $(-\infty, +\infty)$
  - parameters:  $\mu$ ,  $\sigma^2$  independent of each other

# Analytical methods

- **t-test** (`t.test`) to compare one or two means
- **Linear model** (`lm`) to study effect of categorical and continuous variables
  - inference is exact, reliable for each  $n$
- **GLM** (`glm`) to study effect of categorical and continuous variables
  - Gaussian family (default)
  - link: identity
  - inference is asymptotic, valid only for large  $n$

```
glm(formula, family=Gaussian)
```

# Simple Regression

## Background

The number of grains in ears affects the yield of cereals.

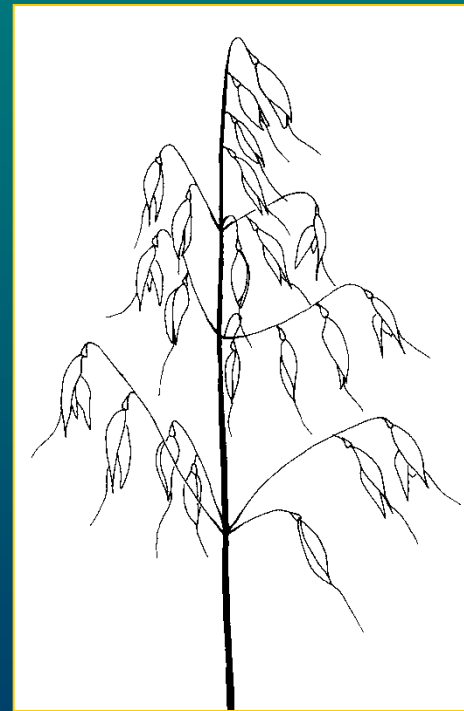

## Design

On 20 plots mean number of seeds per oat ear was estimated. Then at harvest the yield [t/ha] for each plot was estimated.

## Hypotheses

Is number of seeds related to the yield?

What is the predictive model of this relationship?

## Variables

*grain*

*yield*

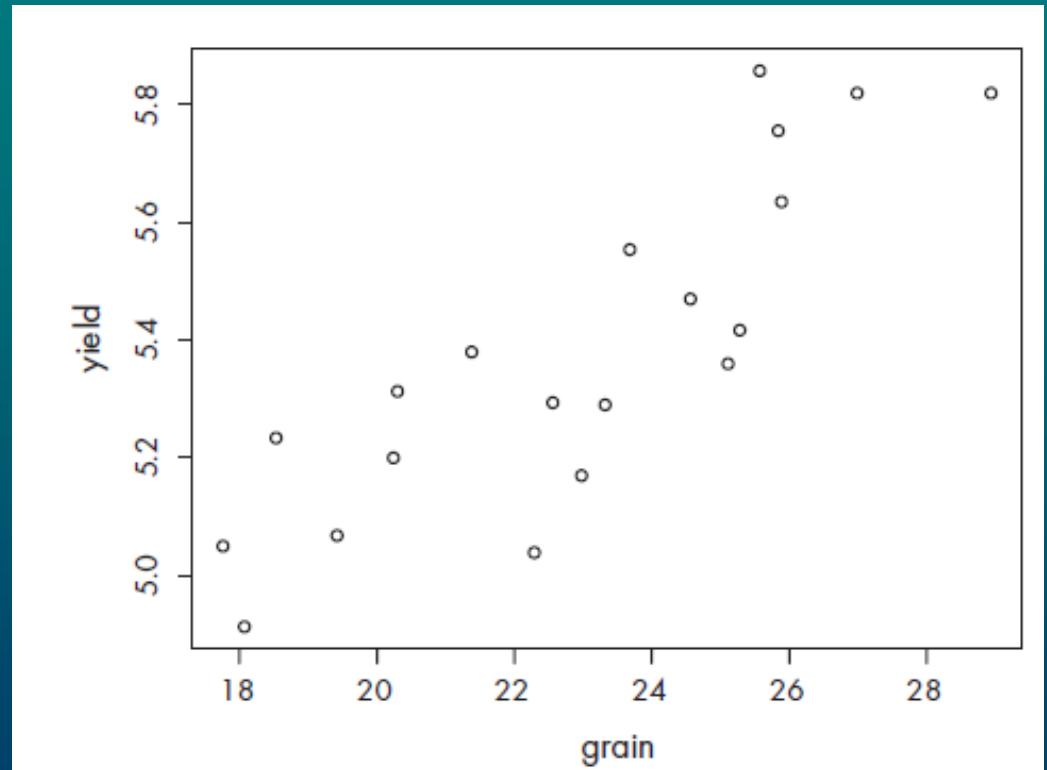

$$yield_i = \alpha + \beta grain_i + \varepsilon_i,$$

kde  $\varepsilon_i \sim N(0, \sigma^2)$ , nezávisle pro jednotlivé plochy.

# Quadratic term

- check for curvature by fitting a separate quadratic term for continuous explanatory variables

$$y = \alpha + \beta x + \gamma x^2 + \varepsilon$$

- quadratic model - a simple description of non-monotonous trend
- use either `poly(x, 2)` or `x + I(x^2)`

$$yield_i = \alpha + \beta grain_i + \gamma grain_i^2 + \varepsilon_i,$$

kde  $\varepsilon_i \sim N(0, \sigma^2)$ , nezávisle pro jednotlivé plochy.



```

> m1 <- lm(yield ~ poly(grain,2))
> summary(m1)

Call:
lm(formula = yield ~ poly(grain, 2))

Residuals:
    Min       1Q   Median       3Q      Max
-0.261562 -0.121112 -0.003686  0.142558  0.281990

Coefficients:
                Estimate Std. Error t value Pr(>|t|)
(Intercept)      5.38205    0.03417  157.520 < 2e-16 ***
poly(grain, 2)1  1.04875    0.15280   6.864 2.75e-06 ***
poly(grain, 2)2  0.15416    0.15280   1.009  0.327
---
Signif. codes:  0 '***' 0.001 '**' 0.01 '*' 0.05 '.' 0.1 ' ' 1

Residual standard error: 0.1528 on 17 degrees of freedom
Multiple R-Squared: 0.739,    Adjusted R-squared: 0.7083
F-statistic: 24.06 on 2 and 17 DF,  p-value: 1.101e-05

```

```

> summary(lm(yield ~ grain + I(grain^2)))

...

Coefficients:
                Estimate Std. Error t value Pr(>|t|)
(Intercept)  5.427559    1.795165   3.023  0.00766 **
grain       -0.083870    0.159018  -0.527  0.60472
I(grain^2)   0.003507    0.003476   1.009  0.32718

```

```

> m2 <- lm(yield ~ grain)
> summary(m2)
...
Coefficients:
              Estimate Std. Error t value Pr(>|t|)
(Intercept)  3.63509     0.25694   14.15 3.42e-11 ***
grain         0.07617     0.01110    6.86 2.03e-06 ***
---
Signif. codes:  0 '***' 0.001 '**' 0.01 '*' 0.05 '.' 0.1 ' ' 1

Residual standard error: 0.1529 on 18 degrees of freedom
Multiple R-Squared:  0.7233,    Adjusted R-squared:  0.708
F-statistic: 47.06 on 1 and 18 DF,  p-value: 2.033e-06

```

$$yield_i = \beta grain_i + \varepsilon_i,$$

kde  $\varepsilon_i \sim N(0, \sigma^2)$ , nezávisle pro jednotlivé plochy.

```

> m3 <- update(m2, ~.-1)
> summary(m3)
...
Coefficients:
              Estimate Std. Error t value Pr(>|t|)
grain 0.231855     0.005006   46.32  <2e-16 ***
---
Signif. codes:  0 '***' 0.001 '**' 0.01 '*' 0.05 '.' 0.1 ' ' 1

Residual standard error: 0.518 on 19 degrees of freedom
Multiple R-Squared:  0.9912,    Adjusted R-squared:  0.9908
F-statistic: 2146 on 1 and 19 DF,  p-value: < 2.2e-16

```

# Removing terms

- remove insignificant interactions
  - begin with the higher order terms because main effects are marginal to interactions
  - intercept is marginal to slope and both are marginal to the quadratic term
- remove insignificant main effects

## Criteria

- test (F or  $\chi^2$ ) and a given p-value (**anova**)
- **Akaike Information Criterion (AIC):**

$$AIC = -2\text{LogLik} + 2p$$

- the more there are parameters in the model the better fit but worse explanatory power of the model
- the lower AIC the better model

```
> AIC(m2, m3)
      df      AIC
m2    3 -14.47461
m3    2  33.42234
```

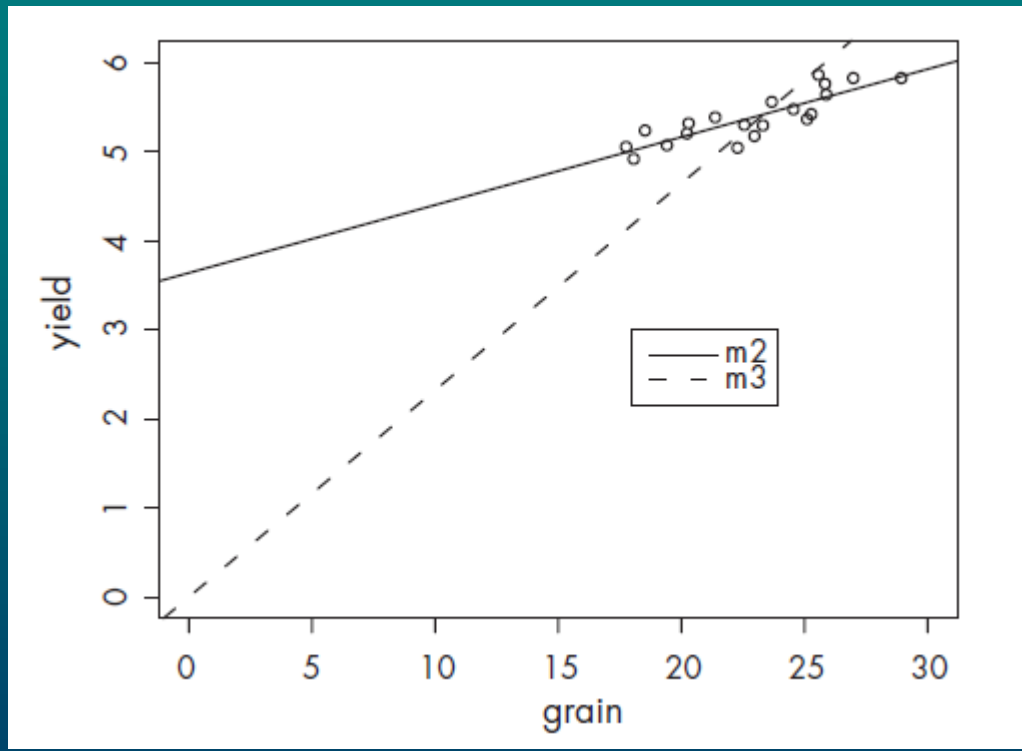

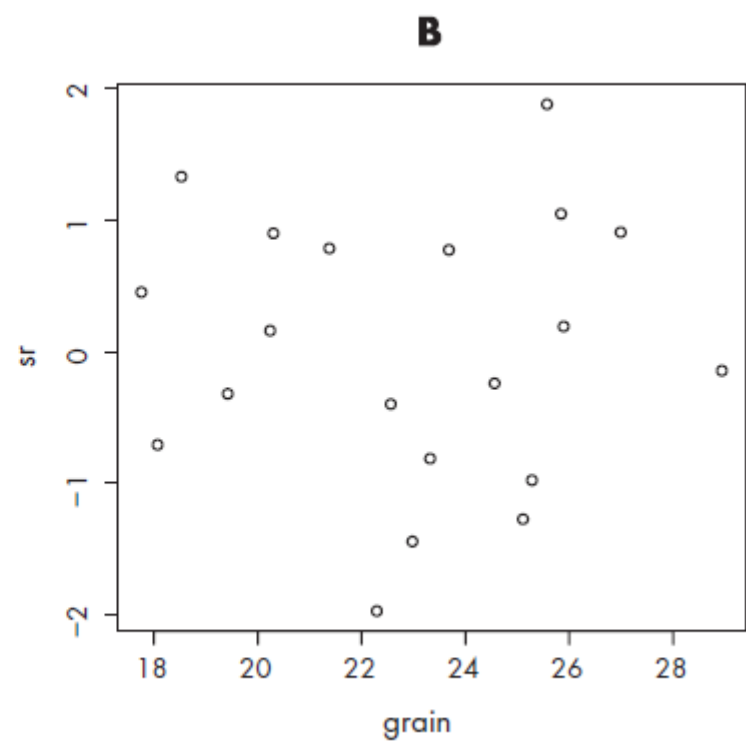
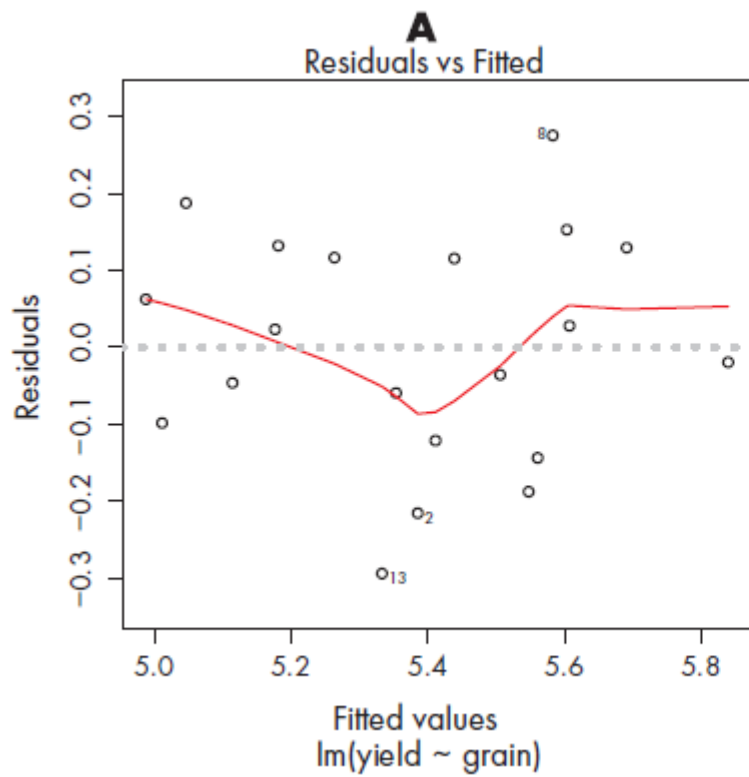

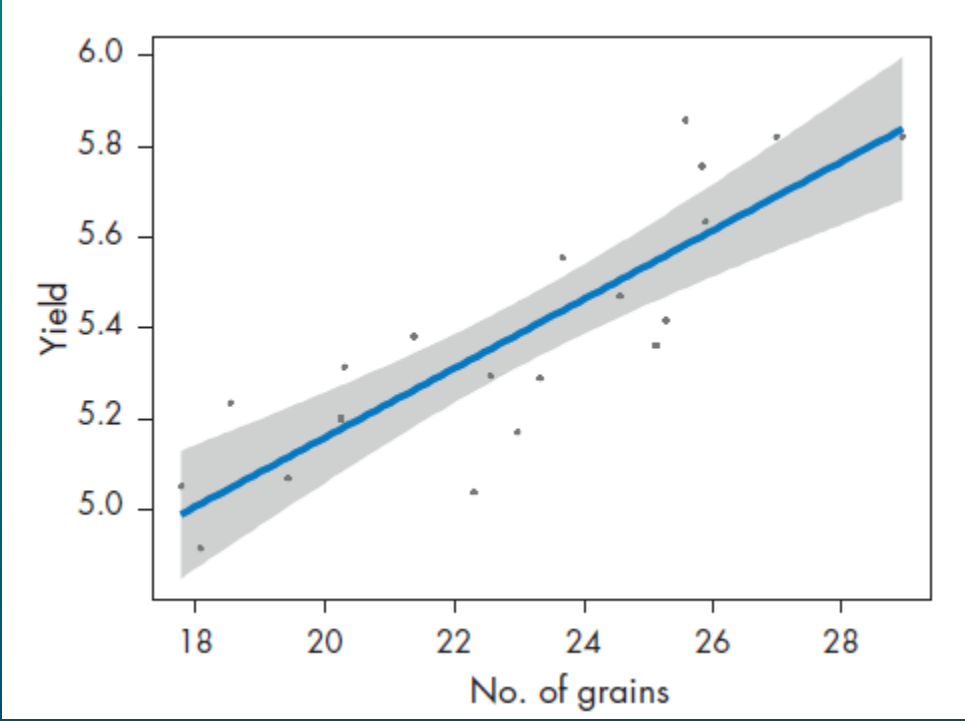

# Weighted Regression

## Weighting

- to increase/decrease effect of some measurements
- only positive values are allowed
- instead of least squares weighted least squares are used

$$\frac{\sigma^2}{n}$$

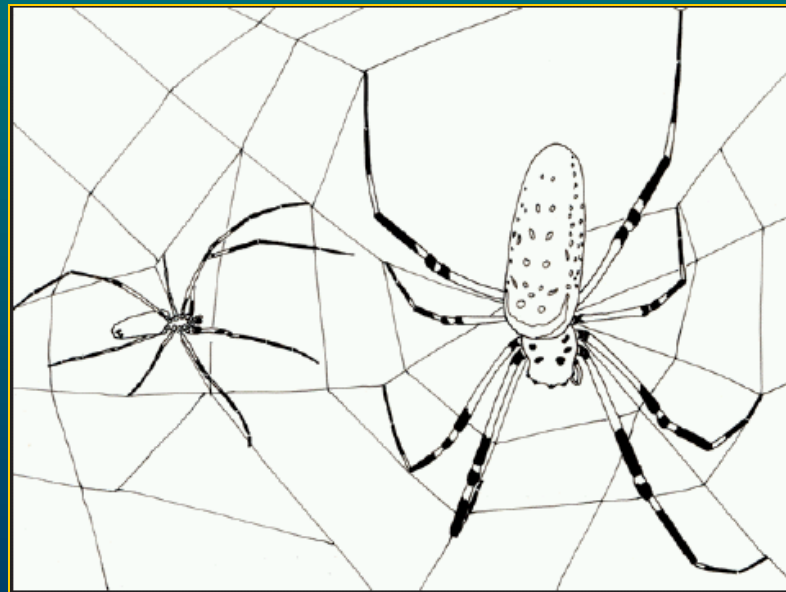

## Background

Sexual size dimorphism may increase with ambient temperature in spiders.

## Design

Males and females of *Zodarion* spiders were sampled on 13 sites with a different temperature [°C]. Of the average size of males and females a size ratio was calculated for each site. The number of individuals varied between sites (2 to 62 specimens).

## Hypotheses

Is there relationship between the ratio and the temperature?

What is the model?

## Variables

*temp*

*number*

*ratio*

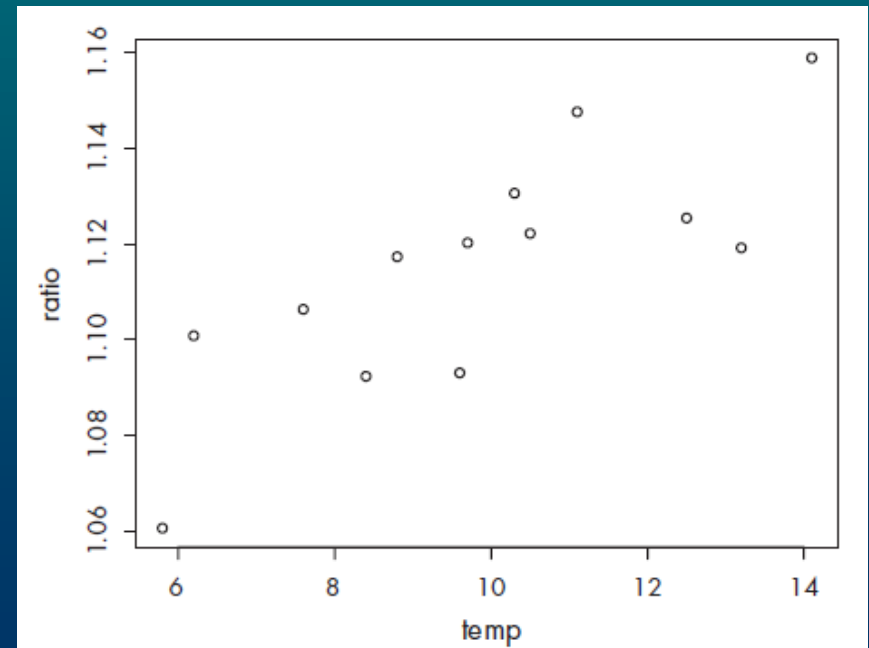



$ratio_i = \alpha + \beta temp_i + \gamma temp_i^2 + \varepsilon_i,$   
kde  $\varepsilon_i \sim N(0, \sigma^2)$ , nezávisle pro různé lokality.

```
> m1 <- lm(ratio ~ poly(temp,2))
> summary(m1)
...
Coefficients:
              Estimate Std. Error t value Pr(>|t|)
(Intercept)   1.114961   0.004597 242.538 < 2e-16 ***
poly(temp, 2)1  0.069484   0.016575   4.192  0.00185 **
poly(temp, 2)2 -0.010728   0.016575  -0.647  0.53206
---
Signif. codes:  0 '***' 0.001 '**' 0.01 '*' 0.05 '.' 0.1 ' ' 1

Residual standard error: 0.01657 on 10 degrees of freedom
Multiple R-Squared:  0.6428,    Adjusted R-squared:  0.5713
F-statistic: 8.996 on 2 and 10 DF,  p-value: 0.005818
```

```
> m2 <- lm(ratio ~ temp)
```

```
Coefficients:
              Estimate Std. Error t value Pr(>|t|)
(Intercept)  1.036897   0.018667  55.547 7.94e-15 ***
temp         0.007941   0.001843   4.307  0.00124 **
---

```

$$ratio_i = \alpha + \beta temp_i + \varepsilon_i,$$
$$\varepsilon_i \sim N\left(0, \frac{\sigma^2}{number}\right), \text{ nezávisle pro různé lokality.}$$

```
> m3 <- update(m2, weights=number)
> summary(m3)
...
Coefficients:
              Estimate Std. Error t value Pr(>|t|)
(Intercept)  1.084297   0.015481  70.038 6.24e-16 ***
temp          0.003265   0.001510   2.162  0.0535 .
---
Signif. codes:  0 '***' 0.001 '**' 0.01 '*' 0.05 '.' 0.1 ' ' 1

Residual standard error: 0.04727 on 11 degrees of freedom
Multiple R-Squared:  0.2982,    Adjusted R-squared:  0.2345
F-statistic: 4.675 on 1 and 11 DF,  p-value: 0.0535
```

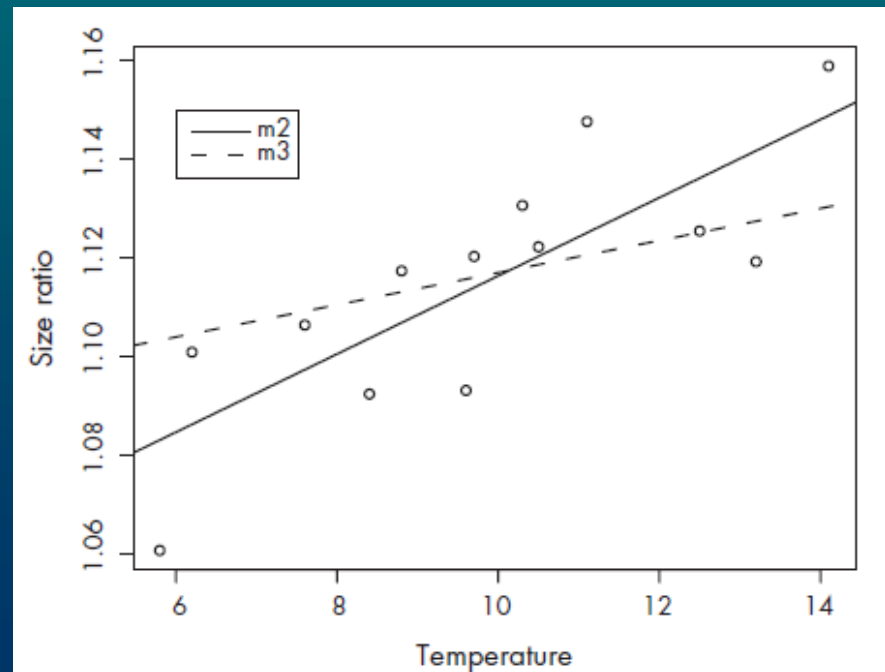
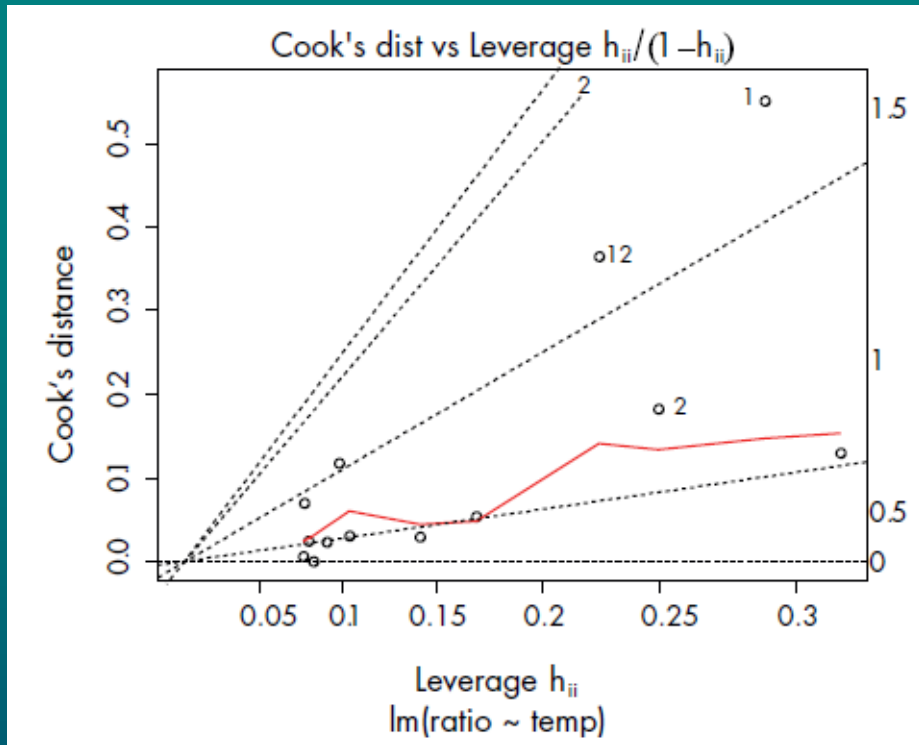

# 2-way ANOVA

## Background

The carcinogenic disease is related to the production of toxins by certain bacteria in the body of patients. Presence of toxins can be used as an indicator of certain carcinogenic disease.

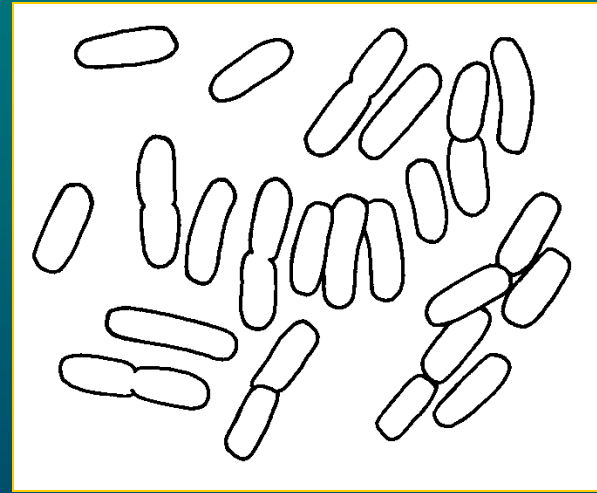

## Design

In a clinical study, the amount of a toxin [units/ $\mu\text{l}$ ] produced by four bacteria species was measured in patients with two carcinogenic and two non-carcinogenic diseases. For each disease there were 20 patients. In each patient only a single bacterial toxin was measured so there were 5 replications per bacteria species.

## Hypotheses

Is the amount of toxin similar for four bacteria species and four diseases?

If not what is the difference?

Which species can be used as an indicator?

## Variables

*SPECIES*: bacterA, bacterB,  
bacterC, bacterD

*DIAGNOSIS*: carc.rectum,  
carc.intestine,  
apendicitis, skin.absces

*toxin*

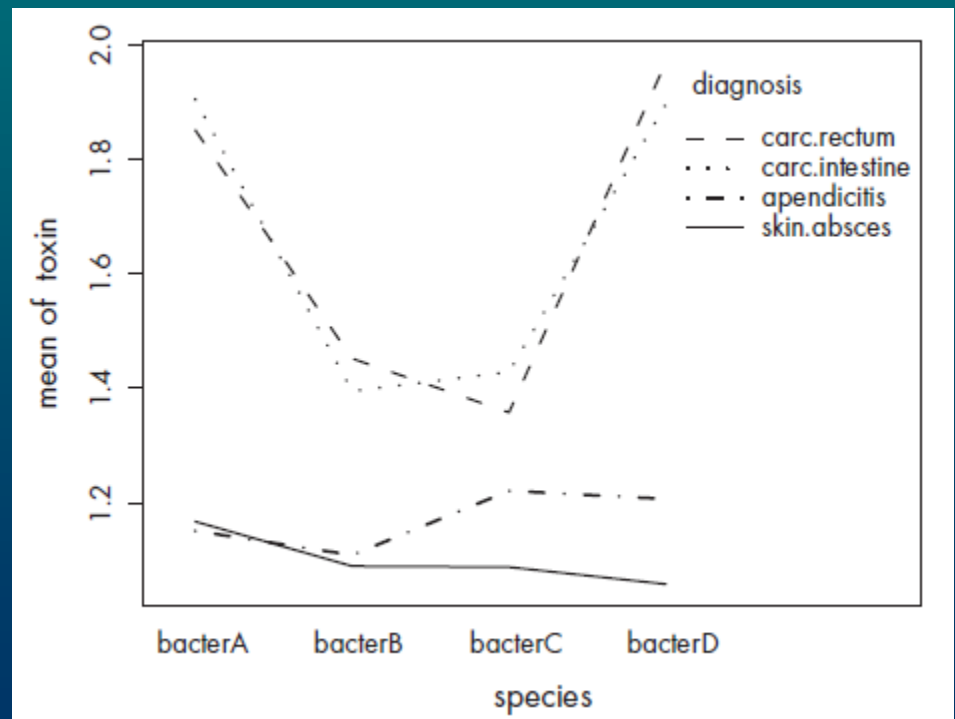

$toxin_{ijk} = \alpha + SPECIES_j + DIAGNOSIS_k + SPECIES:DIAGNOSIS_{jk} + \varepsilon_{ijk}$ ,  
kde  $\varepsilon_{ijk} \sim N(0, \sigma^2)$ , nezávisle pro jednotlivé pacienty.

```
> m1 <- lm(toxin ~ species*diagnosis)
```

```
> anova(m1)
```

Analysis of Variance Table

Response: toxin

	Df	Sum Sq	Mean Sq	F value	Pr(>F)	
species	3	1.3364	0.4455	28.0325	1.077e-11	***
diagnosis	3	5.4775	1.8258	114.8965	< 2.2e-16	***
species:diagnosis	9	1.2704	0.1412	8.8827	1.528e-08	***
Residuals	64	1.0170	0.0159			

# ANOVA Table

- **anova** uses Type I Sum of Squares
  - sequential assessment of effects according to the given order
  - at first main effects are assessed then interactions
  - in orthogonal the order is not important
  - if data are unorthogonal it is more appropriate to use Type III SS

## Orthogonality

- independent variables are orthogonal - effects are straightforward
- correlated variables are unorthogonal - effects are complicated
  - when there are missing values or unequal number of observations *per* treatment

```

> summary(m1)
...
Coefficients:
                                Estimate Std. Error t value Pr(>|t|)
(Intercept)                    1.15100    0.05638   20.417 < 2e-16
speciesbacterB                 -0.04220    0.07973   -0.529 0.598427
speciesbacterC                  0.07000    0.07973    0.878 0.383233
speciesbacterD                  0.05580    0.07973    0.700 0.486536
diagnosiscarc.intestine         0.75400    0.07973    9.457 9.07e-14
diagnosiscarc.rectum           0.70040    0.07973    8.785 1.34e-12
diagnosissskin.absces          0.01640    0.07973    0.206 0.837678
speciesbacterB:diagnosiscarc.intestine -0.46760    0.11275   -4.147 0.000101
speciesbacterC:diagnosiscarc.intestine -0.54620    0.11275   -4.844 8.42e-06
speciesbacterD:diagnosiscarc.intestine -0.06420    0.11275   -0.569 0.571083
speciesbacterB:diagnosiscarc.rectum   -0.35700    0.11275   -3.166 0.002366
speciesbacterC:diagnosiscarc.rectum   -0.56340    0.11275   -4.997 4.78e-06
speciesbacterD:diagnosiscarc.rectum    0.06300    0.11275    0.559 0.578282
speciesbacterB:diagnosissskin.absces  -0.03580    0.11275   -0.318 0.751889
speciesbacterC:diagnosissskin.absces  -0.14960    0.11275   -1.327 0.189287
speciesbacterD:diagnosissskin.absces  -0.16520    0.11275   -1.465 0.147771

```

```

> tapply(predict(m1), list(species,diagnosis), mean)
      apendicitis  carc.intestine  carc.rectum  skin.absces
bacterA      1.1510      1.9050      1.8514      1.1674
bacterB      1.1088      1.3952      1.4522      1.0894
bacterC      1.2210      1.4288      1.3580      1.0878
bacterD      1.2068      1.8966      1.9702      1.0580

```



```
> diagnosis1 <- c(rep("carc",40), rep("non",40))
> diagnosis1 <- factor(diagnosis1)
```

```
> m2 <- lm(toxin ~ species*diagnosis1)
> anova(m1, m2)
```

Analysis of Variance Table

Model 1: toxin ~ species \* diagnosis

Model 2: toxin ~ species \* diagnosis1

	Res.Df	RSS	Df	Sum of Sq	F	Pr(>F)
1	64	1.0170				
2	72	1.1597	-8	-0.1427	1.1225	0.3605

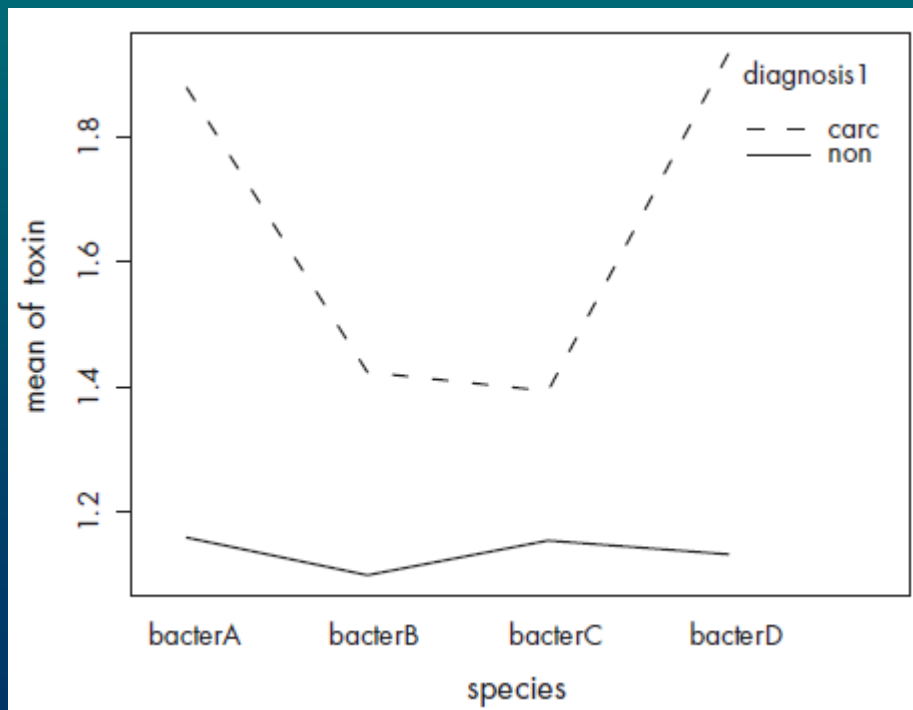

```

> species1 <- species
> levels(species1)
[1] "bacterA" "bacterB" "bacterC" "bacterD"
> levels(species1)[2:3] <- "bacterBC"
> m3 <- lm(toxin ~ species1*diagnosis1)
> anova(m2, m3)
Analysis of Variance Table

Model 1: toxin ~ species * diagnosis1
Model 2: toxin ~ species1 * diagnosis1
  Res.Df    RSS Df Sum of Sq    F Pr(>F)
1      72  1.15974
2      74  1.17962 -2  -0.01988 0.6171 0.5423
> levels(species1)
[1] "bacterA" "bacterBC" "bacterD"
> levels(species1)[c(1,3)] <- "bacterAD"
> m4 <- lm(toxin ~ species1*diagnosis1)
> anova(m3, m4)
Analysis of Variance Table

Model 1: toxin ~ species1 * diagnosis1
Model 2: toxin ~ species1 * diagnosis1
  Res.Df    RSS Df Sum of Sq    F Pr(>F)
1      74  1.17962
2      76  1.19845 -2  -0.01883 0.5905 0.5566

```

```
> anova(m4)
```

```
Analysis of Variance Table
```

```
Response: toxin
```

	Df	Sum Sq	Mean Sq	F value	Pr(>F)	
species1	1	1.3328	1.3328	84.522	5.690e-14	***
diagnosis1	1	5.4267	5.4267	344.139	< 2.2e-16	***
species1:diagnosis1	1	1.1434	1.1434	72.508	1.134e-12	***
Residuals	76	1.1984	0.0158			

```
---
```

```
Signif. codes:  0 '***' 0.001 '**' 0.01 '*' 0.05 '.' 0.1 ' ' 1
```

```
> summary(m4)
```

```
...
```

```
Coefficients:
```

	Estimate	Std. Error	t value	Pr(> t )	
(Intercept)	1.90580	0.02808	67.872	< 2e-16	***
species1bacterBC	-0.49725	0.03971	-12.522	< 2e-16	***
diagnosis1non	-0.76000	0.03971	-19.139	< 2e-16	***
species1bacterBC:diagnosis1non	0.47820	0.05616	8.515	1.13e-12	***

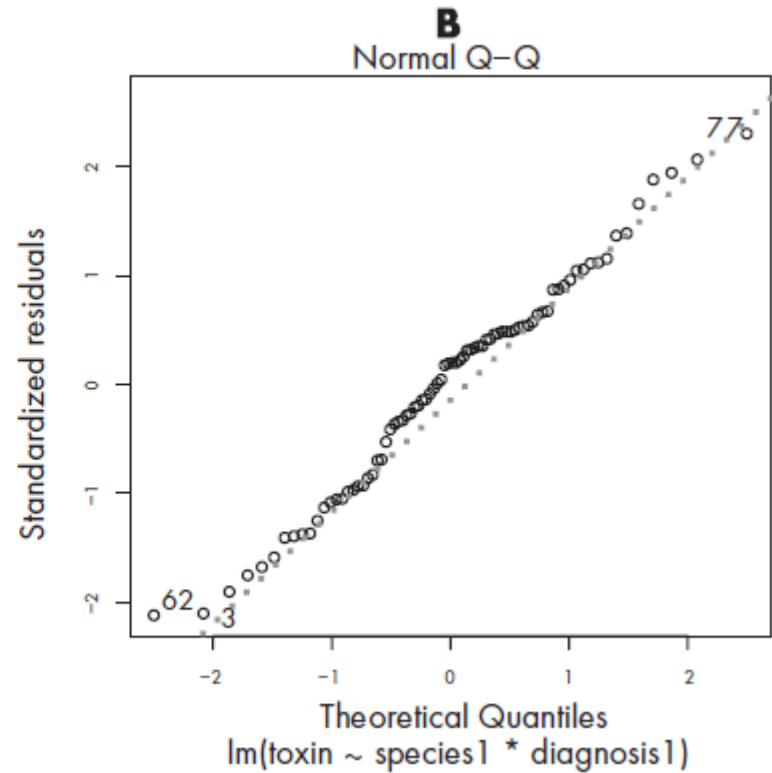
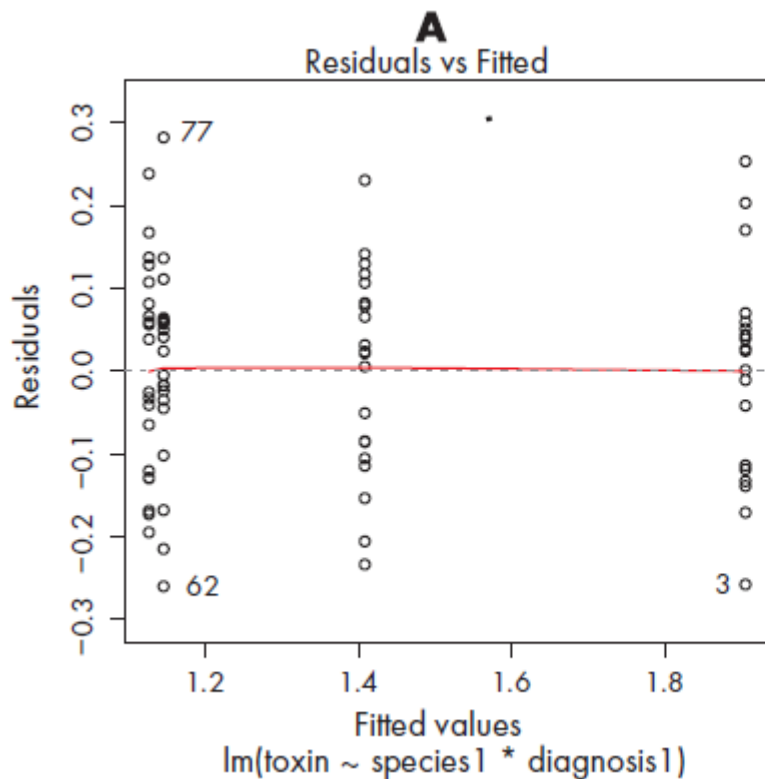

```
> both <- paste(species1, diagnosis1)
> both <- factor(both)
> m5 <- lm(toxin ~ both - 1)
> summary(m5)
```

...

Coefficients:

		Estimate	Std. Error	t value	Pr(> t )	
bothbacterAD	carc	1.90580	0.02808	67.87	<2e-16	***
bothbacterAD	non	1.14580	0.02808	40.81	<2e-16	***
bothbacterBC	carc	1.40855	0.02808	50.16	<2e-16	***
bothbacterBC	non	1.12675	0.02808	40.13	<2e-16	***

```
> confint(m5)
```

		2.5%	97.5%
bothbacterAD	carc	1.849875	1.961725
bothbacterAD	non	1.089875	1.201725
bothbacterBC	carc	1.352625	1.464475
bothbacterBC	non	1.070825	1.182675

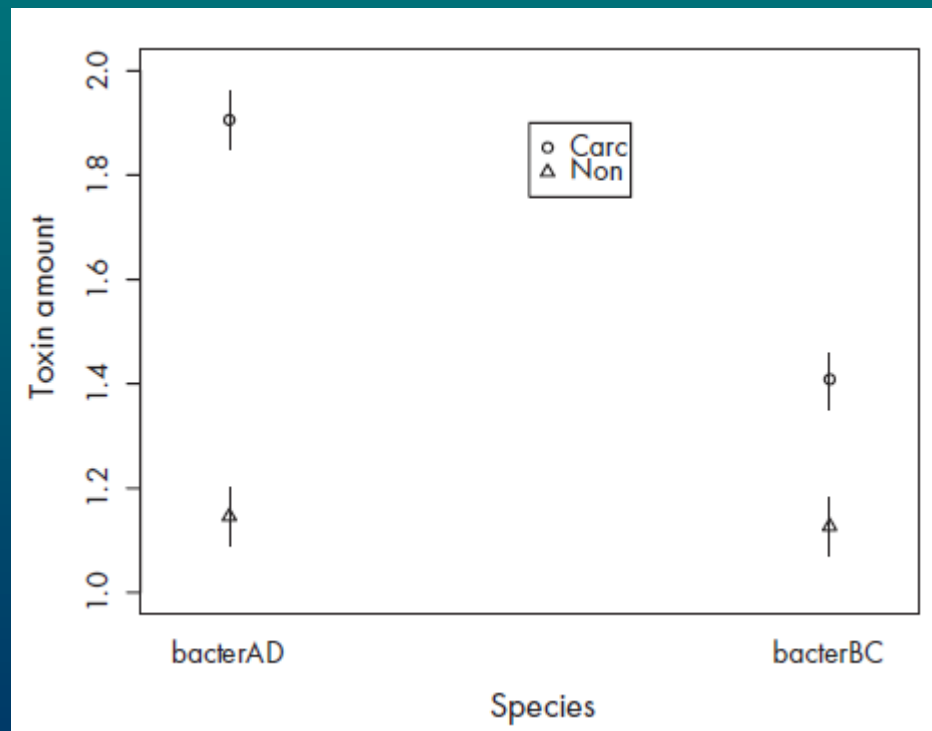

# 1-way ANCOVA

## Background

Rate of population increase is a function of temperature in ectotherms, such as mites. A model of the relationship is essential for the control of mite pests.

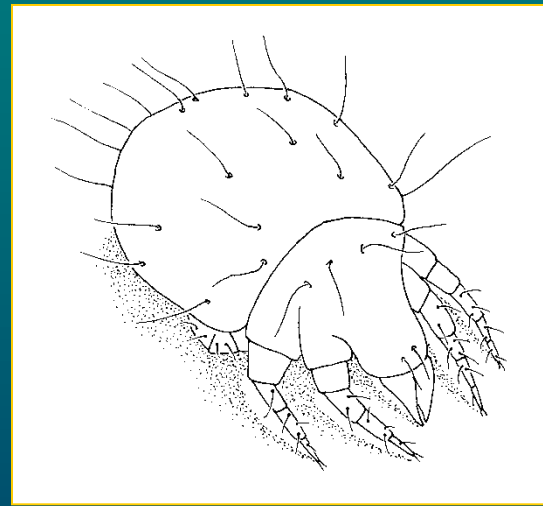

## Design

In the lab, population increase of two pest mite species was studied at 11 temperatures between 10 and 35 °C. The rate of increase was estimated using formula for exponential population growth. For each temperature a single measurement for each species was available.

## Hypotheses

Did temperature affect the rate of increase?

Was the rate similar for both species?

What is the model of the relationship?

## Variables

*GENUS*: genA, genB

*temp*

*rate*

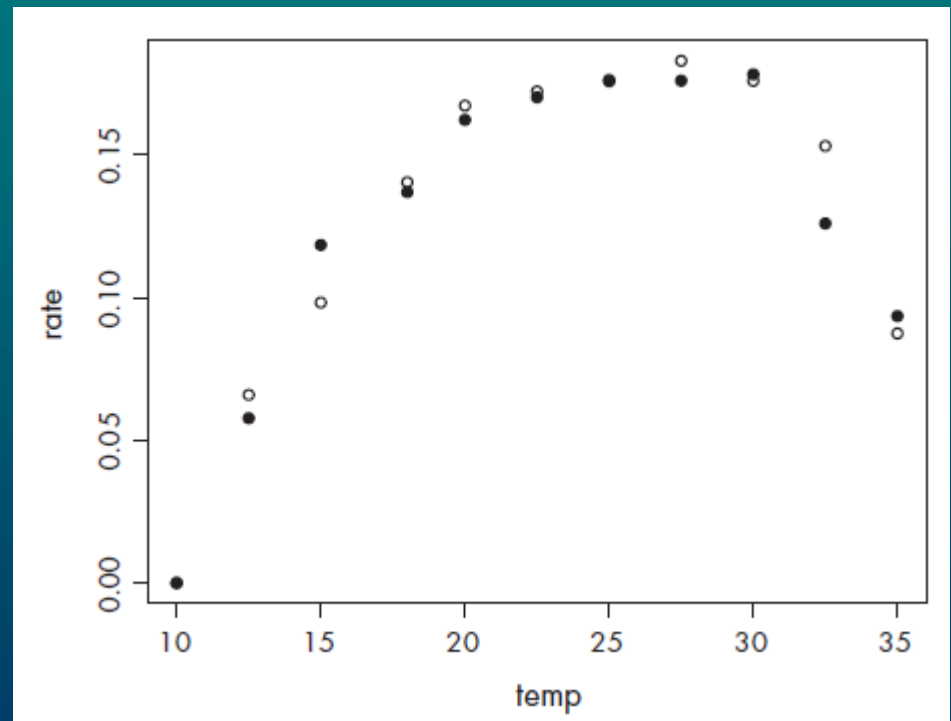

$$rate_{ij} = \alpha + GENUS_j + \beta temp_i + \gamma temp_i^2 + \tau temp_i^3 + \delta_j temp_i + \omega_j temp_i^2 + \eta_j temp_i^3 + \varepsilon_{ij},$$

kde  $\varepsilon_{ij} \sim N(0, \sigma^2)$ , nezávisle pro jednotlivé populace. (8-12)

```
> m1 <- lm(rate ~ poly(temp,3)*genus)
```

```
> anova(m1)
```

```
Analysis of Variance Table
```

```
Response: rate
```

	Df	Sum Sq	Mean Sq	F value	Pr(>F)	
poly(temp, 3)	3	0.065953	0.021984	210.0675	7.125e-12	***
genus	1	0.000028	0.000028	0.2644	0.6152	
poly(temp, 3):genus	3	0.000108	0.000036	0.3454	0.7930	
Residuals	14	0.001465	0.000105			

```
---
```

```
> m2 <- lm(rate ~ poly(temp,3)+genus)
```

```
> anova(m1, m2)
```

	Res.Df	RSS	Df	Sum of Sq	F	Pr(>F)
1	14	0.00146516				
2	17	0.00157360	-3	-0.00010844	0.3454	0.793

```
> anova(m2)
```

```
Analysis of Variance Table
```

```
Response: rate
```

	Df	Sum Sq	Mean Sq	F value	Pr(>F)	
poly(temp, 3)	3	0.065953	0.021984	237.5038	4.509e-14	***
genus	1	0.000028	0.000028	0.2989	0.5917	
Residuals	17	0.001574	0.000093			

```
---
```



```

> m3 <- lm(rate ~ temp + I(temp^2) + I(temp^3))
> summary(m3)

...
Coefficients:
              Estimate Std. Error t value Pr(>|t|)
(Intercept) -2.675e-01  5.138e-02  -5.205 5.97e-05 ***
temp         3.191e-02  7.855e-03   4.063 0.00073 ***
I(temp^2)    -3.986e-04  3.704e-04  -1.076 0.29608
I(temp^3)    -6.178e-06  5.464e-06  -1.131 0.27309
---
Signif. codes:  0 '***' 0.001 '**' 0.01 '*' 0.05 '.' 0.1 ' ' 1

Residual standard error: 0.009432 on 18 degrees of freedom
Multiple R-Squared: 0.9763,    Adjusted R-squared: 0.9723
F-statistic: 247.1 on 3 and 18 DF,  p-value: 8.234e-15

```

```

> m4 <- lm(rate ~ temp + I(temp^2))
> summary(m4)

...
Coefficients:
              Estimate Std. Error t value Pr(>|t|)
(Intercept) -3.222e-01  1.734e-02 -18.59 1.20e-13 ***
temp         4.060e-02  1.662e-03  24.42 8.20e-16 ***
I(temp^2)    -8.154e-04  3.649e-05 -22.35 4.20e-15 ***

```

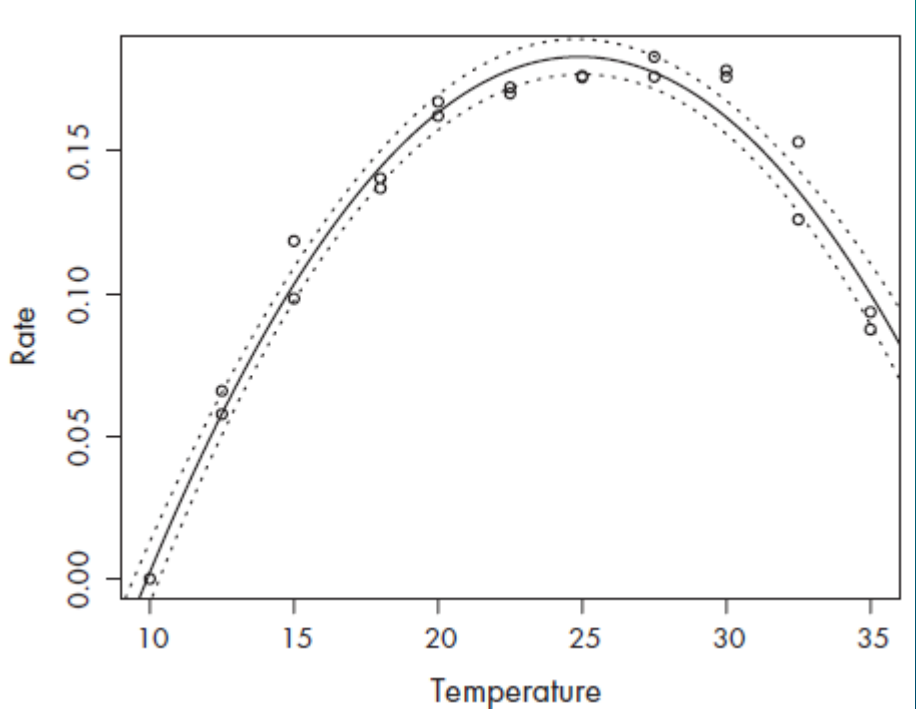

# Multiple Regression

## Background

Yield of cereals is determined by a number of variables. To predict yield with high accuracy, various effects have to be studied.



## Design

On 100 plots, the yield of wheat [t/ha] was estimated together with six other variables: 1. number of overwintering plants, 2. number of ears/m<sup>2</sup>, 3. pH of soil, 4. content of phosphorus [mg/kg], 5. content of potassium [mg/kg], 6. content of magnesium [mg/kg].

## Hypotheses

Did any of six variables affect the yield?

If so which ones?

What is the model for prediction of yield?

## Variables

*winter*

*ears*

*pH*

*P*

*K*

*Mg*

*yield*

```
> pairs(yield ~ winter + ears + pH + P + K + Mg, panel=panel.smooth)
```

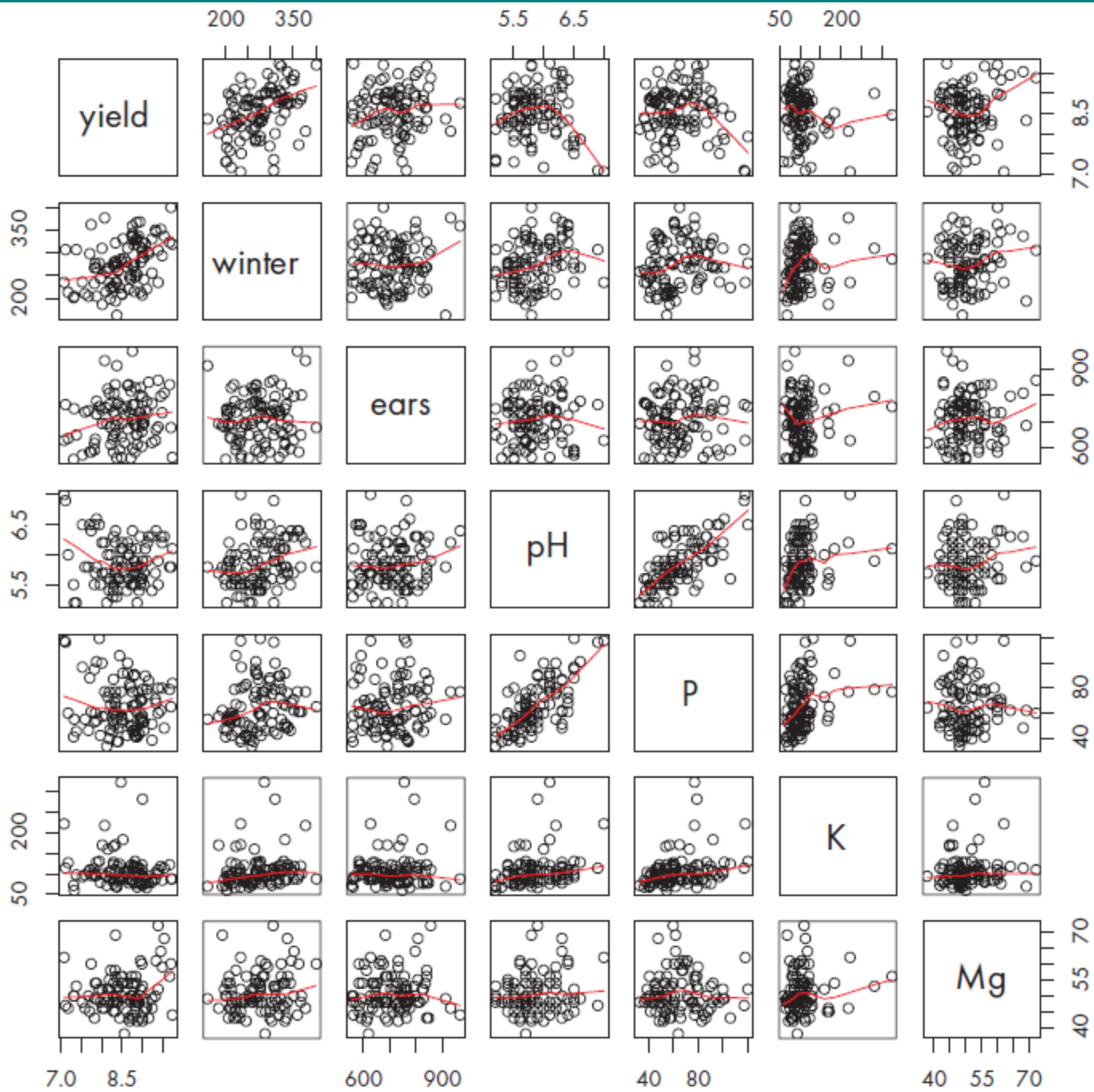

# Collinearity

- When two or more variables show correlation
- PCA can reduce dimensionability of variables – use PCA scores instead

```
> pca <- princomp(~ pH + P, cor=T)
> summary(pca)
Importance of components:

                Comp.1      Comp.2
Standard deviation    1.3049566  0.5450579
Proportion of Variance 0.8514559  0.1485441
Cumulative Proportion 0.8514559  1.0000000
```

```
> PpH <- pca$scores[,1]
```

$$yield_i = \alpha + \beta_1 winter_i + \beta_2 ears_i + \beta_3 PpH_i + \beta_4 K_i + \beta_5 Mg_i + \varepsilon_i,$$

$\varepsilon_i \sim N(0, \sigma^2)$ , nezávisle pro různé parcely.

```
> m1 <- lm(yield ~ (winter+ears+PpH+K+Mg)^2 + I(winter^2) + I(ears^2) +
+ I(PpH^2) + I(K^2) + I(Mg^2))
> anova(m1)
```

Analysis of Variance Table

Response: yield

	Df	Sum Sq	Mean Sq	F value	Pr(>F)	
winter	1	6.5802	6.5802	30.7489	3.764e-07	***
ears	1	0.7288	0.7288	3.4059	0.068712	.
PpH	1	2.1751	2.1751	10.1643	0.002053	**
K	1	0.8568	0.8568	4.0039	0.048830	*
Mg	1	0.3331	0.3331	1.5568	0.215821	
I(winter^2)	1	0.0765	0.0765	0.3576	0.551530	
I(ears^2)	1	0.2315	0.2315	1.0818	0.301467	
I(PpH^2)	1	5.1354	5.1354	23.9977	5.029e-06	***
I(K^2)	1	0.5878	0.5878	2.7470	0.101404	
I(Mg^2)	1	0.6129	0.6129	2.8643	0.094507	.
winter:ears	1	0.1428	0.1428	0.6672	0.416483	
winter:PpH	1	0.1404	0.1404	0.6561	0.420386	
winter:K	1	0.1144	0.1144	0.5344	0.466933	
winter:Mg	1	0.1899	0.1899	0.8874	0.349062	
ears:PpH	1	0.1256	0.1256	0.5871	0.445817	
ears:K	1	0.0176	0.0176	0.0823	0.774937	
ears:Mg	1	0.1679	0.1679	0.7847	0.378402	
PpH:K	1	0.1648	0.1648	0.7702	0.382831	
PpH:Mg	1	0.1922	0.1922	0.8982	0.346156	
K:Mg	1	0.1277	0.1277	0.5965	0.442209	
Residuals	79	16.9057	0.2140			

```

> m2 <- step(m1)
...
> anova(m2)
Analysis of Variance Table

Response: yield

      Df Sum Sq Mean Sq F value    Pr(>F)
winter  1  6.5802   6.5802  33.3952 1.018e-07 ***
ears    1  0.7288   0.7288   3.6990 0.057538 .
K       1  1.7444   1.7444   8.8531 0.003737 **
Mg      1  0.2961   0.2961   1.5026 0.223400
I (PpH^2) 1  5.9517   5.9517  30.2056 3.446e-07 ***
ears:Mg  1  0.6489   0.6489   3.2935 0.072815 .
K:Mg    1  1.5297   1.5297   7.7634 0.006475 **
Residuals 92 18.1276   0.1970
---

```

```

> summary(m2, corr=T)

```

```

Correlation of Coefficients:
      (Intercept) winter ears  K    Mg    I (PpH^2) ears:Mg
winter  -0.05
ears    -0.91      -0.02
K       -0.38      0.00  -0.02
Mg      -0.99      -0.02   0.91  0.36
I (PpH^2) -0.01      0.07  -0.15  0.31 -0.02
ears:Mg  0.90      0.02  -0.99  0.02 -0.92  0.16
K:Mg    0.38      -0.02   0.02 -1.00 -0.36 -0.33  -0.03

```



```

> w1 <- scale(winter); e1 <- scale(ears); pH1 <- scale(pH)
> P1 <- scale(P); K1 <- scale(K); Mg1 <- scale(Mg)
> m3 <- lm(yield ~ (w1+e1+pH1+P1+K1+Mg1)^2 + I(w1^2) + I(e1^2) + I(pH1^2) +
+ I(P1^2) + I(K1^2) + I(Mg1^2))
> anova(m3)

```

Analysis of Variance Table

Response: yield

	Df	Sum Sq	Mean Sq	F value	Pr(>F)	
w1	1	6.5802	6.5802	32.3949	2.542e-07	***
e1	1	0.7288	0.7288	3.5882	0.062208	.
pH1	1	2.1735	2.1735	10.7005	0.001646	**
P1	1	0.0964	0.0964	0.4748	0.492988	
K1	1	0.9223	0.9223	4.5407	0.036513	*
Mg1	1	0.4403	0.4403	2.1675	0.145310	
I(w1^2)	1	0.0232	0.0232	0.1140	0.736647	
I(e1^2)	1	0.2189	0.2189	1.0776	0.302707	
I(pH1^2)	1	5.2872	5.2872	26.0295	2.629e-06	***
I(P1^2)	1	0.0390	0.0390	0.1919	0.662635	
I(K1^2)	1	0.6269	0.6269	3.0861	0.083213	.
I(Mg1^2)	1	0.7946	0.7946	3.9120	0.051770	.
w1:e1	1	0.1109	0.1109	0.5461	0.462318	

w1:pH1	1	0.0001	0.0001	0.0005	0.981871
w1:P1	1	0.3435	0.3435	1.6911	0.197610
w1:K1	1	0.2448	0.2448	1.2051	0.275966
w1:Mg1	1	0.1437	0.1437	0.7072	0.403144
e1:pH1	1	0.1750	0.1750	0.8616	0.356386
e1:P1	1	0.3084	0.3084	1.5182	0.221900
e1:K1	1	0.0010	0.0010	0.0048	0.945214
e1:Mg1	1	0.0699	0.0699	0.3442	0.559238
pH1:P1	1	0.0076	0.0076	0.0372	0.847532
pH1:K1	1	0.0695	0.0695	0.3421	0.560434
pH1:Mg1	1	0.4321	0.4321	2.1272	0.149055
P1:K1	1	0.6919	0.6919	3.4061	0.069067 .
P1:Mg1	1	0.0921	0.0921	0.4535	0.502830
K1:Mg1	1	0.3609	0.3609	1.7766	0.186774
Residuals	72	14.6249	0.2031		

---

```

> m4 <- update(m3, ~.-w1:pH1); anova(m4)
> m5 <- update(m4, ~.-e1:K1); anova(m5)
...
> anova(m26)
Analysis of Variance Table

Response: yield
      Df Sum Sq Mean Sq F value    Pr(>F)
w1      1  6.5802   6.5802  30.4123 3.001e-07 ***
pH1     1  1.9487   1.9487   9.0066 0.003436 **
K1      1  0.8711   0.8711   4.0262 0.047642 *
I (pH1^2) 1  5.6527   5.6527  26.1256 1.653e-06 ***
Residuals 95 20.5547   0.2164
---

```

$$a + b_1 \frac{\text{winter} - \bar{y}_{\text{winter}}}{s_{\text{winter}}} + b_2 \frac{\text{pH} - \bar{y}_{\text{pH}}}{s_{\text{pH}}} + c_1 \left( \frac{\text{pH} - \bar{y}_{\text{pH}}}{s_{\text{pH}}} \right)^2 + b_3 \frac{\text{K} - \bar{y}_{\text{K}}}{s_{\text{K}}}$$

```

> mean(winter); sd(winter)
[1] 275.64
[1] 50.94392
> mean(pH); sd(pH)
[1] 5.852
[1] 0.3812473
> mean(K); sd(K)
[1] 106.66
[1] 40.39657

```

```
> summary(m26, corr=T)
```

```
...
```

```
Coefficients:
```

	Estimate	Std. Error	t value	Pr(> t )	
(Intercept)	8.71416	0.05917	147.278	< 2e-16	***
w1	0.28494	0.04941	5.766	1.00e-07	***
pH1	-0.01134	0.05490	-0.206	0.8368	
K1	-0.09666	0.04885	-1.979	0.0508	.
I (pH1^2)	-0.18880	0.03694	-5.111	1.65e-06	***

```
---
```

```
Signif. codes:  0 '***' 0.001 '**' 0.01 '*' 0.05 '.' 0.1 ' ' 1
```

```
Residual standard error: 0.4652 on 95 degrees of freedom
```

```
Multiple R-Squared: 0.4227, Adjusted R-squared: 0.3984
```

```
F-statistic: 17.39 on 4 and 95 DF, p-value: 9.75e-11
```

```
Correlation of Coefficients:
```

	(Intercept)	w1	pH1	K1
w1	-0.06			
pH1	0.25	-0.28		
K1	0.00	-0.10	-0.22	
I (pH1^2)	-0.62	0.10	-0.40	-0.01

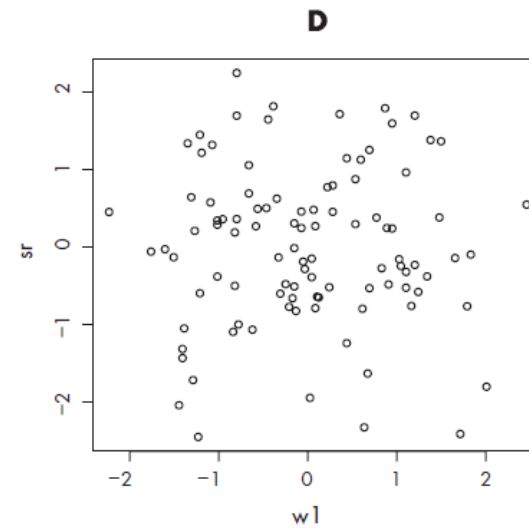
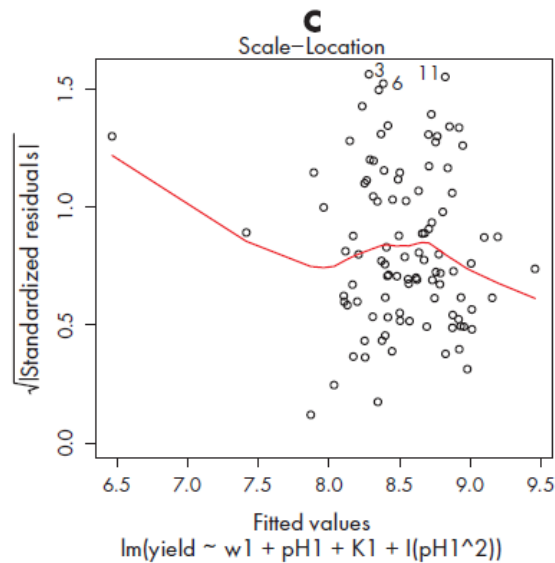
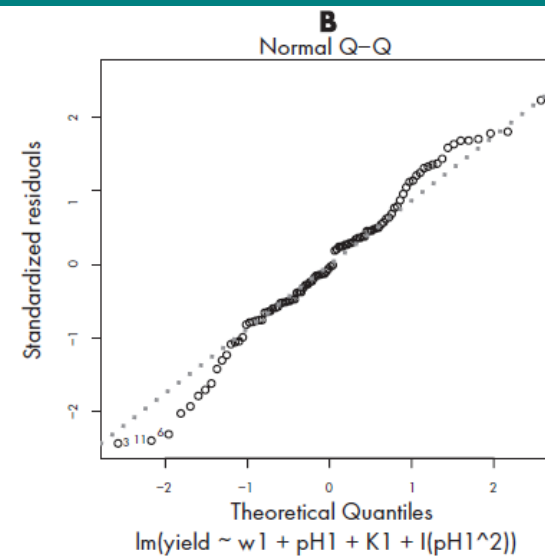
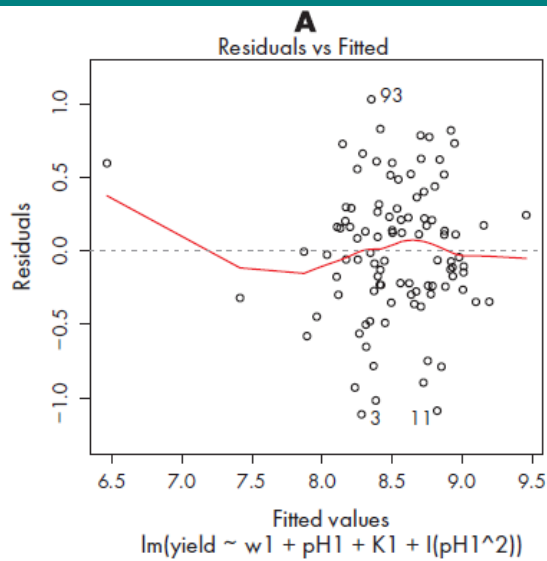

$$8.714 + 0.285 \frac{\text{winter} - 275.6}{50.94} - 0.011 \frac{pH - 5.852}{0.381} - 0.189 \left( \frac{pH - 5.852}{0.381} \right)^2 - 0.097 \frac{K - 106.7}{40.39}.$$