

Structural Virology

Lecture 5

Pavel Plevka



Financováno
Evropskou unií
NextGenerationEU



NÁRODNÍ
PLÁN OBNOVY

MS
MĚ
MIT
MINISTERSTVO ŠKOLSTVÍ,
MLÁDEŽE A TĚLOVÝCHOVY

Herpesviruses

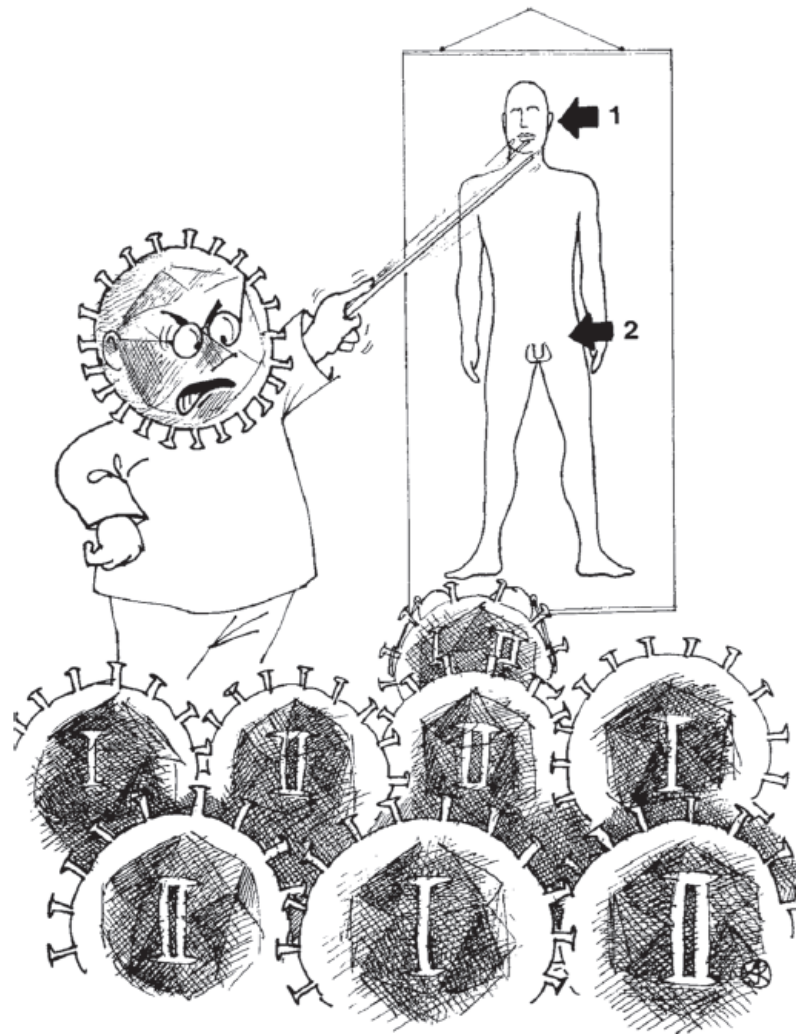

Figure 11.1 "Get your priorities right."

Source: Haaheim, Pattison, and Whiteley (2002) *A Practical Guide to Clinical Virology*, 2nd edition. Reproduced by permission of John Wiley & Sons.

Family *Herpesviridae*

herpein (Greek) = to creep

Hosts: mammals

birds

cold-blooded animals

Diseases: cold sores
genital herpes
chickenpox/shingles

Virion

- Enveloped
- Icosahedral
- 120-200 nm diameter
- Genome: double-stranded DNA
125–240 kbp
linear

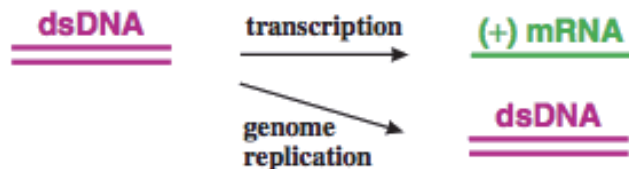
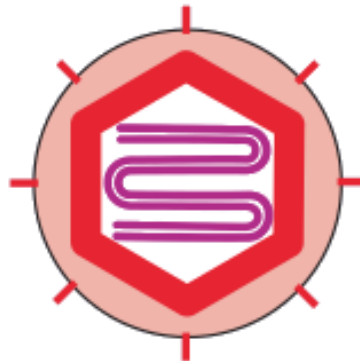

Latent infection

(a) Establishment

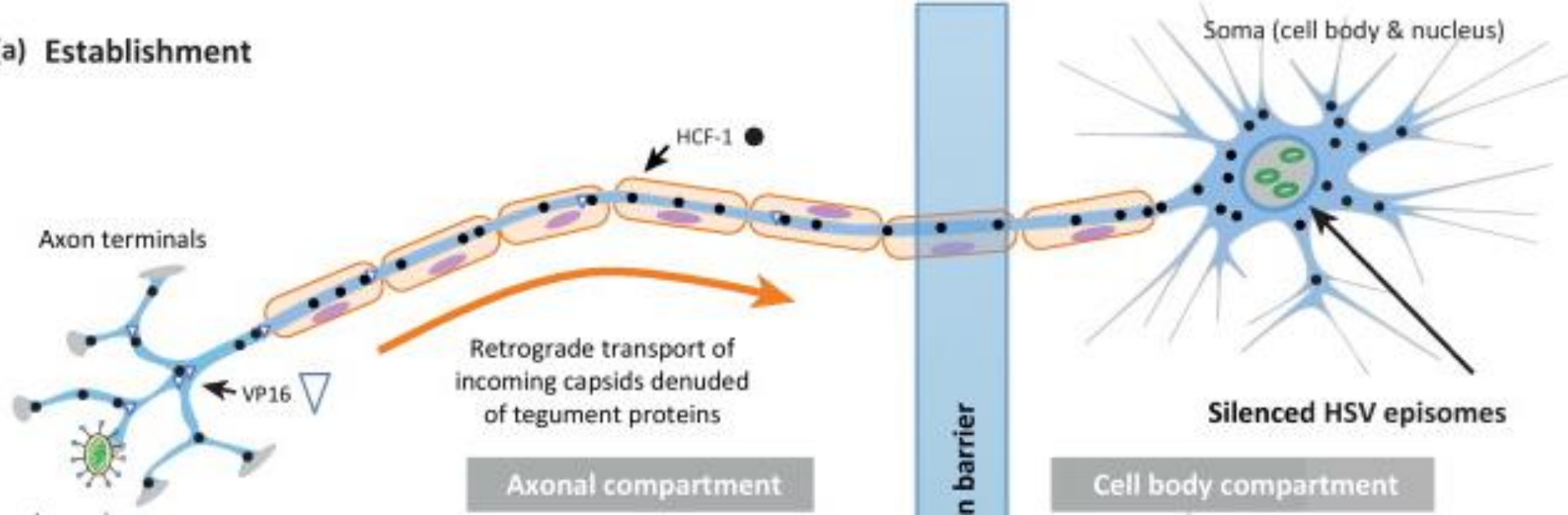

(b) Reactivation

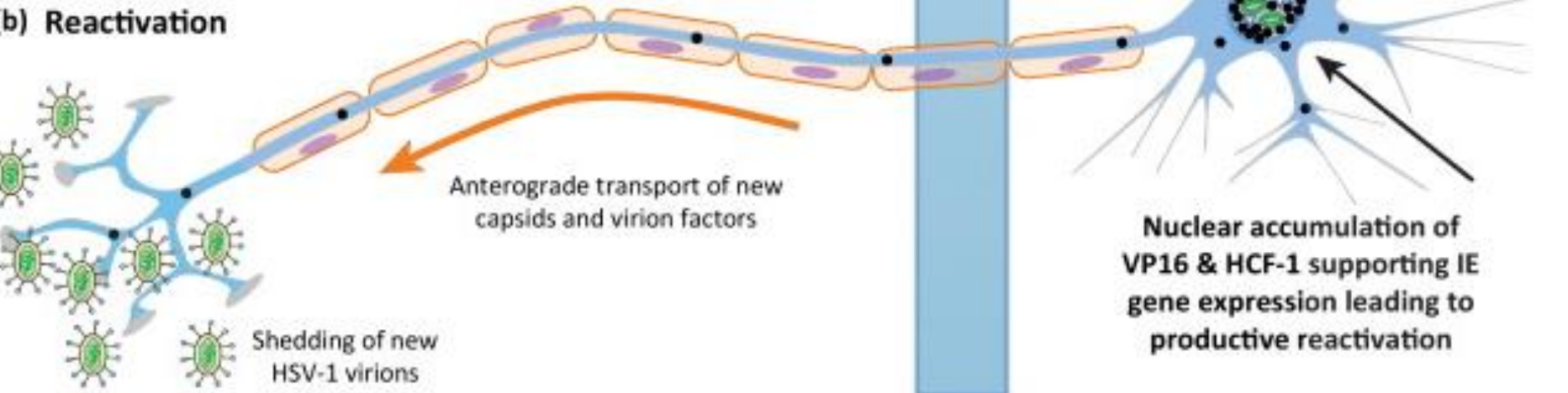

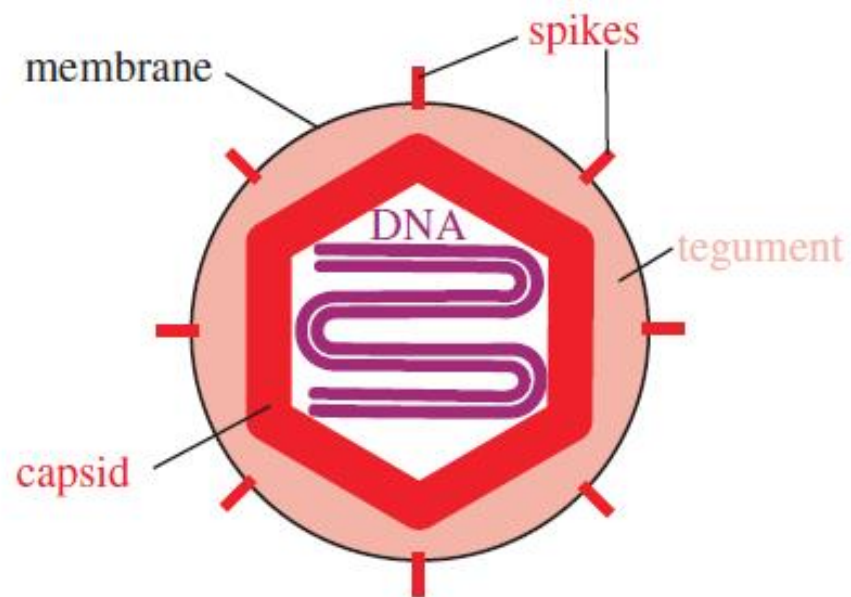

Electron cryo-tomographic visualizations

(b) Central slice through reconstructed volume

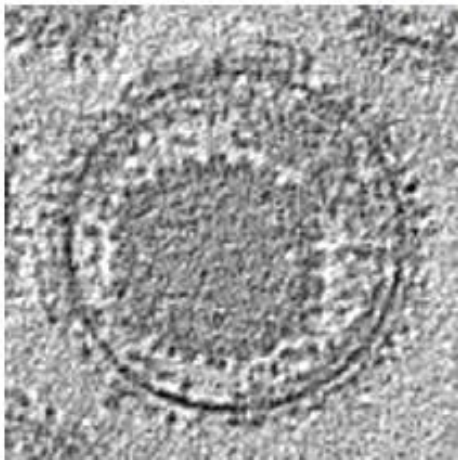

(c) Cut-away view

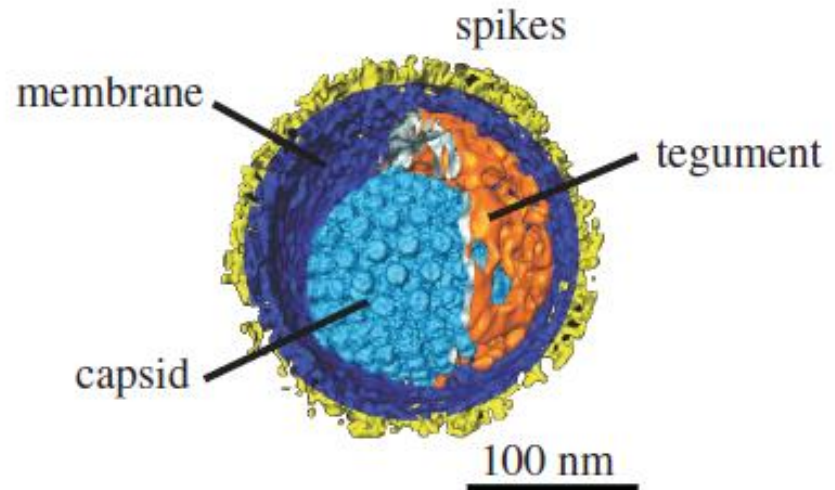

HSV1 capsid

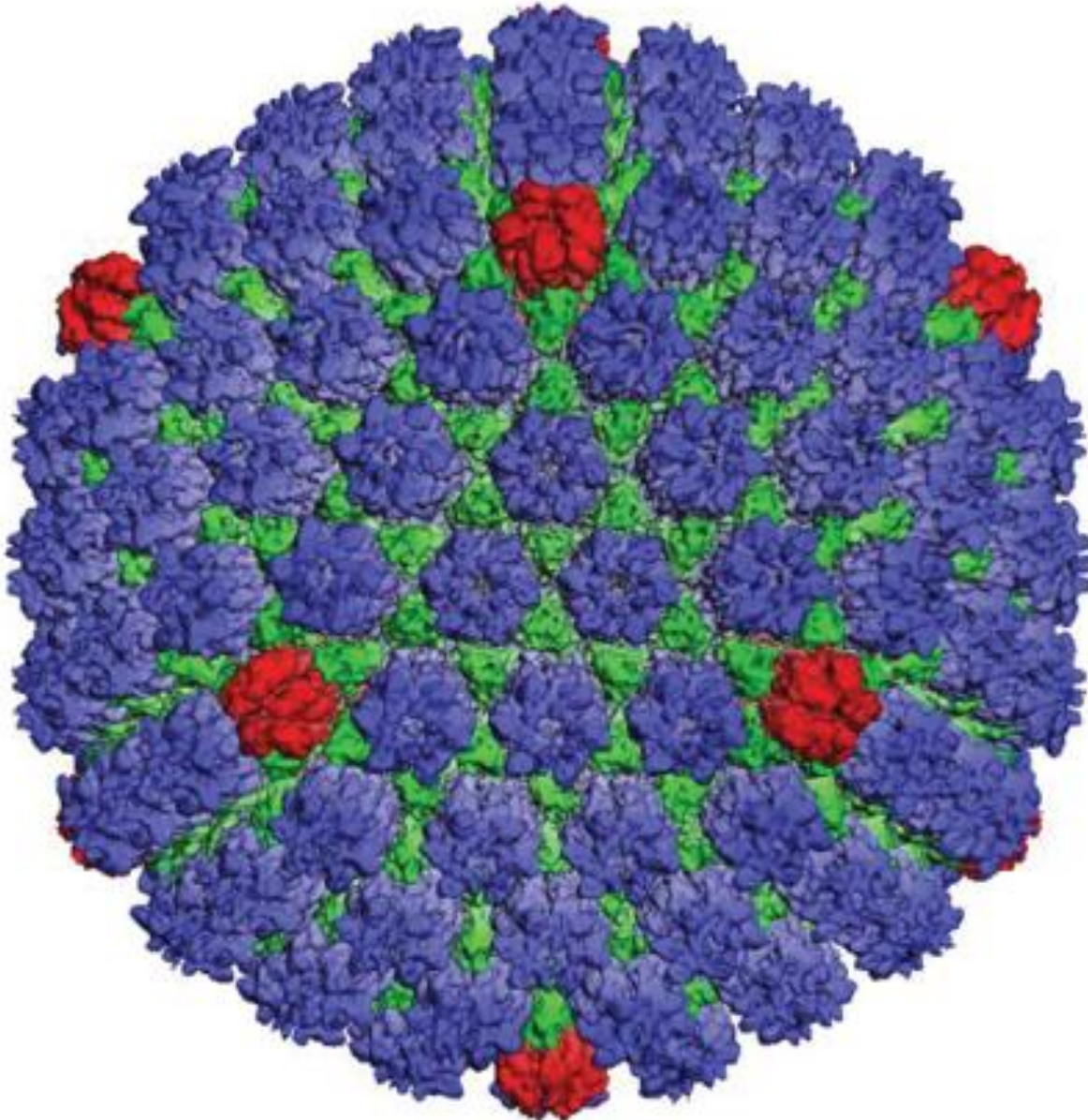

HSV1 genome

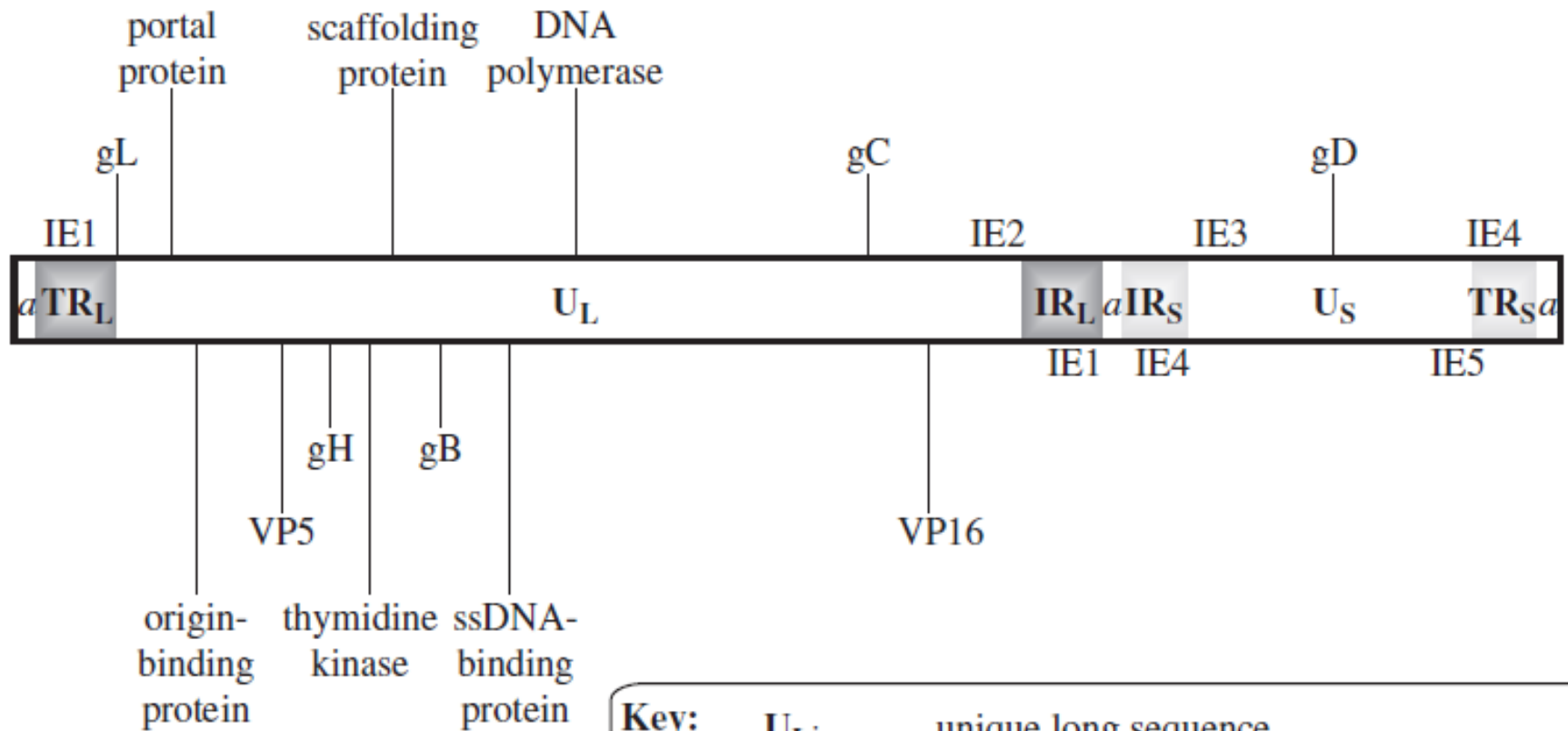

Key:

- U_L:** unique long sequence
- U_S:** unique short sequence
- TR_L, IR_L:** terminal and inverted repeats flanking U_L
- TR_S, IR_S:** terminal and inverted repeats flanking U_S
- a:** repeat sequence, present as several copies
- IE:** gene for an immediate early protein

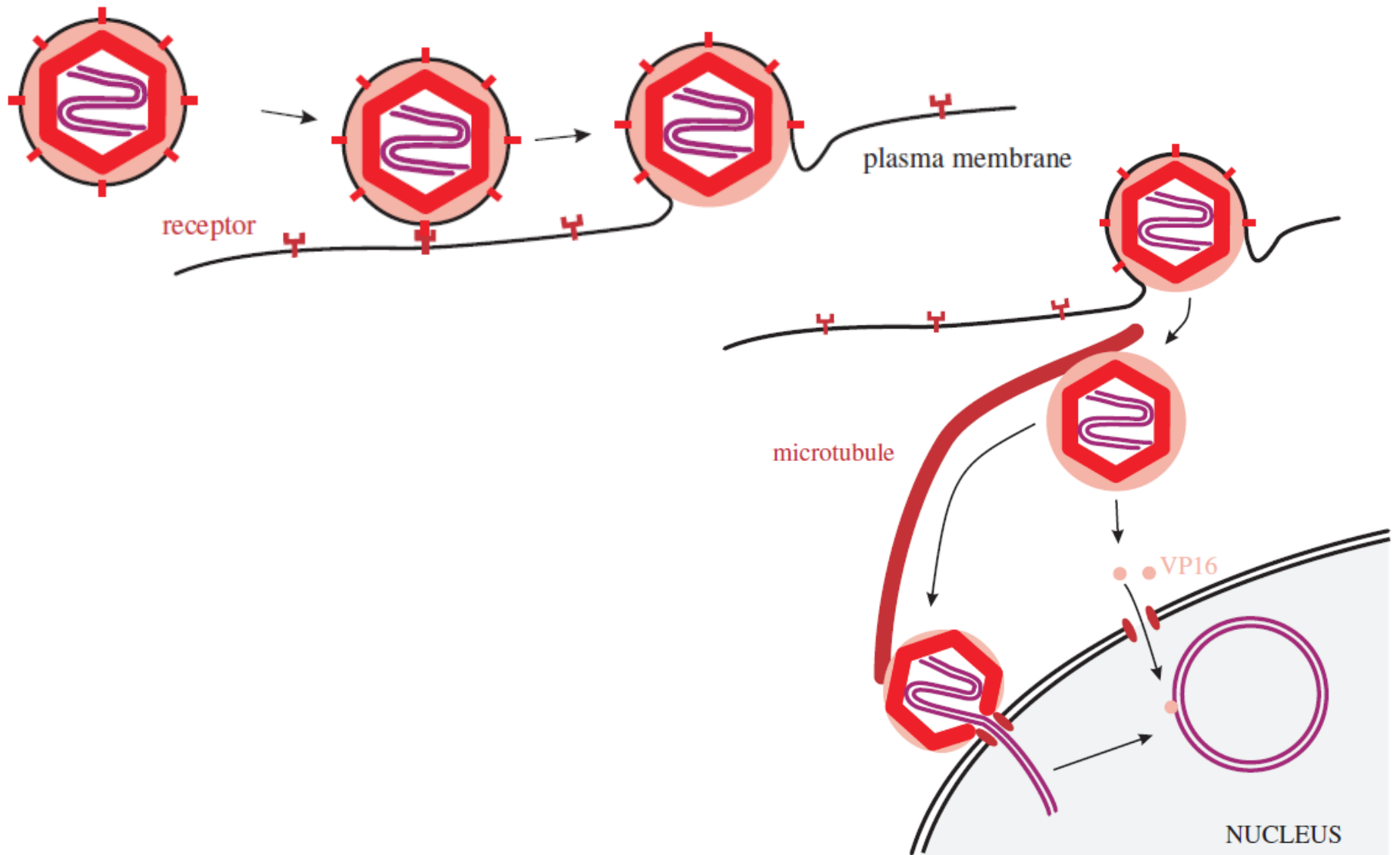

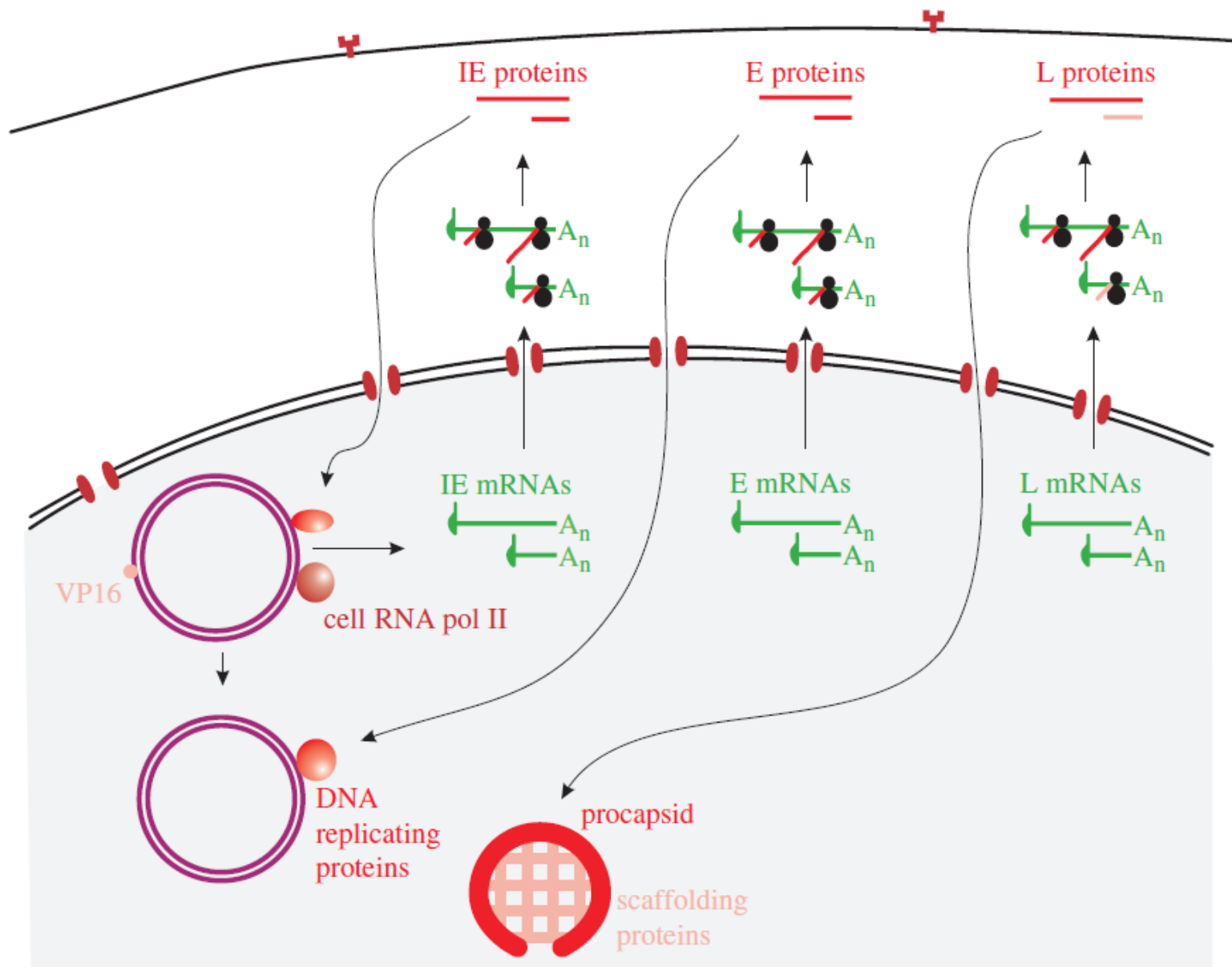

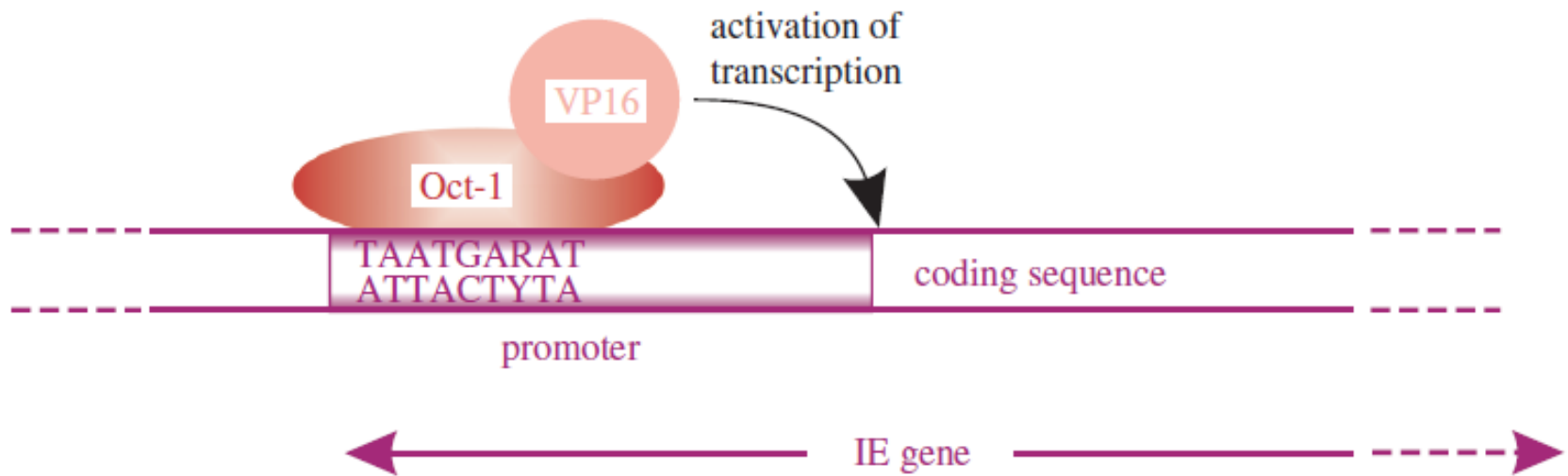

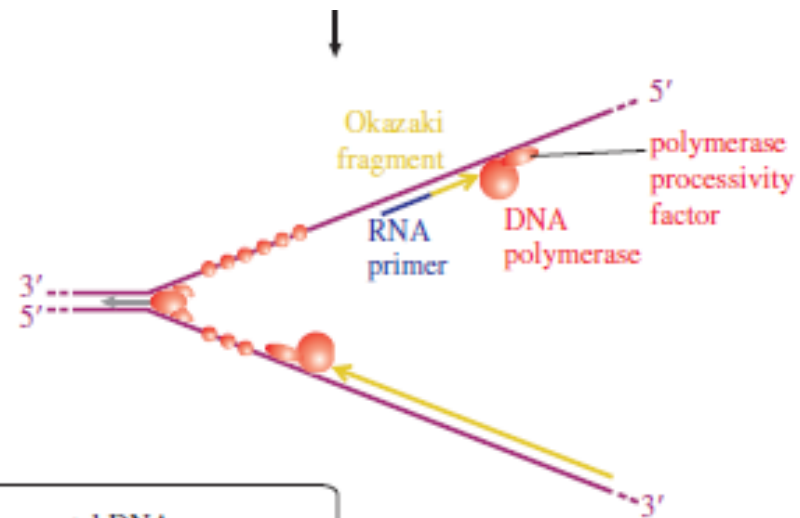
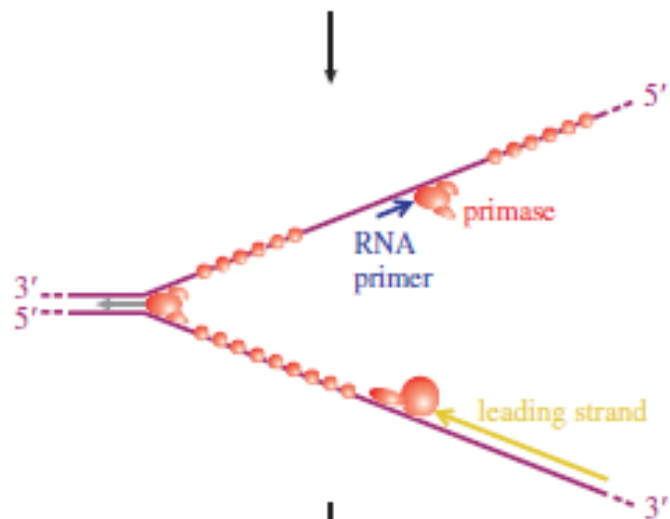
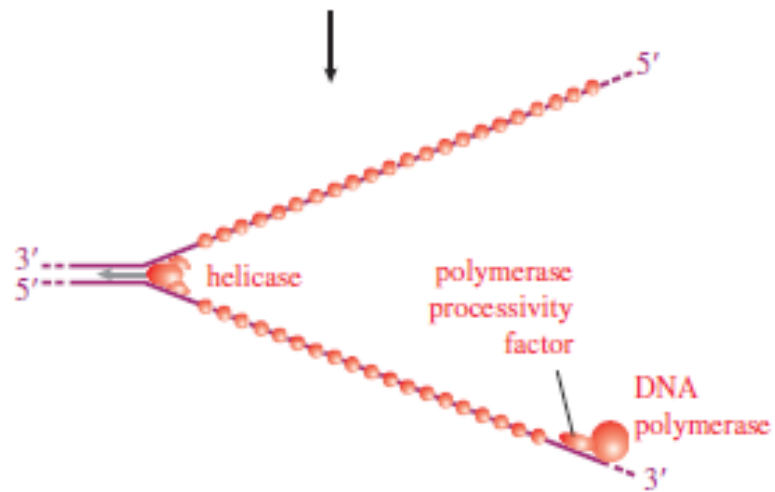
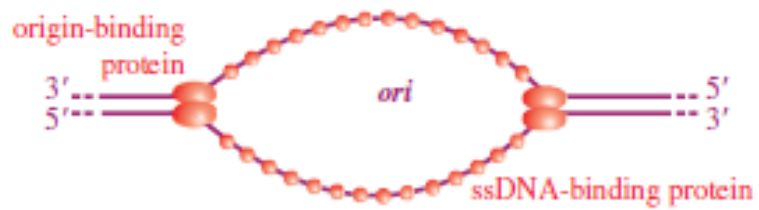

Key: — parental DNA
→ new DNA
 (arrow indicates synthesis in 5' to 3' direction)

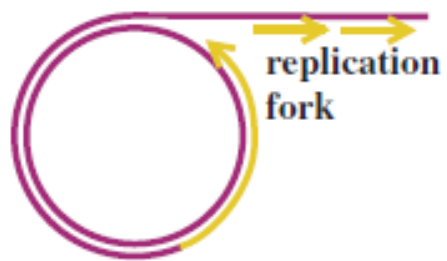

Key: — parental DNA
→ new DNA
(arrow indicates synthesis in 5' to 3' direction)

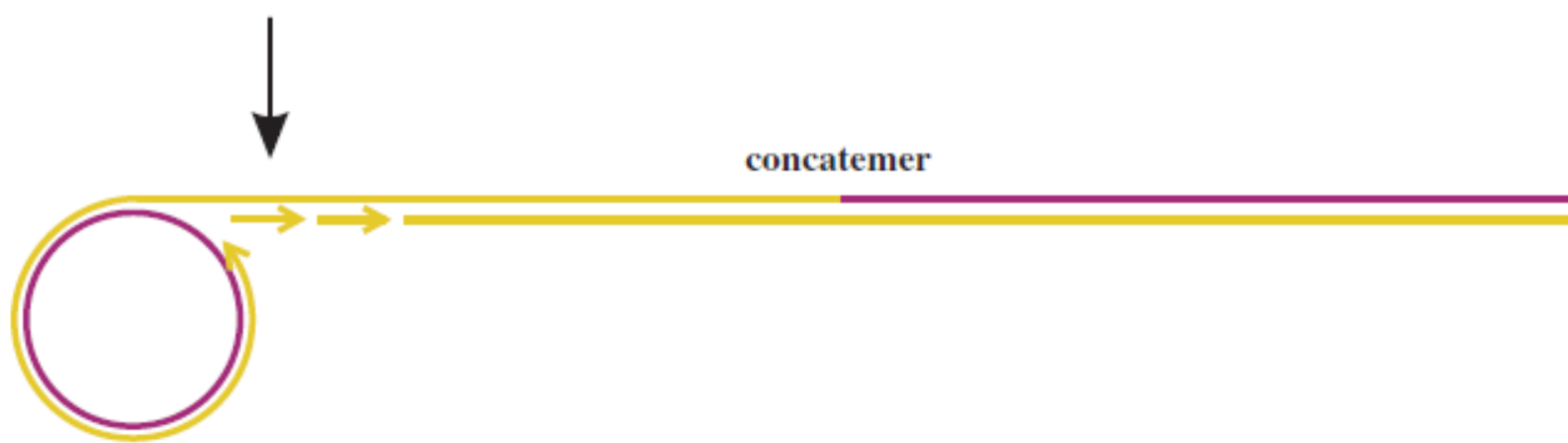
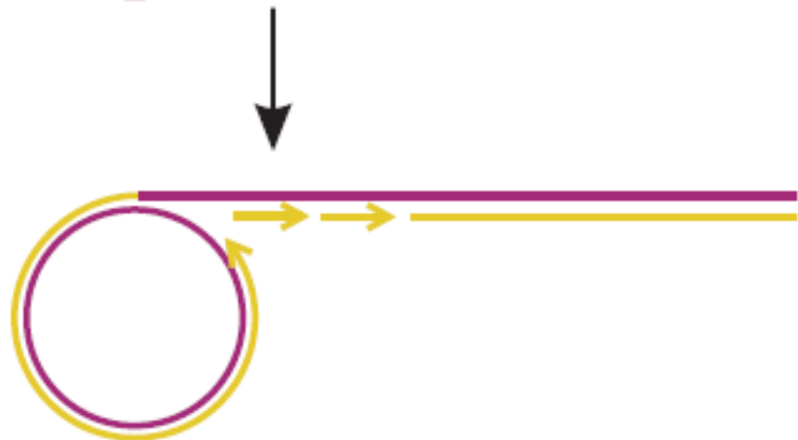

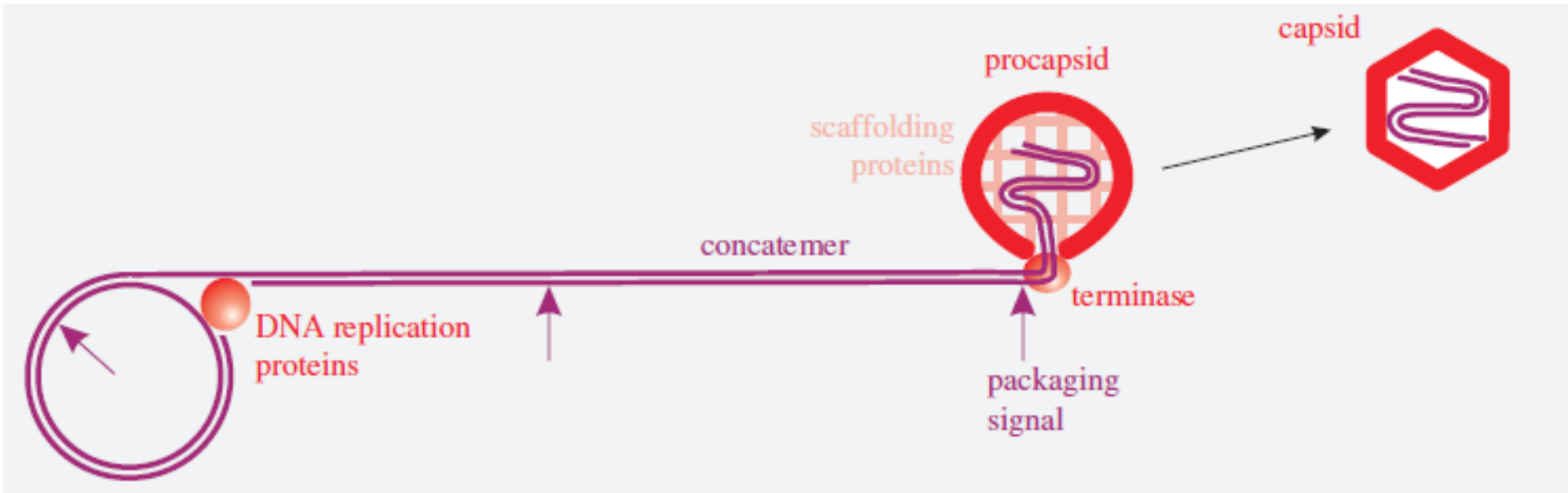

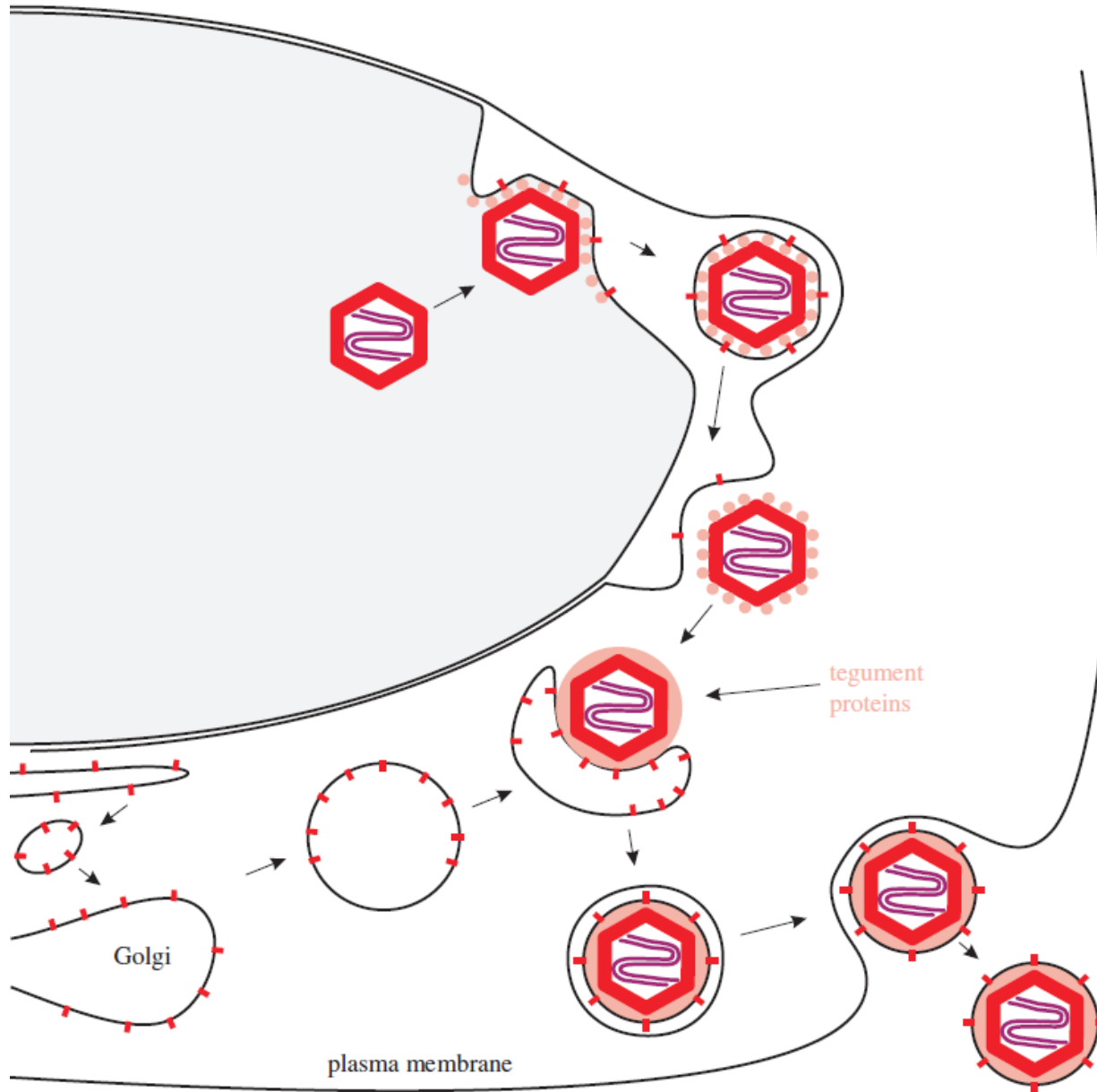

(b) Nucleocapsid with temporary envelope in the perinuclear space

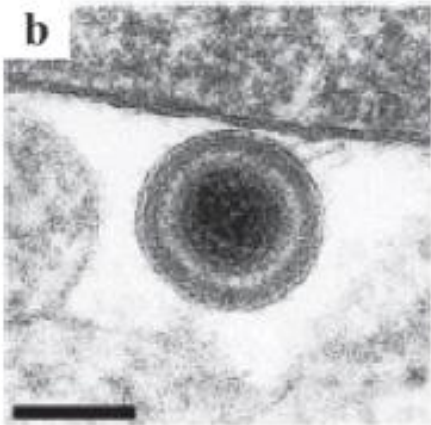

(c) Nucleocapsid budding into a vesicle in the cytoplasm

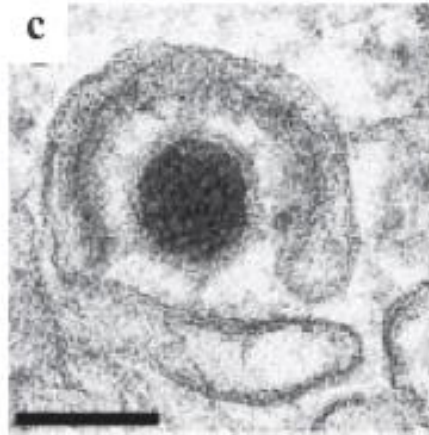

(d) Enveloped virion within a vesicle during transport to the plasma membrane

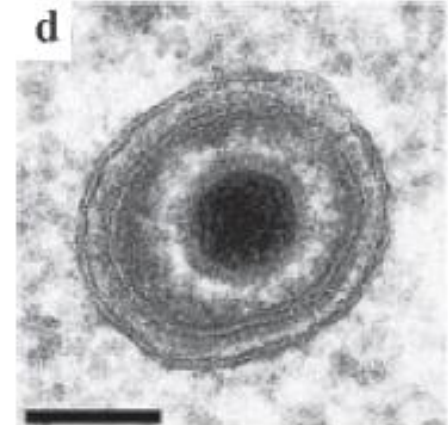

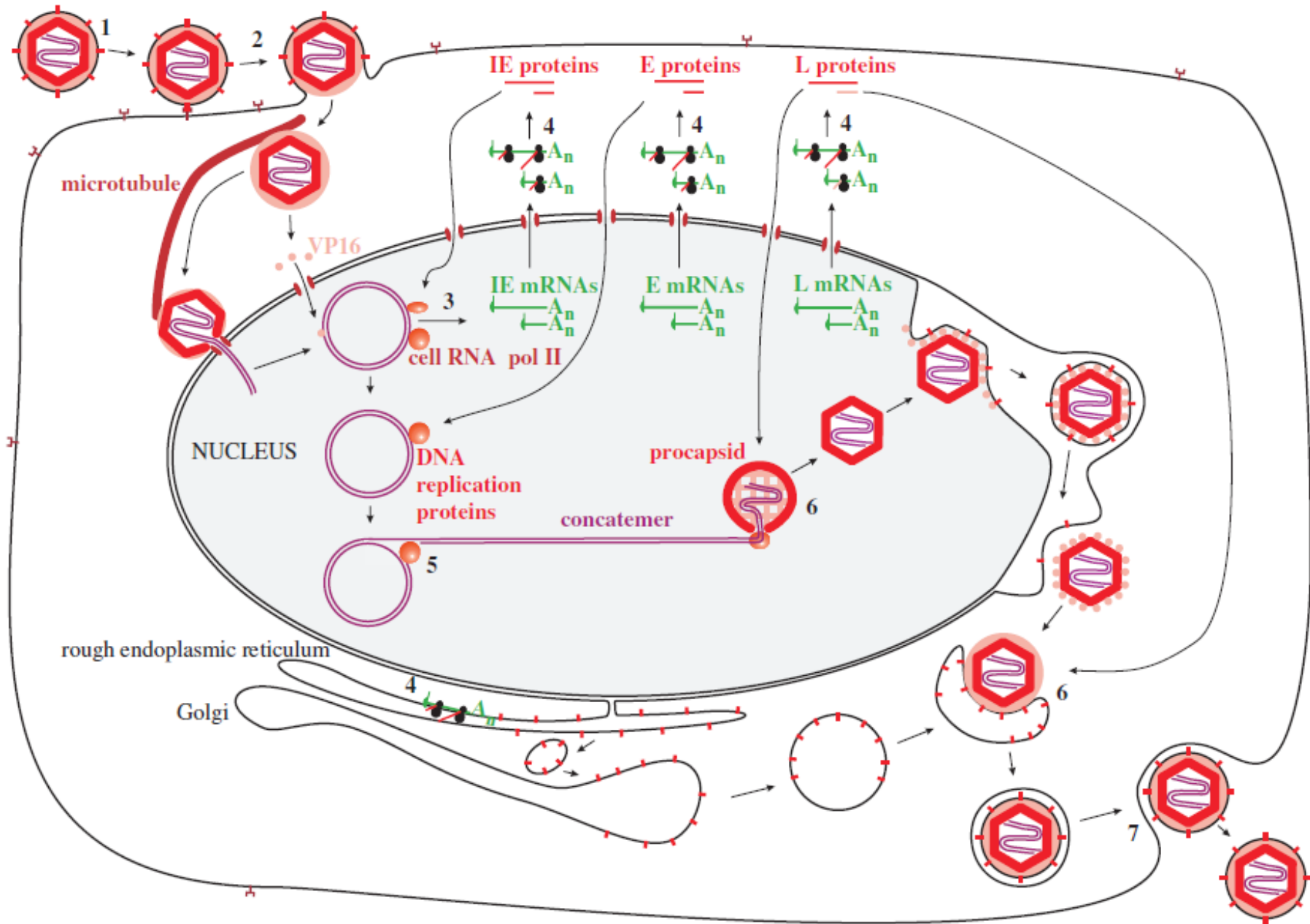

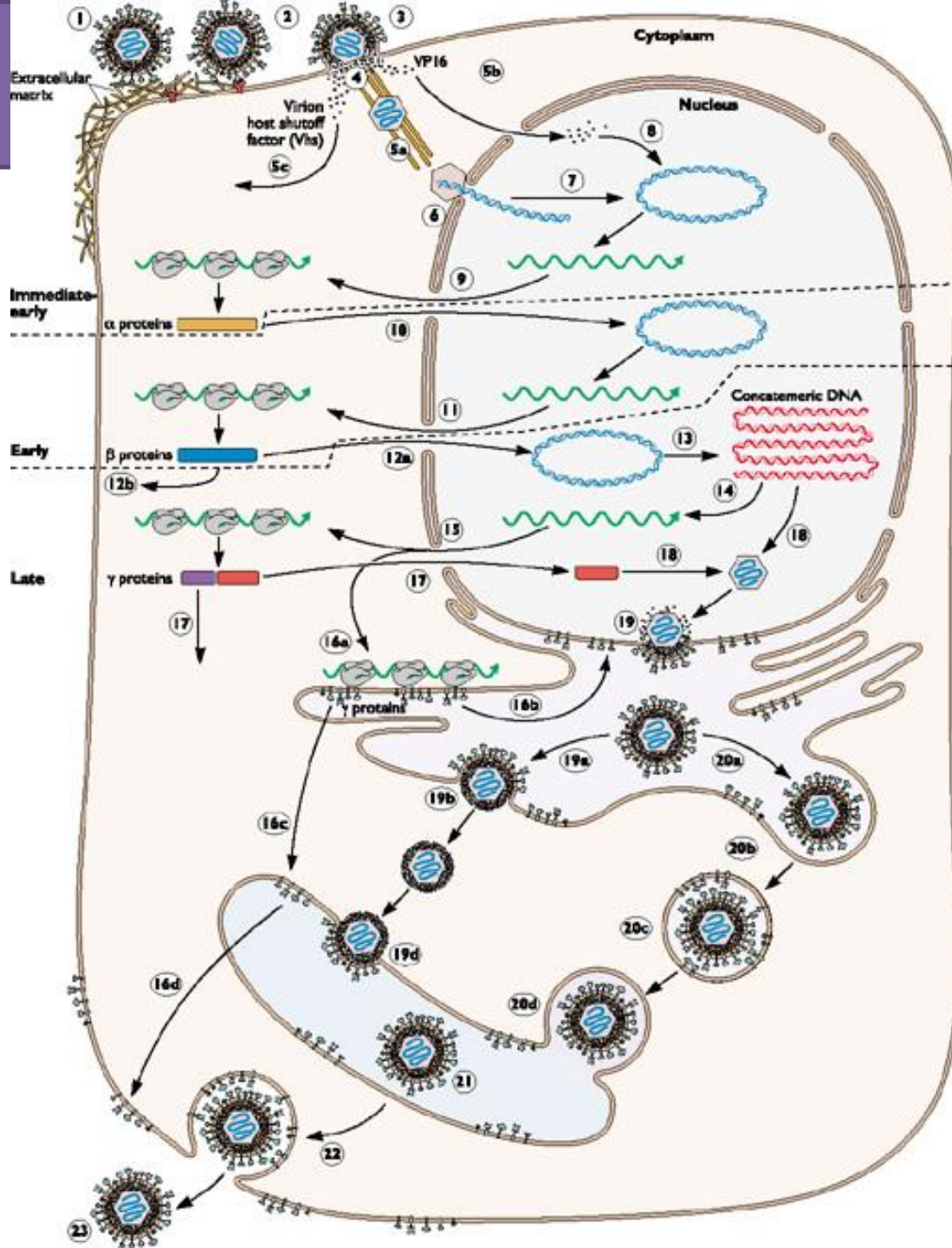

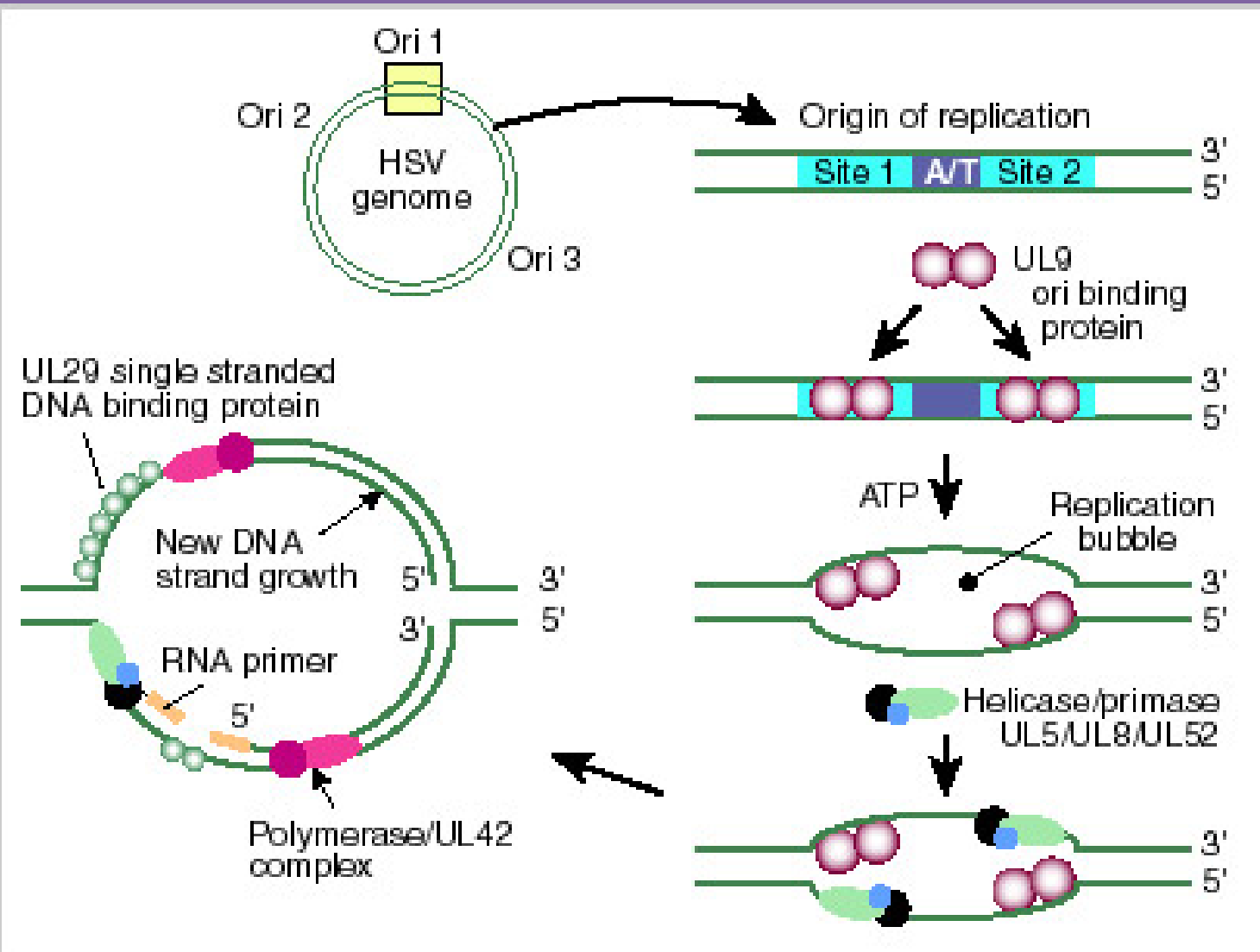

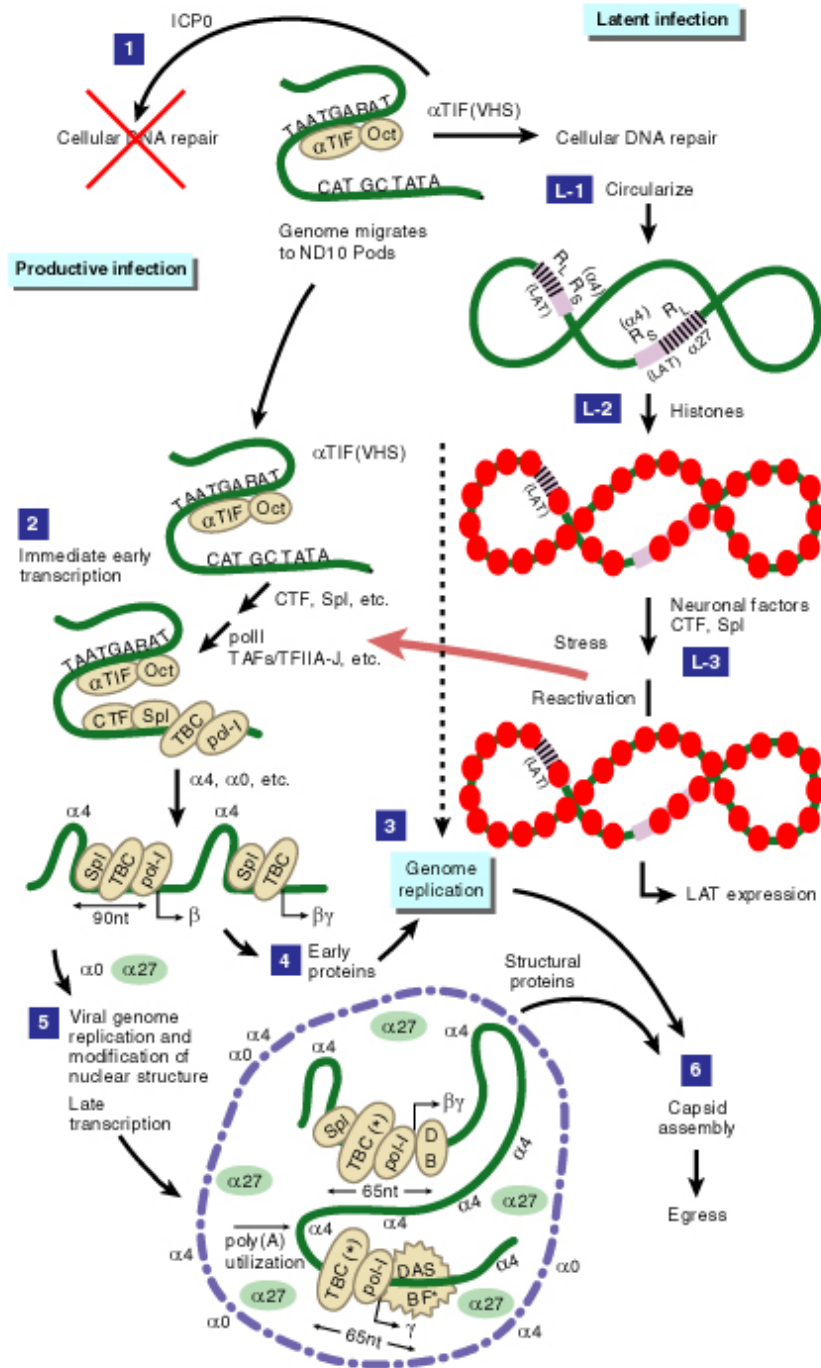

Parvoviruses

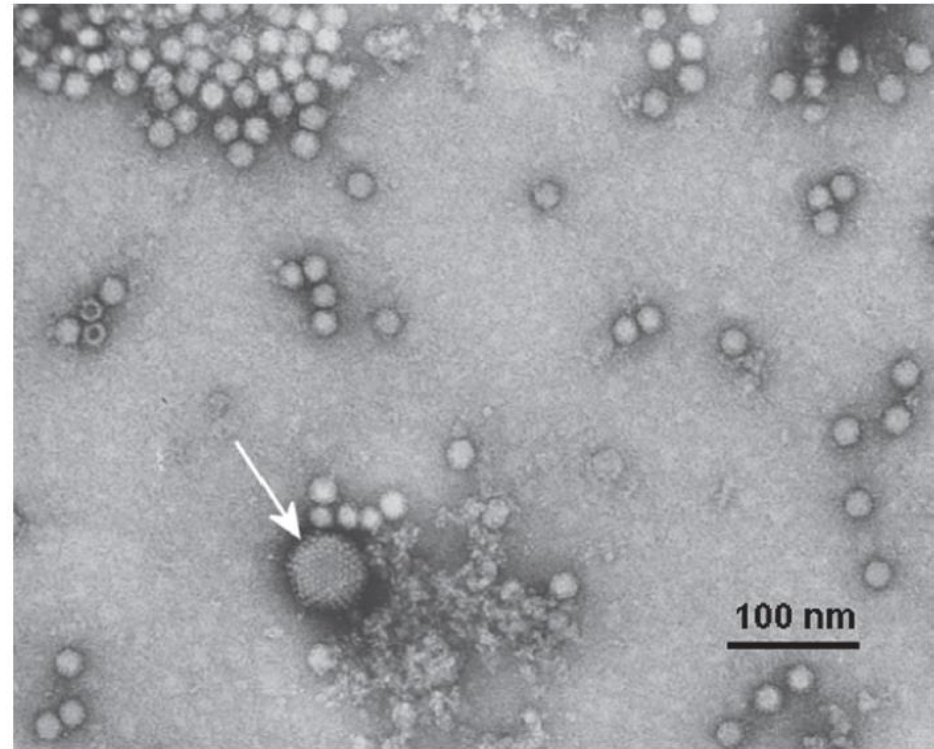
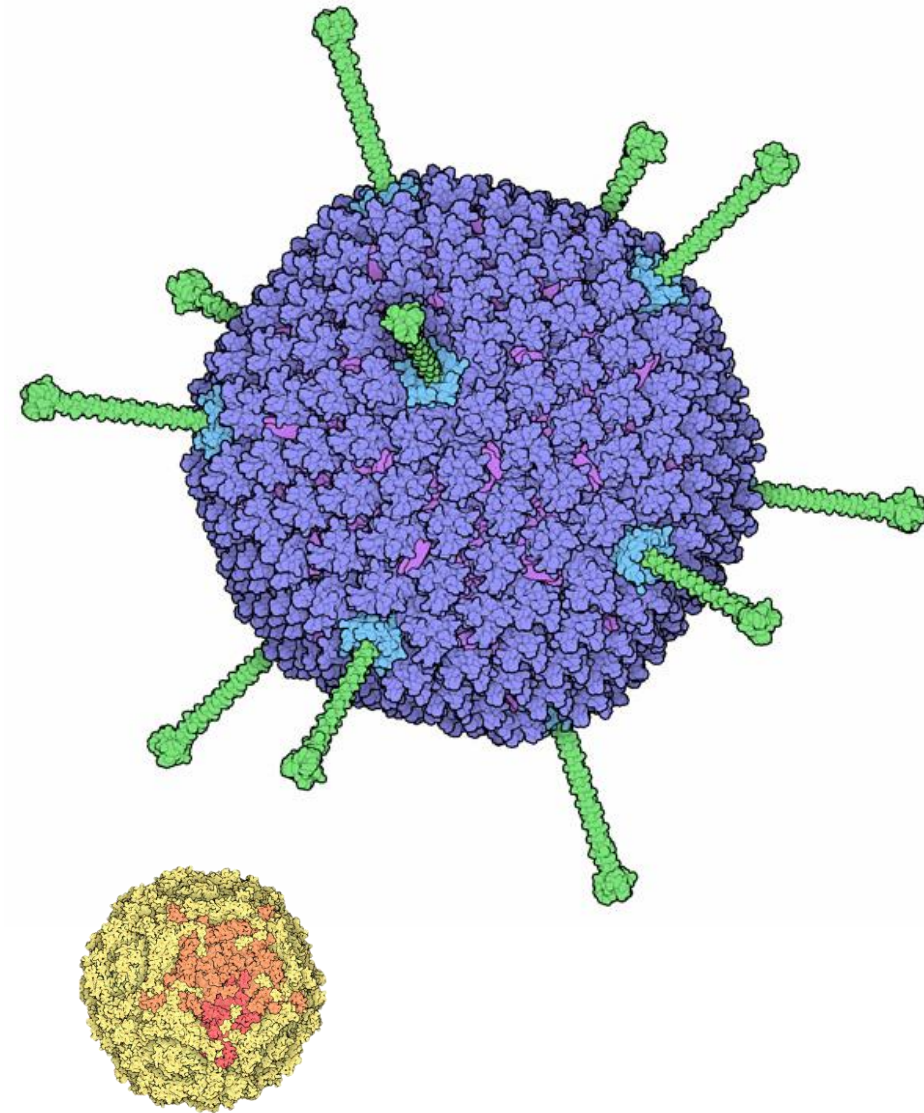
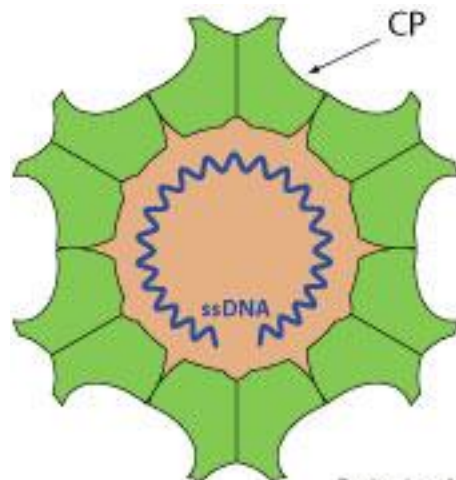
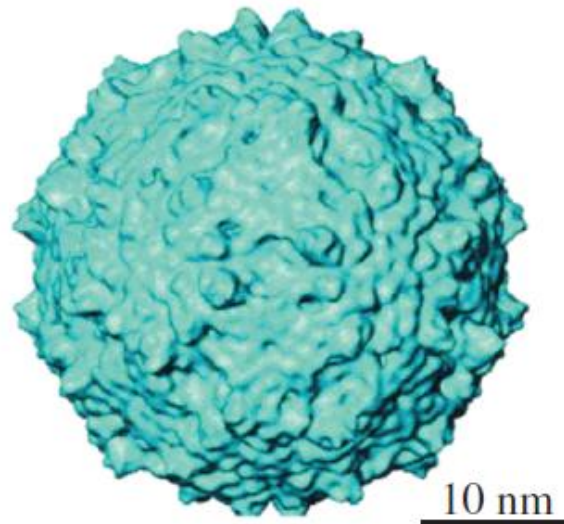
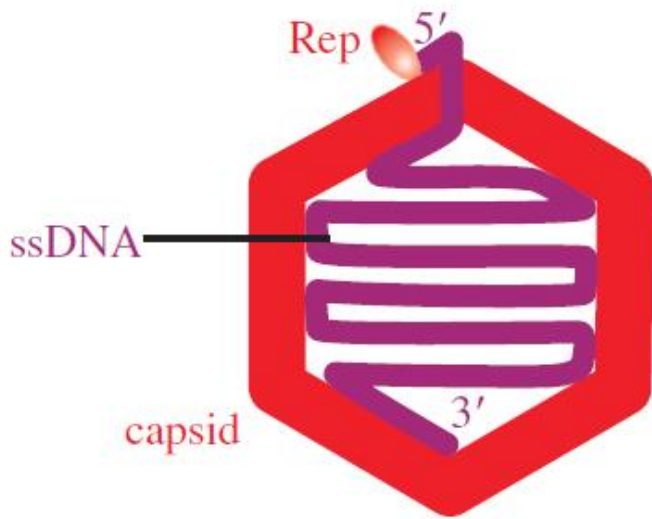

Figure 12.1 Virions of adenovirus (arrowed) and dependovirus.

Source: Reproduced with permission of Professor M. Stewart McNulty and The Agri-Food and Biosciences Institute.



Figure 12.2 Child with fifth disease.



© 2010

Swiss Institute of Bioinformatics

www.wiley.com/college/carter

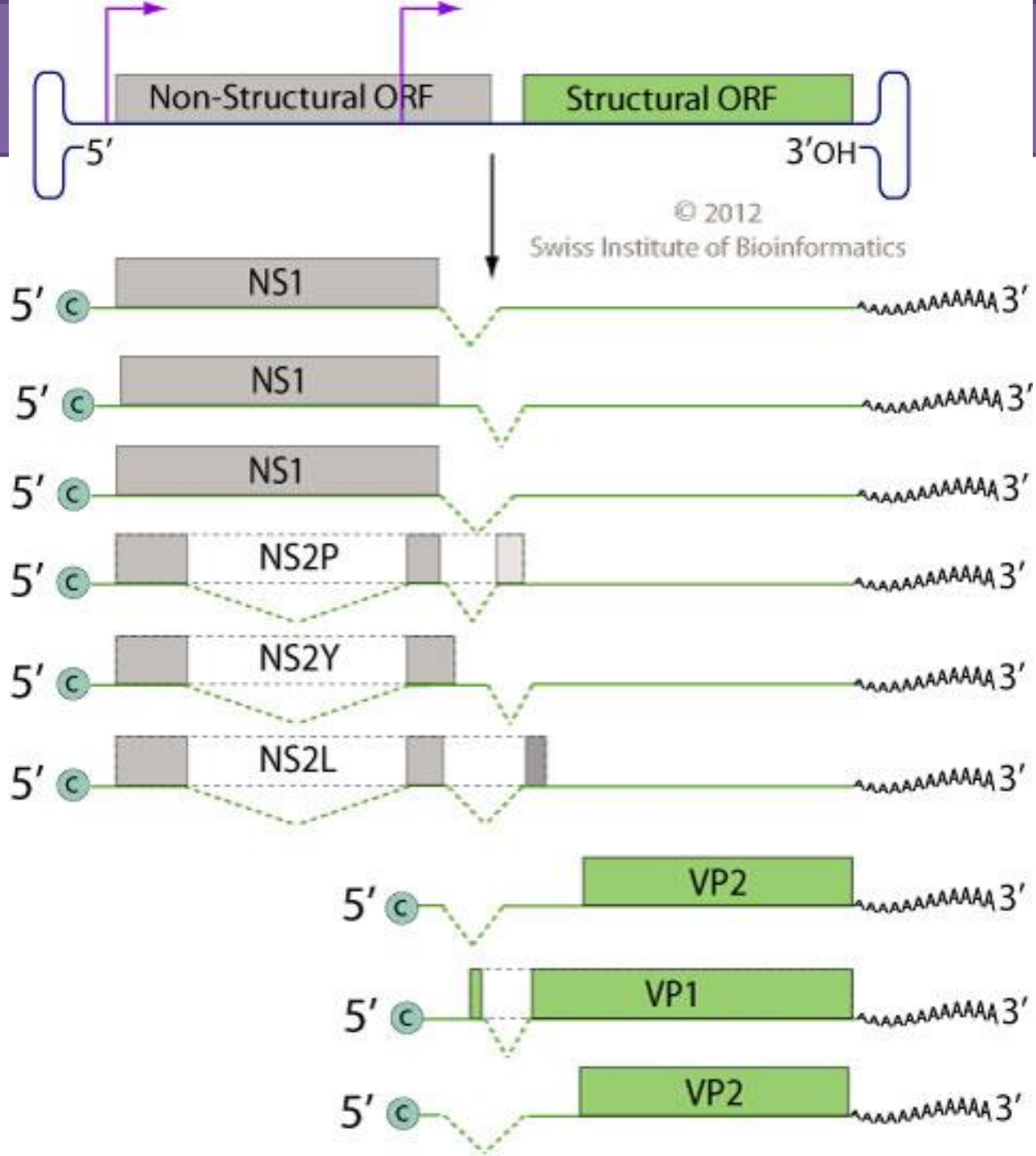

(a) "Inverted repeats" at the termini



(b) Unique sequences at the termini



Figure 12.4 Base pairing at the termini of parvovirus DNA.

Rolling hairpin Replication (AAV)

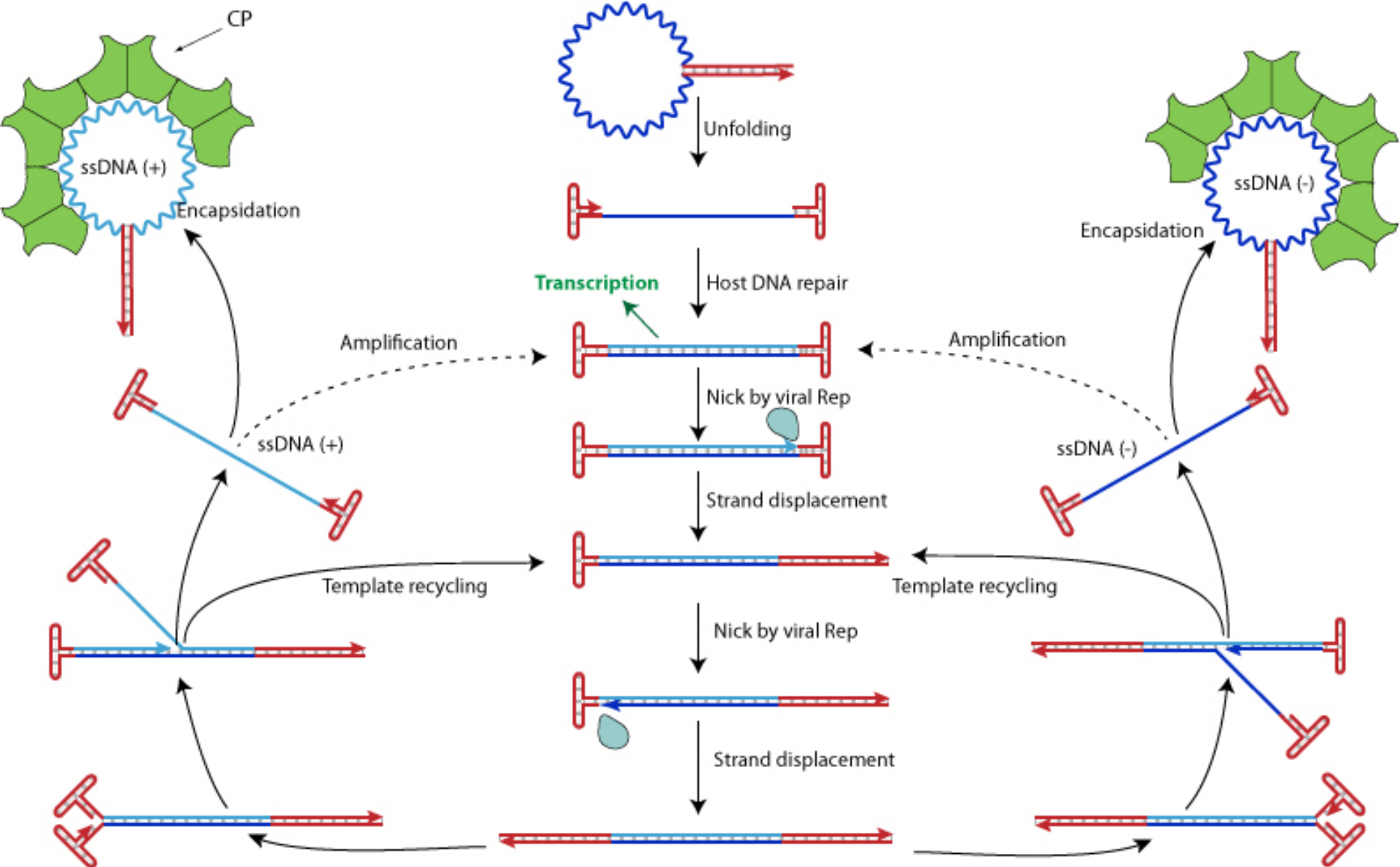

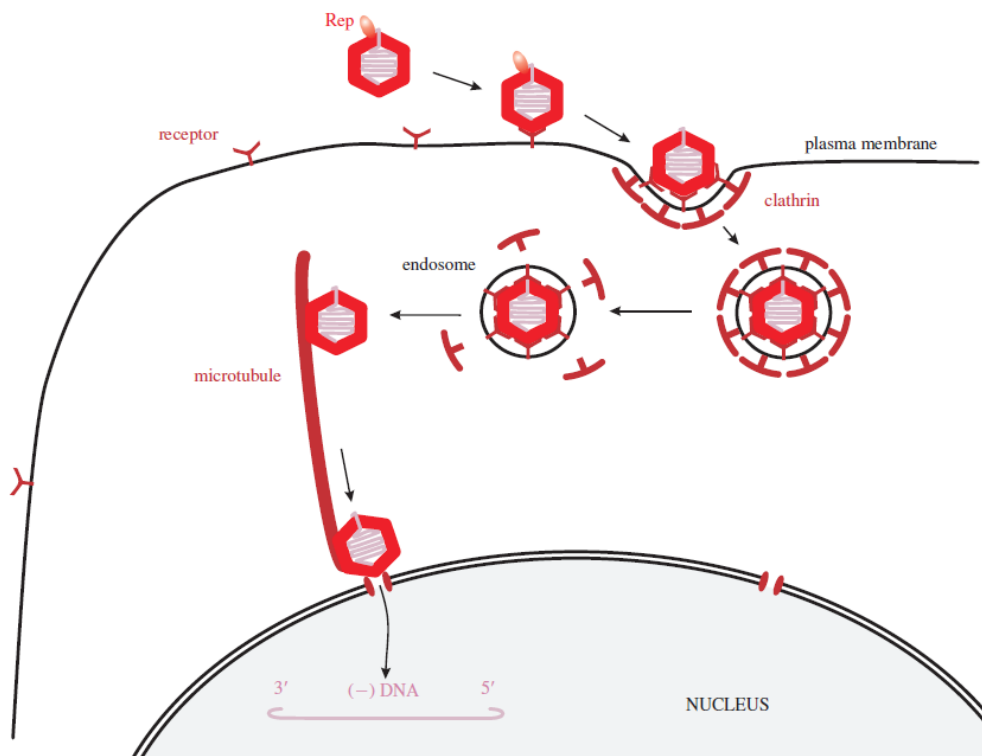

Figure 12.6 Parvovirus attachment and entry. A virion is taken into the cell by clathrin-mediated endocytosis. After release from the endosome it is transported on a microtubule to a site close to the nucleus. It is uncertain whether uncoating of the virus genome occurs at a nuclear pore (as shown here) or within the nucleus.

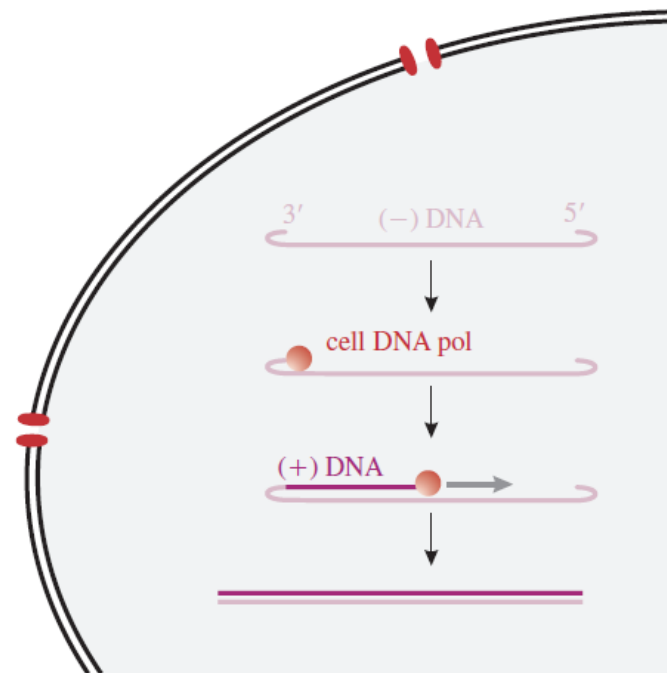
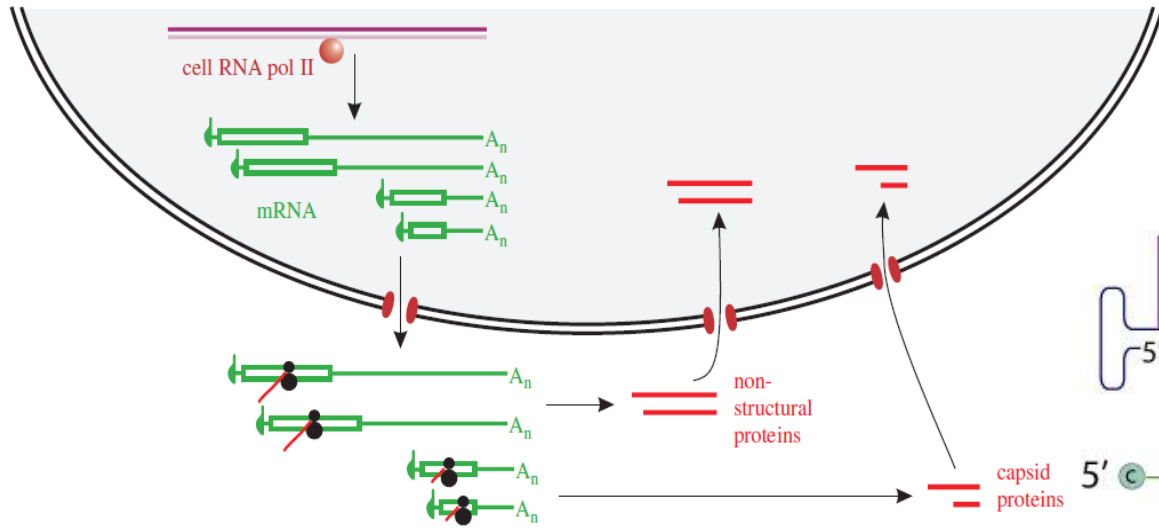
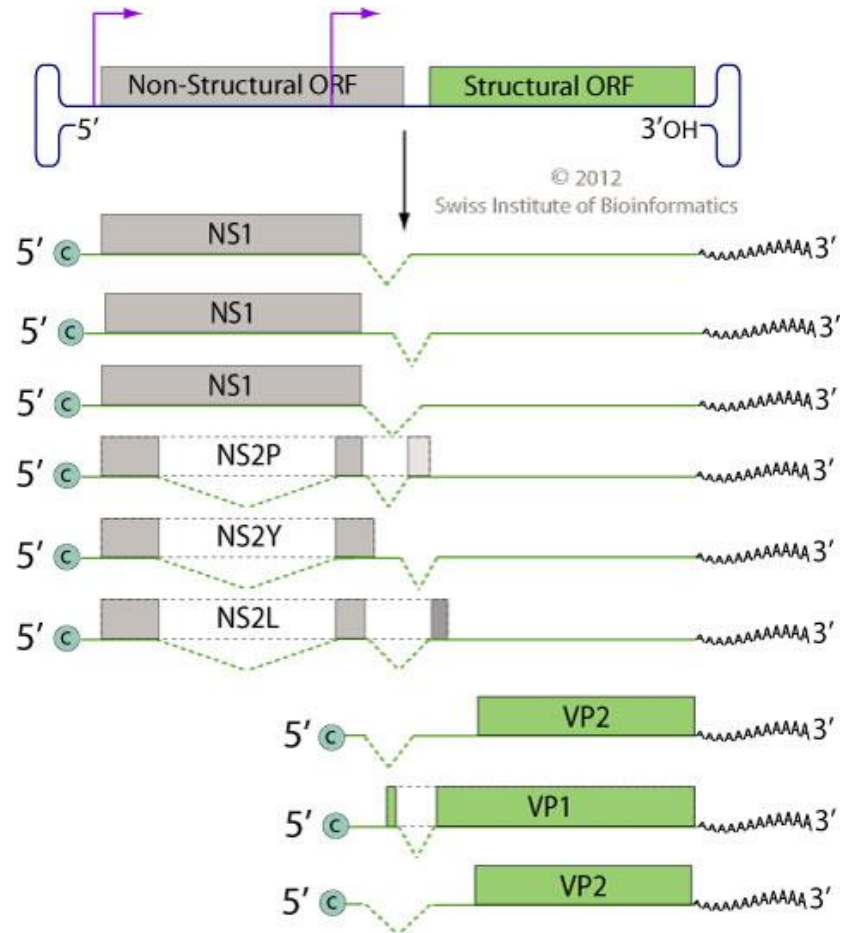

Figure 12.7 Conversion of ssDNA to dsDNA by a cell DNA polymerase. Not all steps are shown.



Minute virus of mice genome organization



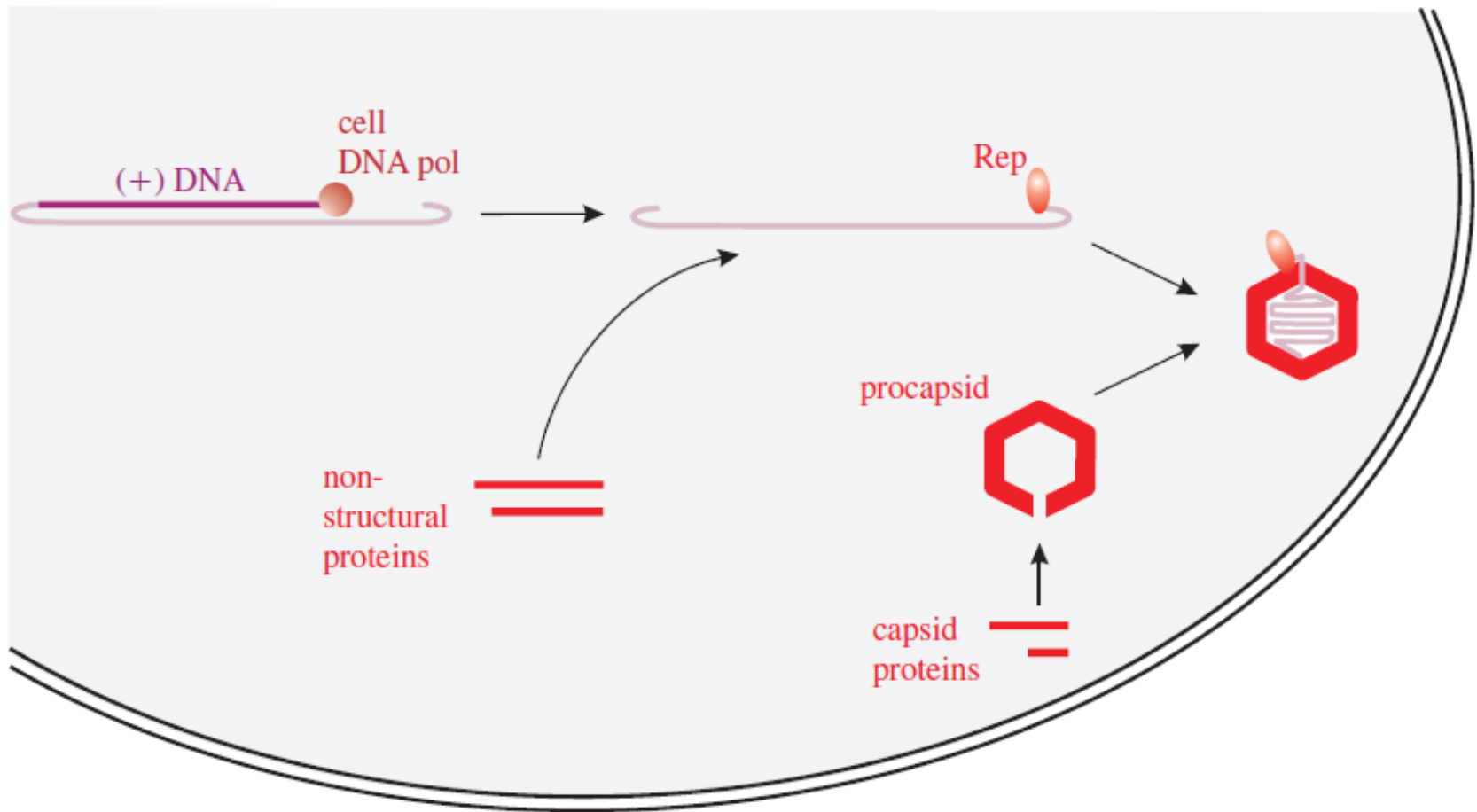
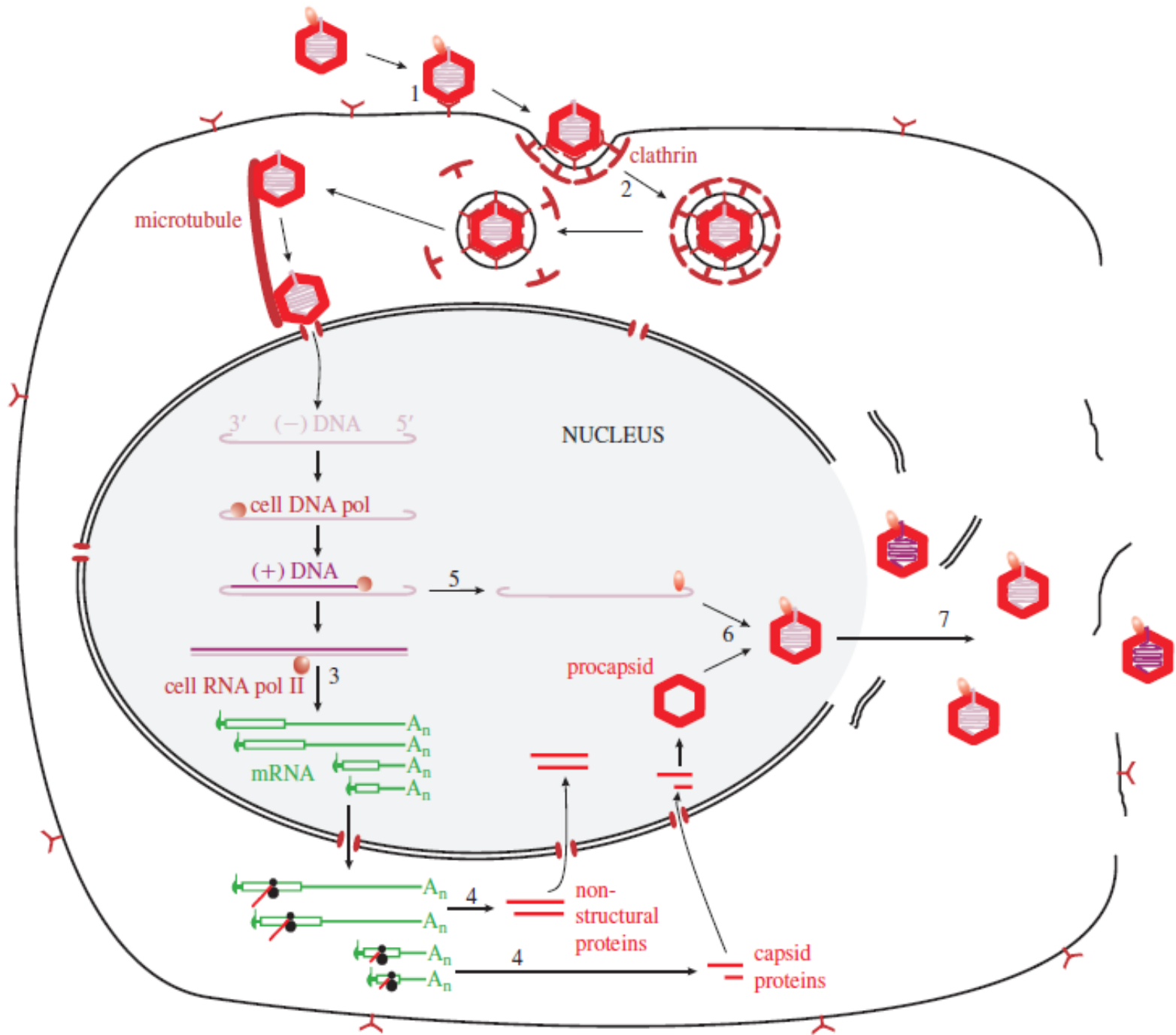
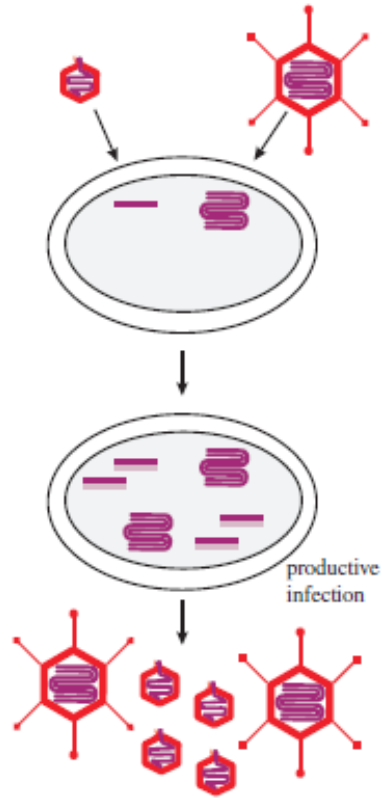

Figure 12.9 Parvovirus virion assembly.



(a) Co-infection of a cell with a dependovirus and an adenovirus



(b) Infection of a cell with a dependovirus

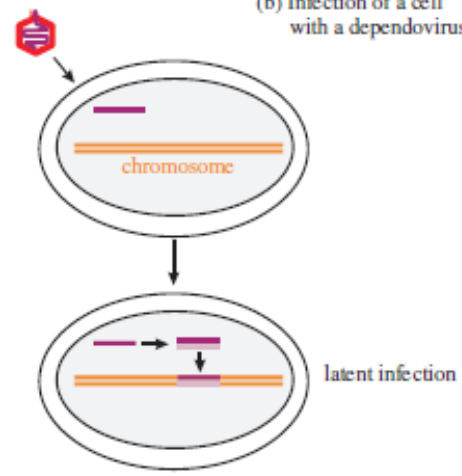

(c) Adenovirus infection of a cell latently infected with a dependovirus

