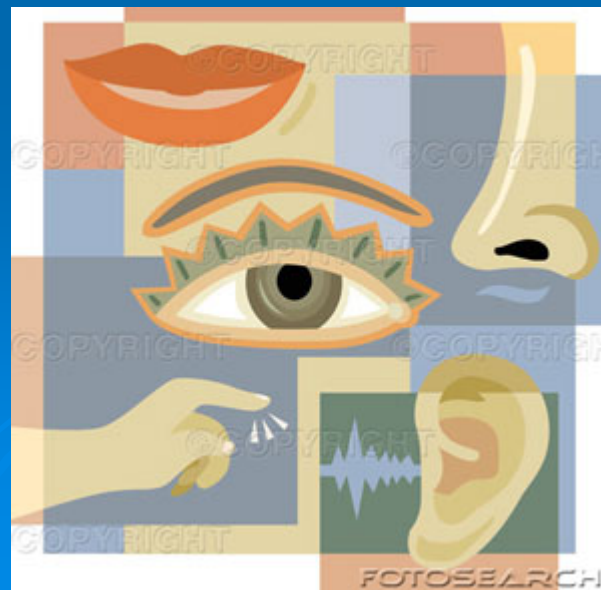


**Neurální a buněčné procesy  
smyslové transdukce – jak  
smyslové podněty vstupují do  
nervového systému.**

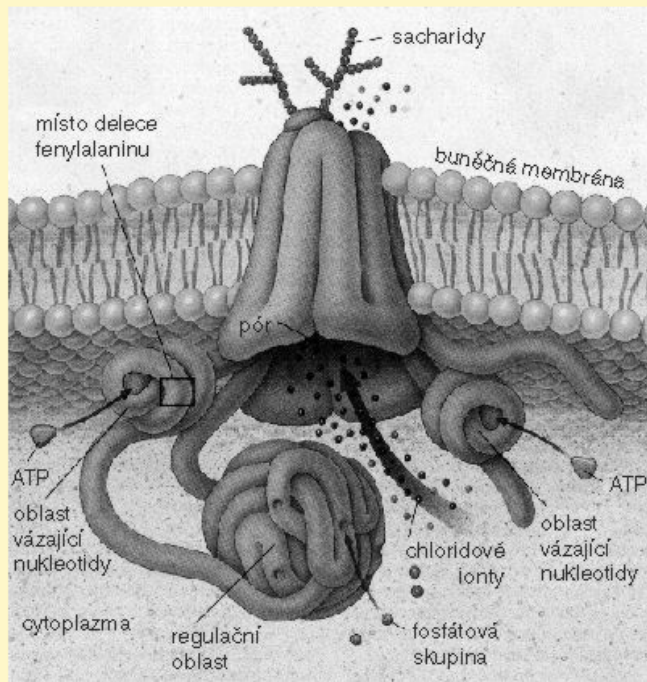


# Všech 5 pohromadě

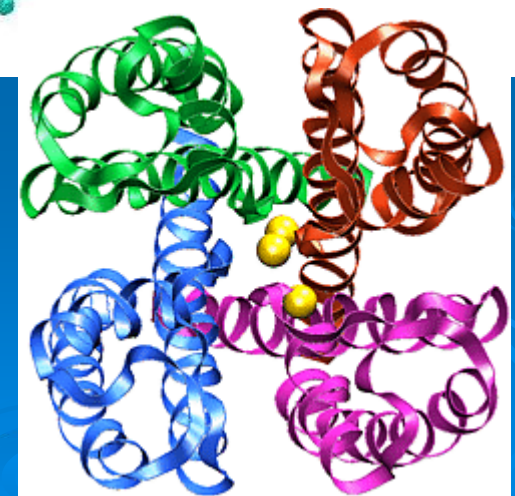
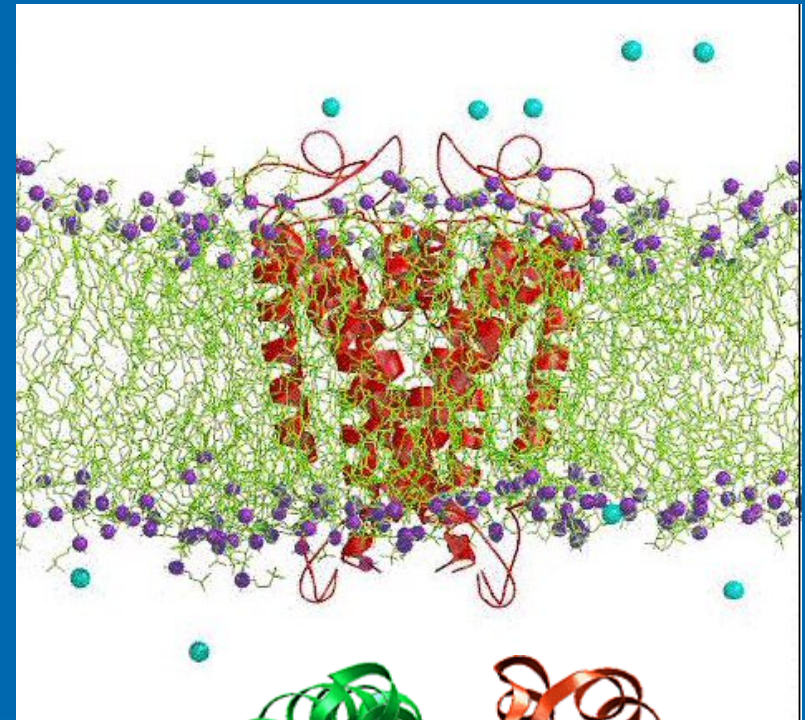




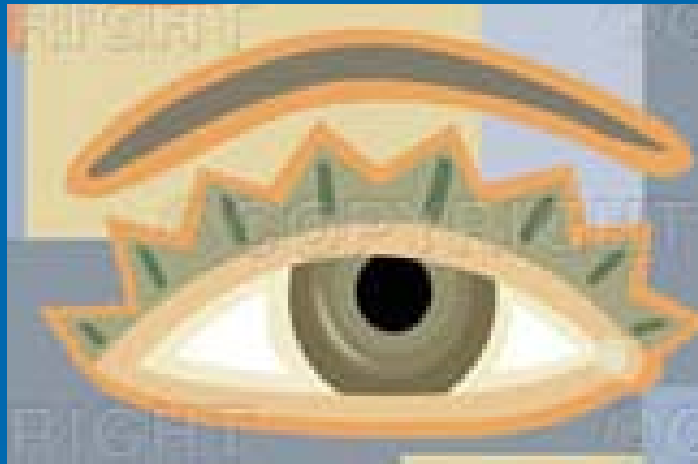
# Kanály – prostředek udržování integrity buňky a komunikace



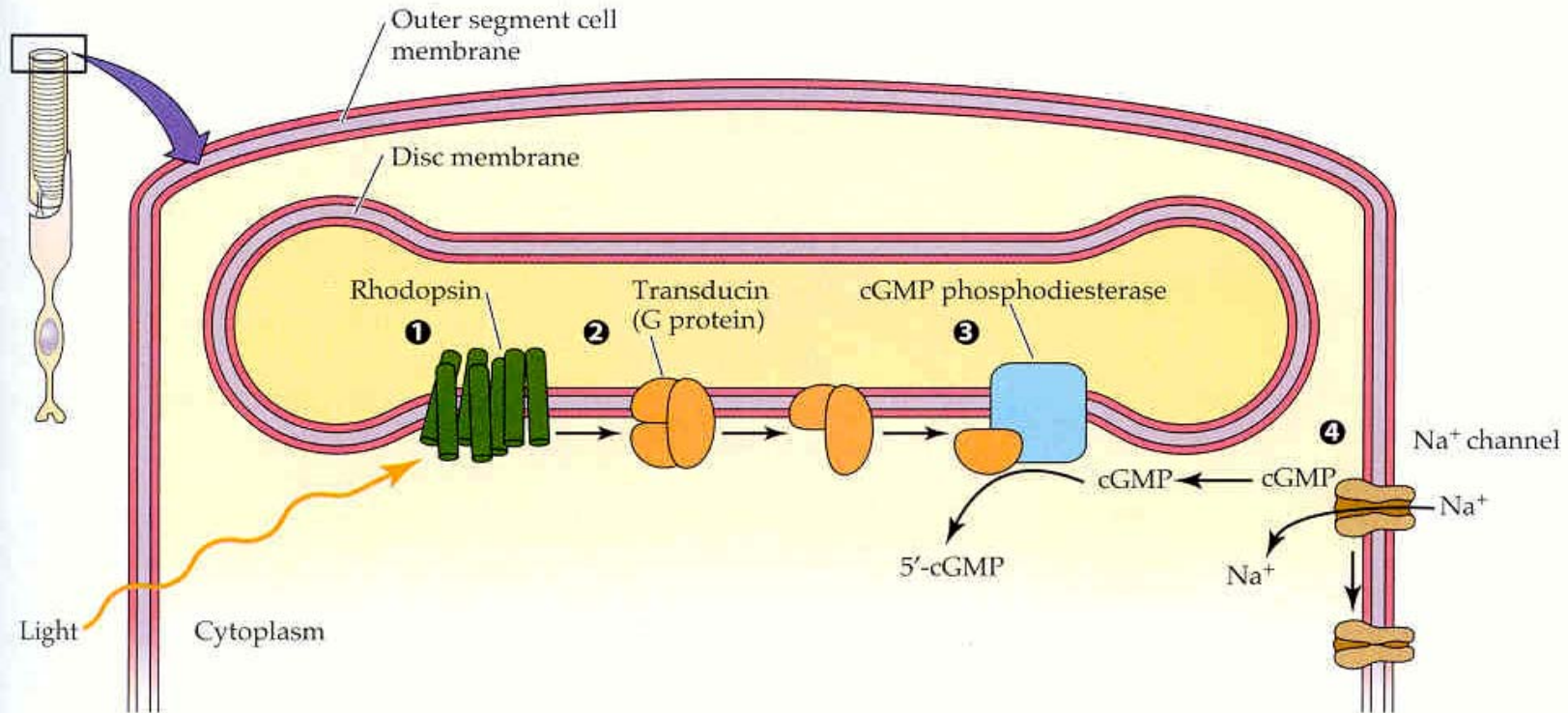
Po ukotvení v membráně se protein CFTR složitě přizpůsobuje – vytváří kanálky, kterými mohou přes membránu proudit chloridové ionty. V cytoplazmatické části proteinu jsou tři regulační oblasti, které se podílejí na uzavírání a otevírání póru. Kanálek se otevře jedině tehdy, když se na CFTR navážou dvě molekuly ATP a zároveň je fosforylována třetí regulační oblast. U mutovaného proteinu je jedna z oblastí vázajících ATP intaktní a membránový kanálek se neotevírá.



# Fotorecepce - Zrak



# Rhodopsin

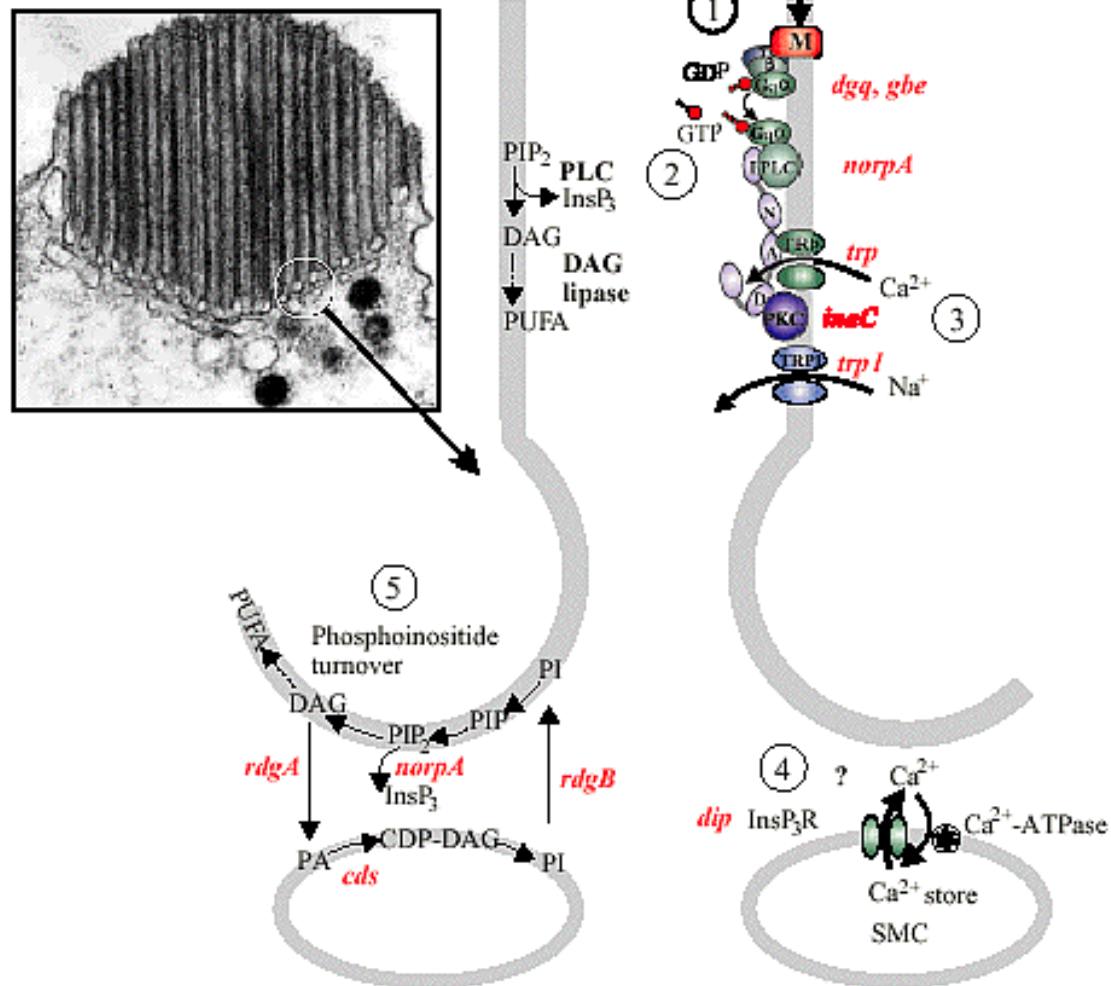


**Figure 13.14 Phototransduction closes cation channels in the outer segment of the photoreceptor membrane** In the dark, the cation channels are kept open by intracellular cGMP and conduct an inward current, carried largely by Na<sup>+</sup>. When light strikes the photoreceptor, these channels are closed by a G protein-coupled mechanism. **1** Rhodopsin molecules in the disc membrane absorb light and are acti-

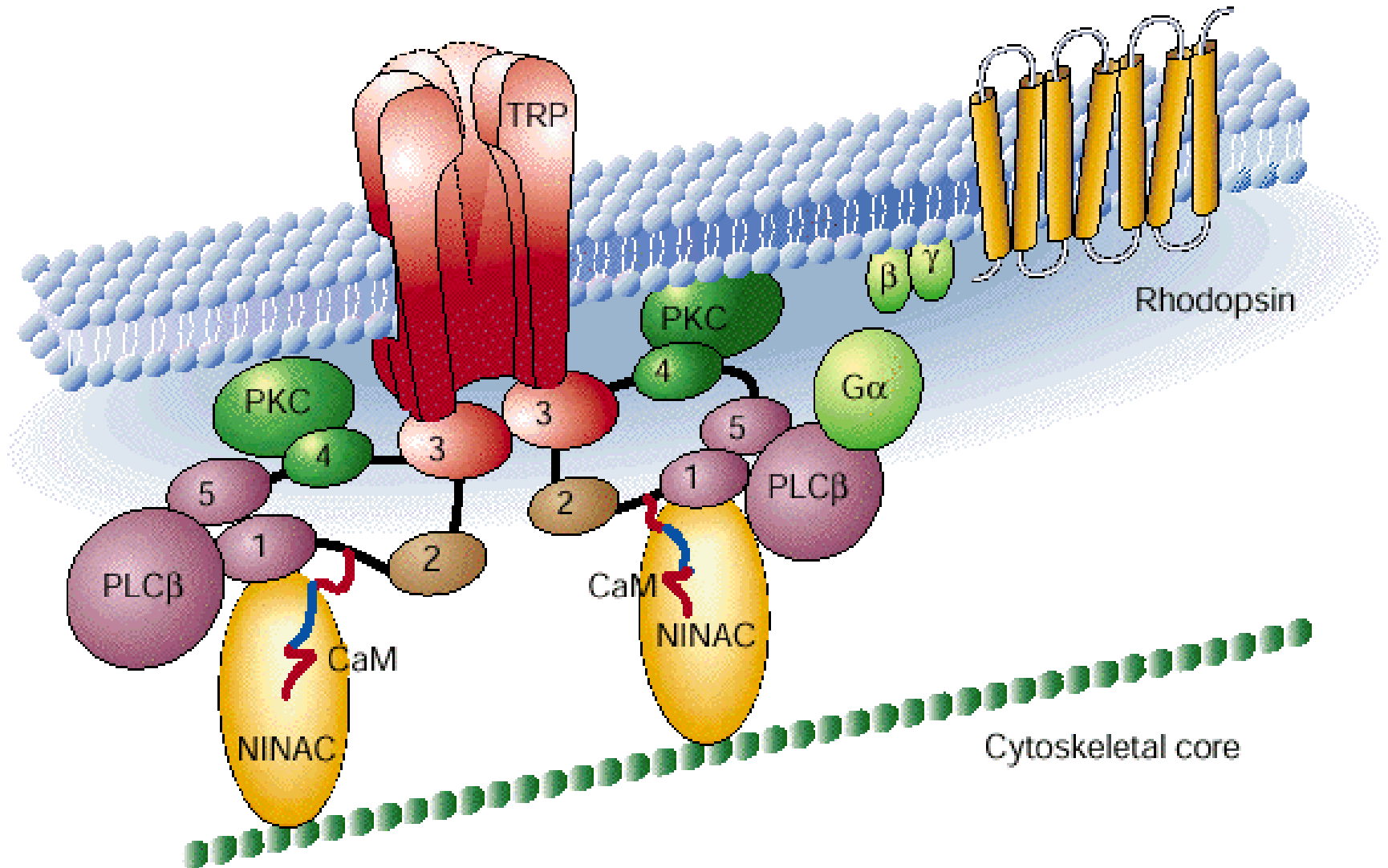
vated. **2** The activated rhodopsin stimulates a G protein (transducin in rods), which in turn activates cGMP phosphodiesterase. **3** The phosphodiesterase catalyzes the breakdown of cGMP to 5'-GMP. **4** As the cGMP concentration decreases, cGMP detaches from the cation channels, which close.



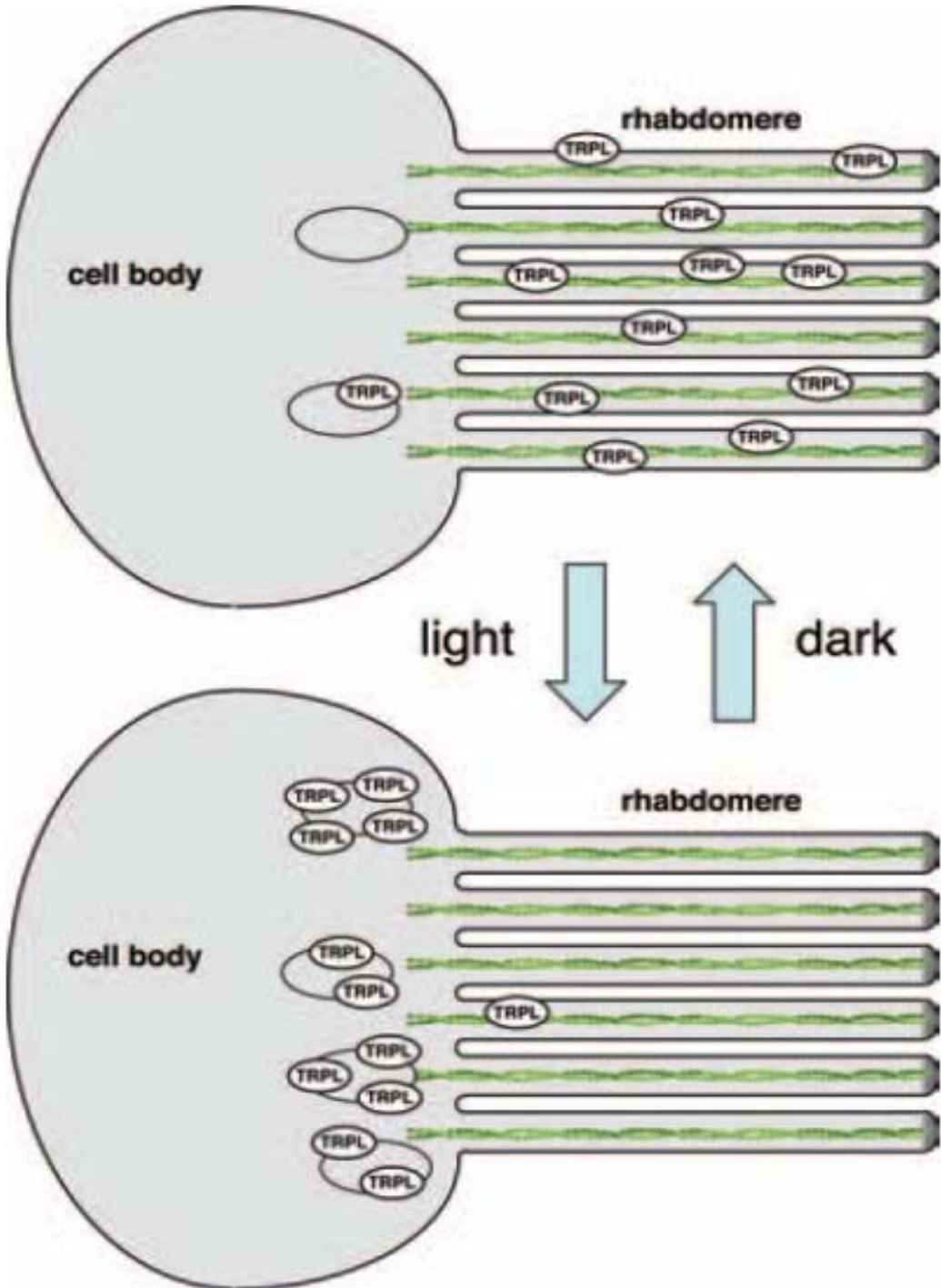
Fig. 1. *Drosophila melanogaster* phototransduction cascade. Inset: cross-section of a *Drosophila melanogaster* rhabdomere (electron micrograph courtesy of Dr A Polyanovsky), which is composed of some 30000 microvilli, each approximately 1–2  $\mu\text{m}$  in length and 60 nm in diameter. Each microvillus contains approximately 1000 molecules of rhodopsin and most elements of the phototransduction machinery. An enlargement of the circled area in the inset, showing the base of one microvillus with associated phototransduction machinery, is shown schematically in the main figure. Activation: (1) photoisomerization of rhodopsin to metarhodopsin (Rh $\rightarrow$ M, encoded by the *ninaE* gene) activates heterotrimeric G<sub>q</sub> protein via GTP–GDP exchange, releasing the G<sub>q</sub> $\alpha$  subunit. Genes and mutants for both  $\alpha$  (*dgq*) and  $\beta$  (*gbe*) subunits have been identified. (2) G<sub>q</sub> $\alpha$  activates phospholipase C (PLC; *norpA* gene), generating inositol 1,4,5-trisphosphate (InsP<sub>3</sub>) and diacyl glycerol (DAG) from phosphatidyl inositol 4,5-bisphosphate (PIP<sub>2</sub>). DAG is also a potential precursor for polyunsaturated fatty acids (PUFAs) via DAG lipase (gene yet to be identified in any eukaryote). (3) Two classes of light-sensitive channel (TRP and TRPL; *trp* and *trpl* genes) are activated by an unknown mechanism. Several components of the cascade, including the ion channel TRP, protein kinase C (PKC, *inaC* gene) and PLC are coordinated into a signalling complex by the scaffolding protein, INAD, which contains five PDZ domains. (4) At the base of the microvilli, a system of submicrovillar cisternae (SMC) has traditionally been presumed to represent Ca<sup>2+</sup> stores endowed with InsP<sub>3</sub> receptors (InsP<sub>3</sub>R; *dip* gene) and smooth endoplasmic reticulum Ca<sup>2+</sup>-ATPase; however, the SMC may play a more important role in phosphoinositide turnover (5): DAG is converted to phosphatidic acid (PA) via DAG kinase (*rdgA* gene) and to CDP-DAG via CD synthase (*cds* gene) in the SMC. After conversion to phosphatidyl inositol (PI) by PI synthase, PI is transported back to the microvillar membrane by a PI transfer protein (*rdgB* gene). PI is converted to PIP<sub>2</sub> via sequential phosphorylation (PI kinase and PIP kinase).



# Signalplex



# Translokace TRP

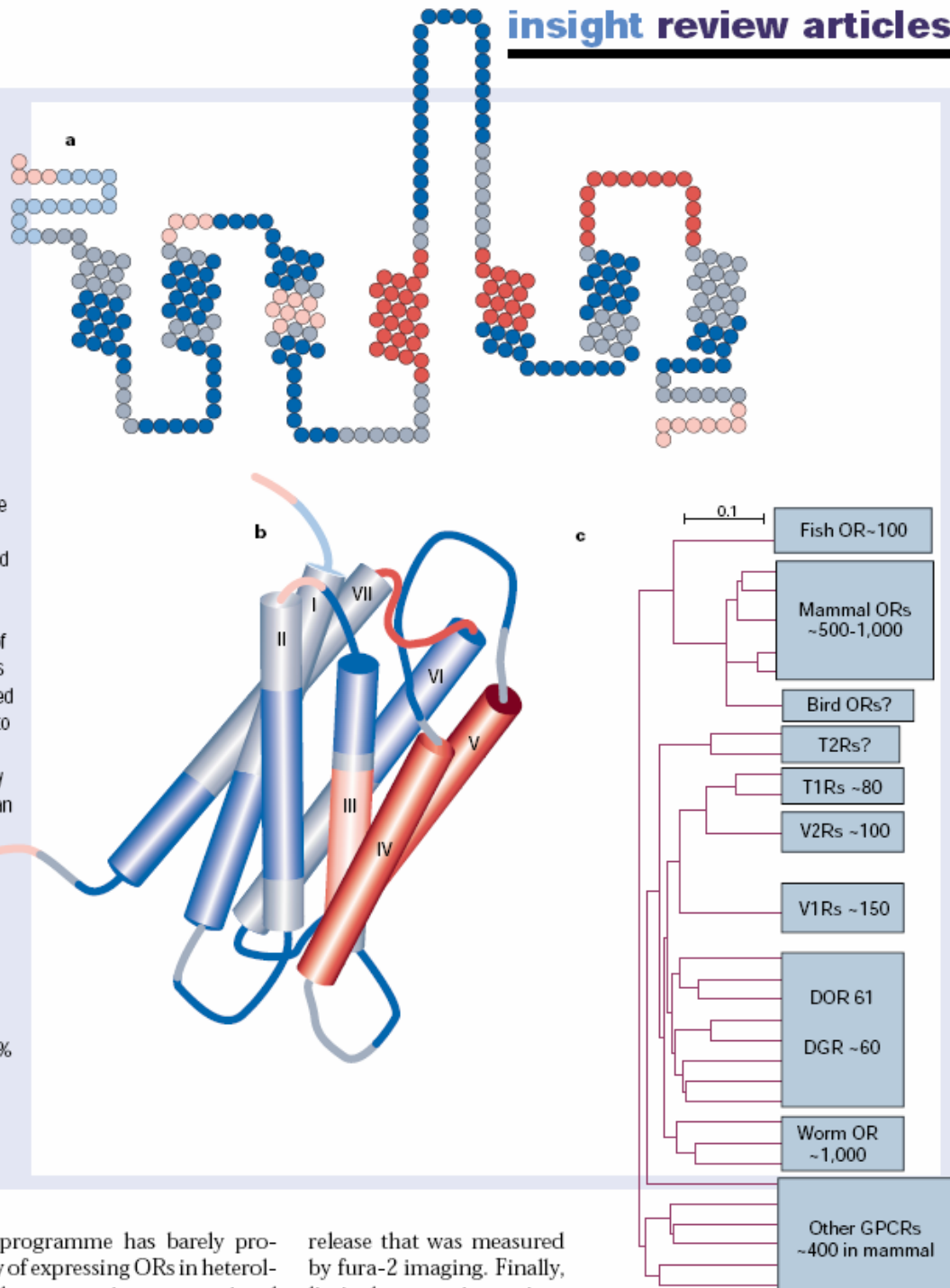




# Čich

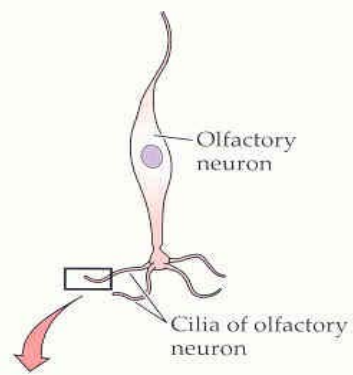


**Figure 2** Odorant receptors are the jewel of olfactory research in the past 10 years. The odorant receptors comprise the largest family of GPCRs. In mammals, odour receptors are represented by as many as 1,000 genes and may account for as much as 2% of the genome. Sequence comparison across the receptors has revealed many regions of conservation and variability that may be related to function. **a**, In a 'snake' diagram showing the amino acids for a particular receptor (M71), those residues that are most highly conserved are shown in shades of blue and those that are most variable are shown in shades of red. The seven  $\alpha$ -helical regions (boxed) are connected by intracellular and extracellular loops. **b**, A schematic view of the proposed three-dimensional structure of the receptor based on the recently solved structure of rhodopsin. Each of the transmembrane regions is numbered according to that model. The conserved (blue) and variable (red) regions are sketched onto this qualitative view and suggest that a ligand-binding region may be at least partially formed by the variable regions of the receptor. **c**, Mammalian odour receptors are related phylogenetically to other chemosensory receptors. In the tree depicted here the numbers refer to the approximate number of receptors in each family. OR, Odorant receptors; T1R, T2R, taste receptors; V3R, vomeronasal receptors; DOR, DGR, *Drosophila* odour and gustatory receptors; worm refers to *C. elegans*. The scale bar is a graphical distance equal to 10% sequence divergence.



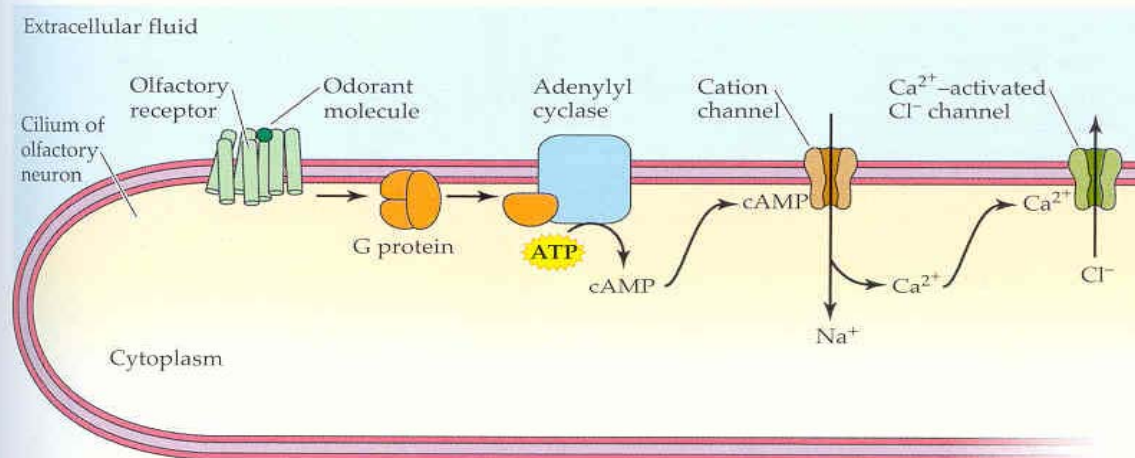
But this ambitious experimental programme has barely progressed, owing to the puzzling difficulty of expressing ORs in heterologous systems suitable for high-throughput screening or mutational

release that was measured by fura-2 imaging. Finally, limited success, in part

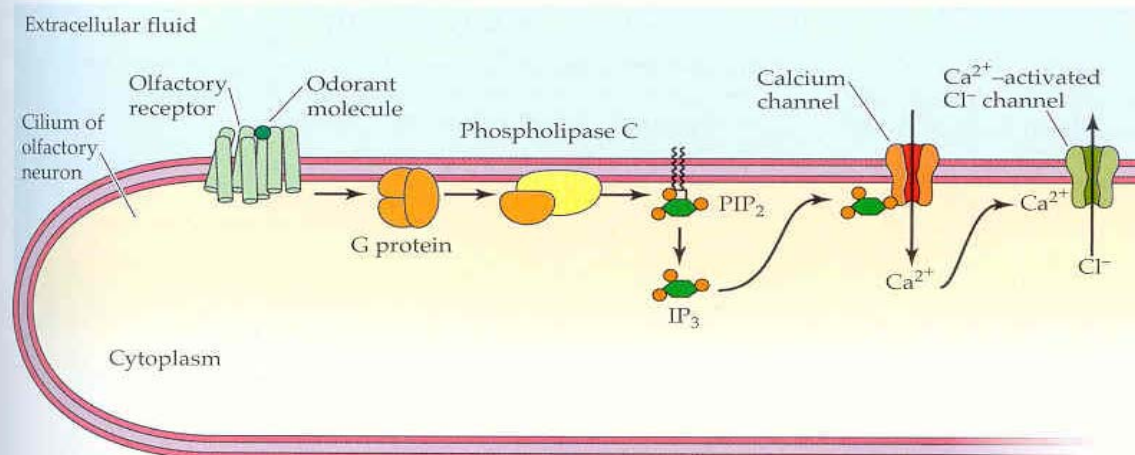


**Figure 13.36 Olfactory transduction mechanisms in cilia membranes of olfactory neurons** (a) Many odorants act to increase cyclic AMP. The odorant binds to an odorant receptor on the ciliary membrane; the receptor activates a G protein to activate adenylyl cyclase, producing cAMP. Cyclic AMP binds to and opens a cation channel, allowing entry of  $\text{Na}^+$  and  $\text{Ca}^{2+}$  ions to depolarize the cell.  $\text{Ca}^{2+}$  binds to  $\text{Ca}^{2+}$ -activated  $\text{Cl}^-$  channels, augmenting the depolarization. (b) Some olfactory responses increase  $\text{IP}_3$ . This mechanism also starts with odorant binding to a G protein-coupled receptor, but in this case the G protein activates phospholipase C, forming  $\text{IP}_3$  from  $\text{PIP}_2$  (see Figure 12.21).  $\text{IP}_3$  binds to and opens a calcium channel, letting  $\text{Ca}^{2+}$  enter to depolarize the cell. As in (a),  $\text{Ca}^{2+}$ -activated  $\text{Cl}^-$  channels augment the depolarization.

(a) Increase in cAMP

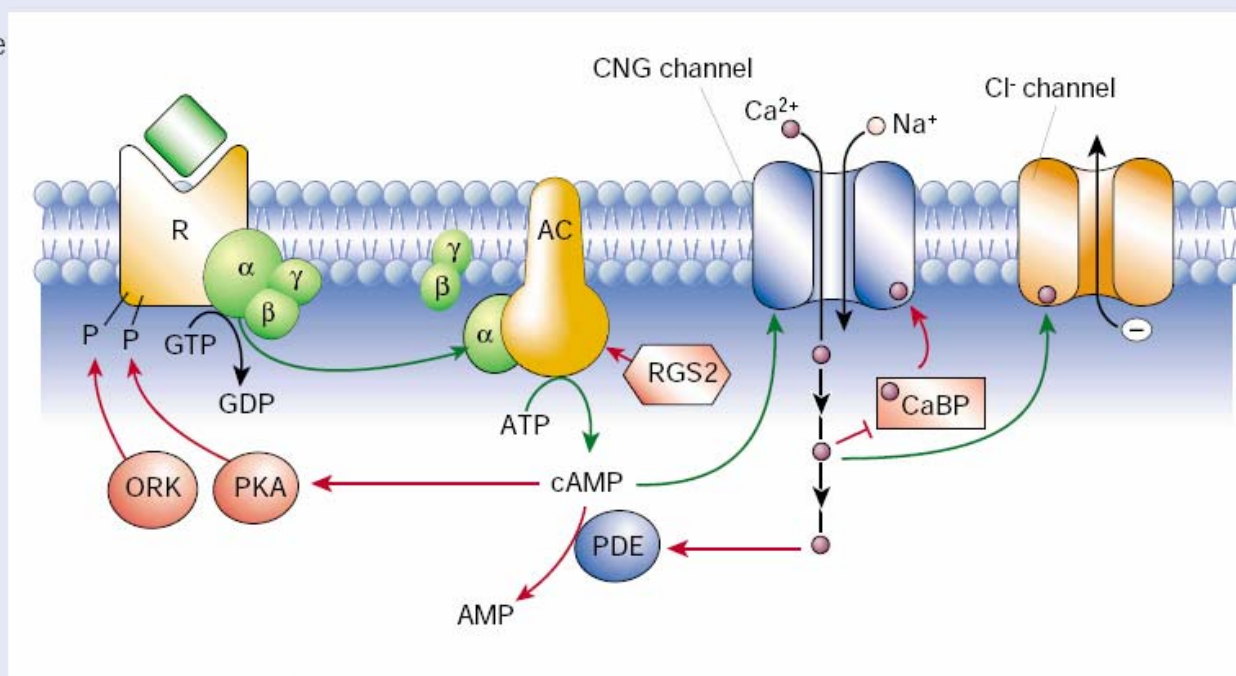


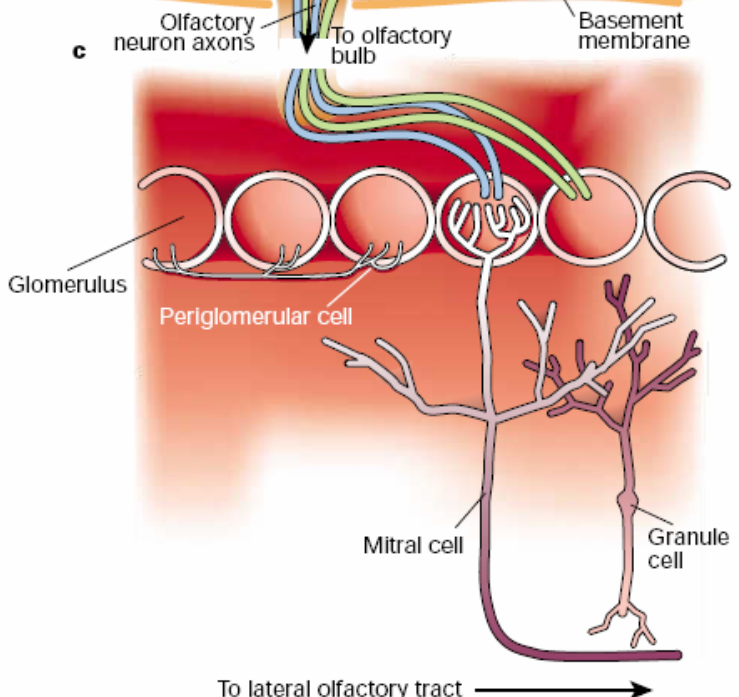
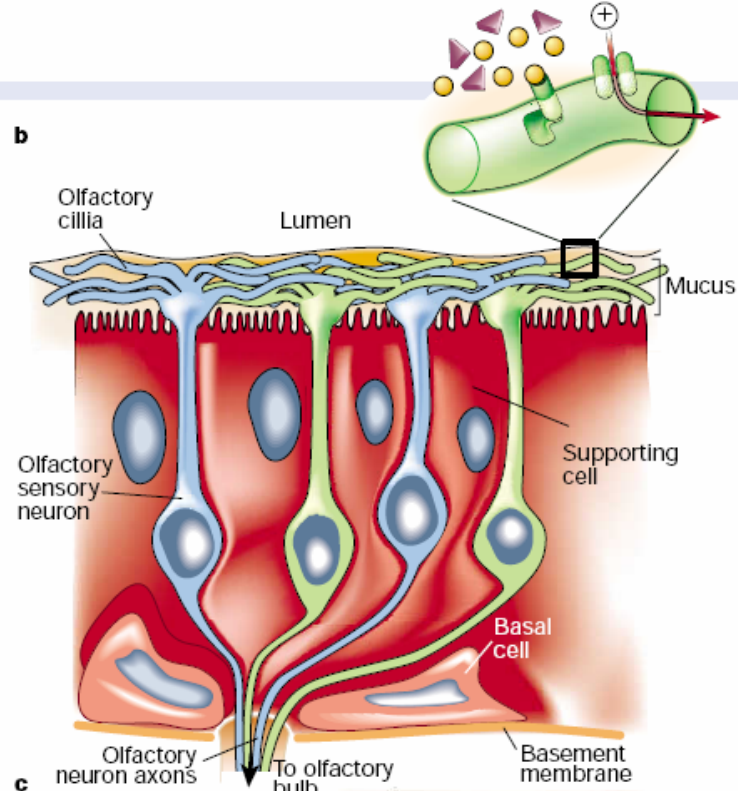
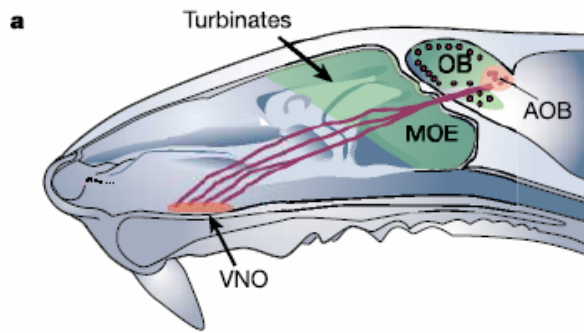
(b) Increase in  $\text{IP}_3$





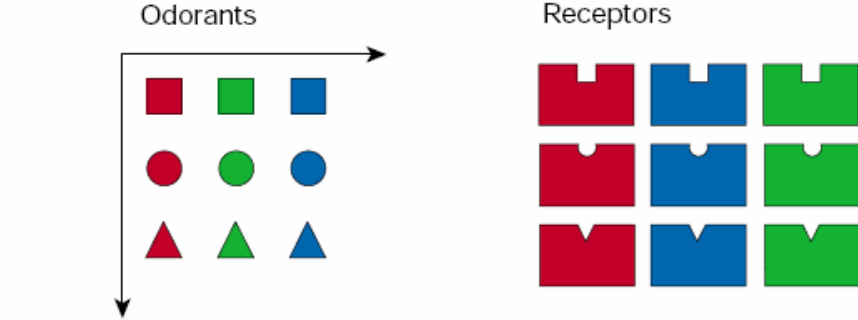
**Figure 3** Sensory transduction. Within the compact cilia of the OSNs a cascade of enzymatic activity transduces the binding of an odorant molecule to a receptor into an electrical signal that can be transmitted to the brain. As described in detail in the text, this is a classic cyclic nucleotide transduction pathway in which all of the proteins involved have been identified, cloned, expressed and characterized. Additionally, many of them have been genetically deleted from strains of mice, making this one of the most investigated and best understood second-messenger pathways in the brain. AC, adenylyl cyclase; CNG channel, cyclic nucleotide-gated channel; PDE, phosphodiesterase; PKA, protein kinase A; ORK, olfactory receptor kinase; RGS, regulator of G proteins (but here acts on the AC); CaBP, calmodulin-binding protein. Green arrows indicate stimulatory pathways; red indicates inhibitory (feedback).



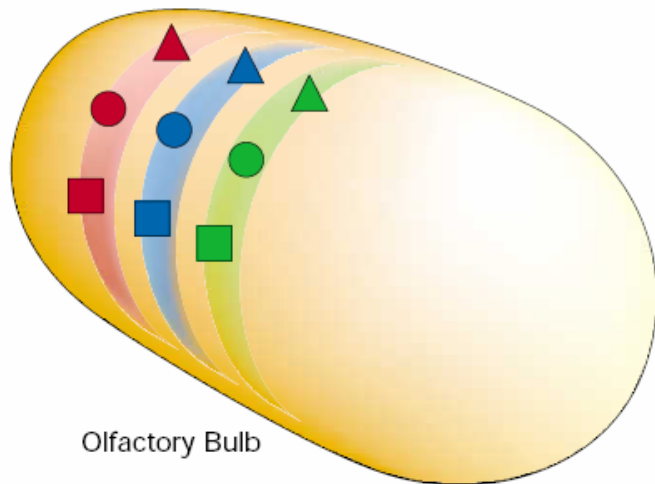
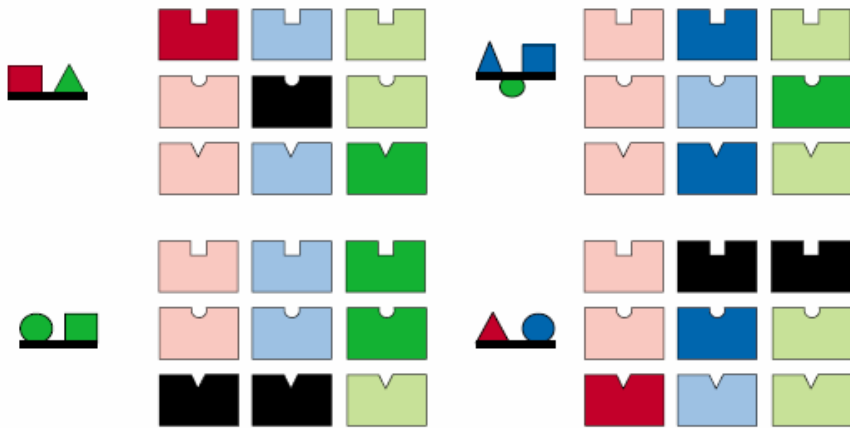


**Figure 1** Functional anatomy and structure of the early olfactory system. In one of the clearest cases of function following form in the nervous system, the anatomy and structure of the early olfactory system reflect the strategy for discriminating between a large number of diverse stimuli. **a**, In a sagittal view of the rat head, the main olfactory epithelium (MOE) is highlighted in green. The turbinates are a set of cartilaginous flaps that serve to increase the surface area of the epithelium; they are covered with the thin olfactory neuroepithelium (shown in **b**). The cells of the MOE send their unbranched axons to targets in the olfactory bulb (OB) known as glomeruli (shown in **c**). The vomeronasal organ (VNO) is shown in red, and the targets of the VSN axons are in glomeruli in the accessory olfactory bulb (AOB). The structure of the nasal cavity is optimized for exposing the largest possible surface area of sensory neurons to a stimulus stream that is warmed, moistened and perhaps concentrated by sniffing. **b**, The olfactory neuroepithelium is a relatively simple tissue consisting of only three cell types: olfactory sensory neurons (OSNs; the only neuronal cell type), supporting or sustentacular cells (a kind of glial cell, which possess microvilli on their apical surface), and a stem-cell population, known as basal cells, from which new OSNs are generated. **c**, Wiring of the early olfactory system. Each OSN expresses only one of the ~1,000 OR genes and the axons from all cells expressing that particular receptor converge onto one or a few 'glomeruli' in the OB. The nearly 2,000 glomeruli in the rat OB are spherical knots of neuropil, about 50–100  $\mu\text{m}$  in diameter, which contain the incoming axons of OSNs and the apical dendrites of the main input-output neuron of the OB, the mitral cell. Mitral axons leaving the OB project widely to higher brain structures including the piriform cortex, hippocampus and amygdala. Lateral processing of the message occurs through two populations of interneurons: periglomerular cells and granule cells.

To lateral olfactory tract →



Pattern of peripheral activation

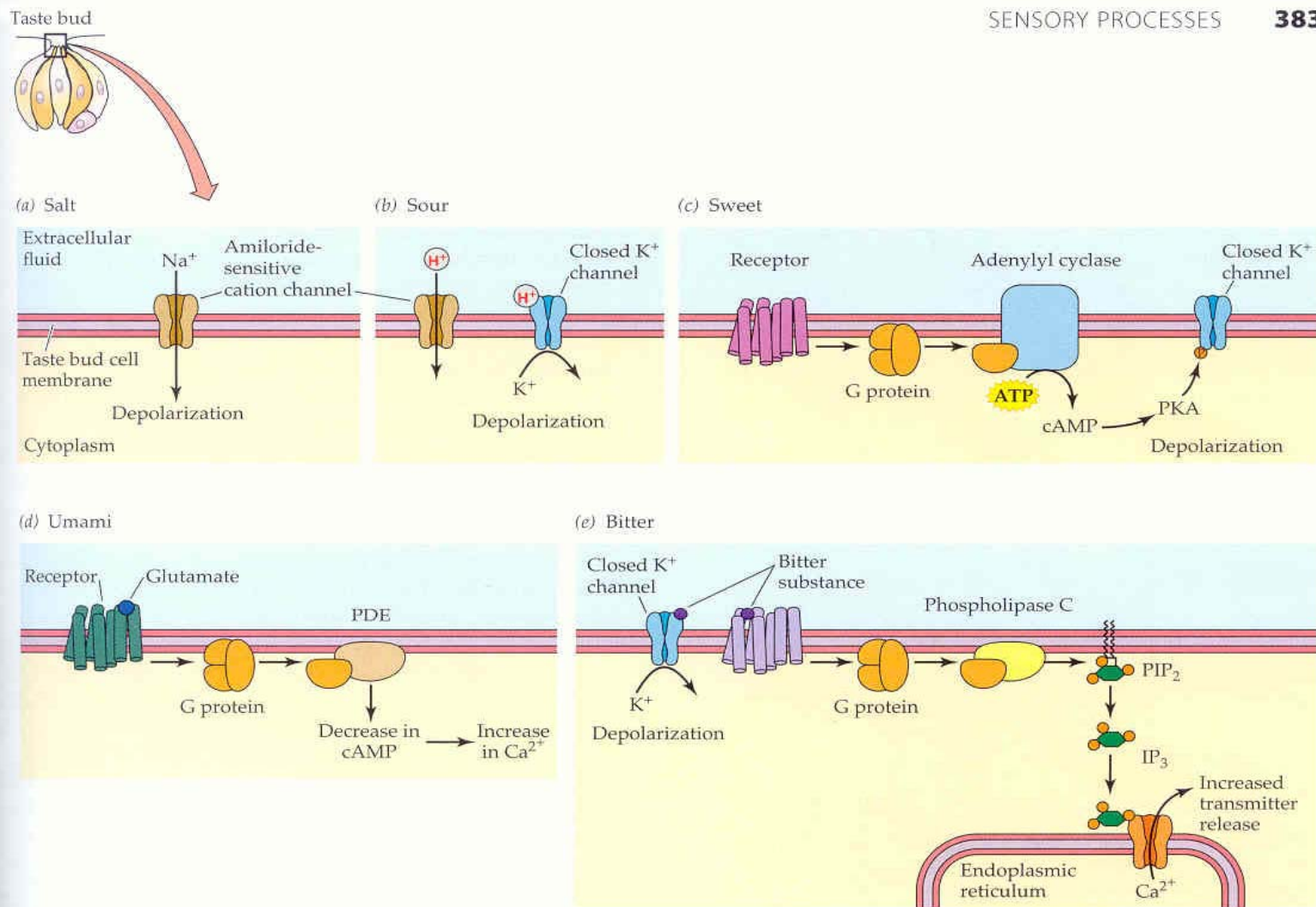


Although there are some 1,000 ORs, detecting the enormous repertoire of odours requires a combinatorial strategy. Most odour molecules are recognized by more than one receptor (perhaps by dozens) and most receptors recognize several odours, probably related by chemical property. The scheme in the figure represents a current consensus model. There are numerous molecular features, two of which are represented here by colour and shape. Receptors are able to recognize different features of molecules, and a particular odour compound may also consist of a number of these 'epitopes' or 'determinants' that possess some of these features. Thus the recognition of an odour molecule depends on which receptors are activated and to what extent, as shown by the shade of colour (black represents no colour or shape match and thus no activation). Four odour compounds are depicted with the specific array of receptors each would activate. Note that there are best receptors (for example, red square), but also other receptors that are able to recognize some feature of the molecule (for example, any square) and would participate in the discrimination of that compound. In the olfactory bulb there seem to be wide areas of sensitivity to different features (for example, functional group or molecular length). This model is based on current experimental evidence, but is likely to undergo considerable revision as more data become available.



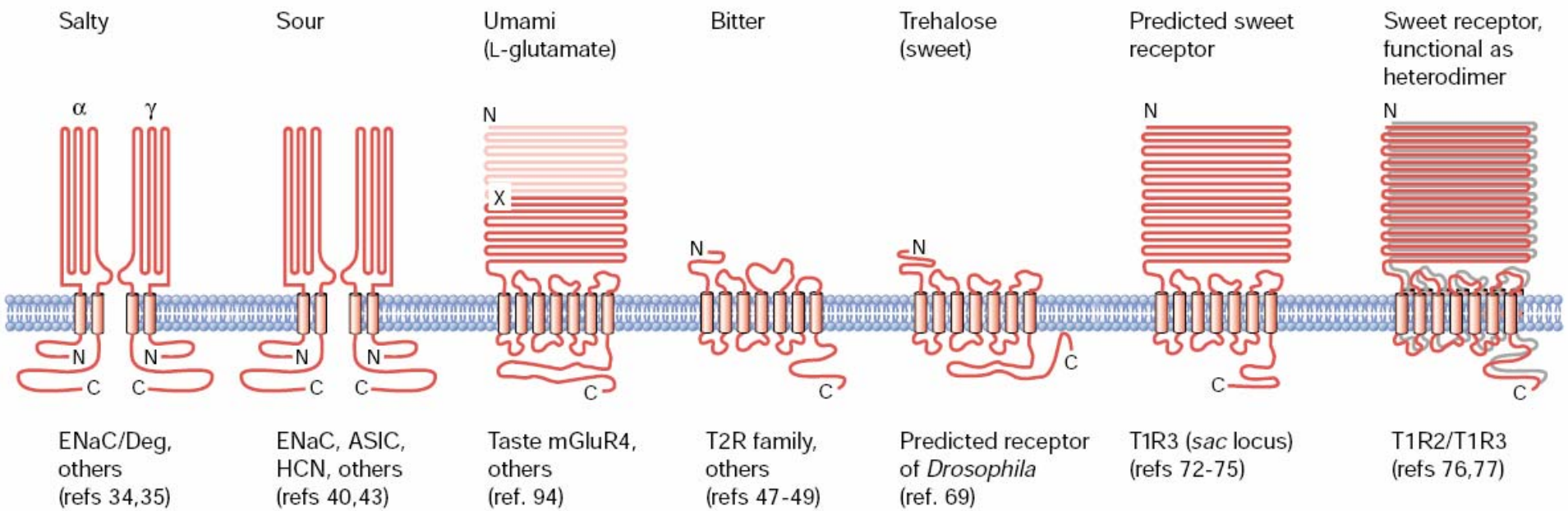
# Chemorecepce - chut'



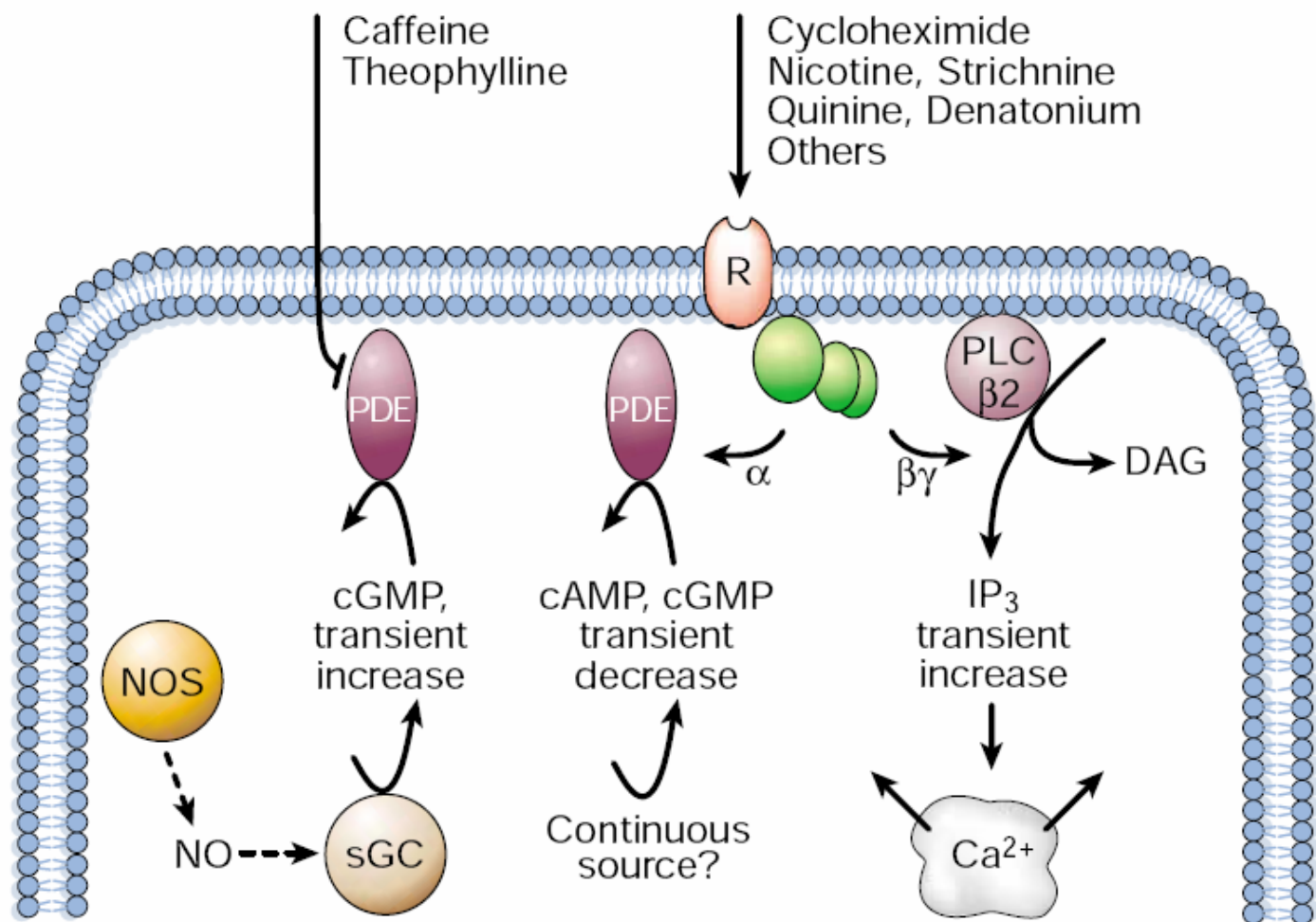


**Figure 13.34 Taste-transduction mechanisms differ for different taste qualities** All transduction mechanisms except the  $\text{IP}_3$  action in (e) lead to *depolarization*, which spreads to the basal end of the cell and opens voltage-gated  $\text{Ca}^{2+}$  channels to allow  $\text{Ca}^{2+}$  entry and transmitter release. (a) For salt taste, sodium ions enter a taste bud cell through amiloride-sensitive cation channels, directly depolarizing the cell. (b) In sour taste, either  $\text{H}^+$  ions enter the cell through amiloride-sensitive cation channels, or they close  $\text{K}^+$  channels to produce depolarization. (c) Sweet taste is most commonly mediated by the binding of sugars to a G protein-coupled receptor, which acts via a G protein to activate adenylyl cyclase and produce cyclic AMP. Cyclic AMP then activates protein kinase A (PKA) to close a  $\text{K}^+$  channel (by phosphorylating

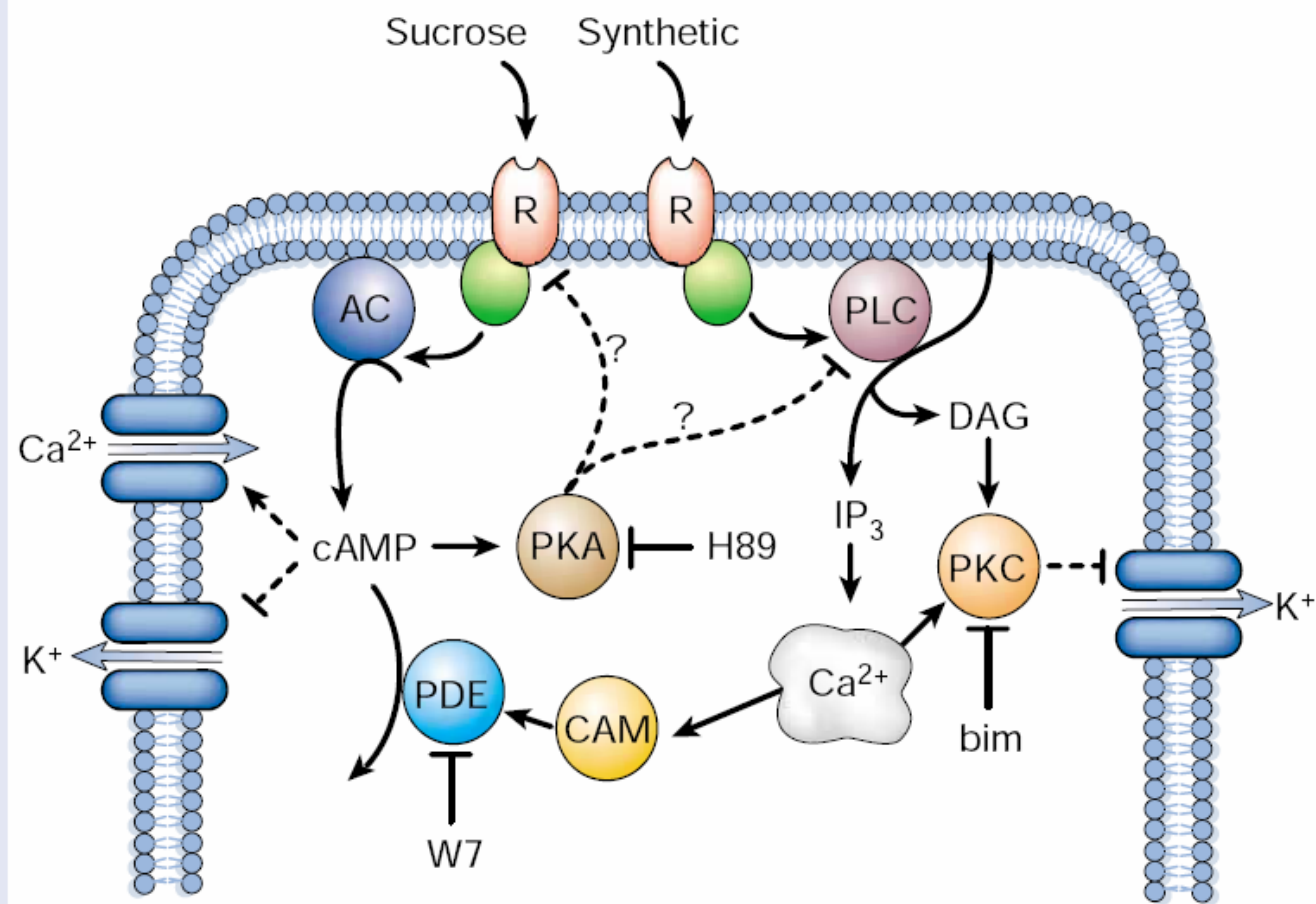
it), producing depolarization. (d) The amino acid glutamate (monosodium glutamate, MSG) stimulates the taste quality umami (a savory or meaty quality). Glutamate binds to a G protein-coupled receptor (related to synaptic metabotropic glutamate receptors) to activate a phosphodiesterase (PDE) and decrease the concentration of cAMP. The decrease in cAMP leads to an increase in intracellular  $\text{Ca}^{2+}$  concentration. (e) Bitter taste mechanisms can involve a G protein-coupled receptor for bitter substances that acts via a G protein and phospholipase C to produce  $\text{IP}_3$ .  $\text{IP}_3$  liberates  $\text{Ca}^{2+}$  ions from intracellular stores, eliciting transmitter release without requiring depolarization. Other bitter substances bind to  $\text{K}^+$  channels and close them to depolarize the cell.







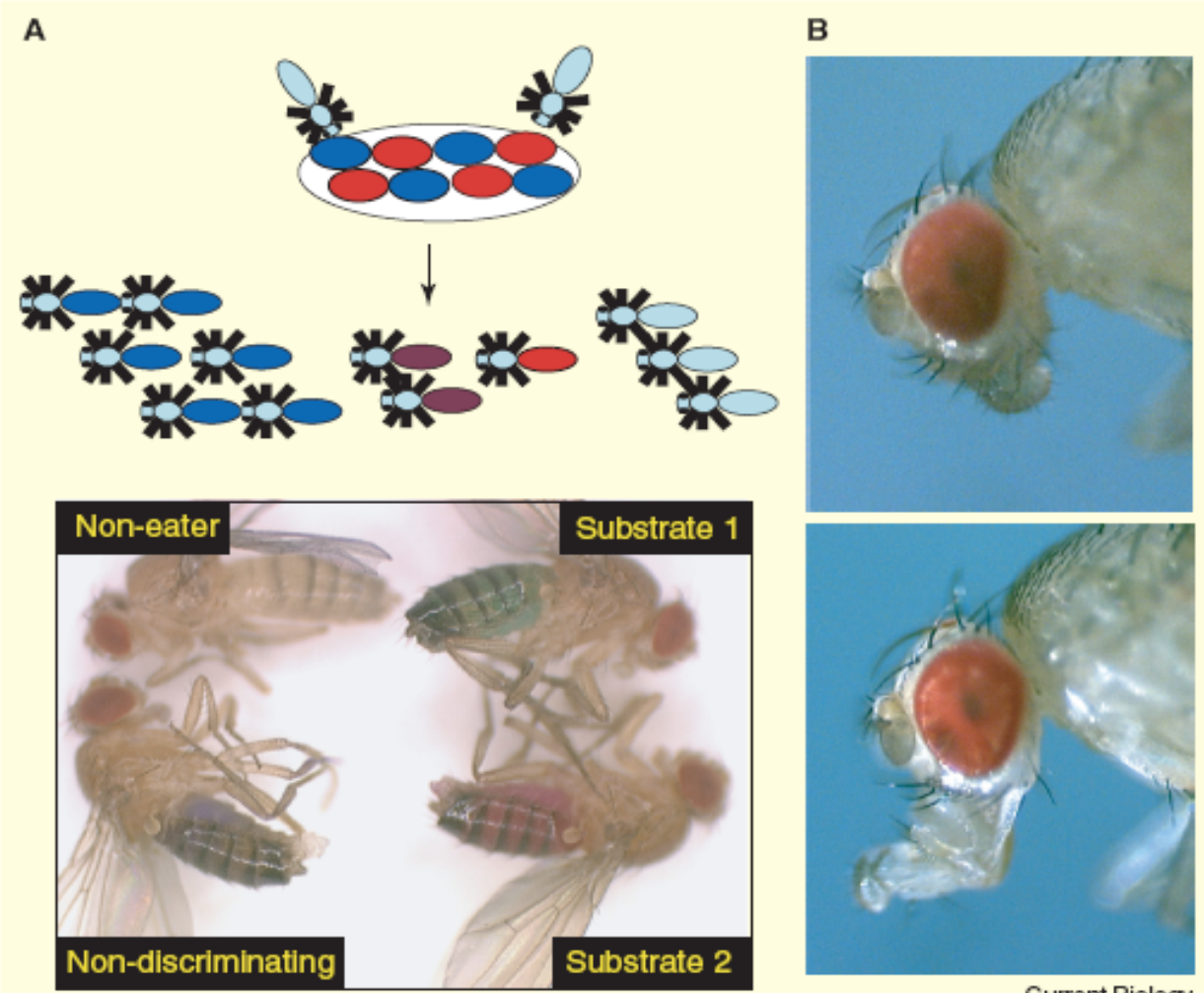
**Figure 3** Transduction of bitter taste as elicited by a variety of ligands. Rs, multiple GPCRs of the T2R family, coupled to the G protein gustducin<sup>47–49</sup>;  $\alpha$ ,  $\alpha$ -subunit of gustducin<sup>6,57</sup>;  $\beta\gamma$ , G-protein subunits  $\beta3$  and  $\gamma13$  (refs 60–62); PLC $\beta2$ , phospholipase C subtype<sup>61</sup>; Ins(1,4,5)P<sub>3</sub>, inositol-1,4,5-trisphosphate<sup>59</sup>; PDE, taste-specific phosphodiesterase<sup>58</sup>; cAMP, cyclic adenosine monophosphate<sup>59</sup>; cGMP, cyclic guanosine monophosphate<sup>59</sup>; sGC, soluble guanylate cyclase<sup>55</sup>; NO, nitric



**Figure 4** Molecules involved in the transduction of sweet taste. Two separate sweet receptors are shown, but the possibility that one receptor activates both of the transduction pathways<sup>100</sup> is not excluded at this stage. R, candidate receptor(s)<sup>72-75</sup>; AC, adenylate cyclase<sup>81,82,87</sup>; cAMP, cyclic adenosine monophosphate<sup>21</sup>; PDE, phosphodiesterase, inhibitor W7 (ref. 89); CAM, calmodulin<sup>89</sup>; PKA, protein kinase A, inhibitor H89 (ref. 89); PLC, phospholipase C<sup>89</sup>; DAG, diacylglycerol; Ins(1,4,5)P<sub>3</sub>, inositol-1,4,5-trisphosphate<sup>21</sup>; PKC, protein kinase C, inhibitor bim (bisindolylmaleimide)<sup>89</sup>. For crosstalk between pathways and effects of inhibitors

Figure 2. Assays of feeding behavior.

(A) Two-choice preference assay. Flies are first starved for a day and then provided with the choice of two chemicals, presented on a multi-well plate at specific concentrations in an agar medium. The two food substrates also contain different tasteless compounds that have intrinsic colors. For example, sucrose might be added in one half of the wells on a titer plate, along with the sulforhodamine B dye (red) and trehalose, along with an erioglaucine dye (blue) on the other half of the wells. The feeding is carried out in darkness (to exclude any influence of color preference) and the abdomen of the flies is inspected visually. The number of flies feeding on either substrate (red or blue abdomen) and both substrates (purple abdomen) are used to determine the feeding preference index:  $PI(\text{sucrose}) = \frac{N(\text{red}) + 0.5N(\text{purple})}{N(\text{red}) + N(\text{blue}) + N(\text{purple})}$ . (B) Proboscis extension reflex. This does not measure feeding behavior, but rather a reflex behavior associated with feeding. Starved flies are narcotized and immobilized and then let to awaken and recover. Upon satiation with water, the forelegs of the fly – the GRNs – are stimulated with a chemical and the number of proboscis extensions are counted over a short period directly following the stimulation. The proboscis is usually withdrawn (top), but upon stimulation of the foreleg with a feeding stimulus (for example a sugar solution), is frequently extended (bottom). The number of extensions is directly correlated with the attractiveness of the stimulus.

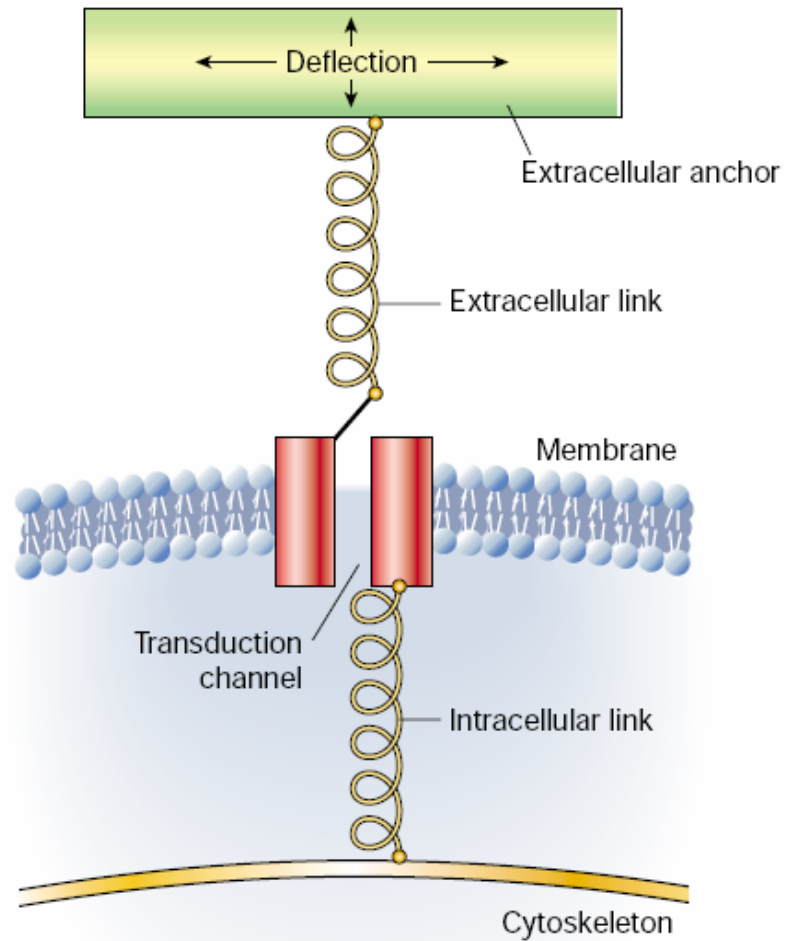


the GRNs – are stimulated with a chemical and the number of proboscis extensions are counted over a short period directly following the stimulation. The proboscis is usually withdrawn (top), but upon stimulation of the foreleg with a feeding stimulus (for example a sugar solution), is frequently extended (bottom). The number of extensions is directly correlated with the attractiveness of the stimulus.



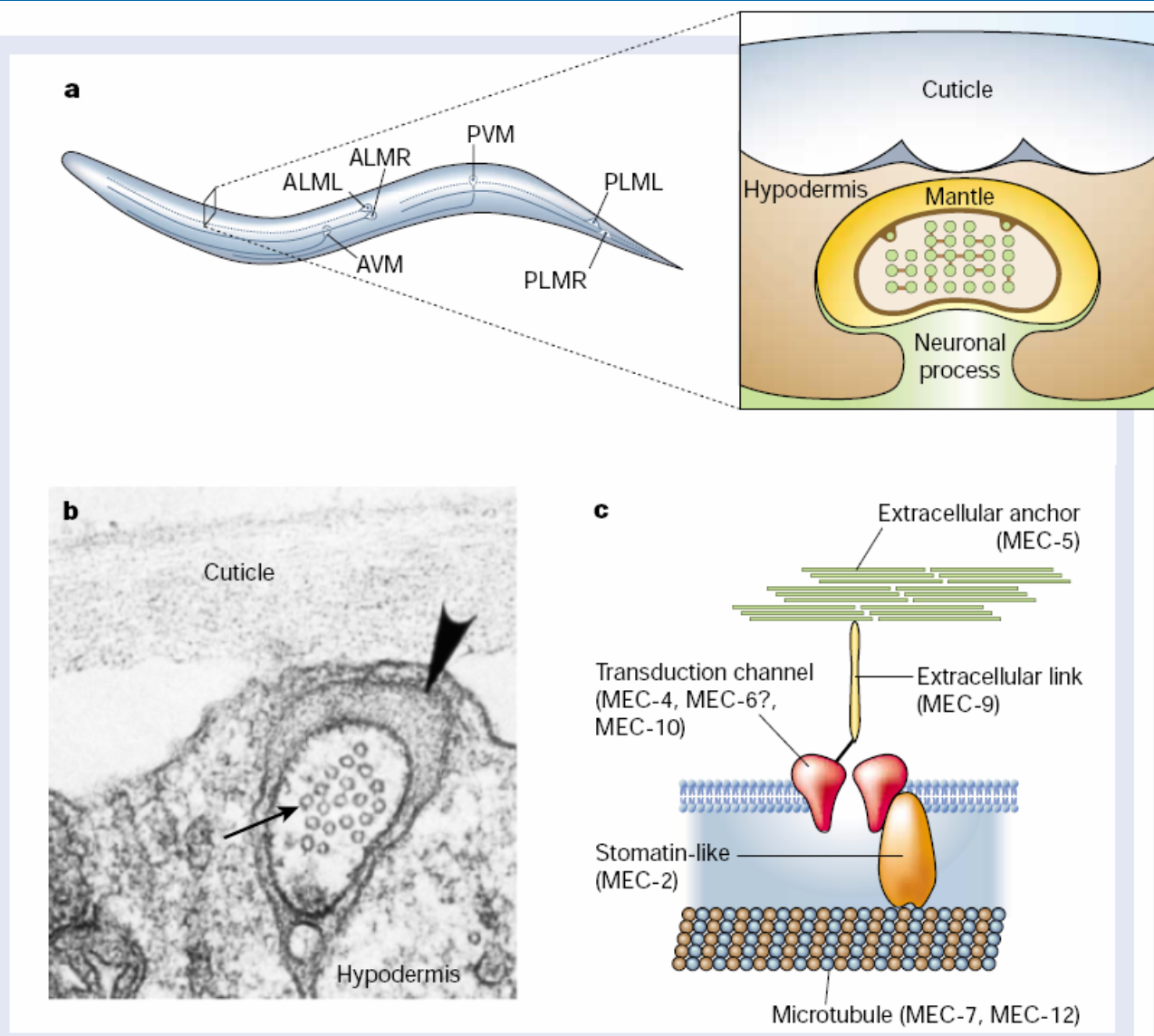
# Mechanorecepce – hmat, sluch





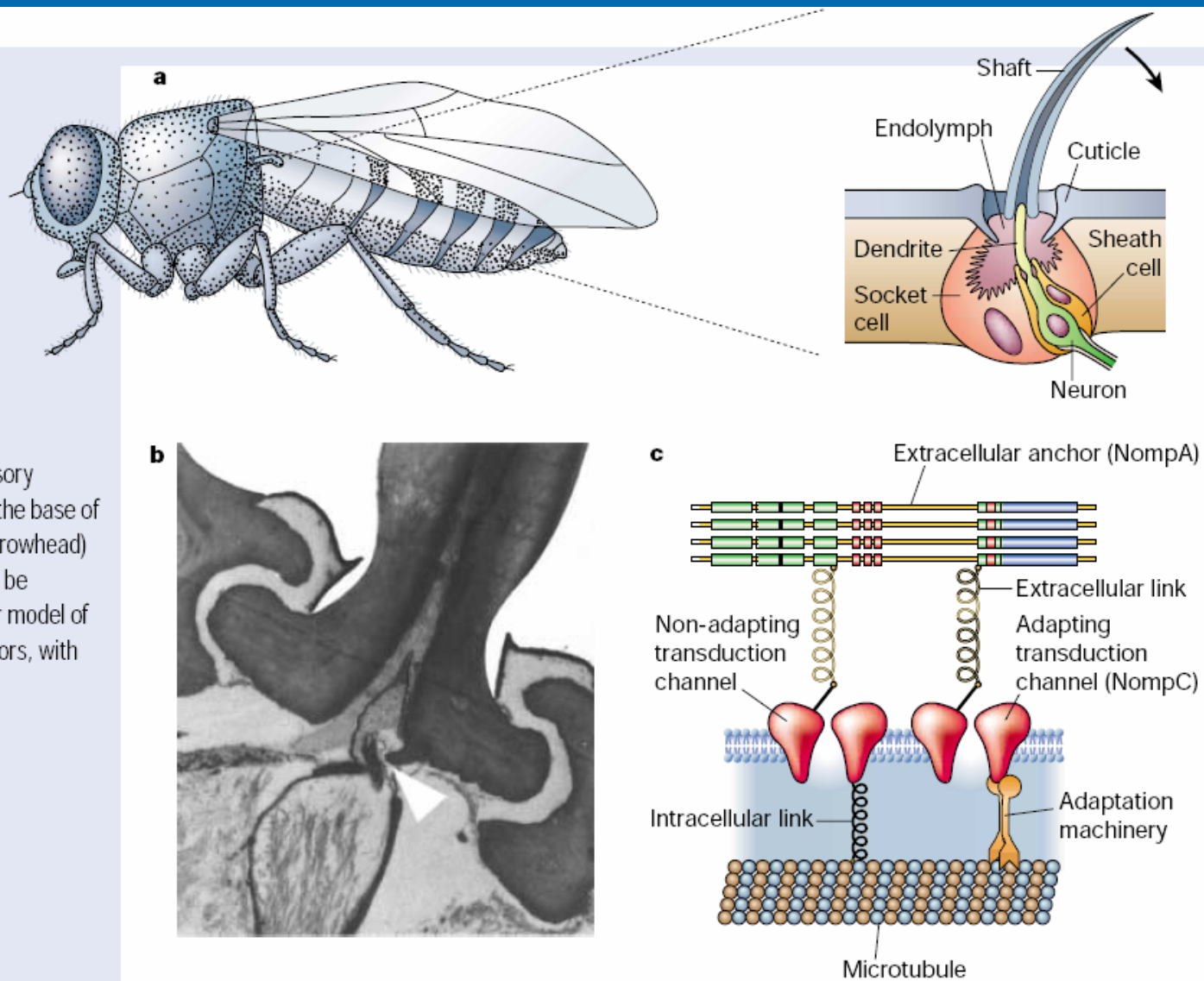
**Figure 1** General features of mechanosensory transduction. A transduction channel is anchored by intracellular and extracellular anchors to the cytoskeleton and to an extracellular structure to which forces are applied. The transduction channel responds to tension in the system, which is increased by net displacements between intracellular and extracellular structures.

**Figure 2** *C. elegans* touch-receptor structure and transduction model. **a**, View of *C. elegans* showing positions of mechanoreceptors. AVM, anterior ventral microtubule cell; ALML/R, anterior lateral microtubule cell left/right; PVM, posterior ventral microtubule cell; PLML/R, posterior lateral microtubule cell left/right. **b**, Electron micrograph of a touch-receptor neuron process. Mechanotransduction may ensue with a net deflection of the microtubule array relative to the mantle, a deflection detected by the transduction channel. Arrow, 15-protofilament microtubules; arrowhead, mantle. Modified from ref. 3. **c**, Proposed molecular model for touch receptor. Hypothetical locations of *mec* proteins are indicated.

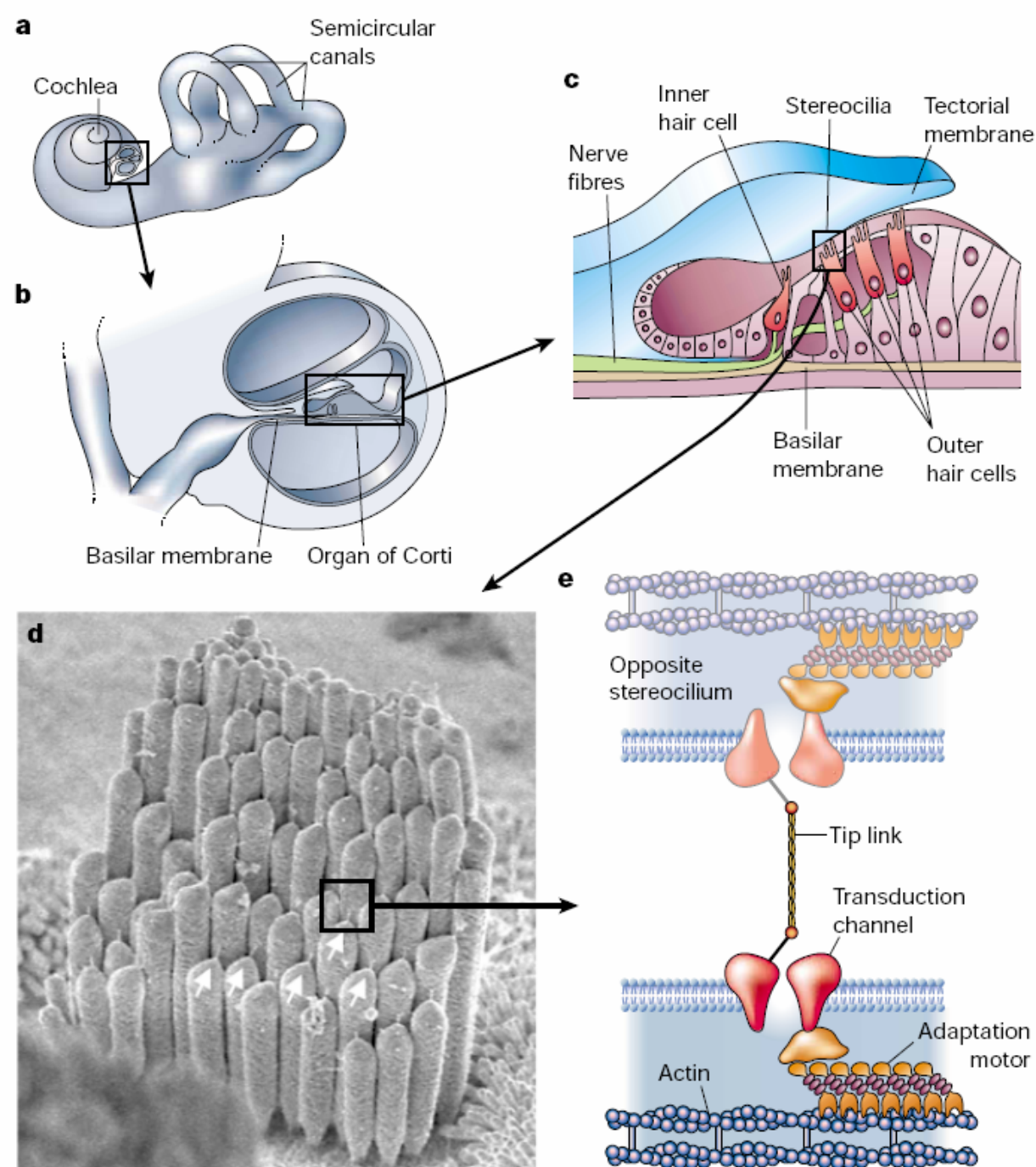


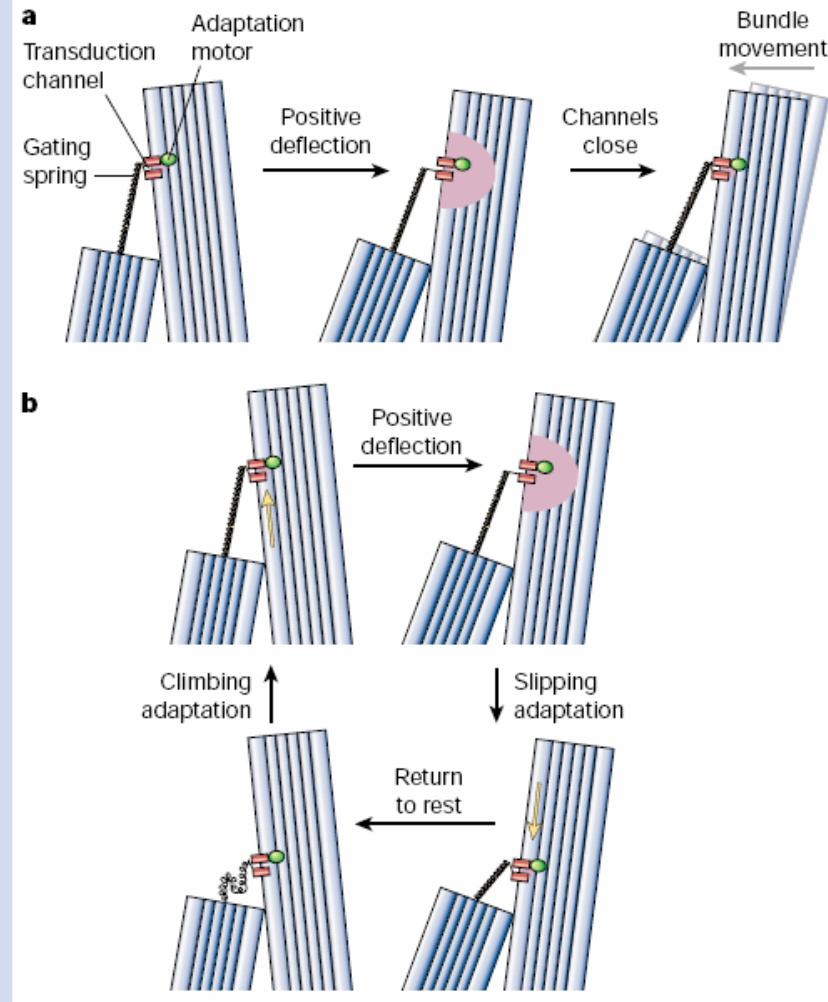


**Figure 3** *Drosophila* bristle-receptor model. **a**, Lateral view of *D. melanogaster* showing the hundreds of bristles that cover the fly's cuticle. The expanded view of a single bristle indicates the locations of the stereotypical set of cells and structures associated with each mechanosensory organ. Movement of the bristle towards the cuticle of the fly (arrow) displaces the dendrite and elicits an excitatory response in the mechanosensory neuron. **b**, Transmission electron micrograph of an insect mechanosensory bristle showing the insertion of the dendrite at the base of the bristle. The bristle contacts the dendrite (arrowhead) so that movement of the shaft of the bristle will be detected by the neuron. **c**, Proposed molecular model of transduction for ciliated insect mechanoreceptors, with the locations of NompC and NompA indicated.



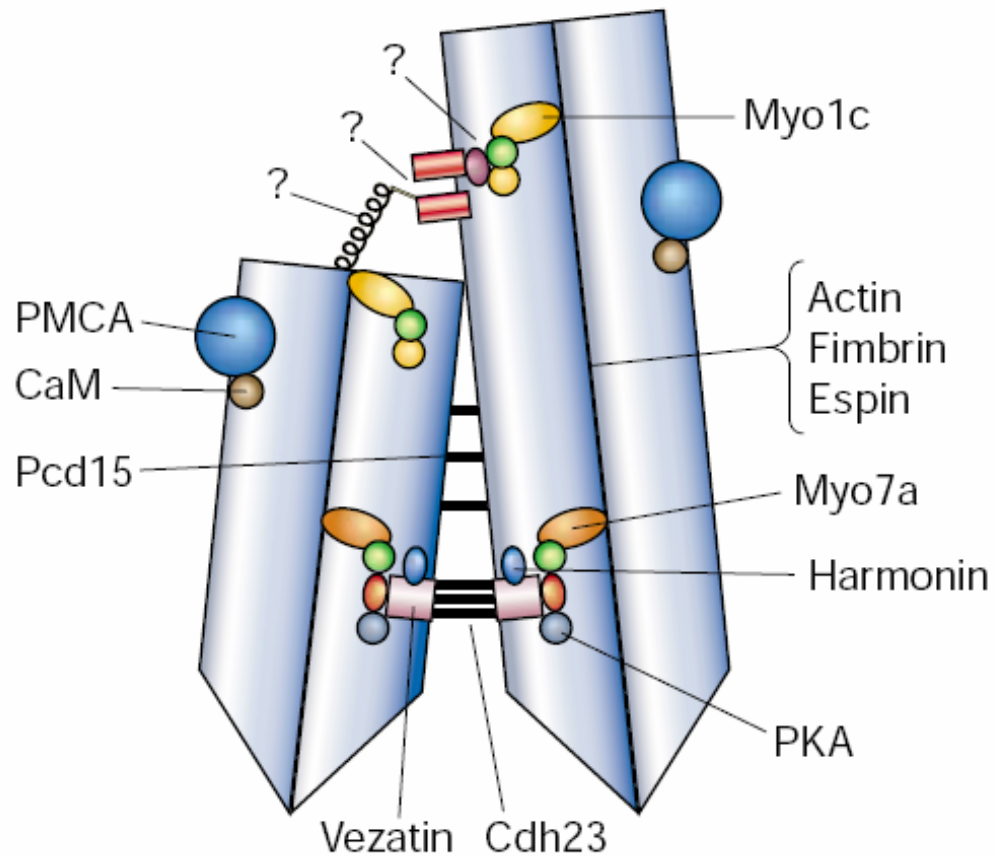
**Figure 4** Inner-ear structure and hair-cell transduction model. **a**, Gross view of part of the inner ear. Sound is transmitted through the external ear to the tympanic membrane; the stimulus is transmitted through the middle ear to the fluid-filled inner ear. Sound is transduced by the coiled cochlea. **b**, Cross-section through the cochlear duct. Hair cells are located in the organ of Corti, resting on the basilar membrane. **c**, Sound causes vibrations of the basilar membrane of the organ of Corti; because flexible hair-cell stereocilia are coupled to the overlying tectorial membrane, oscillations of the basilar membrane cause back-and-forth deflection of the hair bundles. **d**, Scanning electron micrograph of hair bundle (from chicken cochlea). Note tip links (arrows). **e**, Proposed molecular model for hair-cell transduction apparatus.





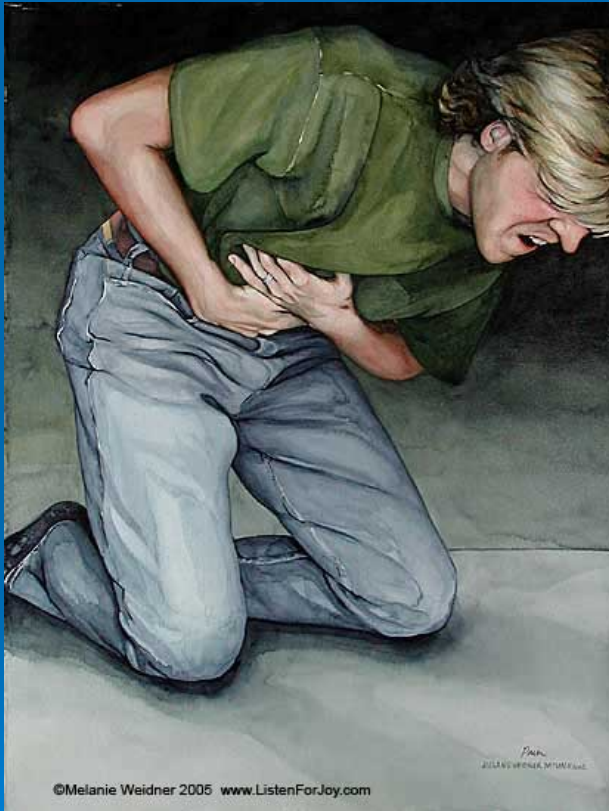
**Box 2 Figure** Hair-cell transduction and adaptation. **a**, Transduction and fast adaptation. At rest (left panel), transduction channels spend ~5% of the time open, allowing a modest  $\text{Ca}^{2+}$  entry (pink shading). A positive deflection (middle) stretches the gating spring (drawn here as the tip link); the increased tension propagates to the gate of the transduction channel, and channels open fully. The resulting  $\text{Ca}^{2+}$  flowing in through the channels shifts the channels' open probability to favour channel closure (right). As the gates close, they increase force in the gating spring, which moves the bundle back in the direction of the original stimulus. **b**, Transduction and slow adaptation. Slow adaptation ensues when the motor (green oval) slides down the stereocilium (lower right), allowing channels to close. After the bundle is returned to rest (lower left), gating-spring tension is very low; adaptation re-establishes tension and returns the channel to the resting state.



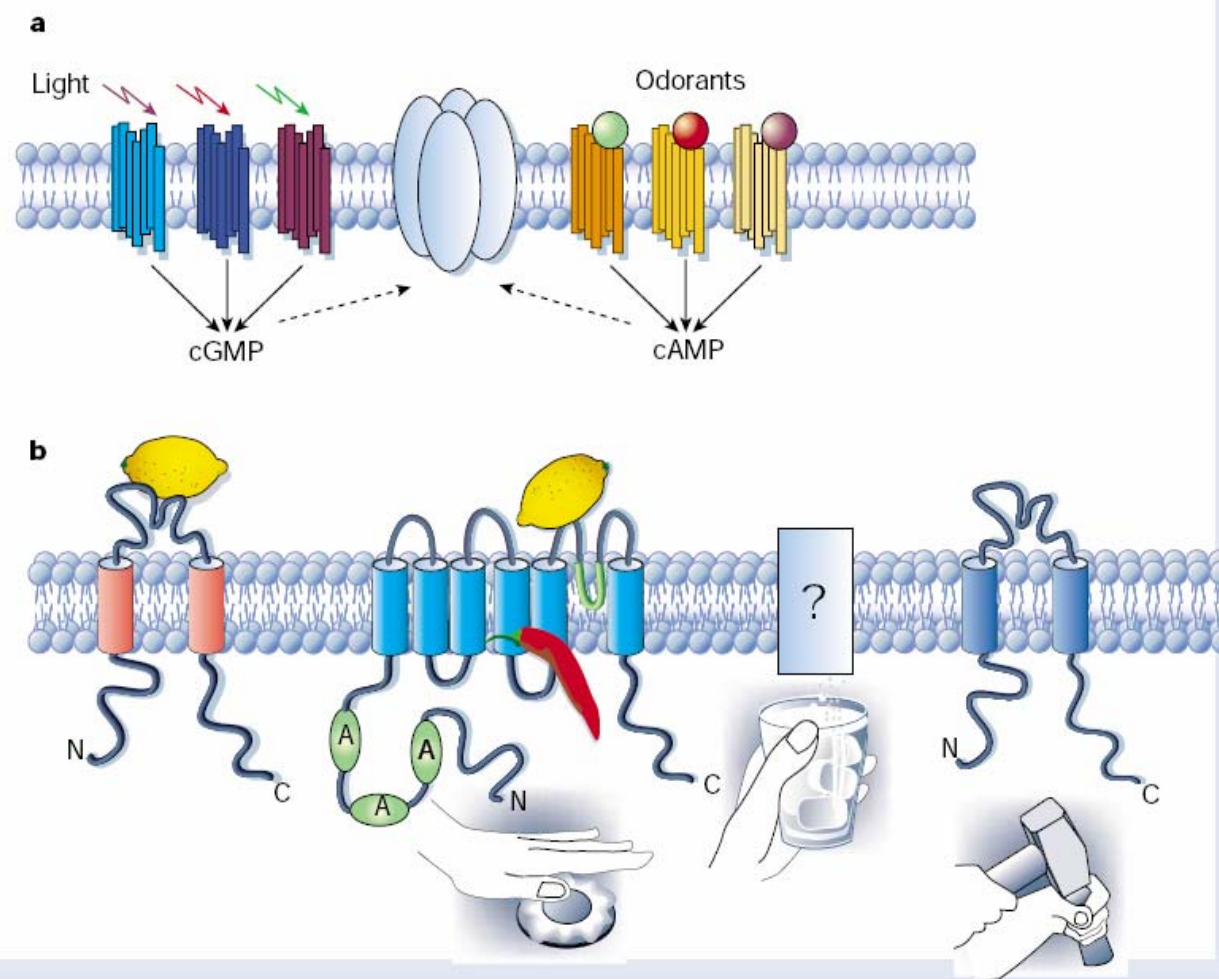


**Box 3 Figure** Schematic illustration of identified hair-bundle proteins showing hypothetical locations of molecules implicated in stereocilia function. Myo7a, vezatin, Cdh23 and PKA may form the ankle-link complex. Pcd15 presumably also interconnects stereocilia. Myo1c may carry out adaptation, whereas PMCA maintains a low  $\text{Ca}^{2+}$  concentration. Actin, fimbrin and espin have structural roles; not shown is DFNA1, which may help form the cytoskeleton. Calmodulin regulates several enzymes within the bundle, including PMCA, Myo1c and Myo7a.

# Nocicepce – vnímání bolesti

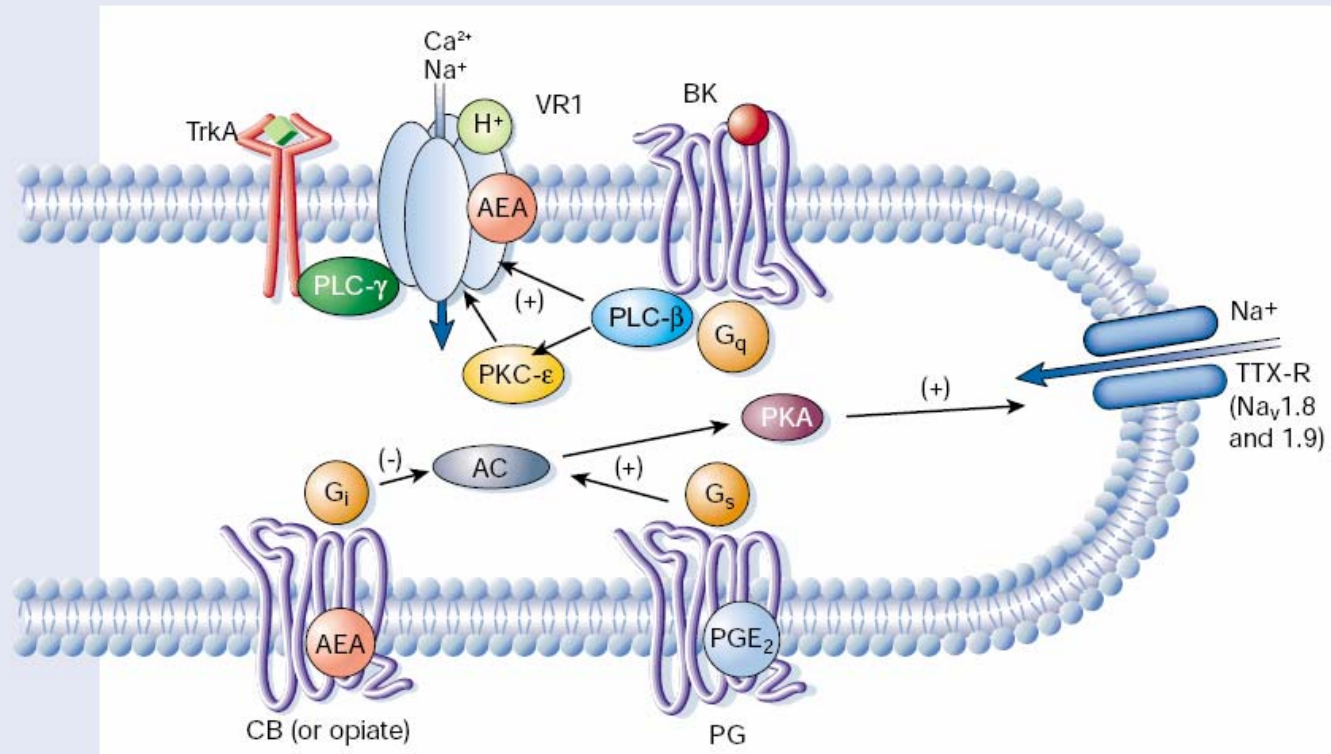


**Figure 2** Polymodal nociceptors use a greater diversity of signal-transduction mechanisms to detect physiological stimuli than do primary sensory neurons in other systems. **a**, In mammals, light or odorants are detected by a convergent signalling pathway in which G-protein-coupled receptors modulate the production of cyclic nucleotide second messengers, which then alter sensory neuron excitability by regulating the activity of a single type of cation channel. **b**, In contrast, nociceptors use different signal-transduction mechanisms to detect physical and chemical stimuli. Recent studies suggest that TRP-channel family members (VR1 and VRL-1) detect noxious heat, and that ENaC/DEG-channel family detect mechanical stimuli. Molecular transducers for noxious cold remain enigmatic. Noxious chemicals, such as capsaicin or acid (that is, extracellular protons) may be detected through a common transducer (VR1), illustrating aspects of redundancy in nociception. At the same time, a single type of stimulus can interact with multiple detectors, as shown by the ability of extracellular protons to activate not only VR1, but also ASICs, which are also members of the ENaC/DEG-channel family.





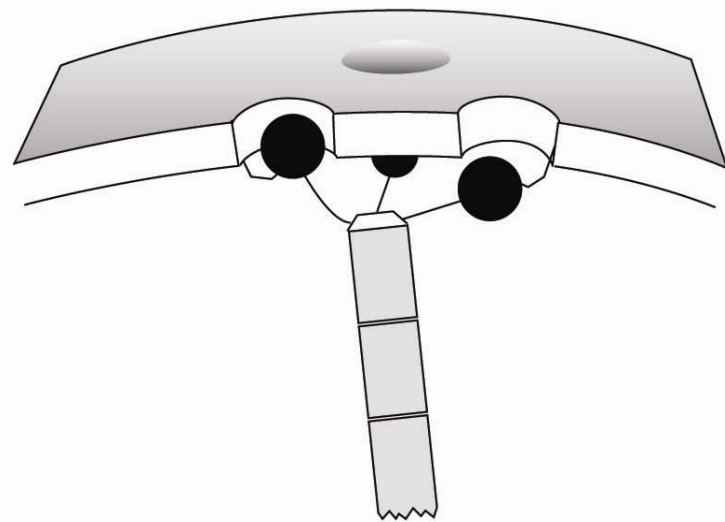
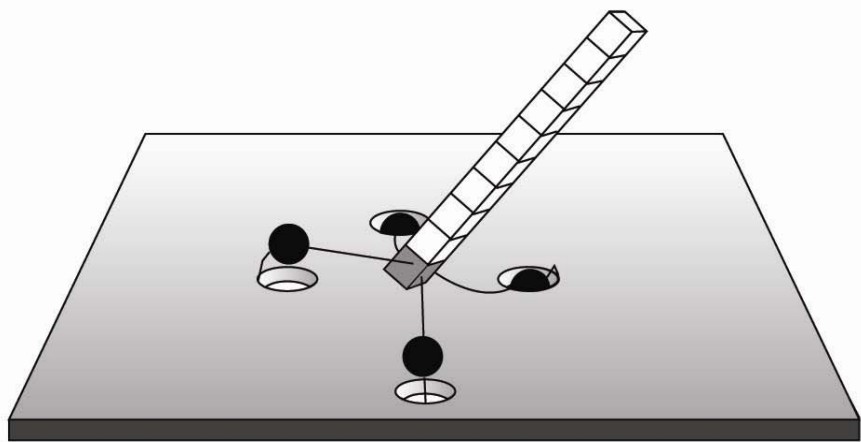
**Figure 4** When nociceptors are exposed to products of injury and inflammation, their excitability is altered by a variety of intracellular signalling pathways. The figure highlights the vanilloid receptor (VR1) and tetrodotoxin-resistant (TTX-R) voltage-gated sodium channels ( $\text{Na}_v1.8$  and 1.9) as downstream targets of modulation. Responses of VR1 to heat can be potentiated by direct interaction of the channel with extracellular protons ( $\text{H}^+$ ) or lipid metabolites, such as anandamide (AEA). VR1 activity can also be heightened by agents such as NGF or bradykinin, which bind to their own cell-surface receptors (TrkA and BK, respectively) to stimulate phospholipase C (PLC- $\gamma$  or PLC- $\beta$ ) signalling pathways. This, in turn, leads to hydrolysis of plasma membrane lipids and the subsequent stimulation of protein kinase C isoforms, such as PKC- $\epsilon$ . Both of these actions have been proposed to potentiate VR1 function.



Prostaglandins ( $\text{PGE}_2$ ) and other inflammatory products that activate adenylyl cyclase (AC) through  $G_s$ -coupled receptors also enhance nociceptor excitability. This occurs, in part, by a cyclic AMP-dependent protein kinase (PKA)-dependent phosphorylation of  $\text{Na}_v1.8$  and/or  $\text{Na}_v1.9$ . By activating  $G_i$ -coupled receptors, opiates and cannabinoids can counteract these increases in excitability of the nociceptor, and produce a peripherally mediated analgesia.

# Magnetorecepce





JD →

SP

$B = 0$

iontové kanály

shluky nanokrystalů magnetitu

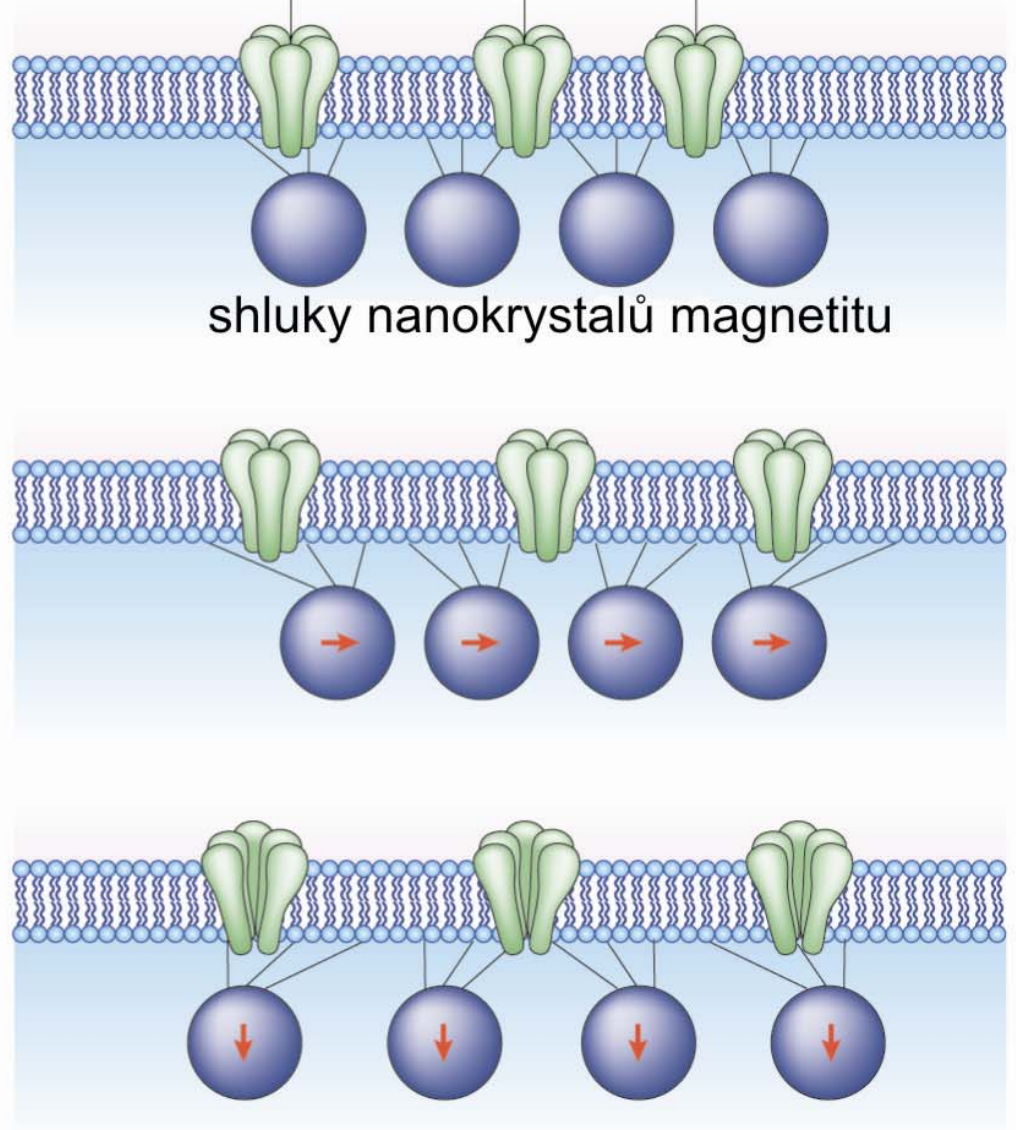
→

→

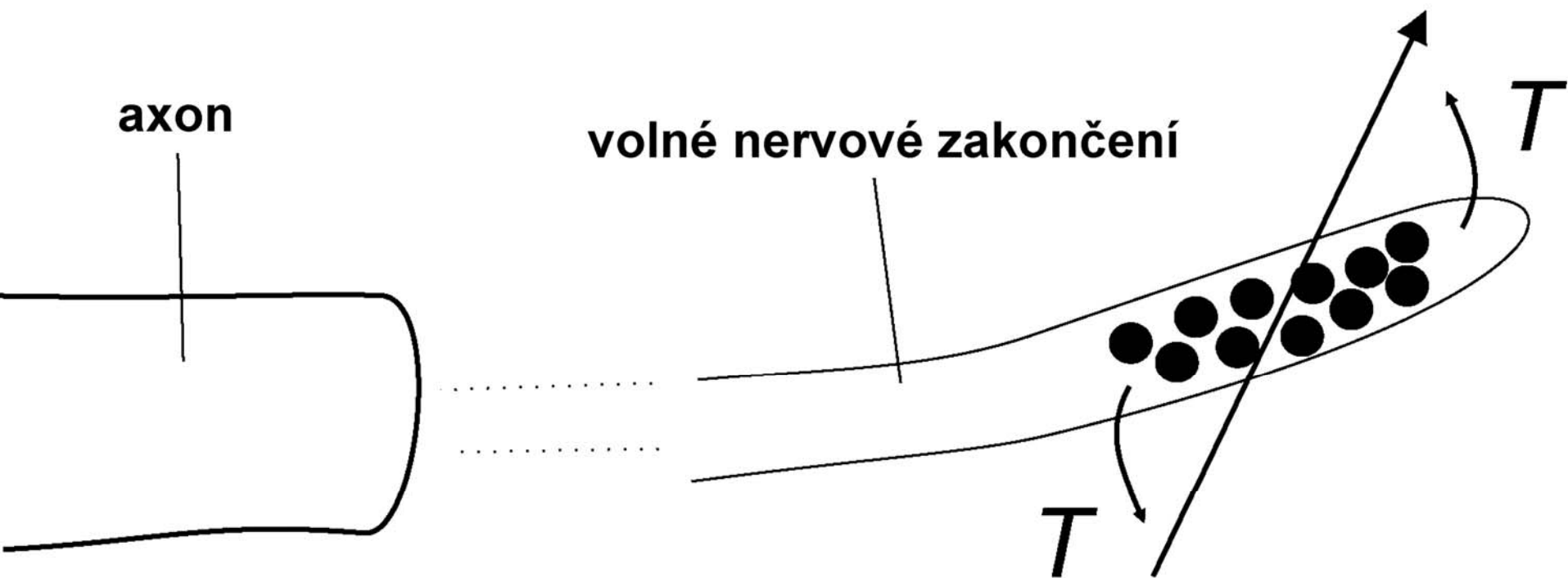


↓

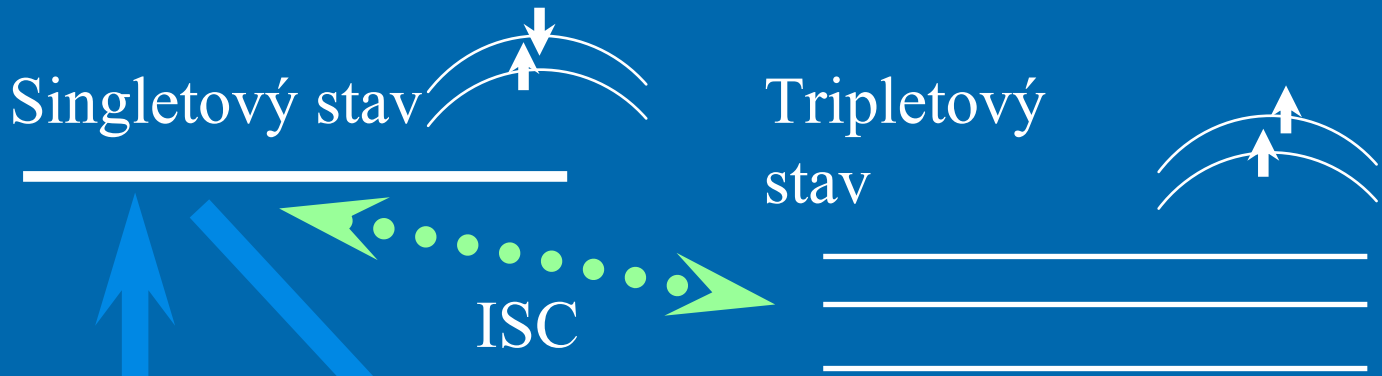
↓







Energie



excitace  
fotonem

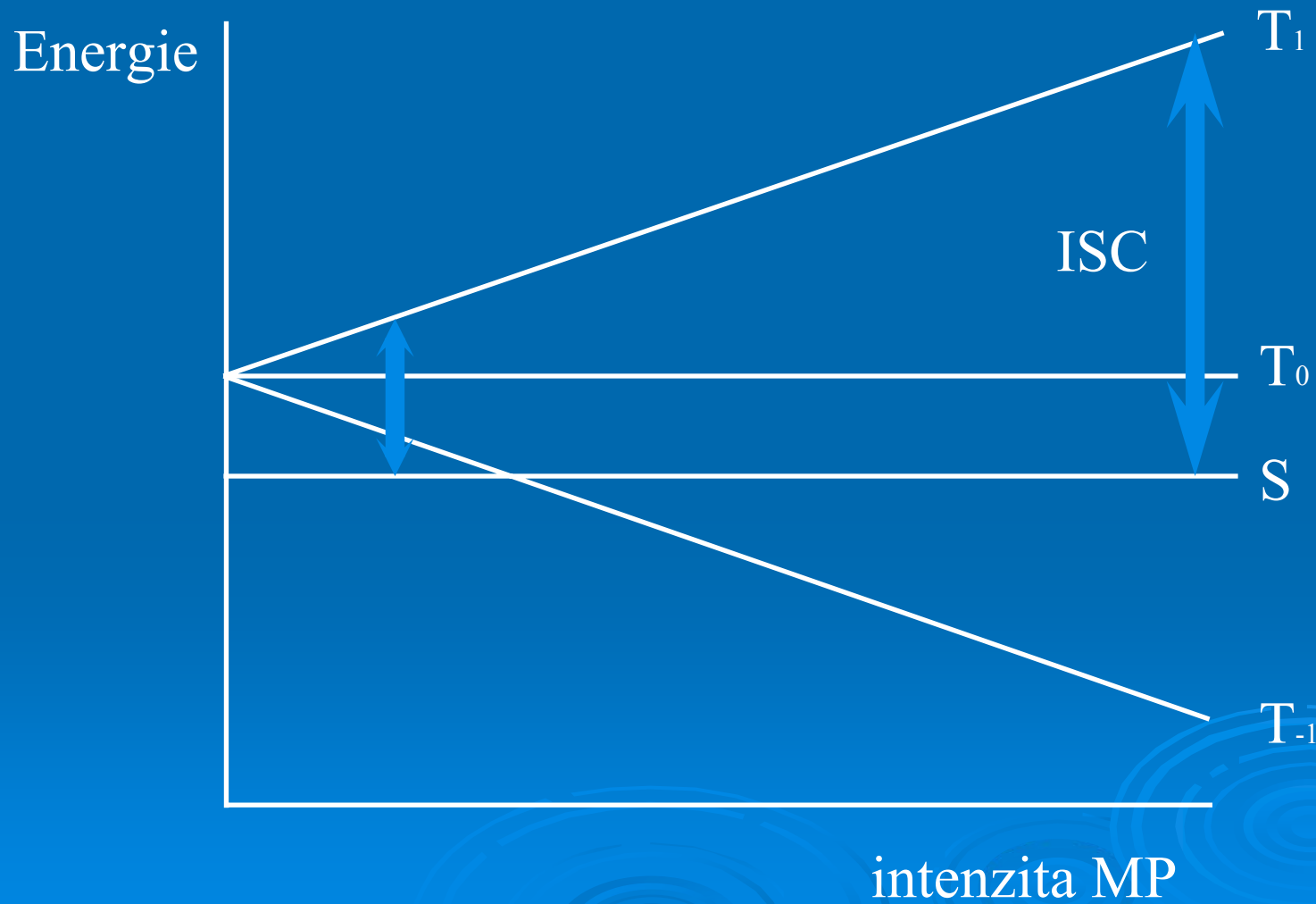
rozpad

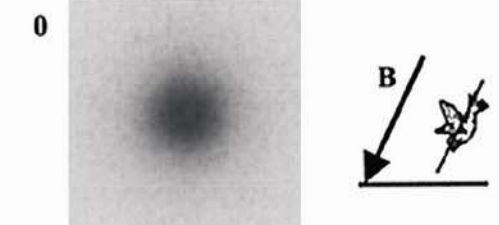
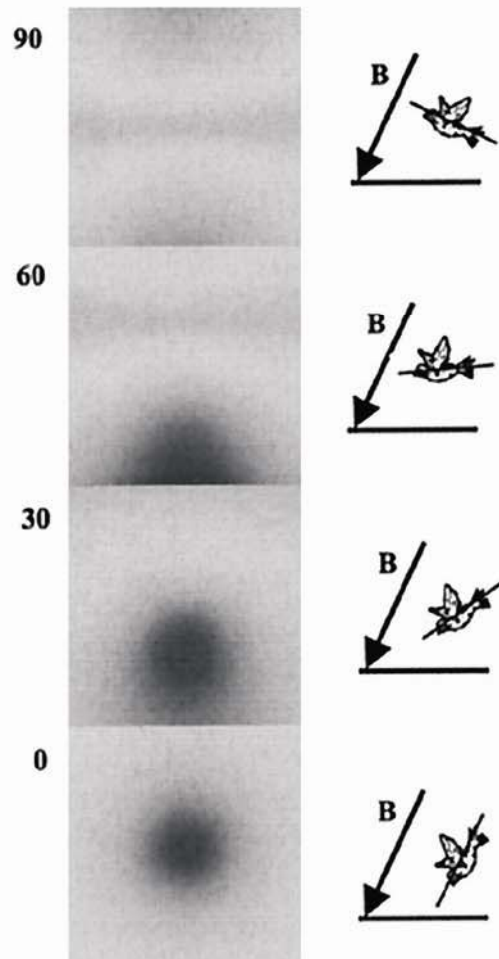
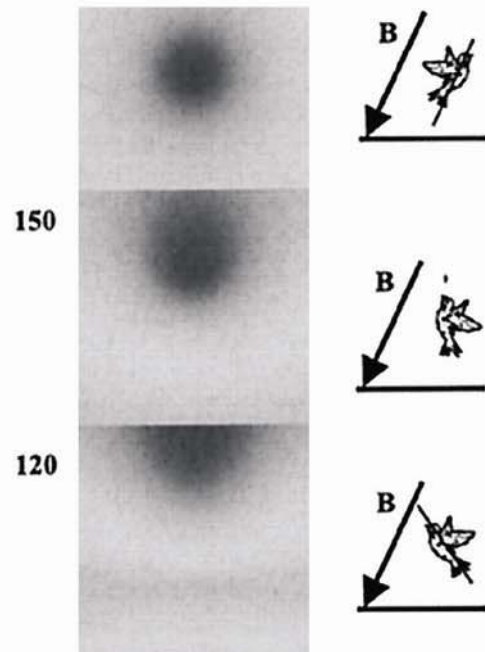
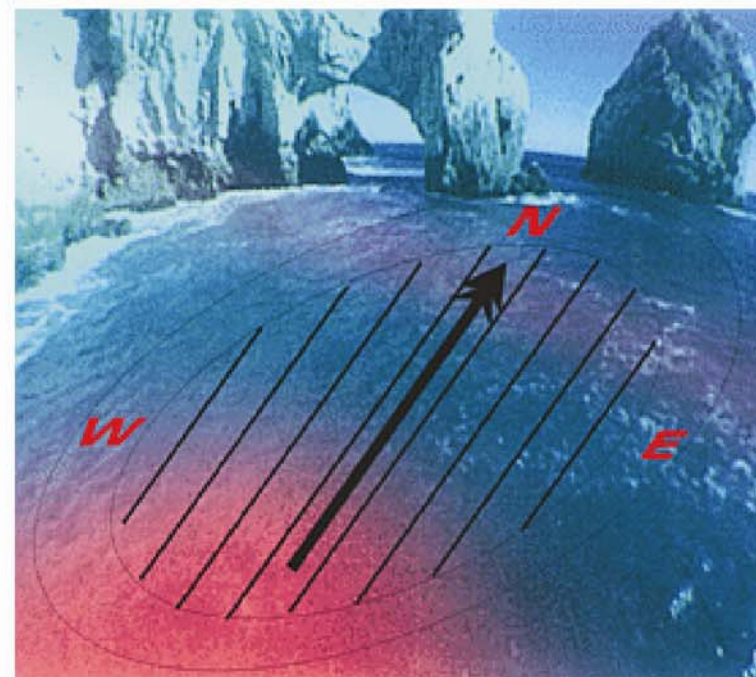
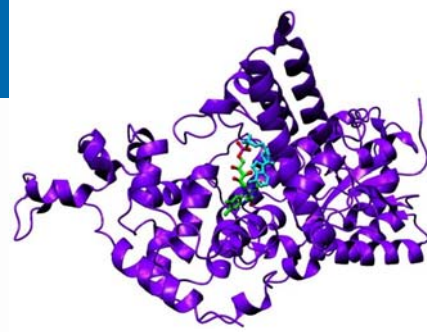
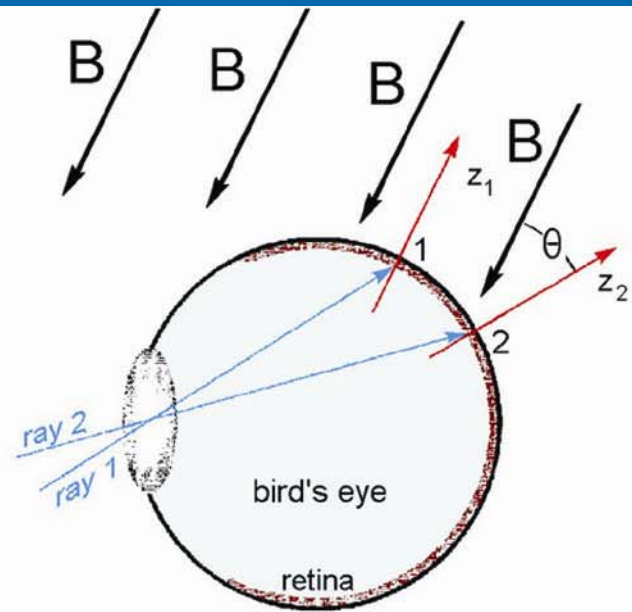
recepce světla

Opsin-cis retinal  
v základním stavu

Trans retinal + opsin

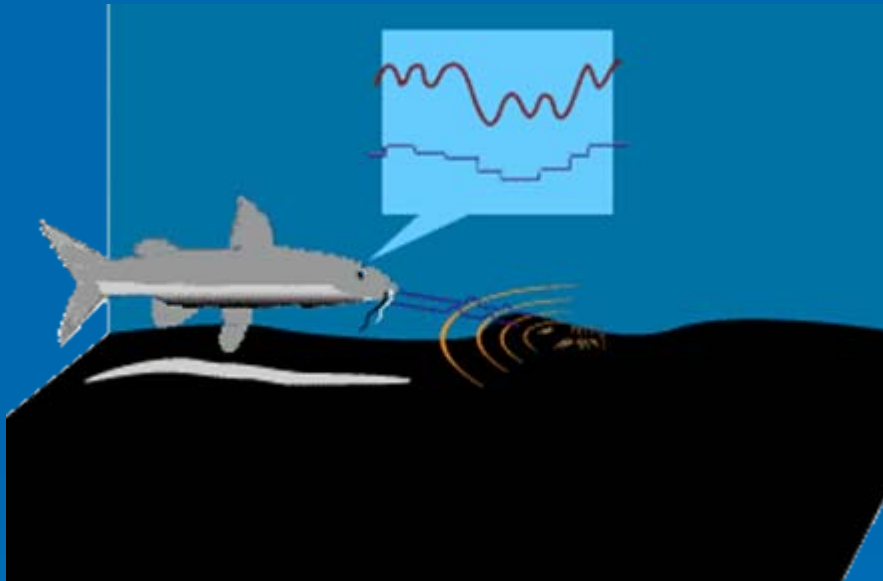
MP štěpí tripletní stavy  
a mění pravděpodobnost přeskoků







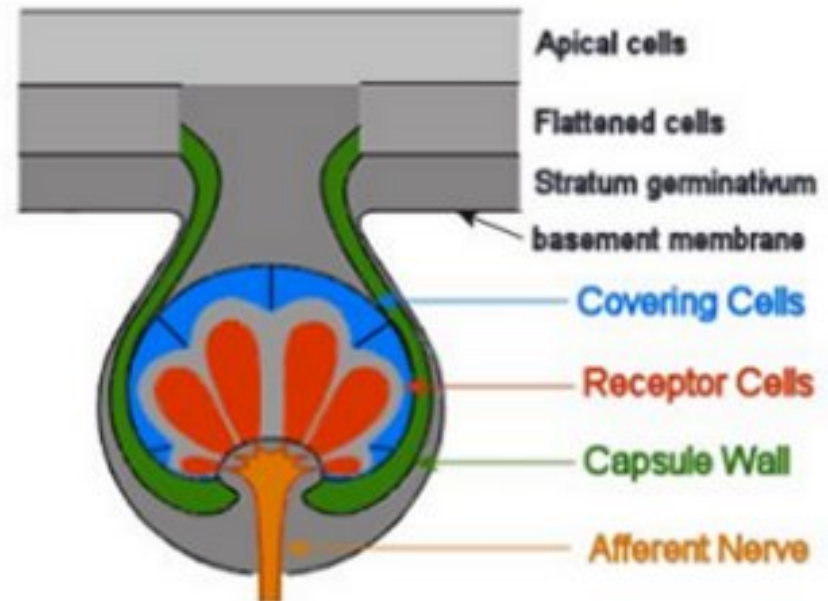
# Elektrorecepce



© 2003 Canadian Shark Research Lab



Lorenziniho ampule



- Pasivní – detekce napětí vznikající svalovou a nervovou činností

- Aktivní – podobá se echolokaci

- Navigace

- Detekce kořisti

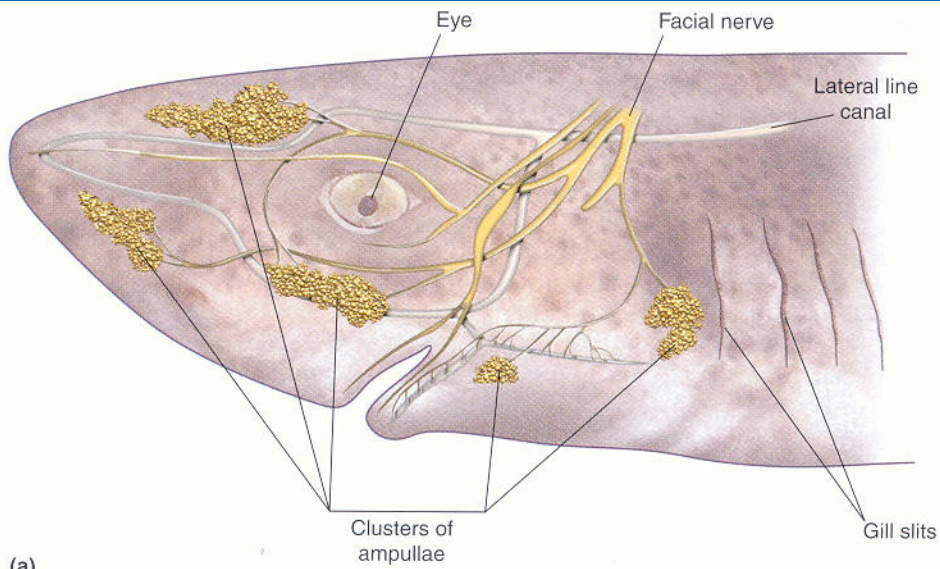
- Komunikace



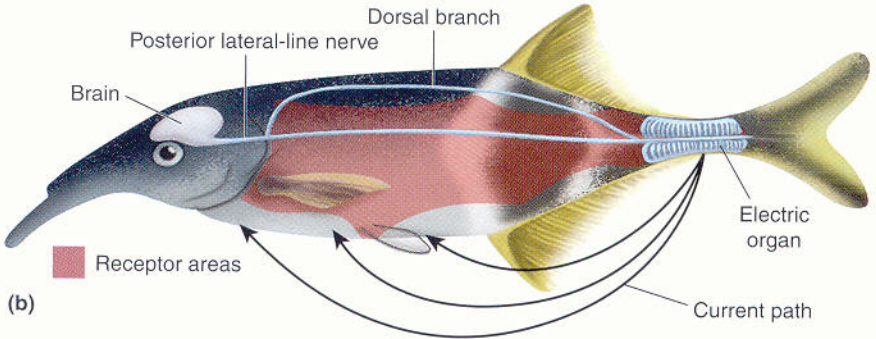
v kalných vodách

Lorenziniho ampule – změna potenciálu otevírá  $\text{Ca}^{2+}$  kanály a stimuluje eflux mediátoru

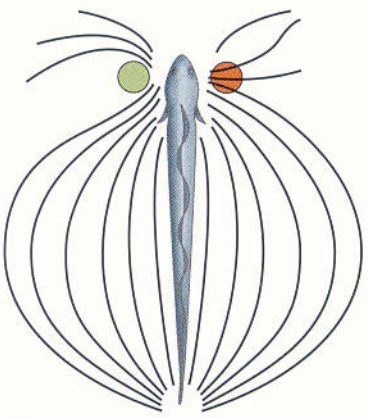




(a)



(b)



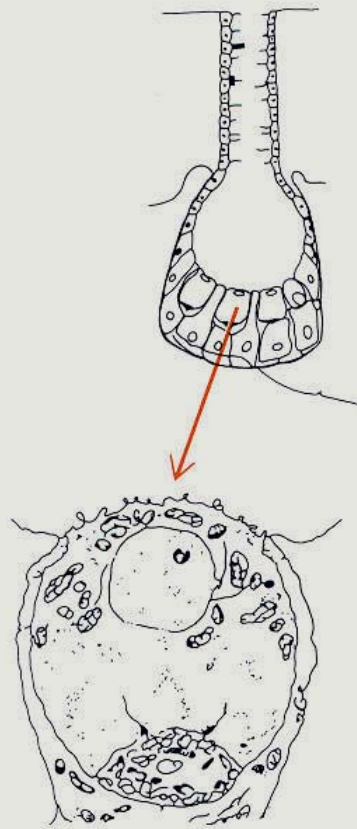
(c)

command center is  
 Gap junctions assure  
 maximizing signal in  
 pling of the medulla  
 tor that determines  
 of electrocytes capal  
 A few species, s  
 produce discharges  
 bodies, whereas in  
 range to millivolts to  
 or kill prey, whereas  
 for electrolocation a

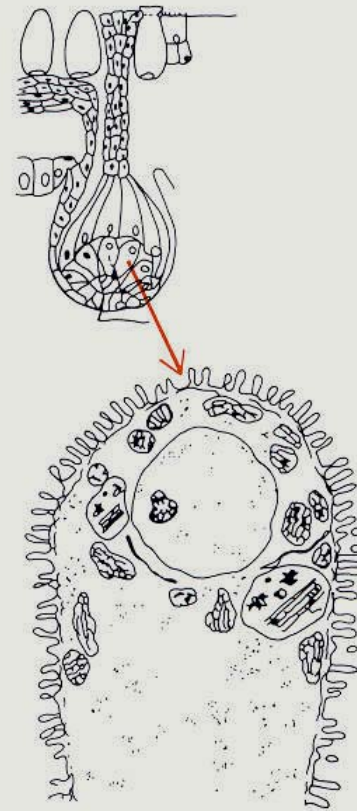
■ Some animals



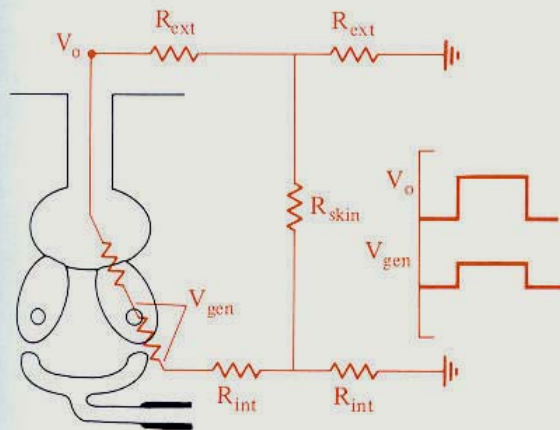
A



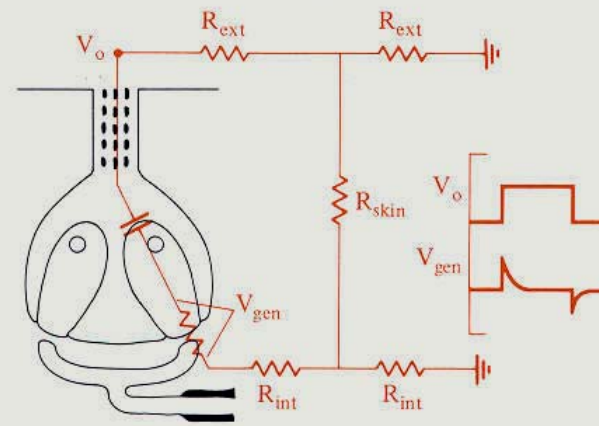
B



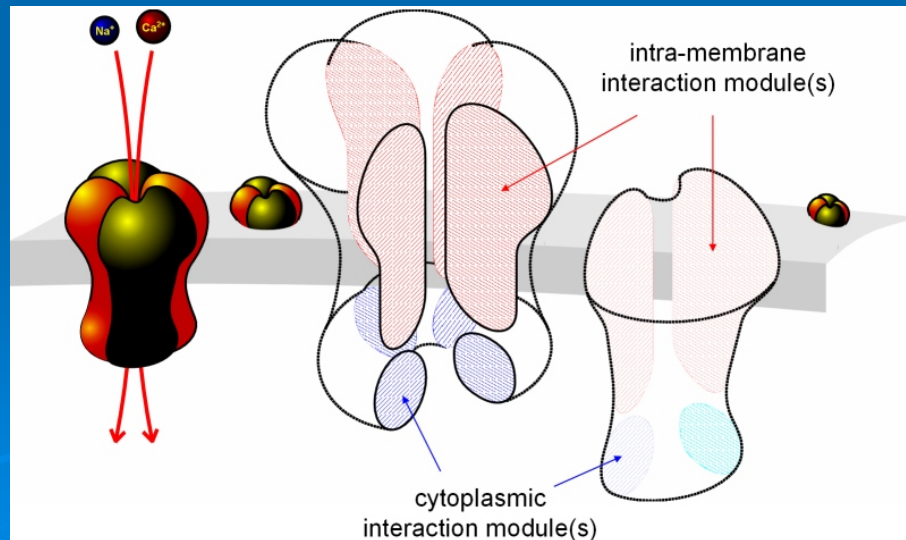
Tonic ampullary electroreceptor

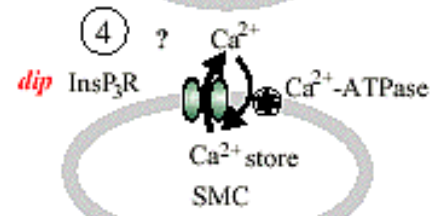
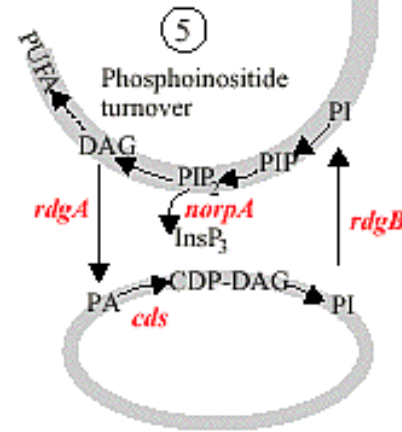
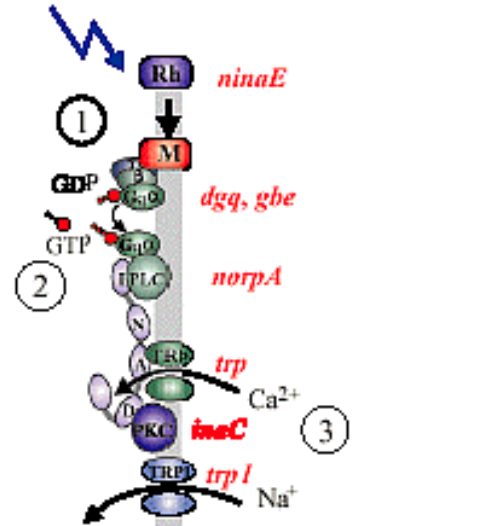
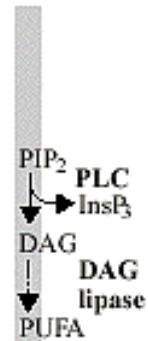
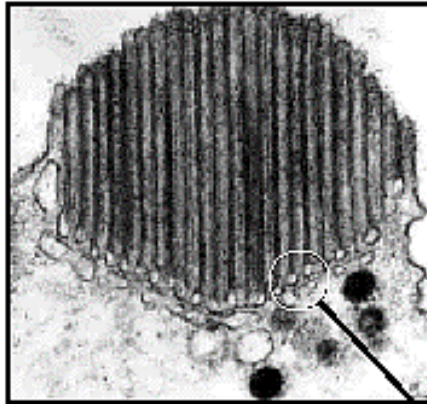


Phasic tuberous electroreceptor

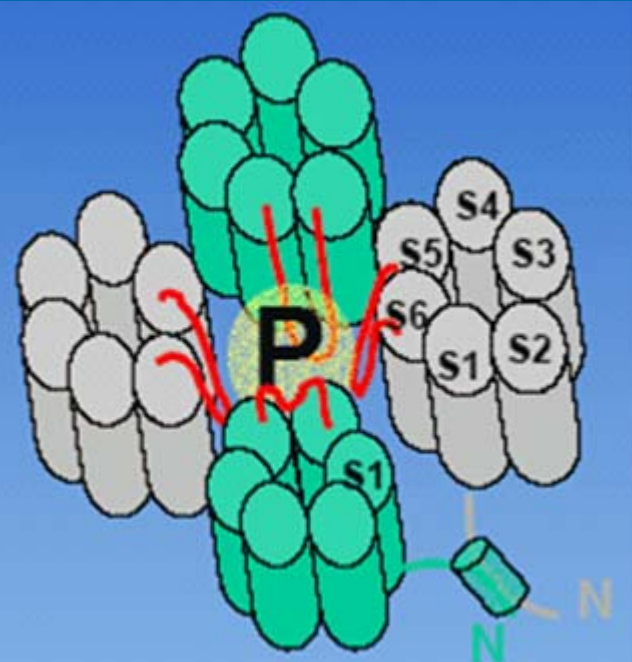
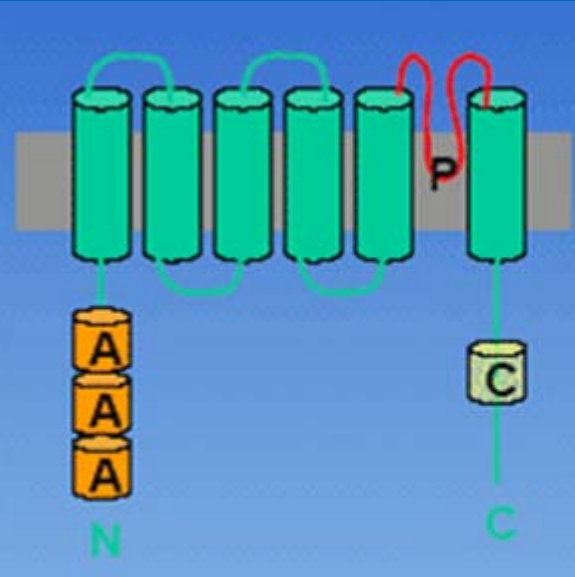
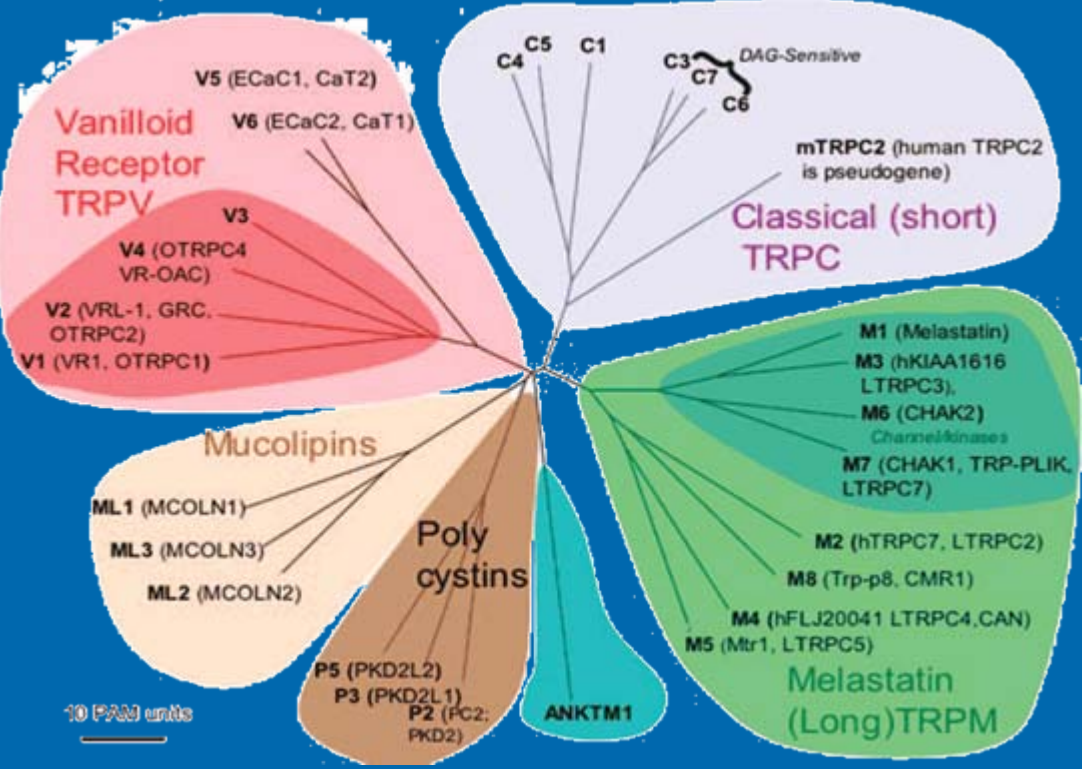


# TRP – transient receptor potential

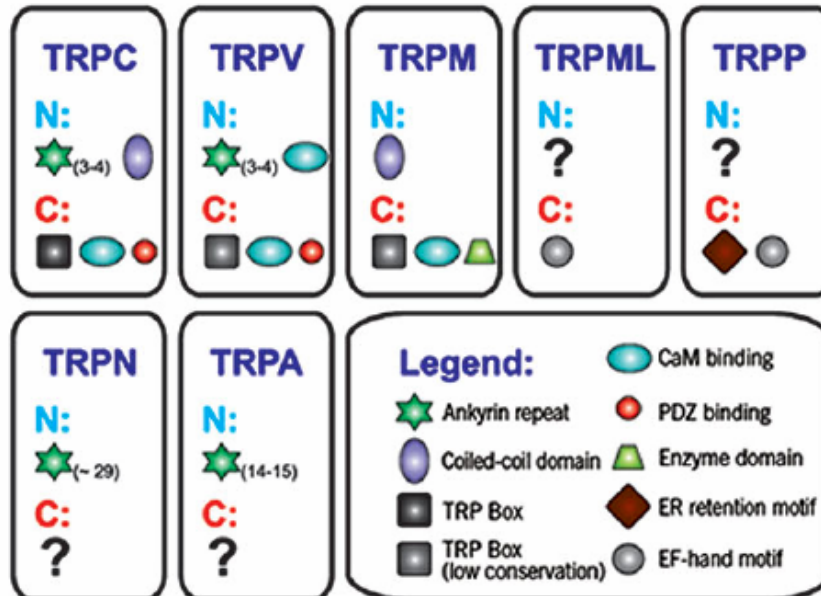
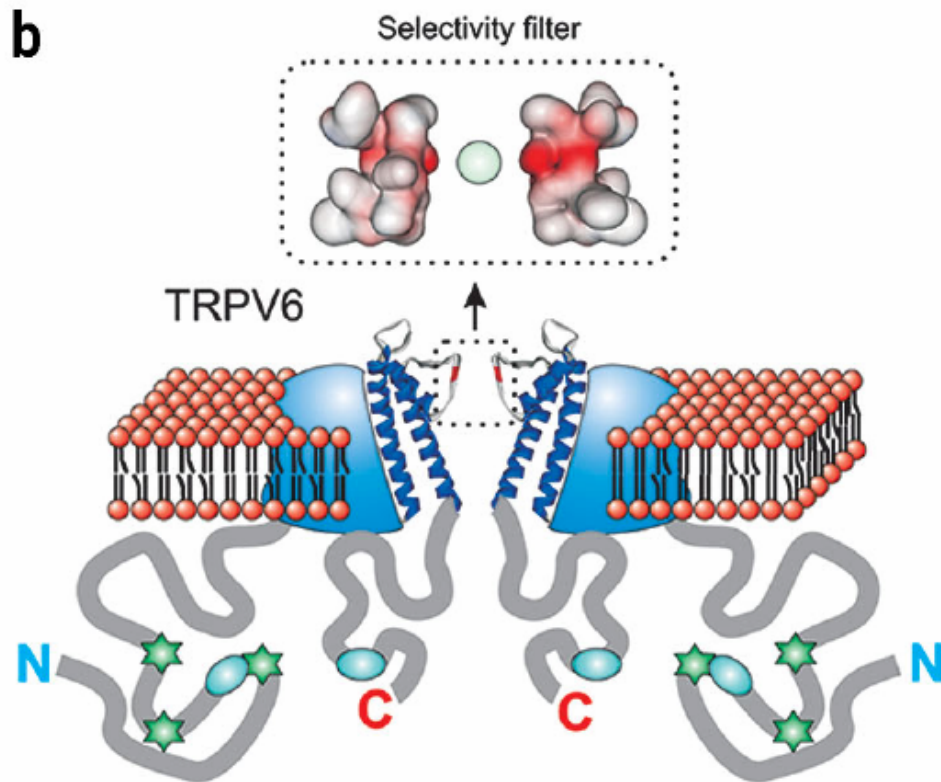


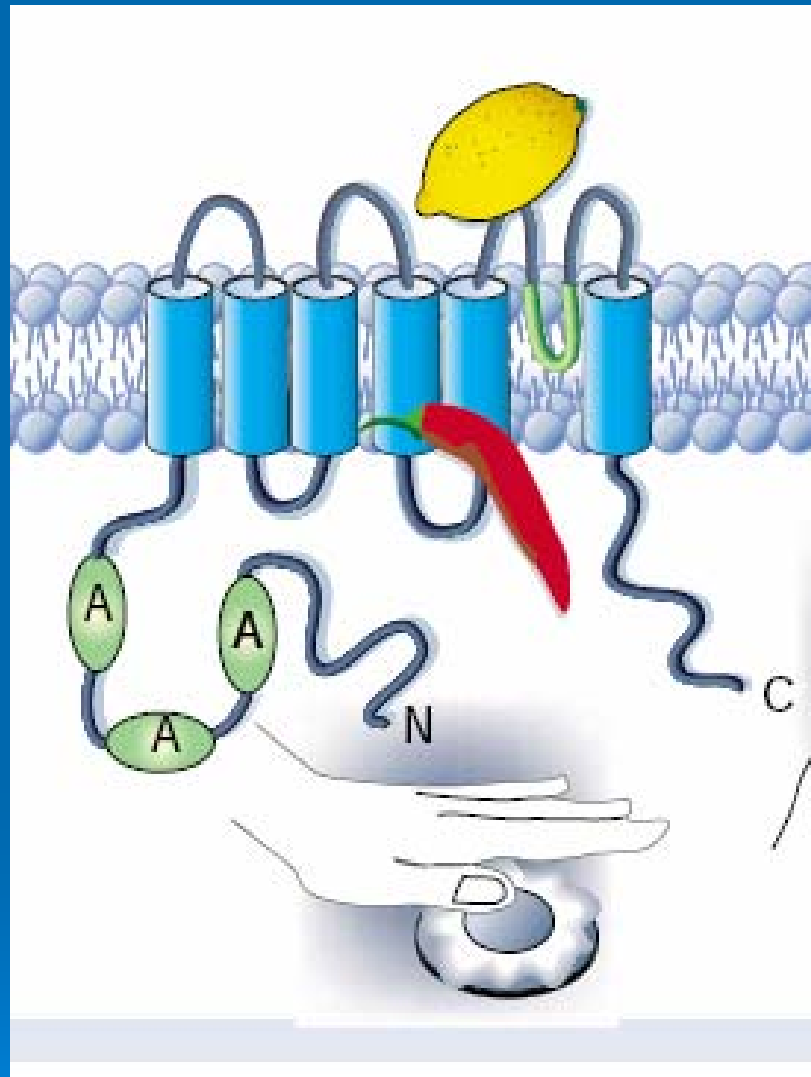


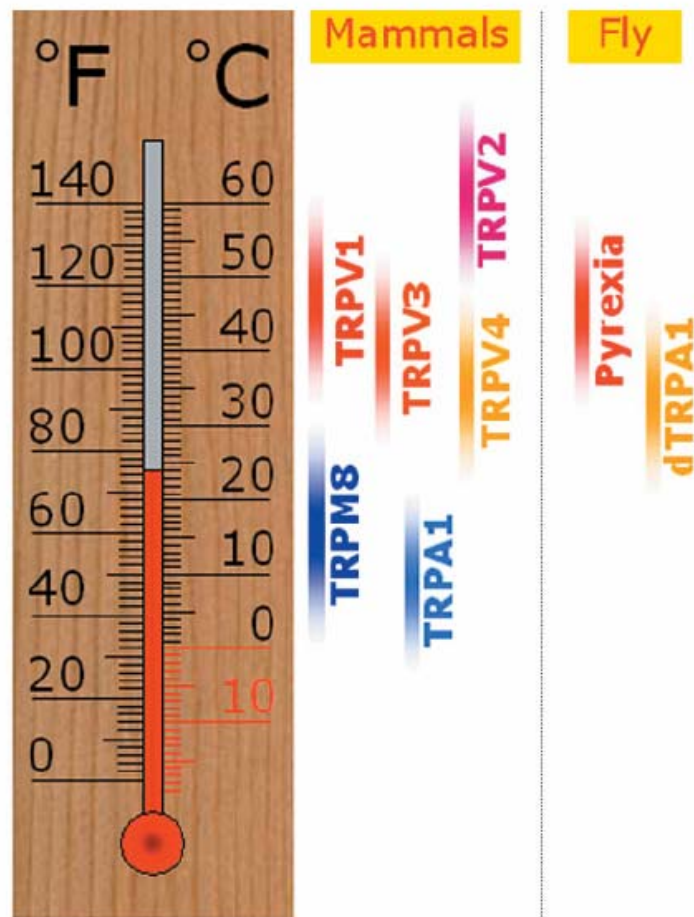
# TRP kanály



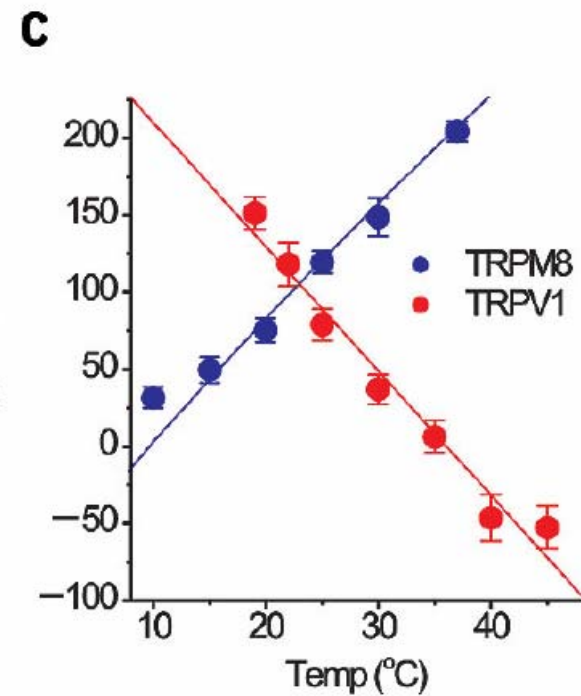
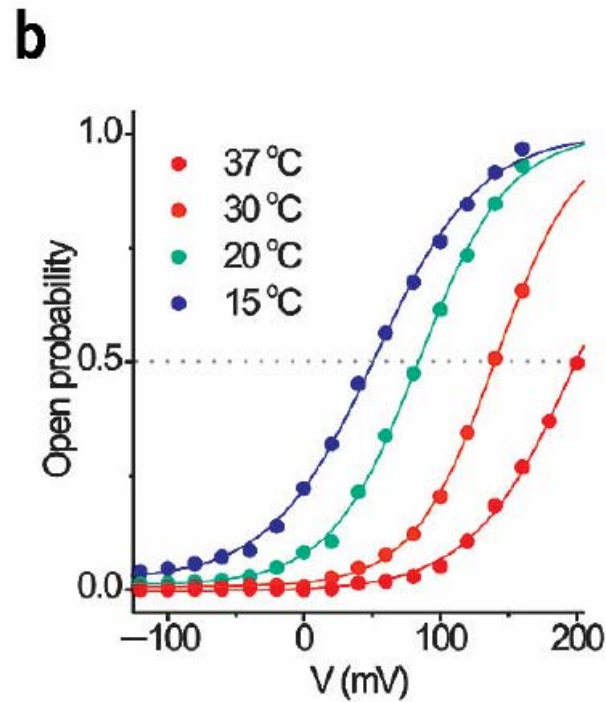
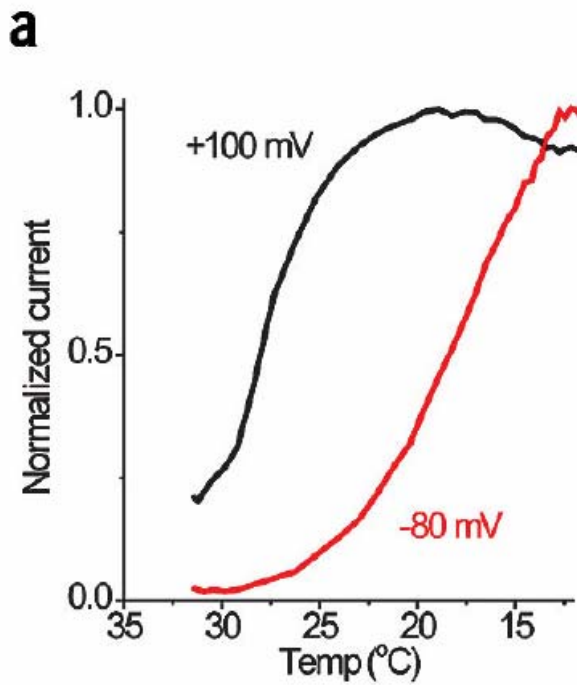


**b**



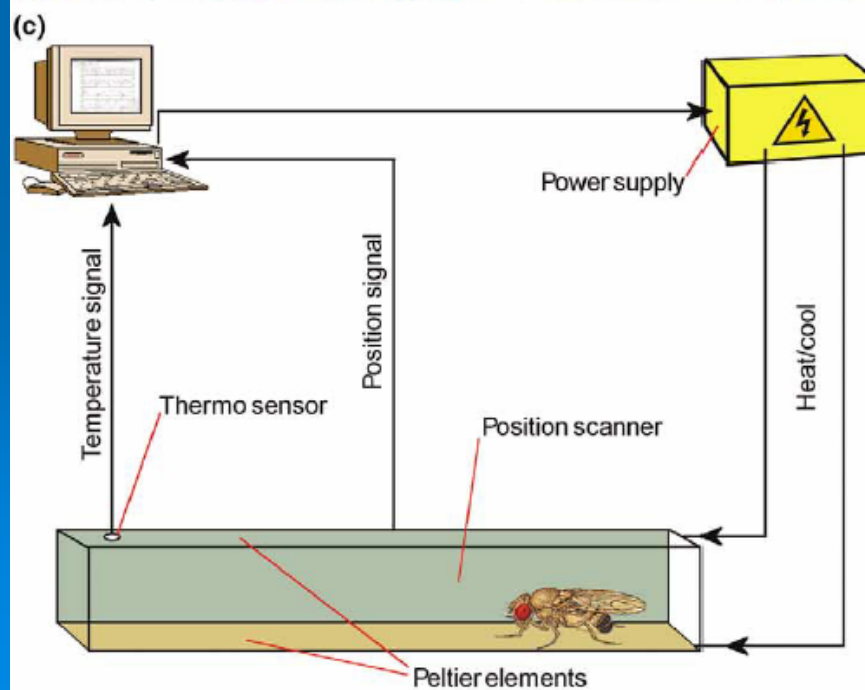


**Figure 2** Activation range of human and *Drosophila* thermoTRPs. Indicative temperature range for activation of mammalian and *Drosophila* thermoTRPs in heterologous expression systems. Note that TRPM8 and TRPA1 are activated upon cooling, whereas all other indicated channels are heat activated.

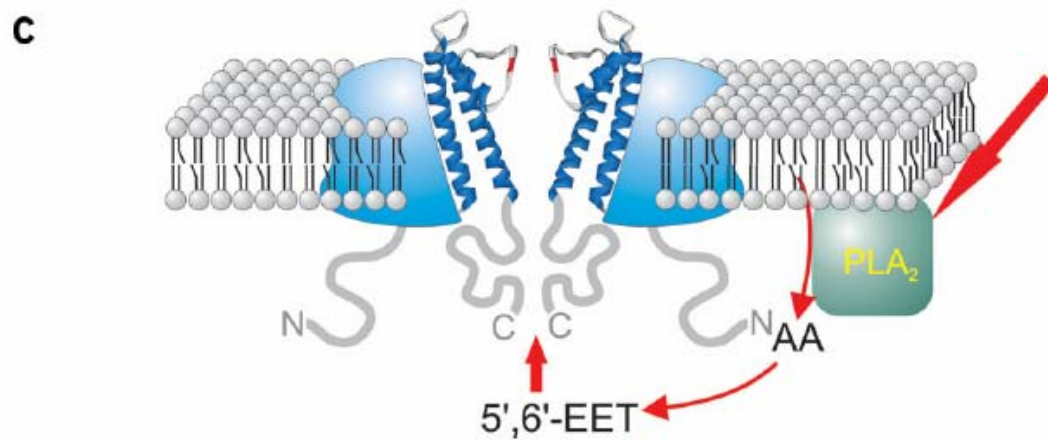
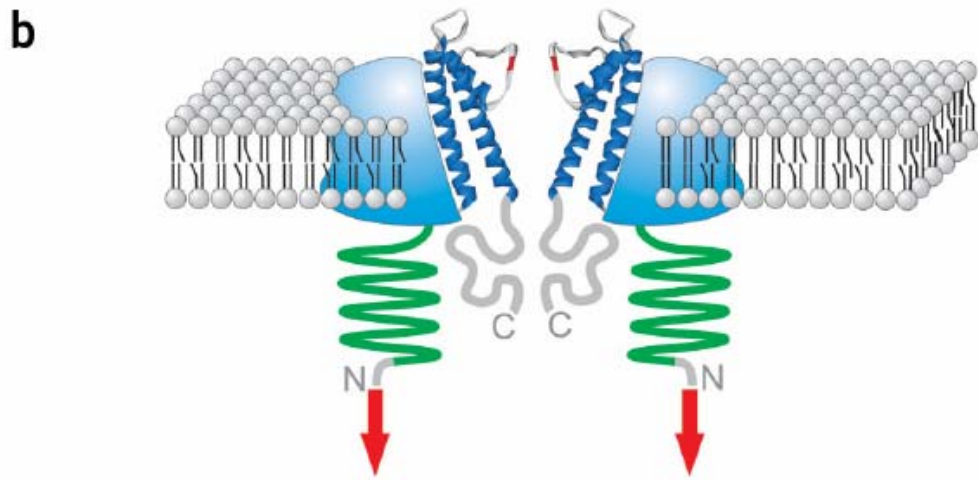
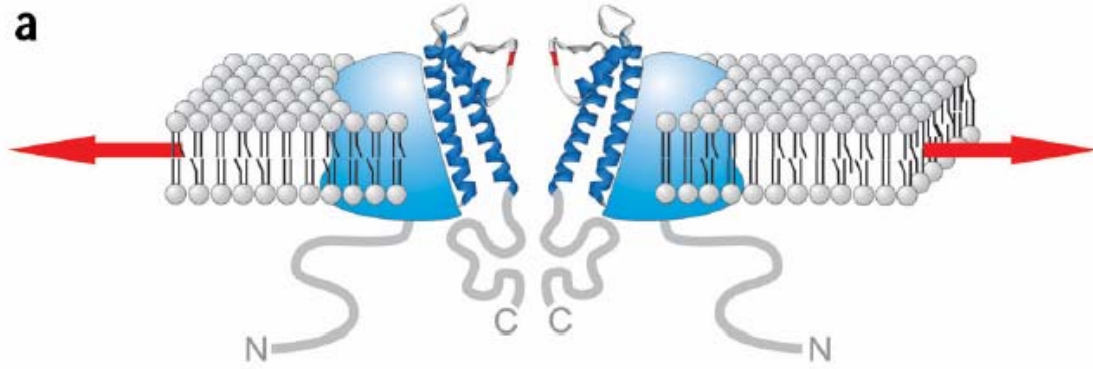


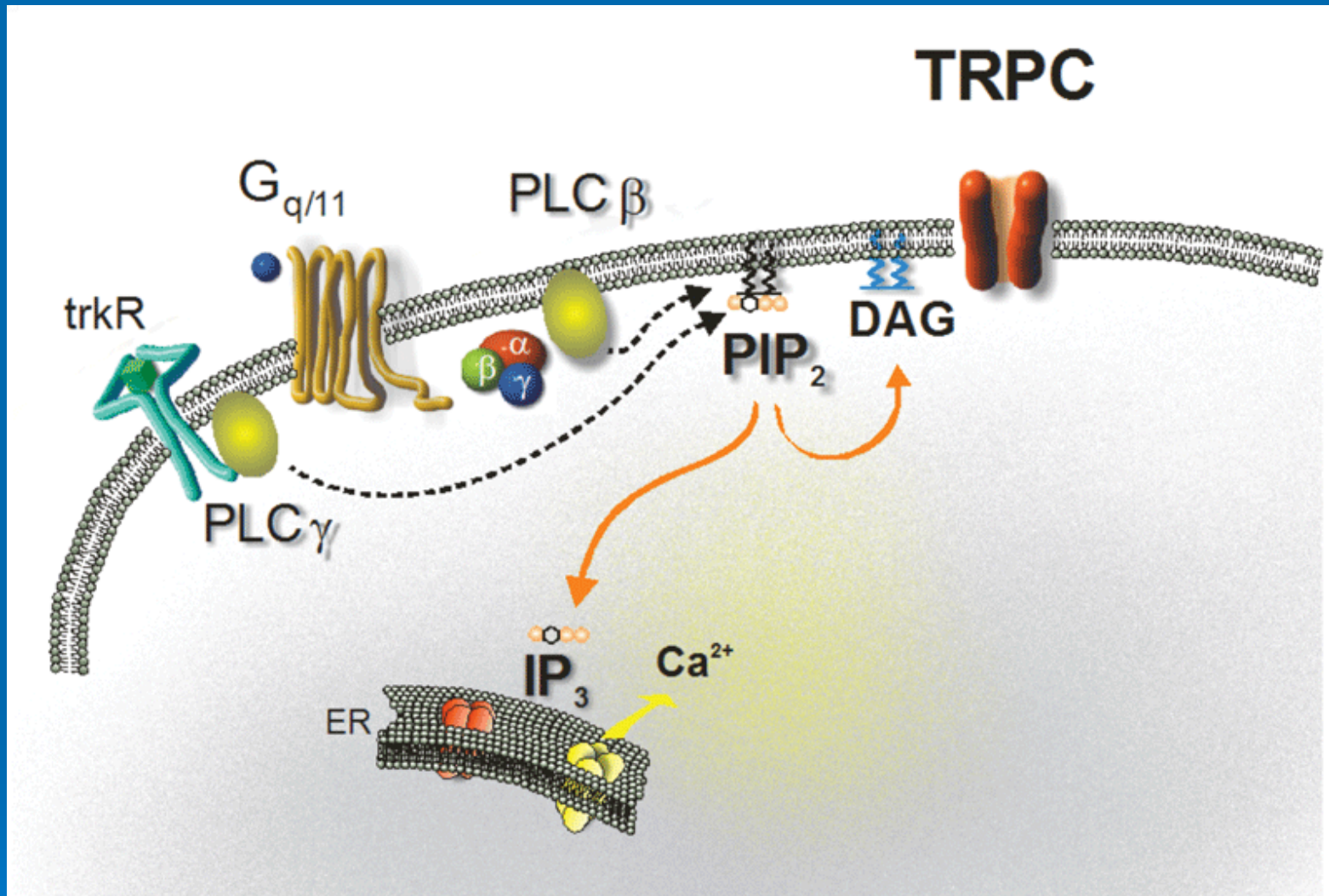
**Figure 3** Temperature sensitivity is voltage dependent. **(a)** Normalized TRPM8 current in response to cooling at +100 and -80 mV. Note that at depolarized potentials, current activation occurs at higher temperatures than at more negative potentials. **(b)** Plot showing the open probability of TRPM8 in function of voltage at the indicated temperatures. **(c)** Plot of the midpoint of the activation curves ( $V_{1/2}$ ) versus temperature for TRPV1 and TRPM8. Adapted from ref. 41.





mechanosensitivita





G protein typu G<sub>q/11</sub> aktivuje fosfolipázu C $\beta$  (PLC $\beta$ ). Fosfolipáza C $\gamma$  (PLC $\gamma$ ) je aktivována stimulací tyrozinkinázových receptorů (trkR). Aktivace fosfolipáz C vede k hydrolýze membránového fosfolipidu fosfatidylinozitol-4,5-bisfosfátu (PIP<sub>2</sub>) na rozpustný inozitol-1,4,5-trisfosfát (IP<sub>3</sub>) a membránově vázaný diacylglycerol (DAG). IP<sub>3</sub> aktivuje receptory v endoplazmatickém retikulu (ER), což vede k výlevu vápníku do nitra buňky.

- Na příkladu TRP lze vidět, jak vše souvisí se vším a studiem smyslových schopností poznáváme obecná pravidla molekulární komunikace.