

# Radiometric Dating – geochronologic units

## Relative dating

**Stratigraphic record can be subdivided according to a variety of criteria** including lithology (lithostratigraphy), fossils (biostratigraphy, ecostratigraphy), seismic profiles (sequence stratigraphy), magnetic polarity (magnetostratigraphy), event deposits (event stratigraphy).

### **Types of Rock units**

**1. Chronostratigraphic units** (time-rock units) - all strata in the world deposited during a given time interval (example: Upper Devonian Series)

**2. Biostratigraphic units** - stratigraphic units of rocks defined by their fossil content

**3. Lithostratigraphic units** - stratigraphic units (usually spatio-temporally restricted, three dimensional rock bodies) defined by lithology and/or physical and chemical characteristics of rocks (Group, Formation, Member, Tongue, Bed)

*(Event Stratigraphic Units* - Units based on short-term events that had widespread depositional effects, that is, events that produced an isochronous event deposit; useful in regional (basin-wide) stratigraphic correlations)

**4. Magnetostratigraphic units** (polarity time units) - stratigraphic units based on magnetic reversals of the Earth's poles

**5. Sequences** (Sequence Stratigraphy) - basin wide stratigraphic sequences that are separated by regional unconformities or their correlative conformities

**Table 1**

**Summary of Categories and Unit-Terms in Stratigraphic Classification\***

<b>Stratigraphic Categories</b>	<b>Principal Stratigraphic Unit-terms</b>	
Lithostratigraphic	Group Formation Member Bed(s), Flow(s)	
Unconformity-bounded	Synthem	
Biostratigraphic	Biozones: Range zones Interval zones Lineage zones Assemblage zones Abundance zones Other kinds of biozones	
Magnetostratigraphic polarity	Polarity zone	
Other (informal) stratigraphic categories (mineralogic, stable isotope, environmental, seismic, etc.)	-zone (with appropriate prefix)	
		<b>Equivalent Geochronologic Units</b>
Chronostratigraphic	Eonothem Erathem System Series Stage Substage (Chronozone)	Eon Era Period Epoch Age Subage (or Age) (Chron)

\* If additional ranks are needed, prefixes *Sub* and *Super* may be used with unit-terms when appropriate, although restraint is recommended to avoid complicating the nomenclature unnecessarily.

Príklad:	Chronostratigrafické jednotky	Geochronologické jednotky	Oblasťné litostratigrafické jednotky	Rôzno biostratigrafické jednotky
fanerozoikum	eonotem	eon		
mezozoikum	eratem	era		
jura	útvar	perioda	skupina -----	
lias	oddelenie	epocha	súvrstvie -----	rôzne druhy biostratigrafických zón
toark	stupeň	věk	člen -----	(subzóna)
Hildoceras bitrons	chronozóna	chron	vrstva (horizont)	(biohorizont)

Obr. 23a. Prehľad hlavných stratigrafických jednotiek. Chronostratigrafické a geochronologické jednotky si vzájomne zodpovedajú a ich obsah je presne stanovený. Oblasťné litostratigrafické a biostratigrafické jednotky sú nezávislé od iných stupníc a hierarchické usporiadanie je relatívne

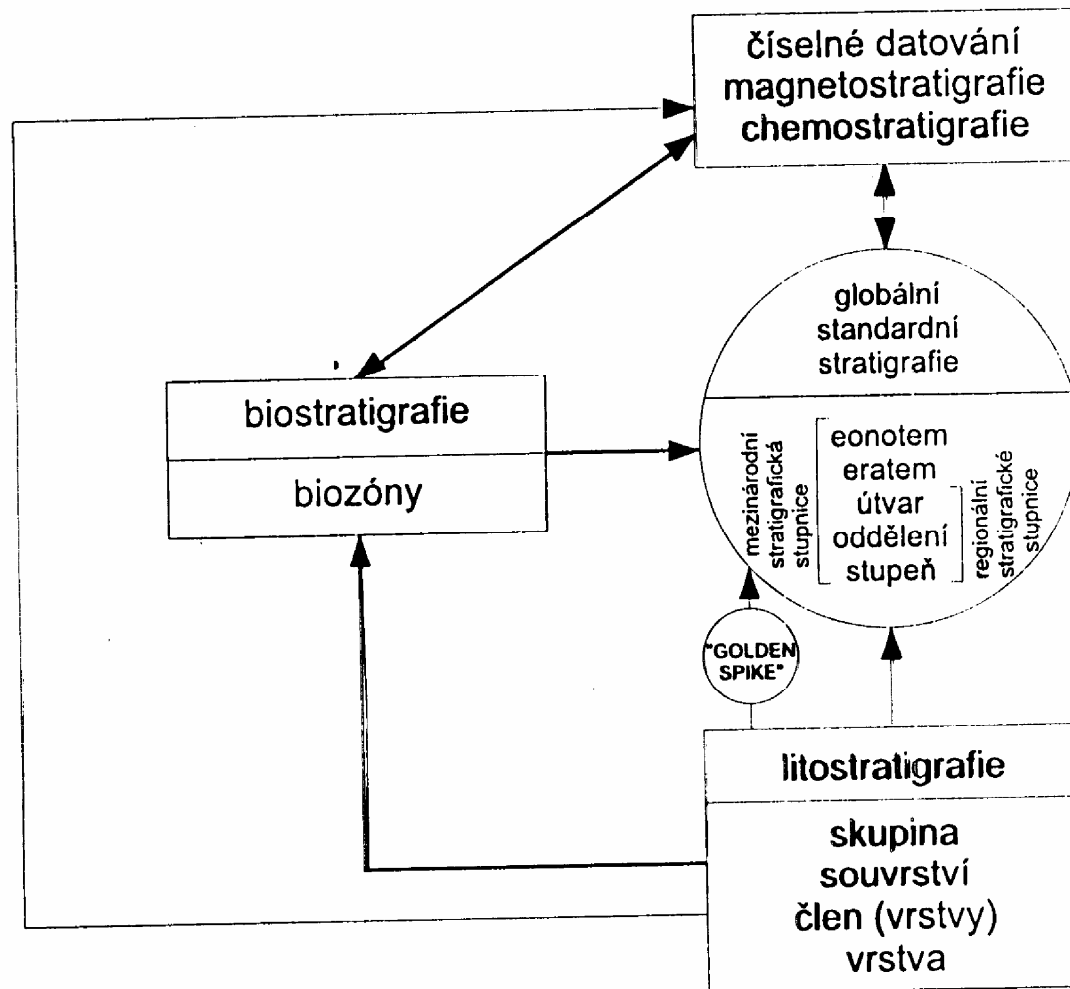

Obr. 5. Vztahy stratigrafických metod a vznik Mezinárodní stratigrafické stupnice (upraveno podle Holland, 1992).

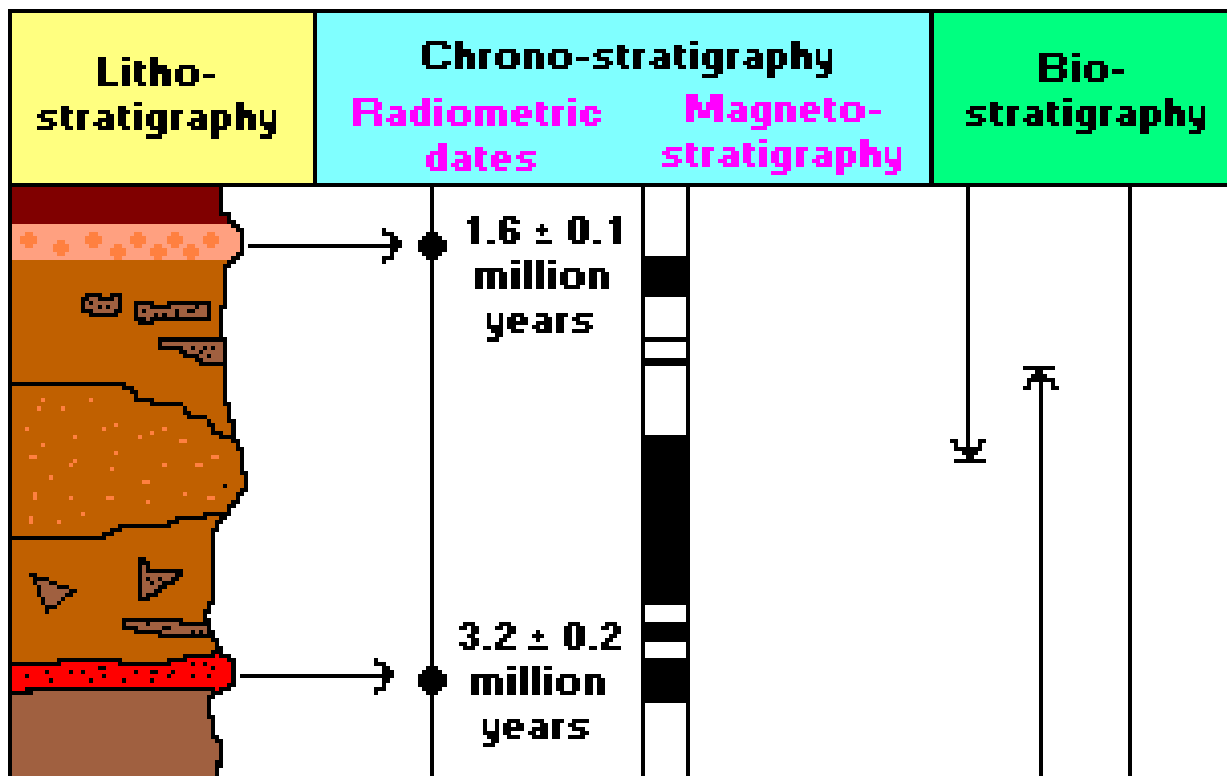

**Three essential components of the study of fossils in context:**  
**Lithostratigraphy • Chronostratigraphy • Biostratigraphy**

# 1. Lithostratigraphy

- a. description of unit properties (e.g. color, texture, particle shape, stratification, lithology)
- b. named after dominant grain size fraction
- c. hierarchy of lithostratigraphic units
  - (1) group: consists of 2 or more formations
  - (2) formation: a main unit that has considerable lateral extent
  - (3) member: a named unit within a formation; names are geographical

**Biostratigraphic Zones Biozones** - the most fundamental biostratigraphic units. A zone is a body of rock whose lower and upper boundaries are based on the ranges of one or more taxa

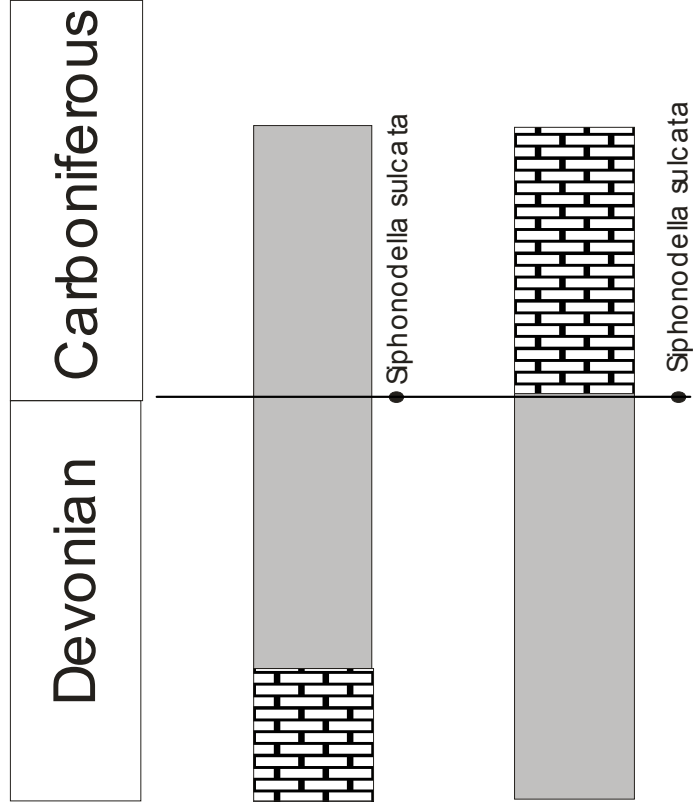



# Bio-Events

---

- First appearances of new species
- First appearances of new higher taxa
- Extinctions of species
- Mass extinctions of multiple taxa
- Bio-events are unique points in geologic time





# Index Fossils

---

- Some fossils are more useful than others for relative age determinations
- Fossils that are most useful are called **INDEX FOSSILS**
- What factors would maximize a fossil's usefulness? (i.e., What makes a good index fossil?)

## **Index Fossils Guide Fossils (other terms used: Zone Fossil, Index Fossil)**

A good index fossil must be:

1. Independent of environment
2. Fast to evolve
3. Geographically widespread
4. Abundant
5. Readily preserved
6. Easily recognised

**Examples:** Graptolites, Ammonites, Foraminiferans, Pollen, Nannoplankton

# What makes a good index fossil?

---

- Distinctive appearance/easy to recognize
- Short duration between first appearance and extinction (a.k.a. RANGE)
- Widespread geographic distribution (makes correlation possible across a wide area/multiple continents)





# Characteristics of Index Fossils

---

- Limited Stratigraphic Range
- Widespread Geographic Distribution
- Commonly Pelagic
- Or, tolerant of a wide variety of environments (found in many facies)

Grafické znázornění příkladů biozón  
(upraveno dle Chlupáč & Štorch 1997)

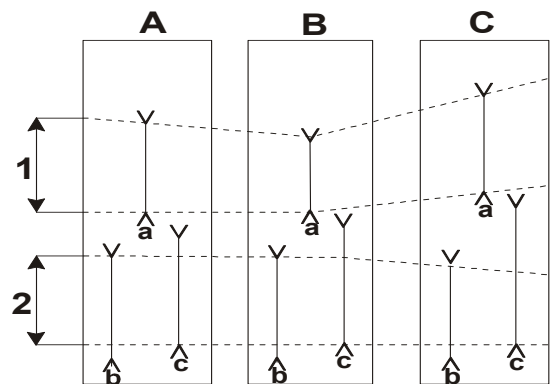

1 - zóna rozsahu taxonu a  
2 - zóna společného rozsahu taxonů b, c

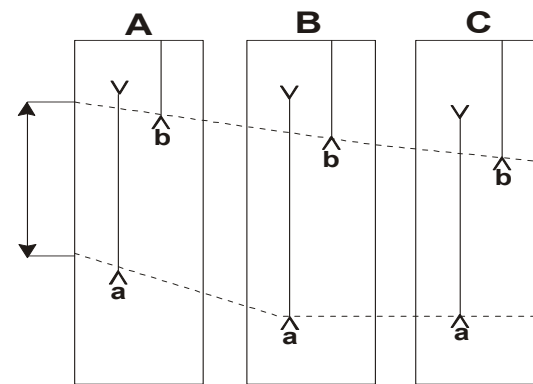

intervalová zóna mezi prvním výskytem taxonů a, b

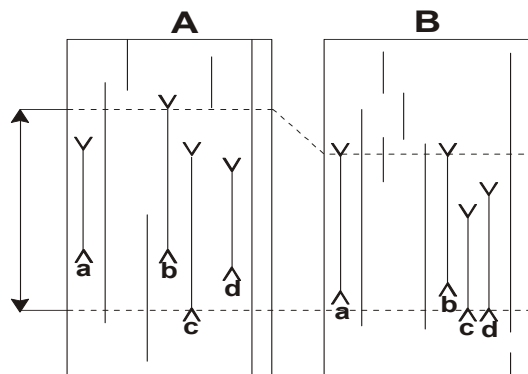

zóna rozsahu společenstva se čtyřmi vůdčími taxony (a, b, c, d)

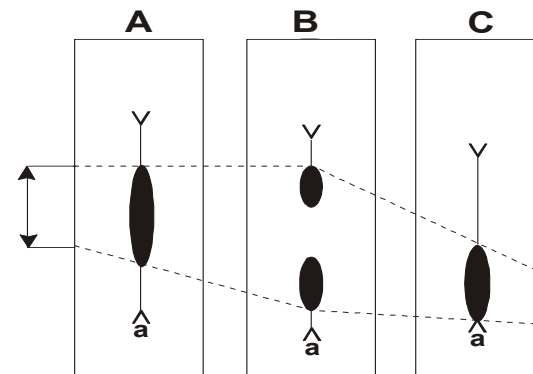

zóna hojného výskytu taxonu a

Vysvětlivky:

- A, B, C - stratigrafické profily
- a, b, c, d - vůdčí taxony (znaky)
- Y - nejvyšší výskyt taxonu (znaku)
- Λ - nejnižší výskyt taxonu (znaku)
- - hojný výskyt taxonu
- hranice biozón

# Units of the Geological Time Scale

---

Time-stratigraphic units-  
defined mainly on  
biostratigraphic criteria

- Erathem
- System
- Series
- Stage
- Zone (Biozone)

Consist of rocks and  
fossils

Geochronologic units –  
calibrated by radiometric  
dating

- Era
- Period
- Epoch
- Age
- Chron

Consists of time intervals  
- years before present



# Geological time scale

---

- Commission on Stratigraphy of the International Union of Geological Sciences
- Time-stratigraphic units defined by internationally agreed boundary stratotype sections

# Definition of the Time Scale

---

- Each unit's base defined by a particular stratigraphic level at **one type section**
  - Global Stratotype Section and Point (GSSP)
  - the "Golden Spike"
- That stratigraphic level is marked by first or last appearance of one or more "index" taxa – base of a zone
- Other sedimentary rocks of that age determined by biostratigraphic (and other!) correlation with that type section
- Many time-rock units are still not formally defined





---

gic boundaries. GSSPs have been defined mainly on the basis of biostratigraphic guiding criteria, but magnetic polarity reversals and chemostratigraphic and cyclostratigraphic horizons are now playing an important role. Most primary guiding criteria



## Requirements for a GSSP

---

- Continuous sedimentation.
- Completeness of exposure.
- Thick enough to work with.
- Abundant and diverse fossils.
- Favourable facies
- Structurally simple, no metamorphism, etc.
- No unconformities.
- Amenable to  
magnetostratigraphy/geochronometry



---

# Index Fossils and International Stratotypes

The Case of the Silurian –  
Devonian Boundary

# Definition of the S-D Boundary

---

Stratotype:  
Klonk, near  
Suchomasty,  
Czech Republic



# S-D GSSP

---



- GSSP = Global Stratotype Section and Point
- First appearance of *Monograptus uniformis uniformis*
- Bed 20
- Klonk, Czechia



# Index Fossils and the Silurian - Devonian Boundary

---



- Graptolites \*
- Conodonts \*
- Chitinozoans \*
- Trilobites
- Brachiopods
- Cephalopods

