

Symetrie – Platonovská tělesa

Octahedron

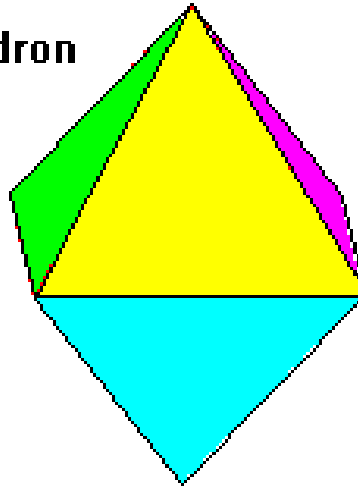

Cube
(Hexahedron)

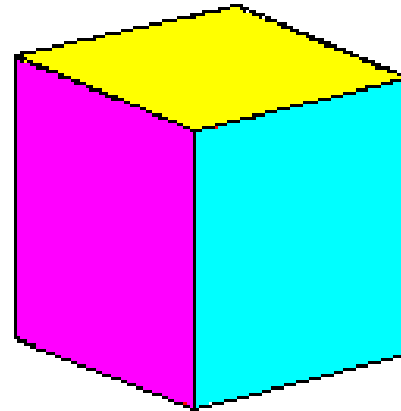

Tetrahedron

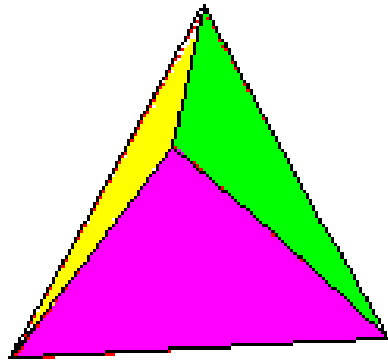

Icosahedron

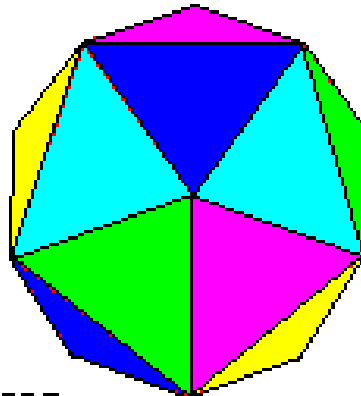

Dodecahedron

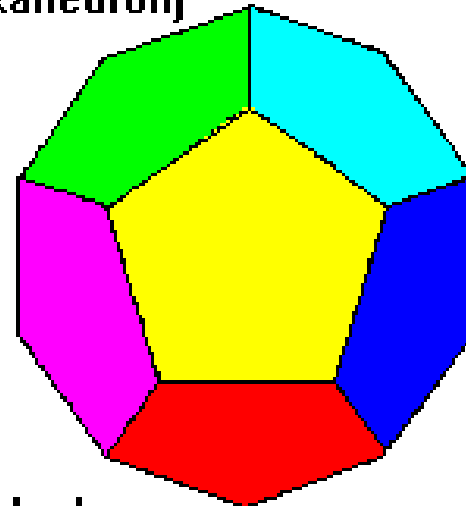

Symetrie

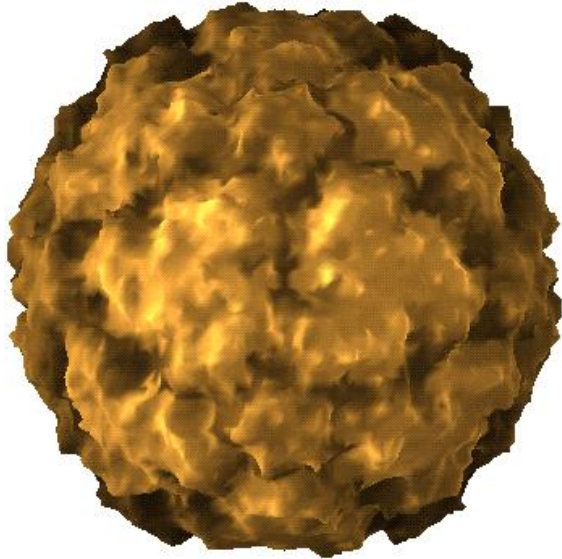

Virus rýmy

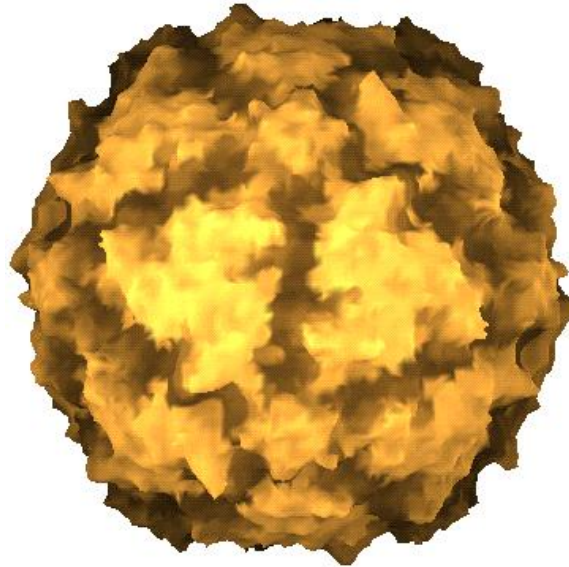
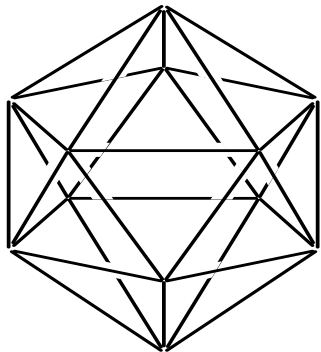

Virus obrny

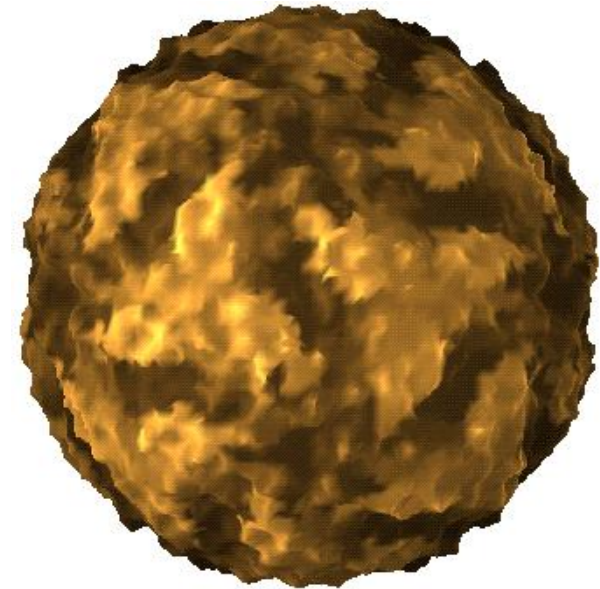
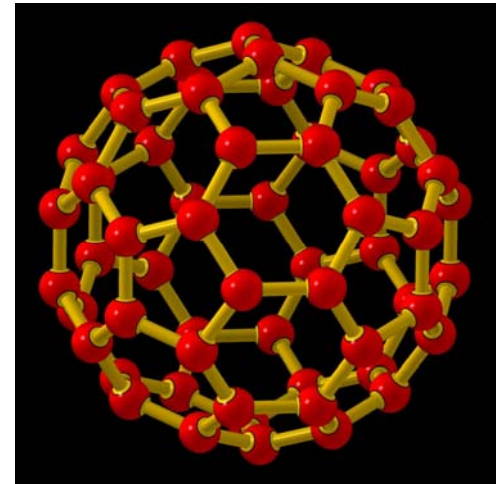

Virus slintavky a kulhavky

Symetrie molekul

Jak jsou atomy v molekule uspořádaný = ekvivalentní atomy

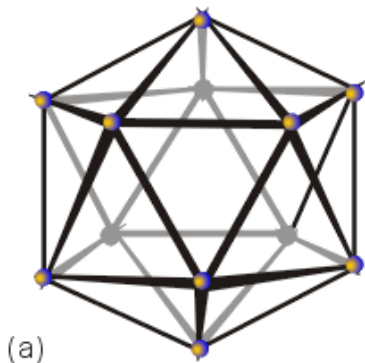
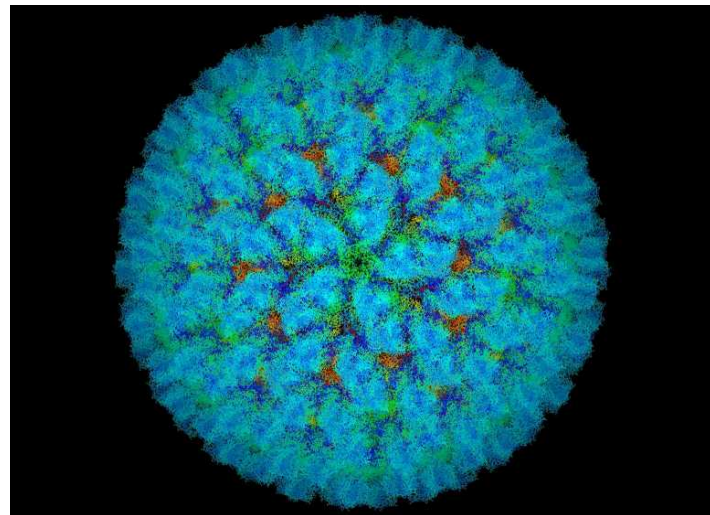
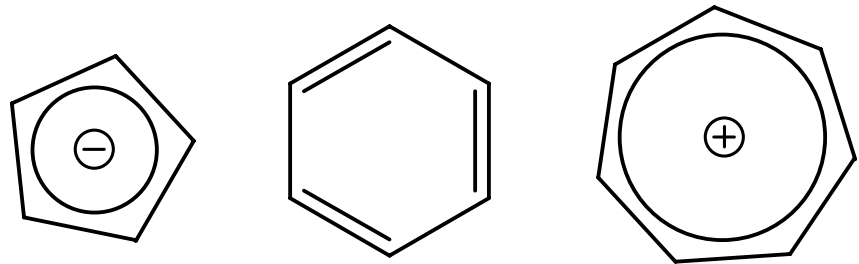
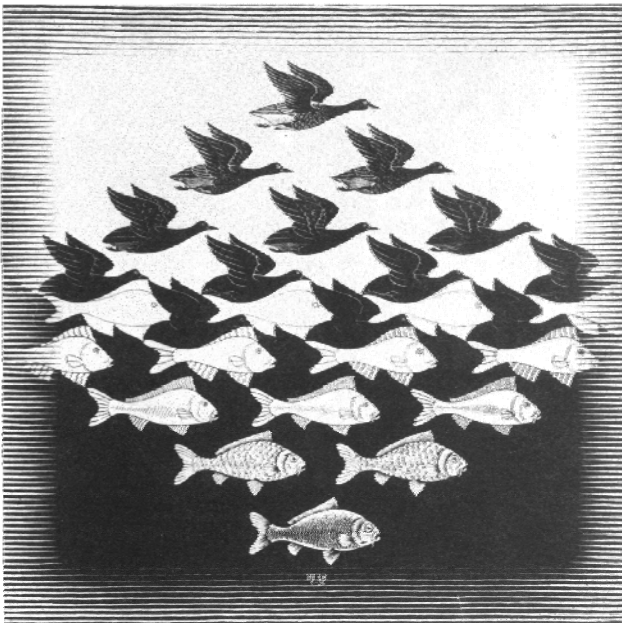

Prvky a operace symetrie

Značka	Prvek	Operace	Pozn.
E	Identita	Identita	Bezezměny, (= 1)
i	Střed symetrie (inverze) BOD	Inverze	Převrácení přes střed
C_n	Rotační osa PŘÍMKA	Pravá (vlastní) rotace	Otočení o úhel 360/n
σ	Rovina symetrie, zrcadlová ROVINA	Zrcadlení, reflexe	Zrcadlení přes rovinu
S_n	Zrcadlově-rotační osa PŘÍMKA	Nepravá (nevlastní) rotace	Otočení o úhel 360/n následované zrcadlením

Střed symetrie

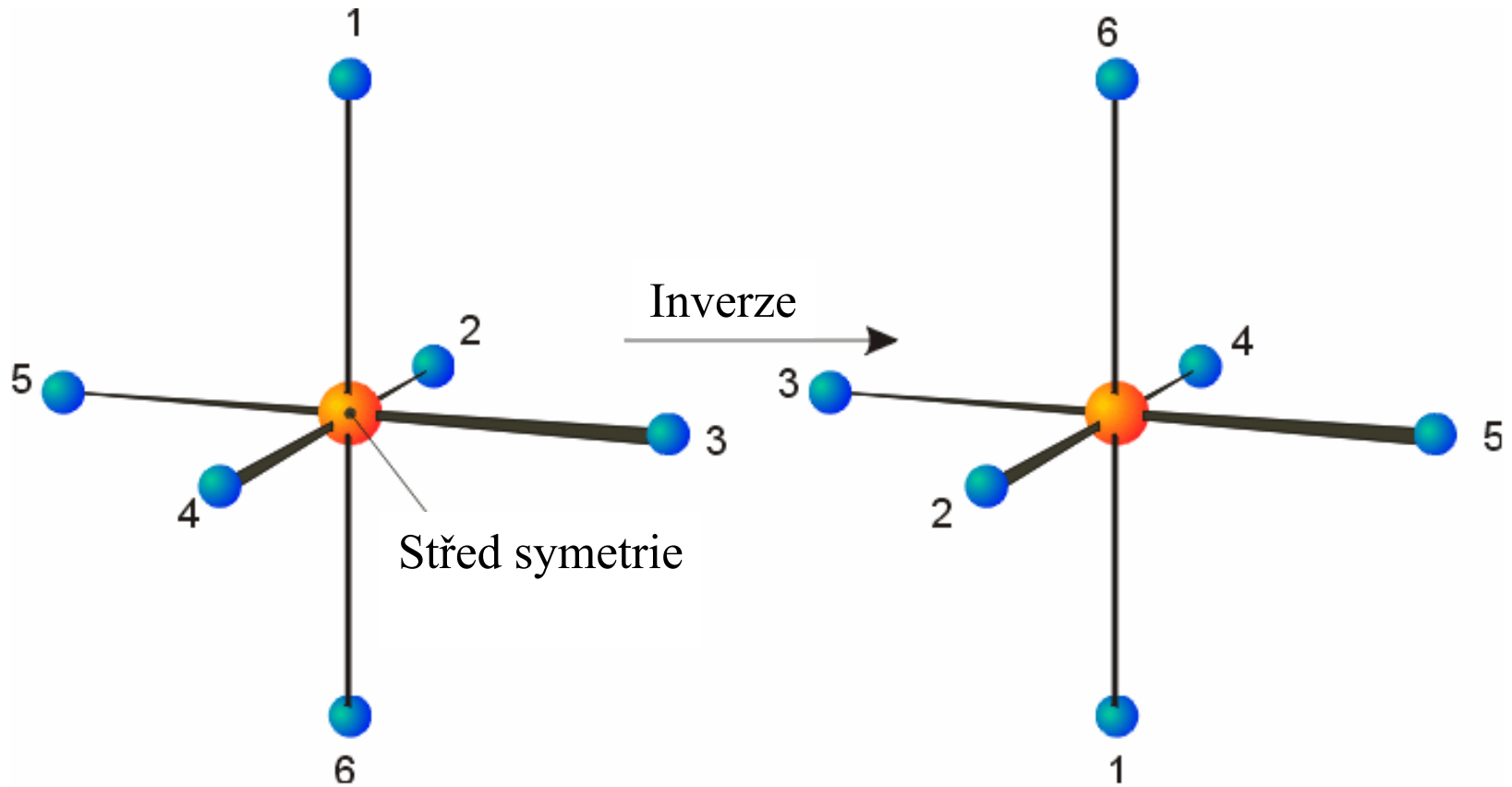

Střed symetrie

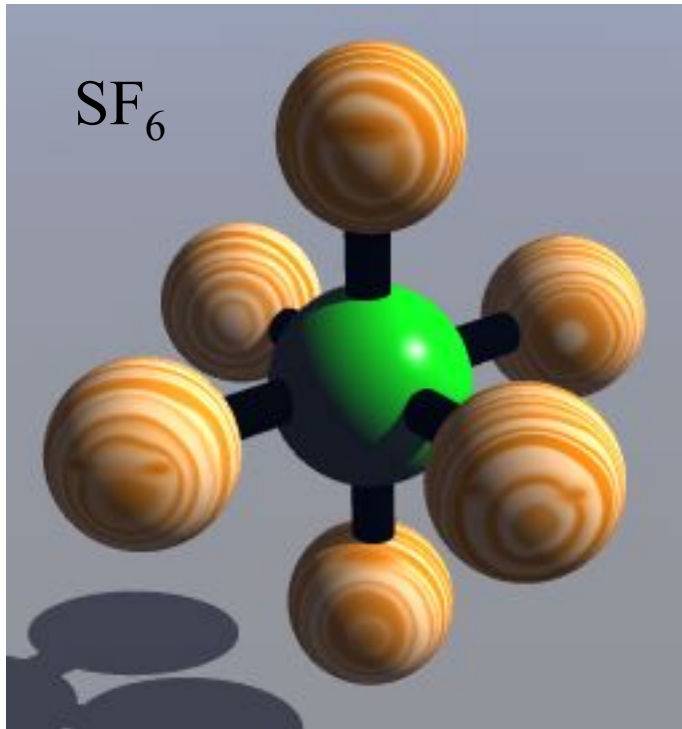

S = střed symetrie

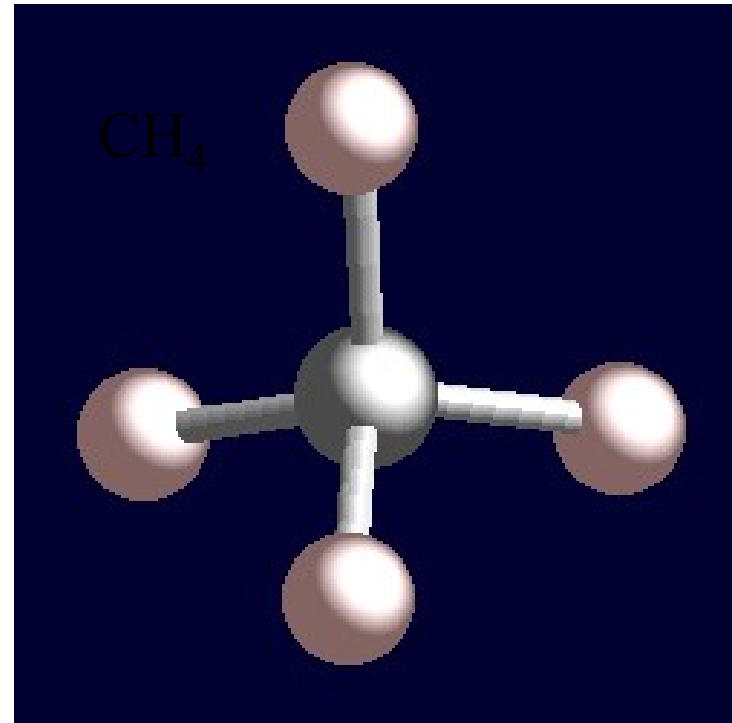

Nemá střed symetrie

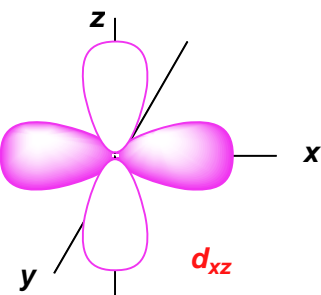
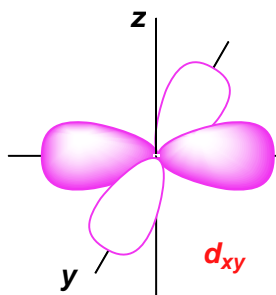
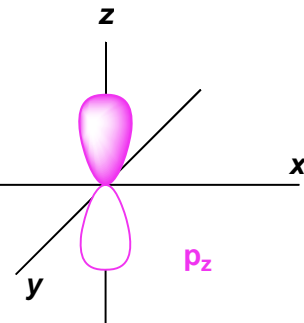
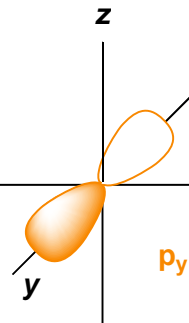
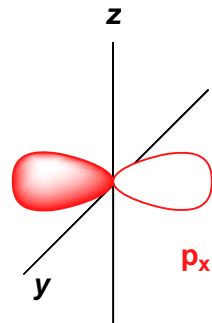
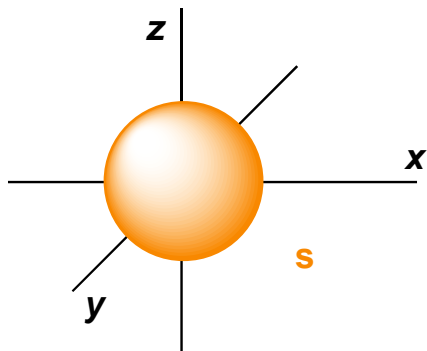

Orbitaly

s a d **mají** *i* (střed symetrie)

p a f **nemají** *i* (střed symetrie)

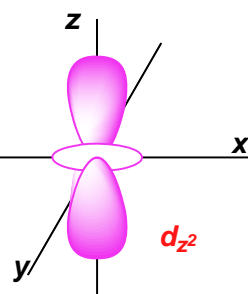
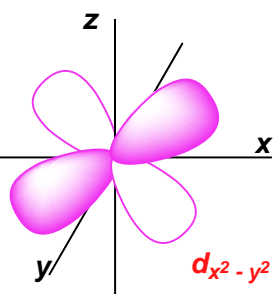
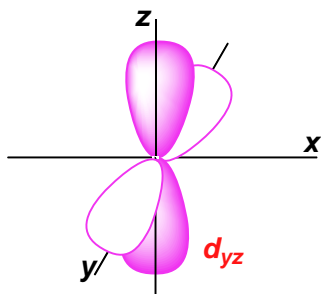

Rotační osa C_2



Rotace o úhel $360/n$. Vzniklá situace je nerozlišitelná od výchozí.

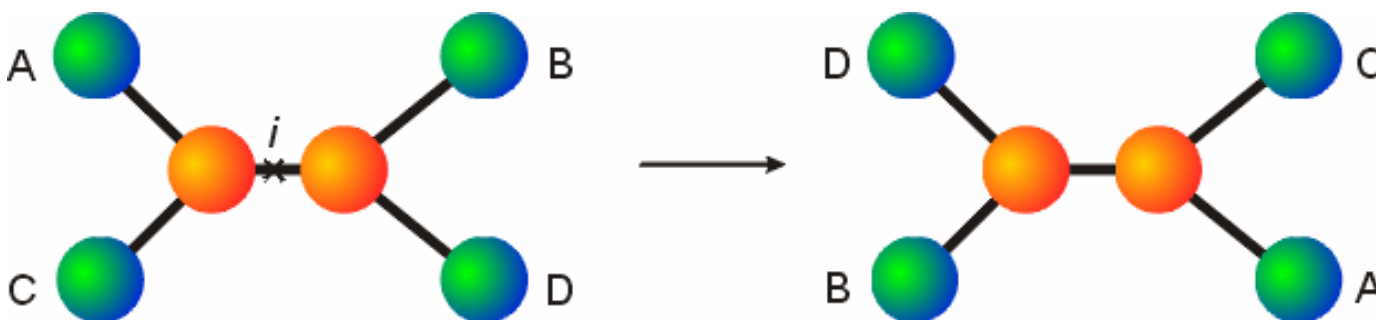

(a)

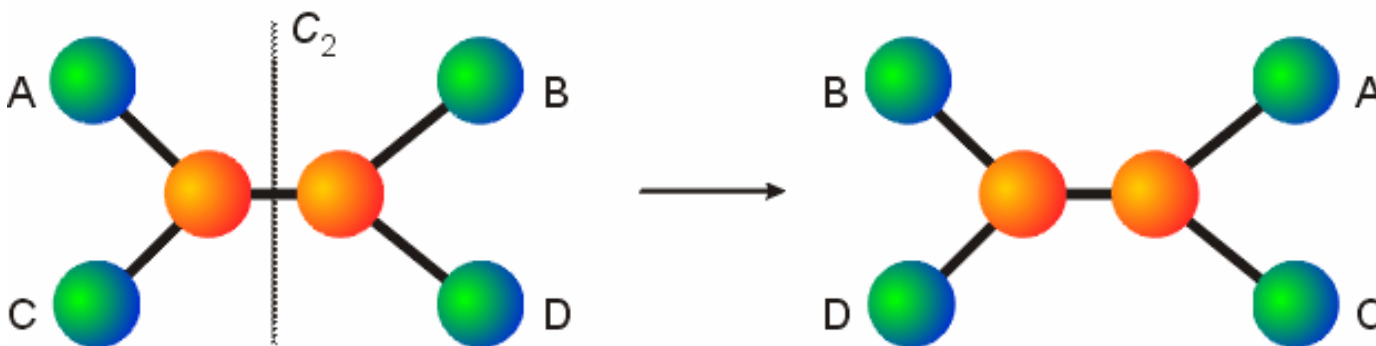

(b)

Rotační osa C_3



Rotace o úhel $360/n$

Vzniklá situace je
nerozlišitelná od výchozí

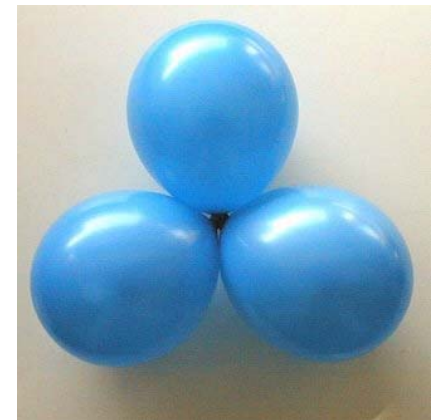
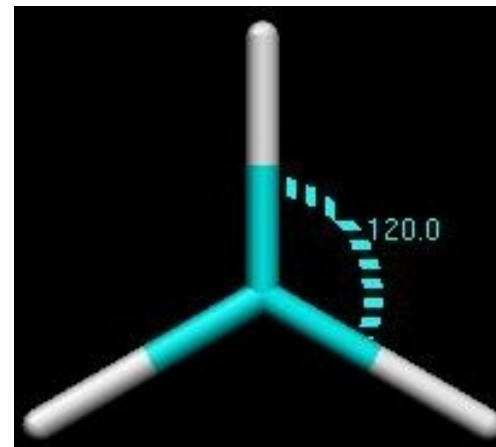
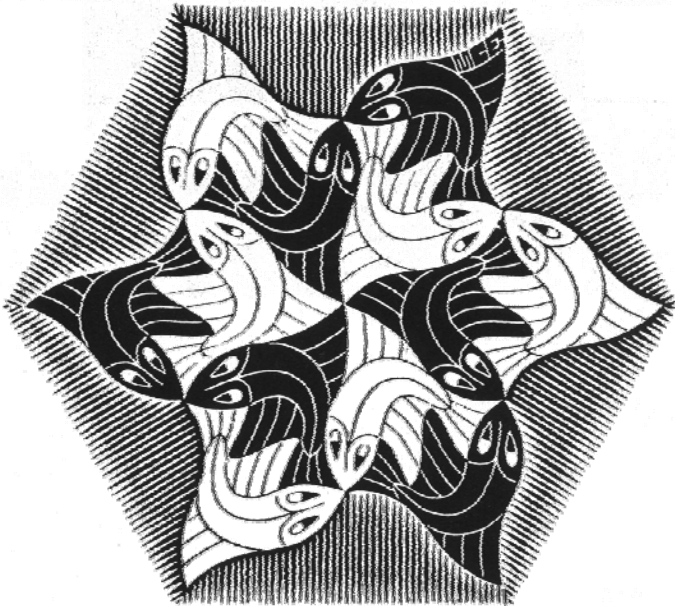

Rotační osa C_4

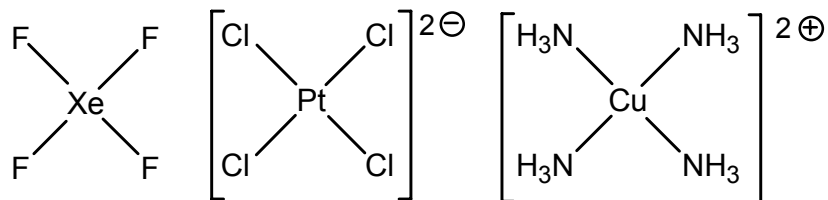

Rotace o úhel $360/4$.

Vzniklá situace je nerozlišitelná od výchozí.

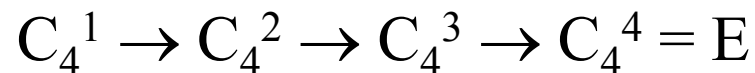
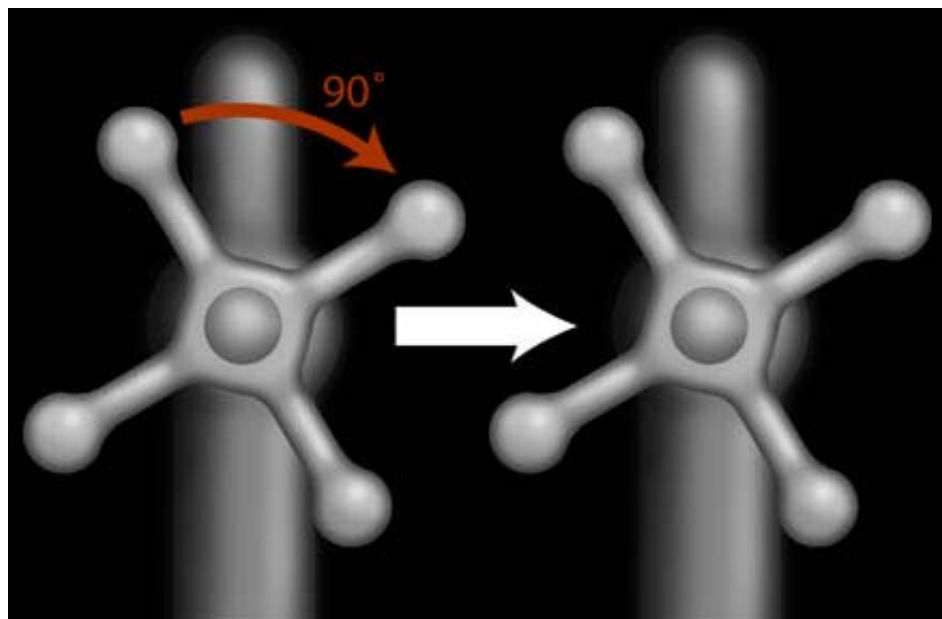
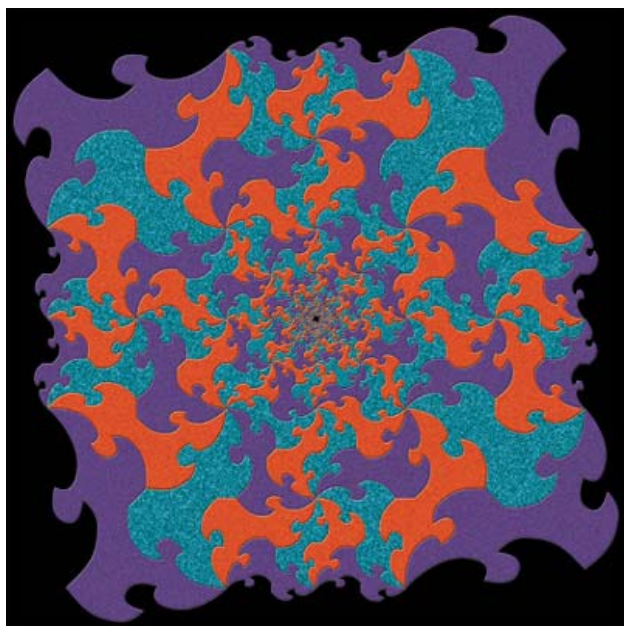

Rotační osa C_n

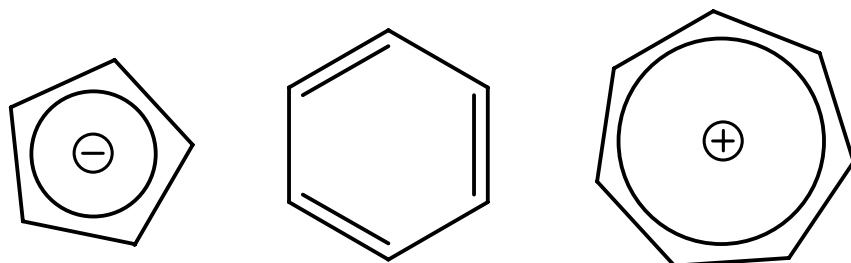

$C_5, C_6, C_7, \dots, C_\infty$

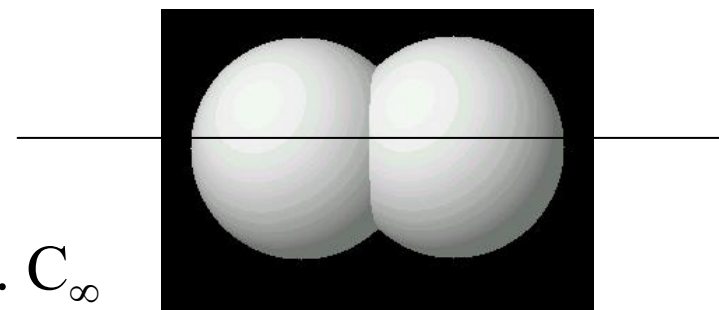

Lineární molekuly



Rovina symetrie σ

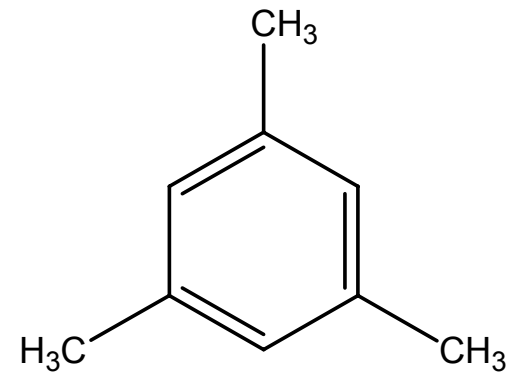
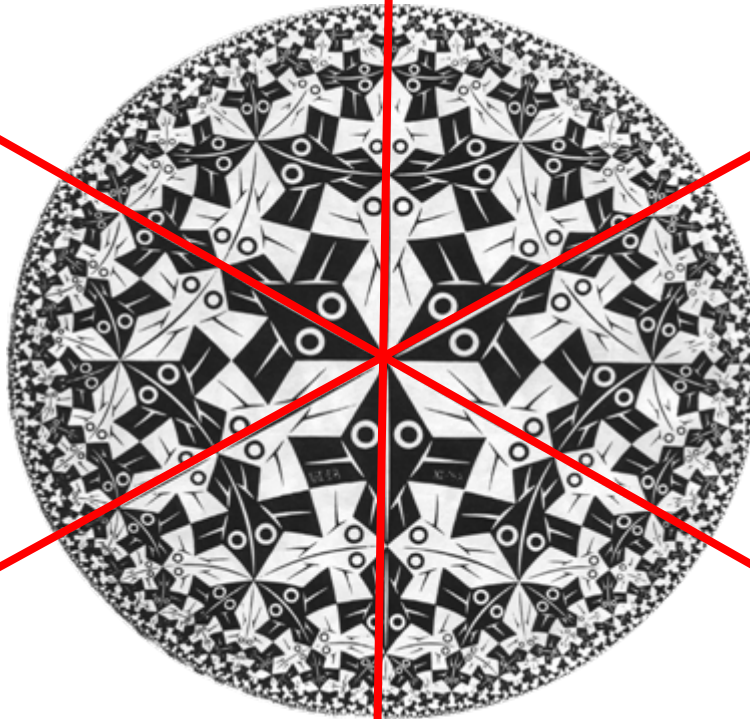
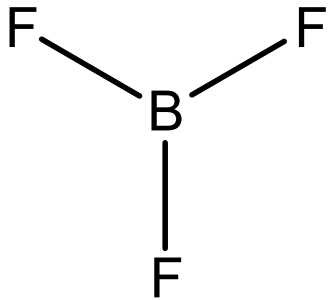

Roviny symetrie σ

Každá planární molekula má rovinu symetrie ve které leží

σ_h = kolmá k hlavní rotační ose

σ_v = protíná nejvíce atomů

σ_d = kolmá k hlavní rotaní ose

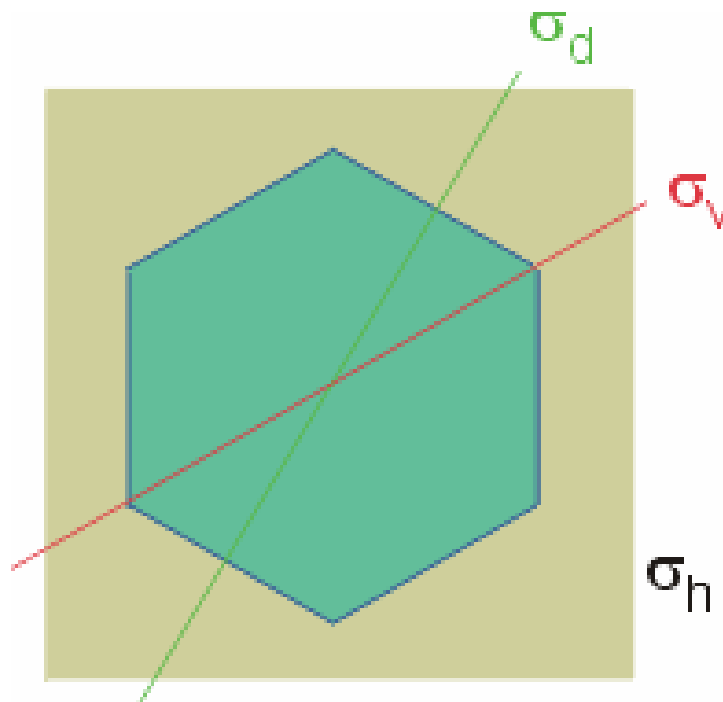

Roviny symetrie σ

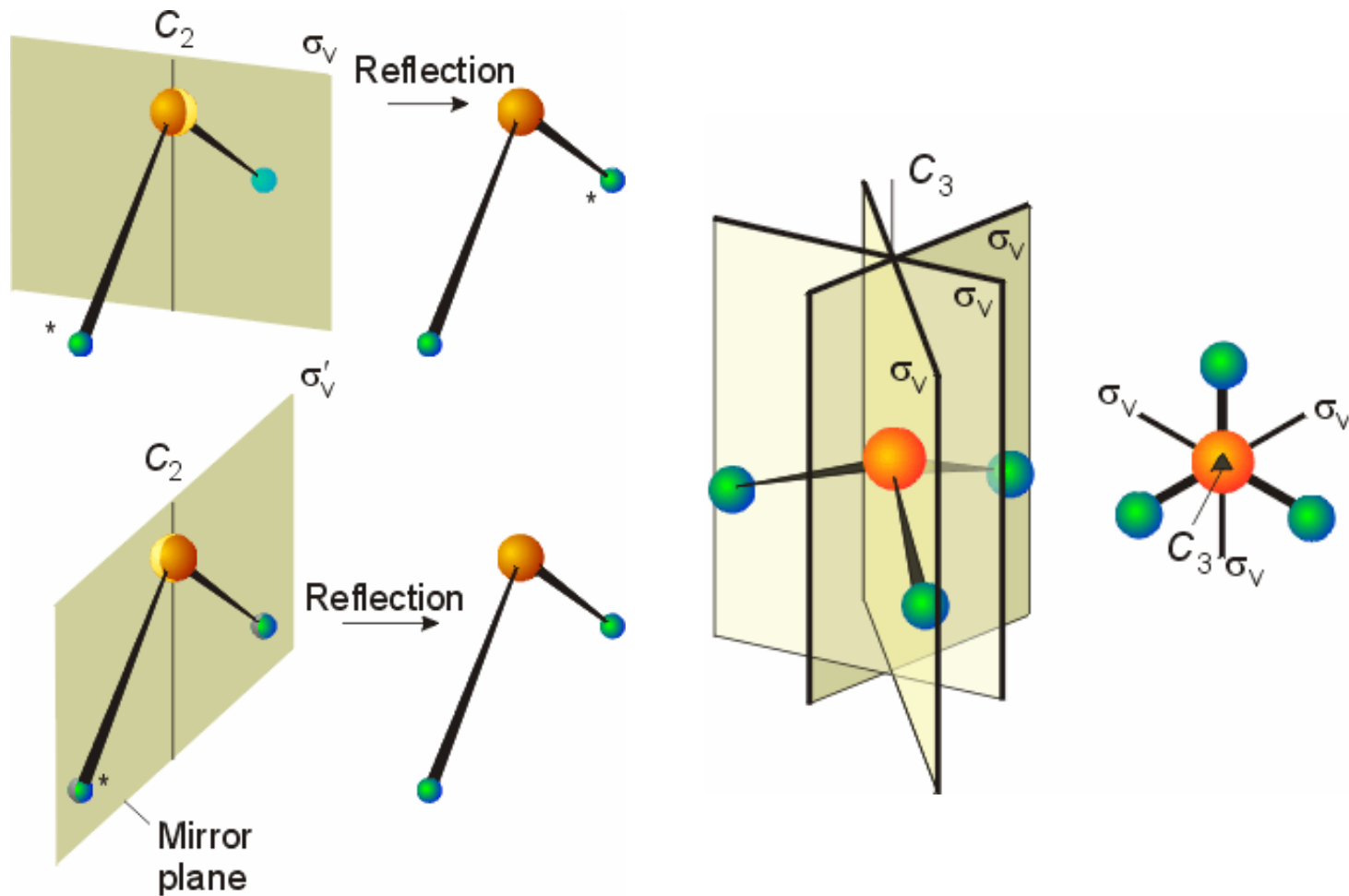

Zrcadlově-rotační osa S_n

Postupné provedení dvou operací – rotace a zrcadlení

$$S_1 = C_1 \times \sigma = \sigma$$

$$S_2 = C_2 \times \sigma = i$$

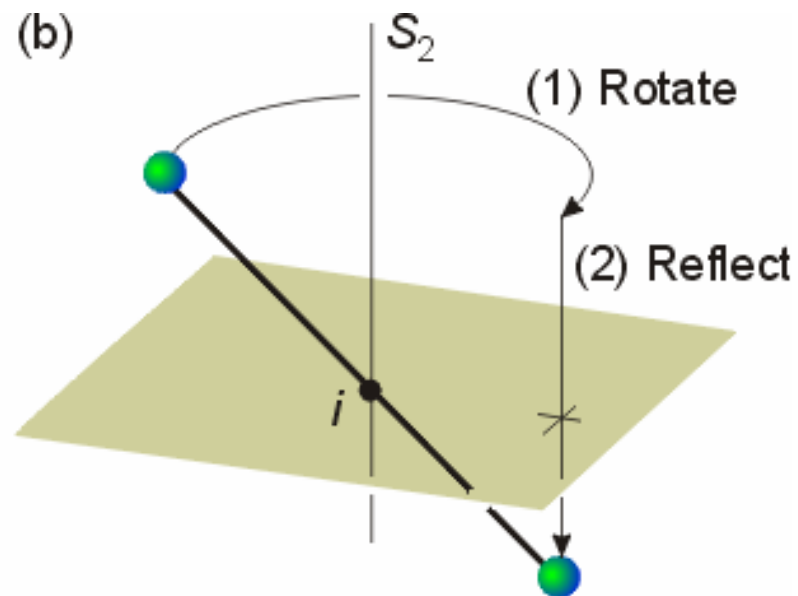
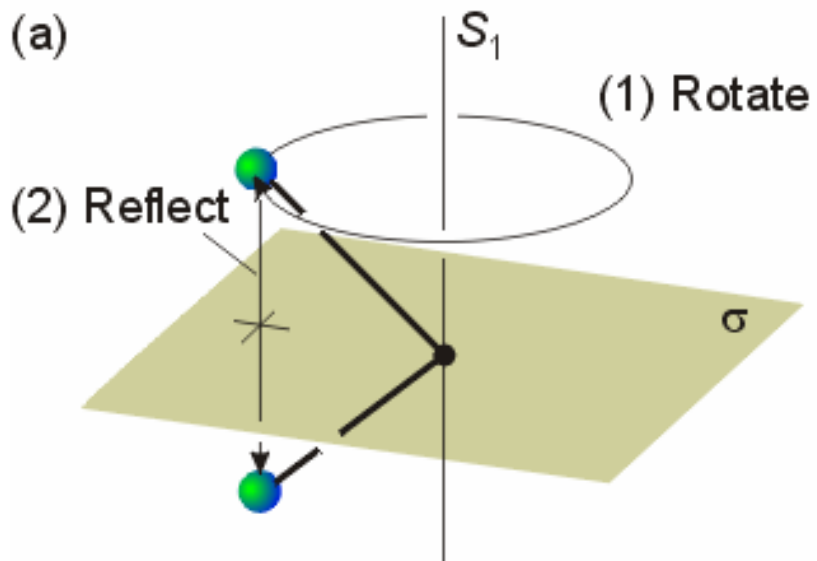

Zrcadlově-rotační osa S_n

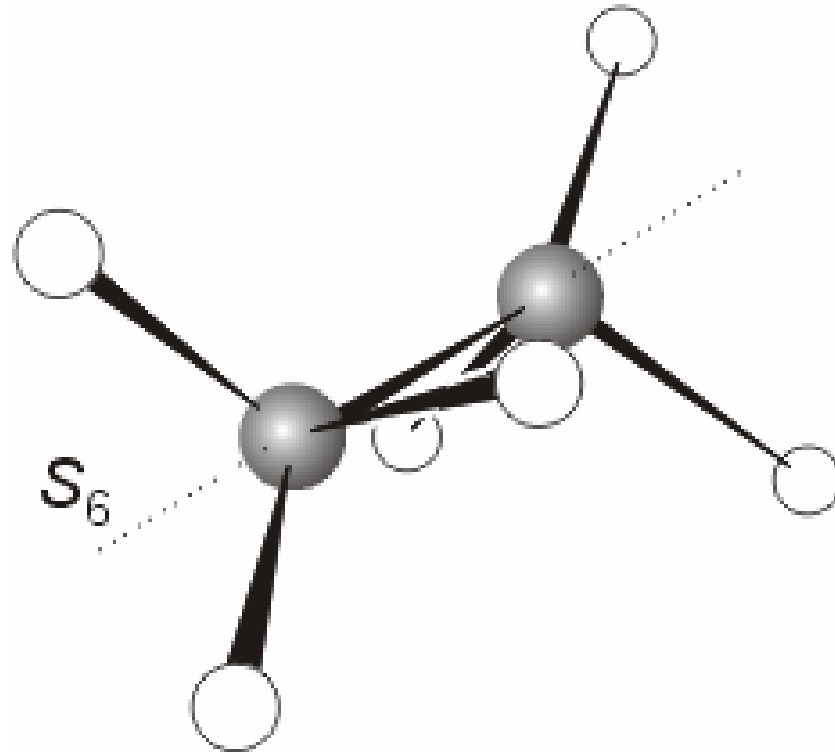
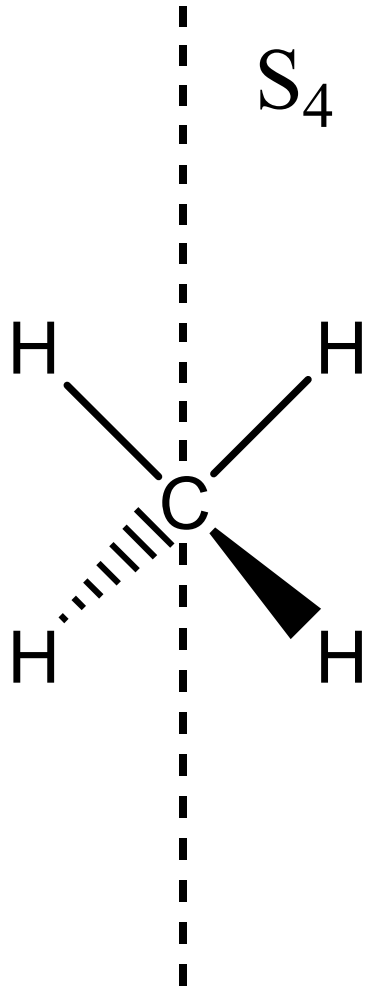

Prvky symetrie v molekule

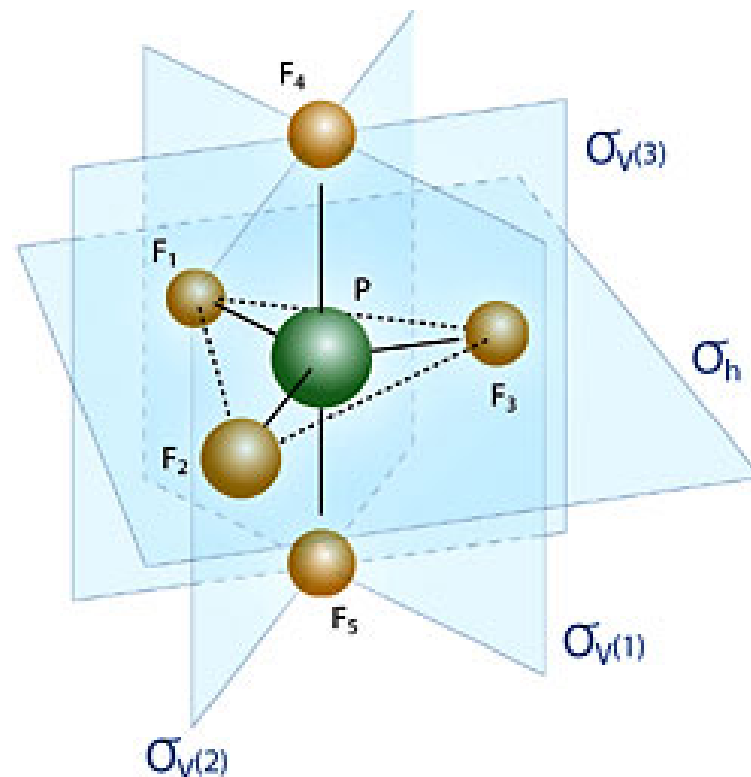
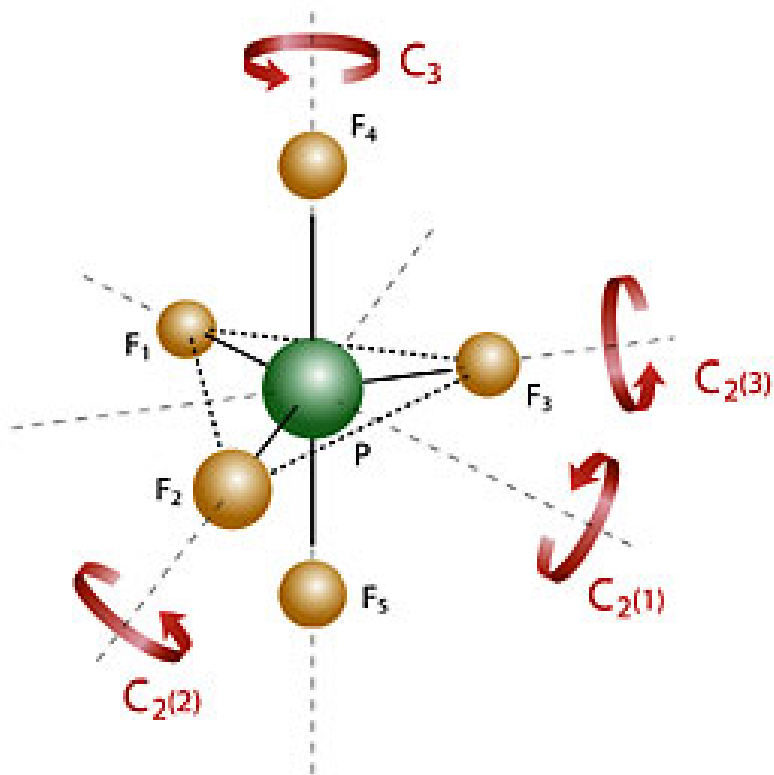

Ekvivalentní atomy = jsou zaměňovány operacemi symetrie

$$F_4 = F_5 \quad F_1 = F_2 = F_3$$

Chiralita



Figure 2. The Founding Fathers. R. M. Barrer (1910–1996) (right) and R. M. Milton (1920–2000) photographed

Chiralita

Podmínka chirality: v molekule není přítomna S_n

$$S_1 = \sigma$$

$$S_2 = i$$

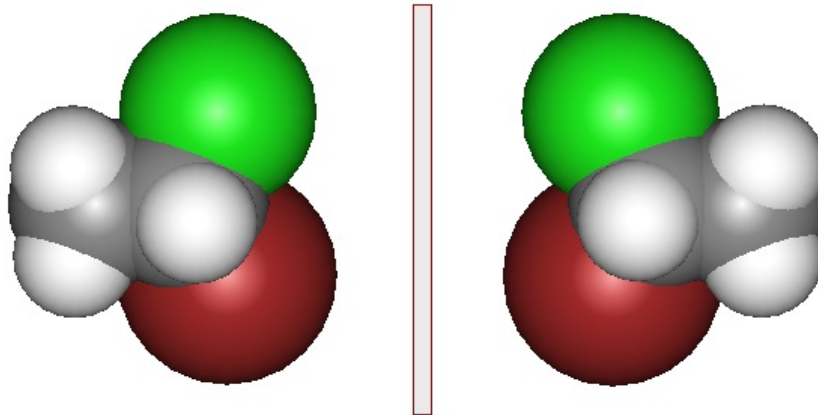

C_2

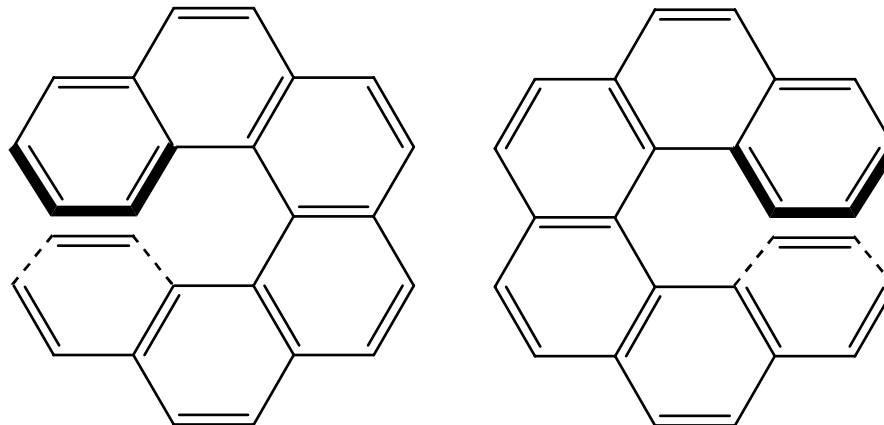
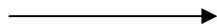

Dipolový moment

$$\mu = q L \quad \text{vektor [C m]}$$

$$1 \text{ D debye} = 3.33564 \cdot 10^{-30} \text{ C m}$$

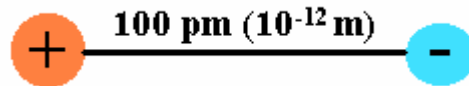

proton a elektron, vzdáleny 1 Å

$$\begin{aligned} \mu &= q L = (1.60 \cdot 10^{-19} \text{ C})(1.00 \cdot 10^{-10} \text{ m}) \\ &= 1.60 \cdot 10^{-29} \text{ C m} = \end{aligned}$$

dipolový moment

je referenční hodnota, čisté +1 a -1
náboje vzdálené 100 pm, vazba mezi nimi
je 100% iontová

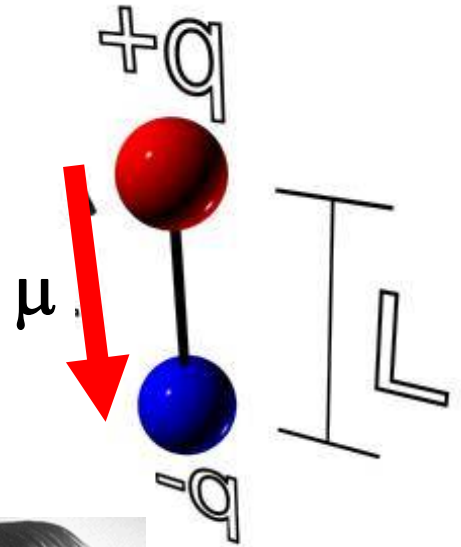

Zahřívání v MW

Dipolový moment molekuly

Dipolový moment molekuly = vektorový součet dipolových momentů vazeb a volných elektronových párů

Míra nerovnoměrnosti rozložení náboje v molekule

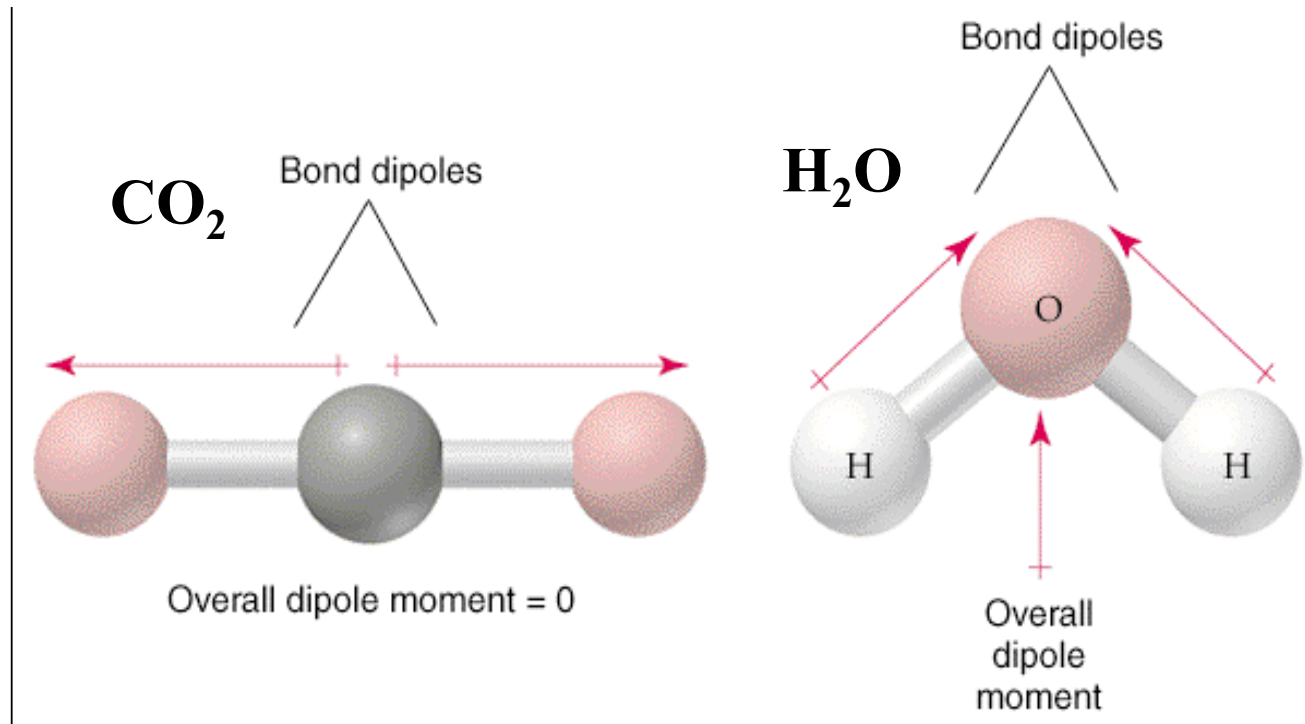

Dipolové momenty diatomických molekul

AH	μ (Debye)	R(Å)
LiH	-6.002	1.595
BeH	-0.282	1.343
BH	1.733	1.236
CH	1.570	1.124
NH	1.627	1.038
OH	1.780	0.9705
FH	1.942	0.9171

negativní nebo pozitivní znaménko pro $\mu \Rightarrow$ H je negativní nebo pozitivní konec dipolu.

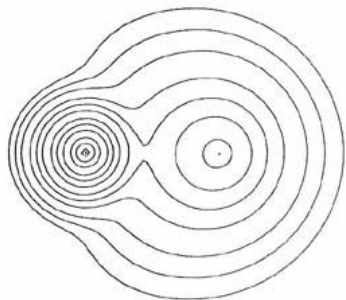

LiH

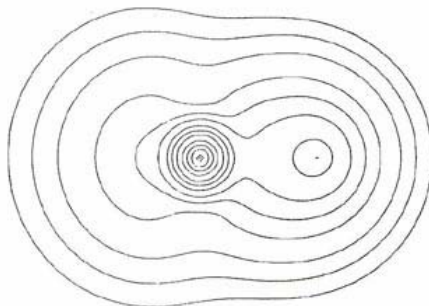

BeH

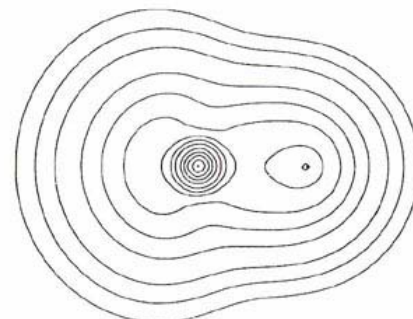

BH

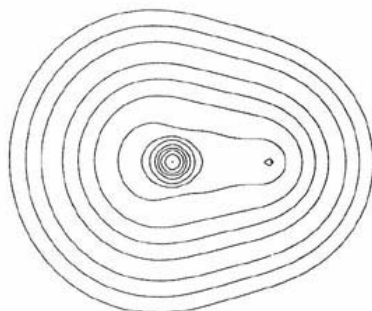

CH

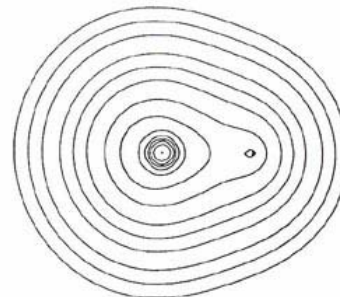

NH

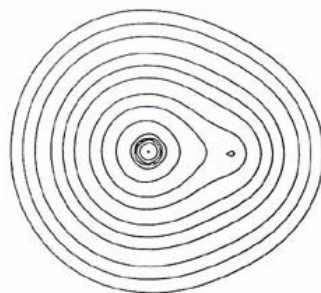

OH

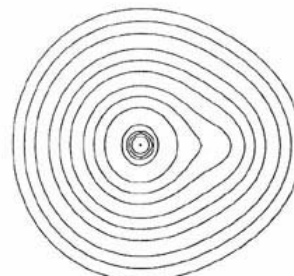

HF

Dipolový moment vazeb

Enlace	$\chi_A - \chi_B$	μ (D)	Enlace	$\chi_A - \chi_B$	μ (D)	Enlace	$\chi_A - \chi_B$	μ (D)
C-H	0.30	0.4	N=C		0.9	Br-P	0.68	0.36
N-H	0.87	1.31	N≡C		3.5	I-P	0.15	0
N-D		1.30	O-C	1.00	0.74	O=As		4.2
H-P	0.14	0.36	O=C		2.3	F-As	1.90	2.03
H-As	0	0.10	C-S	0.06	0.9	Cl-As	0.63	1.64
H-Sb	0.38	0.08	C=S		2.6	Br-As	0.54	1.27
O-H	1.30	1.51	C-Se	0.02	0.8	I-As	0.01	0.78
O-D		1.50	C-Te	0.49	0.6	Cl-Sb	1.01	0.78
S-H	0.24	0.68	F-C	1.60	1.41	Br-Sb	0.92	1.9
F-H	1.90	1.94	Cl-C	0.33	1.46	I-Sb	0.39	0.8
Cl-H	0.63	1.08	Br-C	0.24	1.38	O=S		2.8
Cl-D		1.09	C-I	0.29	1.19	Cl-S	0.39	0.7
Br-H	0.54	0.78	O-N	0.43	0.3	O-Cl	0.67	0.7
I-H	0.01	0.38	O=N		2.0	F-Cl	1.27	0.88
C-C	0	0	F-N	1.03	0.17	F-Br	1.36	1.3
C=C		0	O=P		2.7	Cl-Br	0.09	0.57
C≡C		0	S=P		3.1	Br-I	0.53	1.2
N-C	0.57	0.22	Cl-P	0.77	0.81			

Dipolový moment a polarita molekul

Polární molekula = celkový dipol musí ležet ve všech prvcích symetrie

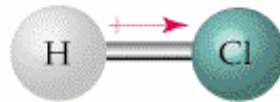

polární

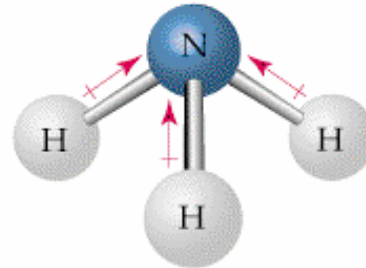

polární

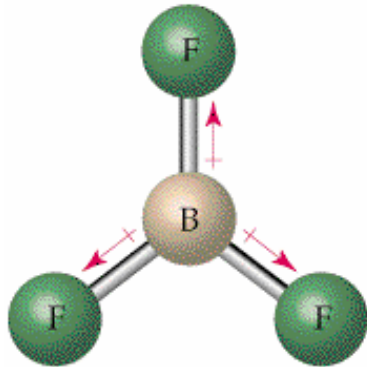

nepolární

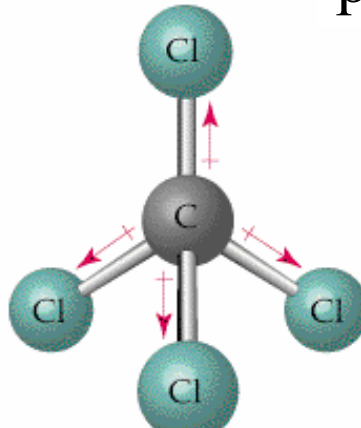

nepolární

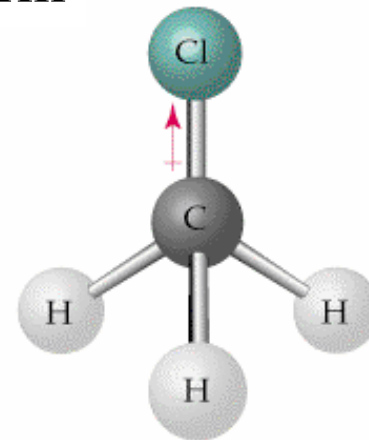

polární

Polární

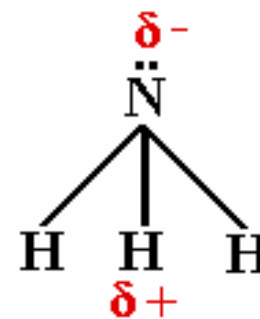
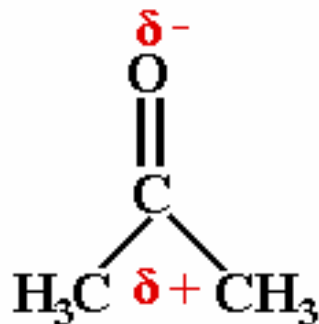
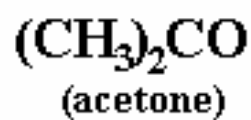
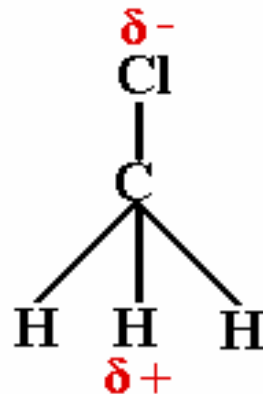
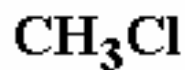
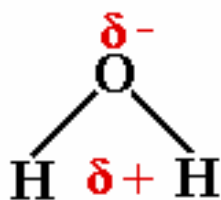
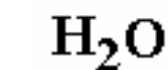

Nepolární

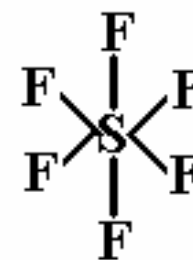
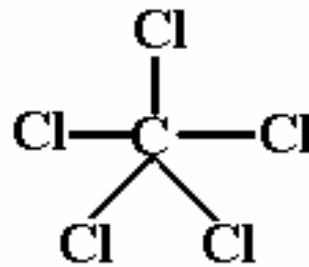
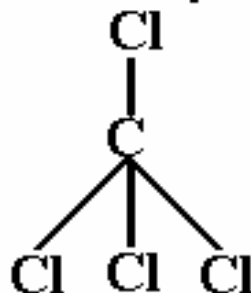
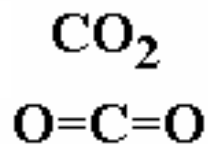

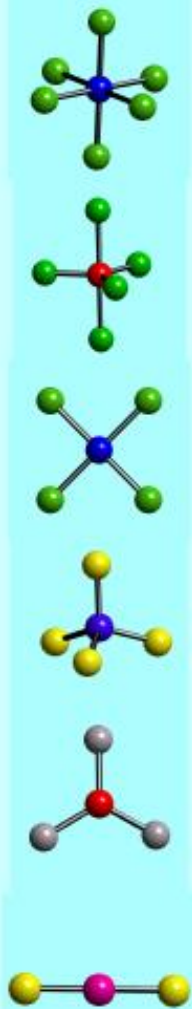

$\mu = 0$

AB_nE_m	Grupo Puntual	μ	Molekula
AB ₂	D _{∞h}	0	CO ₂ , BeCl ₂ (g), ZnX ₂
AB ₃	D _{3h}	0	BX ₃ , GaI ₃ , In(CH ₃) ₃
AB ₂ E	C _{2v}	finito	SnX ₂ , PbX ₂
AB ₄	T _d	0	CX ₄ , SiX ₄ , ThX ₄
AB ₃ E	C _{3v}	finito	NH ₃ , NX ₃ , PX ₃
AB ₂ E ₂	C _{2v}	finito	H ₂ O, SeX ₂ , TeX ₂
AB ₅	D _{3h}	0	PF ₅ , PCl ₅ (g), NbCl ₅ (g)
AB ₄ E	C _{2v}	finito	SF ₄ , SeF ₄
AB ₃ E ₂	C _{2v}	finito	ClF ₃ , BrF ₃
AB ₂ E ₃	D _{∞h}	0	XeF ₂
AB ₆	O _h	0	SF ₆ , SeF ₆ , MoF ₆
AB ₅ E	C _{4v}	finito	ClF ₅ , BrF ₅ , IF ₅
AB ₄ E ₂	D _{4h}	0	XeF ₄
AB ₇	D _{5h}	0	IF ₇

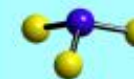
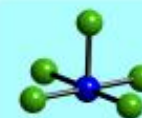

$\mu \neq 0$

Teorie Molekulových Orbitalů (MO)

Kombinace **atomových** orbitalů na **všech atomech** v molekule

- Vhodná symetrie
- Vhodná (podobná) energie

Z n AO vytvoříme n MO

Pro začátek dvouatomové molekuly:
 H_2 , F_2 , CO ,.....

Stejně i pro víceatomové: BF_3 , CH_4 ,.....

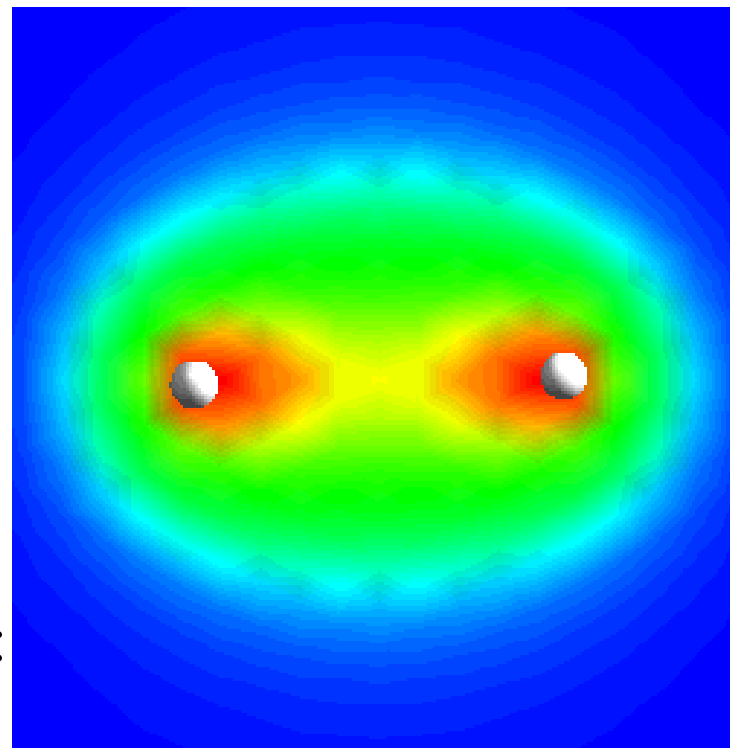

Vazebný MO v molekule H_2

Interference

Konstruktivní

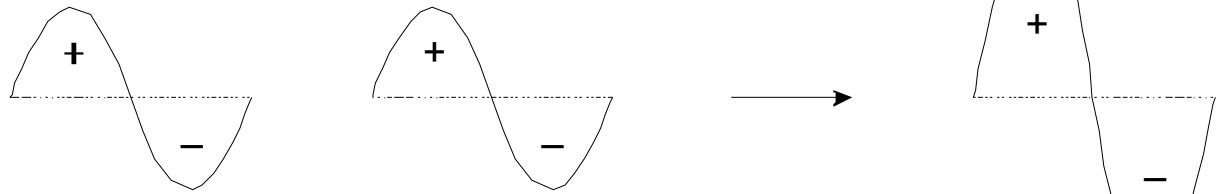

Destruktivní

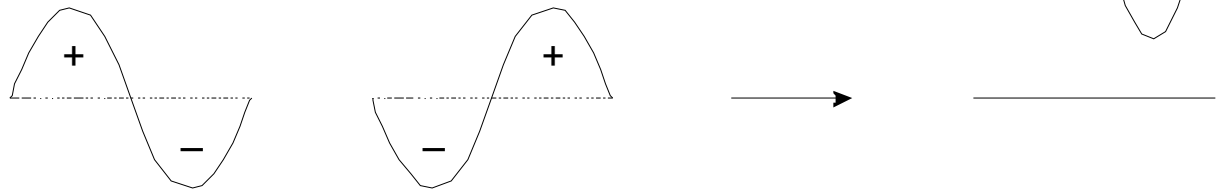

LCAO = Lineární kombinace atomových orbitalů

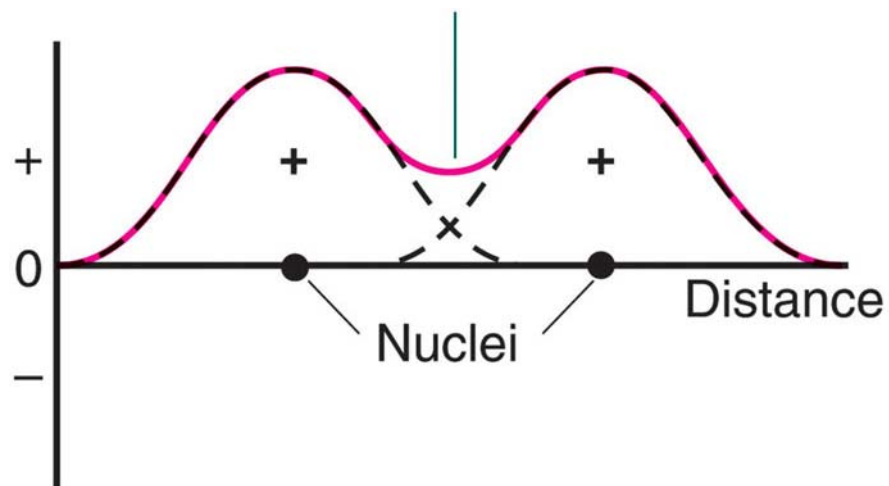

Kombinace dvou vlnových funkcí (orbitalů) se stejným znaménkem

$$\Psi = c_1 \Psi_A + c_2 \Psi_B$$
$$\Psi^* = c_3 \Psi_A - c_4 \Psi_B$$

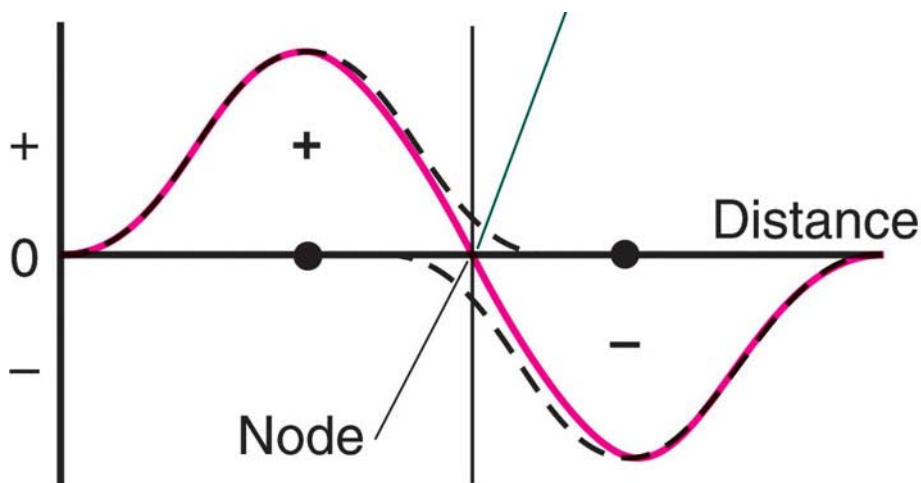

Kombinace dvou vlnových funkcí (orbitalů) s opačným znaménkem

LCAO = Lineární kombinace atomových orbitalů

$$\Psi = c_1 \Psi_A + c_2 \Psi_B$$

$$\Psi^* = c_3 \Psi_A - c_4 \Psi_B$$

Ψ^* Protivazebný MO

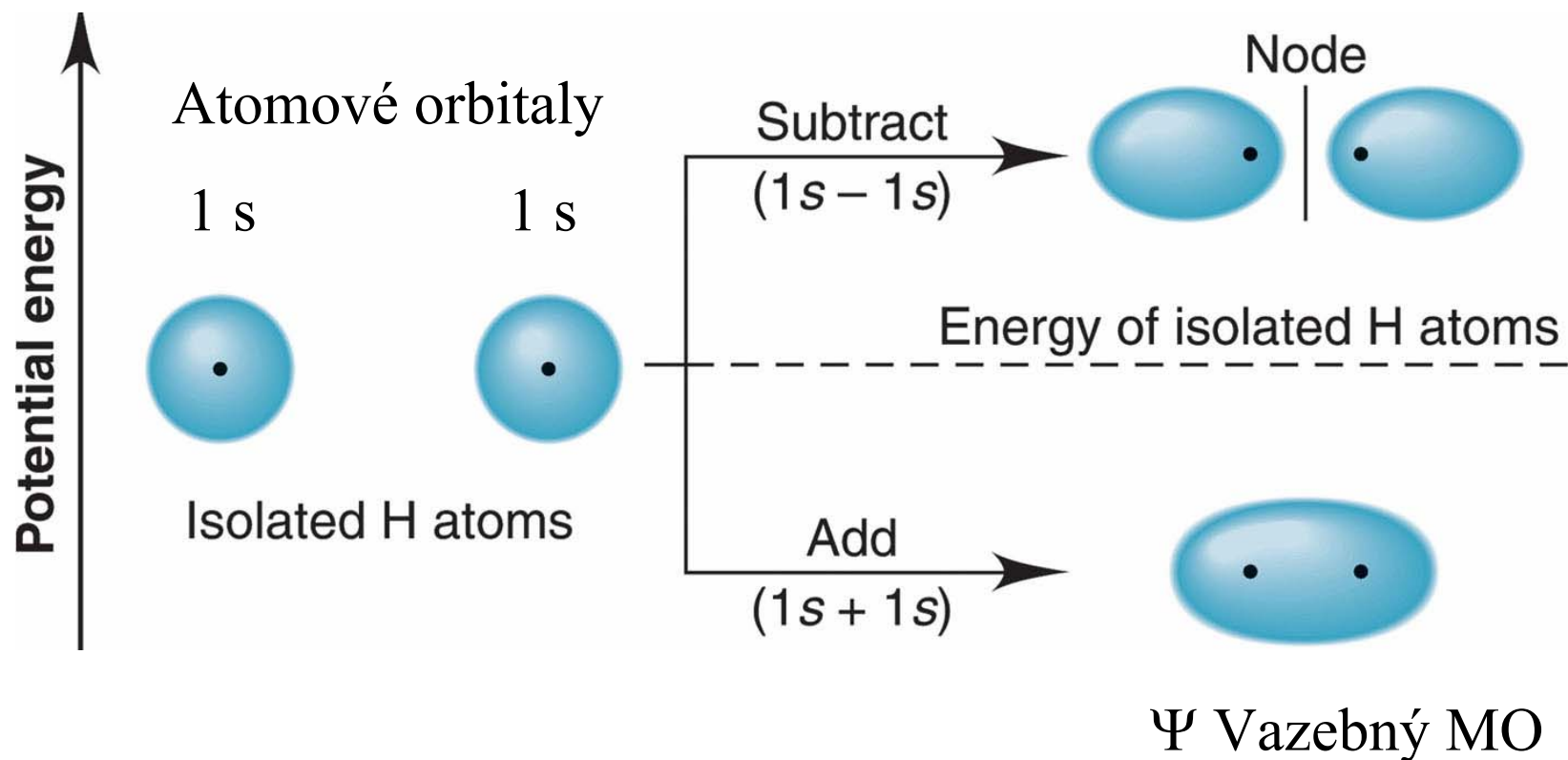

Počet MO = počet AO

LCAO = Lineární kombinace atomových orbitalů

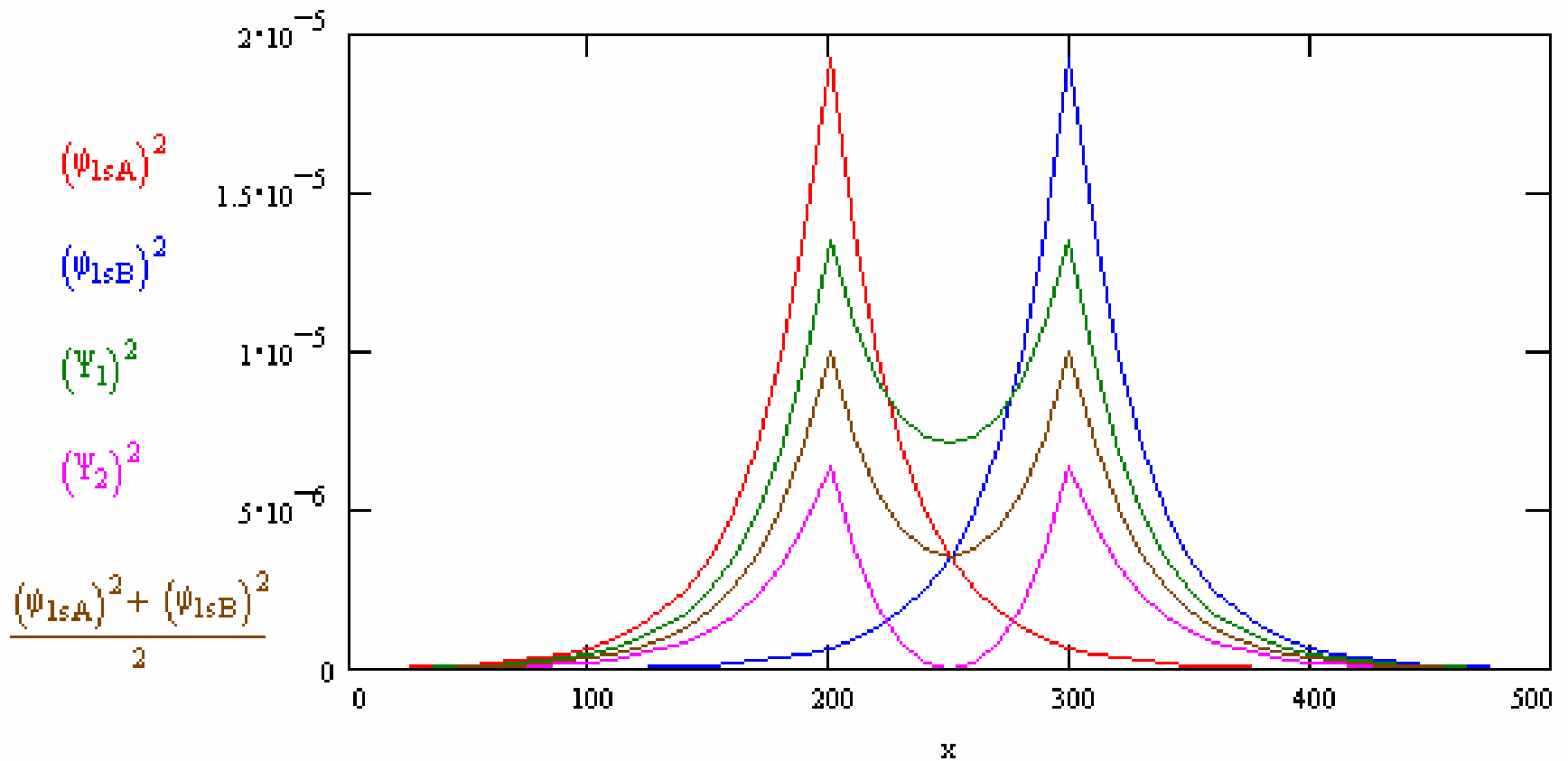

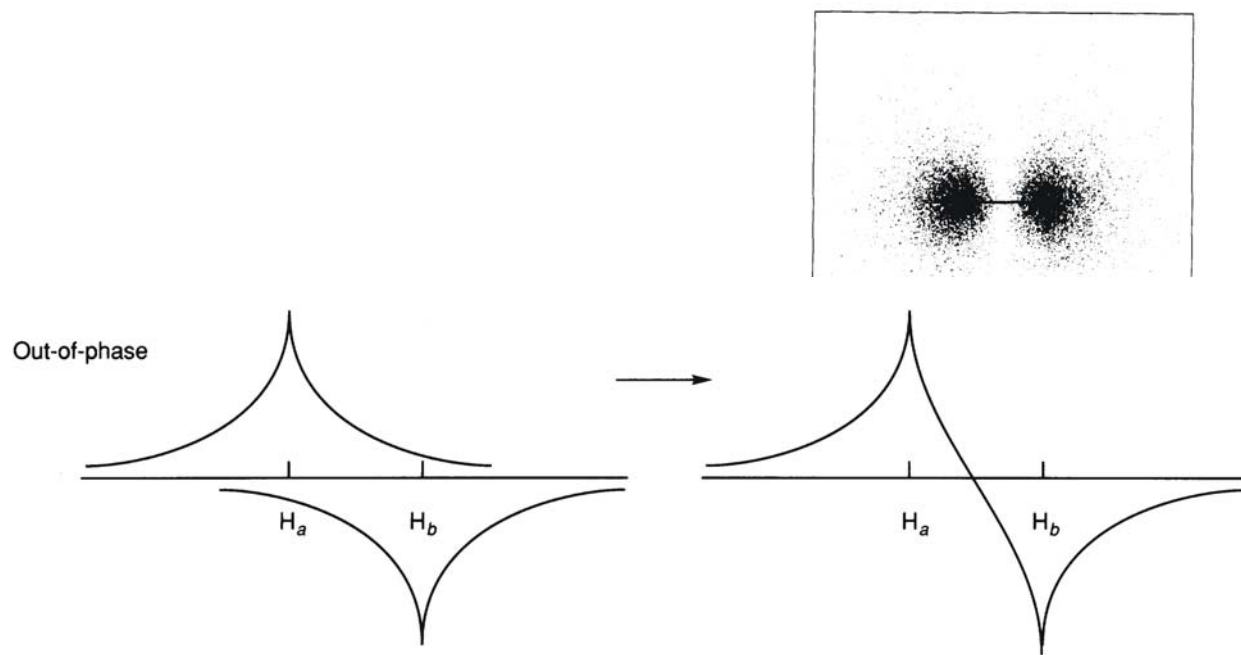
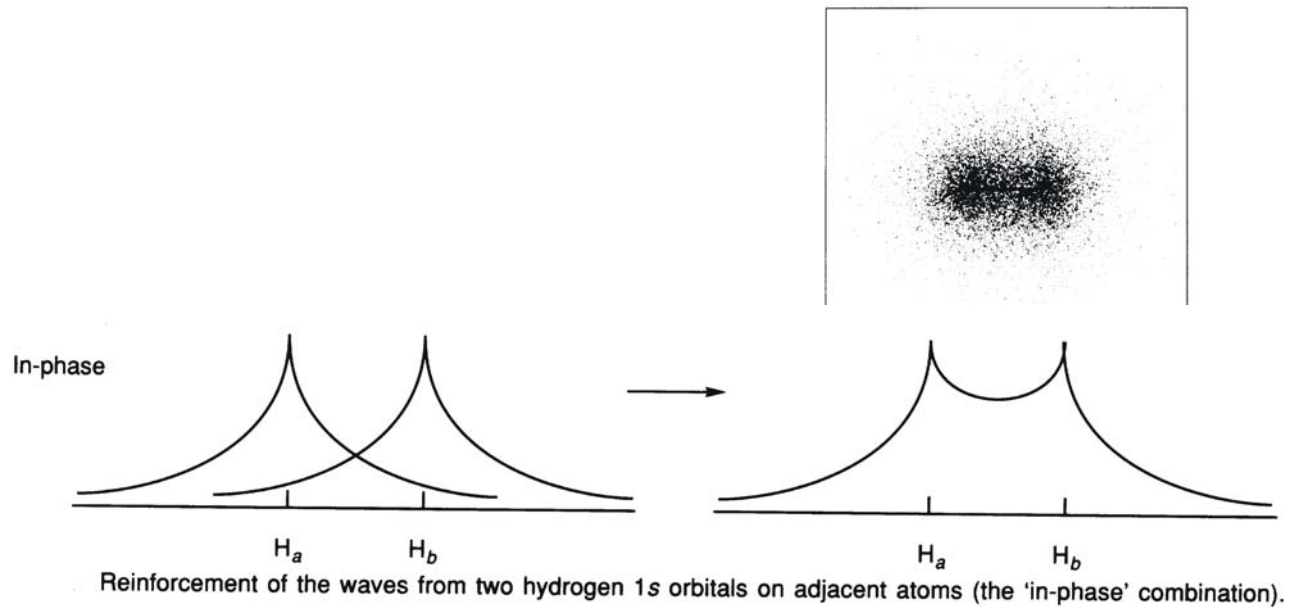

Destructive interference of the waves from two hydrogen 1s orbitals on adjacent atoms (the 'out-of-phase' combination).

Rozdíl mezi VB a MO

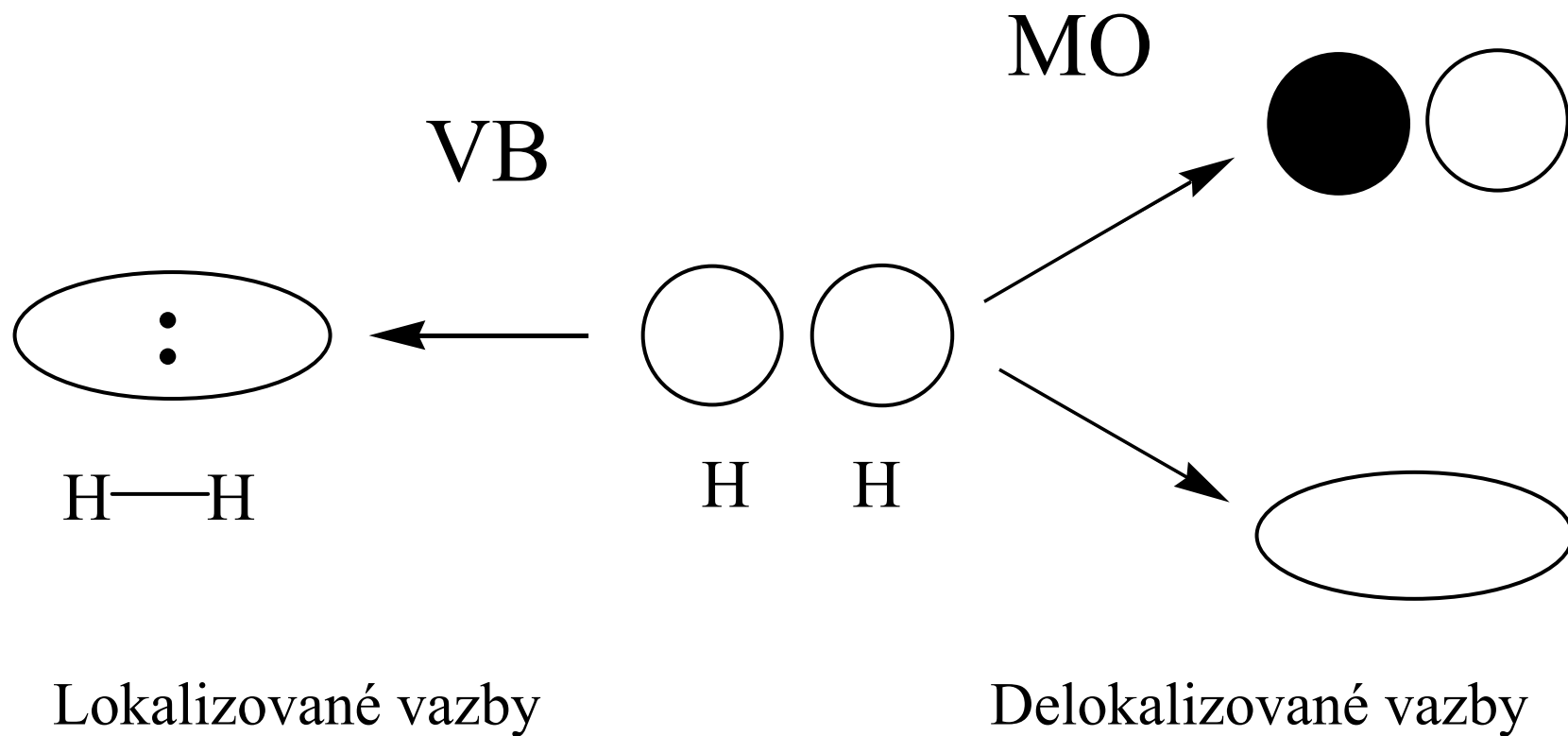

Ψ^* Protivazebný MO ● ○

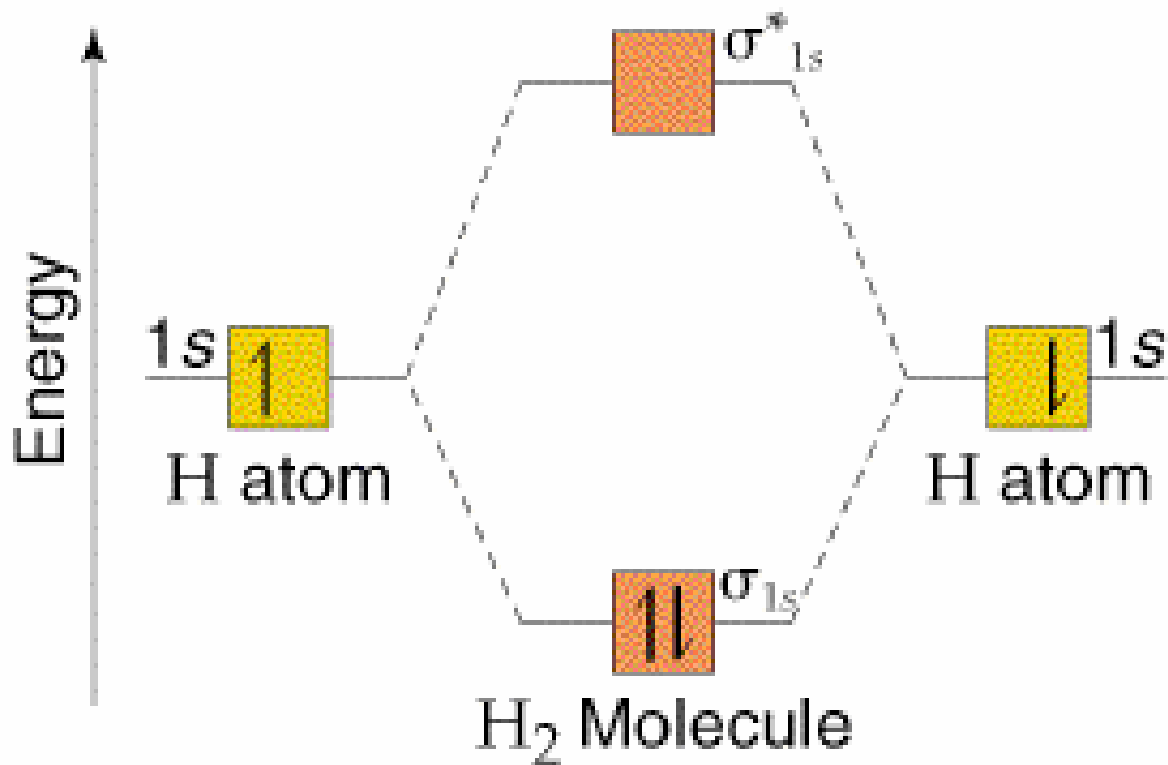

Ψ Vazebný MO ○

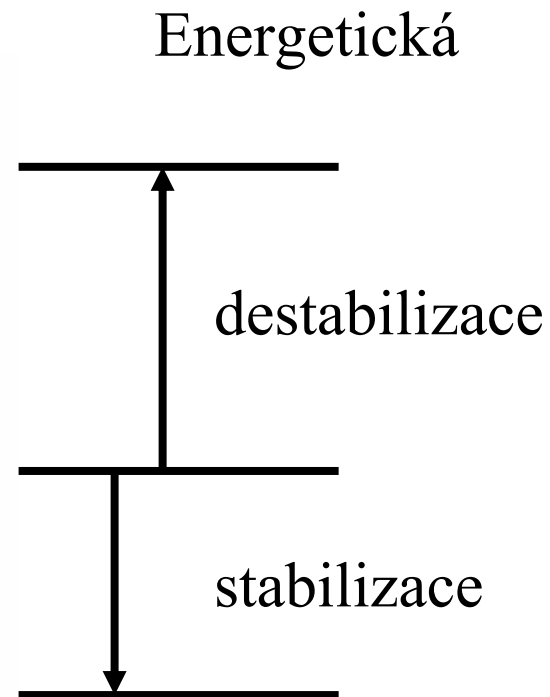

ve srovnání s
volnými atomy

π MO vzniklé kombinací p AO

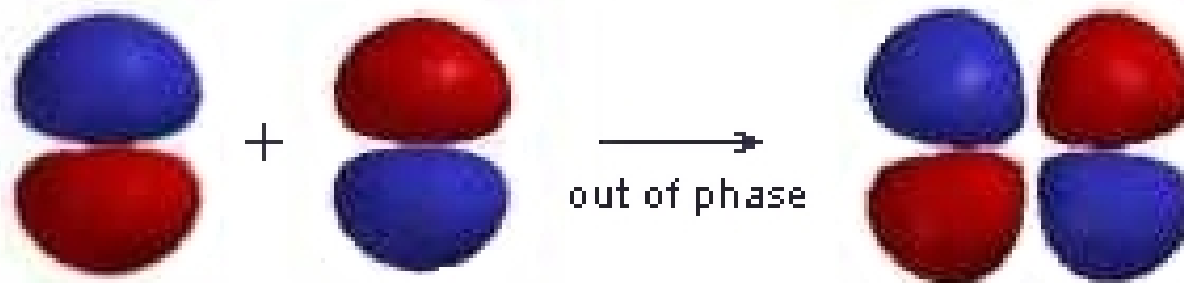

Protivazebný π MO



Vazebný π MO

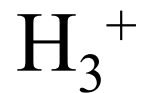

Vzrůstá energie, klesá stabilita



Protivazebný MO

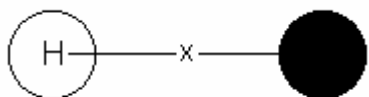

Nevazebný MO

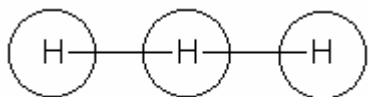

Vazebný MO

Vzrůstá počet uzlových rovin

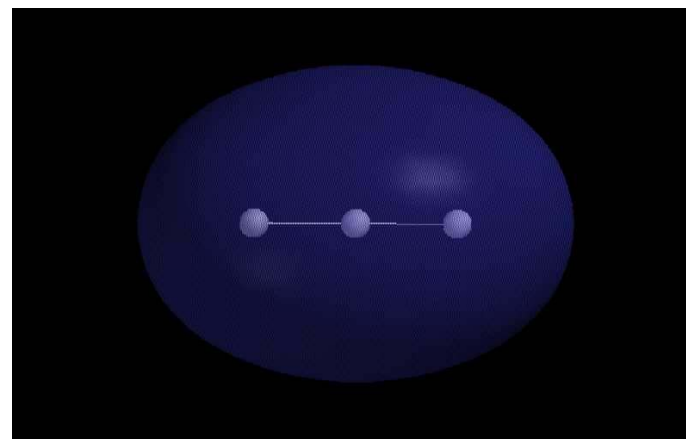
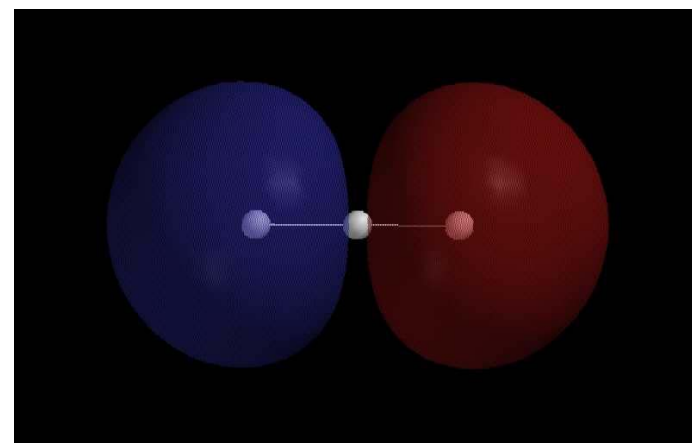
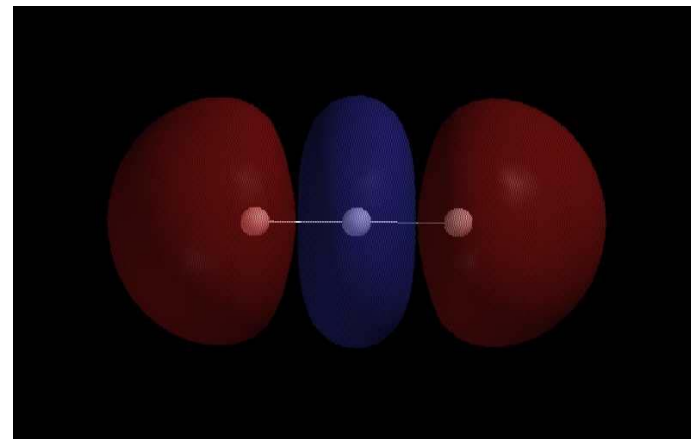

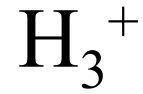

Vzrůstá energie,
klesá stabilita

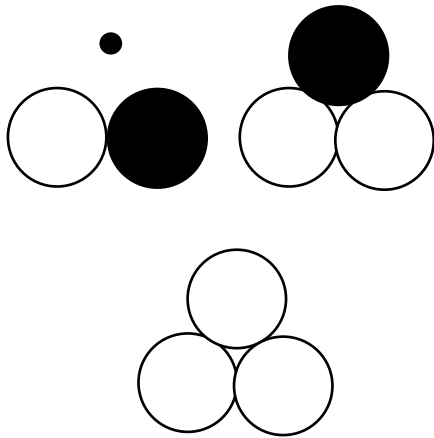

Protivazebné MO

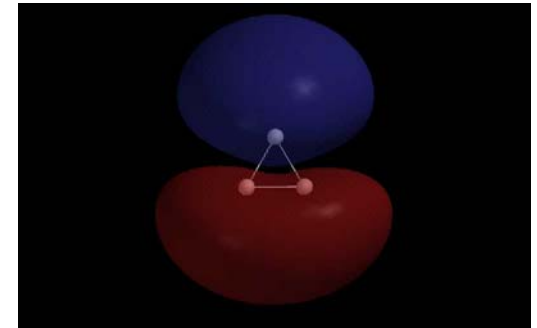
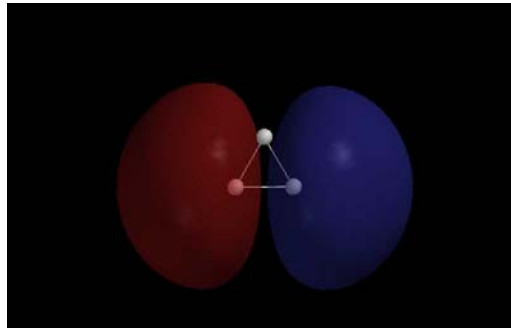

Vazebný MO

Vzrůstá počet uzlových rovin

LCAO = Lineární kombinace AO

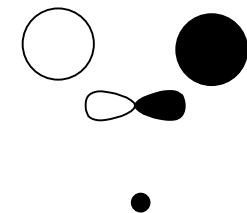
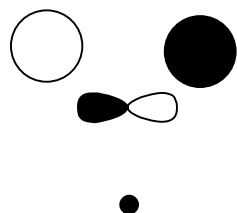
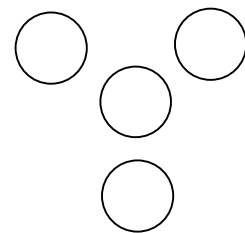
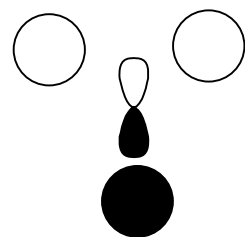
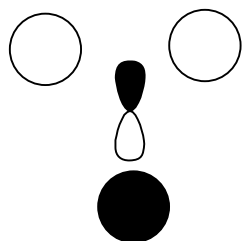
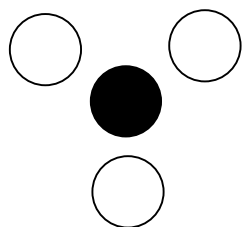

LCAO

obecně pro n atomů a m orbitalů

$$\Psi_i = c_1 \Psi_1 + c_2 \Psi_2 + c_3 \Psi_3 + \dots + c_n \Psi_n$$

MO s nejnižší energií, nemá žádnou uzlovou rovinu, nejvíce vazebný, kombinace po jednom AO z každého atomu, všechny se stejným znaménkem



Zaplňování MO elektrony

Aufbau

Hund

Pauli

Pravidla pro zaplňování MO elektrony

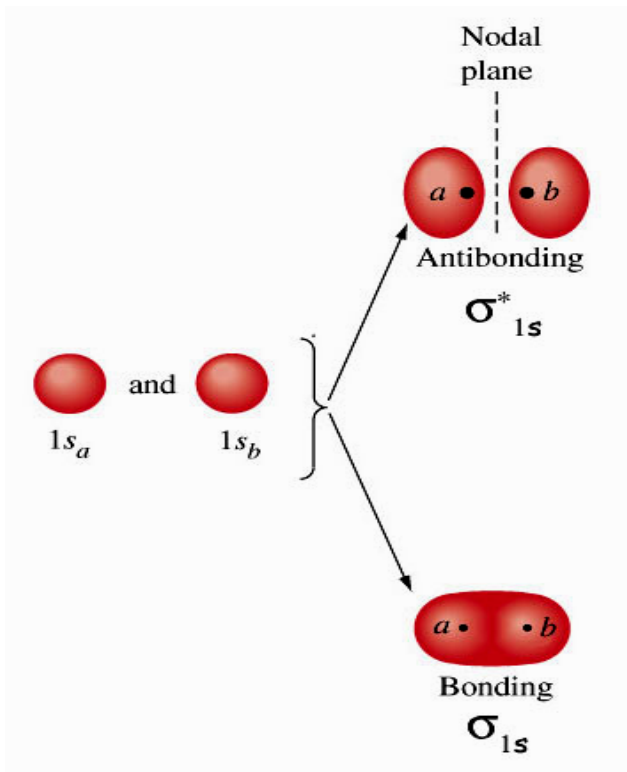

Energy ↑

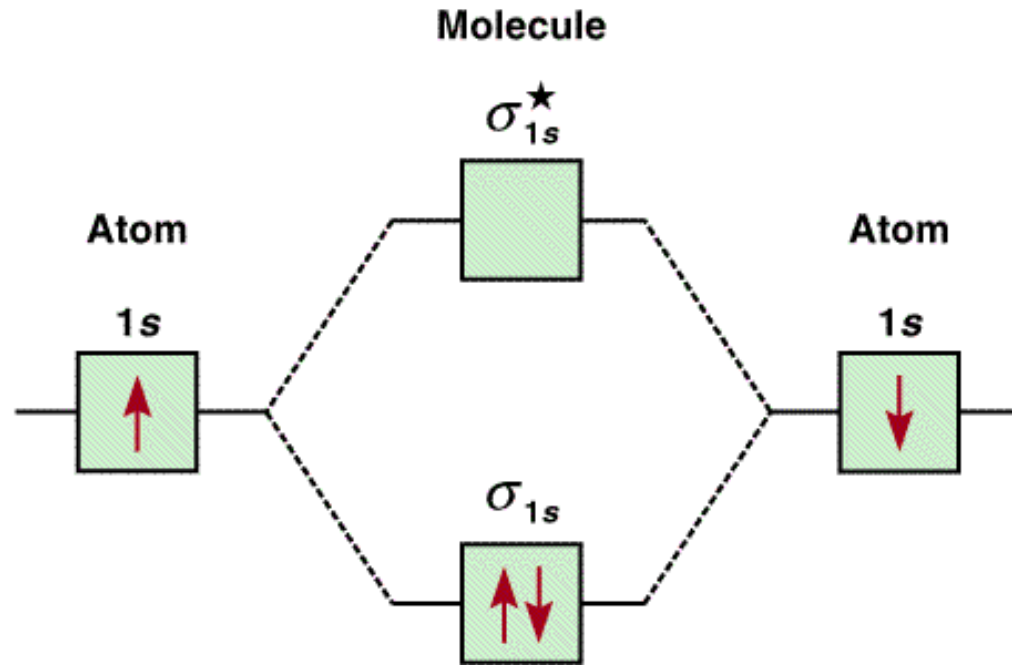

Protivazebný MO

Vazebný MO

Řád vazby

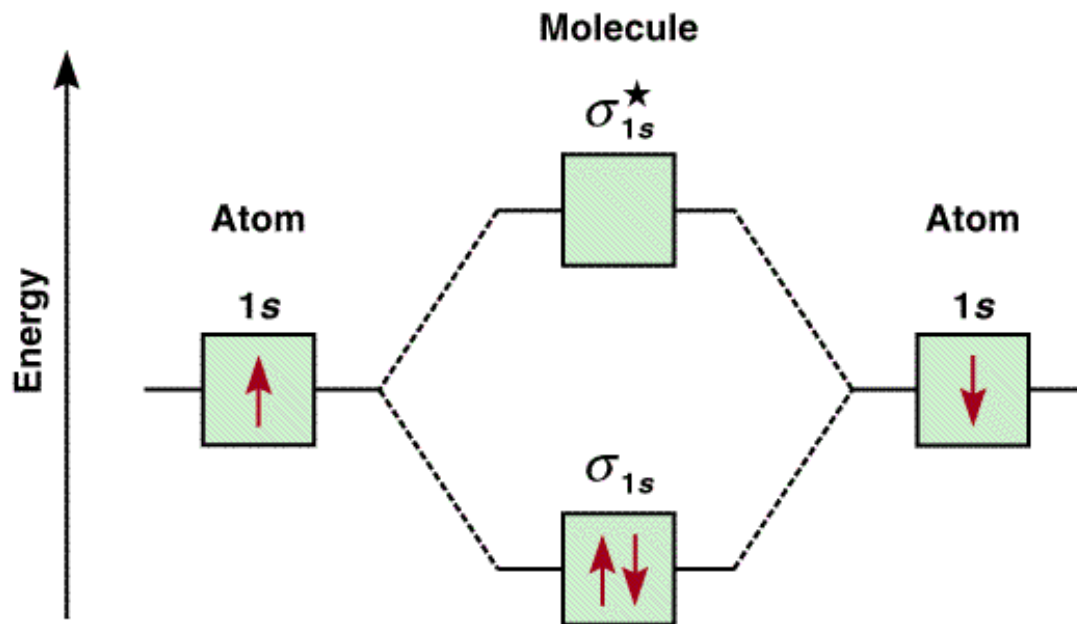

Řád vazby = $\frac{1}{2}$ (počet vazebných e – počet protivazebných e)

Řád vazby

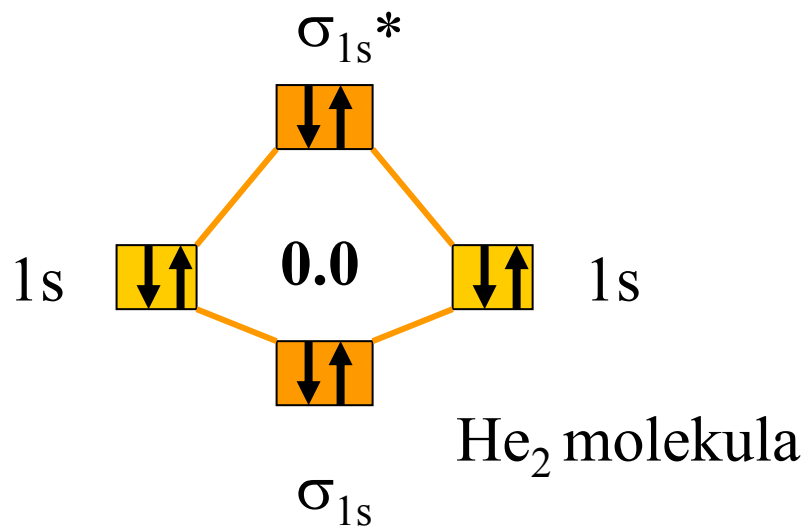
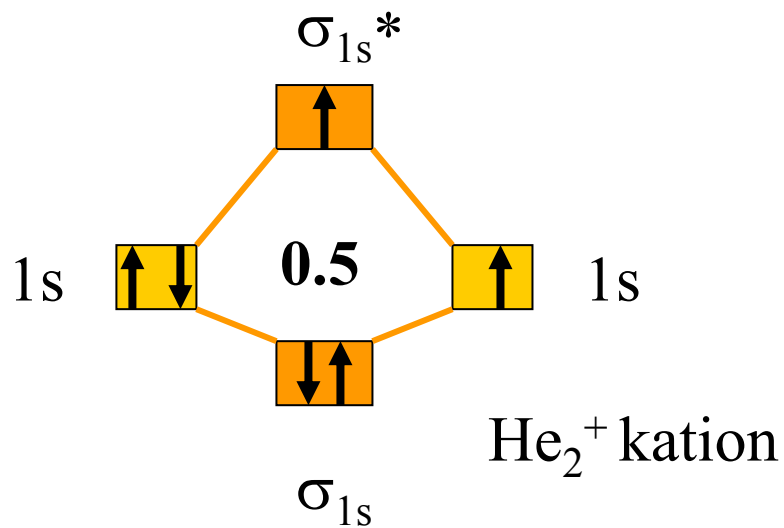
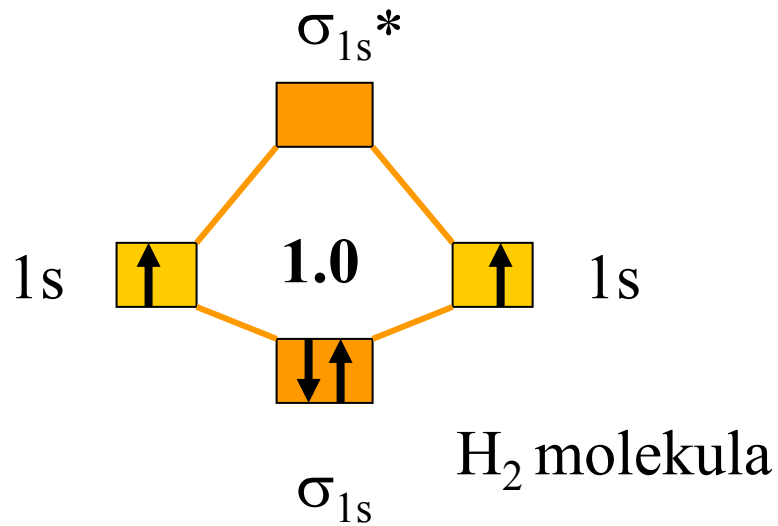
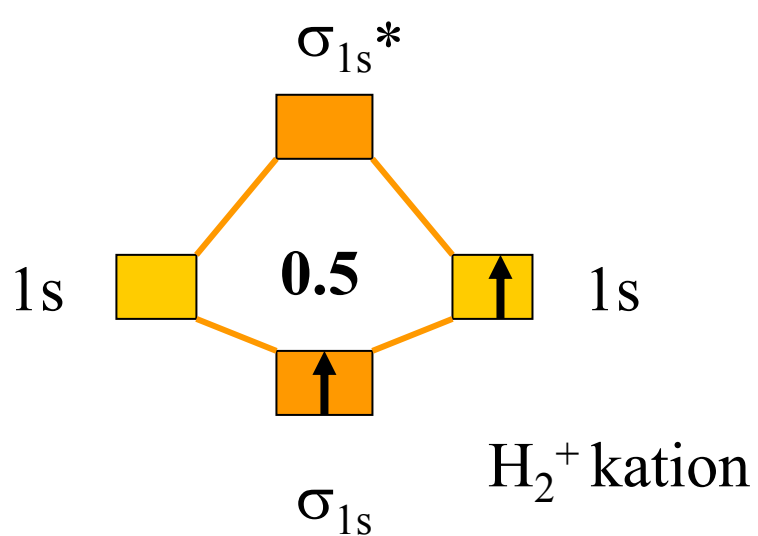

Řád vazby

Molekula	Vazebné elektrony	Protivaz. elektrony	Řád vazby	Délka vazby, Å	Vazebná energie, kJ mol ⁻¹
H ₂ ⁺	1	0	0.5	1.06	255
H ₂	2	0	1	0.74	432
He ₂ ⁺	2	1	0.5	1.08	230
He ₂	2	2	0	---	0

1 elektronová vazba: 1 vazebný e⁻ tvoří silnější vazbu než 2 vazebné a 1 protivazebný e⁻

Vazebný MO σ_{1s}

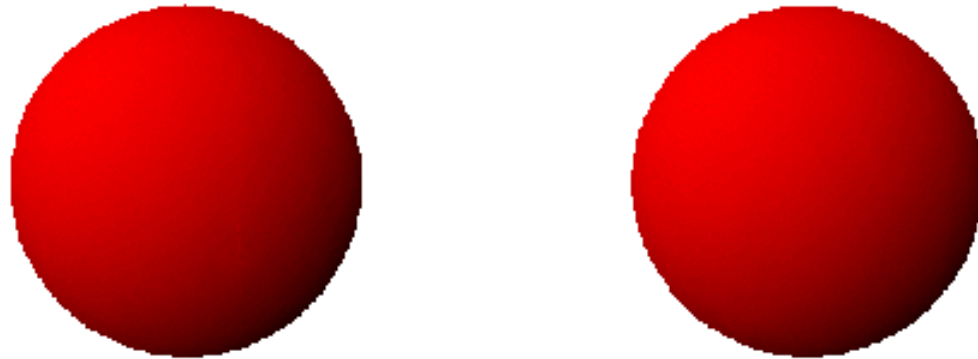

Protivazebný MO σ_{1s}^*

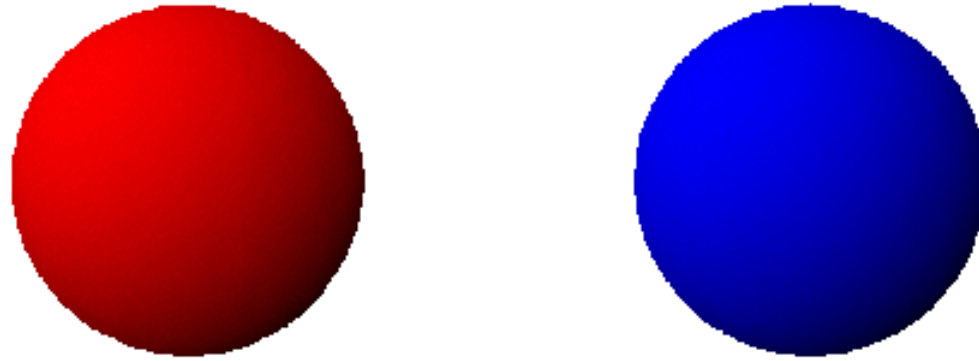

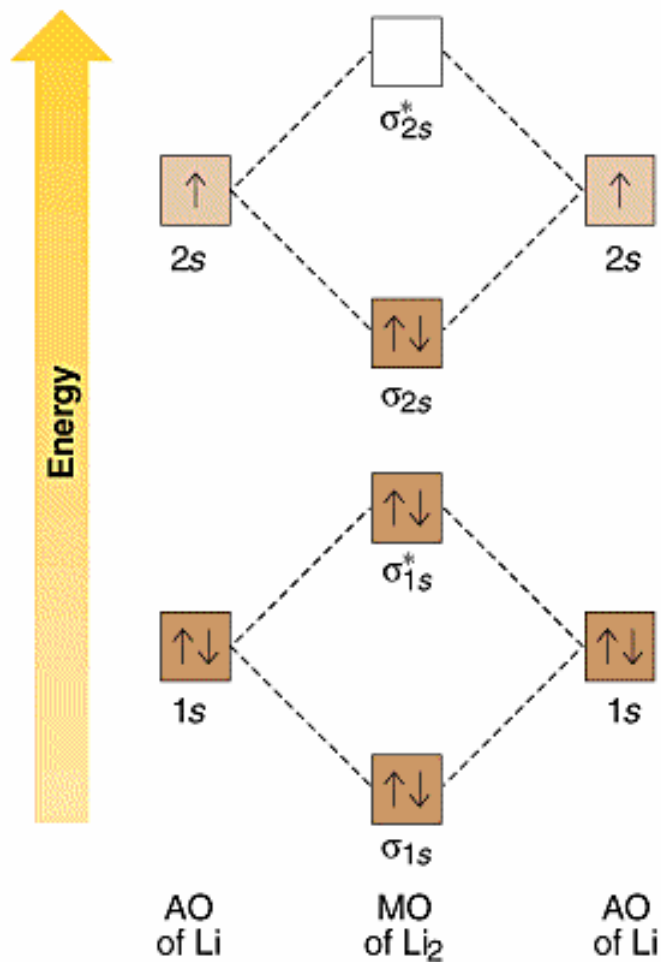

A Li₂ bond order = 1

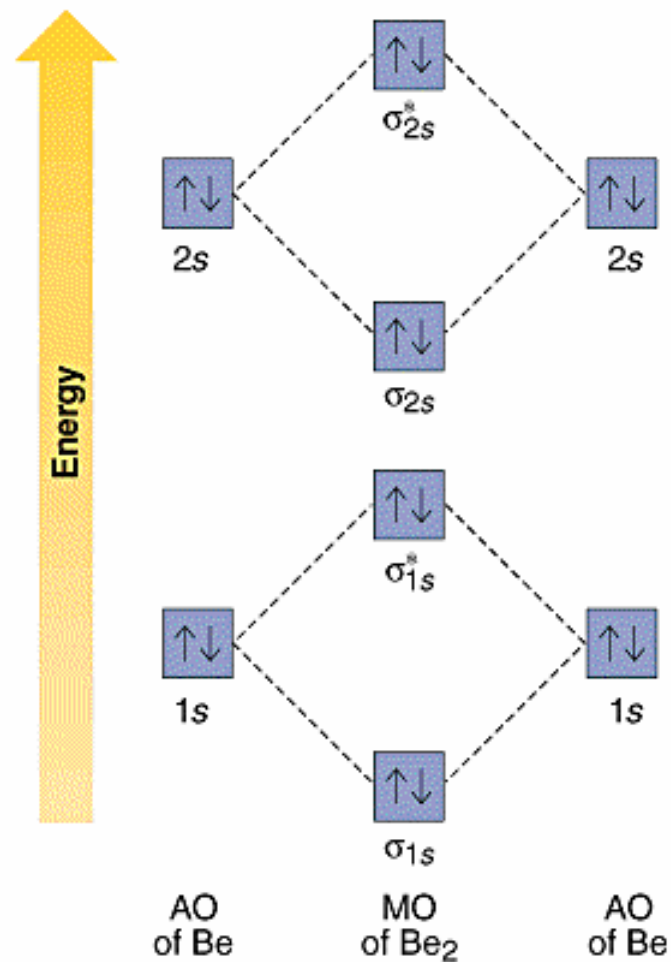

B Be₂ bond order = 0

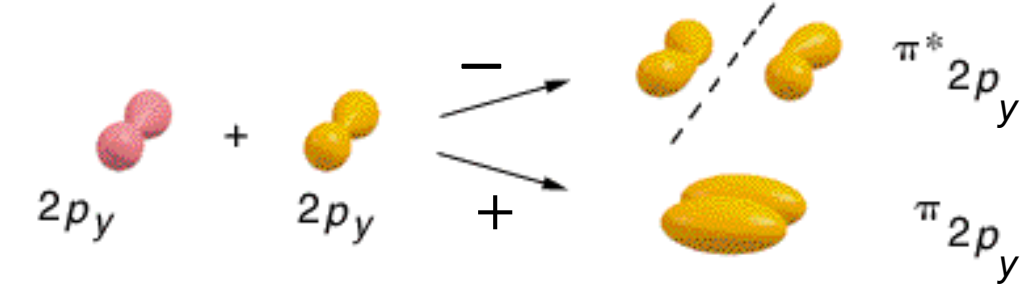
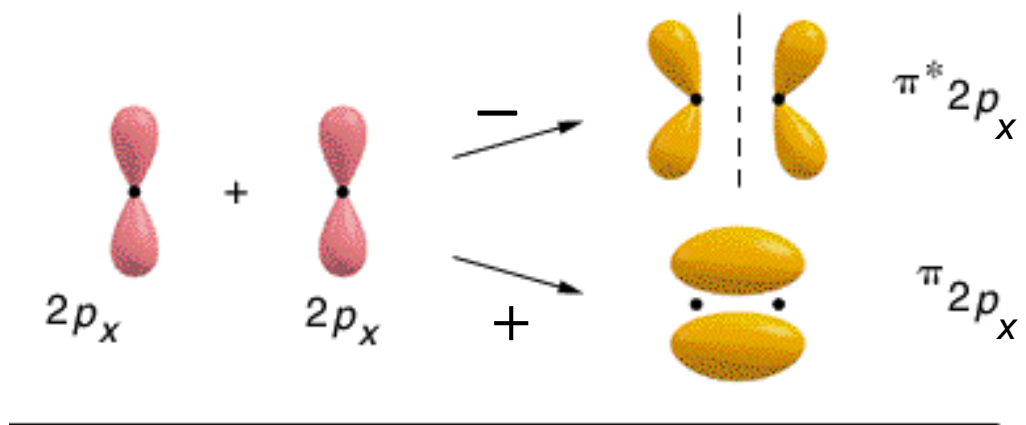
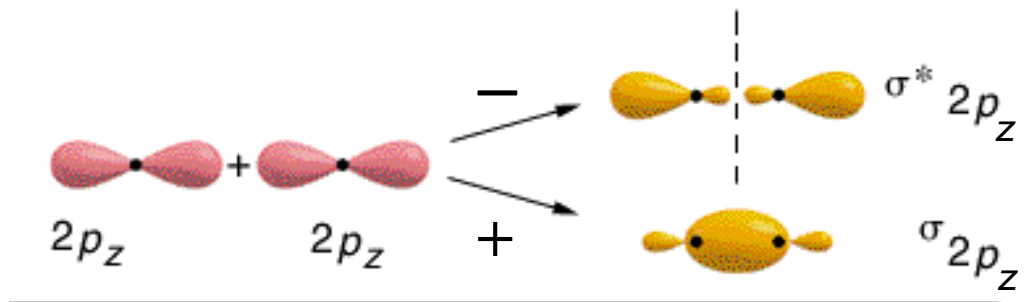

Vazebný MO σ_{2pz}



Protivazebný MO σ_{2pz}^*



Vazebný MO π_{2px}

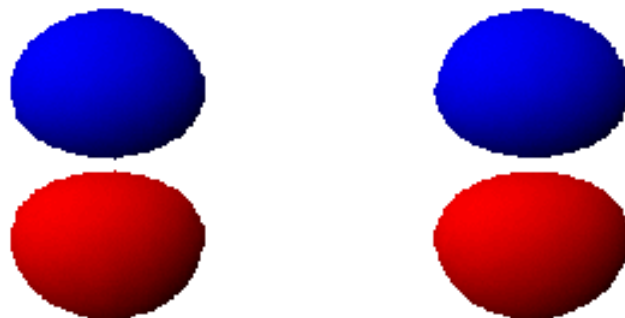

Protivazebný MO π_{2px}^*

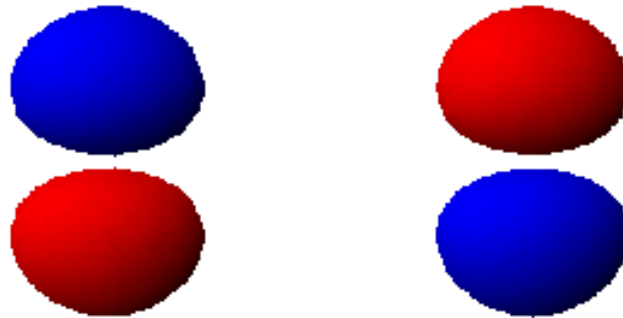

Pi vazba v ethenu pomocí MO

LUMO = nejnižší neobsazený MO

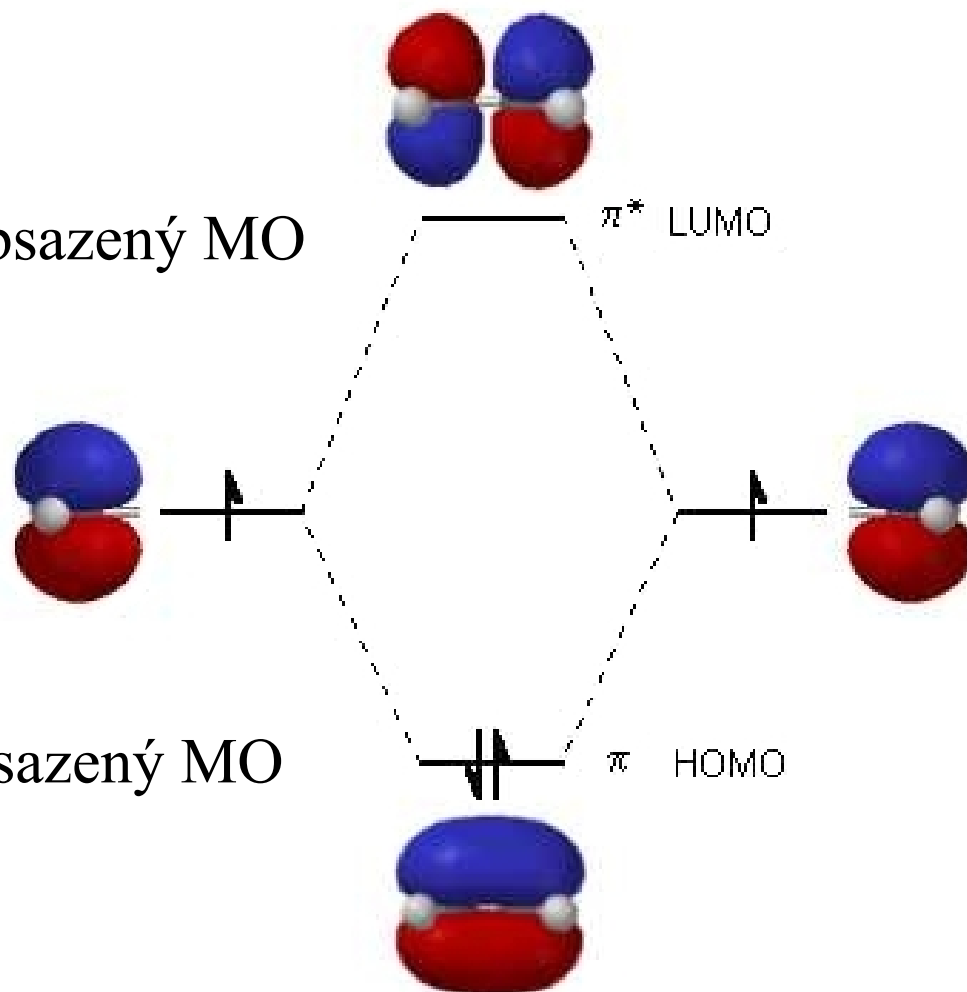

HOMO = nejvyšší obsazený MO

Typy molekulových orbitalů

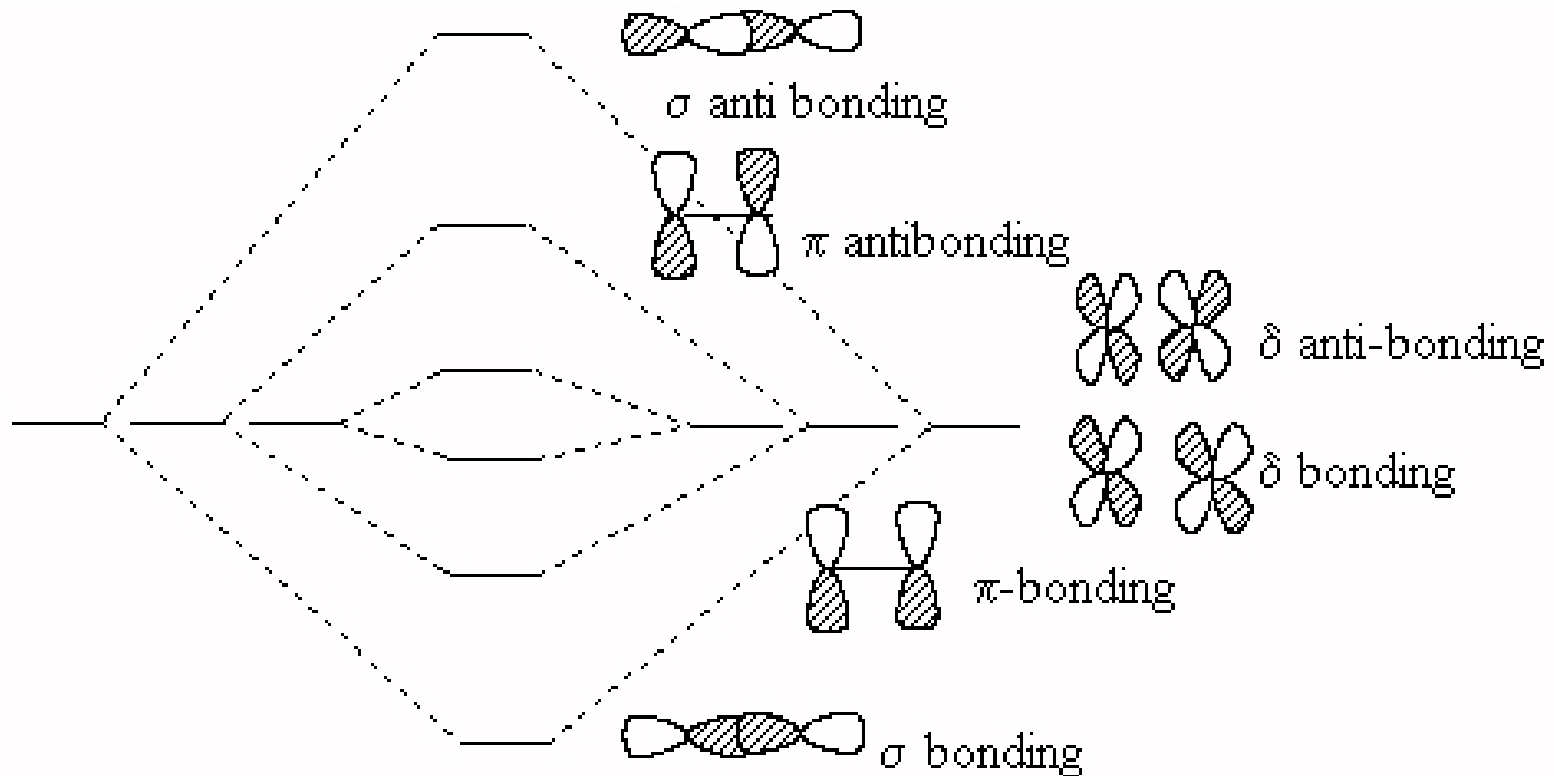

Lepší překryv snižuje energii vazebného MO a zvyšuje energii protivazebného MO: $\sigma > \pi > \delta$

Tvorba MO z d orbitalů

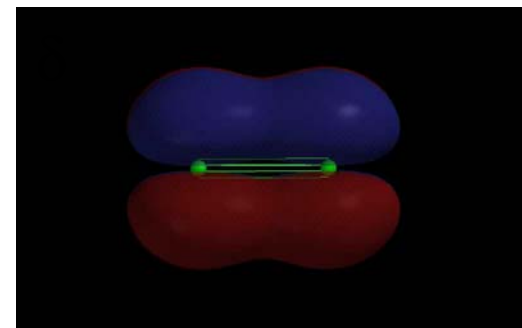
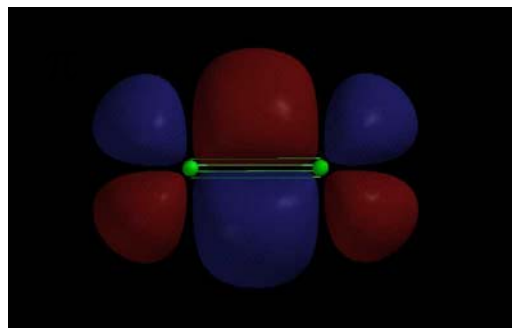
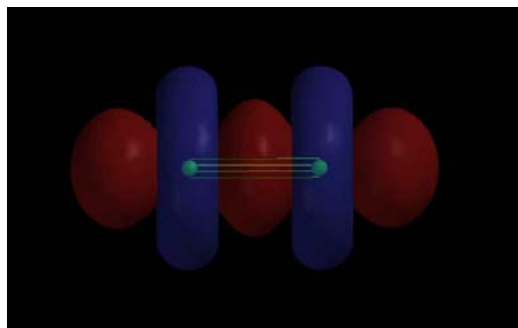
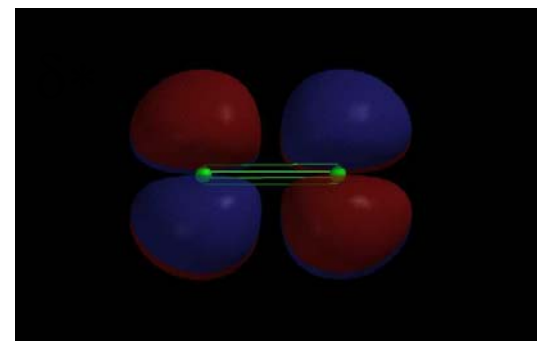
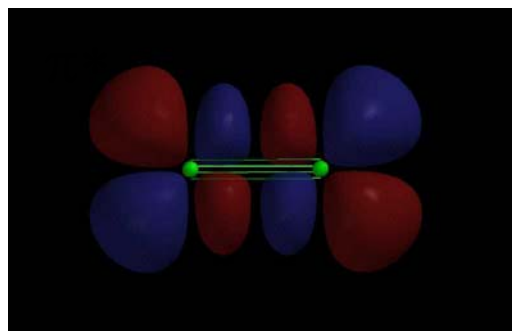
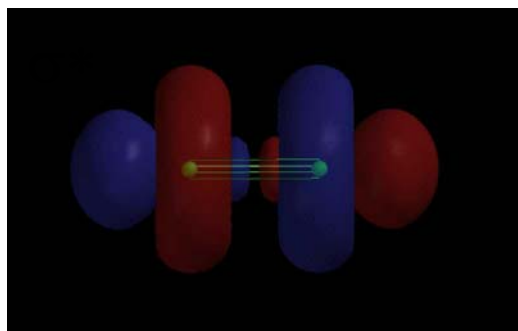
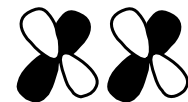
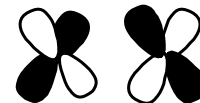
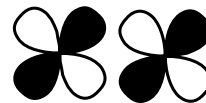

$d(z^2)$ $d(z^2)$

$d(xz)$ $d(xz)$
 $d(yz)$ $d(yz)$

$d(x^2-y^2)$ $d(x^2-y^2)$
 $d(xy)$ $d(xy)$

Mísení s-p orbitalů

Energeticky blízké orbitály na stejném atomu se mohou smíchat

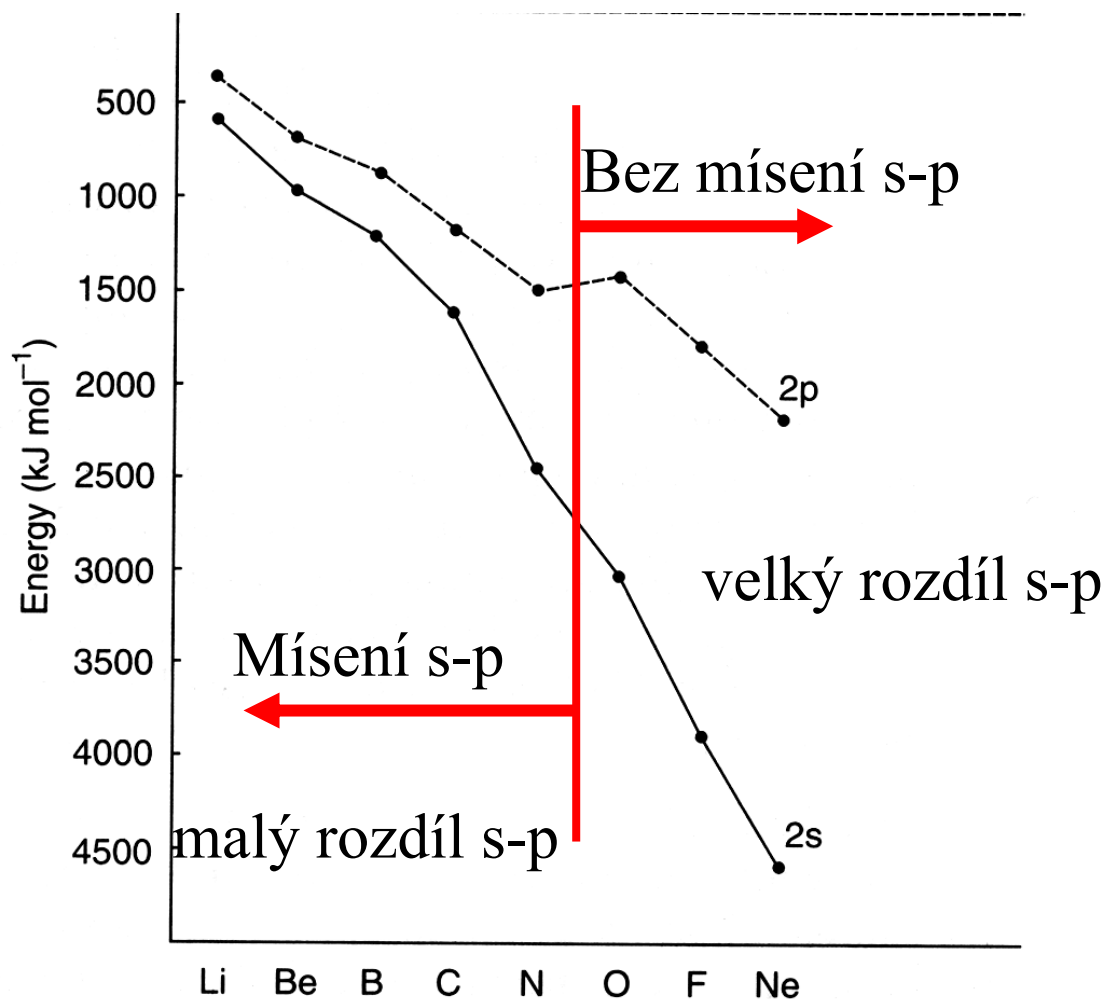

Energie



Bez mísení s-p

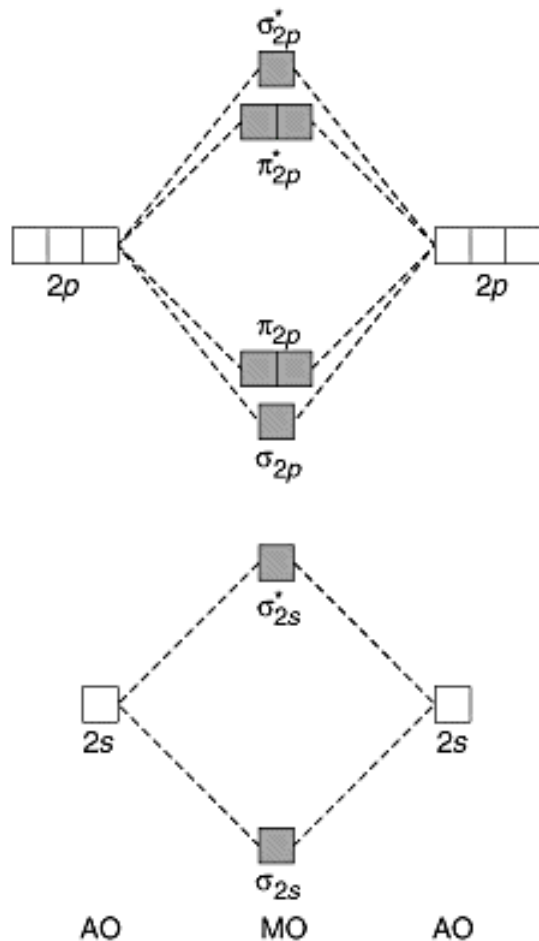

A MO energy levels for O₂, F₂, and Ne₂

Pro O₂ až Ne₂

Mísení s-p

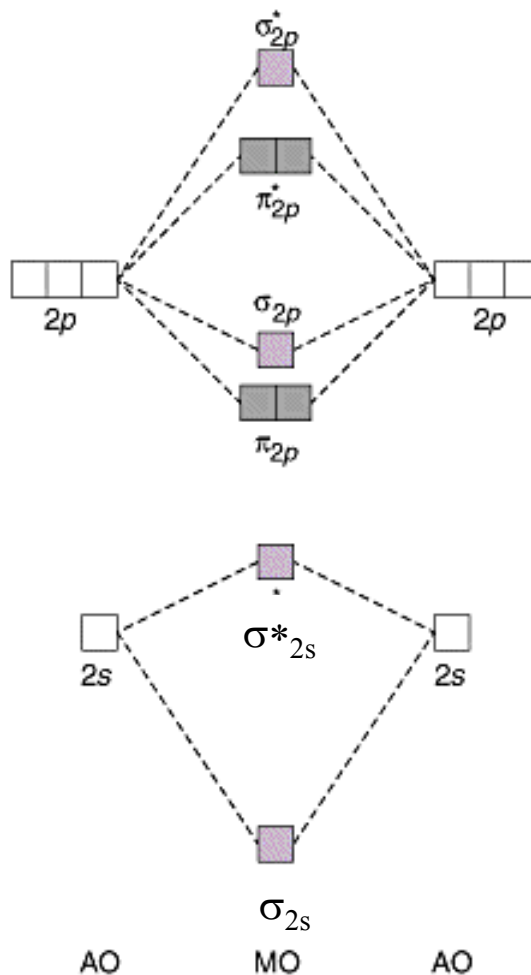

B MO energy levels for B₂, C₂, and N₂

Pro H₂ až N₂

Diatomické molekuly

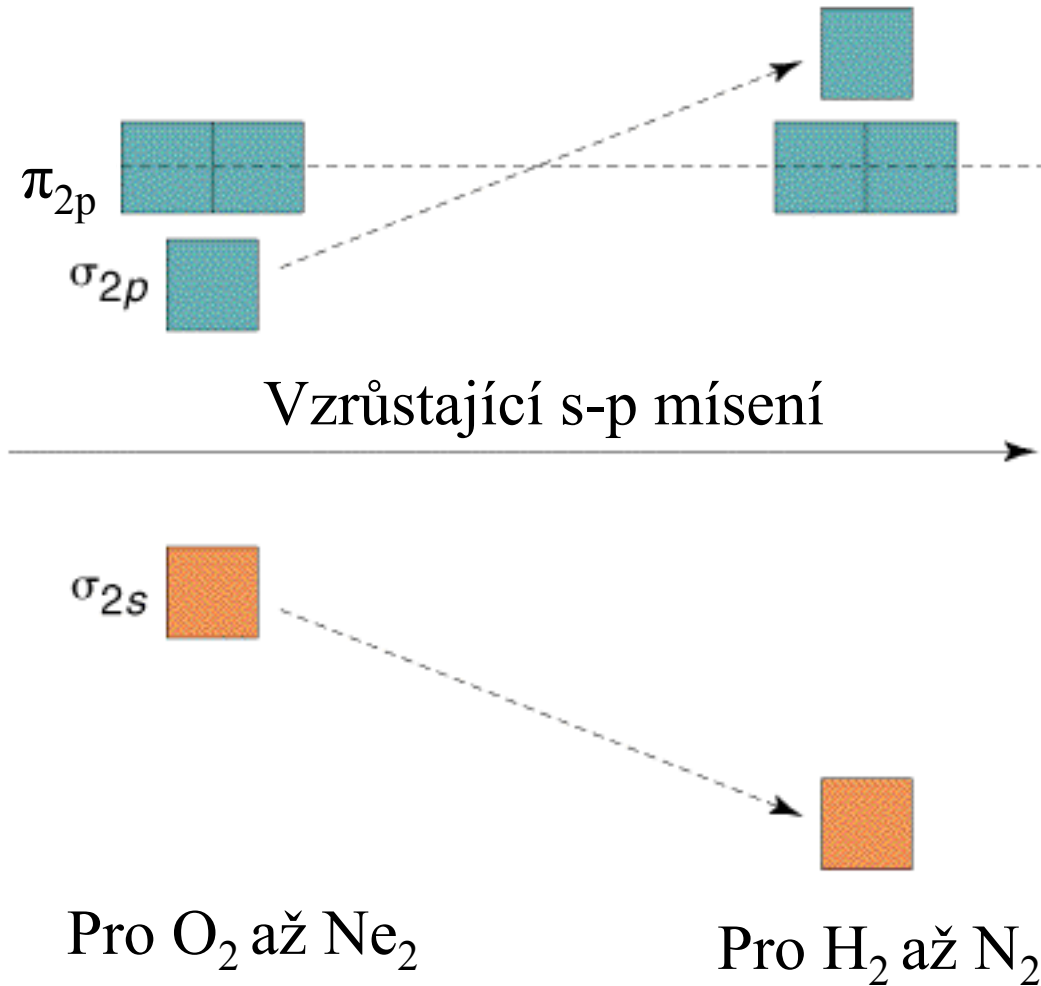

Interakční diagram pro Li₂ až N₂

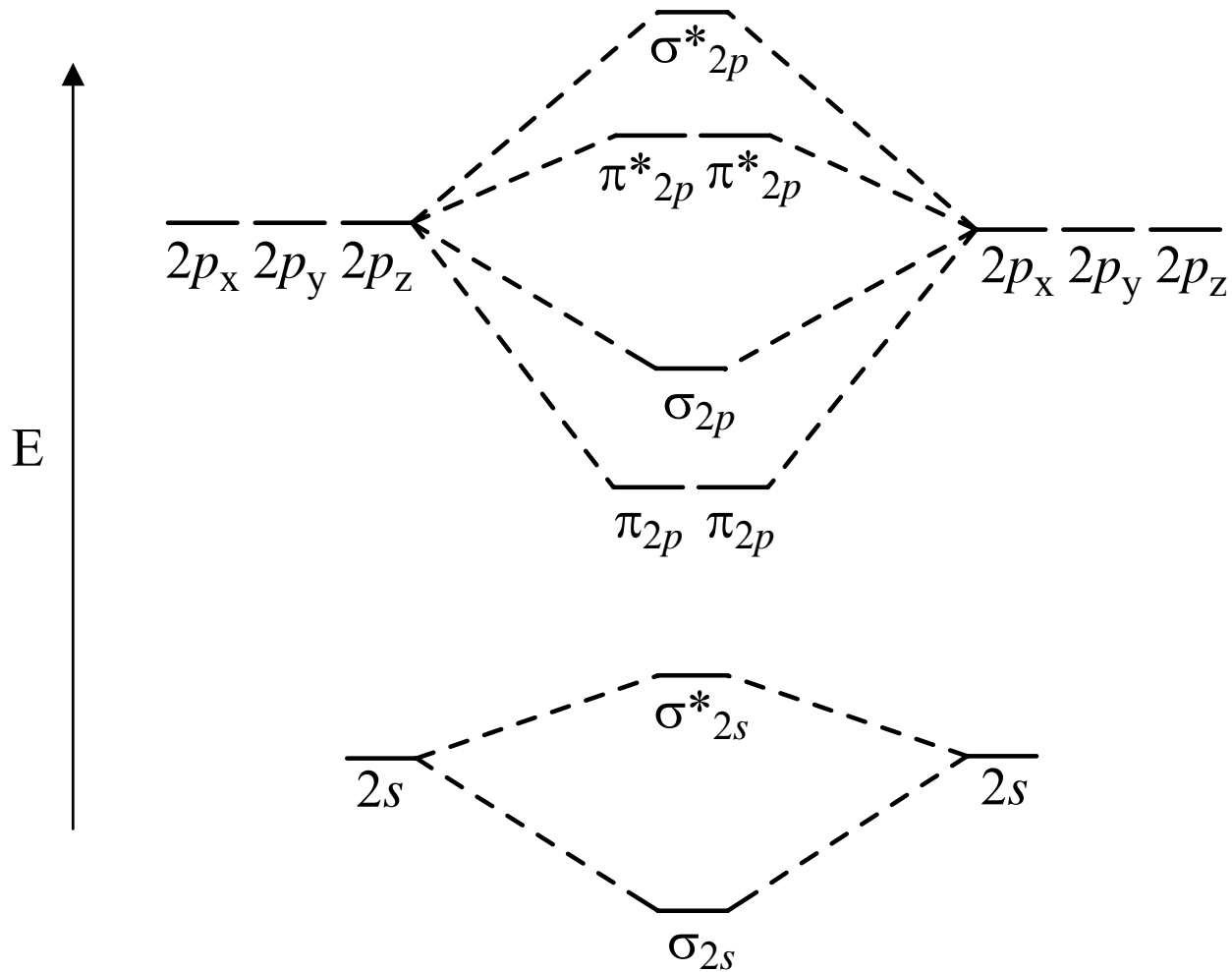

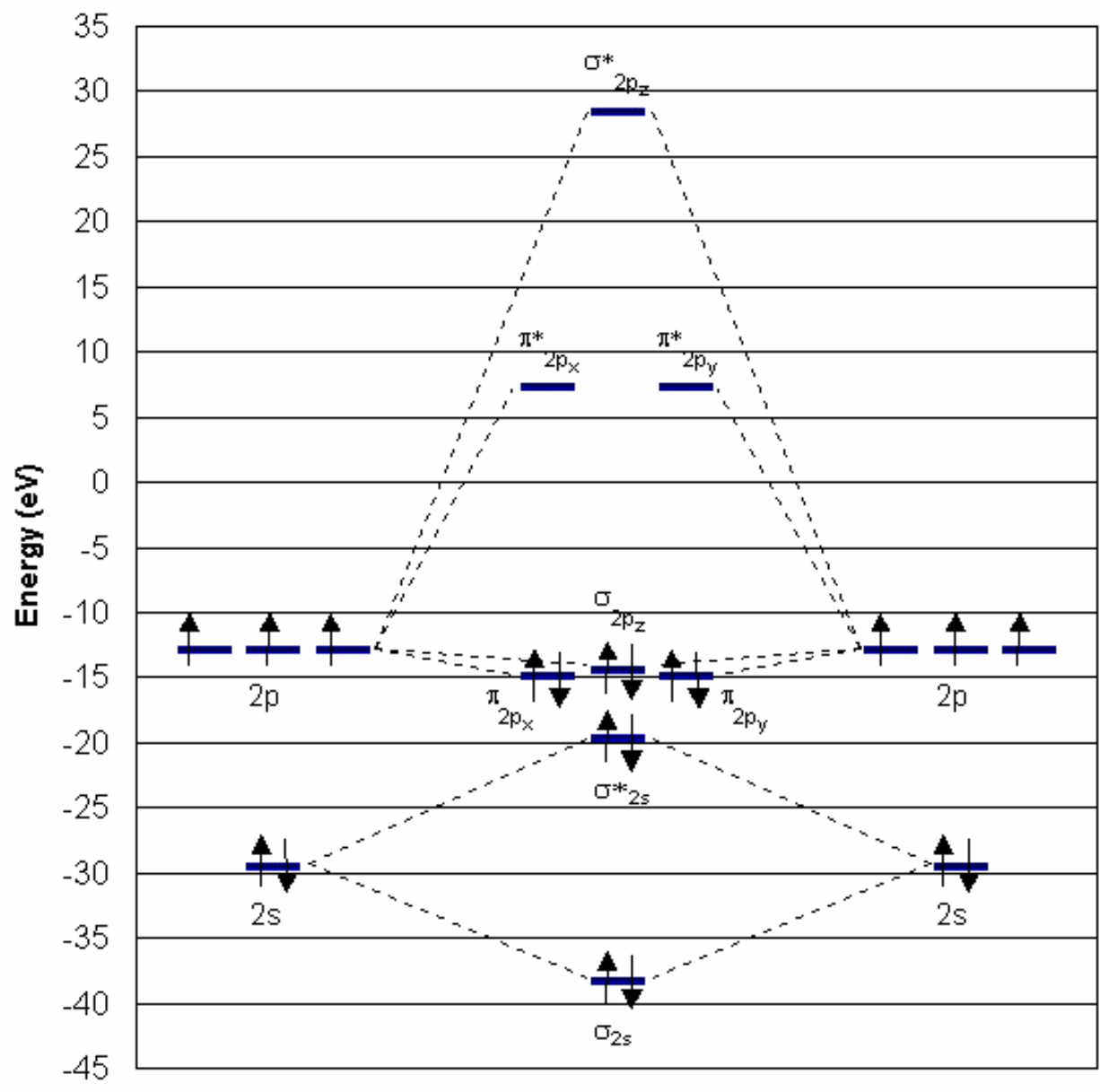

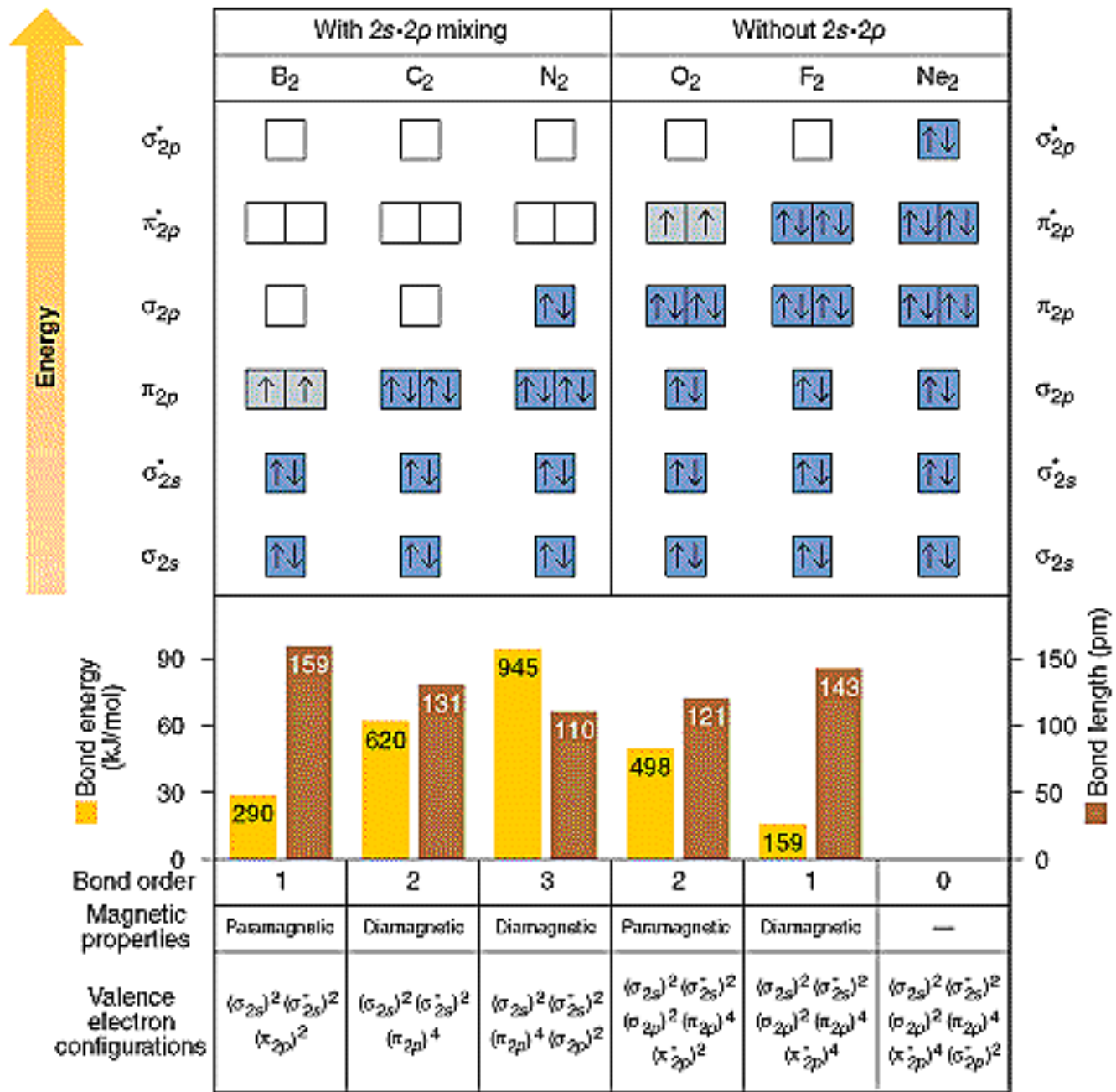

Diatomické molekuly v plynné fázi

		Délka (pm)	E_{vaz} (kJ mol ⁻¹)
Li-Li	σ_{2s}^2	267	110
Be..Be	$\sigma_{2s}^2 \sigma_{2s}^{*2}$?	?
B-B	$\sigma_{2s}^2 \sigma_{2s}^{*2} \pi_{2p}^2$	159	290
C=C	$\sigma_{2s}^2 \sigma_{2s}^{*2} \pi_{2p}^4$	124	602
N≡N	$\sigma_{2s}^2 \sigma_{2s}^{*2} \pi_{2p}^4 \sigma_{2p}^2$	110	942
O=O	$\sigma_{2s}^2 \sigma_{2s}^{*2} \sigma_{2p}^2 \pi_{2p}^4 \pi_{2p}^{*2}$	121	494
F-F	$\sigma_{2s}^2 \sigma_{2s}^{*2} \sigma_{2p}^2 \pi_{2p}^4 \pi_{2p}^{*4}$	142	155

Diatomické molekuly

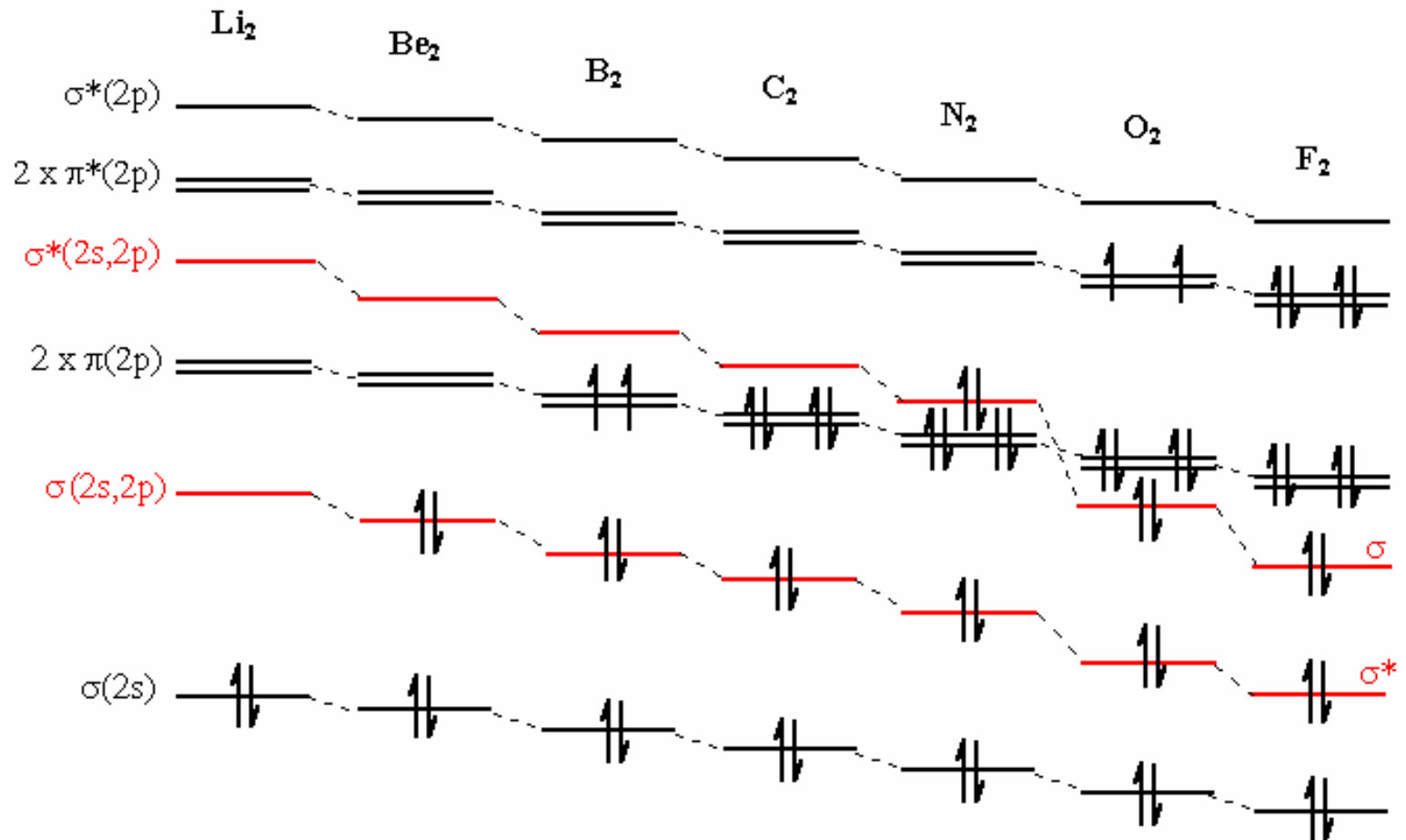

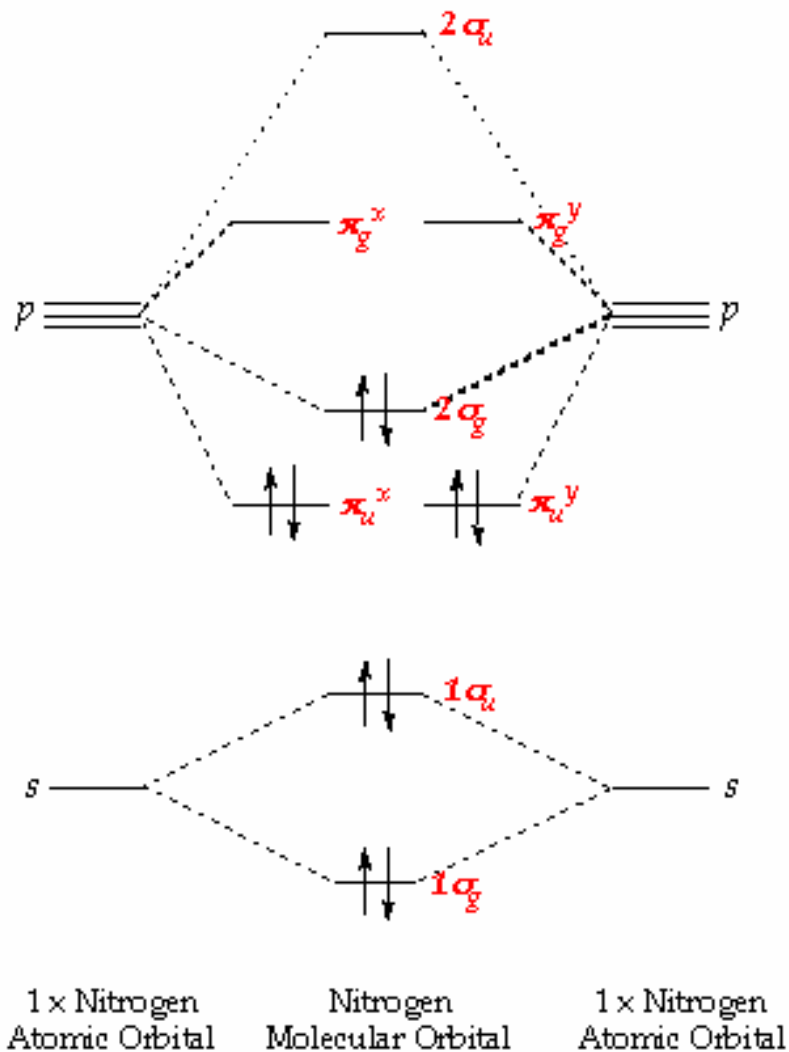

N_2 trojná vazba

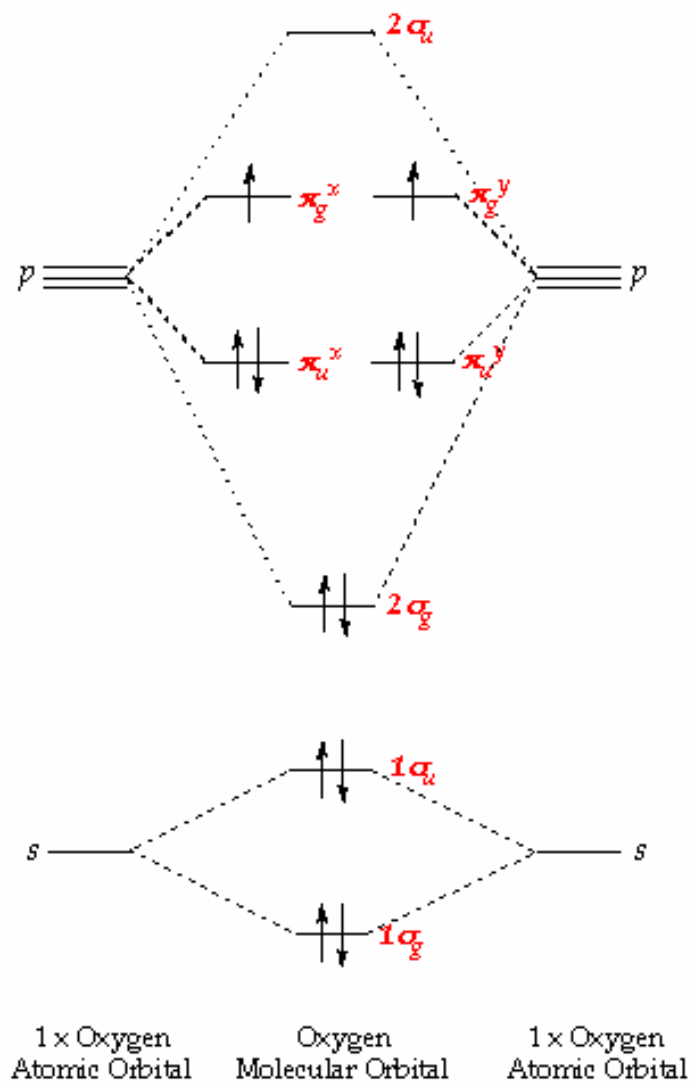

O_2 paramagnetická molekula

Izoelektronové sloučeniny

Počet val. elektr.	Příklady diatomických částic
9	BO, CN, CP, CO ⁺
10	N ₂ , CO, CN ⁻ , BF, NO ⁺ , TiO, SiO
11	O ₂ ⁺ , ·NO, SO ⁺
12	O ₂ , SO
13	O ₂ ⁻ , Cl ₂ ⁺ , ·ClO
14	F ₂ , O ₂ ²⁻ , ClO ⁻

Kyslík a jeho molekulové ionty

	O_2^+	O_2	O_2^-	O_2^{2-}
Počet valenčních elektronů	11	12	13	14
Obsazení HOMO π_x^* a π_y^*	↑	↑ ↑	↑↓ ↑	↑↓ ↑↓
Řád vazby	2.5	2.0	1.5	1.0
Délka vazby, pm	112	121	126	149

Multiplicita

$$M = 2S + 1$$

S = součet nepárových spinů ($\frac{1}{2}$) v atomu nebo molekule

M	název	S	
1	singlet	0	↑↓
2	dublet	$\frac{1}{2}$	↑
3	triplet	1	↑↑
4	kvartet	$1\frac{1}{2}$	↑↑↑
5	kvintet	2	↑↑↑↑
6	sextet	$2\frac{1}{2}$	↑↑↑↑↑

Singletový kyslík $^1\Delta$

Tripletový kyslík $^3\Sigma$

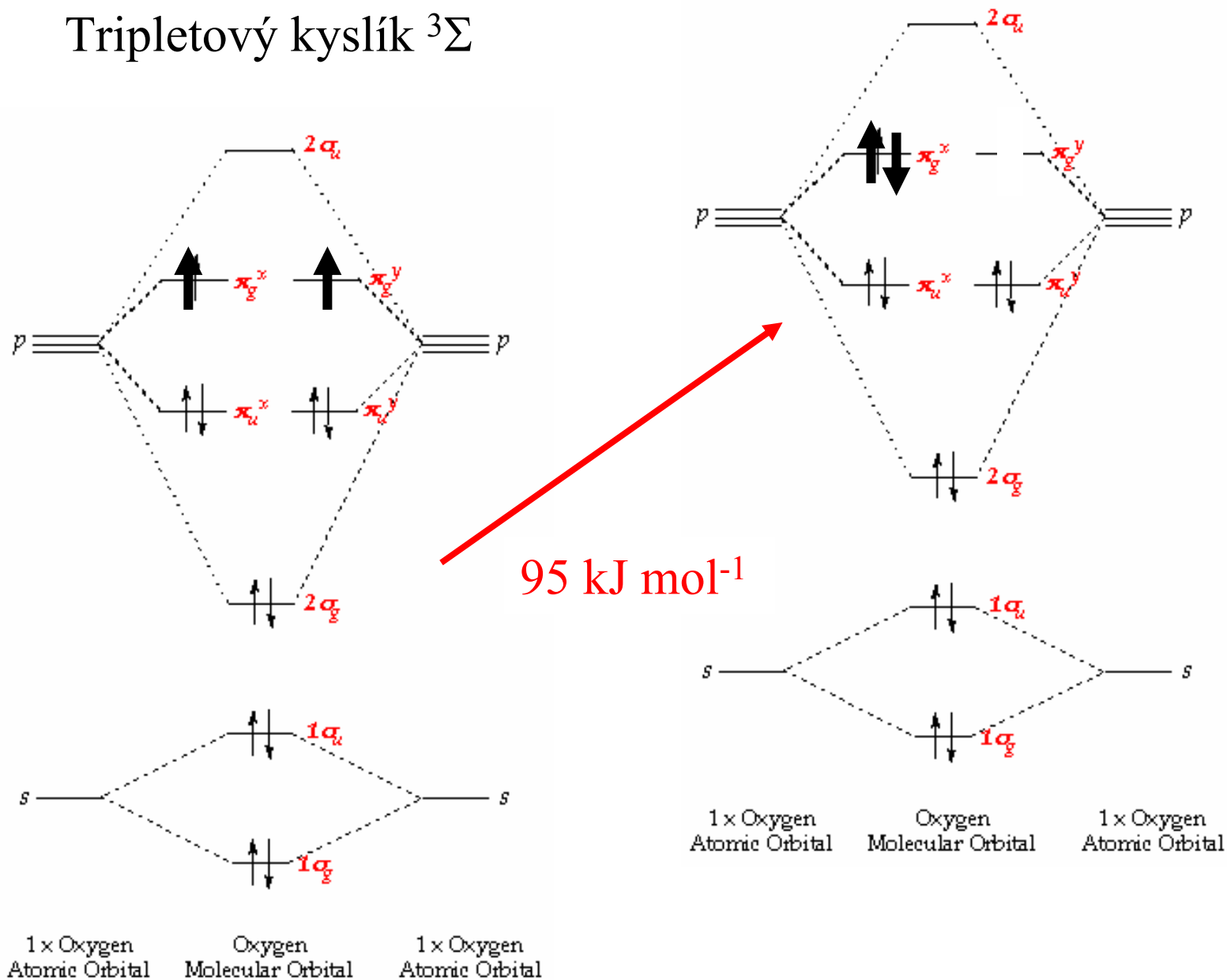

MO v polárních molekulách

$$\Psi^* = c_3 \Psi_A - c_4 \Psi_B$$

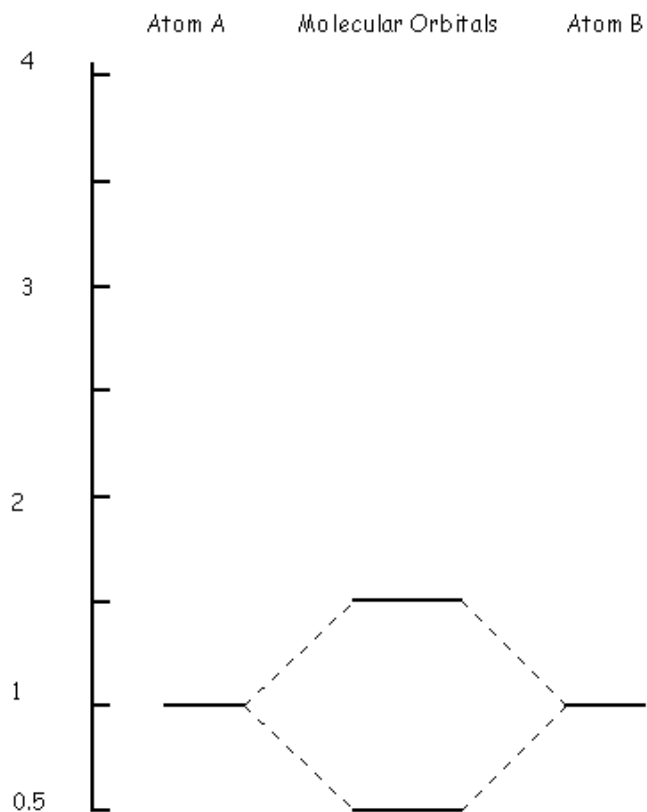

$$\Psi = c_1 \Psi_A + c_2 \Psi_B$$

$\chi(A) \ll \chi(B)$ iontová vazba

$c_1 \rightarrow 0$ vazebný MO = Ψ_B

$c_4 \rightarrow 0$ protivazebný MO = Ψ_A

$\chi(A) < \chi(B)$ polární vazba

$c_1 < c_2$ vazebný MO má větší příspěvek od B

$c_3 > c_4$ protivazebný MO má větší příspěvek od A

$\chi(A) = \chi(B)$ nepolární vazba

$c_1 = c_2$ $c_3 = c_4$

stejný příspěvek od obou atomů

MO v polárních molekulách, HF

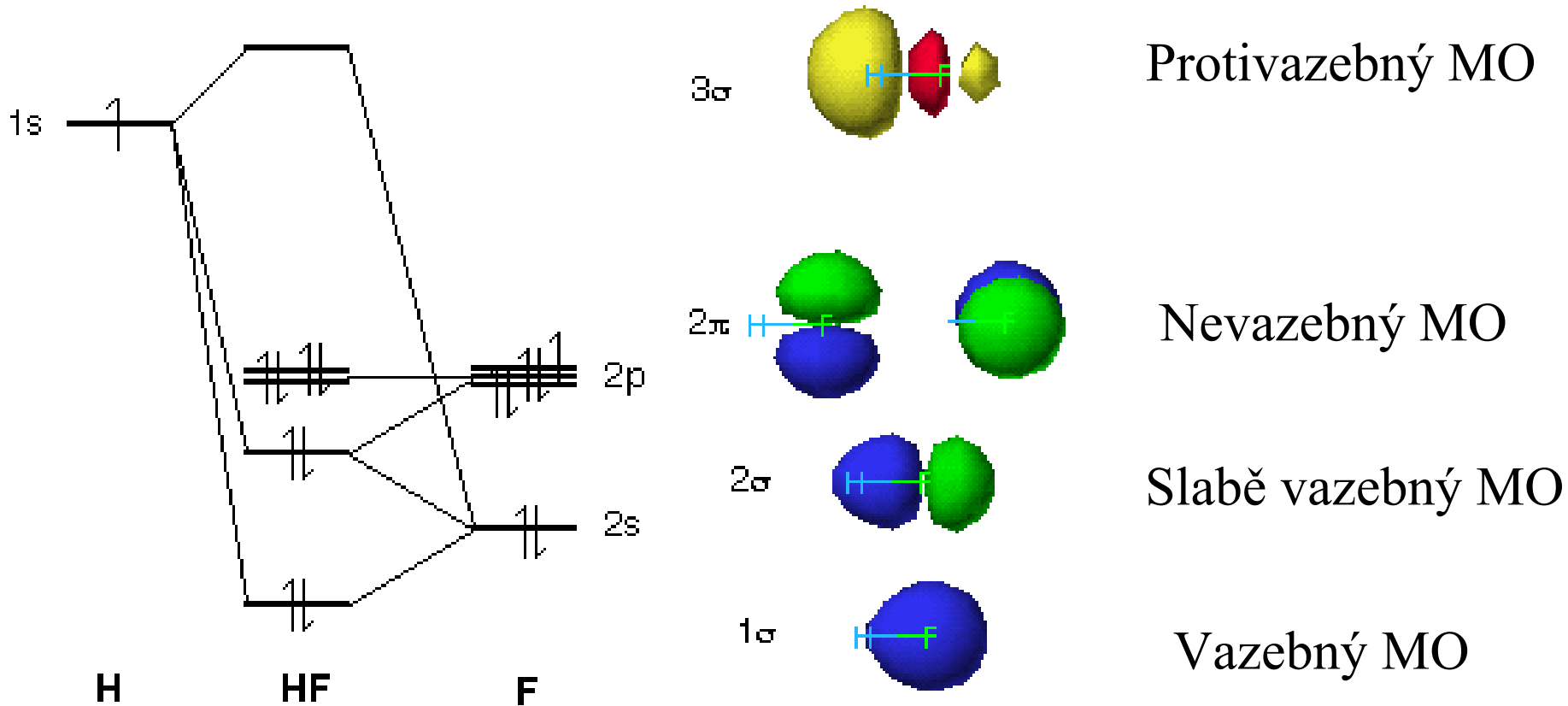

MO v CO

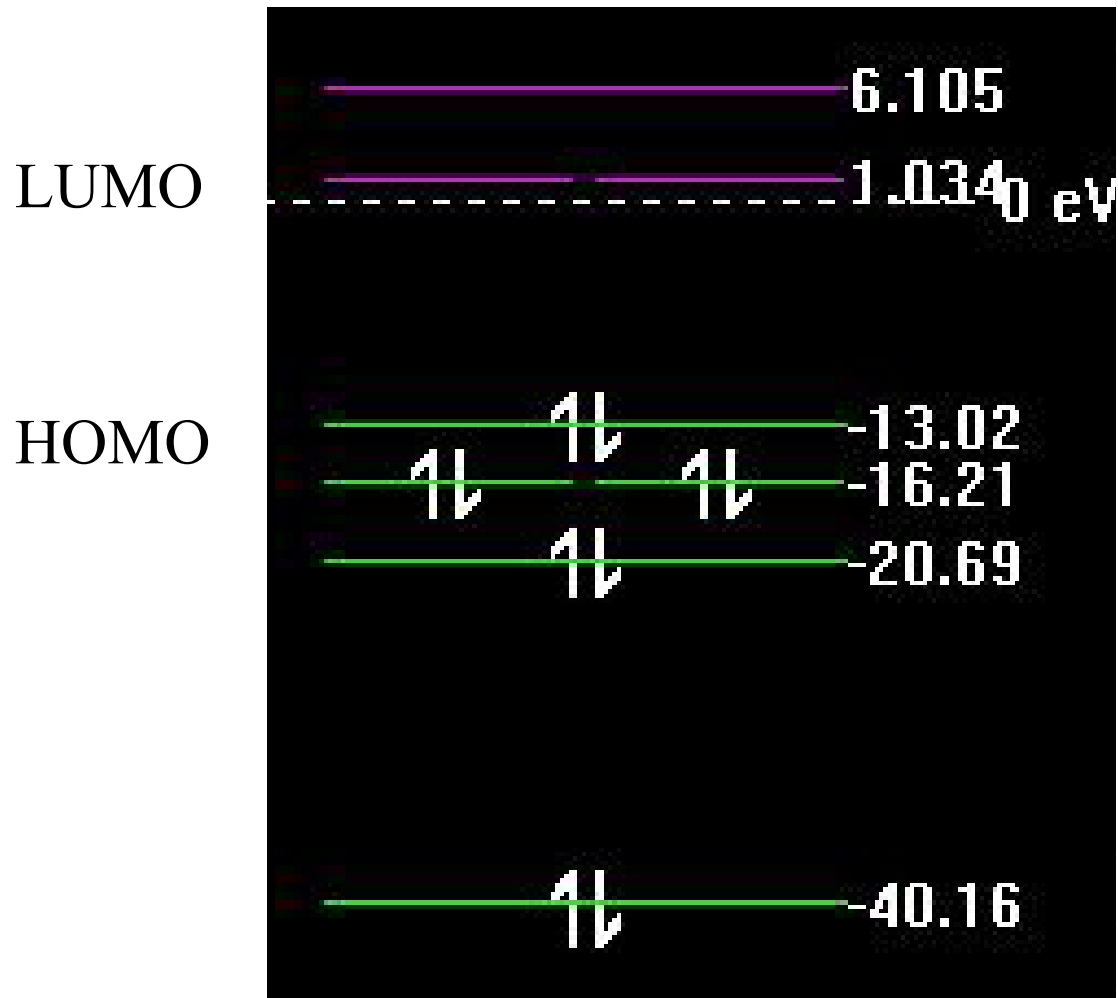

LUMO

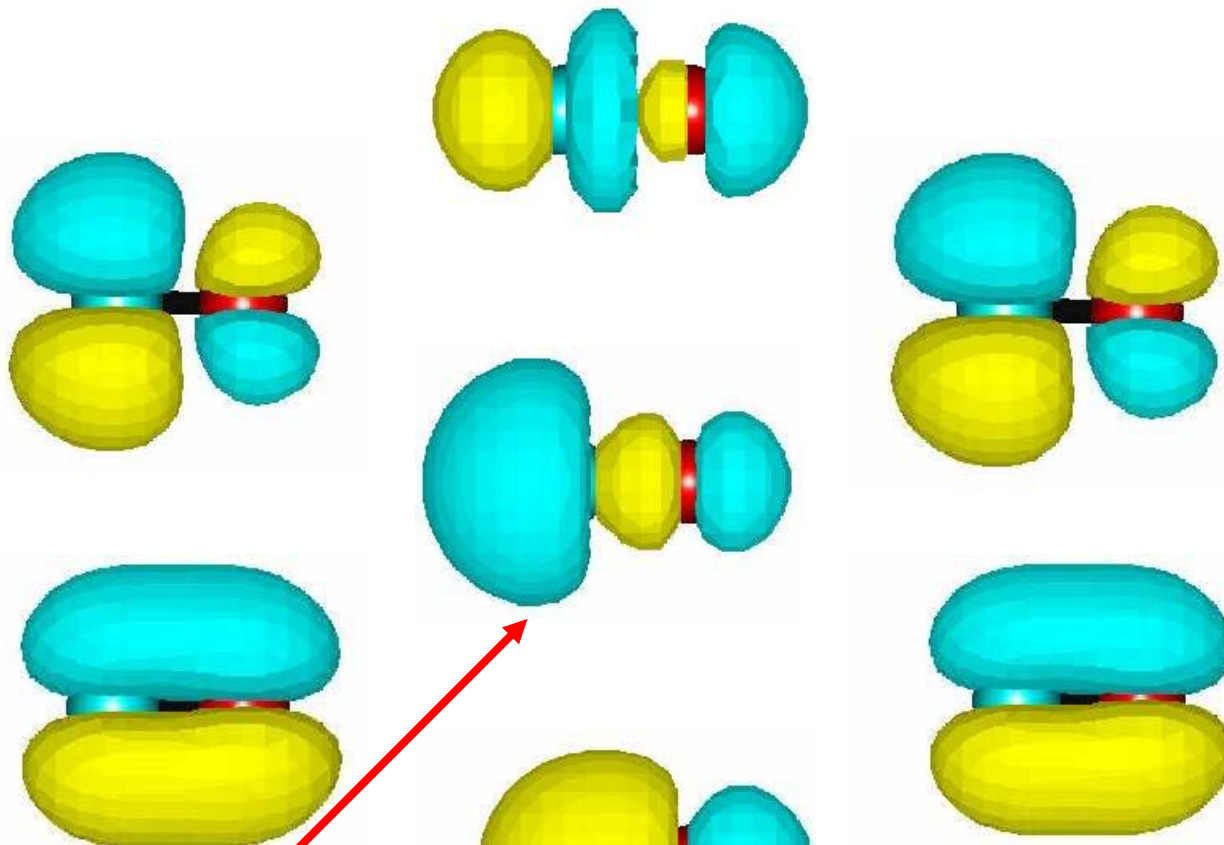

Volný e pár na C
HOMO

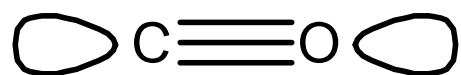

Volný e pár na O

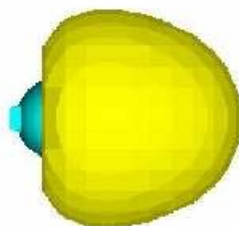

Molekulové orbitály CH₄

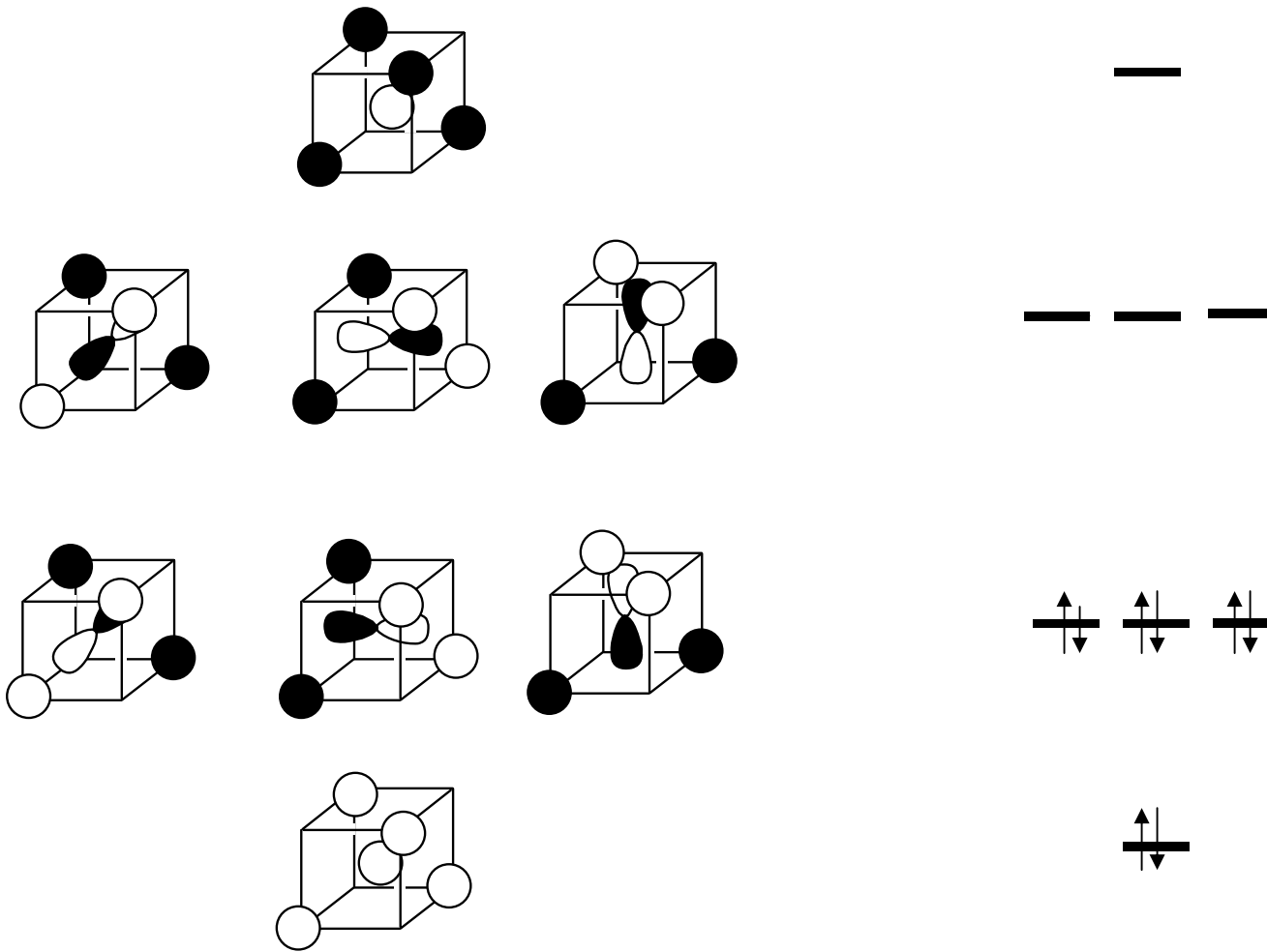

Molekulové orbitály CH₄

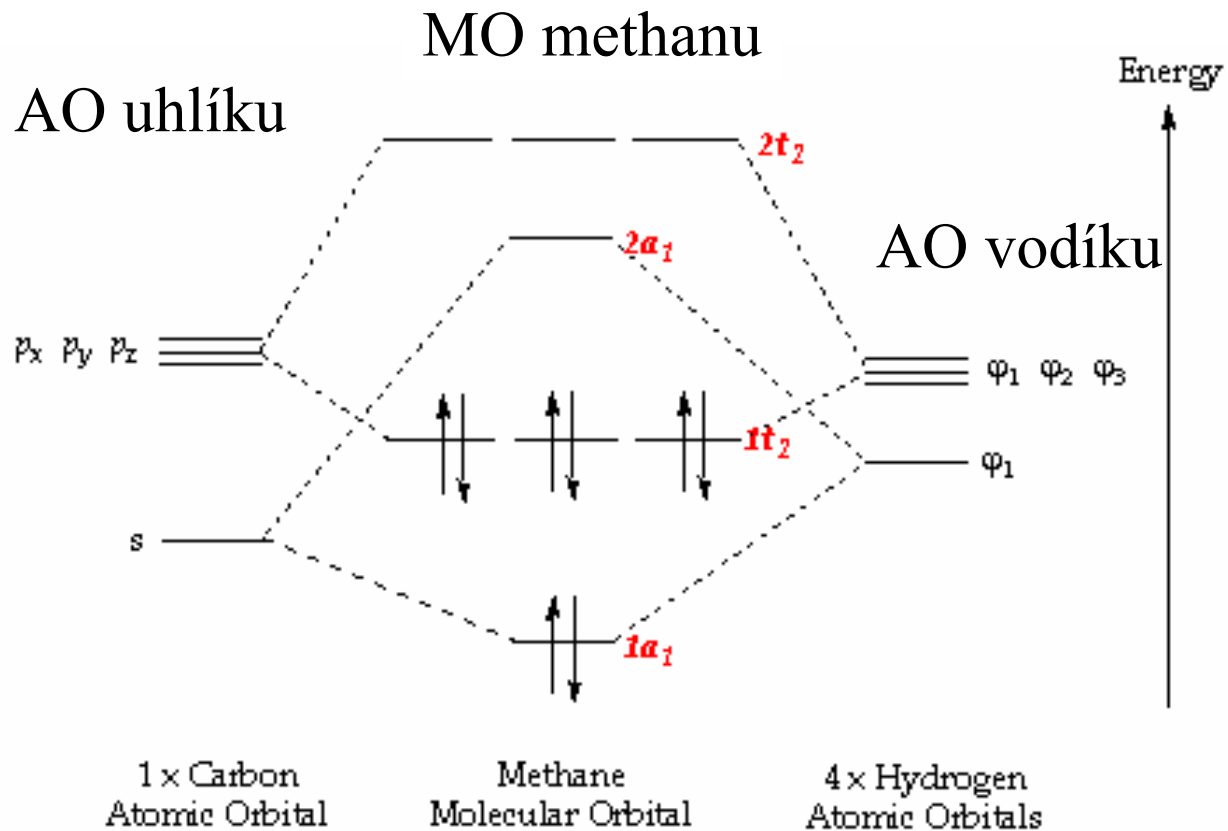

PES methanu souhlasí s modelem MO

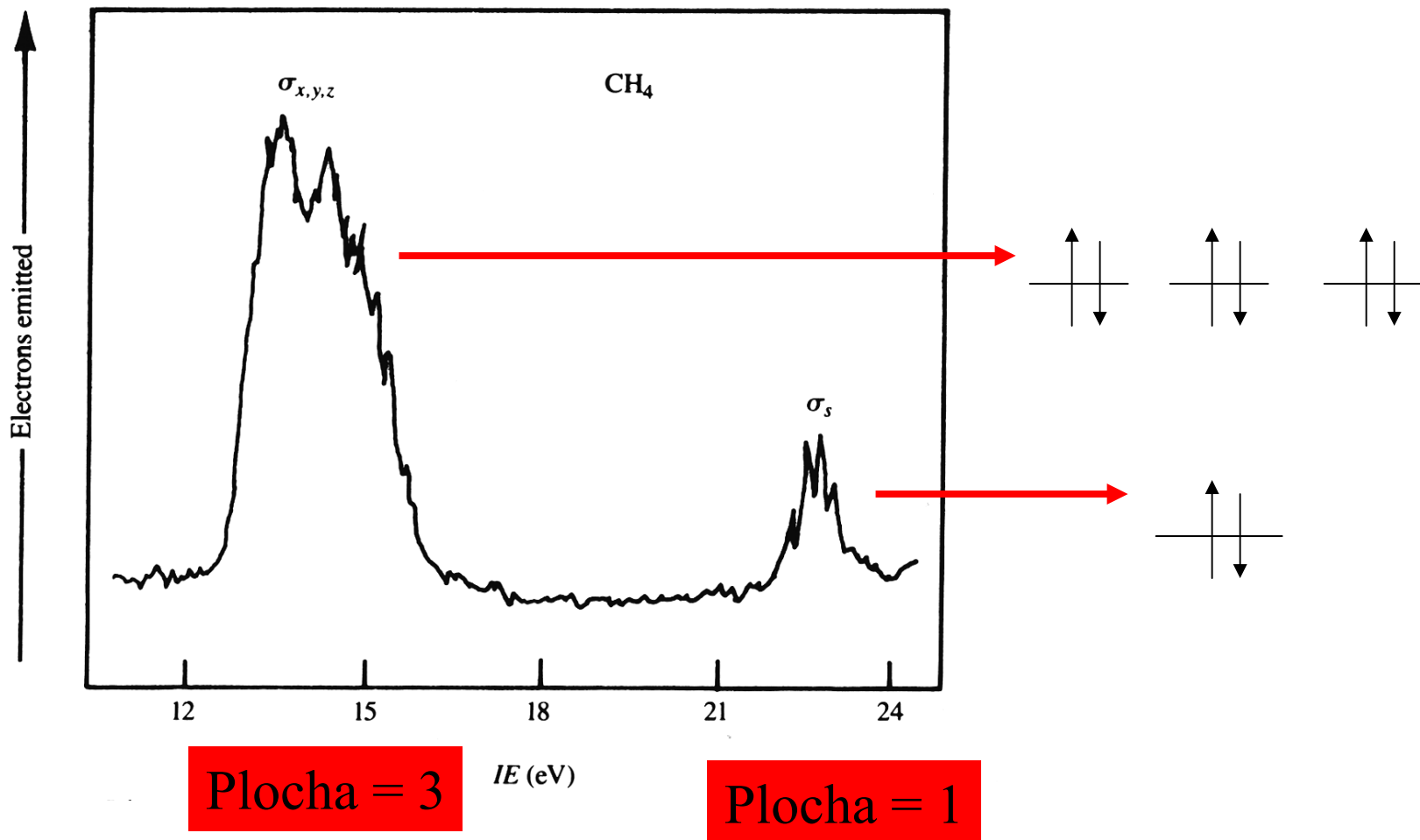

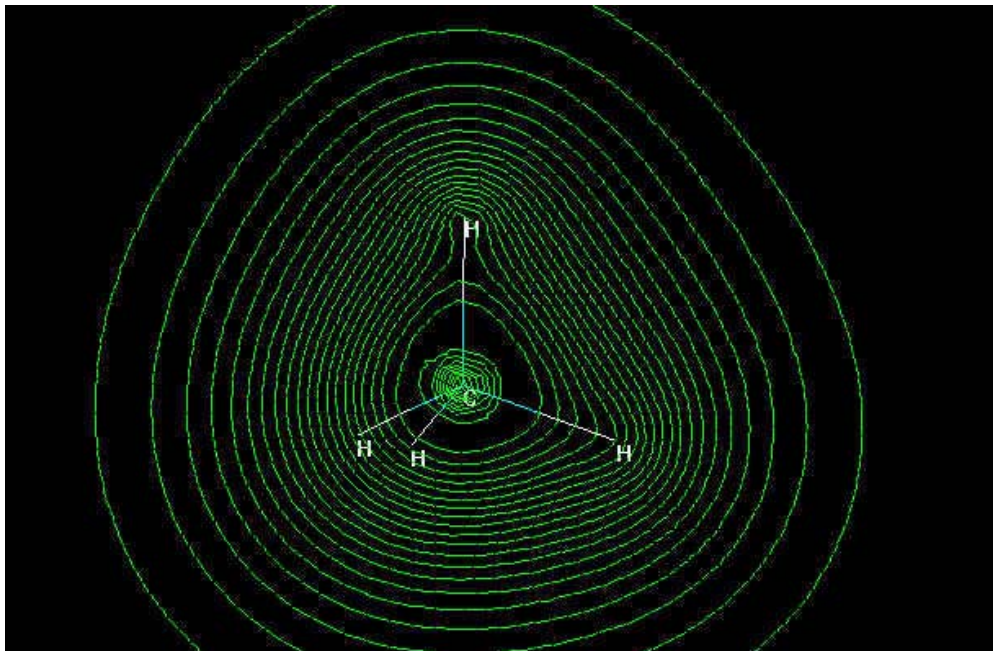
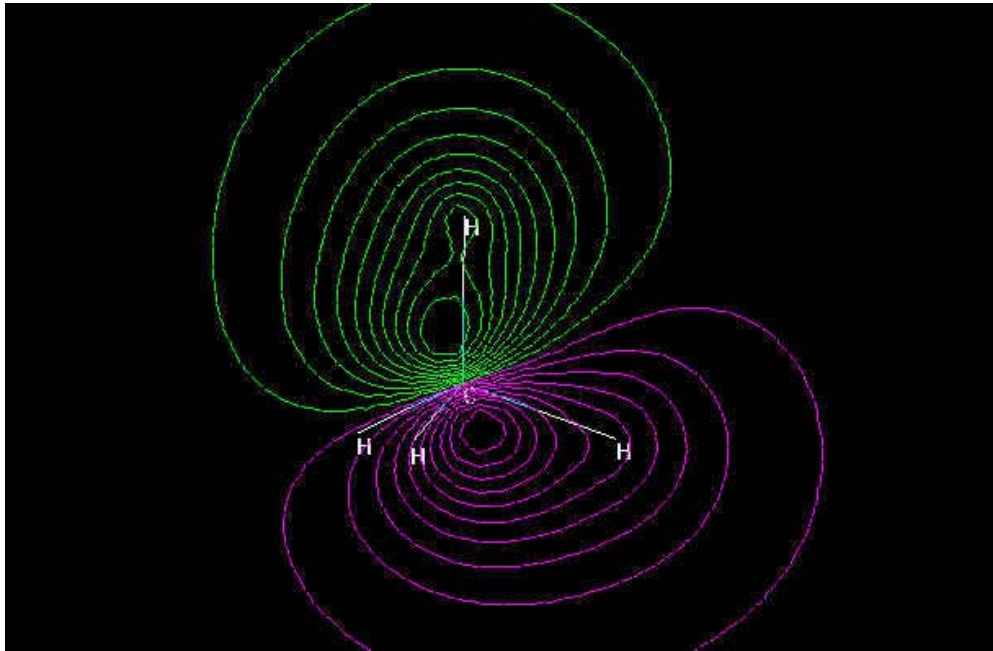

Benzen

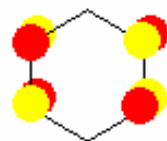
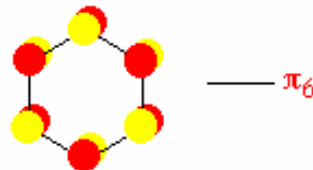
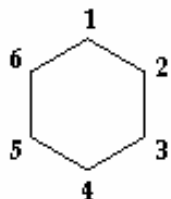
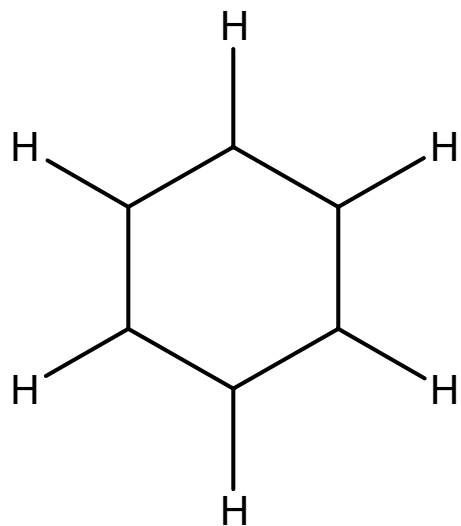

π_4

π_5

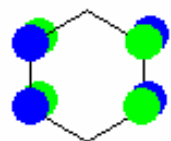
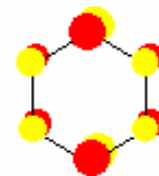

π_2

π_3

π_3

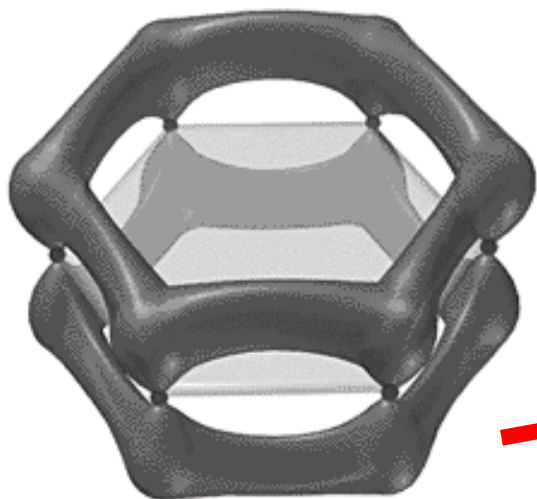
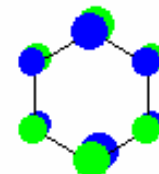

A Benzene, C_6H_6

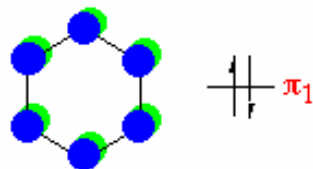

Oddělený pohled na sigma a pi systém

Vazebné MO v benzenu

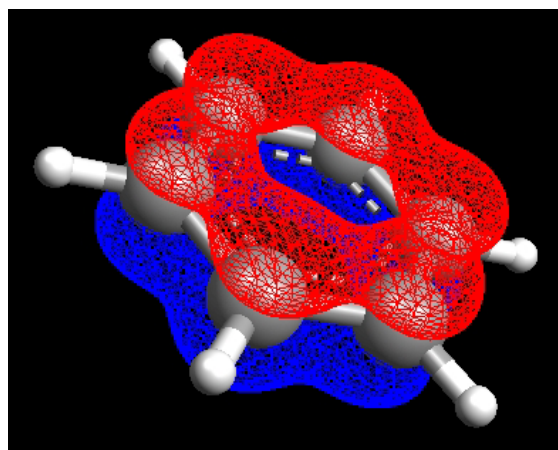
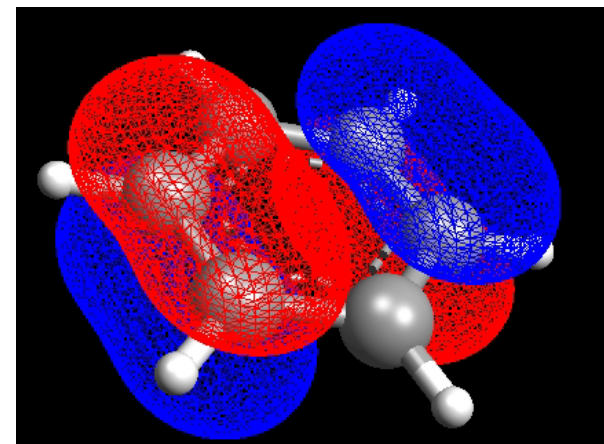
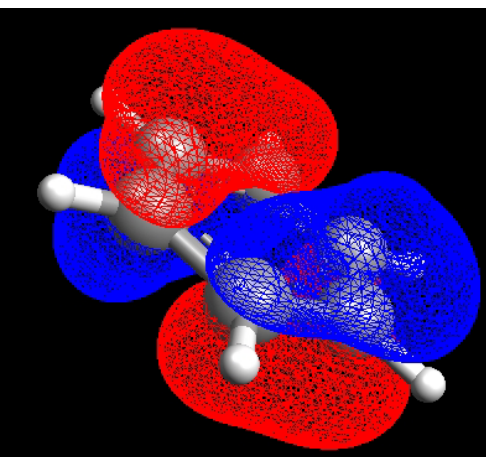
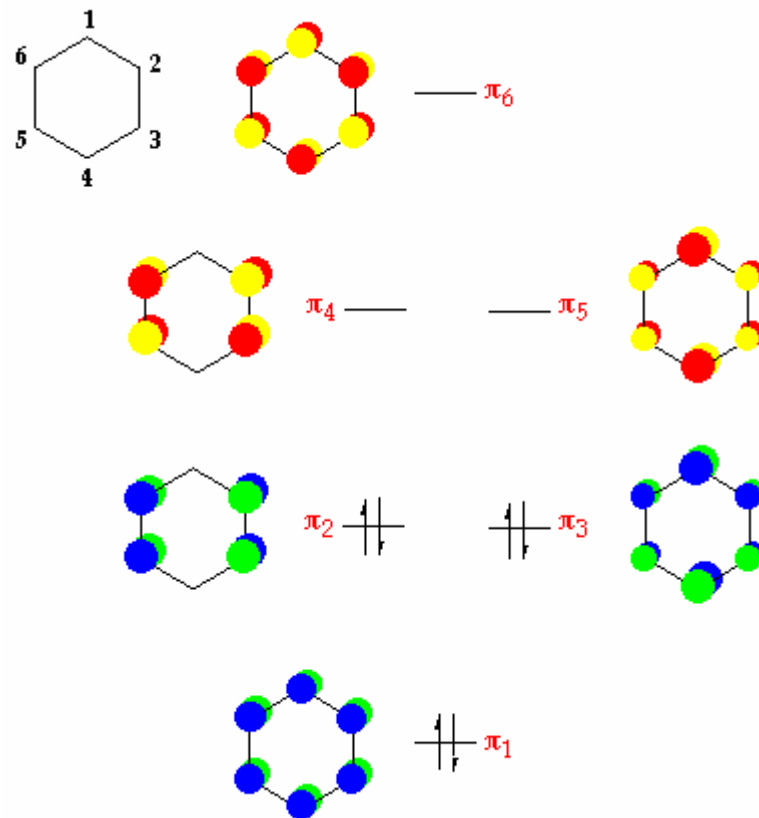

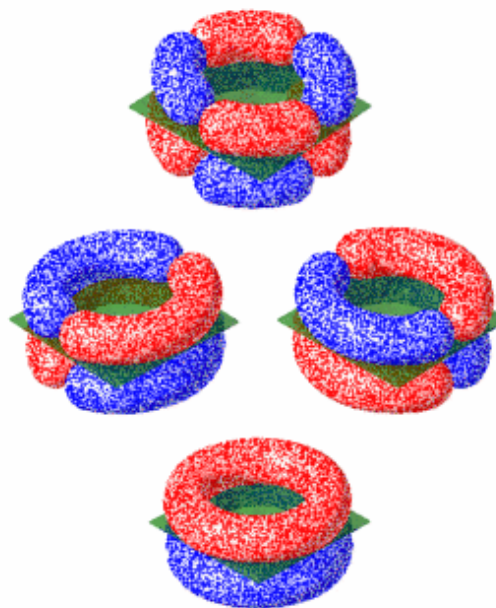
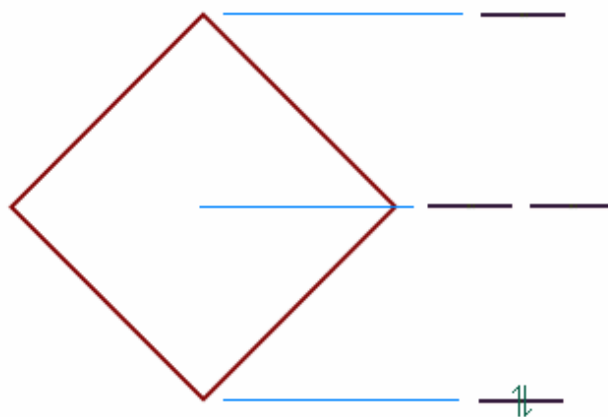
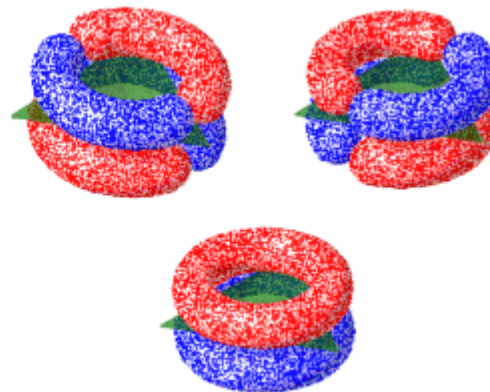
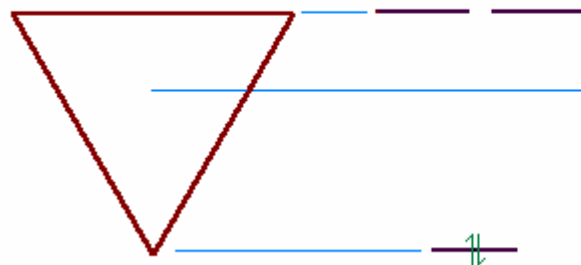

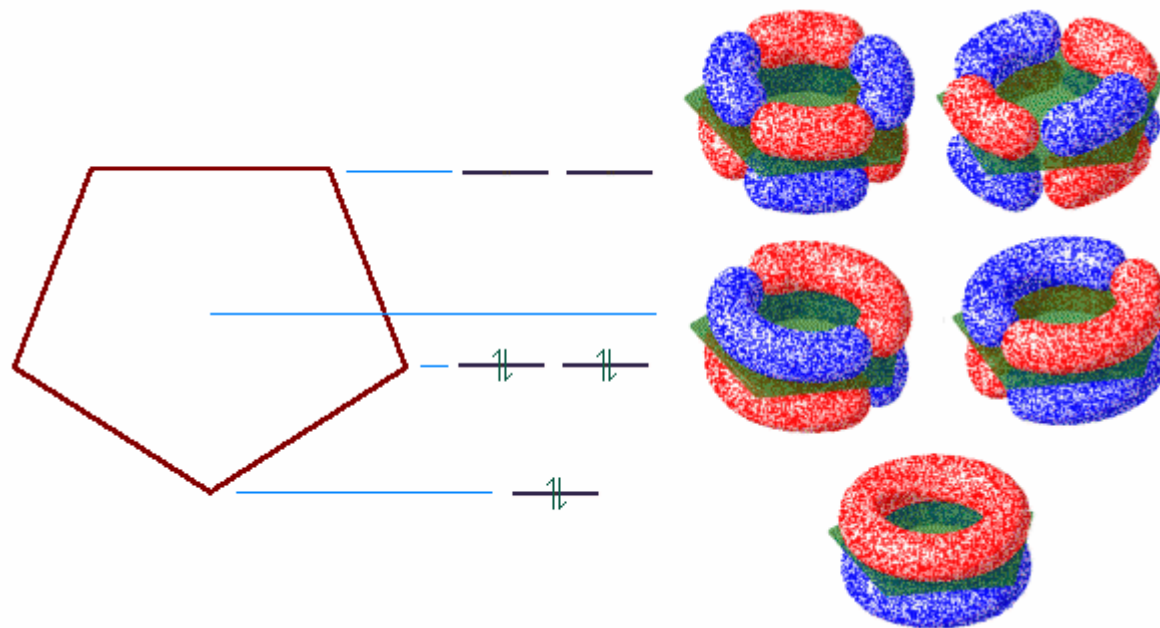
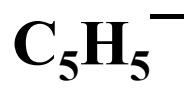

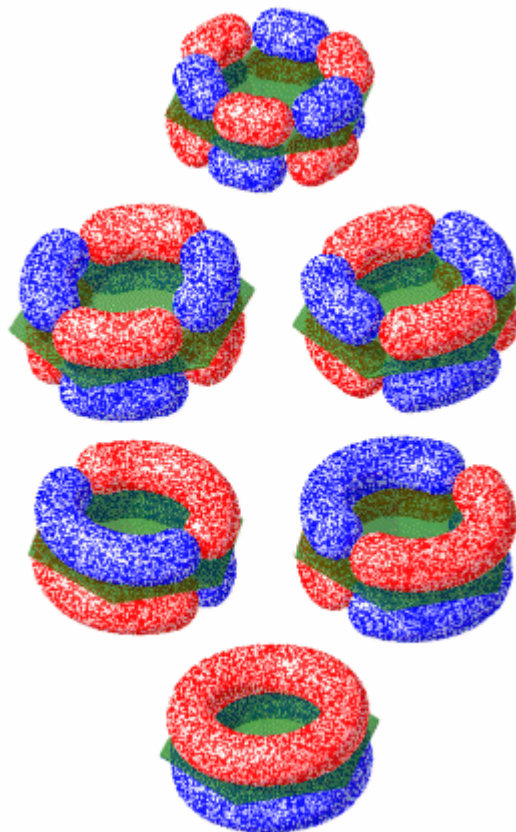
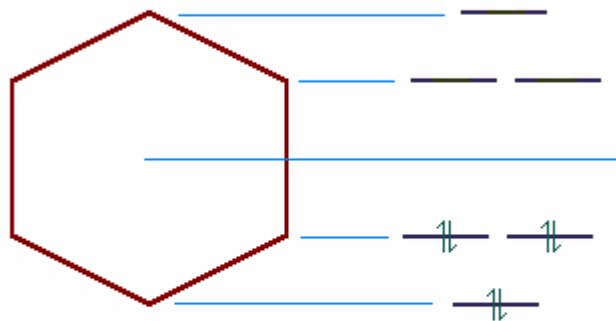

1,3-butadien

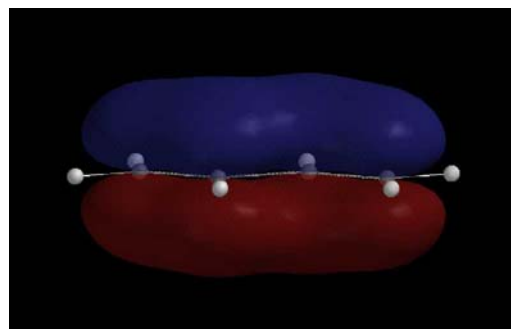
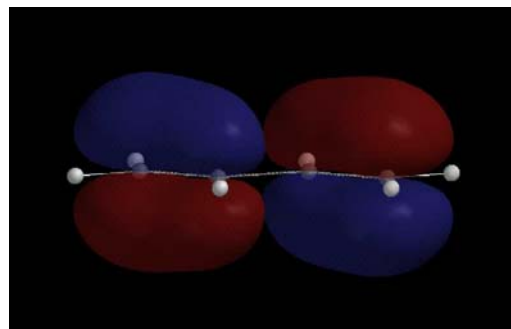
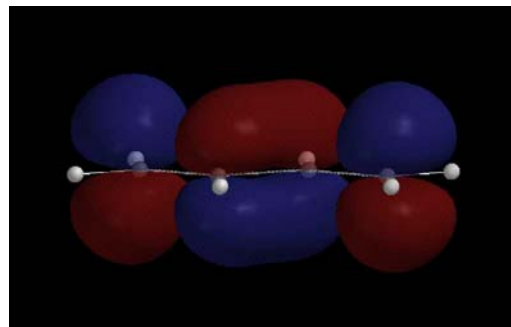
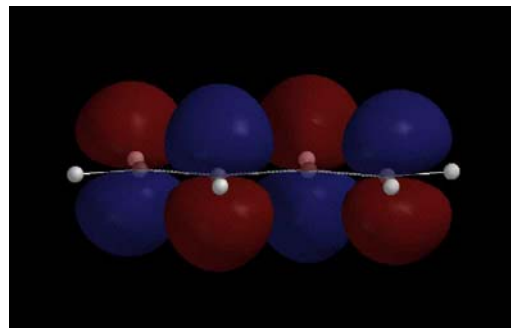
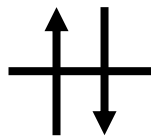
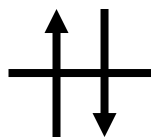
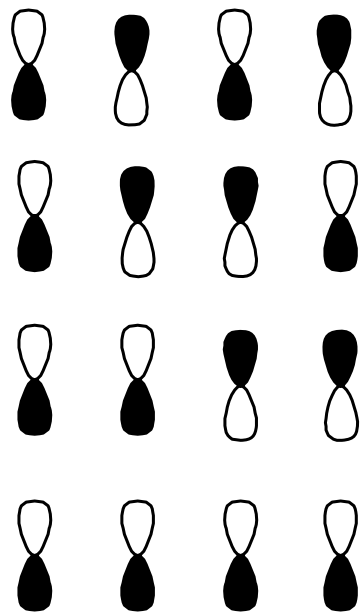
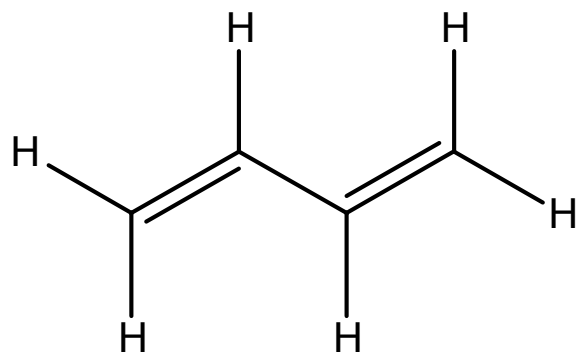

LUMO

HOMO

Molekulové ionty

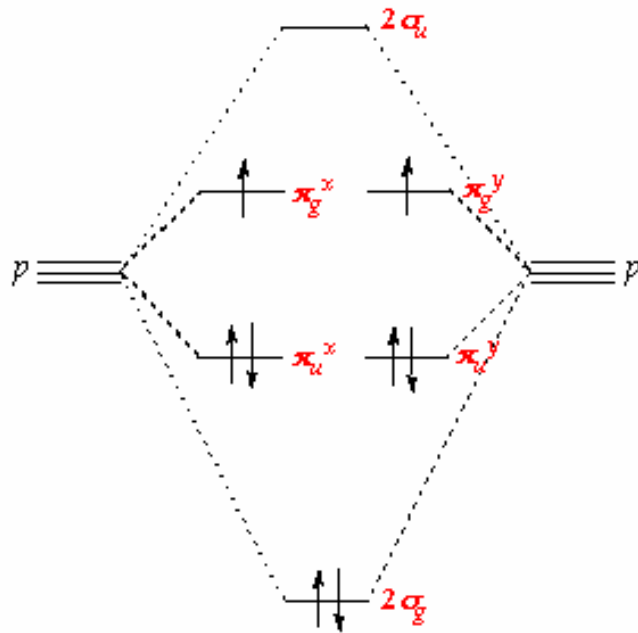

IE



Odtržení nejslaběji vázaného e
v HOMO

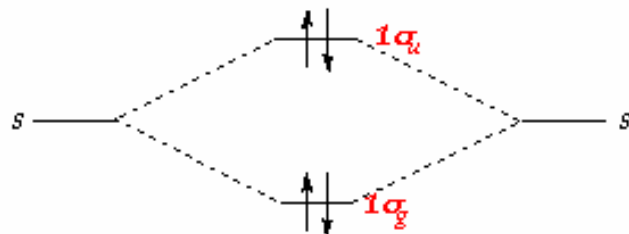

1 × Oxygen
Atomic Orbital

Oxygen
Molecular Orbital

1 × Oxygen
Atomic Orbital

Molekulové ionty

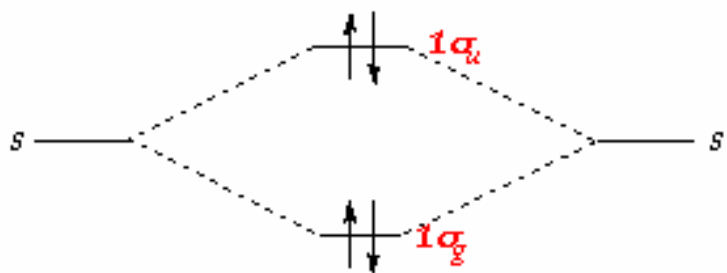
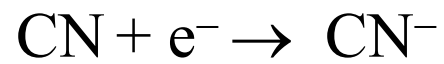
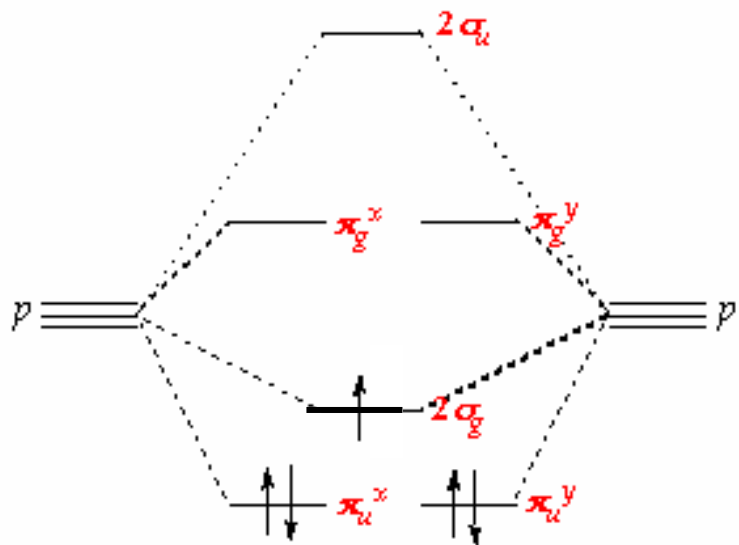

Excitace molekul

$$E_{\text{celk}} = E(\text{elektronová}) + E(\text{vibrační}) + E(\text{rotační}) + E_{\text{ost}}$$

Jednotlivé složky E_{celk} jsou nezávislé – velmi rozdílné velikosti (Bornova-Oppenheimerova aproximace)

$E(\text{elektron})$	100 kJ mol^{-1}	UV a viditelná
$E(\text{vibrační})$	$1.5 - 50 \text{ kJ mol}^{-1}$	Infračervená
$E(\text{rotační})$	$0.1 - 1.5 \text{ kJ mol}^{-1}$	Mikrovlnná a daleká IČ

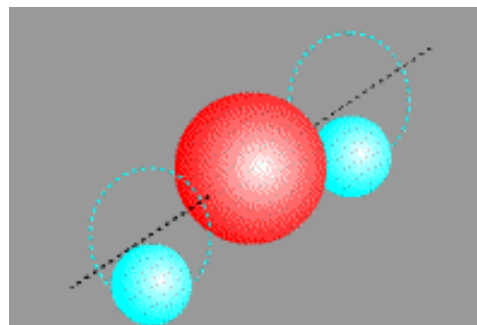
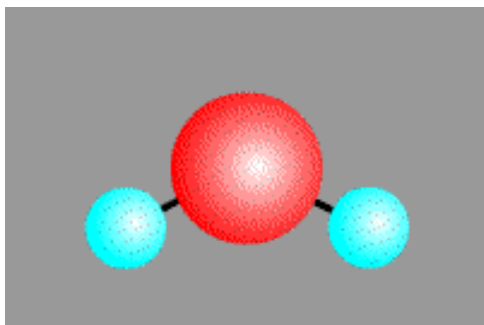

Rotační energie

Kvantování rotační energie

$$E(\text{rotační}) = (\hbar^2/2I) J(J + 1)$$

J = rotační kvantové číslo

I = moment setrvačnosti (μr^2)

Výběrové pravidlo $\Delta J = \pm 1$

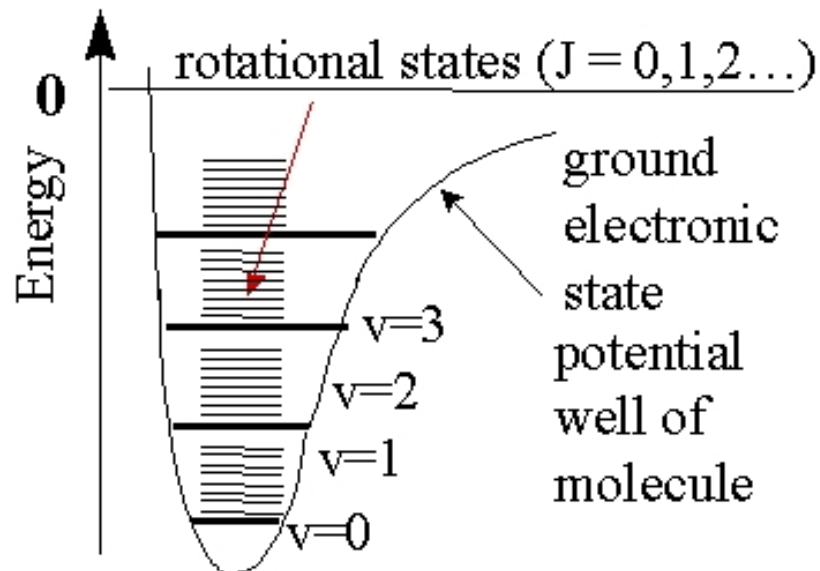

Za normální teploty jsou molekuly v mnoha excitovaných rotačních stavech, rotační energie srovnatelná s tepelnou energií pohybu molekul

Mikrovlnná spektroskopie

Rotační spektra jen pro látky v plynné fázi

Lze získat velmi přesná data o vazebných délkách a úhlech
 $I = \text{moment setrvačnosti} = \mu r^2$

Vazebná délka v H_2 0.74116 Å

Vibrační energie

Kvantování vibrační energie

$$E(\text{vibrační}) = k \hbar^2 (v + \frac{1}{2})$$

v = vibrační kvantové číslo

Výběrové pravidlo $\Delta v = \pm 1$

Energie nulového bodu:

Pro $v = 0$ $E(\text{vibrační}) = \frac{1}{2} k \hbar^2$

H_2 $E(\text{disoc}) = 432 \text{ kJ mol}^{-1}$

$$E(v = 0) = 25 \text{ kJ mol}^{-1}$$

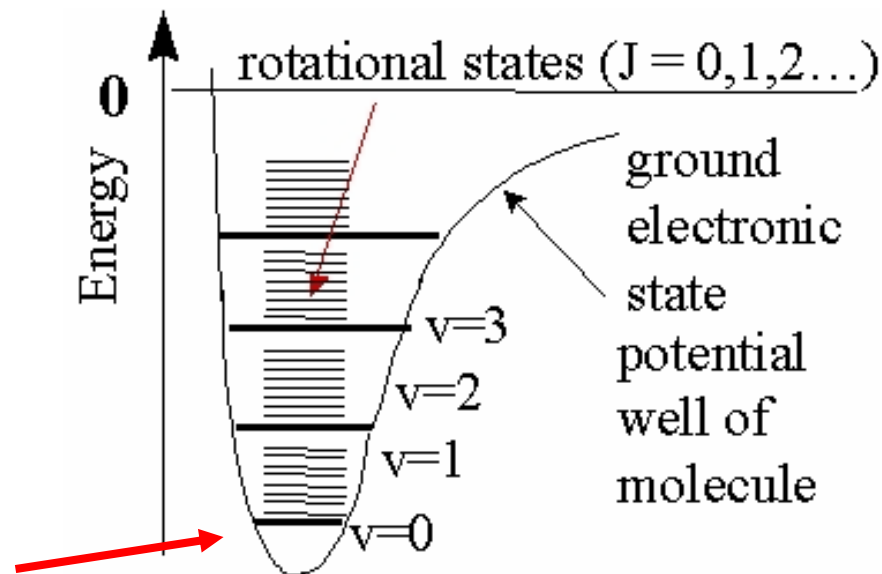

Za normální teploty jsou molekuly v základním vibračním stavu $v = 0$

Vibrační energie

Molekula	Vibrační energie, cm^{-1}
H_2	4159.2
D_2	2990.3
H_2^+	2173

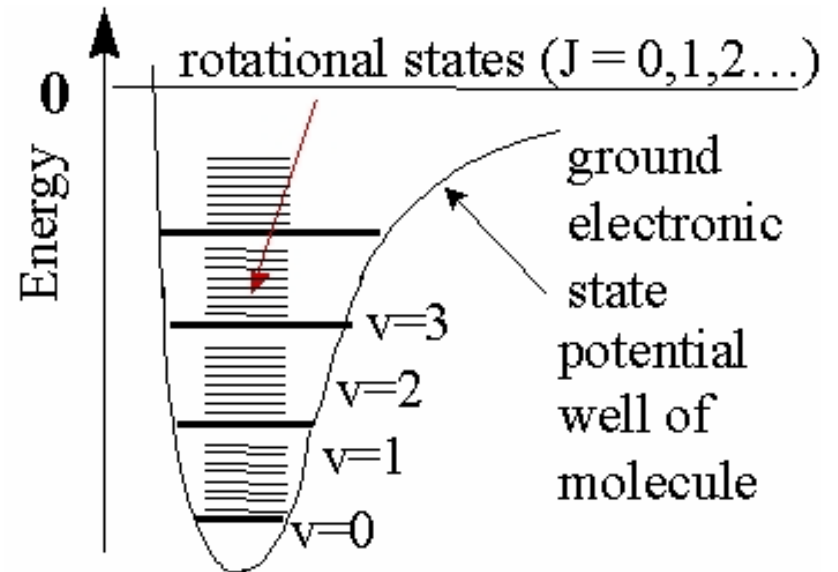

$$\ddot{v} = 1/2\pi (\mathbf{k} / \mathbf{m})^{1/2}$$

Rotačně – vibrační spektrum $\text{HCl}_{(g)}$

IČ oblast

$$\nu_0 = 2886 \text{ cm}^{-1}$$

$$\Delta v = \pm 1$$

$$\Delta J = \pm 1$$

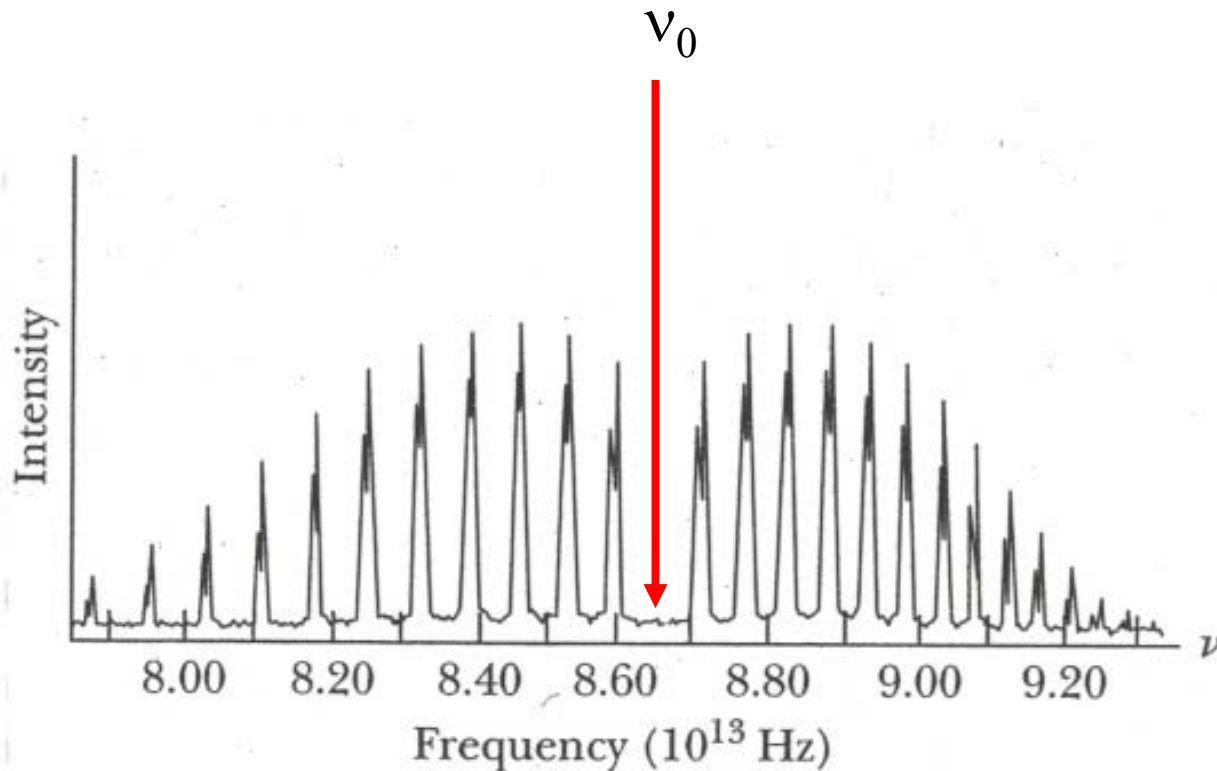

Typy vibrací

Stretching vibrations

Valenční

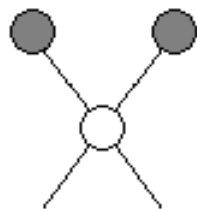

Symmetric

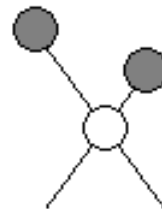

Asymmetric

Deformační

Bending vibrations

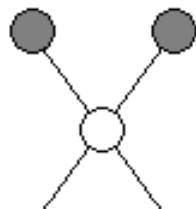

In-plane rocking

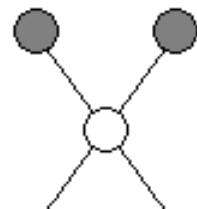

In-plane scissoring

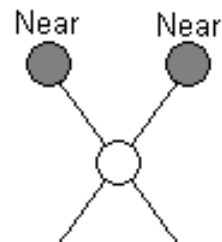

Out-of-plane wagging

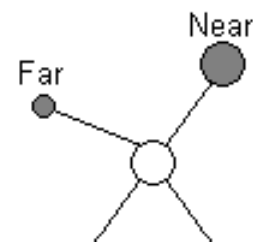

Out-of-plane twisting

Vibrační spektroskopie

Oblast	λ (μm)	vlnočet (cm^{-1})
Blízká IČ	0.78 - 2.5	12800 - 4000
Střední IČ	2.5 - 50	4000 - 200
Daleká IČ	50 - 1000	200 - 10

Nejužitečnější oblast $4000 - 400 \text{ cm}^{-1}$ obsahuje vibrace většiny molekul

Infračervená a Ramanova spektroskopie

Infračervená spektroskopie

Vibrace musí měnit dipolový moment molekuly (HCl, H₂O)

Průchod IČ záření přes vzorek, měříme absorbované množství

Ramanova spektroskopie

Vibrace musí měnit polarizaci molekuly (H₂)

Průchod viditelného záření (laser) přes vzorek, měříme rozptýlené množství

Infrared and Raman Spectra of Polyamide (Nylon 66)

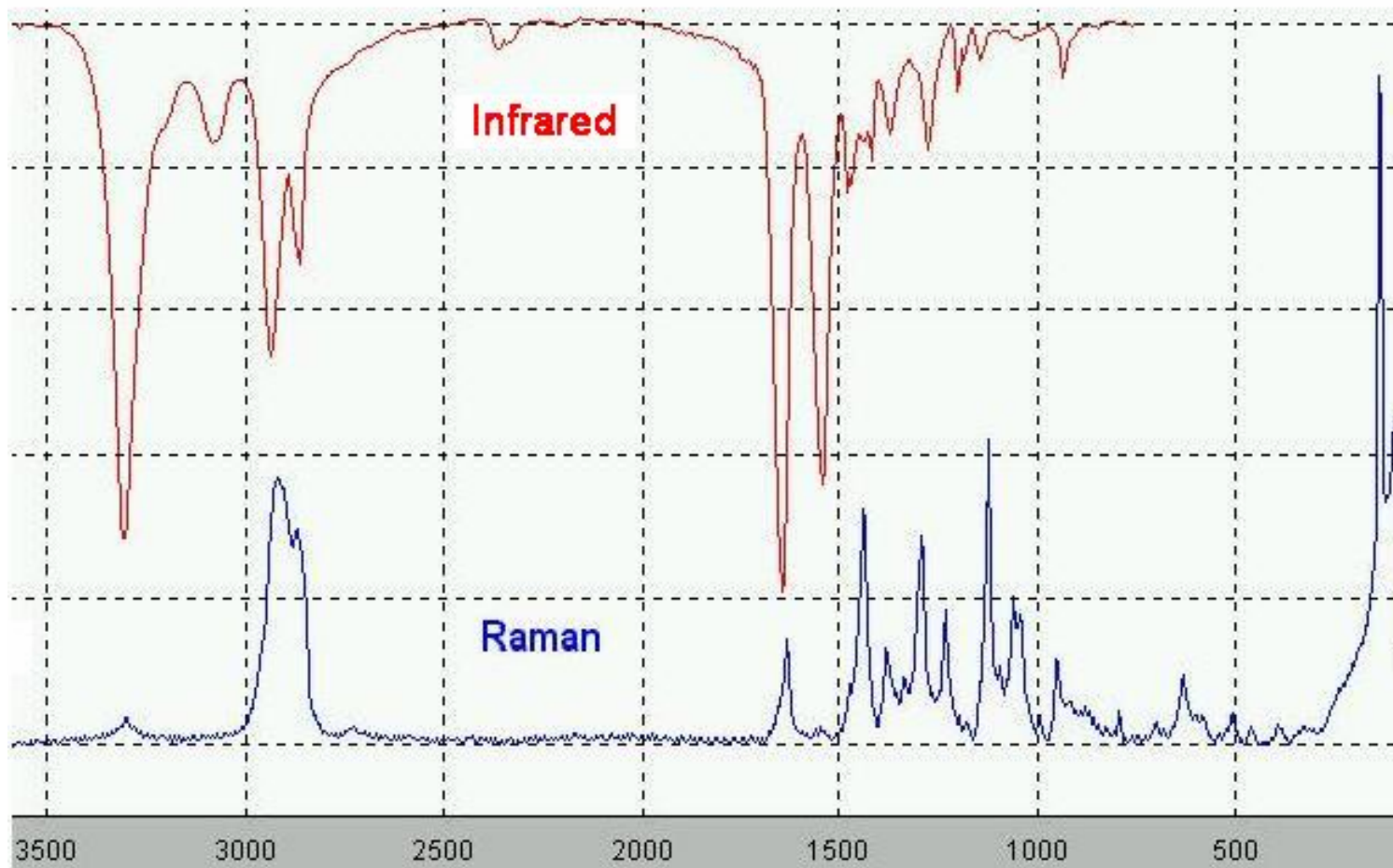

$$\tilde{\nu} = 1/2\pi (k/m)^{1/2}$$

Elektronová energie

Výběrové pravidlo $\Delta S = 0$

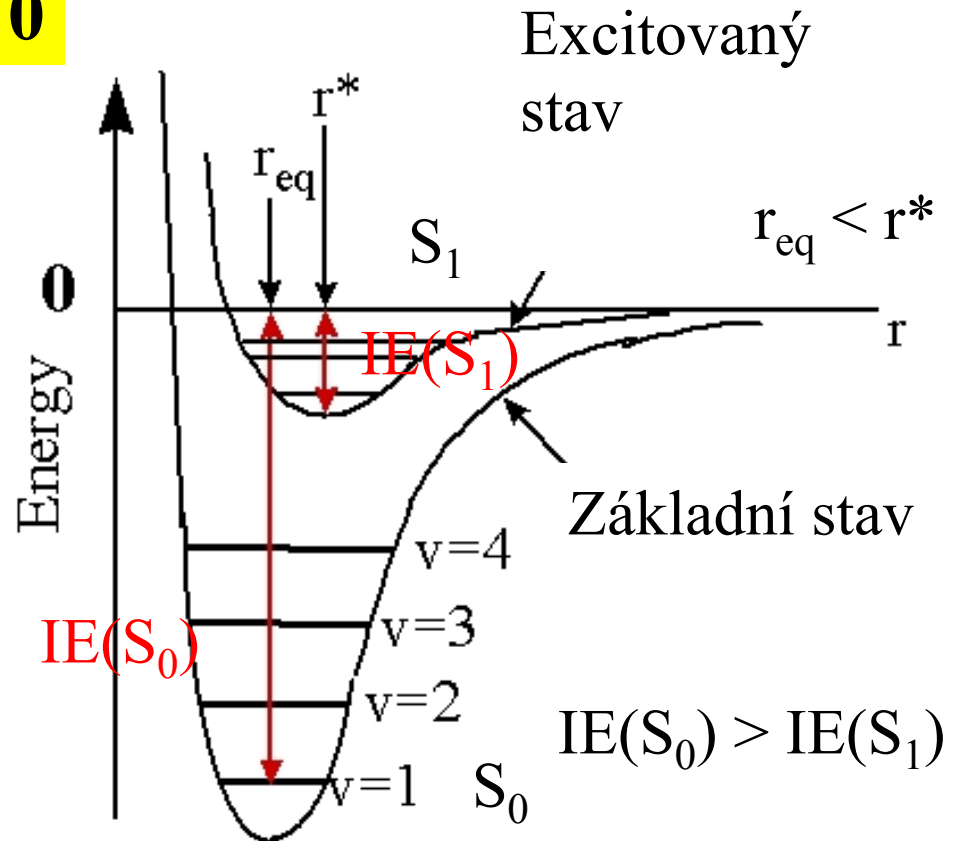
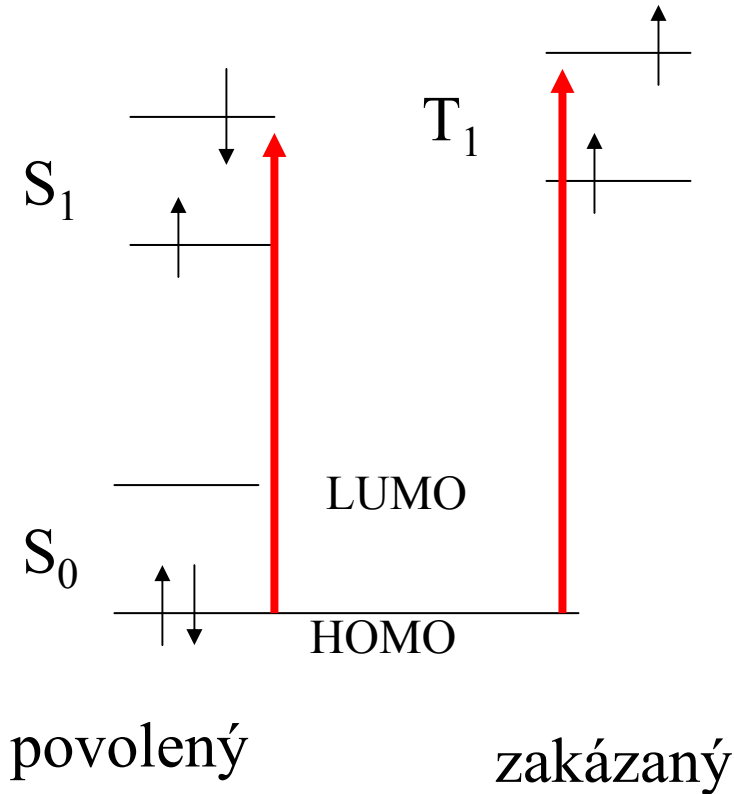

Molekula H₂

$$r_{\text{eq}} = 0.74 \text{ \AA}$$

$$r^* = \text{ \AA}$$

$$E(S_0) = 432 \text{ kJ mol}^{-1}$$

$$E(S_1) = 255 \text{ kJ mol}^{-1}$$

$$\text{IE} = 1490 \text{ kJ mol}^{-1}$$

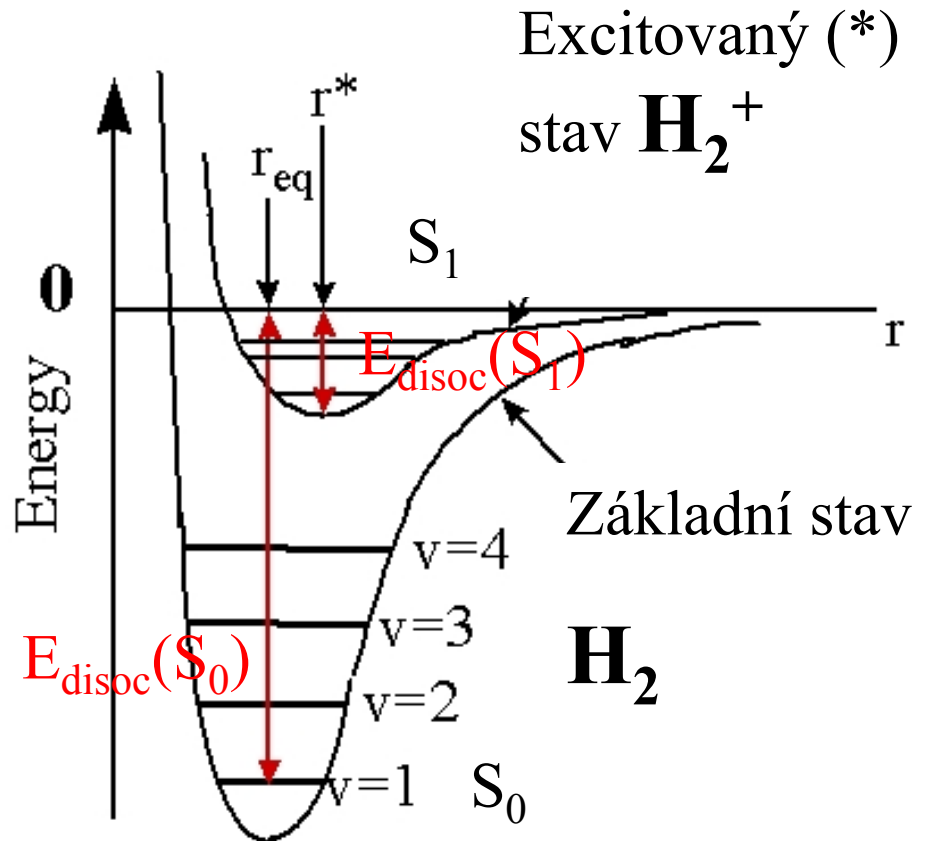

$$r_{\text{eq}} < r^* \quad E(S_0) > E(S_1)$$

Elektronové přechody

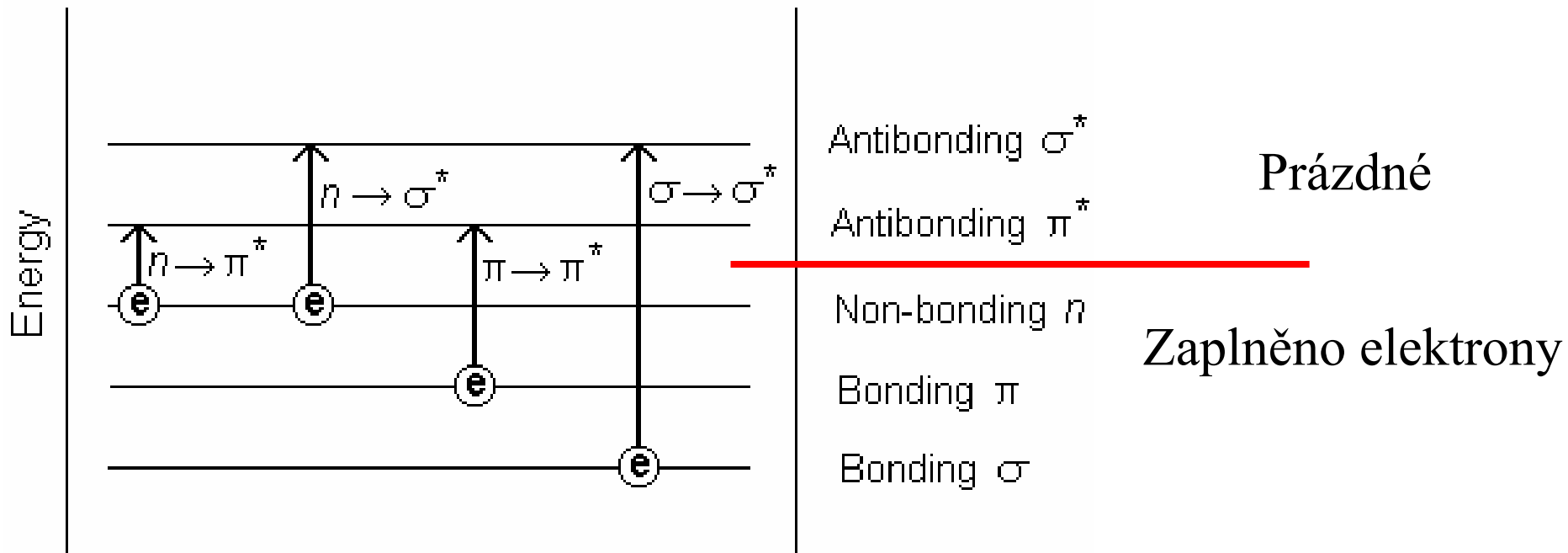

Elektronové přechody

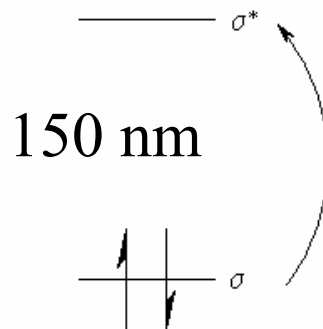
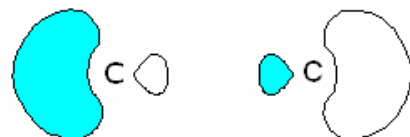

$\sigma\sigma^*$

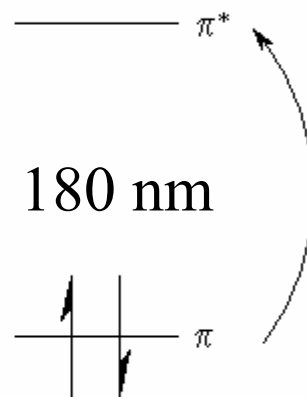

$\pi\pi^*$

Elektronové přechody

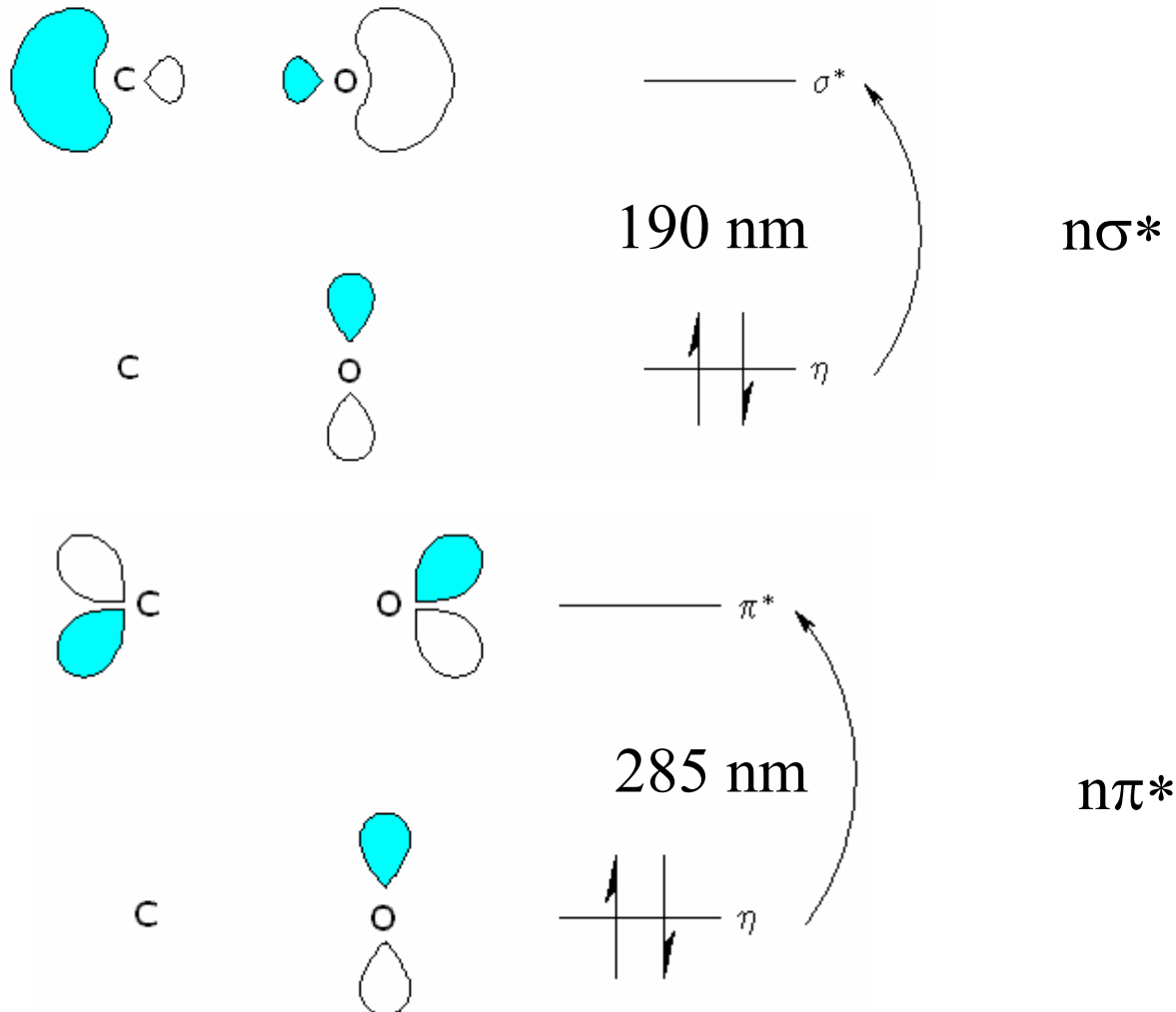

Excitace - deexcitace

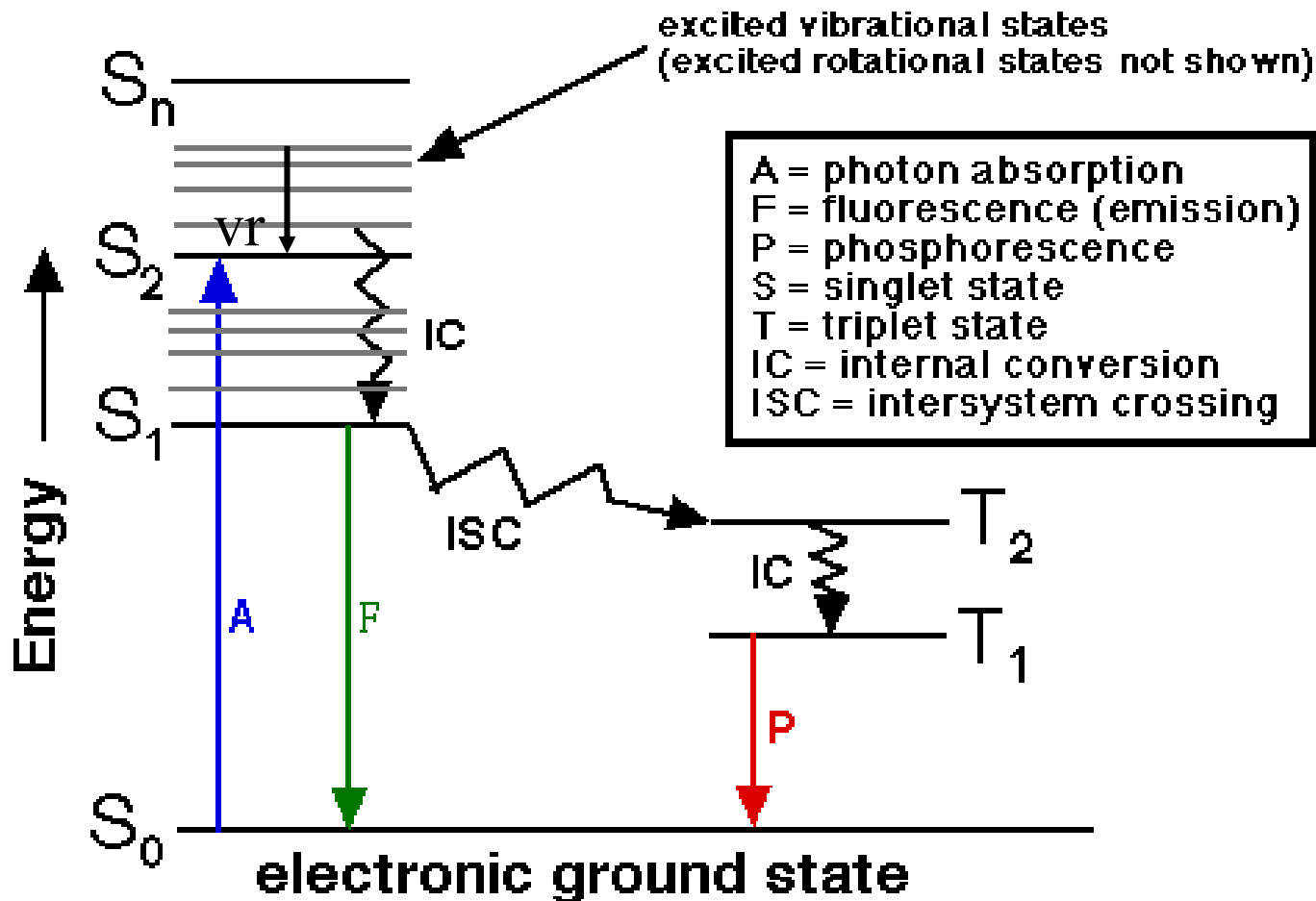

Excitace - deexcitace

A = absorpce fotonu

vr = vibrační relaxace, uvolnění tepla

IC = vnitřní přeměna, nezářivá, mezi stavy se stejnou multiplicitou, spinově povolená

ISC = mezisystémový přechod, nezářivá, mezi stavy se různou multiplicitou, spinově zakázaný

F = fluorescence, spinově povolená emise $S_1 \rightarrow S_0$, rychlá, vyzáření fotonu

P = fosforescence, spinově zakázaná emise $T_1 \rightarrow S_0$, pomalá, vyzáření fotonu

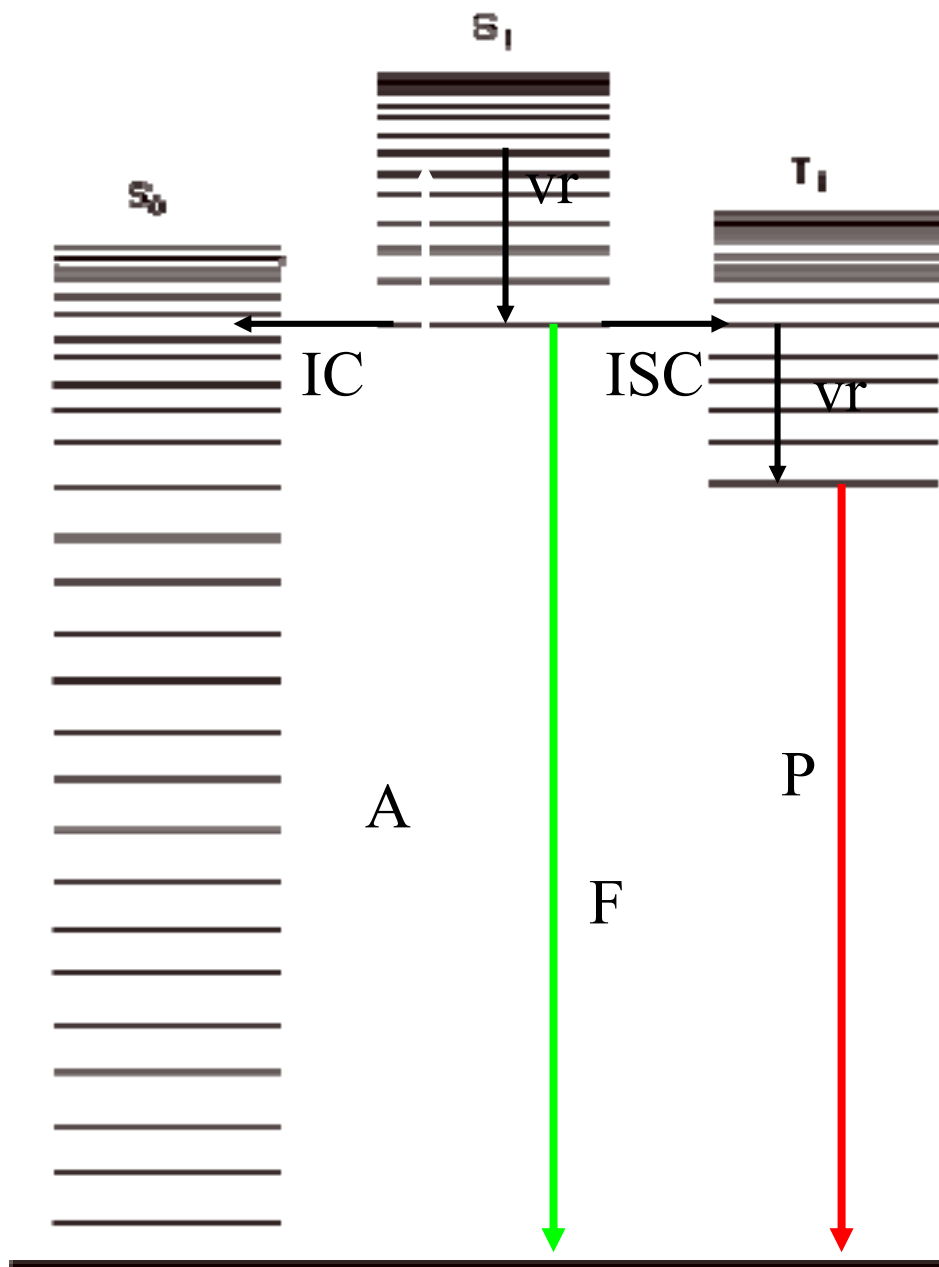

Lambert-Beerův zákon

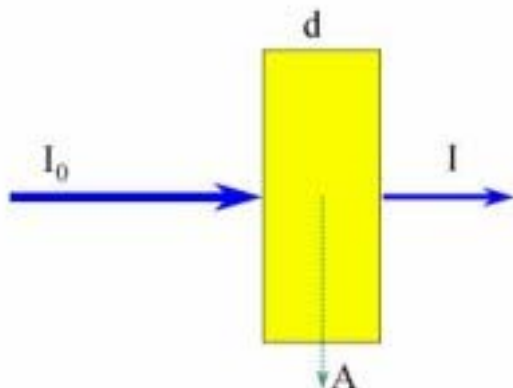

$\epsilon(\lambda)$ = molární extinkční koeficient
 c = molární koncentrace (M)
 d = délka kyvety

Platí pro určitou λ

$$I = I_0 \exp[-\epsilon(\lambda) c d]$$

$$\% \text{ Transmittance} = (I / I_0) 100$$

$$\text{Absorbance} = -\log(I / I_0) = \epsilon(\lambda) c d$$

Johann H. Lambert (1728-1777)

August Beer (1825-1863)

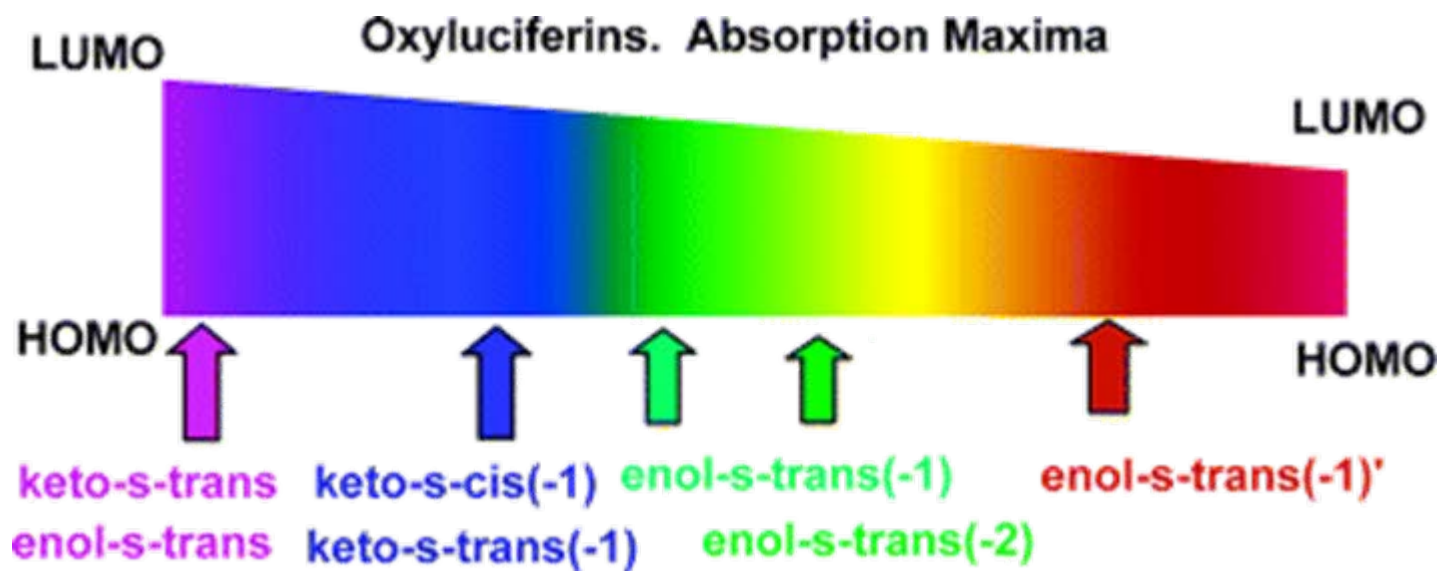

Mechanismy přetržení chemické vazby

Termální excitace

dodaná tepelná energie je napumpována do vibračních modů (valenčních vibrací), vazba se prodlužuje, zeslabuje, až se přeruší
relativně pomalé, 10^{-12} s

Elektronická excitace

energie dopadajícího záření (fotony, elektrony) je použita na excitaci vazebného elektronu do protivazebného orbitalu
okamžité, 10^{-15} s

Mechanismy přetržení chemické vazby

Smíšená vibračně elektronická excitace

energie (tepelná) několika vibrací (fononů) je spojena a napumpována do elektronického přechodu valenčního elektronu do protivazebného orbitalu