

Elektronová absorpční spektra

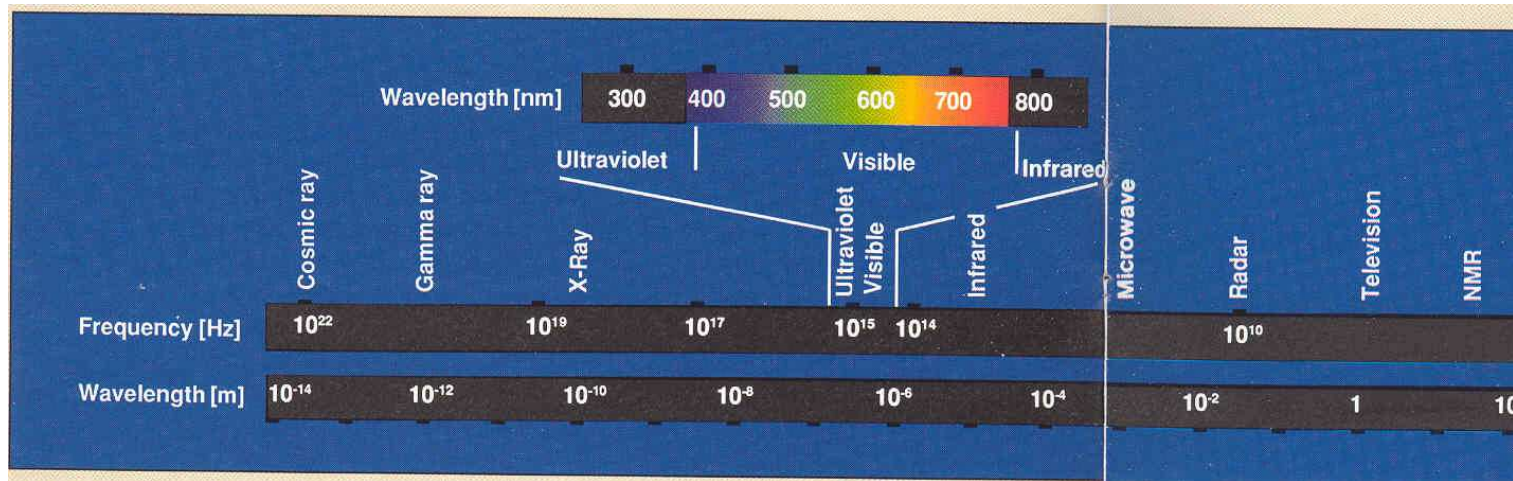

EM radiation

Type	wavelength	Interaction
γ	< 10 nm	nuclear emission
X-ray	< 10 nm	atomic ionization
UV	10-380 nm	electronic transitions
Vis	380-800 nm	electronic transitions
IR	800nm-100 μ m	bond interaction
Radio	meters	nuclear absorption

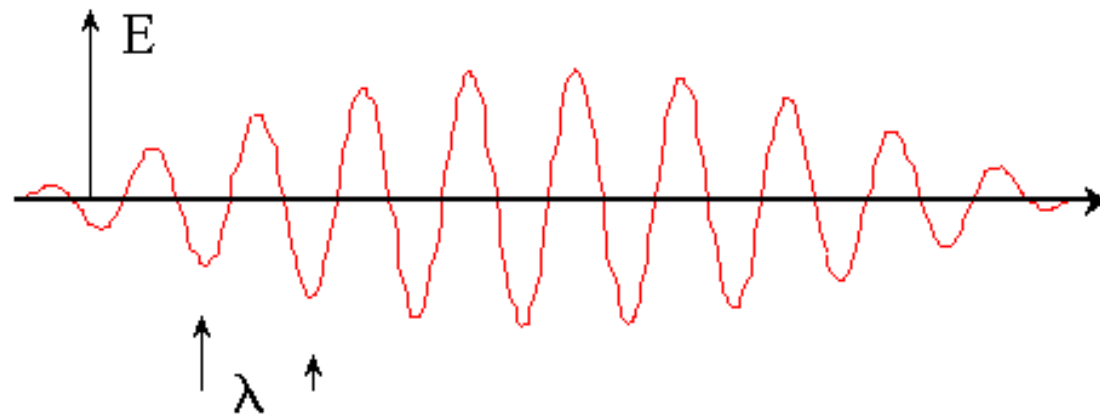
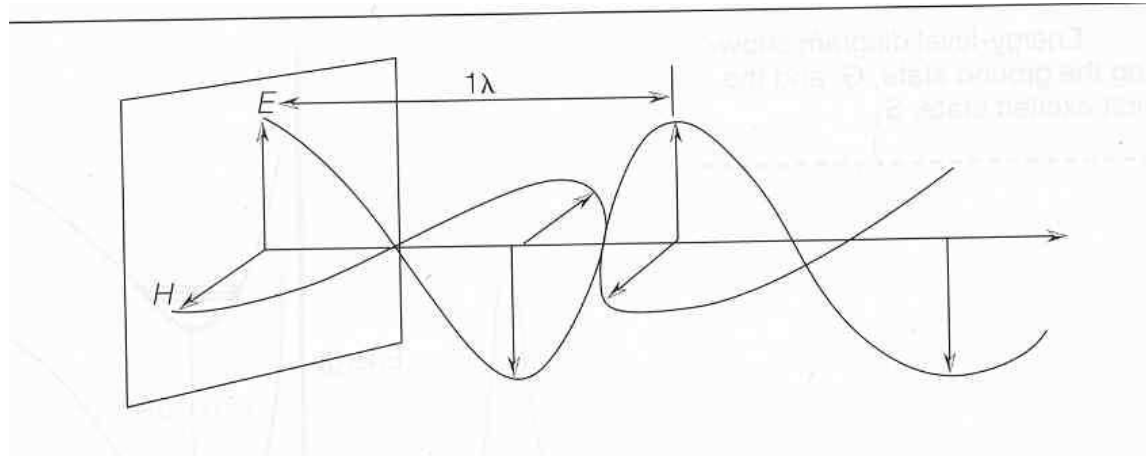

Elektronová absorpční spektra

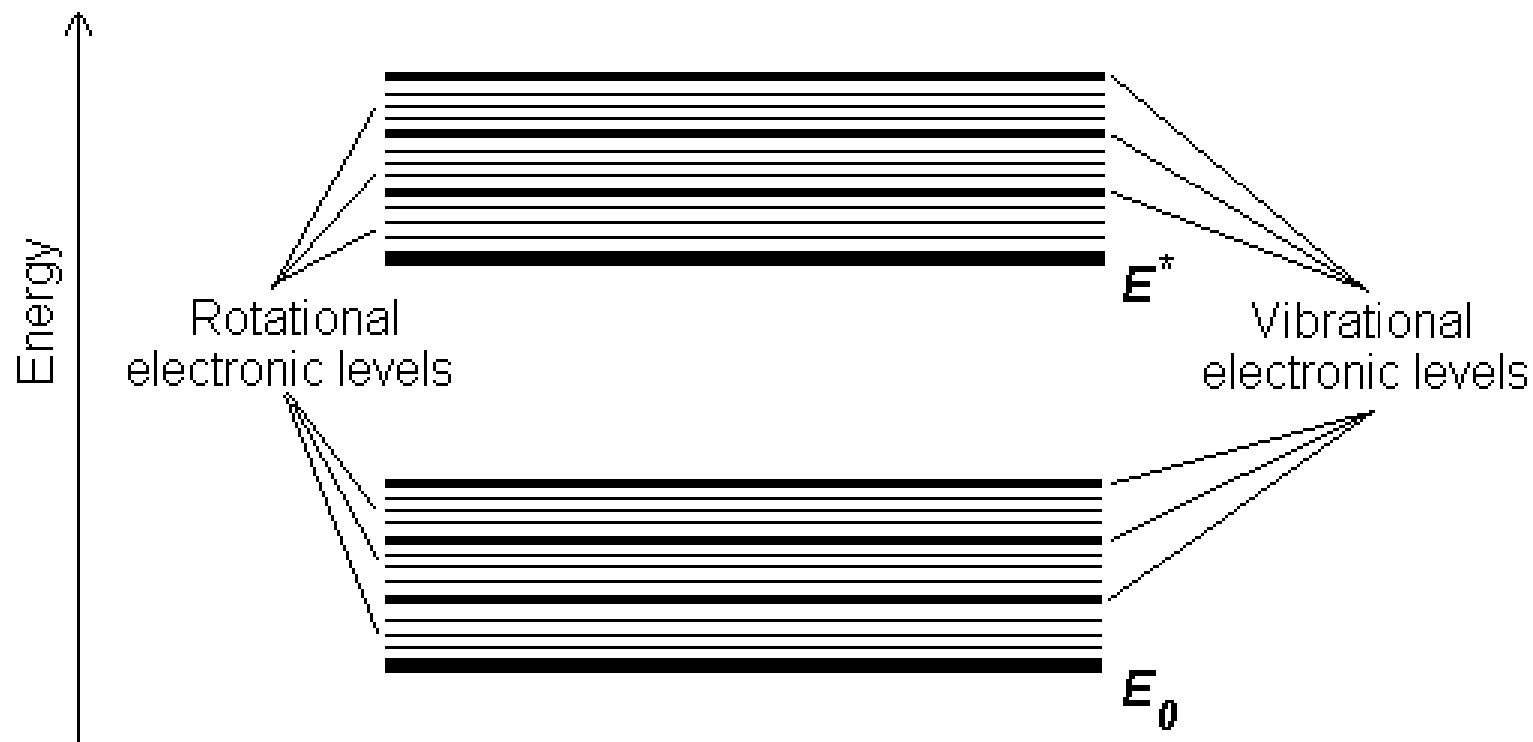

$$\Delta E = \Delta E_{\text{el}} + \Delta E_{\text{vib}} + \Delta E_{\text{rot}}$$

$$\Delta E = hc/\lambda$$

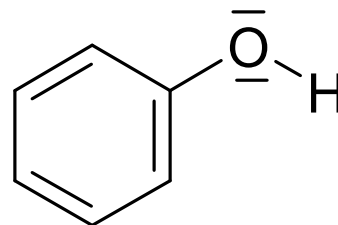

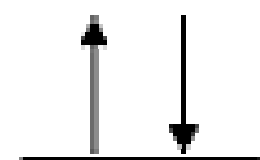

ground
singlet state

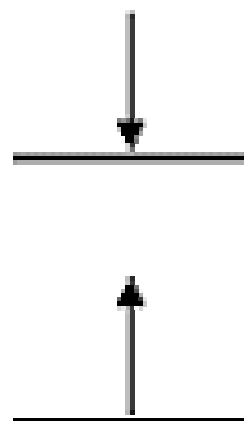

excited
singlet state

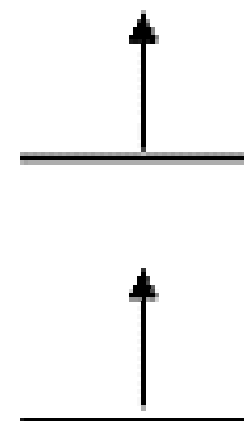

excited
triplet state

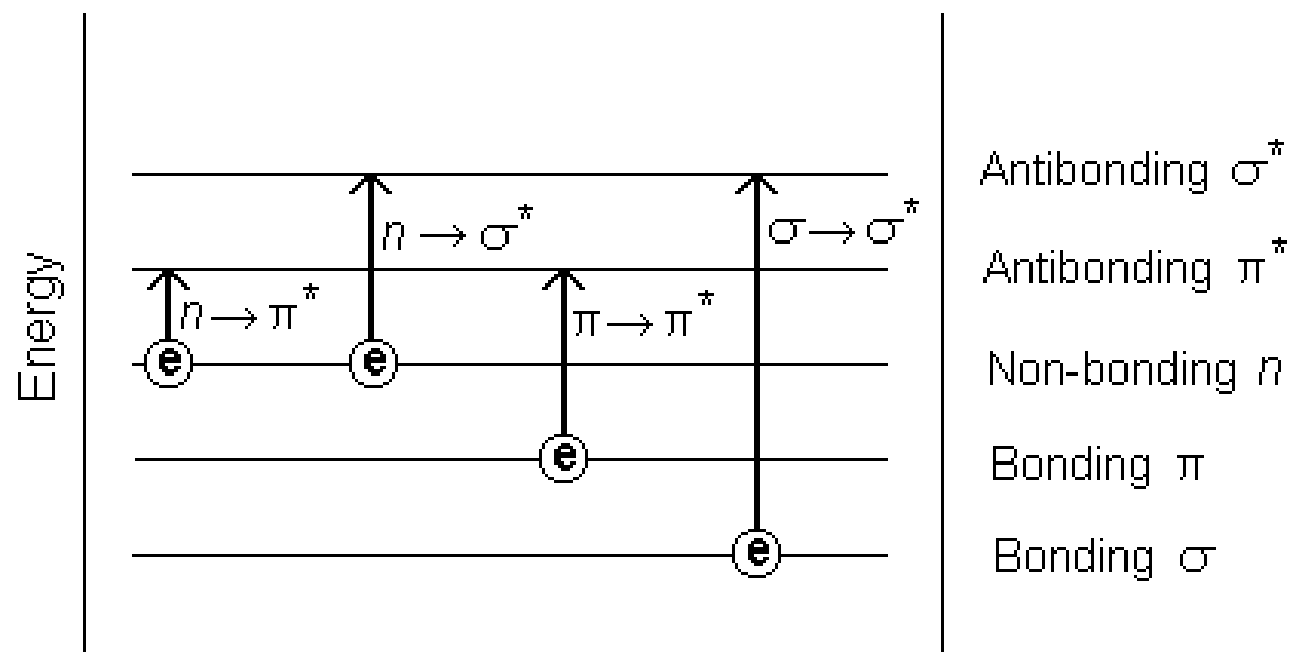
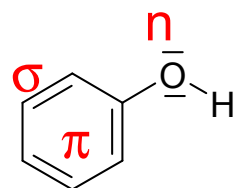

Energie přechodů

$\sigma \rightarrow \sigma^*$ příklad C-H: vysoké energie, 125 nm

$n \rightarrow \sigma^*$ méně časté, energie 150 – 250 nm

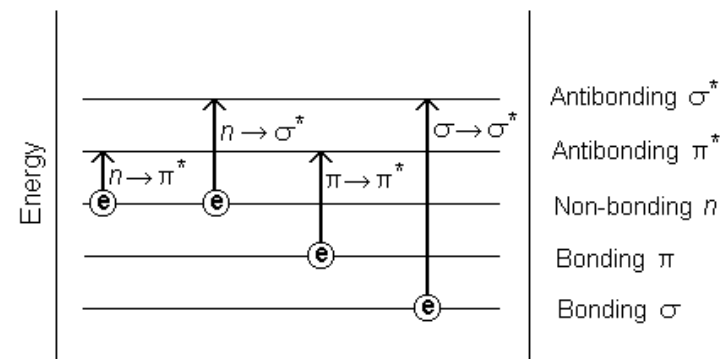

$n \rightarrow \pi^*$ nejobvyklejší případ 200 – 700 nm Mol.abs. koef. = 10 – 100 L.mol⁻¹cm⁻¹

$\pi \rightarrow \pi^*$ Mol. abs. Koef = 1000- 10⁴ L.mol⁻¹cm⁻¹

Charge transfer přechody – anorganické komplexy, interakce mezi elektron.

Donorem a akceptorem – vysoký Mol.abs. koeficient

Vliv polarity na absorpční maximum

$\pi \rightarrow \pi^*$ červený posun

v polárním prostředí

Zvýšená solvatace excitovaného stavu
snižuje jeho energii

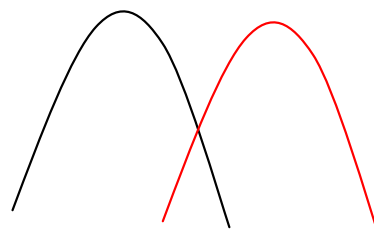

$n \rightarrow \pi^*$ modrý posun

v polárním prostředí

Zvýšená solvatace n páru snižuje
energii n orbitalu

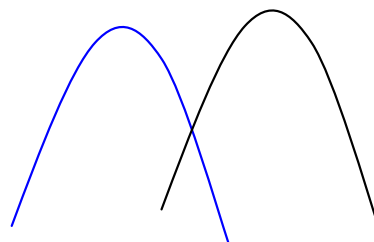

Biochemicky významné chromofory

Významné chromofory v biochemii

	Amax (nm)	mol.abs koef. (l/mol.cm)
-CONH-	225	400
-S ⁻	235	3280
-S-S-	250	500
-fenyl	206 261	8000 220
-hydroxyfenyl	222 270	8000 1450
-hydroxyfenolát	235 287	9300 2600
Indol	220 280	3400 5500
Imidazol	211	6000
Guanin	256	12200
Adenin	260	14900
Cytosin	267	6100
Thymin	265	7900
NADH	340	6220
Hem	410	12000
Retinyl	453	50000
FAD	450	14000
Cytochromy	500-600	
Chlorofyly	630-650	

Lamber-Beerův zákon

$$A = \varepsilon \cdot c \cdot b$$

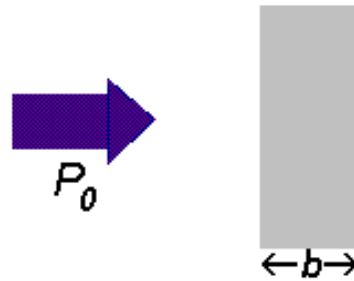

Využití pro kvantitativní analýzu:

- 1) Při znalosti ε : $c = A/\varepsilon \cdot d$
- 2) Kalibrační přímka

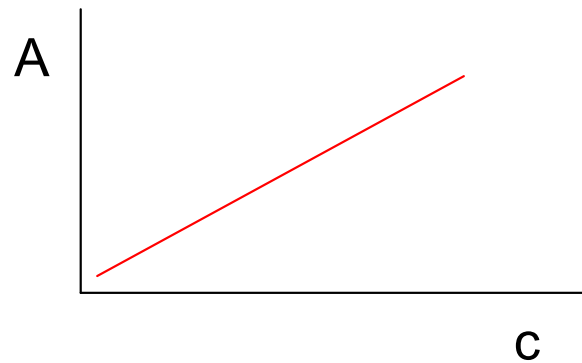

Instrumentace

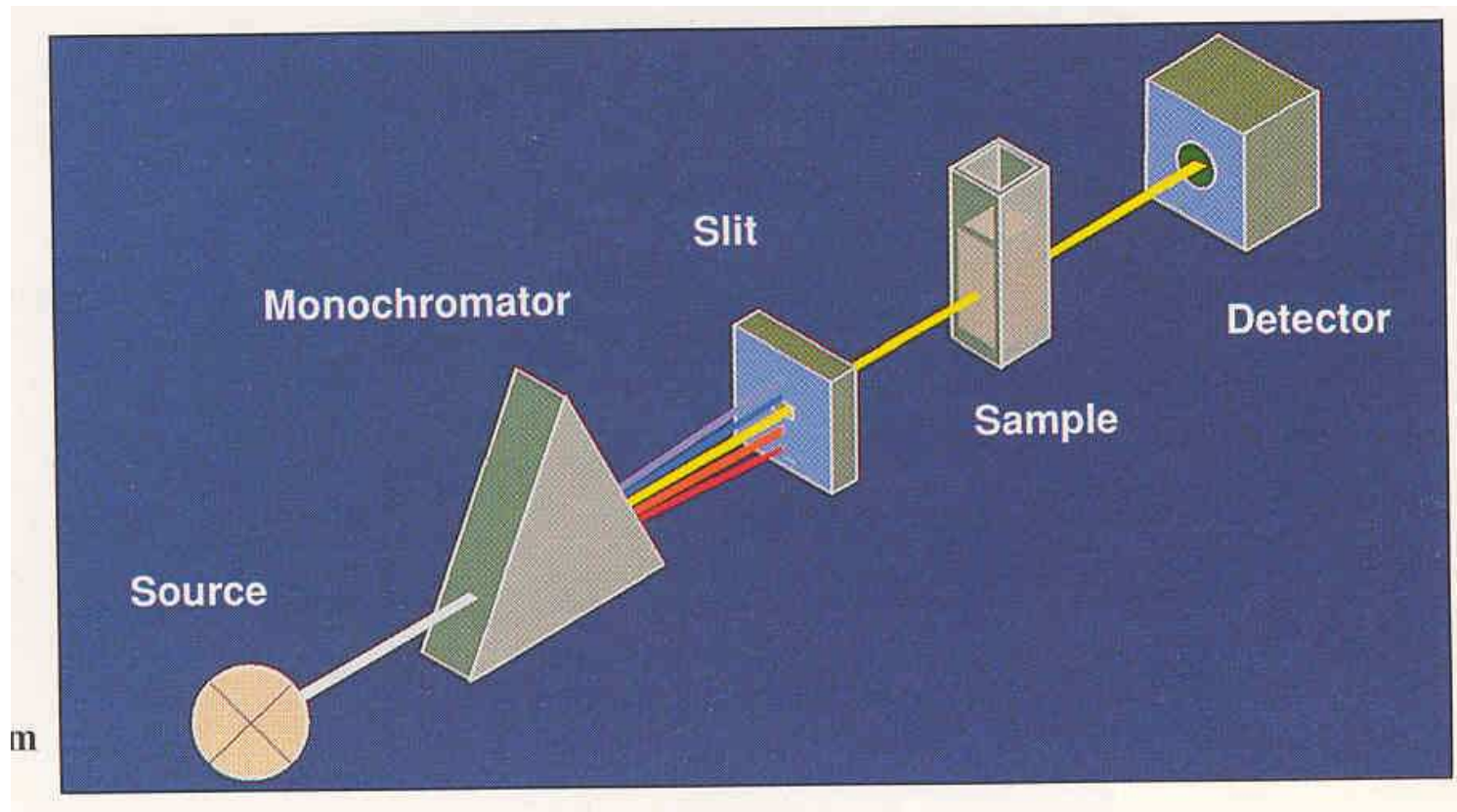

Zdroje

Rtuťová výbojka – UV spektrum

Halogenová žárovka – viditelné spektrum

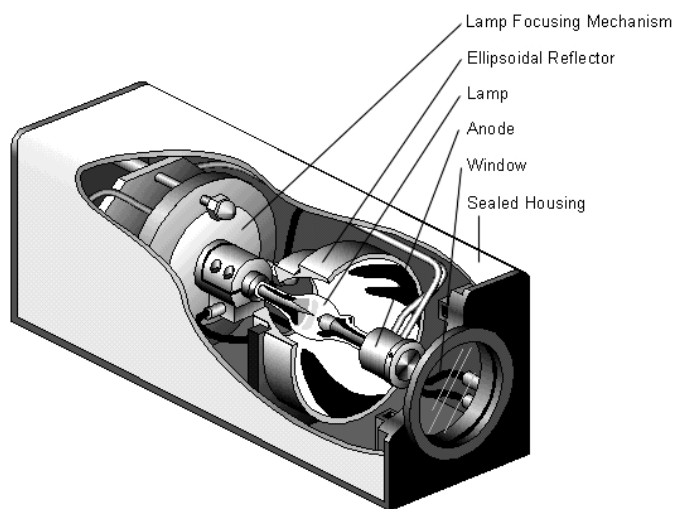

Xenonová výbojka – UV + viditelné spektrum



Deuteriová lampa – UV spektrum

Overlapping Spectra of Deuterium and Tungsten Lamps

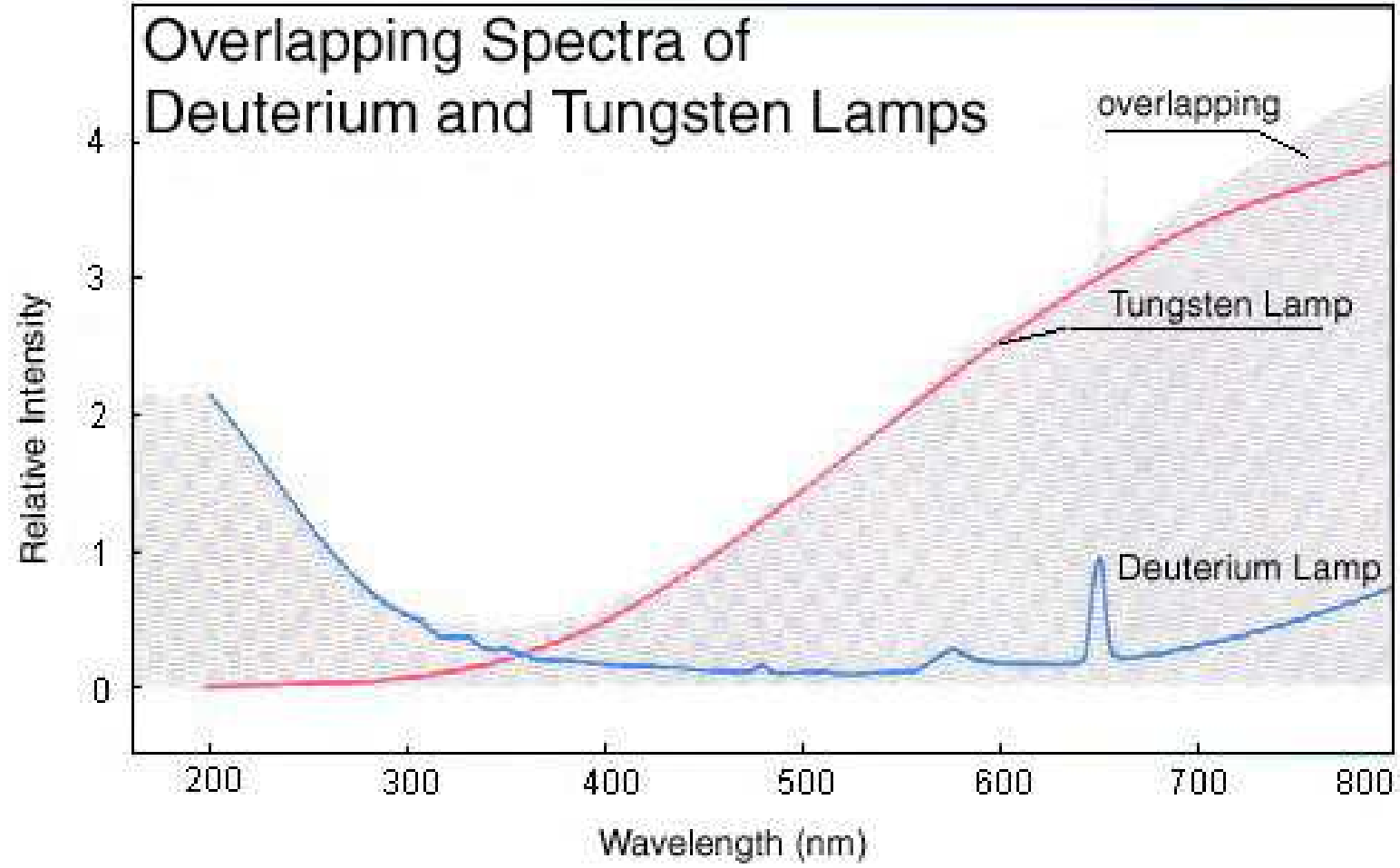

Rtuťová výbojka

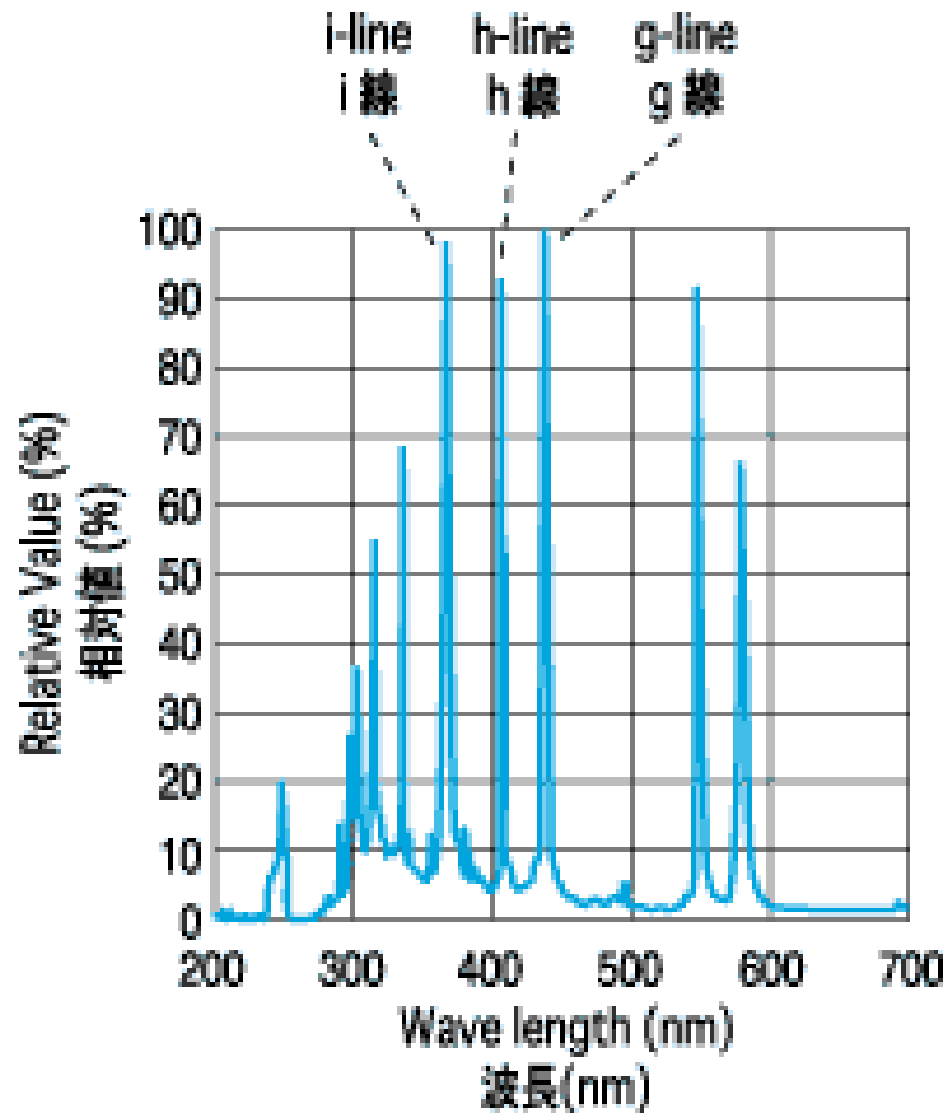

Xenonová výbojka

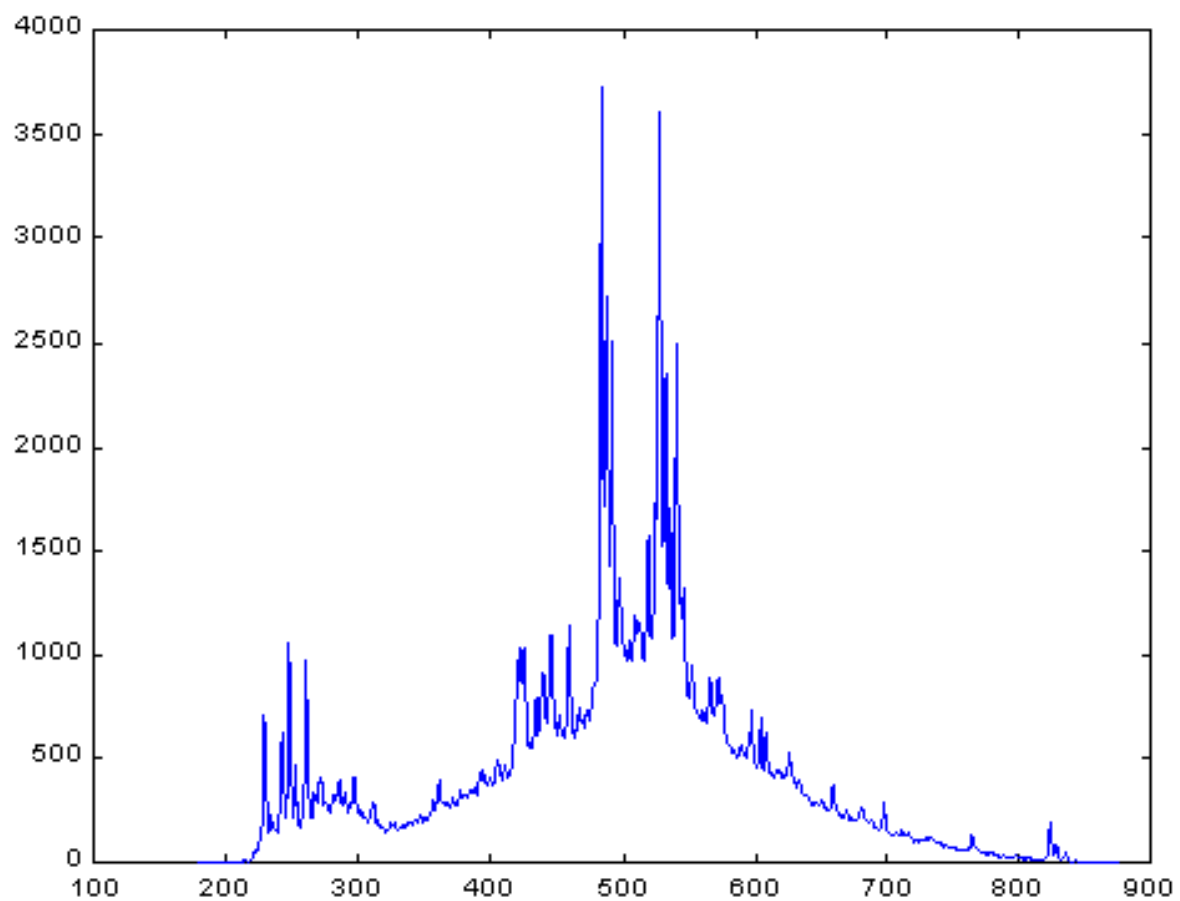

Spektrofotometrické kyvety

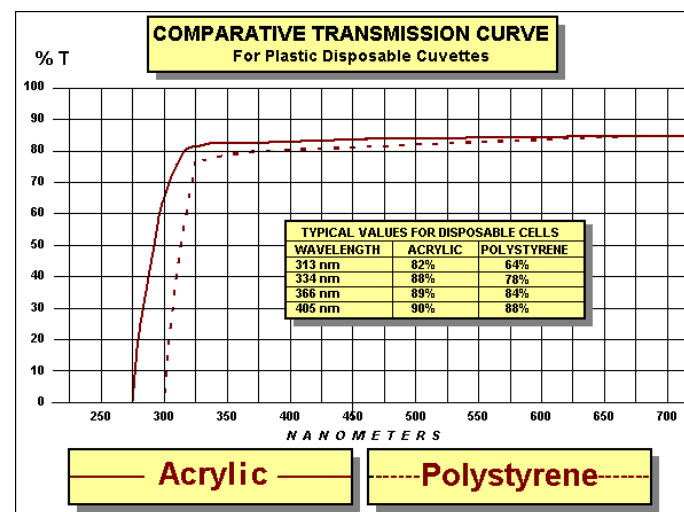
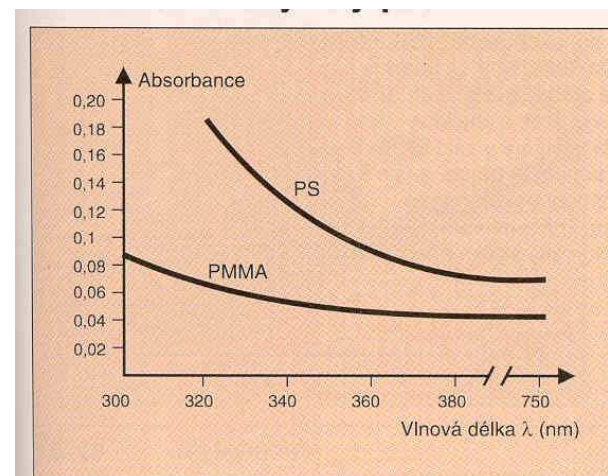
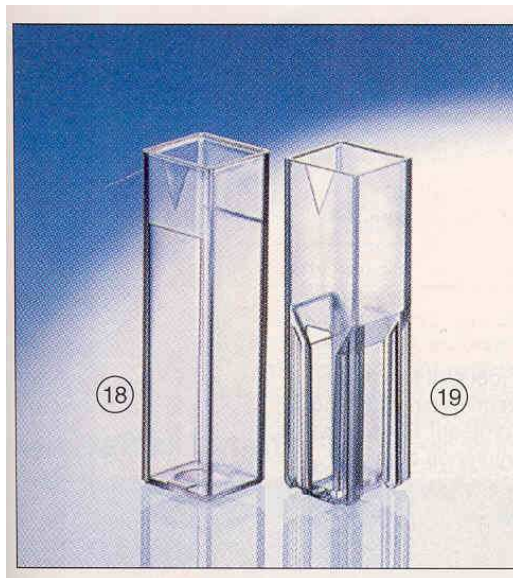
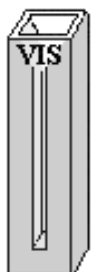
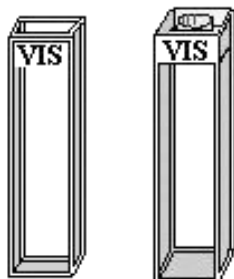

Detektory

Fotonásobič

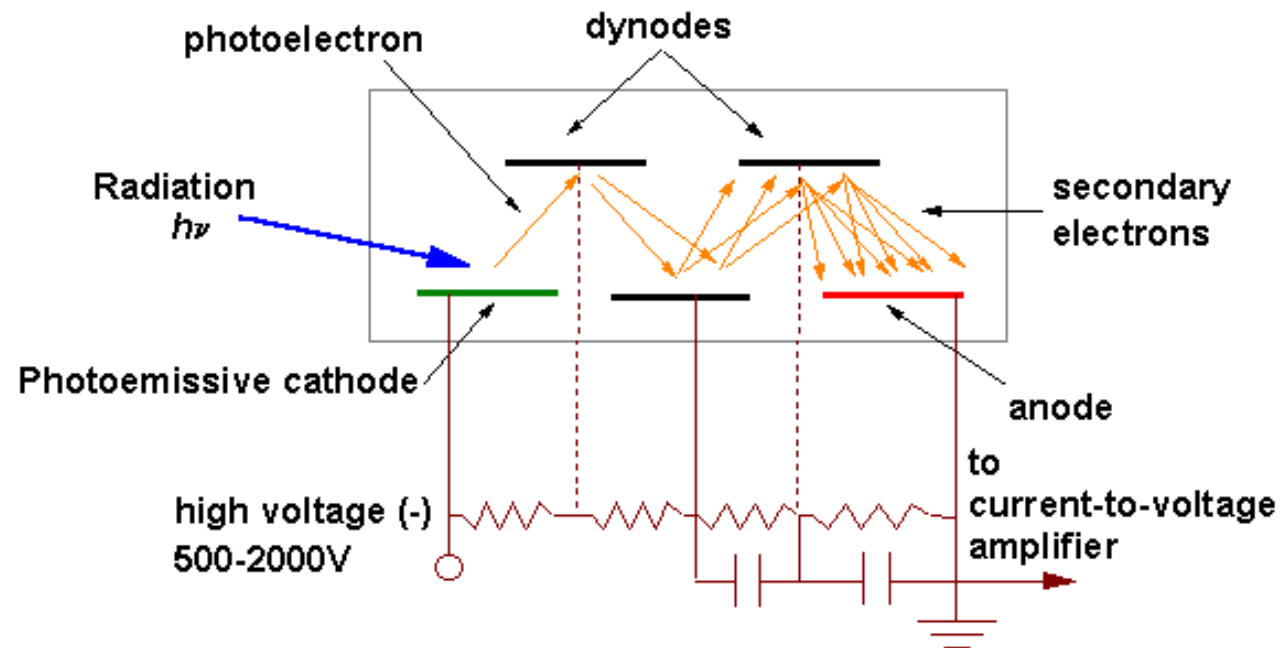

SEMITRANSSPARENT PHOTOCATHODE SPECTRAL RESPONSE CHARACTERISTICS

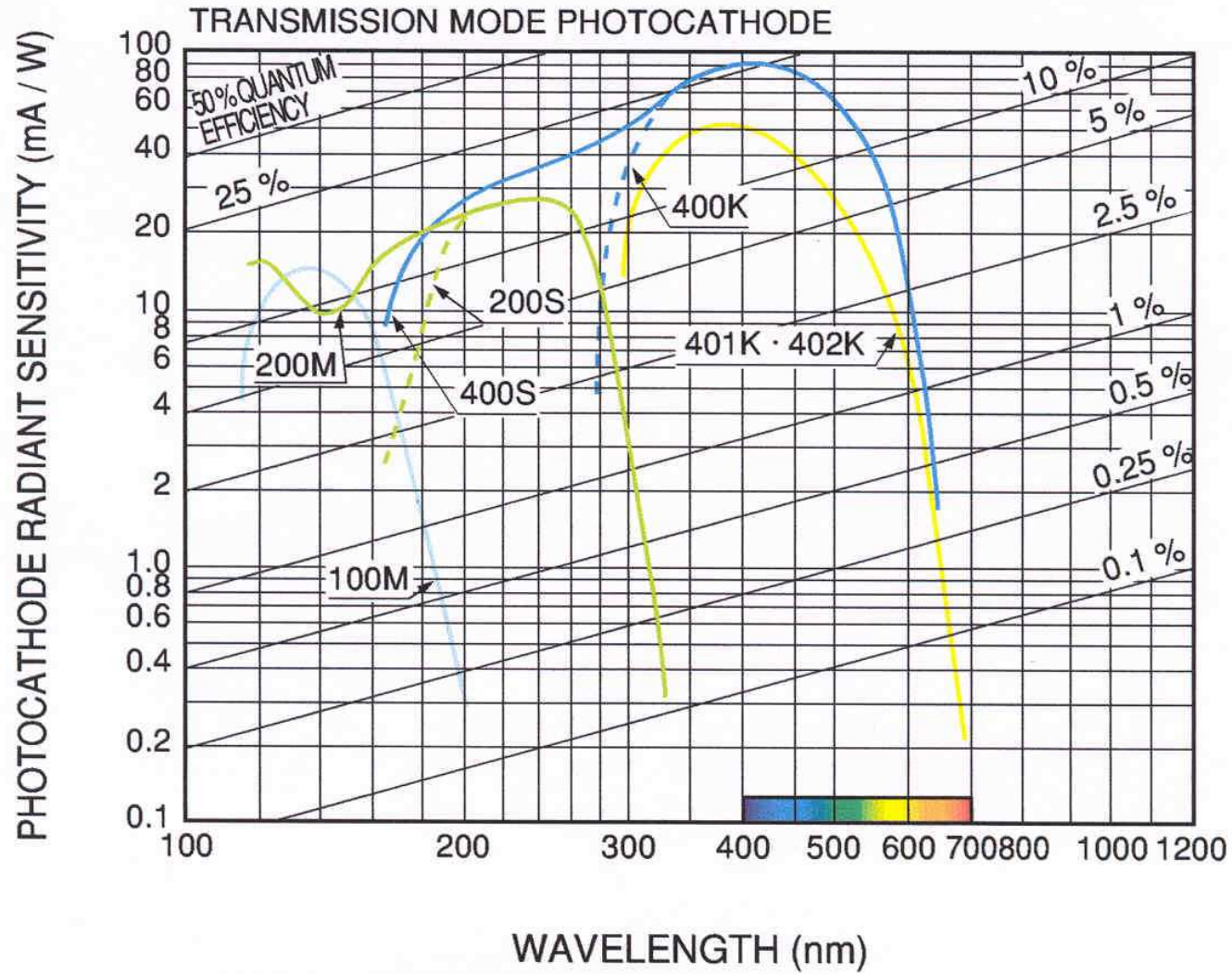

Rozpouštědla

Použitelnost rozpouštědel v UV oblasti

Voda	> 185 nm
EtOH	>195 nm
Diethyléter	>205 nm
Dioxan	>220 nm
CHCl ₃	>245 nm
CCl ₄	>262 nm
Benzen	>280 nm
Aceton	>330 nm

Dvoupaprskový fotometr (double-beam)

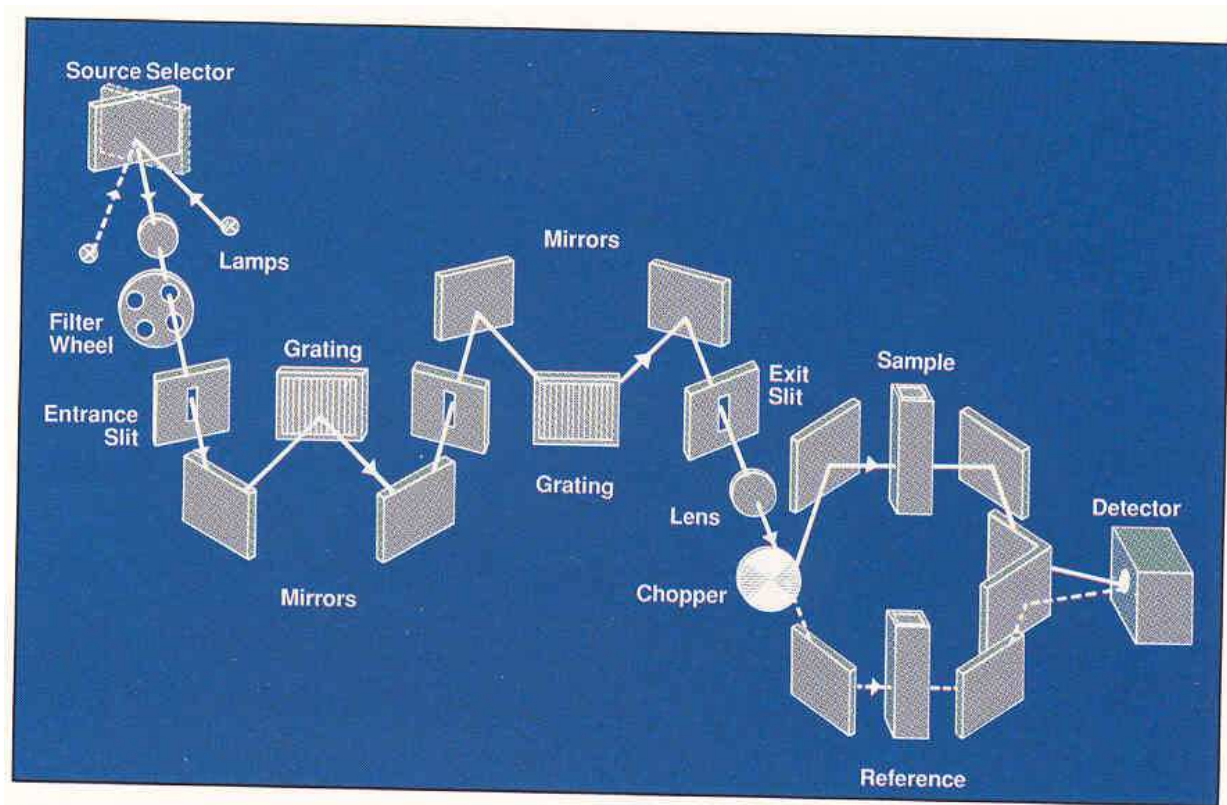

Fotometr s diodovým polem

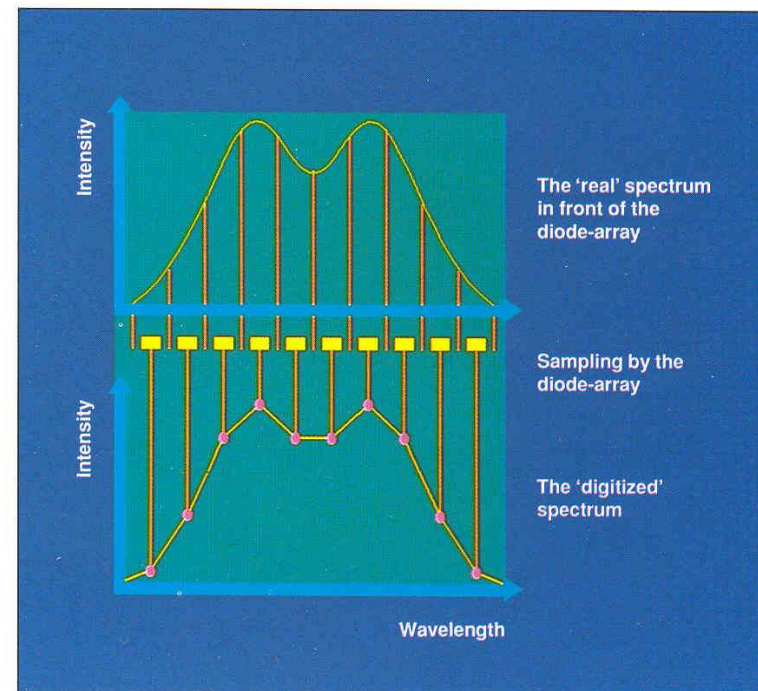
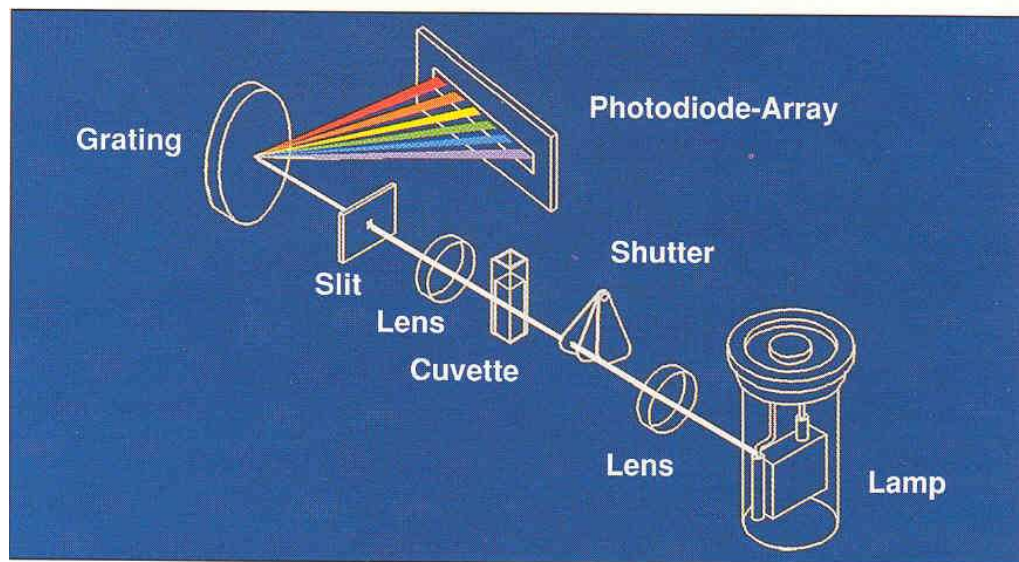

Charakteristiky přístroje

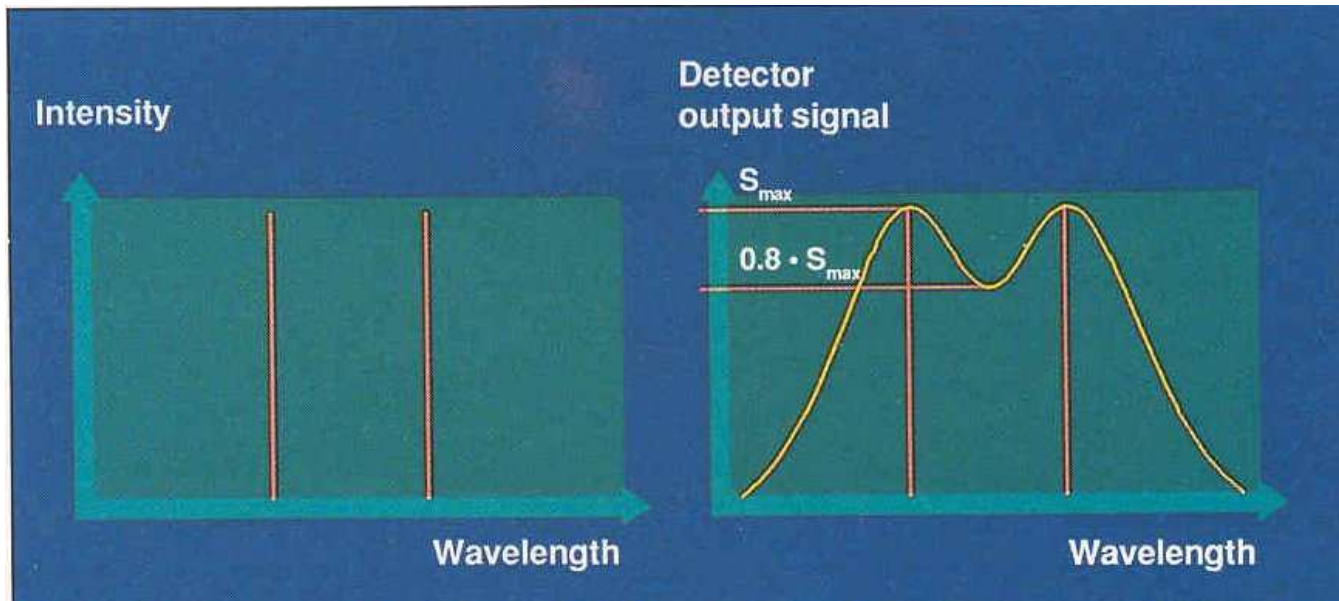

Spektrální rozlišení – schopnost rozlišit dvě těsně přilehlé vlnové délky

Charakteristiky přístroje

Spektrální šířka přístroje – šířka pásu světla opouštějícího monochromátor měřená v polovině výšky píku (SBW), závisí na šířce štěrbin a disperzi mřížky, Obvykle $< 2 \text{ nm}$

Přirozená šířka pásu vzorku - šířka absorpčního pásu vzorku měřená v polovině výšky píku (NBW)

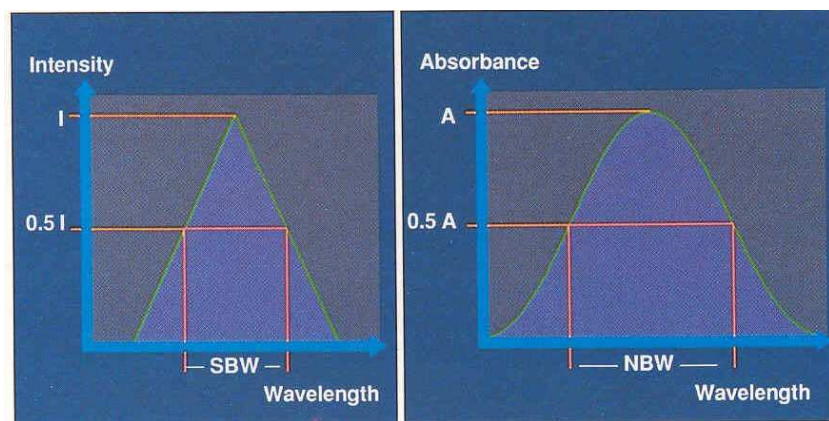

Charakteristiky přístroje

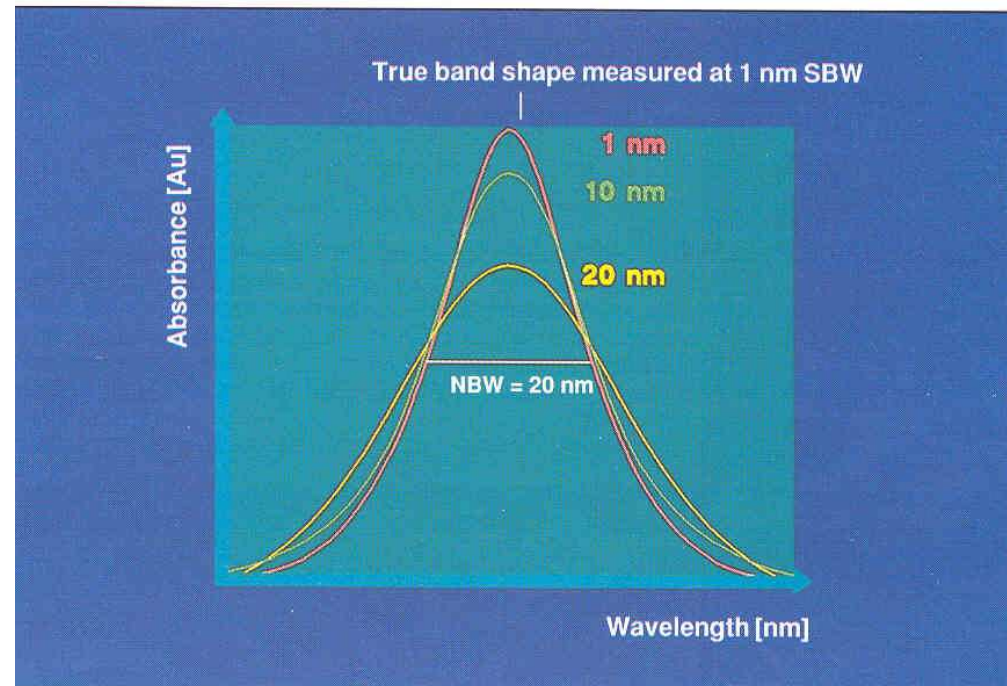

Přesnost měření závisí na poměru $SBW/NBW = 0.1$ a menší (přesnost 99.5%)
SBW 2 nm postačuje pro NBW 20 nm

Chyba měření

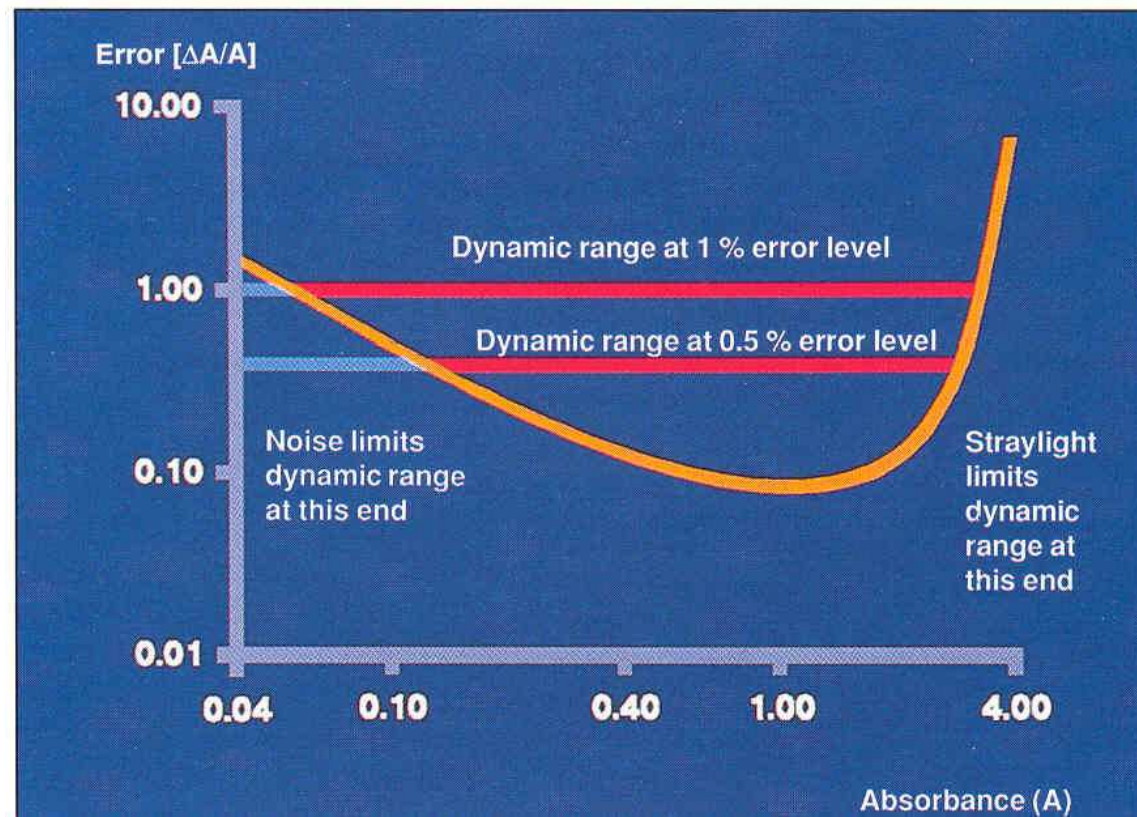

Diferenční spektroskopie

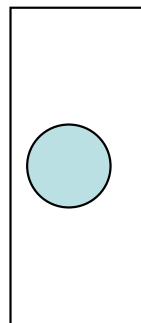
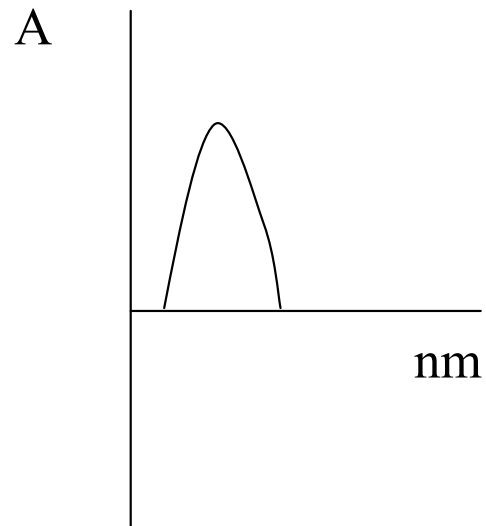

Diferenční spektroskopie

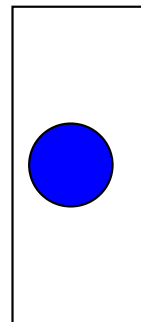
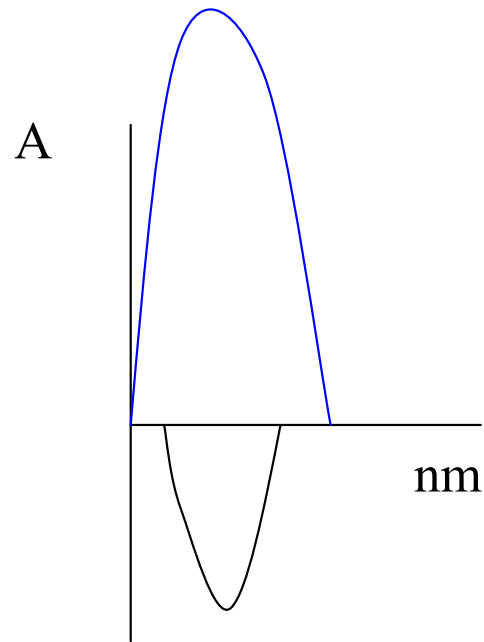

Diferenční spektroskopie

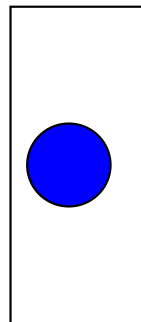
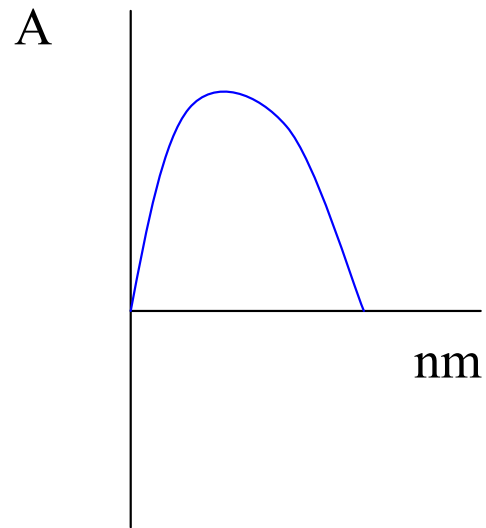

Stanovení bílkovin

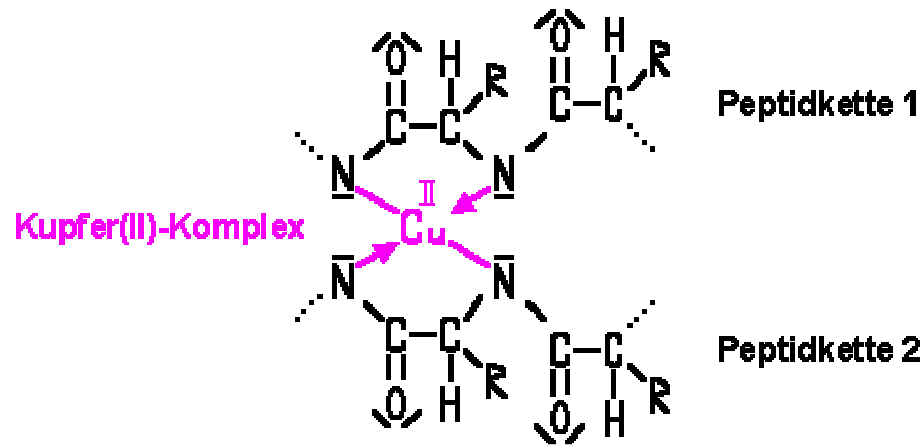

Biuretová metoda

Citlivost 1-20 mg

Interference: některé aminokyseliny,
zwiterionty

Lowryho metoda (595 nm)

Citlivost 10 ug

Zdlouhavost (2kroky)

Interference: ruší sulfát amonný., glycin,
SH reagenty, EDTA > 0.1 mM

Stanovení bílkovin

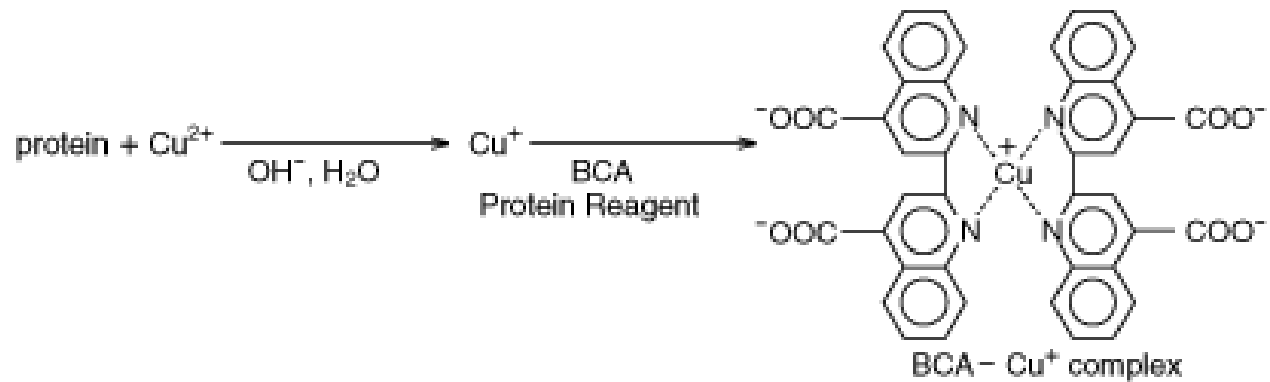

562 nm

Bicinchoninát

Citlivost vysoká

1 ug

Pracná metoda – 2 kroky

Interference: ruší EDTA, SH reagenty

Stanovení bílkovin

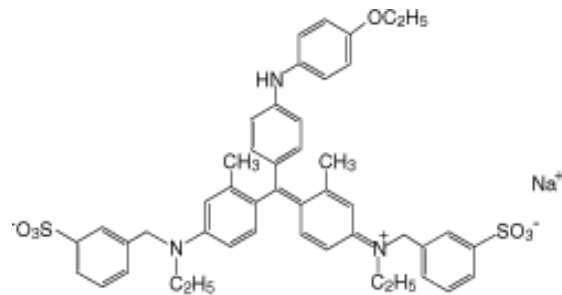

Coomassie Brilliant Blue G

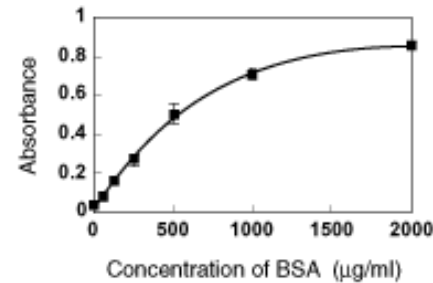

BSA standard solutionで作成した検量線の例

Posun maxima
Ze 465 na 595 nm

Metoda podle Brafordové

Citlivost vysoká 1 µg

Rychlá metoda (náročná na pečlivost)

Interference: ruší Triton X-100, SDS,

Silně bazické pufrы

Stanovení bílkovin

Absorpce v UV oblasti (Tyr, Try) – 280 nm

Citlivost 50 ug

Velmi rychlá metoda, nedestruktivní

Interference: ruší NK, zákal

$$C \text{ (mg/ml)} = A_{280}$$

$$C \text{ (mg/ml)} = A_{280}/\epsilon$$

$$C \text{ (mg/ml)} = 1,55 \cdot A_{280} - 0,76 A_{260}$$

ϵ (ml/mg)

BSA = 0,63

Ig = 1,38

Ovalbumin = 0,70

Použití spektroskopie pro studium konformace bílkovin

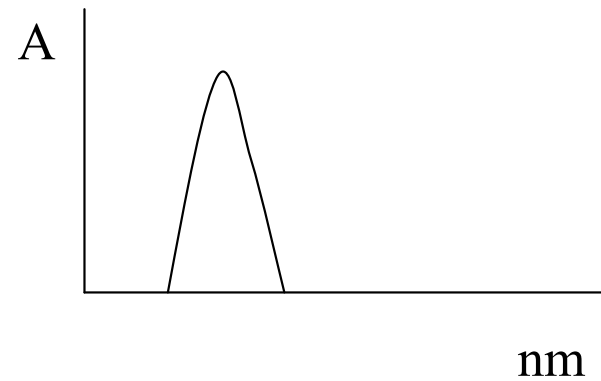
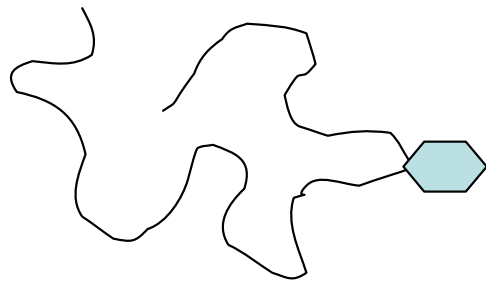

Fluorescence Try, Tyr – 280 nm

Závislost spektra na polaritě prostředí (červený posun)

Použití spektroskopie pro studium konformace bílkovin

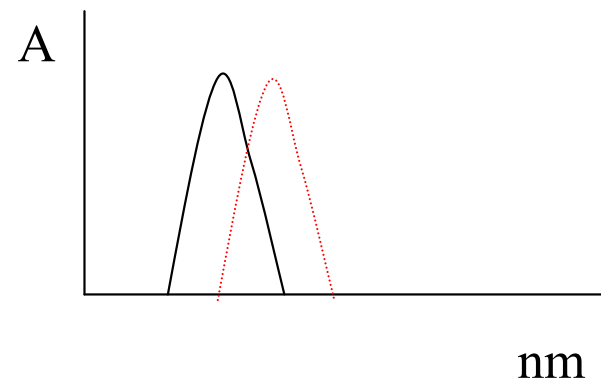
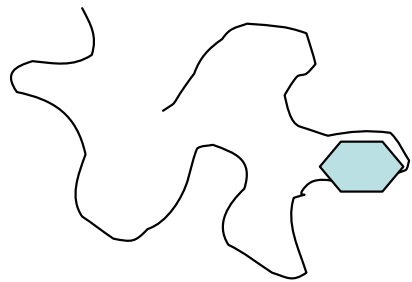

Fluorescence Try, Tyr – 280 nm

Závislost spektra na polaritě prostředí (červený posun v nepolárním prostředí)

Diferenční spektrum

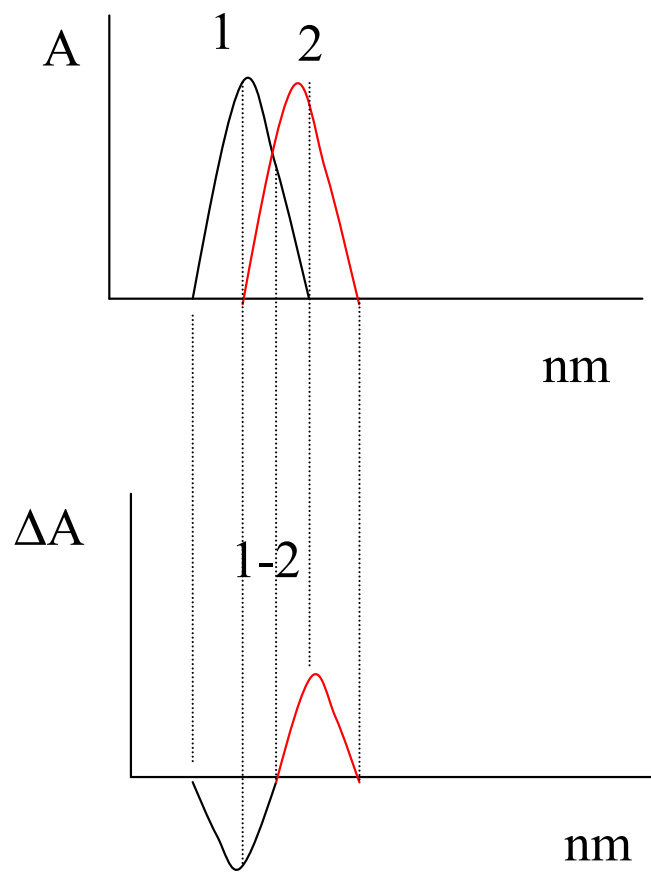

Použití spektroskopie pro studium konformace bílkovin

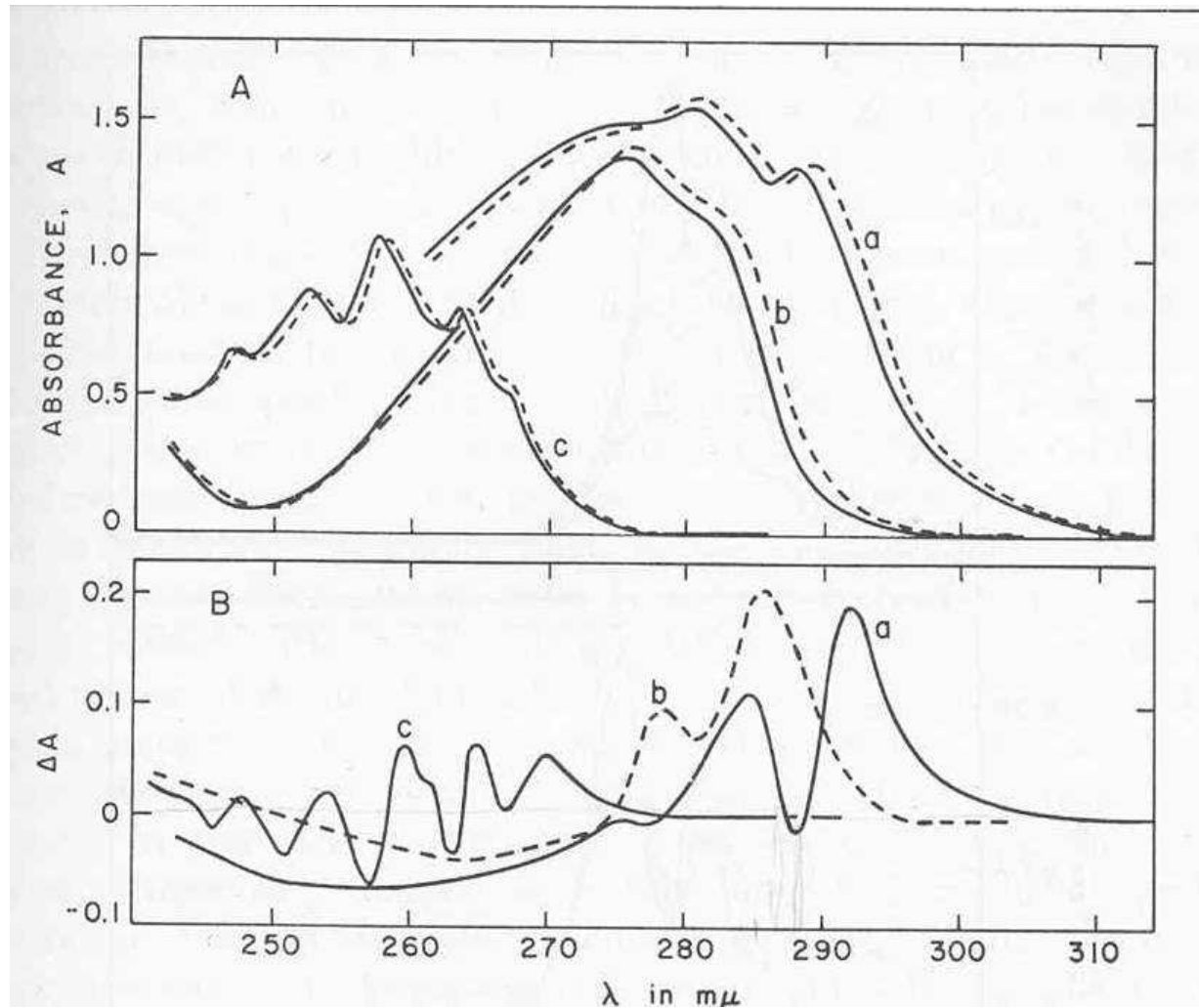

a – Try — voda
b – Tyr - - - DMSO
c - Phe

A – Absorpční spektrum

B – diferenční spektrum