

Growth of Single Crystals

High temperature methods

Czochralski
Stockbarger and Bridgman
Verneuil
Zone melting

Medium temperature methods

Fluxes
Electrochemical from melts
Hydrothermal
Vapor phase transfer
Sublimation

Low temperature methods

Solution
Gel

Growth of Single Crystals

Crystallization techniques: vapor, liquid, solid phase

Single crystals

●* **vital for meaningful property measurements of materials**

●* **allow measurement of anisotropic phenomena (electrical, optical, magnetic, mechanical, thermal) in anisotropic crystals (symmetry lower than cubic)**

●* **fabrication of devices**

$\text{Y}_3\text{Al}_5\text{O}_{12}$ (YAG = yttrium aluminum garnet) and beta-beryllium borate (BBO) for doubling and tripling the frequency of CW or pulsed laser light

SiO_2 (quartz) crystal oscillators for mass monitors

lithium niobate for photorefractive applications

Many different crystal growing techniques exist, hence one must think very carefully as to which method is the most appropriate for the material under consideration, size of crystal desired, stability in air, morphology or crystal habit required

Solidification of Materials

As a material cools off the average kinetic energy drops

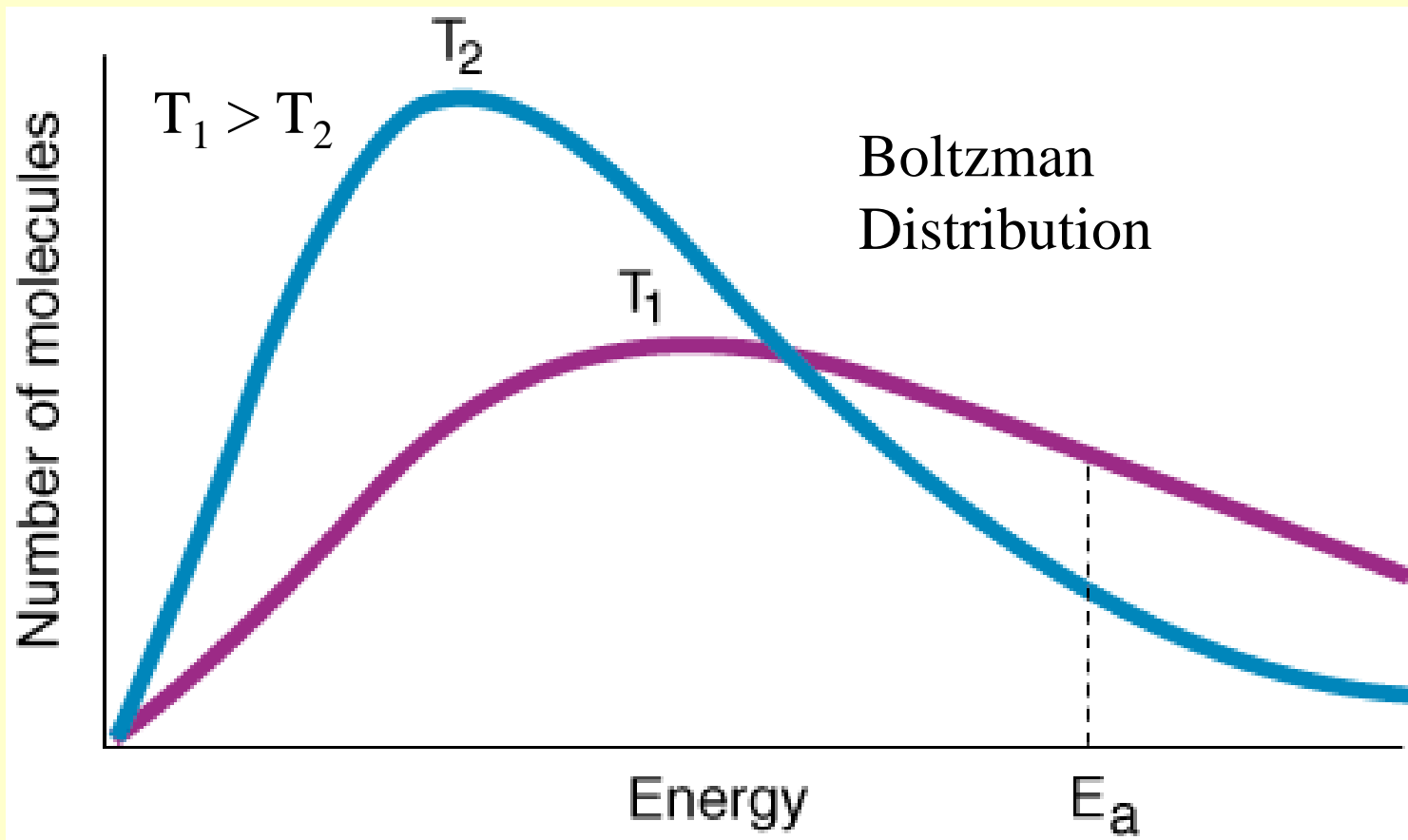

Crystallization

Nucleation – formation of nuclei of critical size

Crystal growth – diffusion of material toward the crystal,
deposition vs. dissolution

Formation of Nuclei

Molecules are always bumping into each other – sometimes they stick

At lower kinetic energies more molecules stick together = form nuclei

Cooling

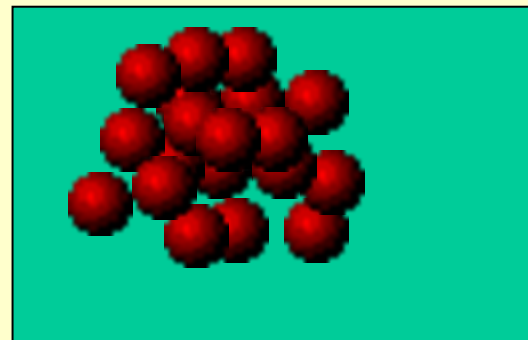
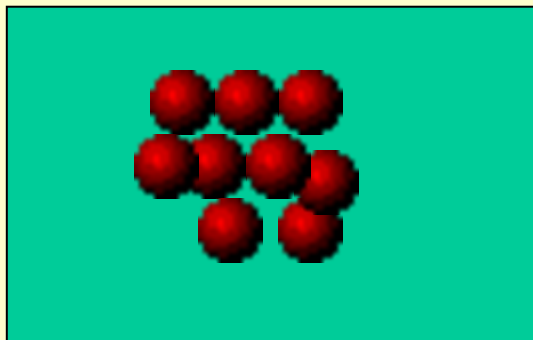

Solidification

The energy of the crystal structure is less than that of the liquid

The difference = the volume free energy ΔG_v

As the solid grows in size, the magnitude of the total volume free energy increases (a negative value)

When solids form in a liquid there is an interface created

The surface free energy, σ is associated with this interface

As the solid grows, the total surface free energy increases (a positive value)

Solidification

The total change in free energy for the system is the sum of the two factors.
For spherical nuclei

$$\Delta G = \frac{4}{3} \pi r^3 \Delta G_v + 4\pi r^2 \sigma$$

The **volume free energy** goes up with the cube of the radius

The **surface free energy** goes up with the square of the radius

ΔG has a maximum at a critical radius – critical free energy ΔG_c

If just a few molecules stick together, they will redissolve

If enough molecules stick together, the embryo will grow

$$\Delta G_V = -\frac{RT \ln S}{V_m}$$

ΔG_V – the free energy change between the ‘monomer’
in solution and unit volume of bulk crystal

S – supersaturation

V_m – molar volume of the bulk crystal

Total Free Energy of a Solid-Liquid System

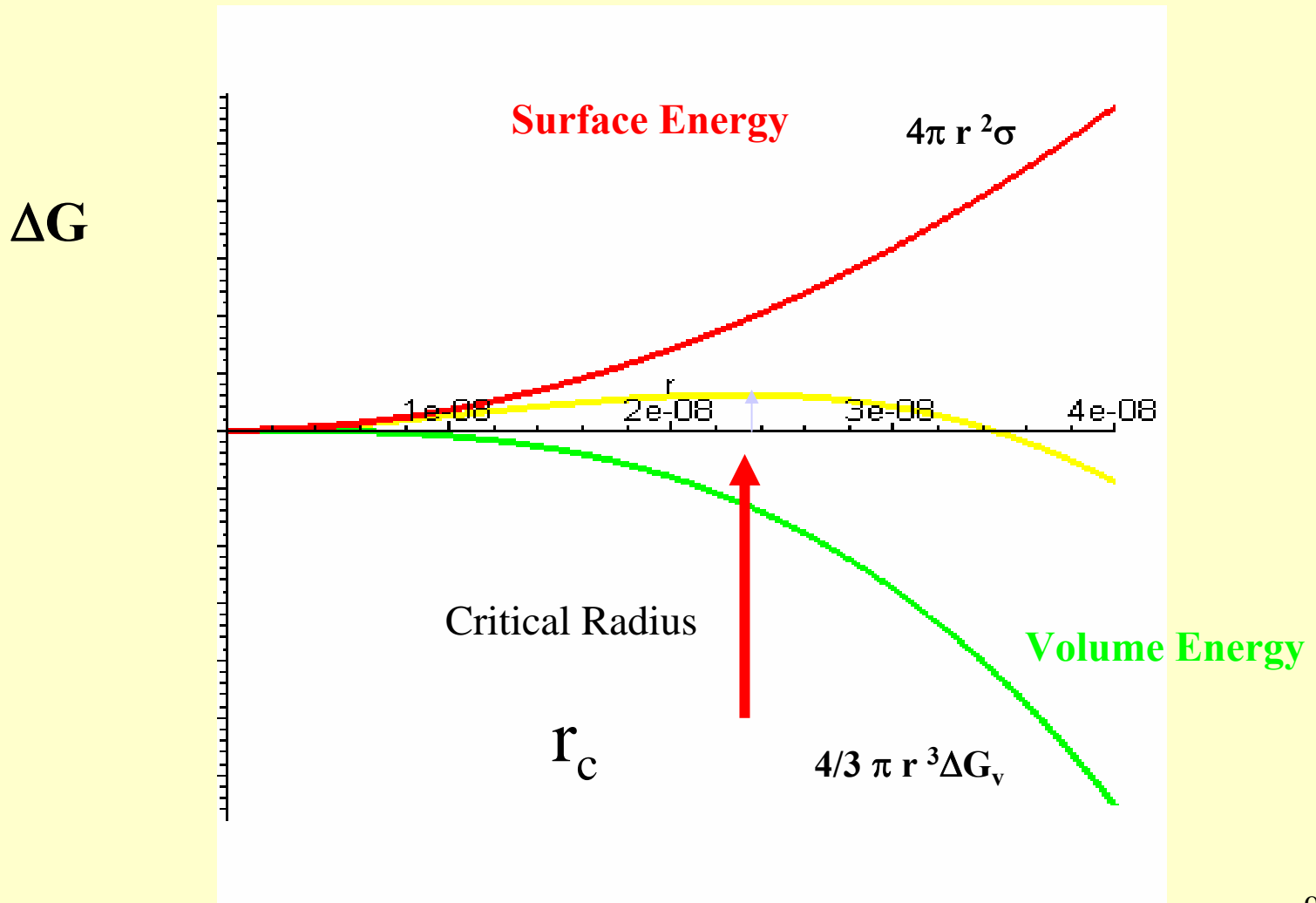

Supersaturated Solutions

If the liquid is just at the freezing point, only a few molecules stick, because they have comparatively high energy

As the liquid is cooled, more molecules can form into nuclei.

When the nucleus is big enough (because of undercooling) the supercooled liquid suddenly changes to a solid.

Homogeneous Nucleation - Critical Radius

r_c critical radius is:

S = super saturation

$$r_c = \frac{2\sigma}{\Delta G_V} = \frac{2\sigma V_m}{RT \ln S}$$

At larger supersaturation, the critical radius of nuclei is smaller -

Critical Free Energy ΔG_c

$$\Delta G_c = -\frac{16\pi\gamma^3 V_m^3}{3(RT \ln S)^2}$$

The free energy necessary to form stable nuclei

Rate of Nucleation

ΔG_c – the free energy barrier to nucleation

S – supersaturation

V_m – molar volume of the bulk crystal

Arrhenius

$$\frac{dN}{dt} = A \exp\left(-\frac{\Delta G_c}{kT}\right) = A \exp\left(-\frac{16\pi\gamma^3 V_m^3}{3k^3 T^3 N_A^2 (\ln S)^2}\right)$$

LaMer Plot

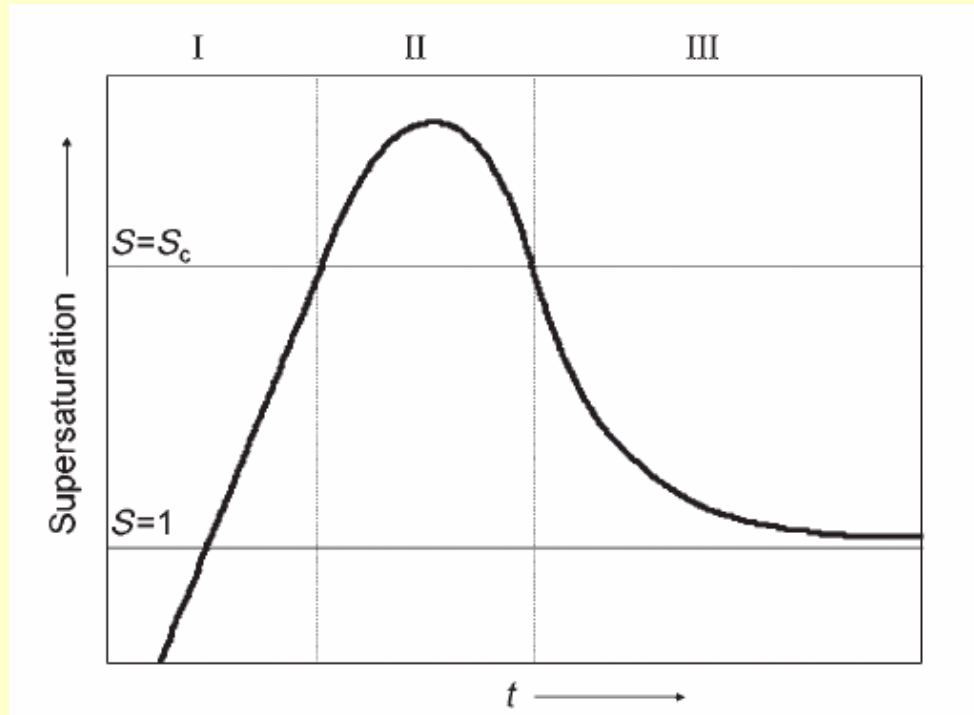

Burst nucleation - many nuclei generated at the same time, then the nuclei grow without additional nucleation
all of the particles nucleate simultaneously, their growth histories are the same.
control of the size distribution of the ensemble of particles during growth - synthesis of monodisperse nanocrystals

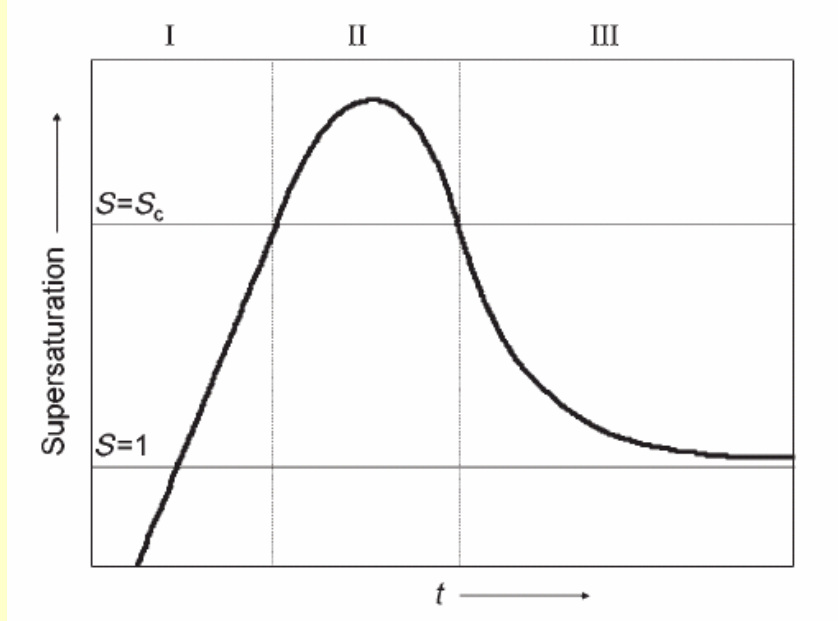

The concentration of “monomer”, (the minimum subunit of bulk crystal) constantly increases with time.

Stage I precipitation does not occur even under supersaturated conditions ($S > 1$), the energy barrier for spontaneous homogeneous nucleation is too high.

Stage II nucleation occurs, the degree of supersaturation is high enough to overcome the energy barrier for nucleation, the formation and accumulation of stable nuclei. The rate of monomer consumption exceeds the rate of monomer supply, the monomer concentration decreases until it reaches the level at which the nucleation rate is zero.

Stage III the growth stage, nucleation stopped, the particles keep growing as long as the solution is supersaturated

Homogeneous Nucleation

The process is called homogeneous nucleation

It only occurs if the material is very pure

The size of the critical radius is:

$$r^* = \frac{2\sigma T_m}{\Delta H_f \Delta T}$$

ΔT is the undercooling

Metals often experience undercooling of 50 to 500 °C

Growth

Growth by diffusion

the growth rate of spherical particles (dr/dt)

depends only on the flux of the monomers to the particles (J)

$$J = \frac{4\pi r^2}{V_m} \frac{dr}{dt}$$

$$J = 4\pi x^2 D \frac{dC}{dx}$$

$$\int_r^{r+\delta} \frac{dx}{x^2} = \frac{4\pi D}{J} \int_{C_s}^{C_\delta} dC$$

$$J = 4\pi D \frac{r(r+\delta)}{\delta} [C_\delta - C_s]$$

Heterogeneous Nucleation

Homogeneous nucleation usually only occurs in the lab.

Impurities provide a “seed” for nucleation

Solidification can start on a wall.

It’s like cloud seeding, or water condensing on the side of a glass.

Adding impurities on purpose is called inoculation

Growth and Solidification - Grain Size

Solidification caused by homogeneous nucleation occurs suddenly, and only produces a few grains

In heterogeneous nucleation, solidification occurs on many “seeds”, so the grains are smaller, and more uniform

If a melt is cooled slowly, and the temperature is the same throughout, solidification occurs with equal probability everywhere in the melt.

Metals are usually cooled from the container walls – so solidification starts on the walls

Nucleation vs. Crystal Growth (solution or melt)

Undercooling – cooling below the melting point

relations between undercooling, nucleation rate and growth rate of the nuclei

large undercooling: many small nuclei
(spontaneous nucleation)
growth rate small

small undercooling: few (evtl. small) nuclei
growth rate high

Nucleation vs. Crystal Growth

Rate of nucleation

Rate of growth

T_a = small undercooling, slow cooling rate

Fast growth, slow nucleation = Few coarse crystals

T_b = larger undercooling, rapid cooling rate

Rapid nucleation, slow growth = many fine-grained crystals

T_c = very rapid cooling

Nearly no nucleation = glass

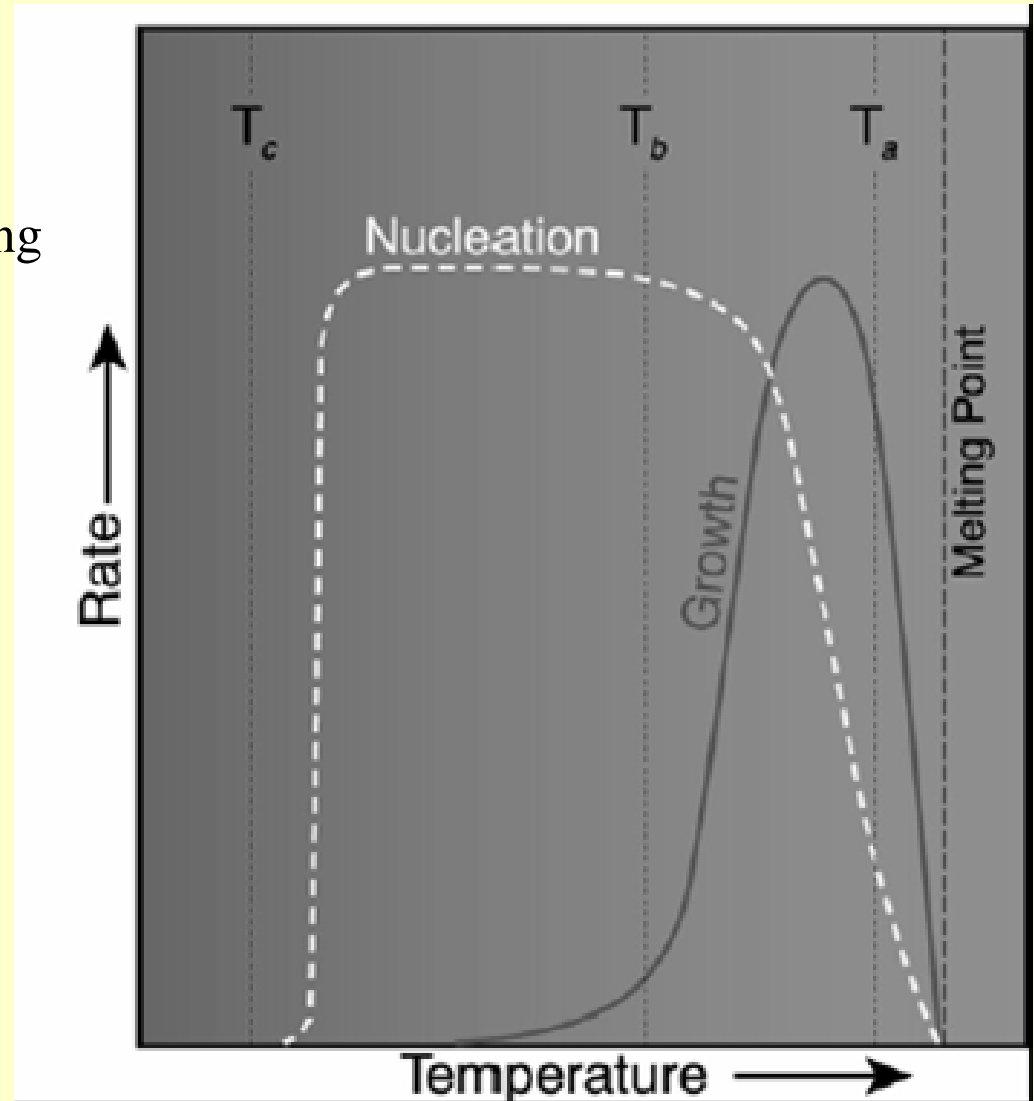

Heat of Fusion

When the liquid solidifies, energy must be removed.

In planar growth the energy is conducted into the solid and out through the walls of the container

If the melt is not well inoculated

Solidification starts on the walls

The surrounding liquid is supercooled, so the solid quickly grows

All heat that is evolved is hard to conduct away

Some of it is absorbed by the surrounding liquid which then heats up

Growth of Single Crystals

CZOCHEWSKI or KYROPOULOS METHOD

Crystal pulling technique

Single crystal growth from the melt precursor(s)

Crystal seed placed in contact with surface of melt

Temperature of melt held just above melting point = highest viscosity, lowest vapor pressure

Seed gradually pulled out of the melt, 1 mm per hour

Melt solidifies on surface of seed

Melt and seed usually rotated counterclockwise with respect to each other to maintain constant temperature and to facilitate uniformity of the melt during crystal growth, 10 rpm

Produces higher quality crystals, less defects

Inert atmosphere, often under pressure around growing crystal and melt to prevent any materials loss

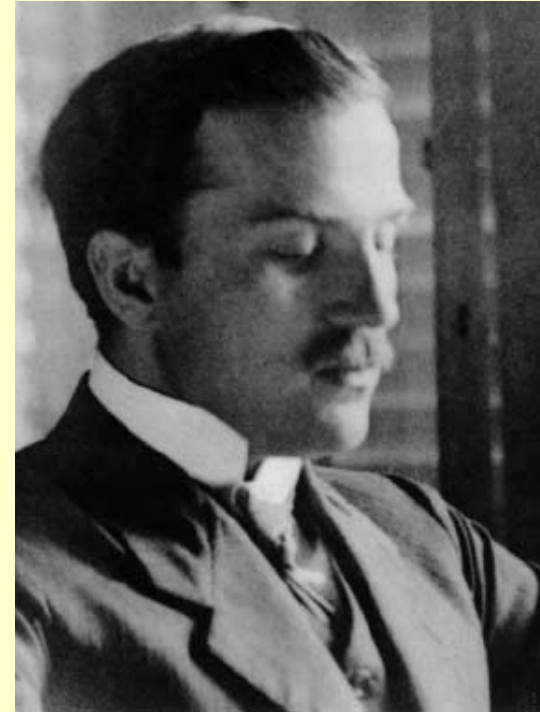

**Jan Czochralski
(1885–1953)**

Growth of Single Crystals

CZOCHRALSKI or KYROPOULOS METHOD

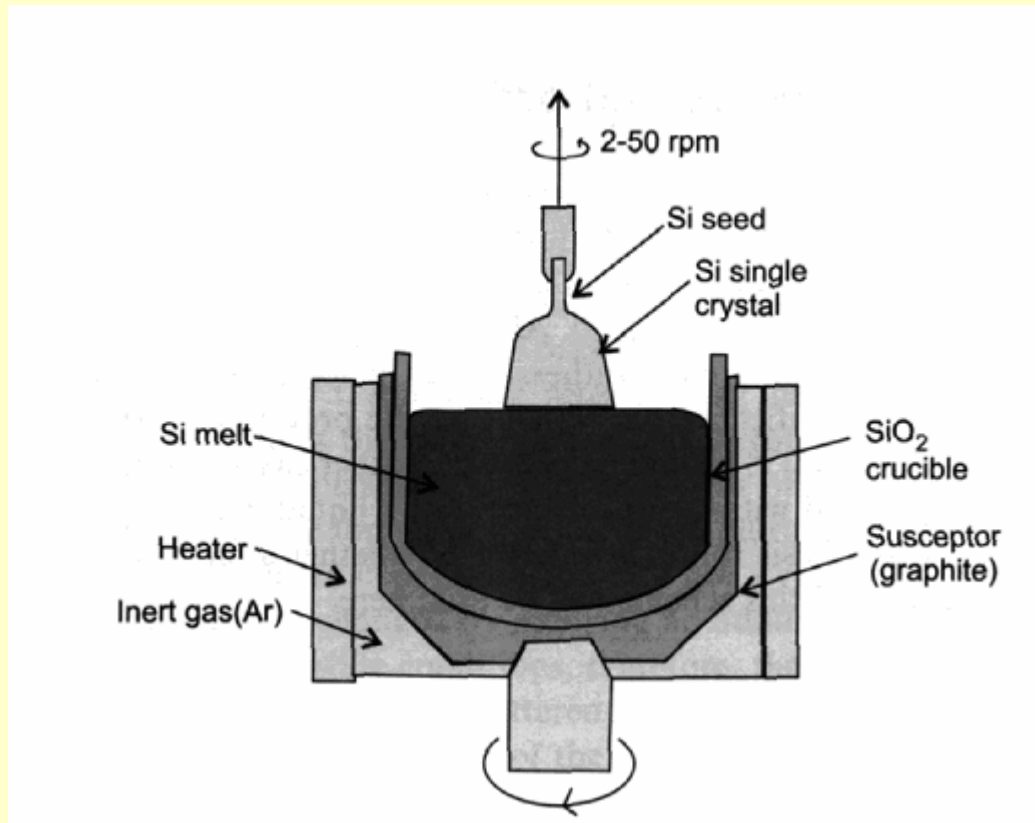



Diam 300 mm
Length 2 m
Weight 265 kg

Growth of Single Crystals

Growing bimetallic crystals like GaAs

Layer of molten inert oxide like B_2O_3 spread on to the molten feed material to prevent preferential volatilization of the more volatile component of the bimetal

critical for maintaining precise stoichiometry

for example $Ga_{1+x}As$ and $GaAs_{1+x}$ which are respectively rich in Ga and As, become p-doped and n-doped

Growth of Single Crystals

The Czochralski crystal pulling technique for growing large single crystals in the form of a rod subsequently cut and polished for various applications

Si

Ge

GaAs

LiNbO₃

SrTiO₃

NdCa(NbO₃)₂

Six steps in the CZ growth of a silicon single crystal:

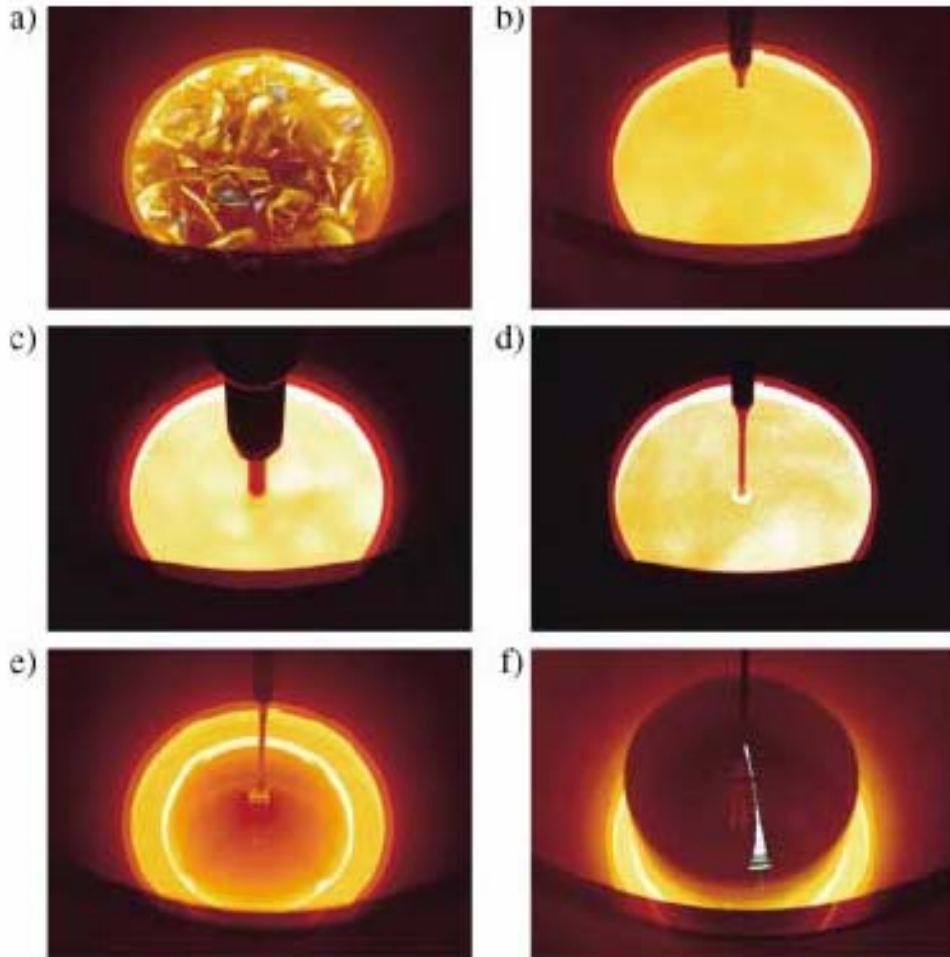

a) Evacuation and heating of the polycrystalline silicon (“pumping”)

b) Setting the temperature of the Si melt just above 1414 °C (“melting”)

c) Dipping the thin Si seed crystal into the homogeneous Si melt (“dipping”)

d) Initiating crystallization at the neck of the thin Si seed (“necking”)

e) Adjustment of the shoulder of the desired single crystal diameter (“shoulder”; four positions which portray the fourfold drawing axis [100] are visible at the hot, light marginal zone of the single crystal)

f) Growing phase of the single crystal with constant diameter (“body”).

Growth of Single Crystals

STOCKBARGER AND BRIDGMAN METHODS

Stockbarger method is based on a crystal growing from the melt, involves the relative displacement of melt and a temperature gradient furnace, fixed gradient and a moving melt/crystal

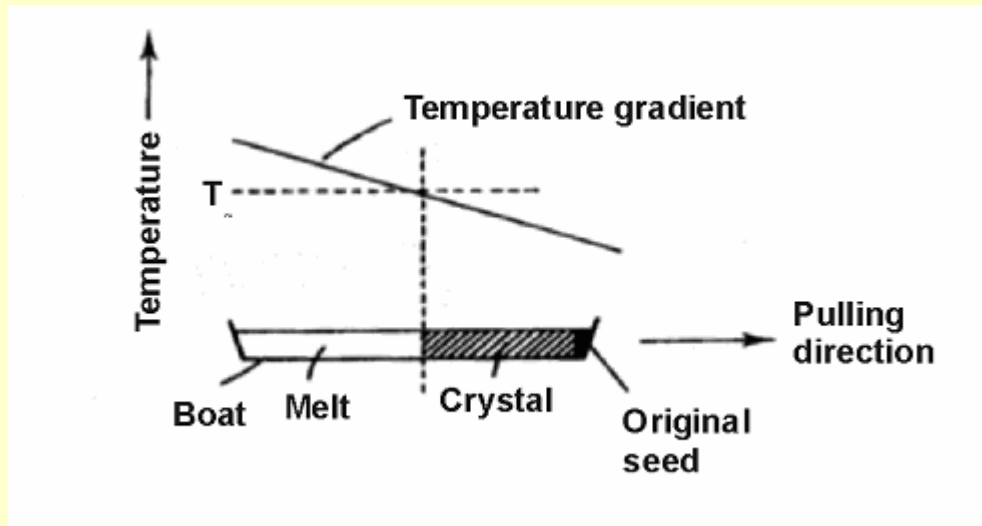

Growth of Single Crystals

STOCKBARGER AND BRIDGMAN METHODS

Bridgman method is again based on crystal growth from a melt, but now a temperature gradient furnace is gradually cooled and crystallization begins at the cooler end, fixed crystal and changing temperature gradient

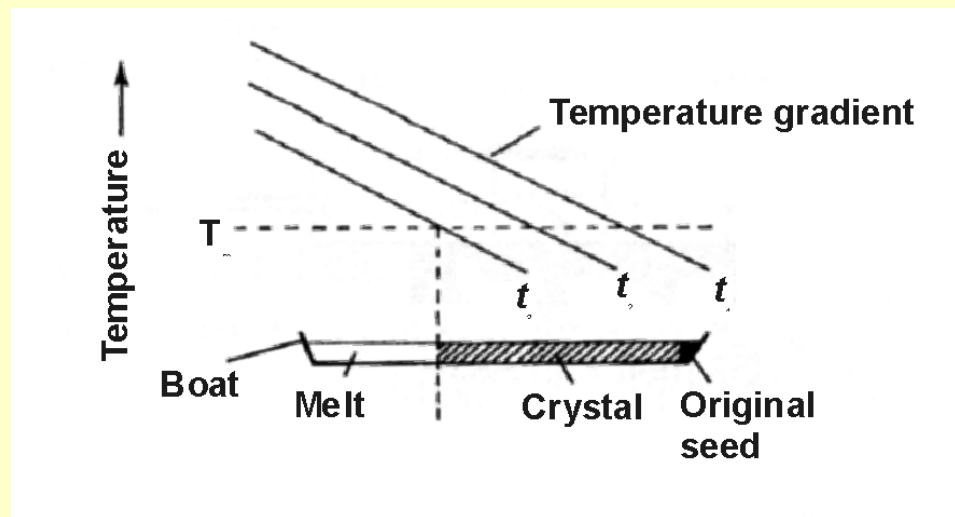

Both methods are founded on the controlled solidification of a stoichiometric melt of the material to be crystallized

Enables oriented solidification

Melt passes through a temperature gradient

Crystallization occurs at the cooler end

Both methods benefit from seed crystals and controlled atmospheres (sealed containers)

crystal	mp (°C)	velocity of grad.	container material
Al₂O₃	2037	2-8 mm h⁻¹	Mo
FeAl₂O₄	1790	5-10	Ir
Cu	1083	6-60	graphite
AgBr	434	1-5	Pyrex
Ar (!)	-189	0.5-1.5	Mylar

ZONE MELTING CRYSTAL GROWTH AND PURIFICATION OF SOLIDS

Thermal profile furnace, RF, arc, electron beam heating

Material contained in a boat (must be inert to the melt)

Only a small region of the charge is melted at any one time

Initially part of the melt is in contact with the seed

Boat containing sample pulled at a controlled velocity through the thermal profile furnace - zone of material melted

Oriented solidification of crystal occurs on the seed

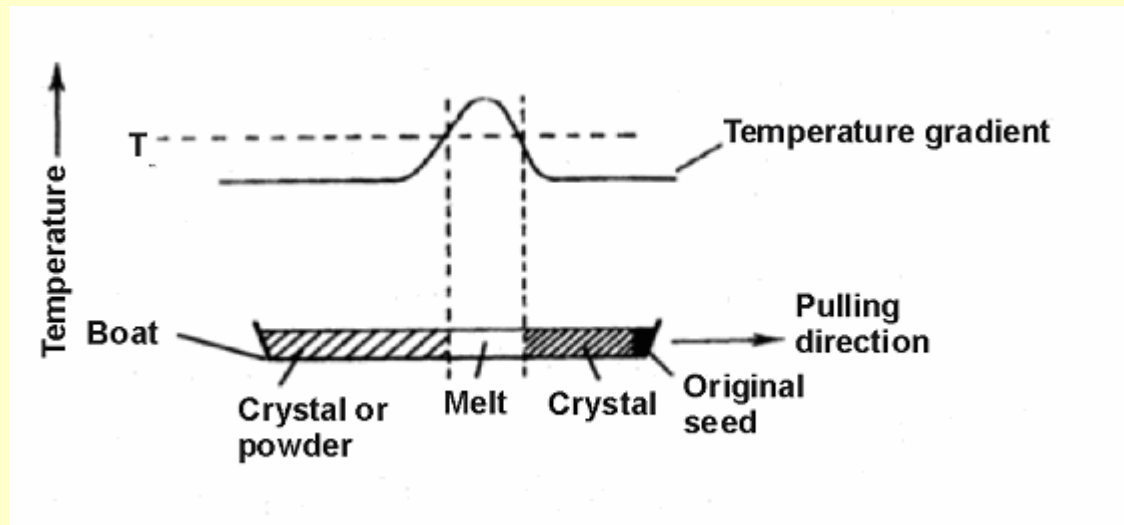

ZONE MELTING CRYSTAL GROWTH AND PURIFICATION OF SOLIDS

Zone refining methods for purifying solids

Partitioning of impurities occurs between melt and the crystal

Impurities concentrate in liquid more than the solid phase, swept out of crystal by moving the liquid zone

Used for purifying materials like W, Si, Ge to ppb level of impurities, often required for device applications

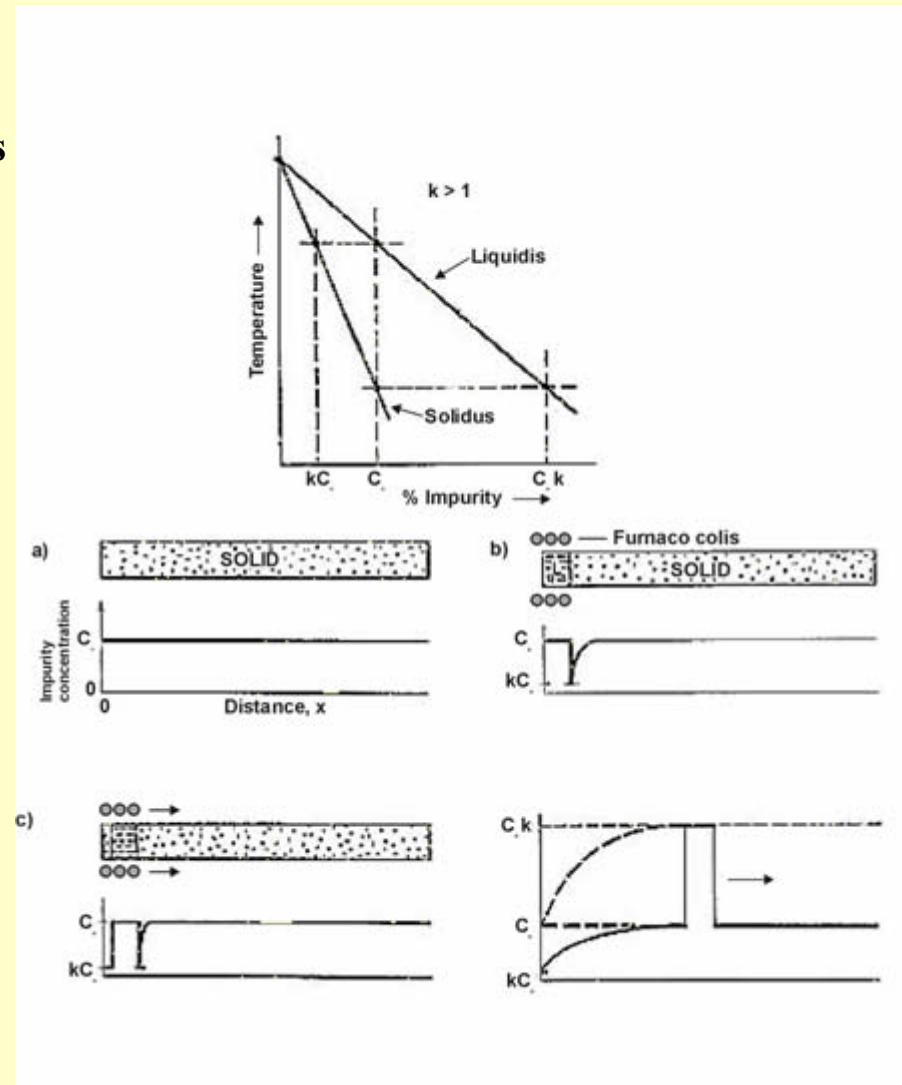

ZONE MELTING CRYSTAL GROWTH AND PURIFICATION OF SOLIDS

- a small slice of the sample is molten and moved continuously along the sample**
- impurities normally dissolve preferably in the melt
(!! icebergs in salt water don't contain any salt !!)**
- segregation coefficient k:**

$$k = c_{\text{solid}}/c_{\text{liquid}}$$

(c: concentration of an impurity)

only impurities with $k < 1$ can be removed by zone melting !!

ZONE MELTING CRYSTAL GROWTH AND PURIFICATION OF SOLIDS

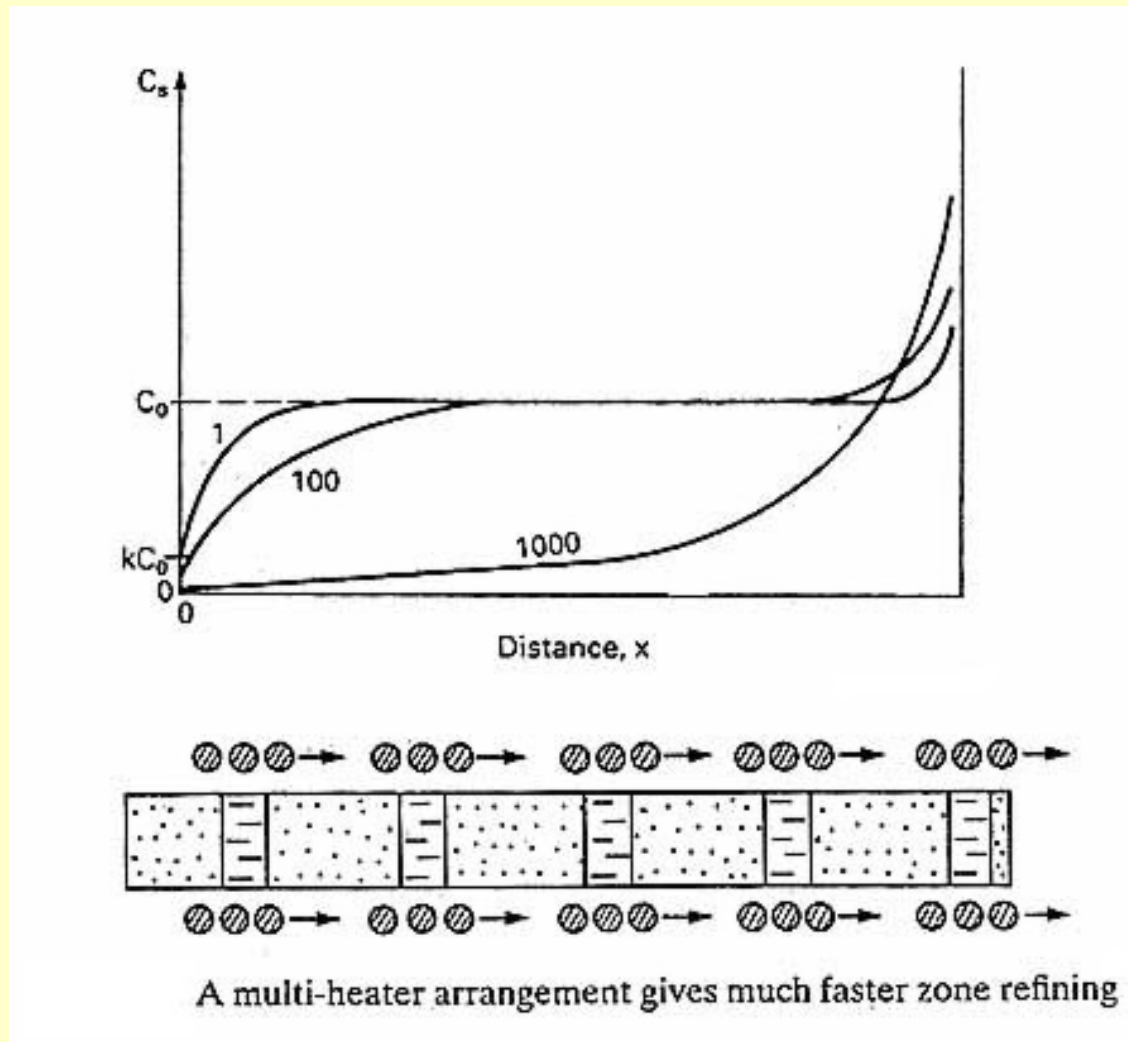

ZONE MELTING CRYSTAL GROWTH AND PURIFICATION OF SOLIDS

FLOATING ZONE METHOD

Molten zone is confined by surface tension between a polycrystalline ingot and a single-crystal seed

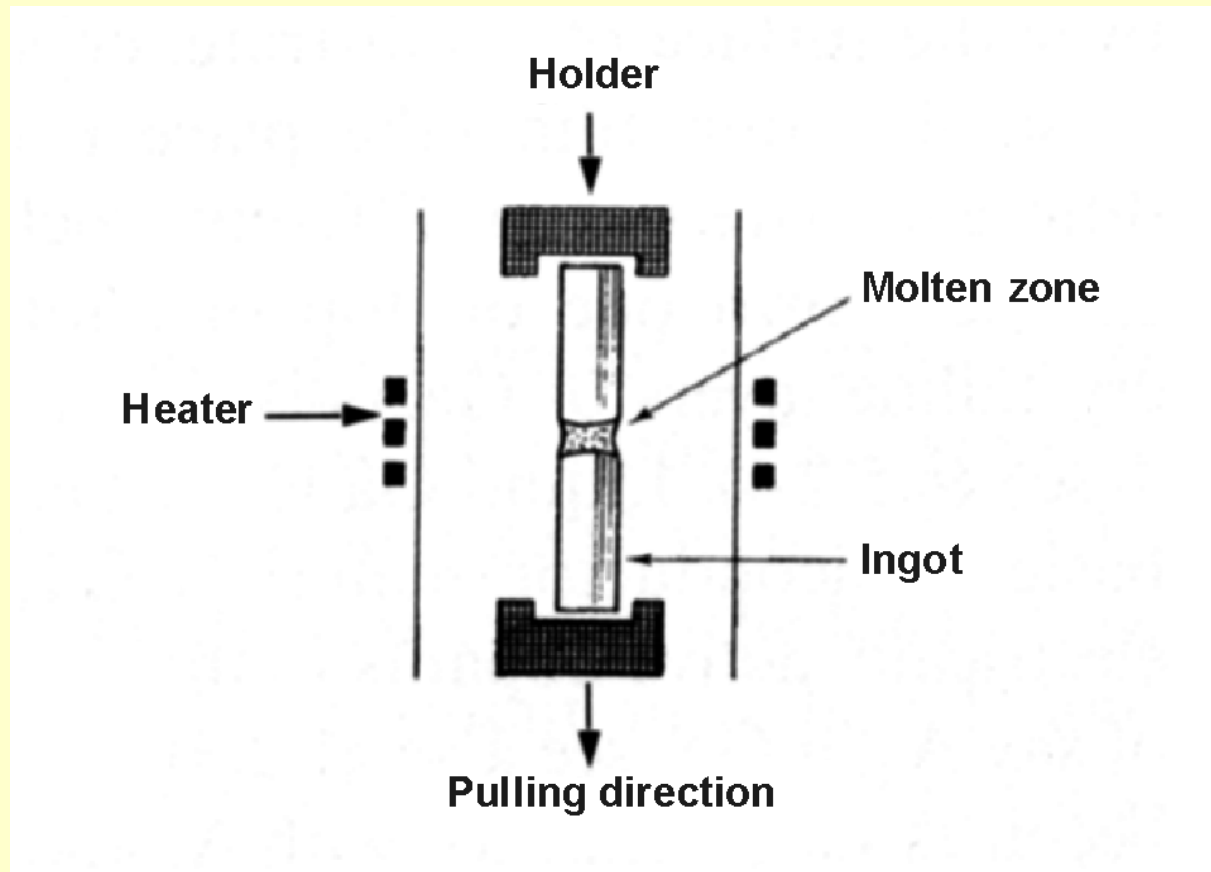

VERNEUIL FUSION FLAME METHOD

1904 first recorded use of the method
Useful for growing crystals
of extremely high melting metal oxides
Examples include:

Ruby from $\text{Cr}^{3+}/\text{Al}_2\text{O}_3$ powder

Sapphire from $\text{Cr}_2^{6+}/\text{Al}_2\text{O}_3$ powder

Spinel, CoO, ferrites

Starting material fine powder

Passed through O_2/H_2 flame or plasma torch

Melting of the powder occurs in the flame

Molten droplets fall onto the surface of a seed or growing crystal

Controlled crystal growth

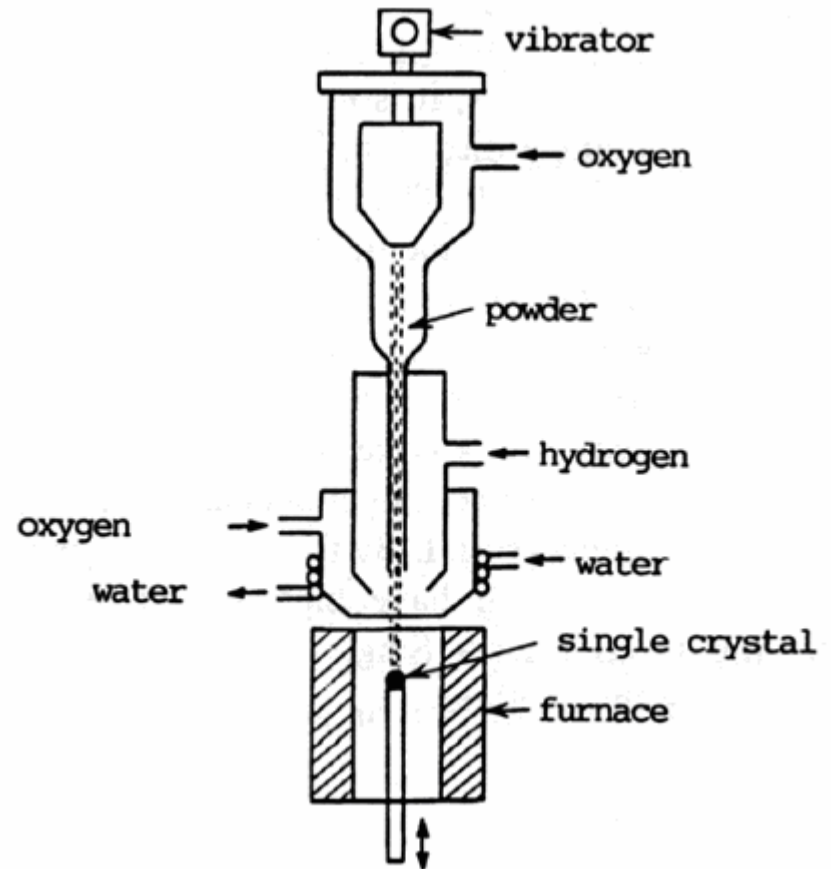

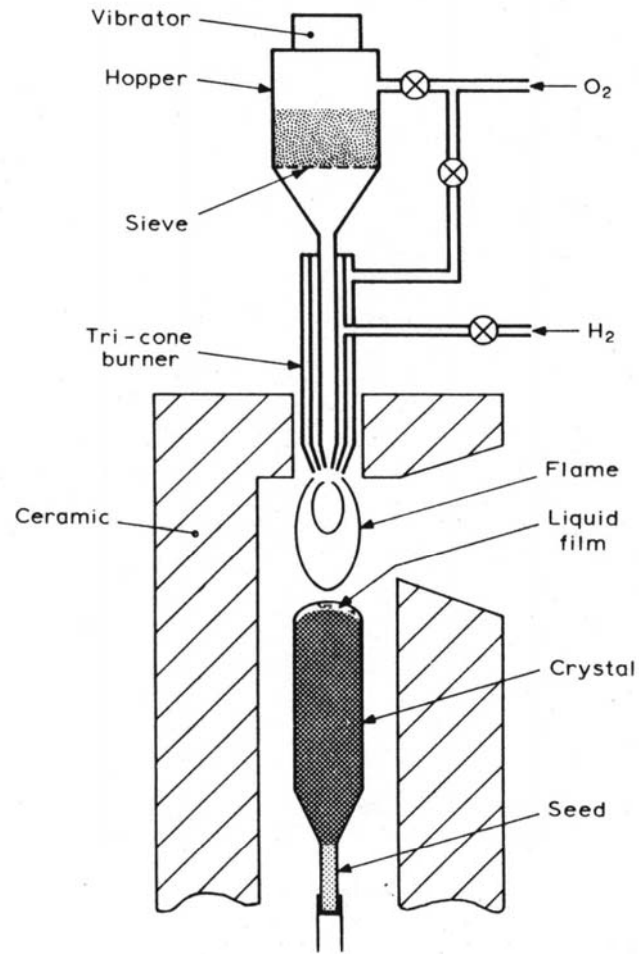

Figure 5.1 A system for the Verneuil growth of oxides. Note that the burner is composed of three coaxial tubes. Some workers use more tubes, and there are also designs using many small parallel tubes. With these it is possible to produce wider flames, and by having independent controls on various sets of tubes it is possible to optimize the heat input to give a nearly flat growth face on a large crystal.

THE FLUX METHOD

Material dissolved in a suitable flux = solvent (metals, fluorides, oxides), lower melting point than the pure solute

Single crystals grown from supersaturated solution

Suitable for materials which:

- ◆ vaporize or dissociate at temperatures above their mp
- ◆ there are no suitable containers at elevated temperatures

Material	Flux
As	Ga
B	Pt
Si, Ge	Pb, Zn, Sn
GaAs, GaP	Pb, Zn, Sn
BaTiO ₃	KF
ZnO	PbF ₂
ZnS	SnF ₂
MgFe ₂ O ₄	NaF
Co ₃ O ₄	B ₂ O ₃ – PbO
Fe ₂ O ₃	Na ₂ B ₄ O ₇
TiO ₂	Na ₂ B ₄ O ₇ – B ₂ O ₃

THE FLUX METHOD

AlF_3

2.0 g of AlF_3 , 25.0 g of PbCl_2 , 2.5 g PbF_2

24 h at 1200 K, cooled at 4 deg h^{-1} down to 723 K

thick platelets and small cubes

THE SOLUTION METHOD

Suitable for materials with a reasonable solubility in the selected solvent: water, organic solvents, $\text{NH}_3(\text{l})$, HF , $\text{SO}_2(\text{l})$

Nucleation homogeneous
 heterogeneous

Dilute solution, solvent with low solubility for given solute

Supersaturated solution, seed crystals

Single crystals grown at constant supersaturation

Techniques:

- ◆ slow evaporation
- ◆ slow cooling
- ◆ vapor diffusion
- ◆ solvent diffusion
- ◆ reactant diffusion
- ◆ recirculation, thermal differential, convection
- ◆ cocrystallants (OPPh_3 for organic proton donors)
- ◆ counterion, similar size of cation and anion least soluble
- ◆ ionization of neutral compounds, protonation/deprotonation, hydrogen bonding

Rochelle salt: $d\text{-NaKC}_4\text{H}_4\text{O}_6 \cdot 4\text{H}_2\text{O}$ (tartrate)

KDP

alum

KDP crystals (KH_2PO_4)

grown from supersaturated solution

crystal seed

slow cooling



HYDROTHERMAL SYNTHESIS

Water medium

High temperature growth, above normal boiling point

Water acts as a pressure transmitting agent

Water functions as solubilizing phase

Often a mineralizing agent is added to assist with the transport of reactants and crystal growth

Speeds up chemical reactions between solids

Crystal growth hydrothermally involves:

Temperature gradient reactor = autoclave (bomb !!)

Dissolution of reactants at one end

Transport with help of mineralizer to seed at the other end

Crystallization at the other end

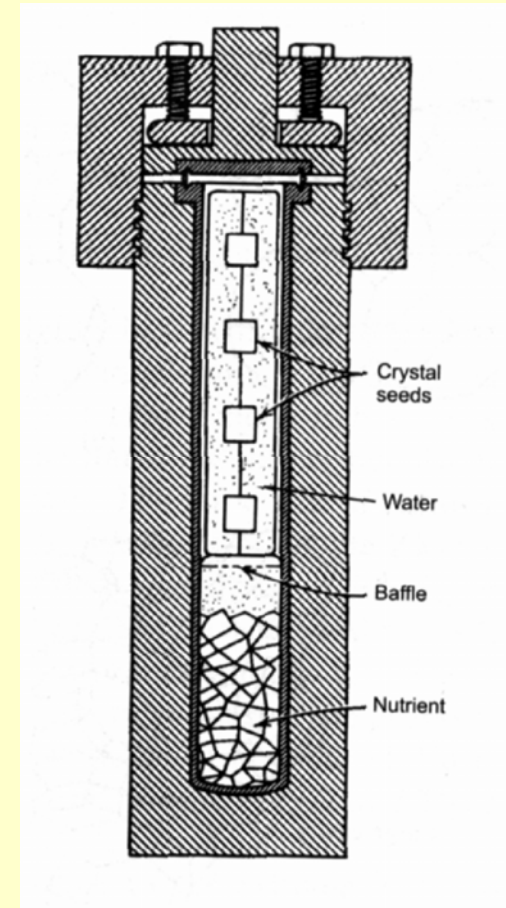

HYDROTHERMAL SYNTHESIS

Useful technique for the synthesis and crystal growth of phases that are unstable in a high temperature preparation in the absence of water

materials with low solubility in water below 100 °C

Some materials have negative solubility coefficients, crystals can grow at the hotter end in a temperature gradient hydrothermal reactor

Example: α -AlPO₄ (Berlinite) important for its high piezoelectric coefficient (larger than α -quartz with which it is isoelectronic) used as a high frequency oscillator

Hydrothermal growth of quartz crystals

**Water medium, nutrients 400 °C, seed 360 °C, pressure 1.7 kbar
Mineralizer 1M NaOH**

Uses of single crystal quartz: Radar, sonar, piezoelectric transducers, monochromators, XRD

Annual global production hundreds of tons of quartz crystals

HYDROTHERMAL SYNTHESIS

Hydrothermal crystal growth is also suitable for growing single crystals of:

Ruby: $\text{Cr}^{3+}/\text{Al}_2\text{O}_3$

Corundum: $\alpha\text{-Al}_2\text{O}_3$

Sapphire: $\text{Cr}_2^{6+}/\text{Al}_2\text{O}_3$

Emerald: $\text{Cr}^{3+}/\text{Be}_3\text{Al}_2\text{Si}_6\text{O}_{18}$

Berlinite: $\alpha\text{-AlPO}_4$

Metals: Au, Ag, Pt, Co, Ni, Tl, As

Role of the mineralizer:

Control of crystal growth rate:

choice of mineralizer, temperature and pressure

Solubility of quartz in water is important

HYDROTHERMAL SYNTHESIS

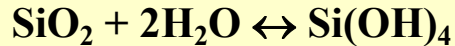

0.3 wt% even at supercritical temperatures >374 °C

A mineralizer is a complexing agent (not too stable) for the reactants/precursors that need to be solublized (not too much) and transported to the growing crystal

Some mineralizing reactions:

NaOH mineralizer, dissolving reaction, 1.3-2.0 kbar

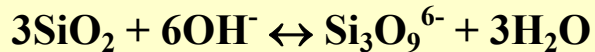

Na₂CO₃ mineralizer, dissolving reaction, 0.7-1.3 kbar

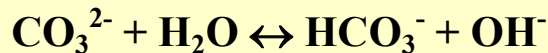
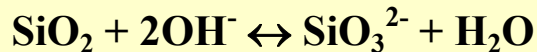

NaOH creates growth rates about 2x greater than with Na₂CO₃ because of different concentrations of hydroxide mineralizer

HYDROTHERMAL SYNTHESIS

Examples of hydrothermal crystal growth and mineralizers

Berlinite α -AlPO₄

Powdered AlPO₄ cool end of reactor

negative solubility coefficient!!!

H₃PO₄/H₂O mineralizer, AlPO₄ seed crystal at hot end

Emeralds Cr³⁺/Be₃Al₂Si₆O₁₈

SiO₂ powder at hot end 600 °C, NH₄Cl or HCl/H₂O mineralizer, 0.7-

1.4 kbar, cool central region for seed, 500 °C, Al₂O₃/BeO/Cr³⁺

dopant powder mixture at other hot end 600 °C



Beryl contains Si₆O₁₈¹²⁻ six rings

HYDROTHERMAL SYNTHESIS

Metal crystals

Metal powder at cool end 480 °C, Mineralizer 10M HI/I₂

Metal seed at hot end 500 °C.

Dissolving reaction that also transports Au to the seed crystal:

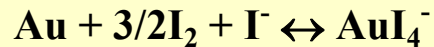

Metal crystals grown this way include Au, Ag, Pt, Co, Ni, Tl, As at 480-500 °C

Diamonds

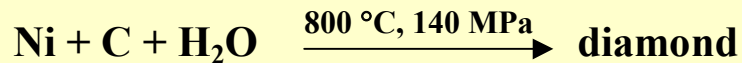

HYDROTHERMAL SYNTHESIS

Carbon films on SiC fibers

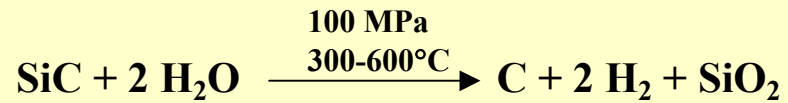

Zeolites

$\text{Al}(\text{OH})_3$, SiO_2 , NaOH , template

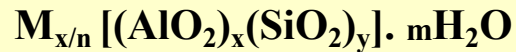

HYDROTHERMAL SYNTHESIS

necessitates knowledge of what is going on in an autoclave under different degrees of filling and temperature

Pressure, volume, temperature tables of dense fluids like water

Critical point of water: 374.2 °C, 218.3 bar

Density of liquid water decreases with T

Density of water vapor increases with T

Density of gas and liquid water the same 0.32 gcm^{-3} , at the critical point

Liquid level in autoclave rises for > 32% volume filling

Autoclave filled at 250 °C for > 32% volume filling

For 32% volume filling liquid level remains unchanged and becomes fluid at critical temperature

HYDROTHERMAL SYNTHESIS

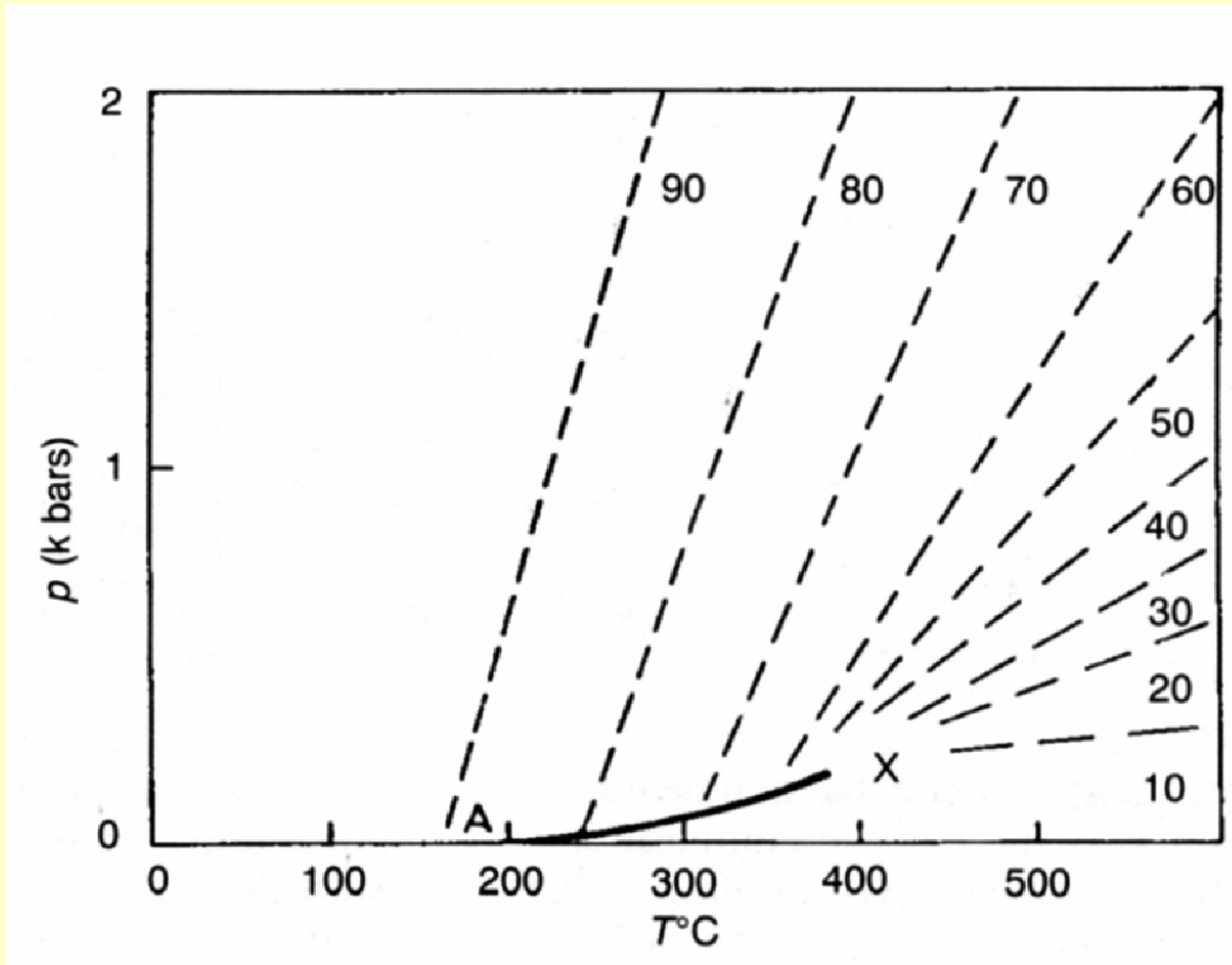

HYDROTHERMAL SYNTHESIS

Tables of pressure versus temperature for different initial volume filling of autoclave must be consulted to establish a particular set of reaction conditions for a hydrothermal synthesis or crystallization

Safety: if this is not done correctly, with proper protection equipment in place, you can have an autoclave explosion that can kill!!!

BULK-MATERIAL DISSOLUTION TECHNIQUE

large zeolite crystals: up to 3 mm, SOD, MFI, ANA,CAN, JBW

autoclave, PTFE liner

quartz tube (SiO₂) TPAOH, HF, H₂O 200 °C, 25-50 days

ceramic tube (SiO₂, Al₂O₃) NaOH, H₂O 100-200 °C, 7-20 days

Small surface area, low dissolution rate, saturation concentration maintained, only a few nuclei are produced at the beginning, no large crystals formed in the stirred reactions, concentration gradients

DECOMPLEXATION CRYSTALLIZATION

crystallization under ambient conditions, low temperature and pressure, provides kinetic products, control of crystal size and morphology, habit

AgX, X = Cl, Br, I

MX, M = H, Na, K, NH₄

AgI + HI \rightleftharpoons H⁺ + [AgI₂]⁻ aqueous solution

**overlayer absolute ethanol, HI diffusion, decomplexation of AgI,
hexagonal plates 5 mm**

AgX + 2 NH₃ \rightleftharpoons [Ag(NH₃)₂]⁺ + X⁻

X = Cl, Br, slow evaporation (3-5 days), AgX crystals

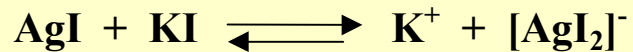

© concentration gives $\text{K}[\text{AgI}_2]$ crystals

© dilution by slow diffusion gives 20 mm AgI crystals

© warming gives AgI crystals (inverse temperature dependence of AgI solubility in KI)

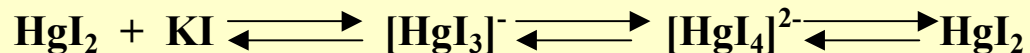
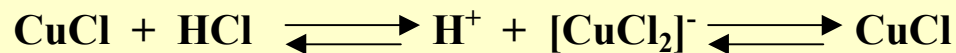

PbO + hot KOH solution, slow cooling provides PbO as 2 mm yellow needles and 1 mm red blocks

COMPLEXATION-MEDIATED CRYSTALLIZATION

**Salts with high lattice energy
fluorides, carbonates, acetates**

**Solubilized in organic solvents by crown ethers
Crystallization provides uncomplexed salts**

**$\text{NaOOCCH}_3 \cdot 3\text{H}_2\text{O}$ dissolves in cyclohexane with 15-crown-5
prismatic crystals**

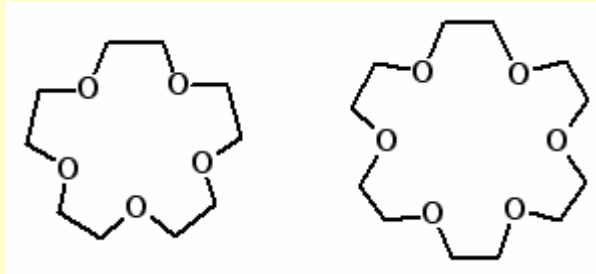

COMPLEXATION-MEDIATED REACTION CRYSTALLIZATION

Two soluble salts react to produce an insoluble phase

© **aqueous solutions**

© **nonaqueous solvents**

CaCO₃ calcite TD stable phase at room temp., in H₂O
vaterite kinetic product
aragonite TD stable at high temperature

CaCl₂ (in MeOH) + NaHCO₃ (in MeOH, 18-crown-6)

microcrystalline calcite

upon aging converts to nanocrystalline vaterite, surface stabilization by surface chelation

THE GEL METHOD

Large single crystals

◆ hydrogels: silicagel (water glass), polyvinyl alcohol, gelatin, agar

Silicate gel

Impregnation with metal or ligand, setting the gel = condensation, crosslinking, pH control of the condensation rate

Layered with the solution of ligand or metal

Slow diffusion, xtal growth

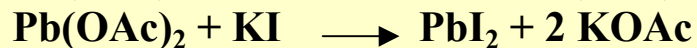
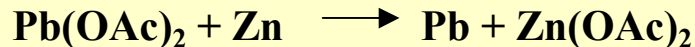
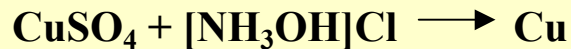

Liesegang rings, agates

RbSnBr_3 , CsSb_2I_5 semiconductors

THE GEL METHOD

◆ nonaqueous gels

**PEO (MW = 100 000) in 1,2-dichloroethane + MeOH, EtOH, PrOH,
DMF, CH₃CN, DMSO**

Impregnation with metal or ligand

Layered with the solution of ligand or metal

Slow diffusion, crystal growth

U-tube, counter-diffusion

Concentration programming, increasing concentrations

Ostwald rippening = larger xtals grow, smaller dissolve

ELECTROCHEMICAL REDUCTIVE SYNTHESIS, CRYSTAL GROWTH

Molten mixtures of precursors, product crystallizes from melt

Melt electrochemistry: Electrochemical reduction

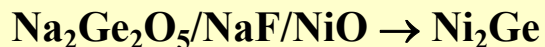
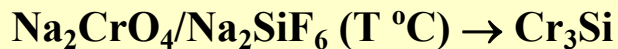
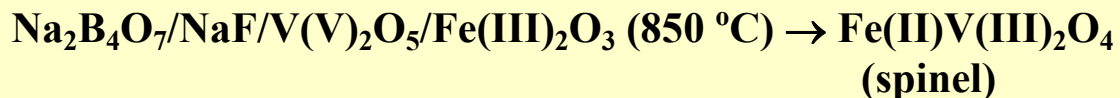
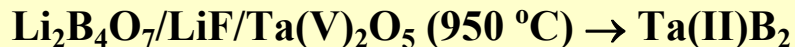
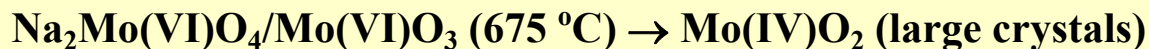
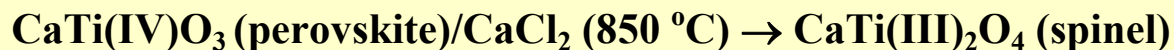

ELECTROCHEMICAL REDUCTIVE SYNTHESIS, CRYSTAL GROWTH

Phosphates → phosphides

Carbonates → carbides

Borates → borides

Sulfates → sulfides

Silicates → silicides

Germanates → germides

Synthesis of amorphous materials

Quenching of molten mixture of metal oxide with a glass former (P_2O_5 , V_2O_5 , Bi_2O_3 , SiO_2 , CaO , ...), large cooling rates required ($>10^7 \text{ K s}^{-1}$)

Ion beam sputtering

Thermal evaporation

**Thermal decomposition of organometallic precursors ($\text{Fe}(\text{CO})_5$, ...)
 Cr_2O_3 , MnO_2 , PbO_2 , V_2O_5 , Fe_2O_3**

**Sonochemical decomposition of organometallic precursors
($\text{Fe}(\text{CO})_5$, $\text{M}(\text{acac})_n$, ...)**

Precipitation on metal hydroxides, transformation to hydrous oxides

**MW heating of metal salt solution
 Cr_2O_3 , Fe_2O_3**