

Aplikovaná chemie a biochemie



Přednáška č. 5

Nukleové kyseliny



Práce s nukleovými kyselinami

- Izolace DNA
- Izolace RNA
- Gelová elektroforéza
- Detekce mRNA - Northern blotting, RNase protection assay, RT-PCR, expression microarrays

Isolation of Nucleic Acids

Goals:

- removal of proteins
- DNA vs RNA
- isolation of a specific type of nucleic acid

Types of DNA:

- genomic (chromosomal)
- organellar (satellite)
- plasmid (extra-chromosomal)
- phage/viral (ds or ss)
- complementary (mRNA)

Types of Methods:

- differential solubility
- 'adsorption' methods
- density gradient centrifugation

General Features:

- denaturing cell lysis (SDS, alkali, boiling, chaotropic)
- \pm enzyme treatments
 - protease
 - RNase (DNase-free)
 - DNase (RNase-free)

High MW Genomic DNA Isolation

Typical Procedure

- 1 Cell Lysis
 - 0.5% SDS + proteinase K (55° several hours)
- 2 Phenol Extraction
 - gentle rocking several hours
- 3 Ethanol Precipitation
- 4 RNase followed by proteinase K
- 5 Repeat phenol extraction and EtOH ppt

Phenol Extraction

- mix sample with equal volume of sat. phenol soln
- retain aqueous phase
- optional chloroform/isoamyl alcohol extraction(s)

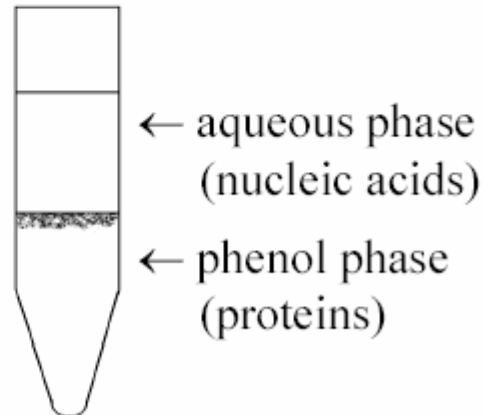

High MW Genomic DNA Isolation

Typical Procedure

- 1 Cell Lysis
 - 0.5% SDS + proteinase K (55° several hours)
- 2 Phenol Extraction
 - gentle rocking several hours
- 3 Ethanol Precipitation
- 4 RNase followed by proteinase K
- 5 Repeat Phenol Extraction and EtOH ppt

EtOH Precipitation

- 2-2.5 volumes EtOH, -20°
- high salt, pH 5-5.5
- centrifuge or 'spool' out

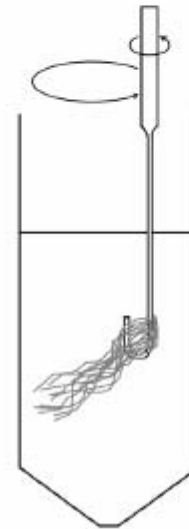

Isolation of RNA

Special Considerations

- RNase inhibitors!
- extraction in guanidine salts
- phenol extractions at pH 5-6
 - (pH 8 for DNA)
- treatment with RNase-free DNase
- selective precipitation of high MW forms (rRNA, mRNA) with LiCl
- oligo-dT column

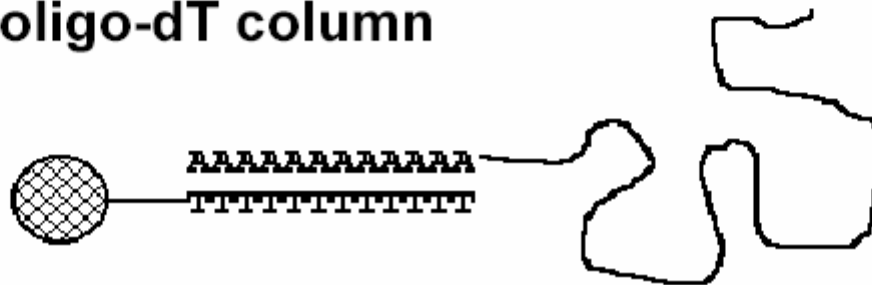



Adsorption Methods

- nucleic acids selectively absorb to silica or diatomaceous earth in presence of certain chaotropic agents or salts
- applications:
 - plasmid preps
 - fragments after electrophoresis
 - PCR templates

Plasmid Miniprep Protocol

1. Solubilize bacteria in alkali solution
2. Neutralize with Na-acetate
3. Centrifuge, discard pellet
4. Mix supernatant with resin + chaotropic agent
5. Wash resin
6. Elute DNA with low salt buffer

Izolace plazmidů

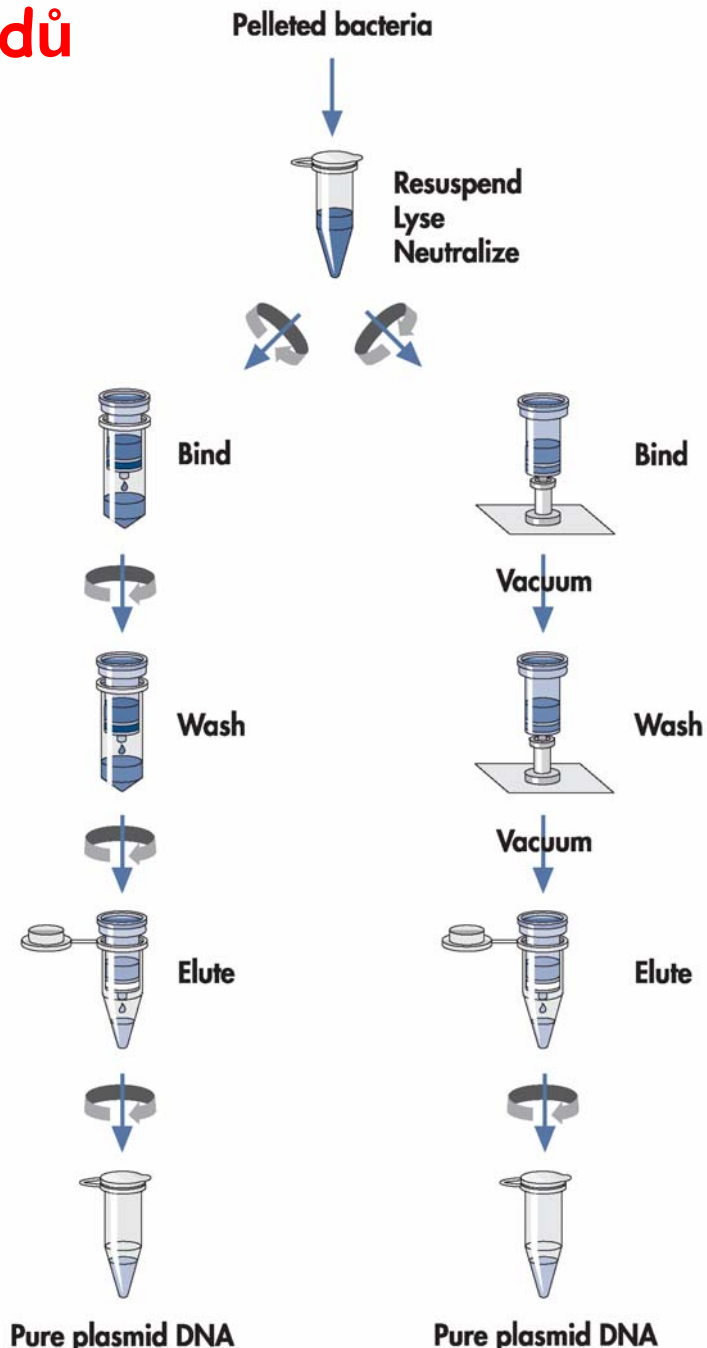

RNA extraction and isolation

"Isolation of high quality RNA is one of the most challenging techniques in modern molecular biology"

Nice versus nasty

Chomczynski, P. and Sacchi, N. Single-Step Method of RNA Isolation by Acid Guanidinium Thiocyanate- phenol-chloroform extraction. *Anal. Biochem.* 162, 156-159 (1987).

Will require use of inhibitors to inactivate endogenous RNases

e.g. guanidinium isothiocyanate (GITC)

RNAzol/Trizol/Ultraspec (14M GITC and urea salts)

Qiagen RNeasy - use of columns to avoid organic extractions.



Issues related to RNA isolation

- ❖ protection of RNA against degradation by RNases
 - avoid touching samples
 - RNase inhibitors such as Guanidinium Thiocyanat
- ❖ removal of contaminating DNA
 - acid-phenol chloroform extraction
 - oligo d(T) methods (only eukaryotic mRNA)
 - DNases

Best methods for removing DNA contamination

❖ Oligo d(T) methods (for eukaryotic mRNA only)

- exploit the poly(A) tail of eukaryotic mRNA
- hybridize Oligo d(T) + a with poly(A) tail
- separate bound mRNA

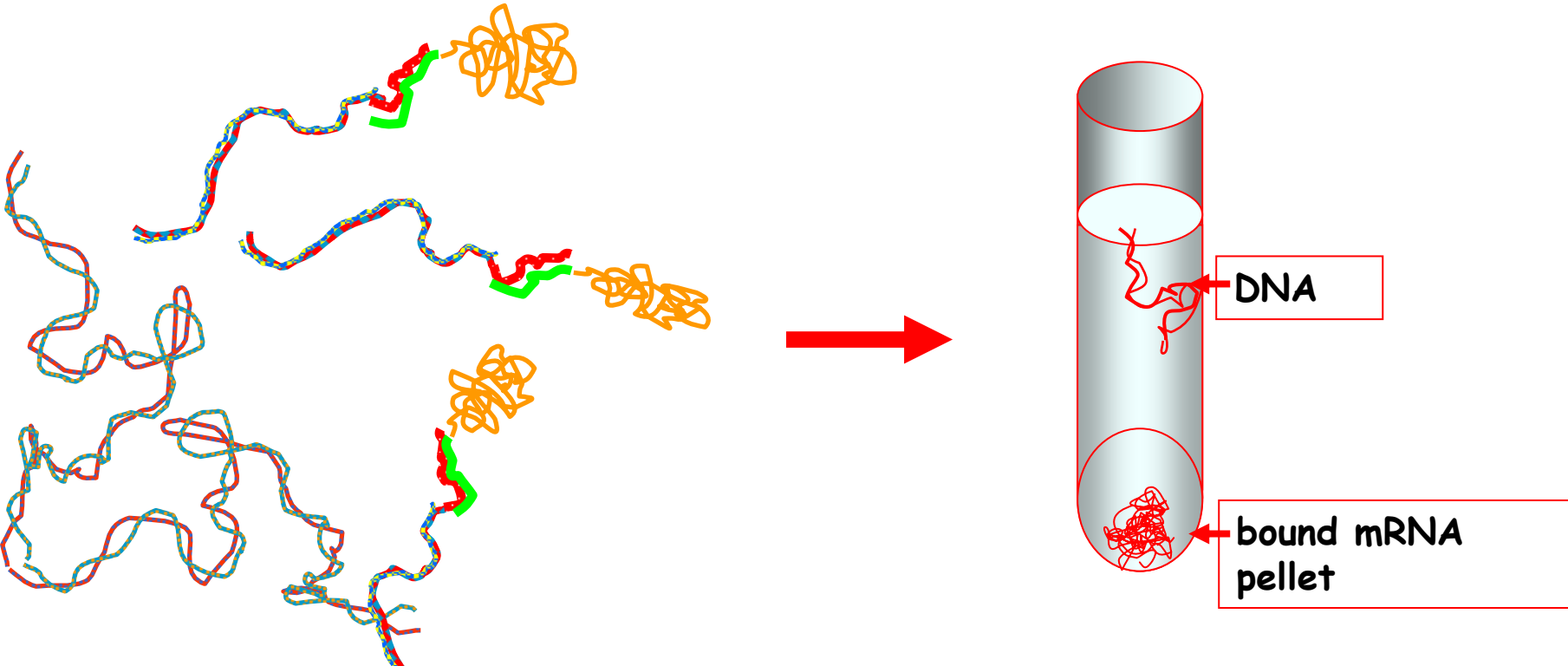

Best methods for removing DNA contamination

❖ DNase

1. degrade contaminating DNA with Dnase
2. disable / remove DNase



Izolace RNA pomocí kitů

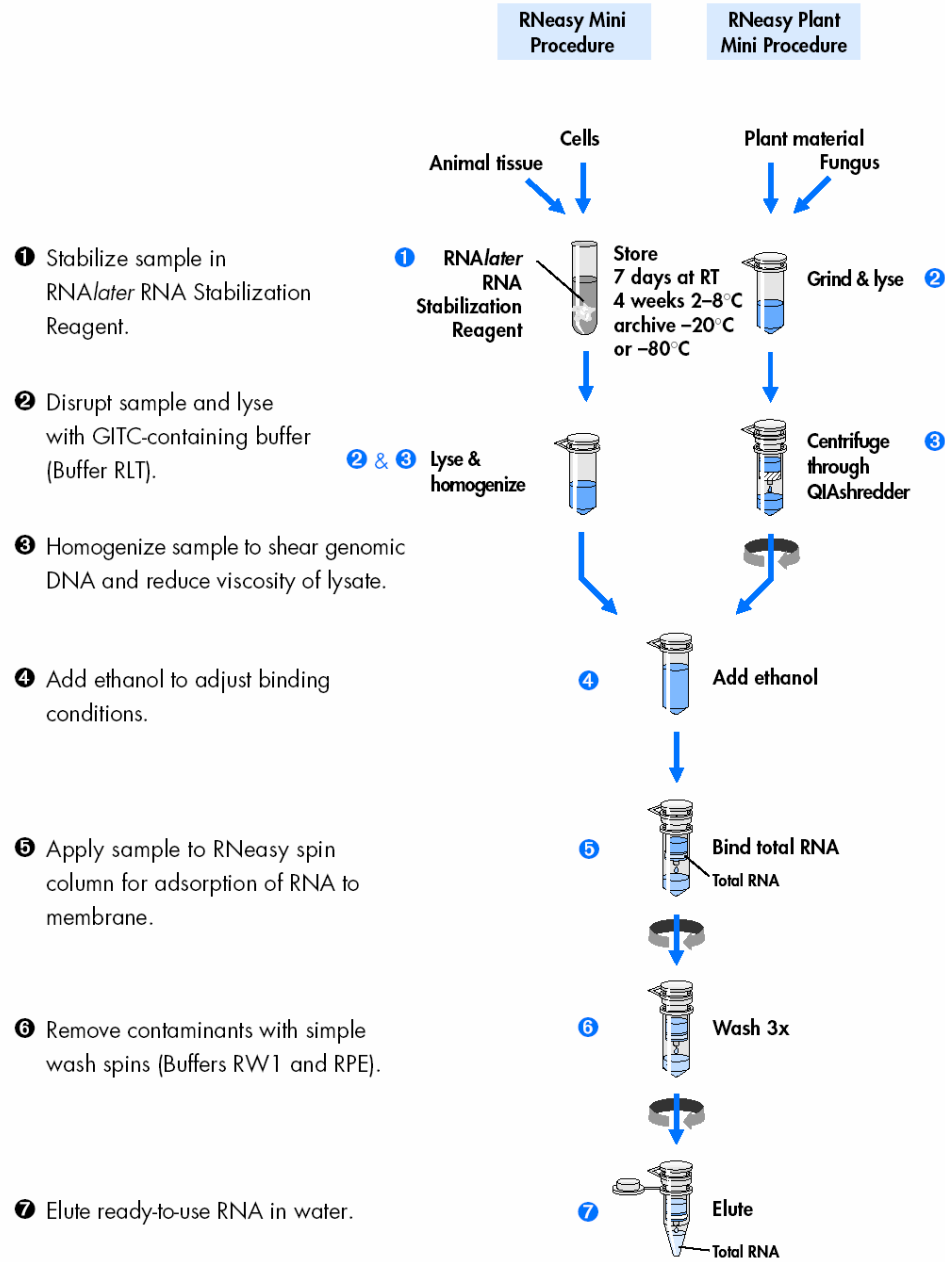

Evaluation of Nucleic Acids

- spectrophotometrically
 - quantity
 - quality
- fluorescent dyes
 - gel electrophoresis

DNA	A_{260}	1.0 \approx 50 $\mu\text{g/ml}$
	A_{260}/A_{280}	1.6 - 1.8
RNA	A_{260}	1.0 \approx 40 $\mu\text{g/ml}$
	A_{260}/A_{280}	\sim 2.0

RNA extraction and isolation

Total RNA versus mRNA

Depends on final usage

mRNA will comprise 2-5% of total RNA

mRNA usually requires a further purification step - polyA tail

Degradation can be visualised with total RNA

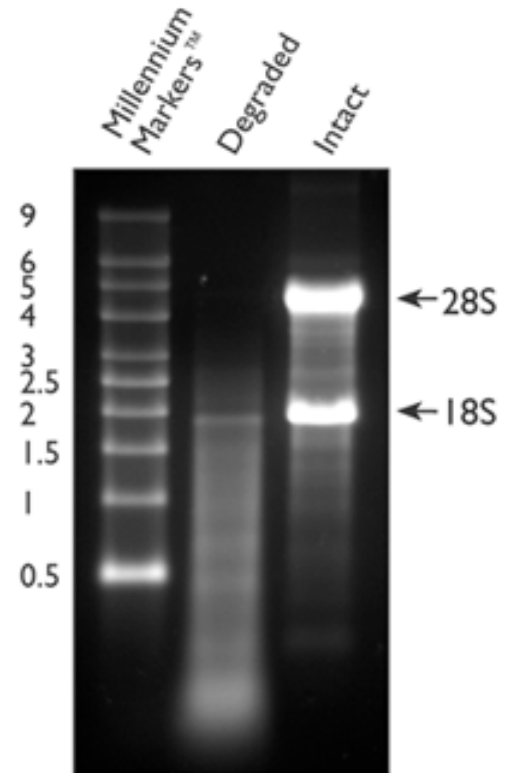

Nové technologie pro analýzu čistoty a koncentrace NK

NanoDrop® ND-1000 UV-Vis Spectrophotometer



Small samples: designed for 1 ul samples

Dynamic range: measures 2-3700 ng/ul (dsDNA) on a single sample.

Full Spectrum (220-750nm)

10 second measurement time

No cuvettes or capillaries

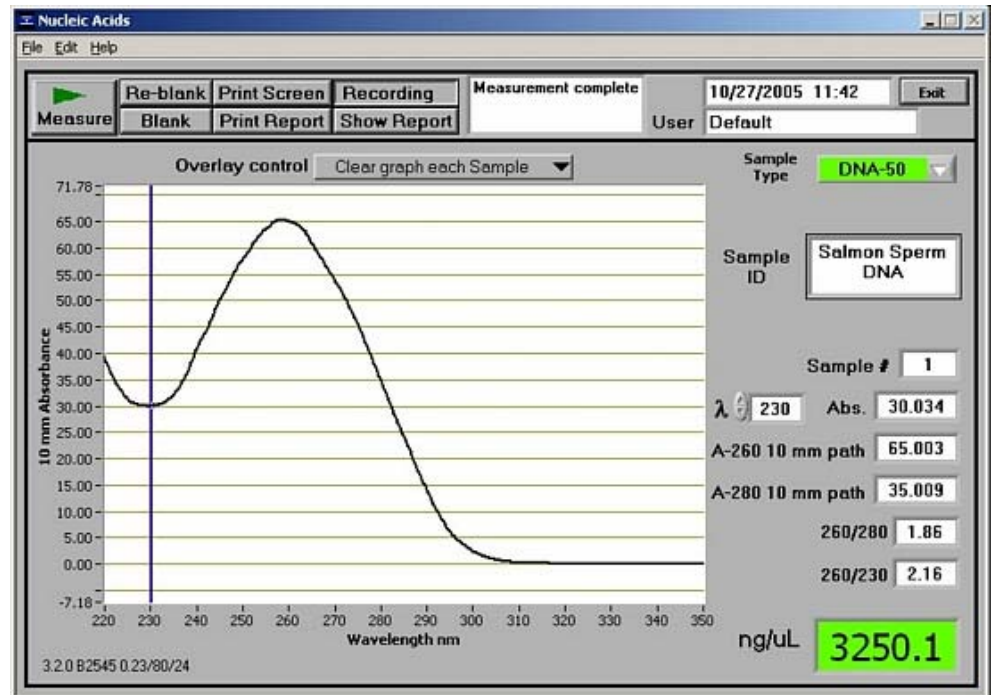

Nové technologie pro analýzu čistoty a koncentrace NK



Agilent 2100 Bioanalyzer

<http://www.chem.agilent.com/scripts/generic.asp?lPage=1565&indcol=N&prodcol=Y>

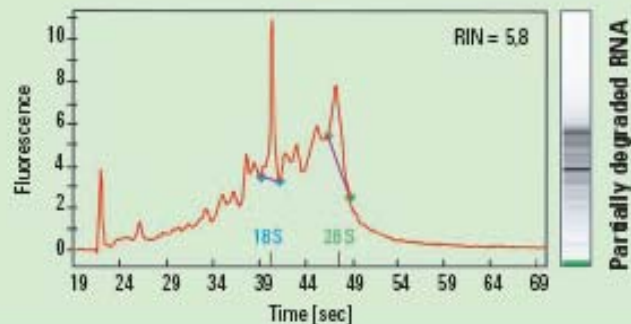
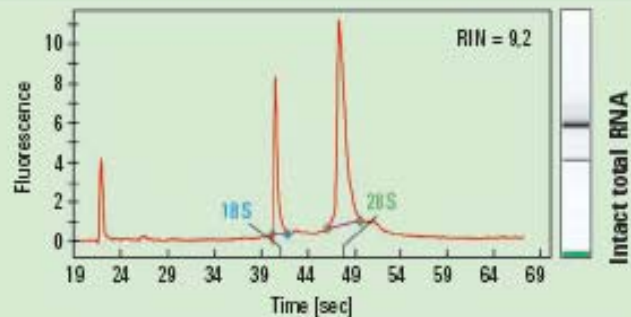

Metody analýzy RNA

❖ Northern blot analysis

- RNA extraction, isolation & size fractionation

❖ Ribonuclease protection assay

- hybridization with anti-sense RNA
- selection of desired RNA
- protection against RNase

❖ RNA-targeted Fluorescent In Situ Hybridization

- DNA strands can be separated under conditions which break H-bonds
- double-stranded molecules can be reformed in vitro
- formation of duplexes dependent on sequence complementarity
- homologous 'probes' are used to detect specific nucleic acids

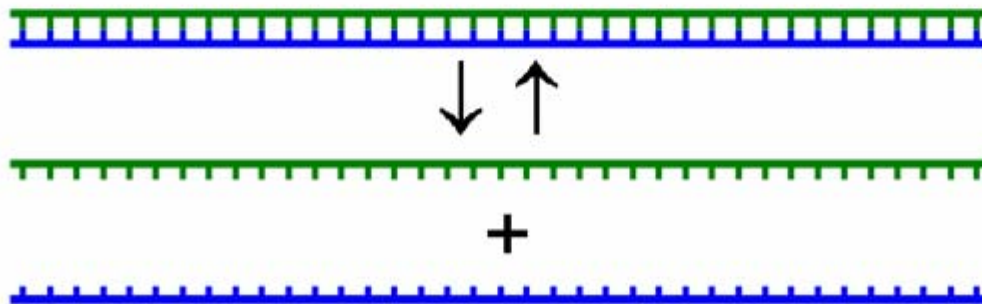

Northern and Southern Blots

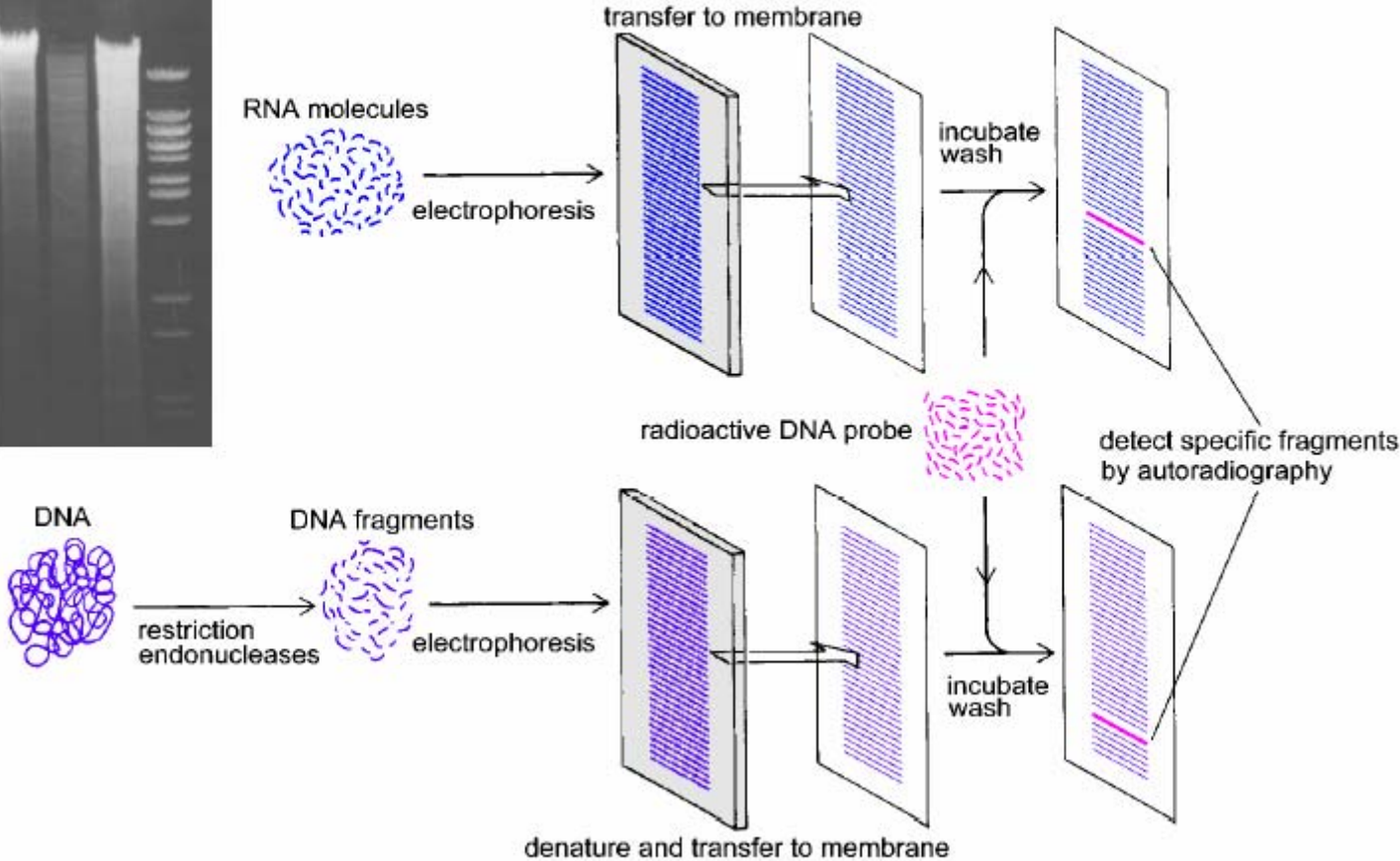
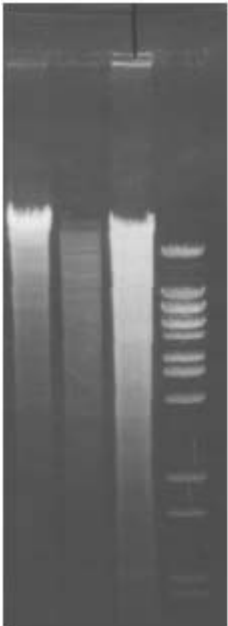

Transfer DNA/RNA to Membrane

- **Capillary Action**
 - original method
 - no special apparatus
 - efficient, but slow
- **Vacuum**
 - special apparatus
 - quick and efficient
- **Electrophoretic**
 - not widely used
- **Fix Membrane**
 - 'baking' (heat 80°)
 - UV cross-link

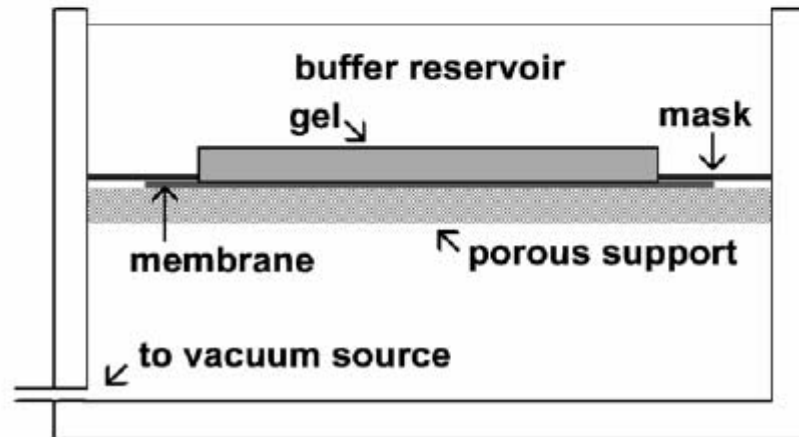
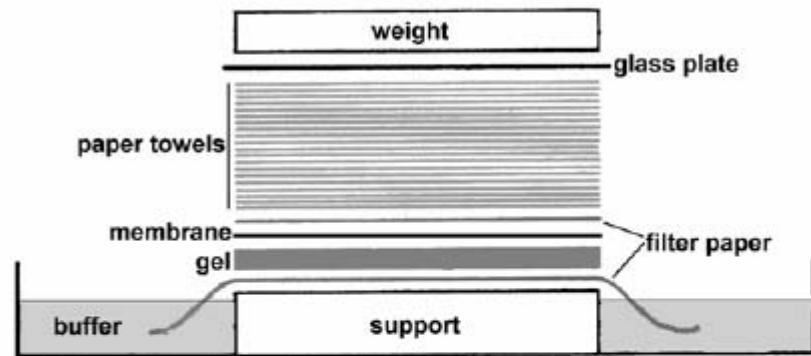

Factors Affecting Hybridization

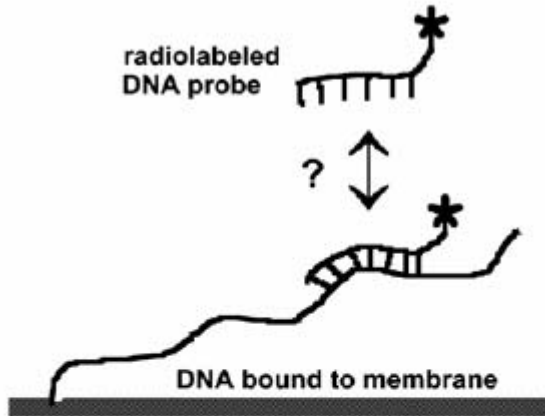

- temperature
- ionic strength
- chaotropic agents
- probe length
- probe mismatch
- % GC

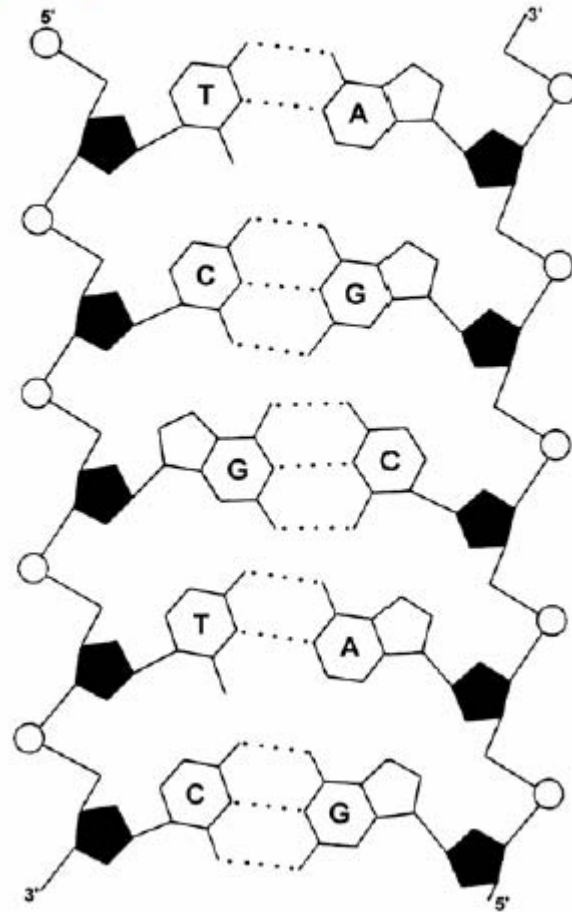



Labeling DNA Probes

- **random priming**
 - used for cloned DNA fragments
- **T4 nucleotide kinase**
 - used primarily for synthetic oligonucleotides
- **(nick translation)**
 - earlier method replaced by random priming
 - quality control and reproducibility problems
- **(terminal transferase)**
 - adds nucleotides to 3' end
 - used primarily for generation of homopolymer tails

Random priming:

Labeling principle

The method of "random primed" DNA labeling developed by Feinberg and Vogelstein (1,2) is based on the hybridization of a mixture of all possible hexanucleotides to the DNA to be labeled. All sequence combinations are represented in the hexanucleotide primer mixture, which leads to binding of primer to the template DNA in a statistic manner. Thus an equal degree of labeling along the entire length of the template DNA is guaranteed.

The complementary strand is synthesized from the 3' OH termini of the random hexanucleotide primer using Klenow enzyme, labeling grade. Modified deoxy- ribonucleoside triphosphates ([³²P]-, [³⁵S]-, [³H]-, [¹²⁵I]-digoxigenin or biotin-labeled) present in the reaction are incorporated into the newly synthesized complementary DNA strand.

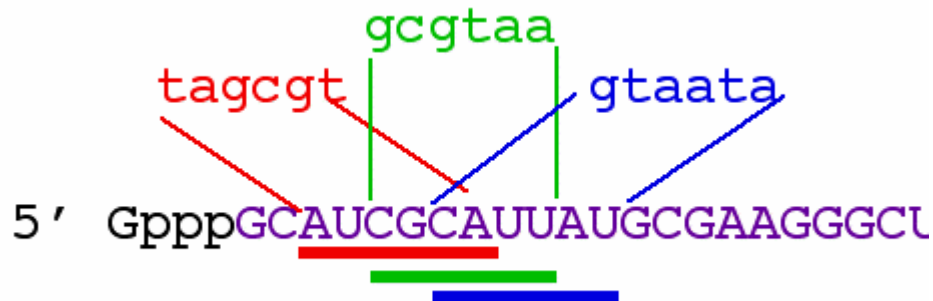

T4 nucleotide kinase:

Labeling principle

The bacteriophage T4 polynucleotide kinase catalyzes two reactions: forward and exchange. In the forward reaction, the enzyme transfers the γ phosphate of $[\gamma\text{-}^{32}\text{P}]\text{ATP}$ to the 5'-hydroxy group of a DNA molecule (oligonucleotides or nucleoside 3'-monophosphates) or RNA, previously dephosphorylated with alkaline phosphatase. In the exchange reaction, T4 polynucleotide kinase transfers the 5'-terminal phosphate group of the DNA molecule to ADP. Then, the enzyme transfers the γ phosphate of $[\gamma\text{-}^{32}\text{P}]\text{ATP}$ to the 5'-hydroxy group of a DNA molecule.

Northern Blotting

5 -10 μ g isolated RNA
260/280nm ~ 2.0
(*c.f.* DNA 1.8)

Heat in formamide to denature

Denaturing agarose gel electrophoresis
Formaldehyde 0.66M/2.2mM
Glyoxal/Methyl Mercuric Hydroxide

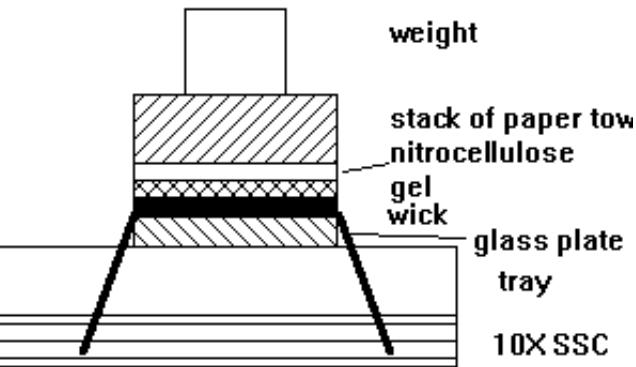

Blot/transfer the RNA
onto a membrane using
salt solution

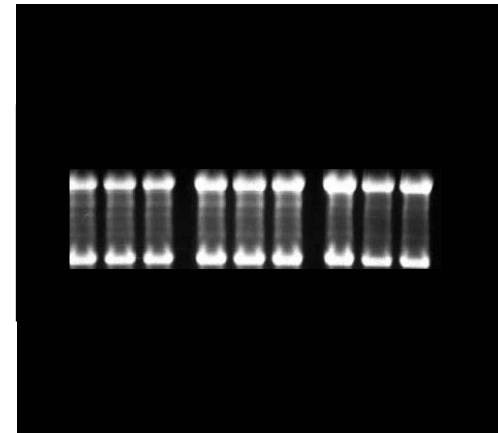

Northern Blotting

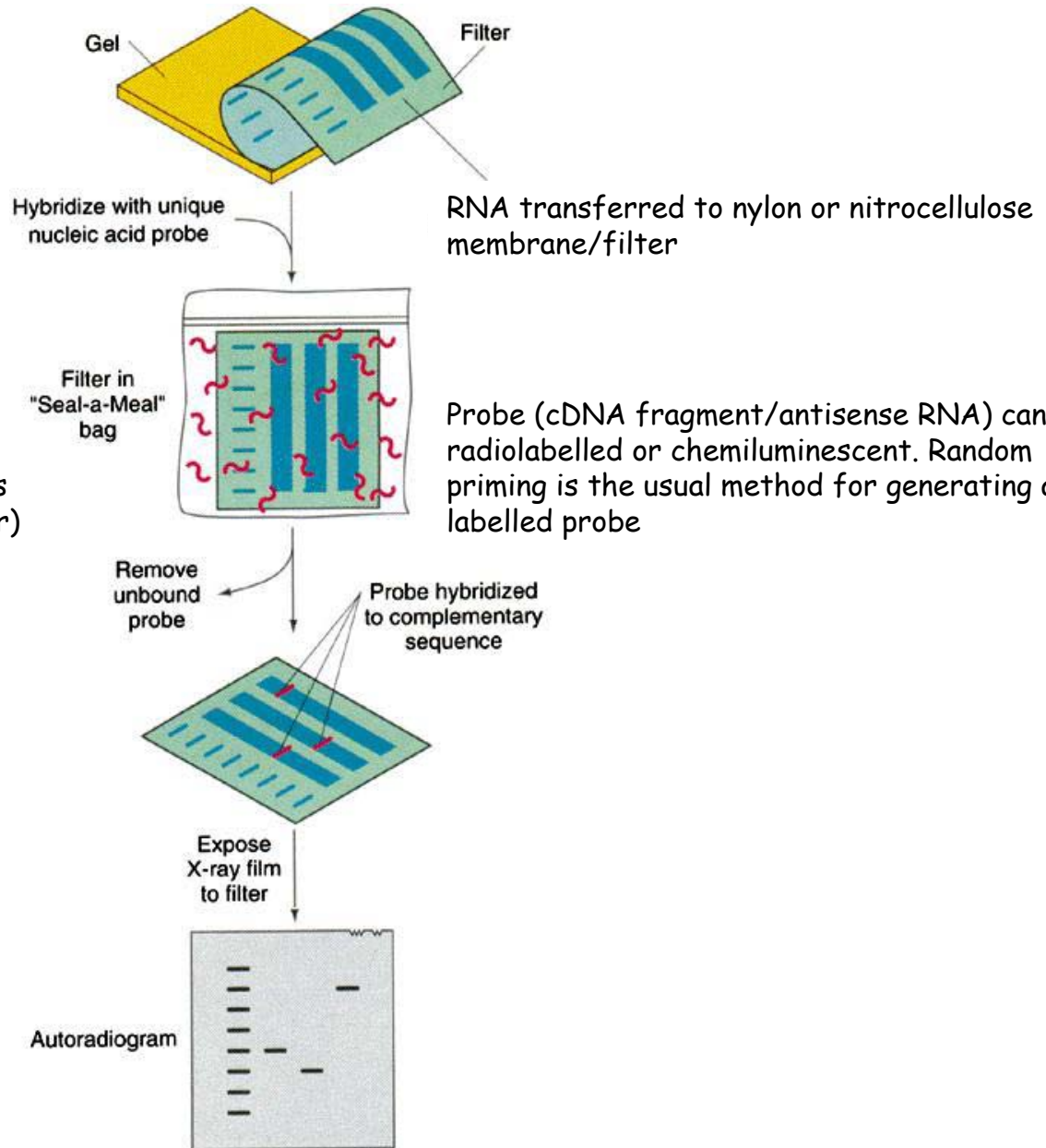

Hybridization buffer is important as is stringency of washing (Rapid Hyb ~ 1hr)

Northern Blotting

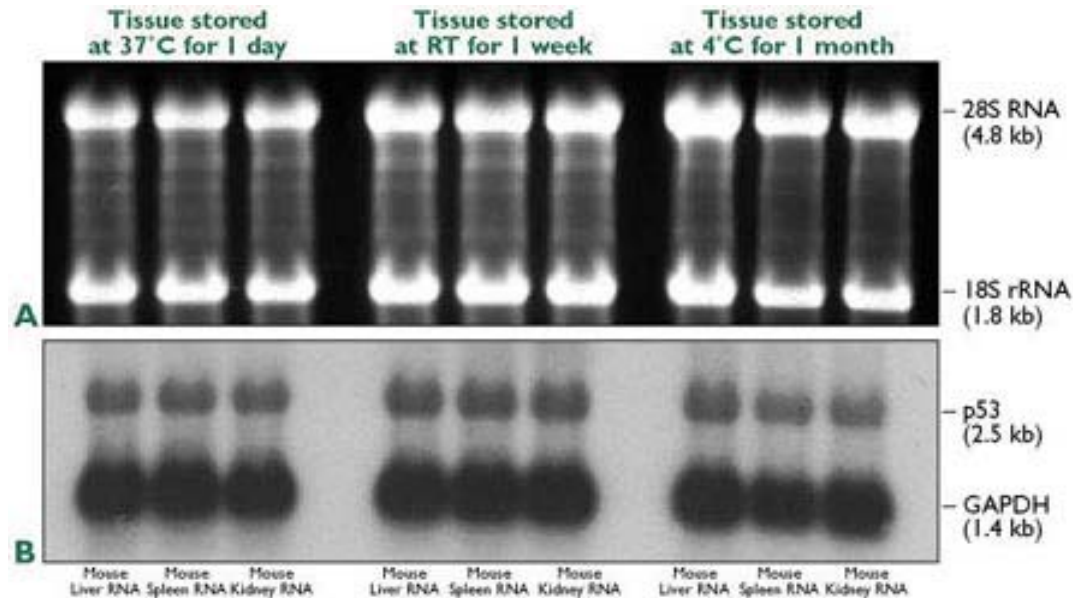

Probe can be stripped off the membrane which can be reprobbed or multi-probed.

Use a housekeeping type to probe to analyse changes
Glyceraldehyde 3' phosphate dehydrogenase (GAPDH),
 β -actin, β_2 -microglobulin

RNase protection assay

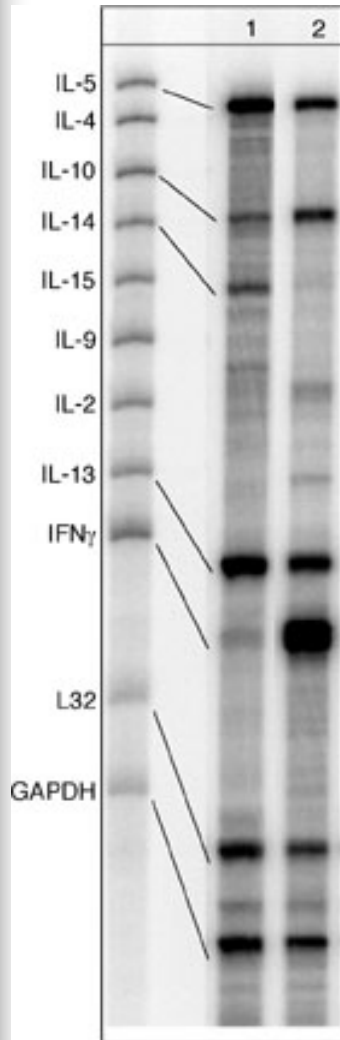

The ribonuclease protection assay (RPA) is a highly sensitive and specific method for the detection of mRNA species. The assay was made possible by the discovery and characterization of DNA-dependant RNA polymerases from the bacteriophages SP6, T7 and T3, and the elucidation of their cognate promoter sequences. These polymerases are ideal for the synthesis of high-specific-activity RNA probes from DNA templates because these polymerases exhibit a high degree of fidelity for their promoters, polymerize RNA at a very high rate, efficiently transcribe long segments. The strategy for the development of multi-probe RPA systems is to generate a series of related gene templates, each of distinct length and each representing a sequence in a distinct mRNA species. The templates are assembled into biologically relevant sets to be used by investigators for the T7 polymerase-directed synthesis of a high-specific-activity, [32 P]-labeled, antisense RNA probe set. The probe set is hybridized in excess to target RNA in solution after which free probe and other single-stranded RNA are digested with RNases. The remaining "RNase-protected" probes are purified, resolved on denaturing polyacrylamide gel, and quantified by autoradiography or phosphorimaging. The quantity of each mRNA species in the original RNA sample can then be determined based on the intensity of the appropriately-sized, protected probe fragment.

Two distinct advantages of the multi-probe RPA approach are its sensitivity and its capacity to simultaneously quantify several mRNA species, in a single sample of total RNA. This allows comparative analysis of different mRNA species within samples and, by incorporating probes for housekeeping gene transcripts, the levels of individual mRNA species can be compared between samples.

Advantages & disadvantages of RT-PCR

- ❖ RT-PCR is very sensitive because of the ability to amplify product

Northern blot 5 ~ 10mg

RNasePA 100ng-1mg

RT-PCR < 1ng (even single cells)

- ❖ Able to look at multiple mRNA simultaneously by using multiple primers

- ❖ May be too sensitive?

Applications of RT-PCR

- ❖ diagnosis of viruses
- ❖ **expression of specific genes in specific tissues**
- ❖ rRNA:rDNA ratio as an indicator of growth
 - universal activity
 - activity of specific organisms
- ❖ expression of specific mRNA as indicator of activity
 - nifH gene
 - degradation of xenobiotic compounds
- ❖ RT *in situ* PCR

Reverse transcription (RT)-PCR

Convert the RNA to cDNA using reverse transcriptase

Oligo dT



Random primers (pdN₆)



Gene-specific primer



Reverse transcription (RT)-PCR

Reverse transcriptase - AMV or MMLV

Typical RT reaction

1 μg total RNA	1 μl
500ng primer (pdN ₆)	1 μl
0.1 mM DTT	1 μl
1mM dNTPs	2 μl
1U RNase inhibitor	1 μl
Nuclease free H ₂ O	13 μl

19 μl - heat 80°C 4', snap on ice

+ 1 μl 200U MMLV - *superscript* (Invitrogen)

25°C - 10'

42°C - 50'

95°C - 2'

1-20 μl into 50 μl typical PCR

Reverse transcription (RT)-PCR

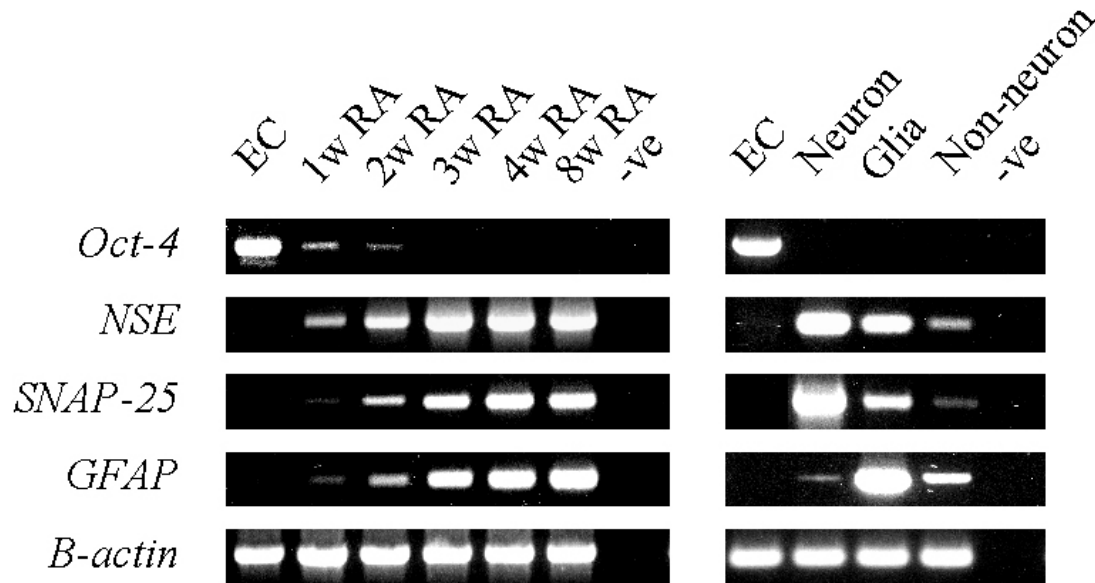

Note - the RT and PCR can be done in the same tube in a one-step reaction.



Reverse transcription (RT)-PCR

Semi-quantitative vs. quantitative

Quantitative Real-Time PCR e.g. TaqMan

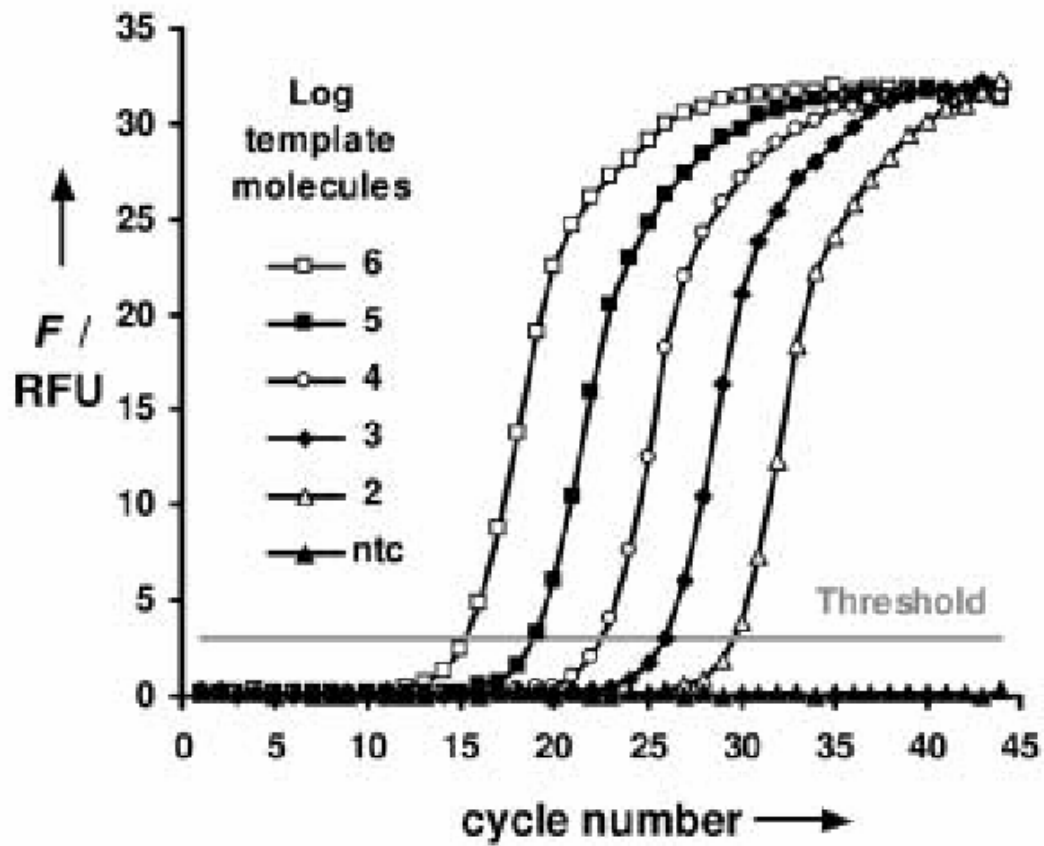

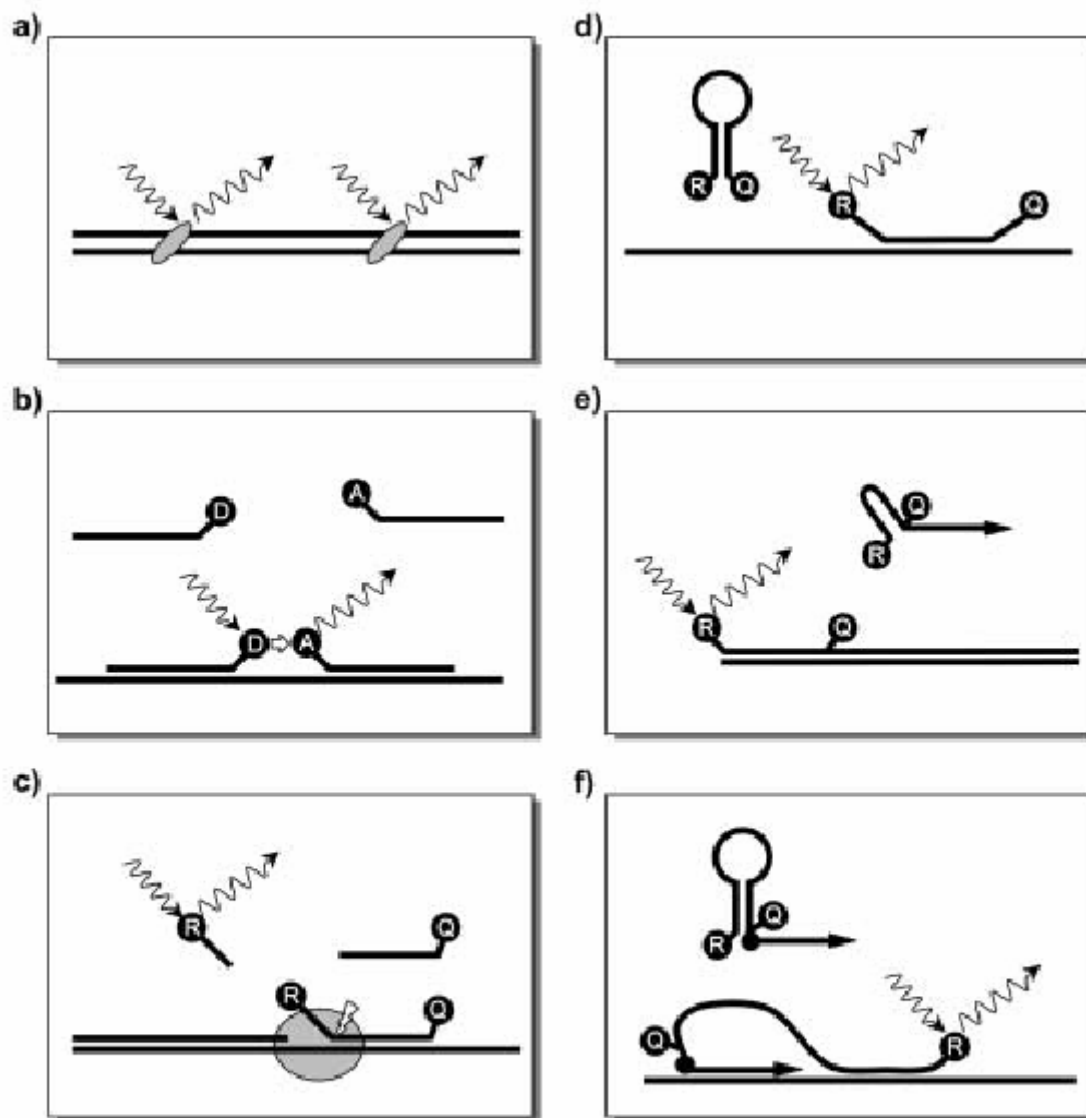
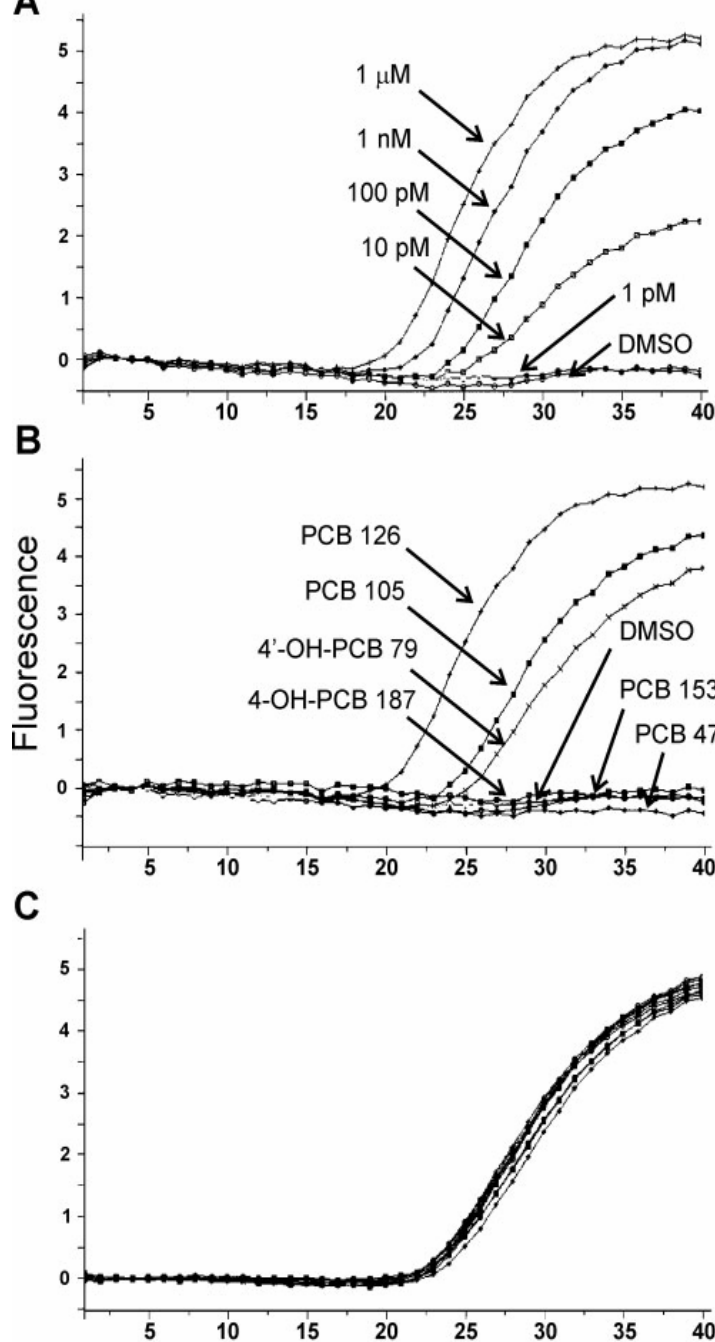
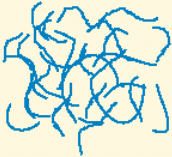

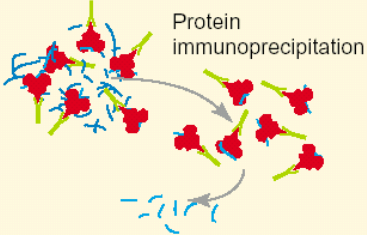

Figure 4. Detection formats commonly used for real-time PCR. For explanations, see the text; D, donor; A, acceptor; R, reporter; Q, quencher. a) SYBR Green I; b) hybridisation probes; c) TaqMan probes. The grey circle indicates the Taq polymerase hydrolysing the TaqMan probe; d) molecular beacon; e) Sunrise primer; f) Scorpion primer.

Příklad: Kvatifikace CYP1A1 mRNA v buňkách ovlivněných PCB



Induction of cytochrome p450 (CYP) 1A1 mRNA by PCBs in WB-F344 cells. (A) PCB 126 induced CYP1A1 mRNA expression in WB-F344 cells in a dose-dependent manner. Cells were treated with the indicated concentrations of PCB 126 or DMSO as a solvent control for 24 h. Total RNA was isolated and quantitative real-time RT-PCR was performed as described in the Materials and Methods. One representative experiment is shown out of three independent experiments. (B) Induction of CYP1A1 mRNA expression following the 24-h treatment of WB-F344 cells with PCBs (1 mM). (C) Expression of the reference gene porphobilinogen deaminase in samples analyzed in parts A and B.

Substrate	 DNA	 mRNA	 Protein immunoprecipitation Protein-bound DNA or RNA
	Sample labeling		
Hybridization to microarray of probe sets for	Transcribed and/or untranscribed DNA	RNA	DNA or RNA
Readout	DNA copy number at thousands of sites across the genome	Detection and quantification of thousands of RNA Pol I generated transcripts	Binding sites for DNA binding proteins or protein bound RNA
Interpretations	<ul style="list-style-type: none"> • Aneuploidy • Gene amplification • Replication dynamics • Polymorphism detection • Recombination break point map 	<ul style="list-style-type: none"> • Spatial gene expression patterns • Temporal gene expression patterns • Transcriptional network construction 	<u>ChIP</u> <ul style="list-style-type: none"> • Transcriptional network construction • Binding sites for proteins involved in genome maintenance and replication <u>RNA binding protein immunoprecipitation</u> <ul style="list-style-type: none"> • RNA binding protein targets

TRENDS in Cell Biology

Current applications for DNA microarrays. Classical microarray experiments use isolated genomic DNA or mRNA from a whole organism or tissue. The DNA or mRNA is transformed and amplified into fluorescently labeled cDNA or cRNA, respectively, which is then hybridized to microarrays. These types of experiment have been used to identify changes in DNA copy number and mRNA expression patterns. Recent innovations in microarray approaches have used an additional purification step by protein immunoprecipitation to identify DNA (chromatin immunoprecipitation or ChIP) or mRNA-binding proteins. Protein bound to DNA or mRNA is first crosslinked and then immunoprecipitated by an antibody to a specific protein of interest. Crosslinks are then reversed, which releases the co-purified DNA or mRNA for amplification, labeling and hybridization to microarrays. These procedures have been successful in determining the targets of transcription factors, as well as genomic DNA-binding and mRNA-binding proteins.

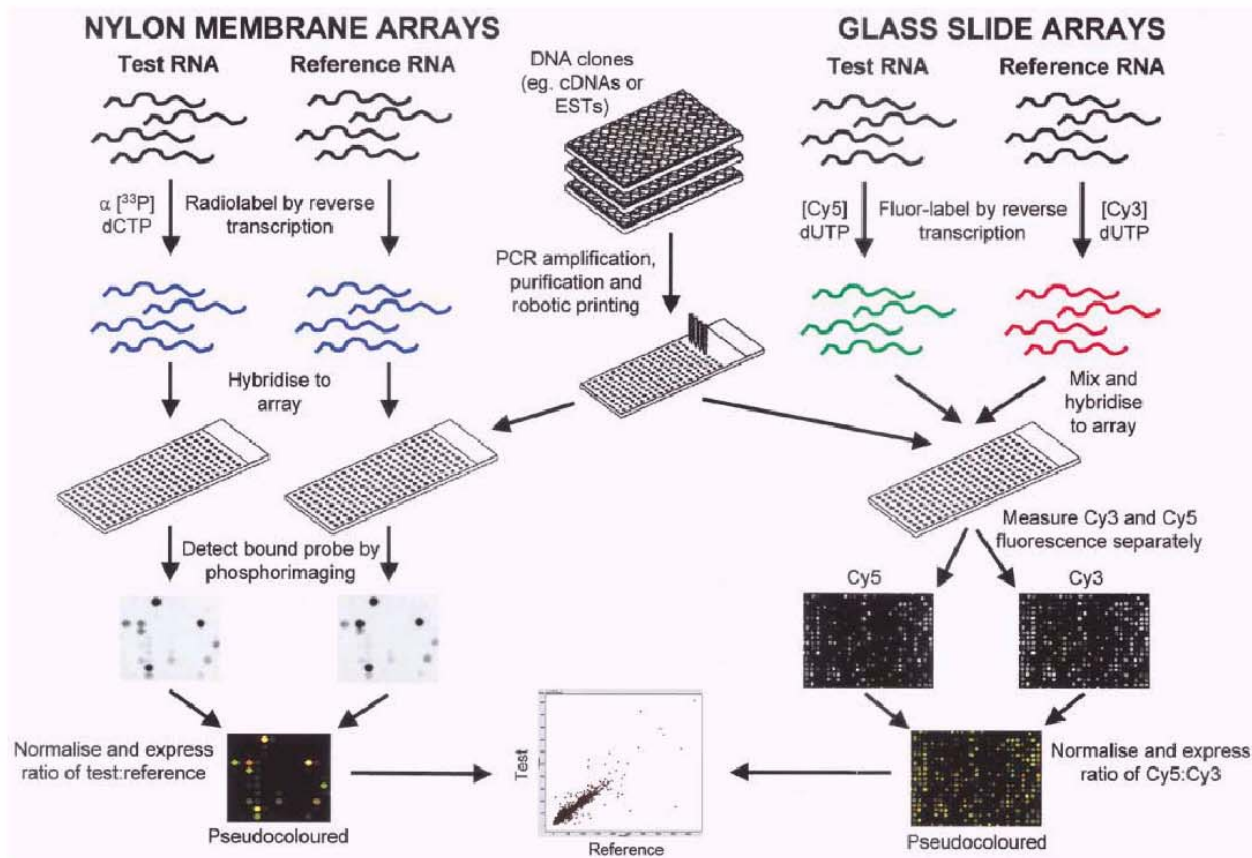

Microarray experiment. Plasmid clones are propagated in bacteria, and the cloned inserts are amplified by PCR and then purified. The purified PCR products are then robotically printed onto glass or nylon solid supports. Modifications of this approach include the use of oligonucleotides instead of PCR products or the *in situ* synthesis of oligonucleotides directly onto the glass support using photolithographic or other techniques. Separate nylon based arrays are hybridised with ^{32}P -radiolabeled cDNA prepared from the test and reference sample, whereas glass slide arrays are hybridised simultaneously with Cy5 and Cy3 fluorescently labeled test and reference samples, respectively. Following stringency washes, hybridisation to nylon arrays is detected by phosphorimaging. Hybridisation to glass slides is detected by excitation of the two fluors at the relevant wavelength and the fluorescent emission collected with a charge-coupled device. The test and reference images are overlaid using specialist software and can be displayed in a number of ways, including as a scatter plot of the ratio of test:reference gene expression.

„Disease-specific expressen genen“

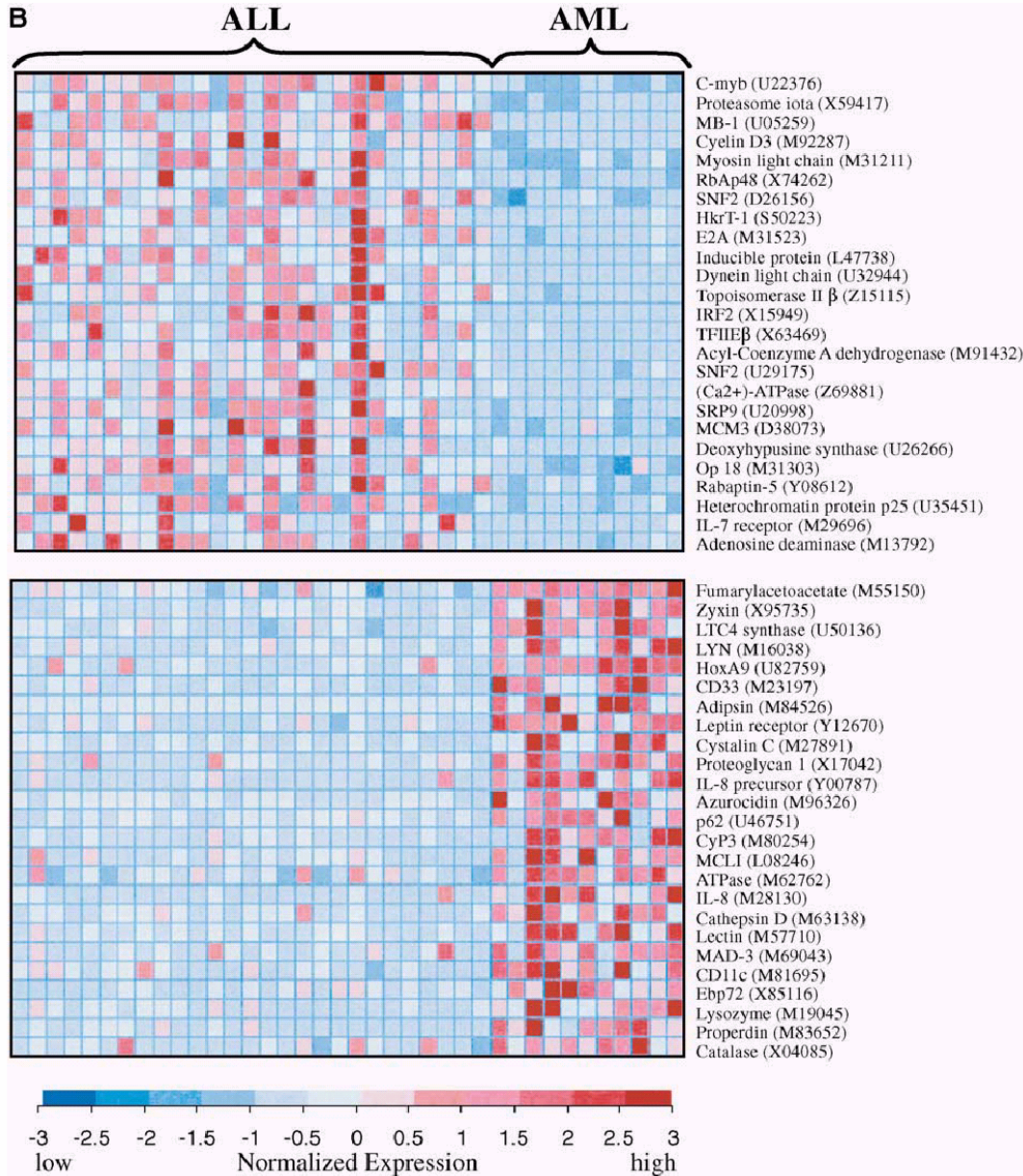

T.R. Golub et al.,
Molecular classification of cancer: class discovery and class prediction by gene expression monitoring,
Science 286 (1999) 531-537.