

# Fauna obratlovců ČR a SR

## Mammalia - Savci

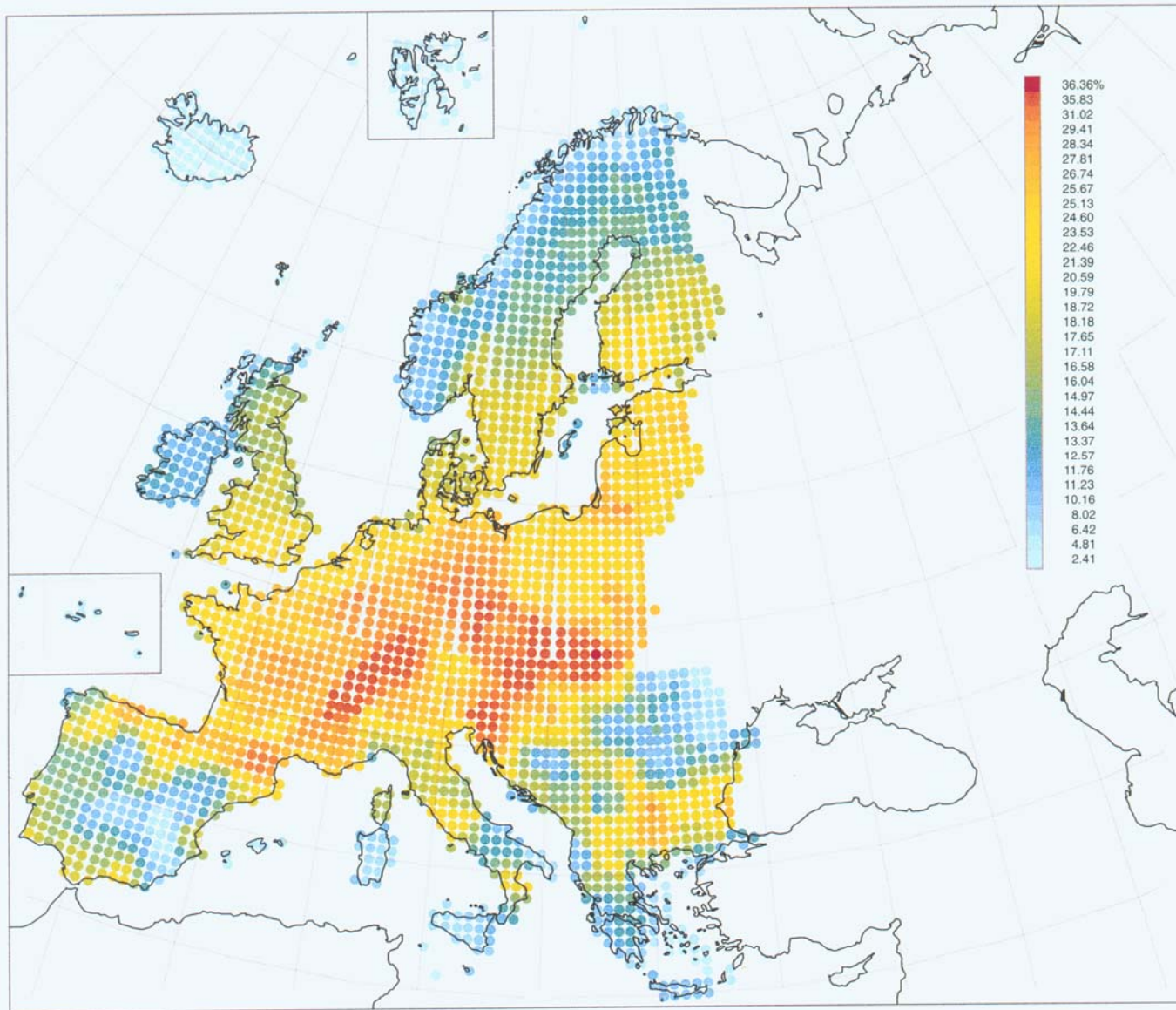
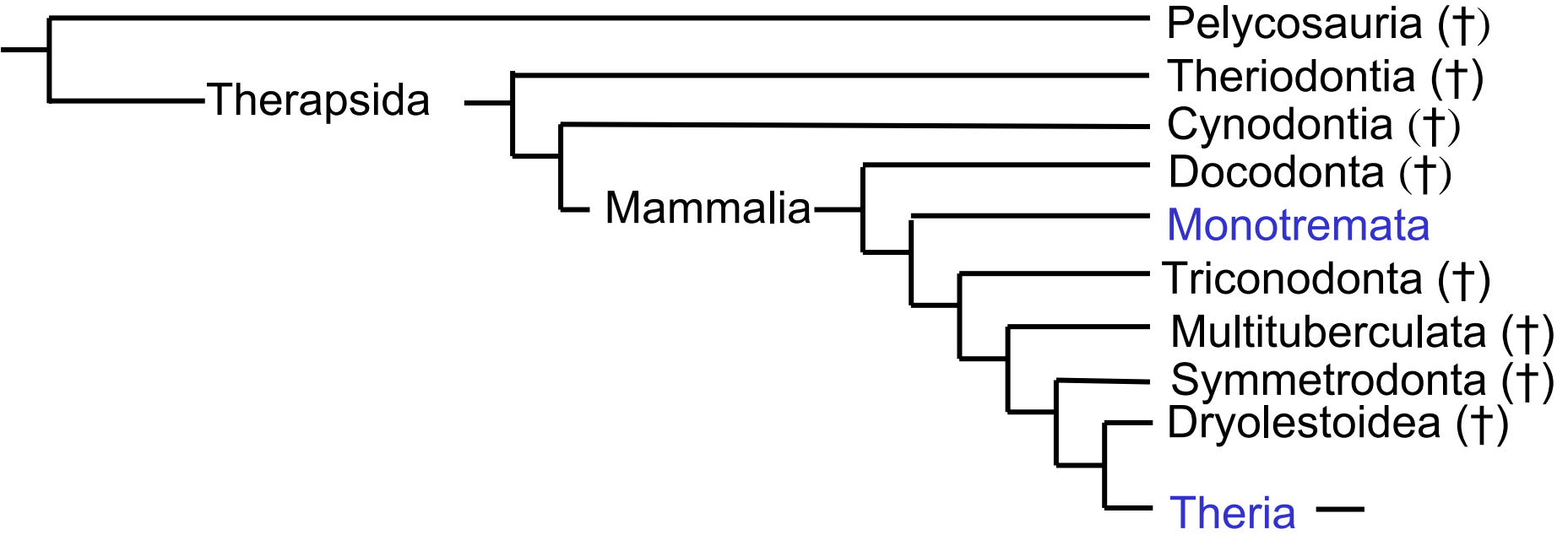
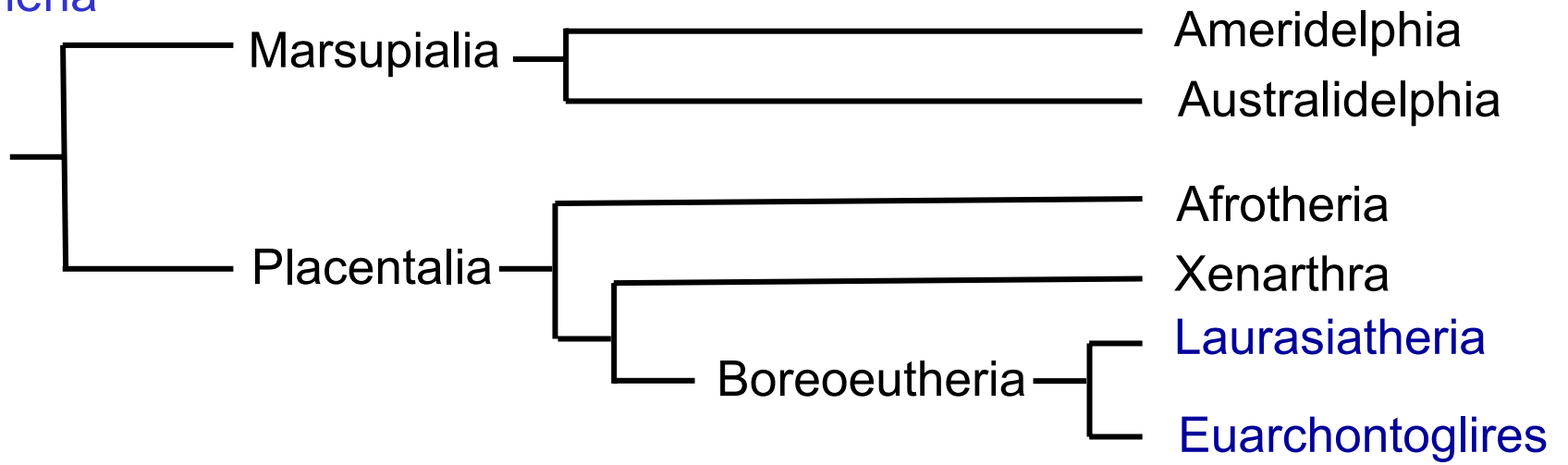

Figure 1 Species richness of mammals across Europe. This illustrative map was prepared using Worldmap software and shows species richness (number of species per grid square) with one level of smoothing. The entire atlas dataset has been used, including introduced species. There are some differences between the *Atlas Flora Europaea* UTM grid used by this software and the one used in the Atlas, particularly around the south-eastern borders of Europe and also in the treatment of some island groups.

# Synapsida



# Theria



## Laurasiatheria

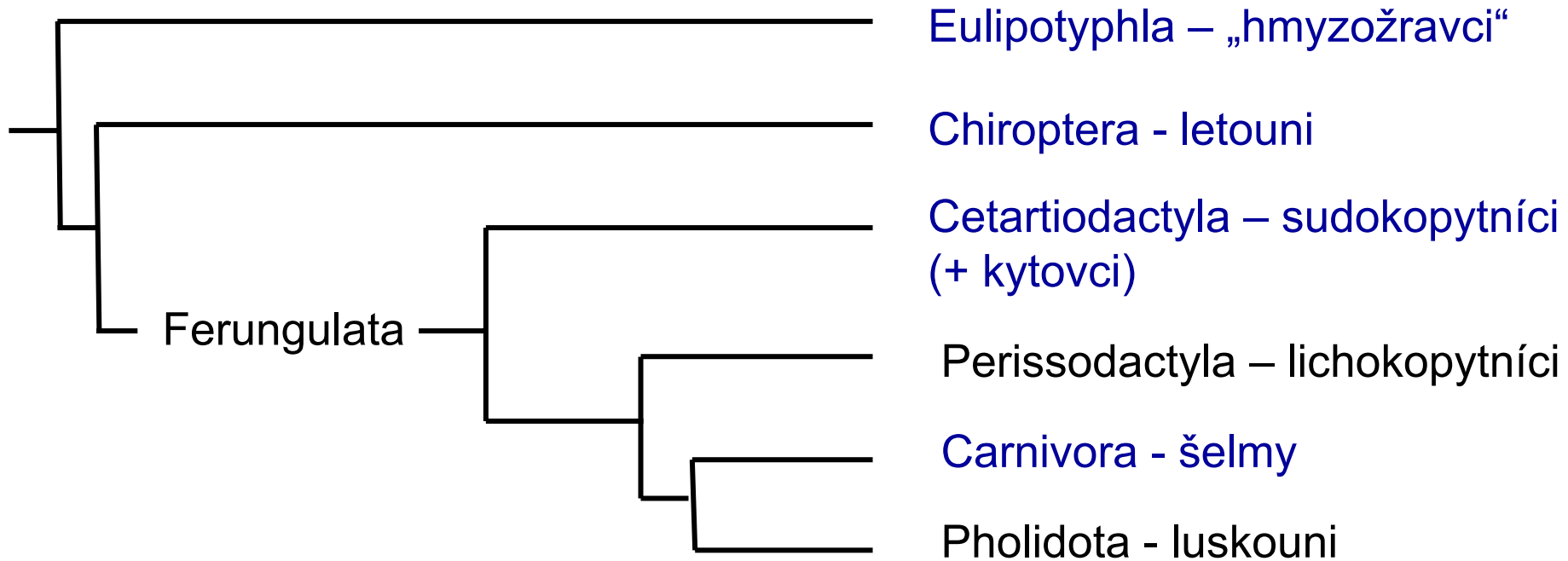

## Euarchontoglires

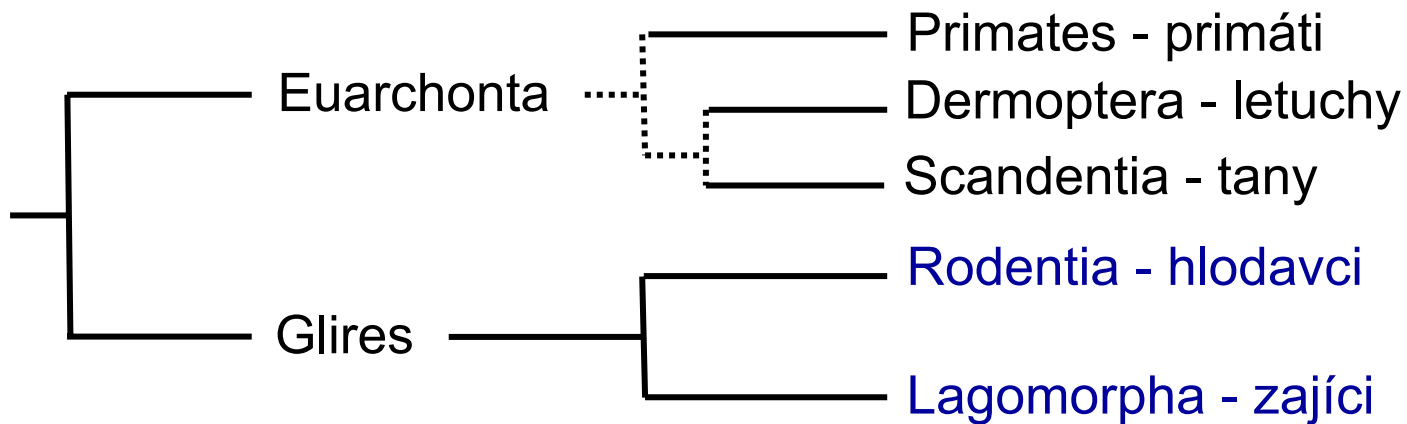

# Eulipotyphla – „hmyzožravci“

## Erinaceidae - ježkovití

*Erinaceus europaeus* Linnaeus, 1758 - ježek západní

*Erinaceus concolor* Martin, 1837 - ježek východní

## Soricidae - rejskovití

*Sorex araneus* Linnaeus, 1758 - rejsek obecný

*Sorex minutus* Linnaeus, 1766 - rejsek malý

*Sorex alpinus* Schinz, 1837 - rejsek horský

*Neomys fodiens* (Pennat, 17771) - rejsec vodní

*Neomys anomalus* Cabrera, 1907 - rejsec černý

*Crocidura suaveolens* (Pallas, 1811) - bělozubka šedá

*Crocidura leucodon* (Hermann, 1780) - bělozubka bělobřichá

*Crocidura russula* (Hermann, 1780) - bělozubka tmavá

## Talpidae - krtkovití

*Talpa europaea* Linnaeus, 1758 - krtek obecný

*Erinaceus europaeus* Linnaeus, 1758

- ježek západní

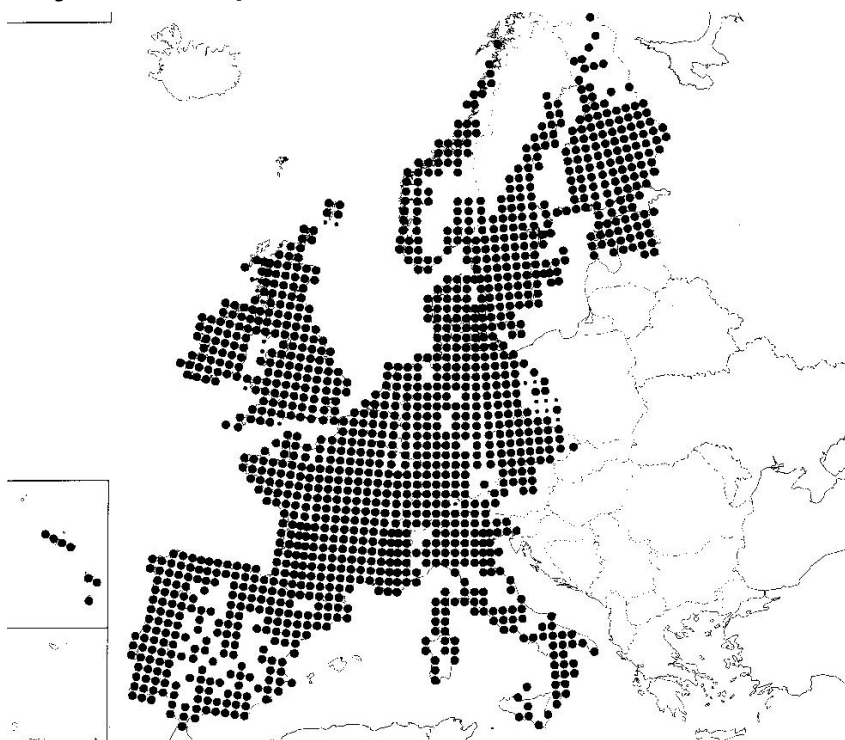

*Erinaceus europaeus*

*Erinaceus concolor* Martin, 1837

- ježek východní

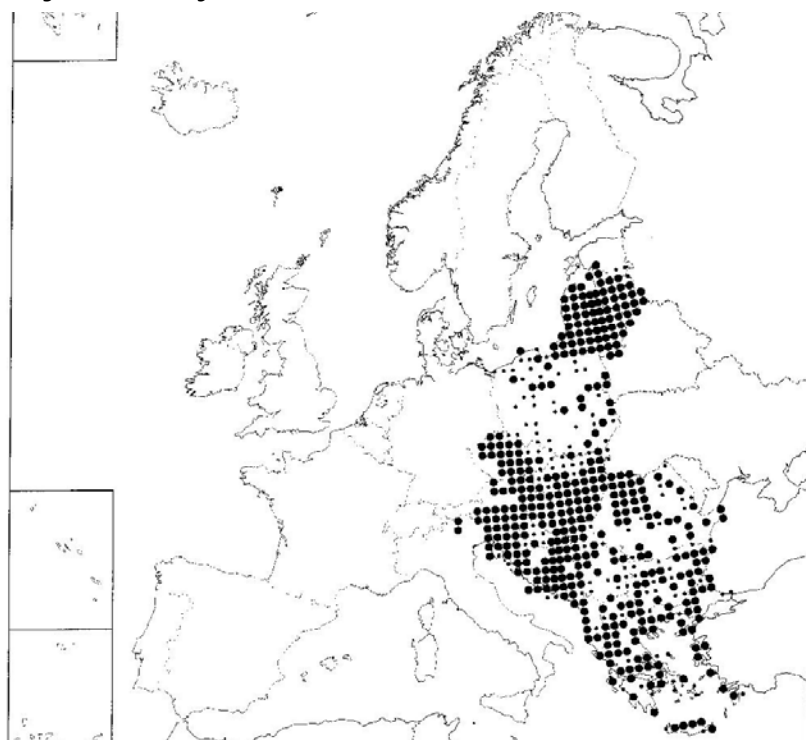

© Miloš Anděra



© -josef hlasek  
www.hlasek.com  
*Erinaceus europaeus* 4043



*Erinaceus europaeus*

- ježek západní

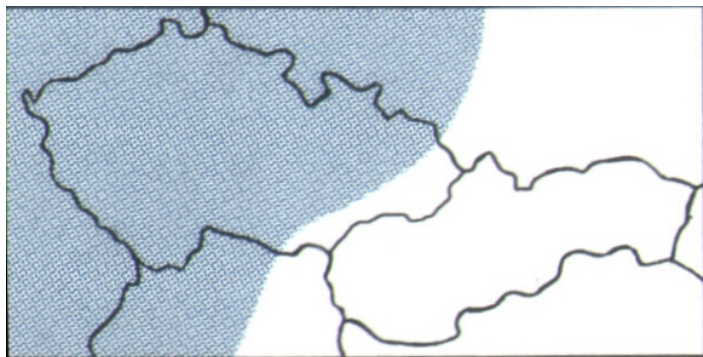

*Erinaceus concolor*

- ježek východní

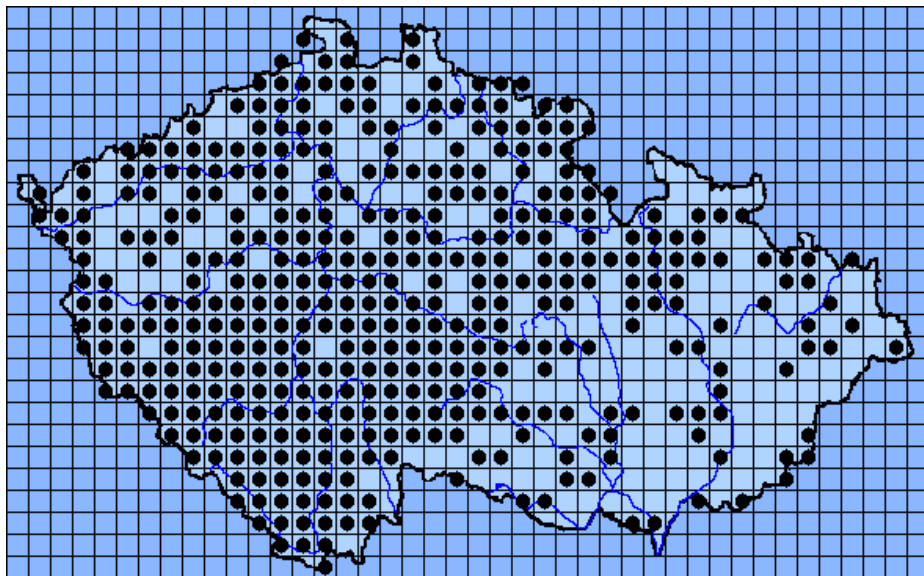
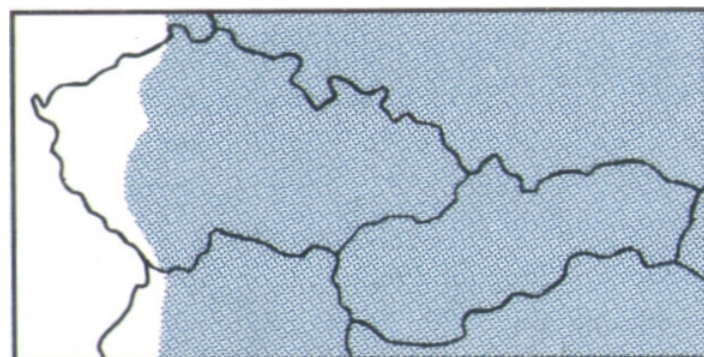

-, -, -

65%

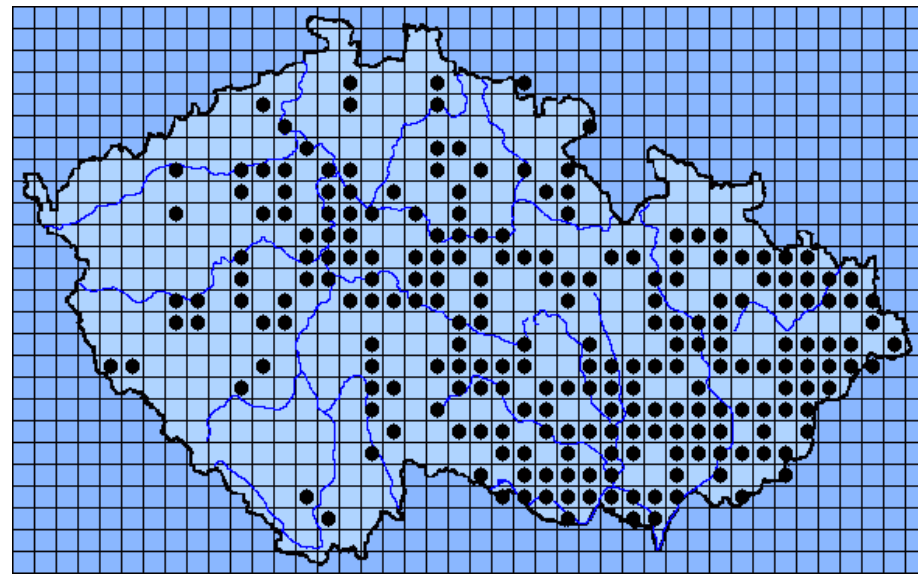

-, -, -

37%

*Sorex araneus* Linnaeus, 1758  
- rejsek obecný

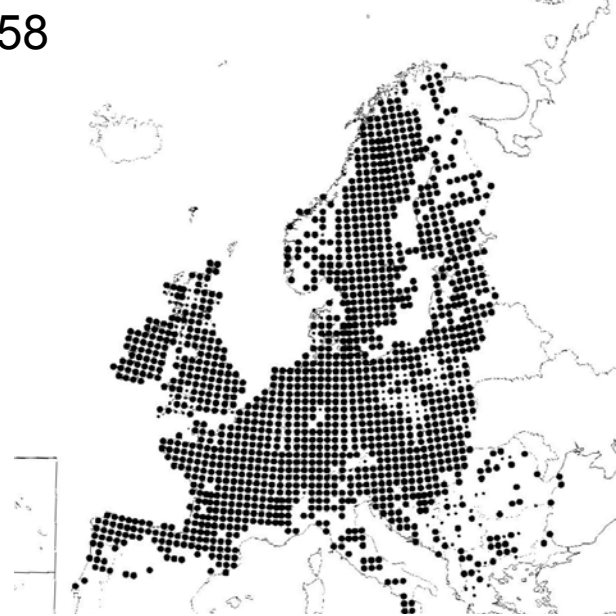
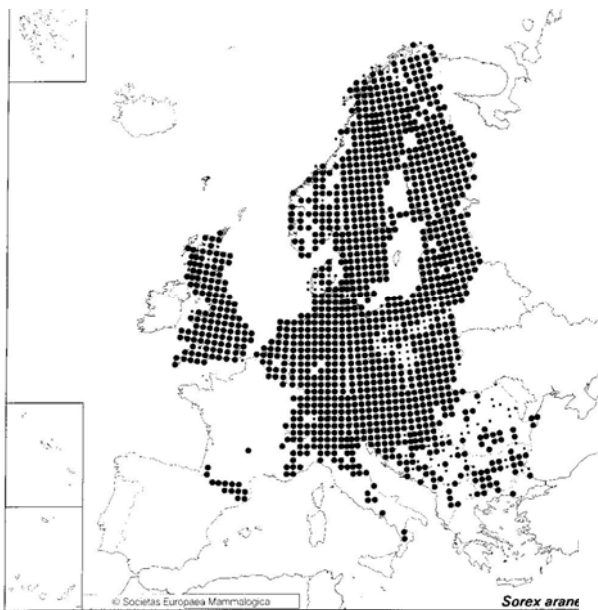

*Sorex minutus* Linnaeus, 1766  
- rejsek malý

*Sorex alpinus* Schinz, 1837  
- rejsek horský

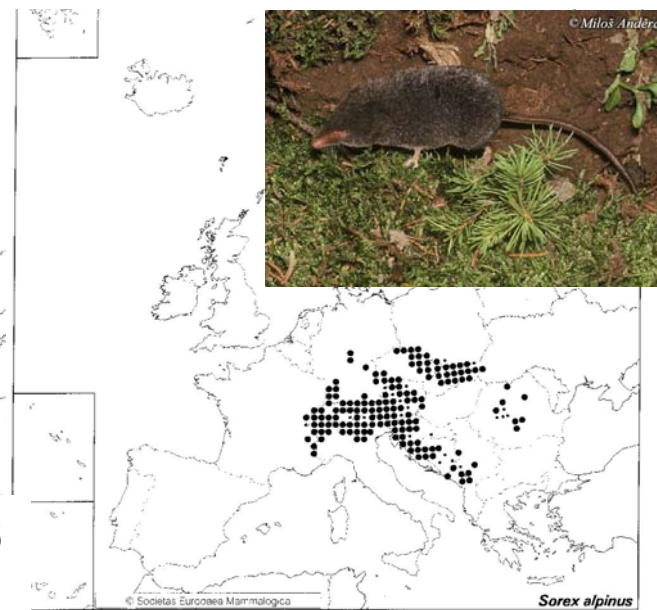

-, -, -

-, -, -

VU, -, SO



*Sorex araneus*  
- rejsek obecný

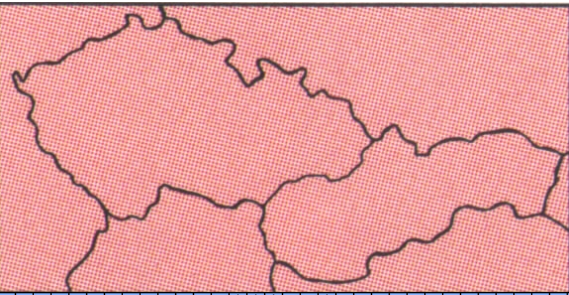

*Sorex minutus*  
- rejsek malý

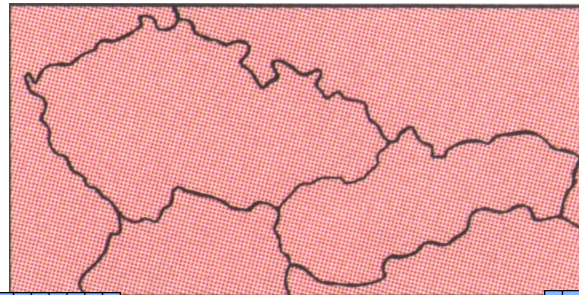

*Sorex alpinus*  
- rejsek horský

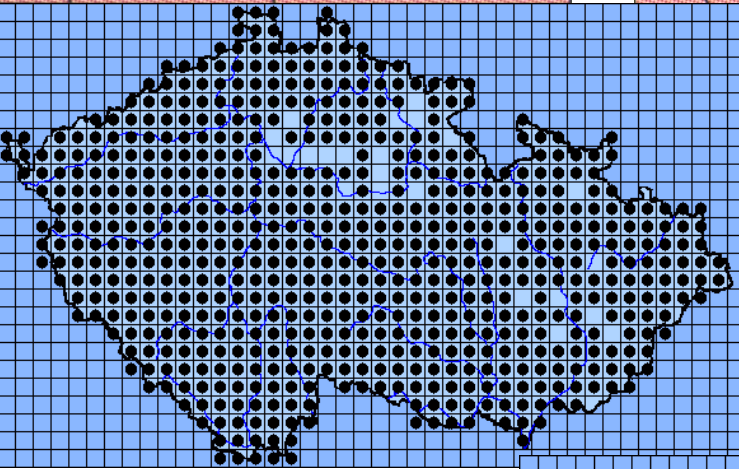
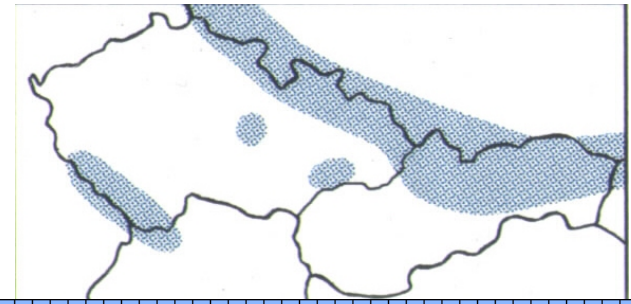

99%

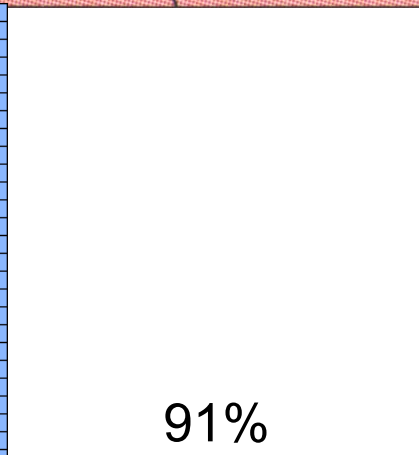

91%

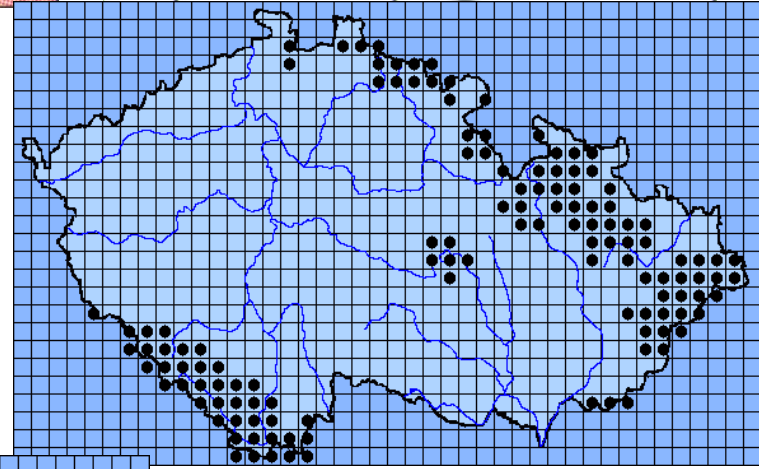

21%

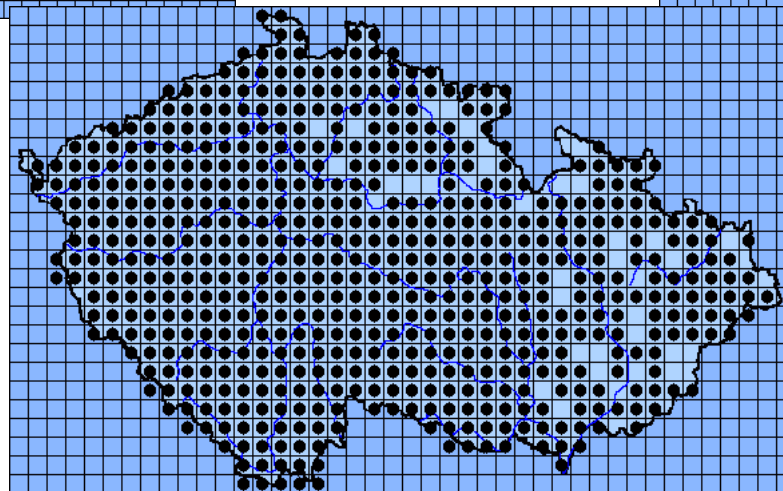

*Neomys fodiens* (Pennat, 17771) -  
rejsec vodní

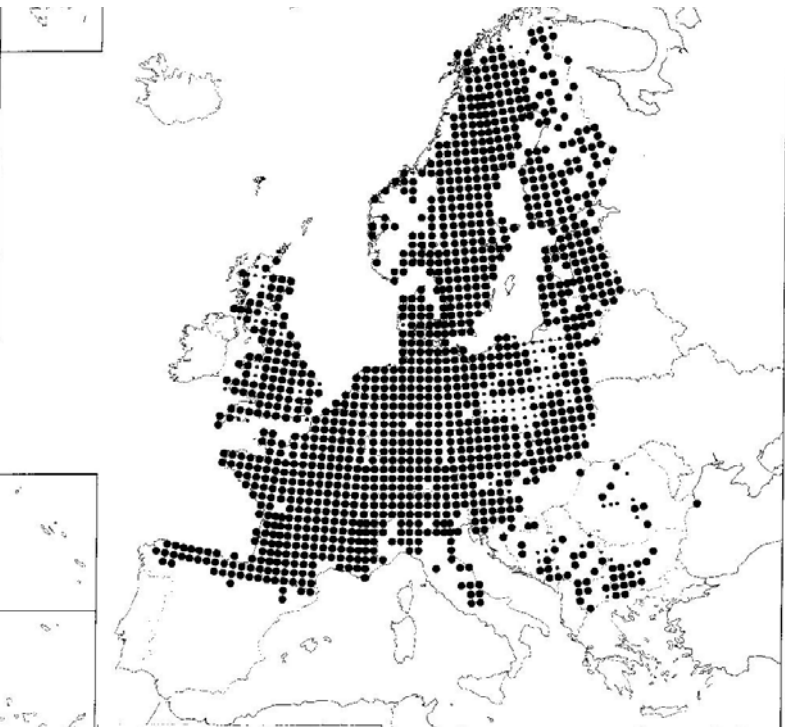

*Neomys anomalus* Cabrera, 1907 -  
rejsec černý

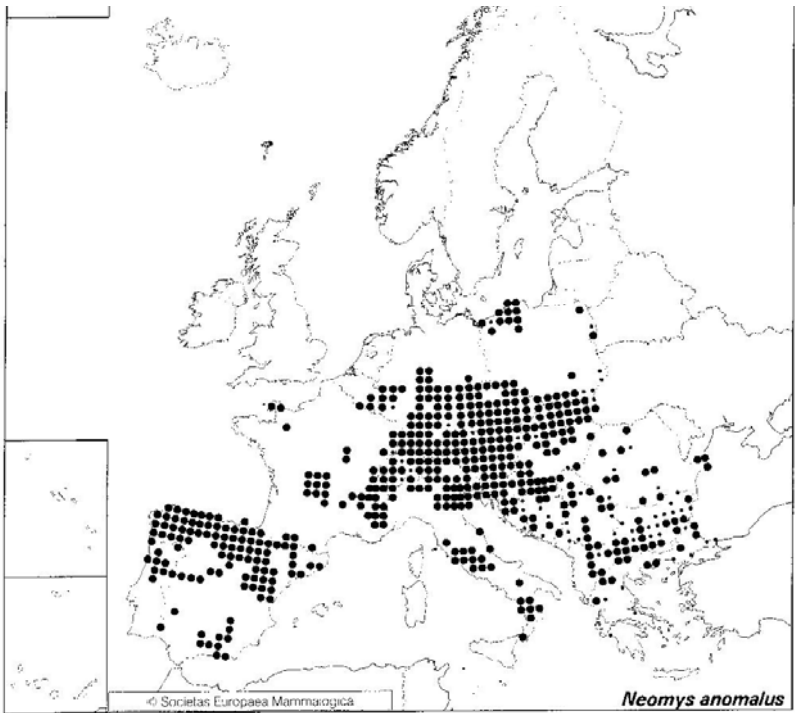

-, -, -



-, -, -

*Neomys fodiens* - rejsec vodní

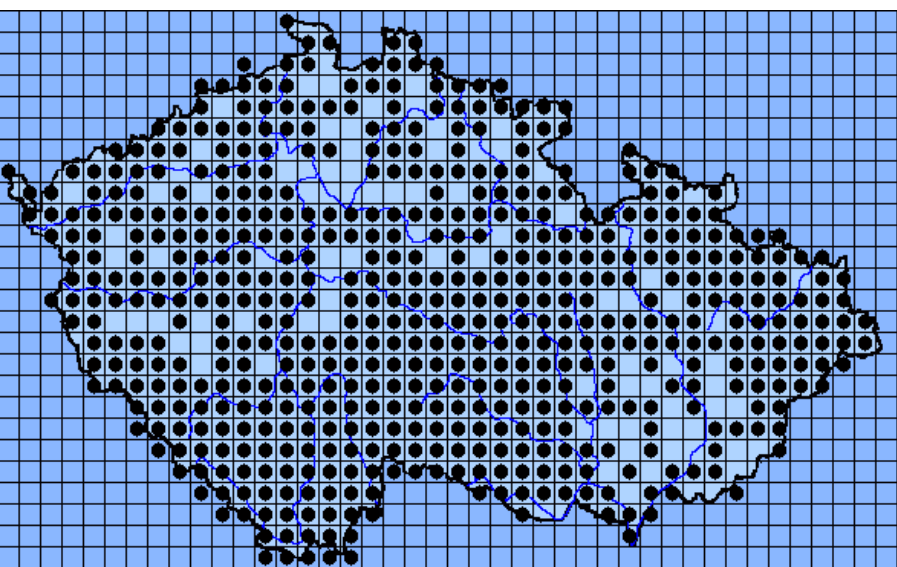
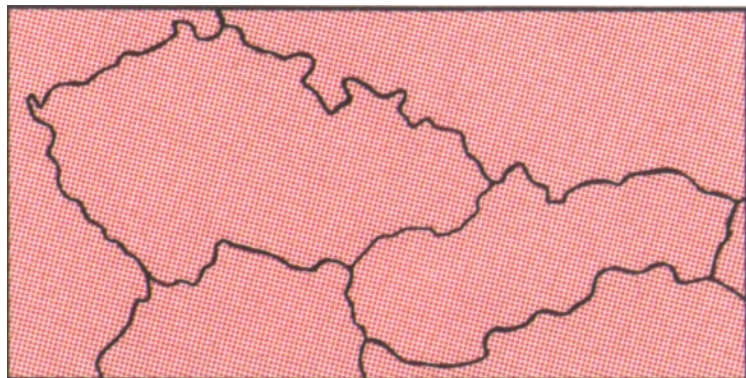

87%

*Neomys anomalus* - rejsec černý

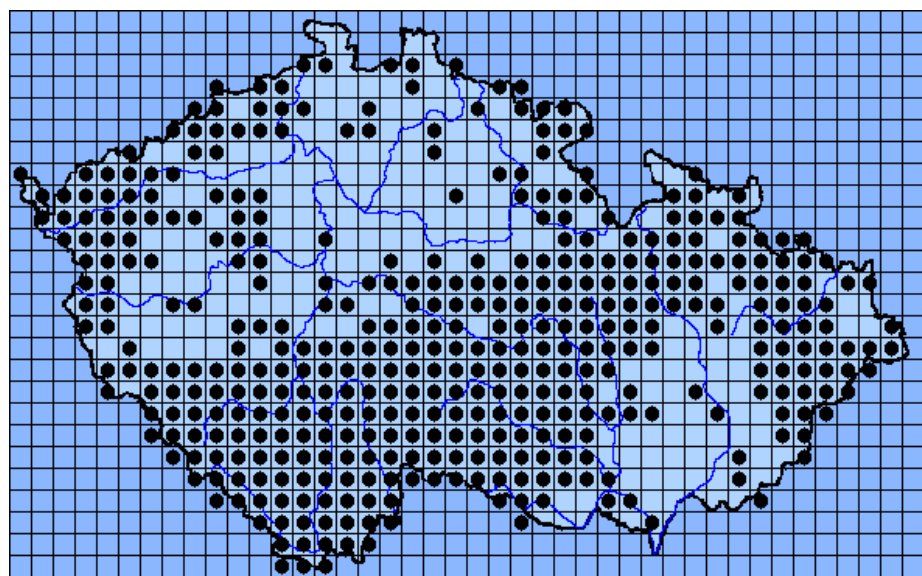
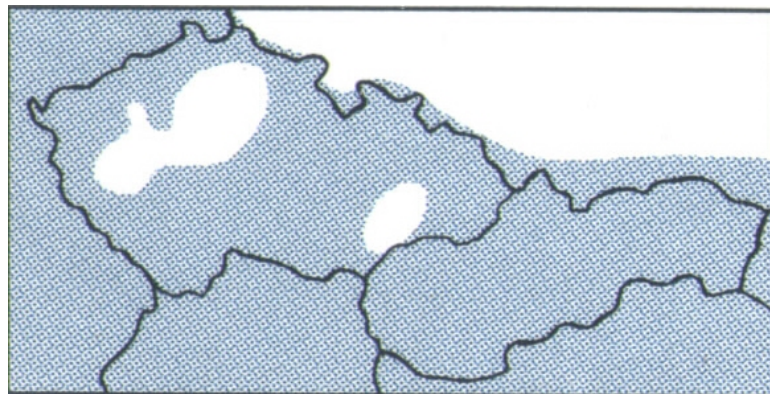

66%

*Crocidura leucodon* (Hermann, 1780)  
- bělozubka bělobřichá

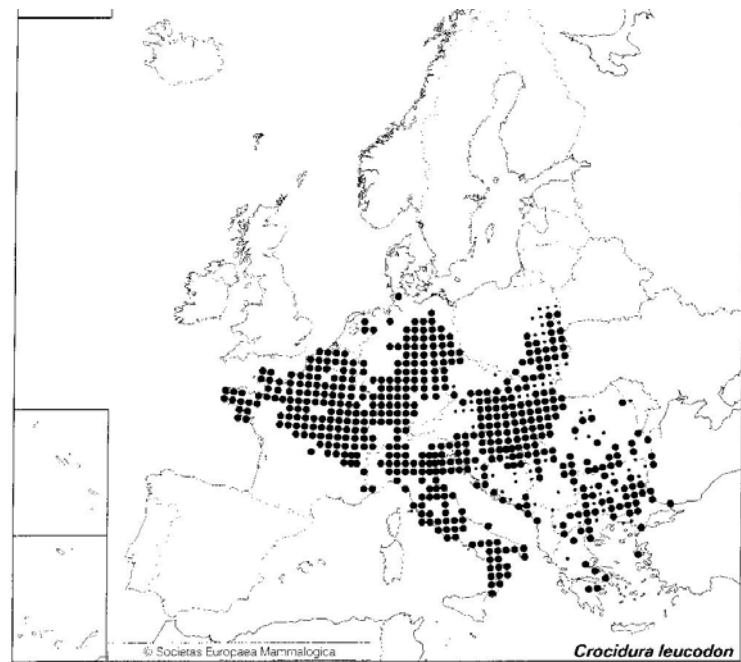

*Crocidura suaveolens* (Pallas, 1811)  
- bělozubka šedá

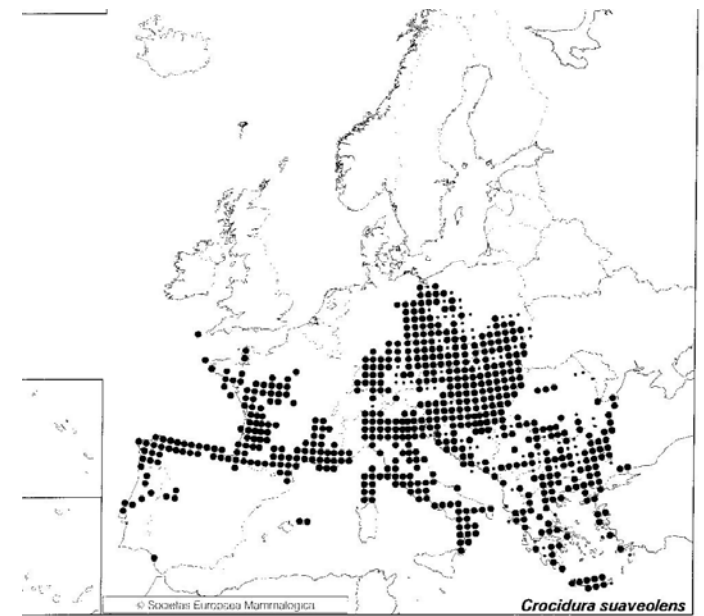

-, -, O



-, -, -

*Crocidura leucodon*  
- bělozubka bělobřichá

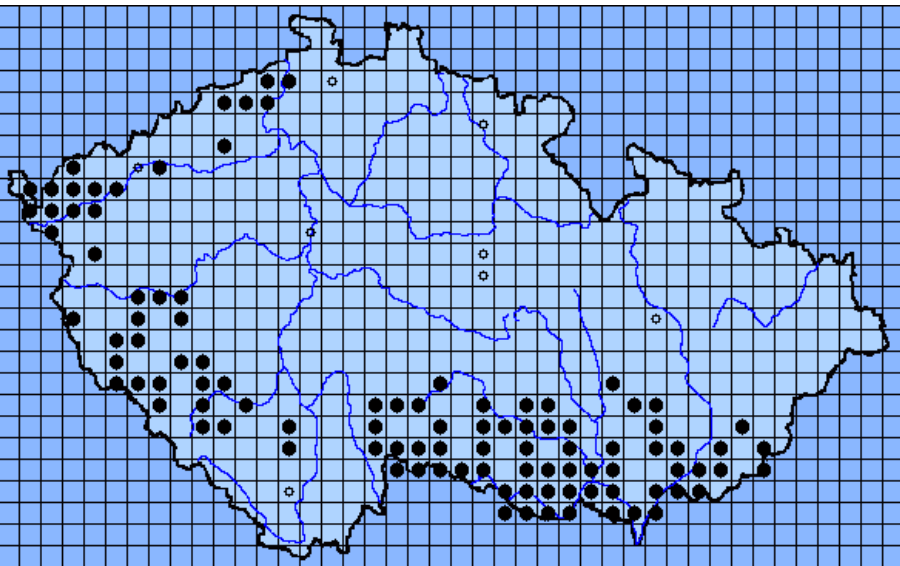

17%

*Crocidura suaveolens*  
- bělozubka šedá

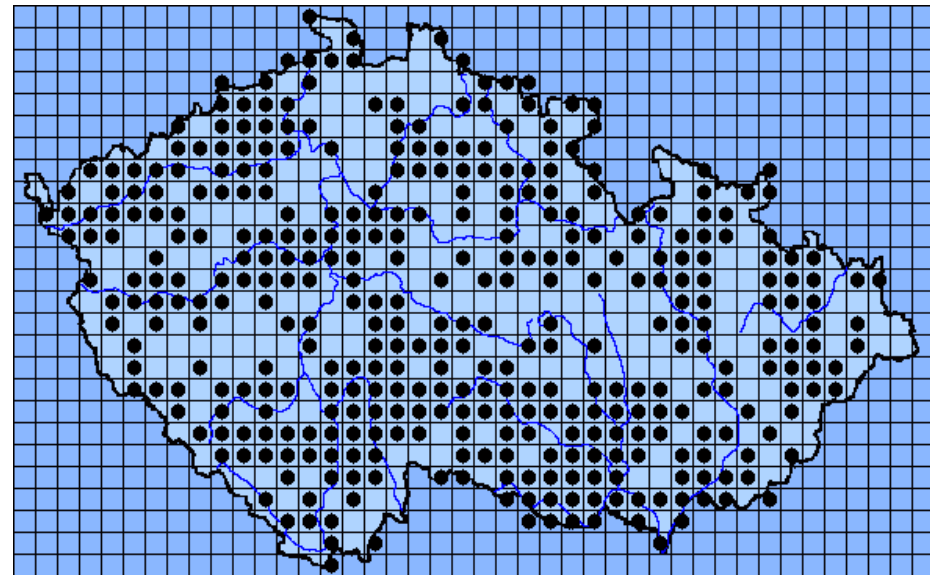
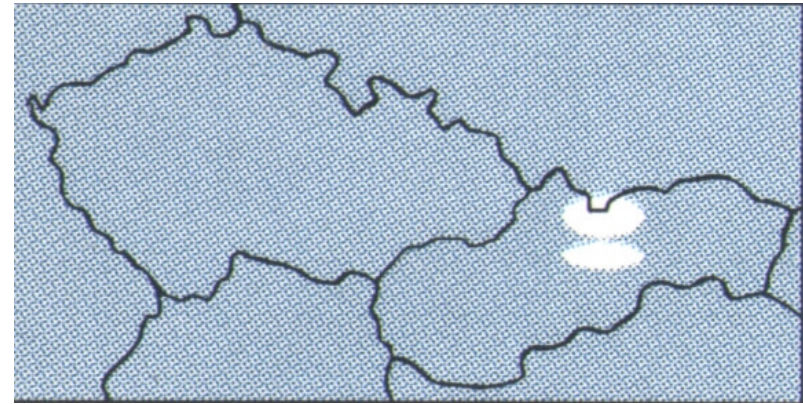

59%

*Crocidura russula* (Hermann, 1780)

- bělozubka tmavá

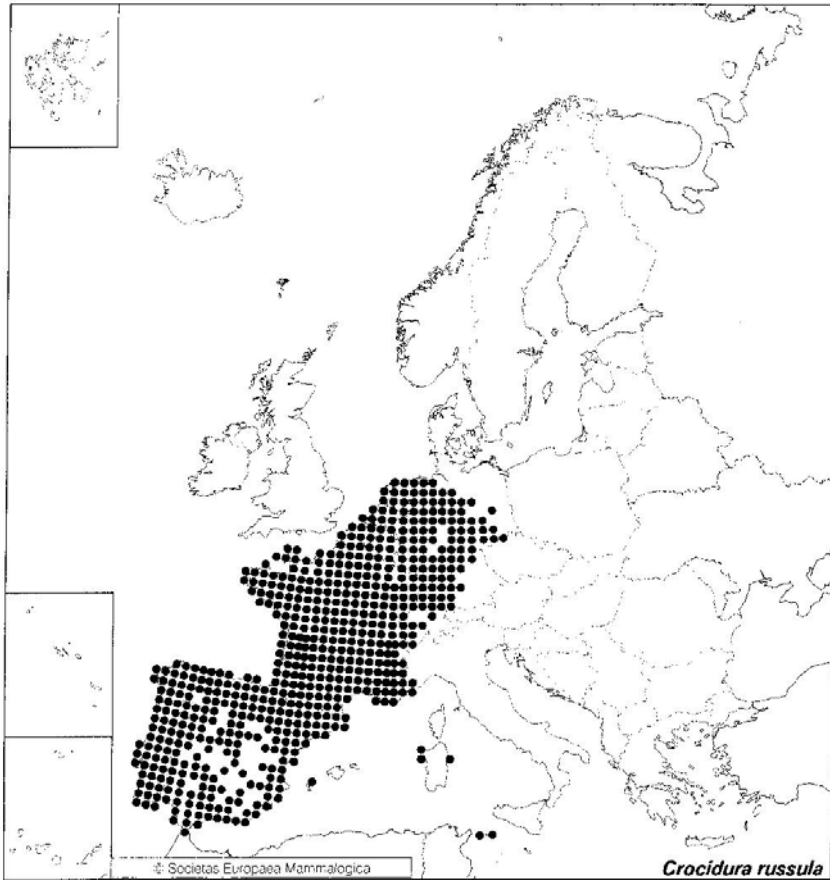

# *Talpa europaea* Linnaeus, 1758 - krtek obecný

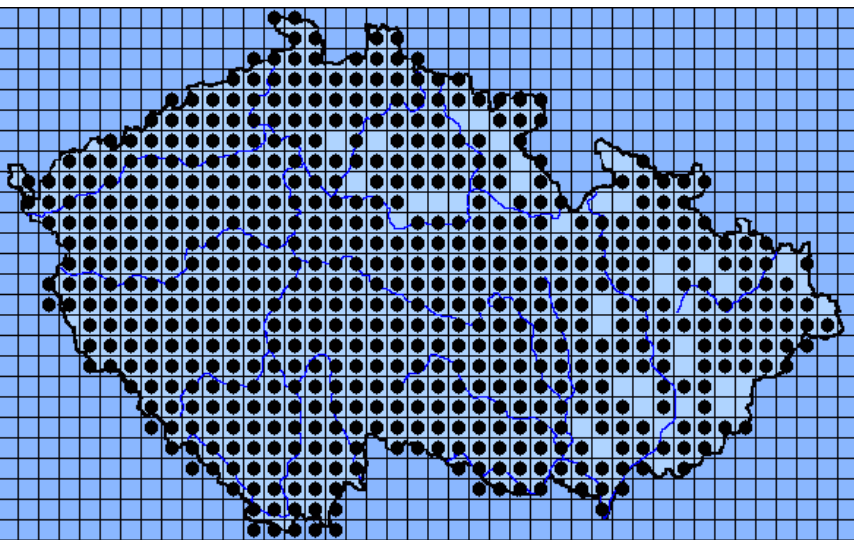
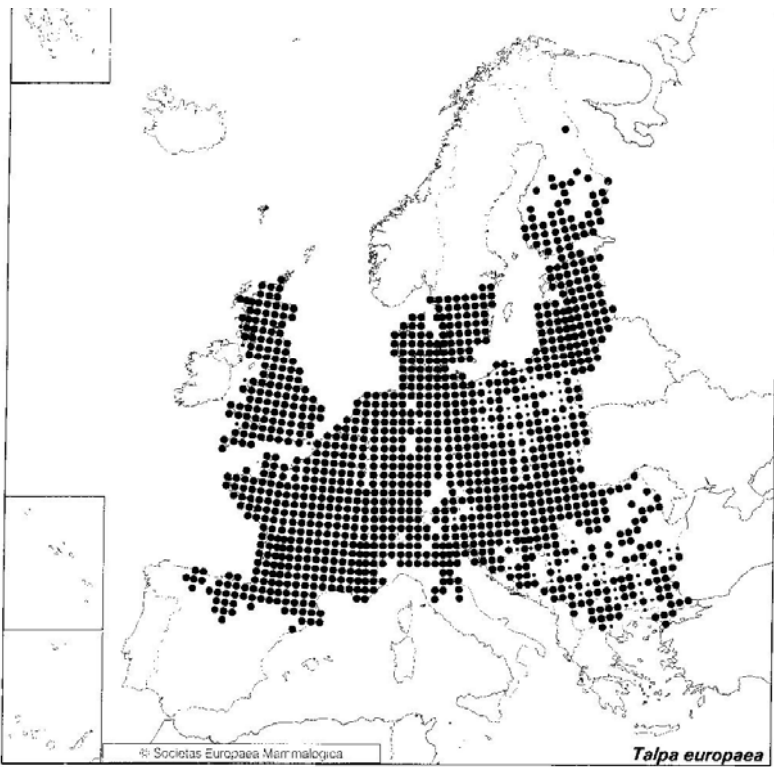

94% -, -, -

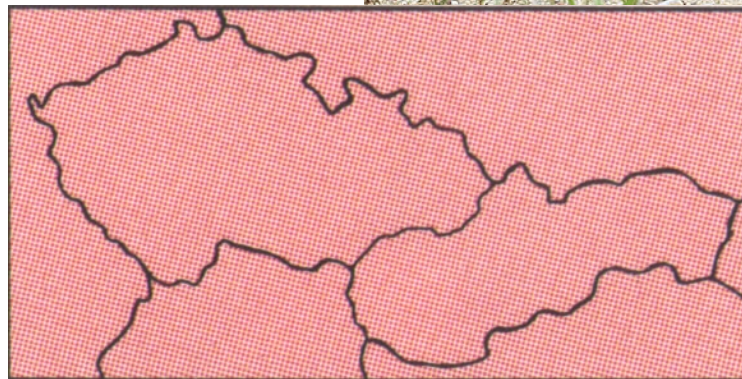

# Chiroptera - letouni

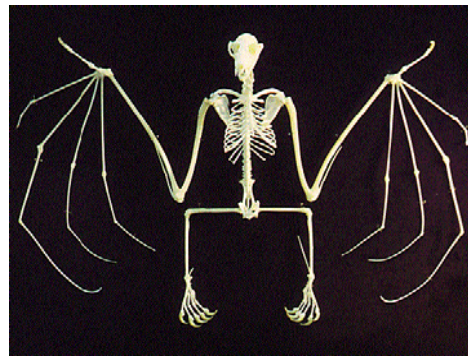
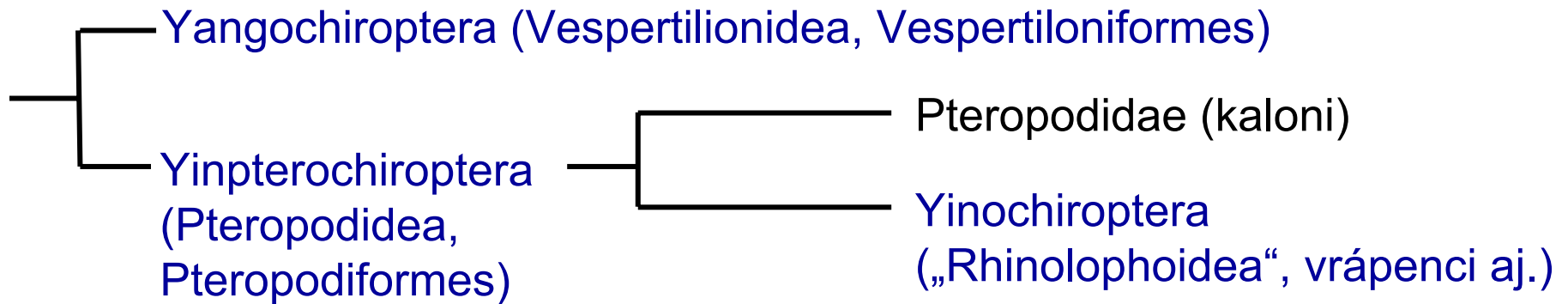

Yinochiroptera = Rhinolophoidea – Emballonuridae, Nycteridae =  
= **Rhinolophidae**, „Hipposideridae“, Megadermatidae, Rhinopomatidae,  
Crasseonycteridae



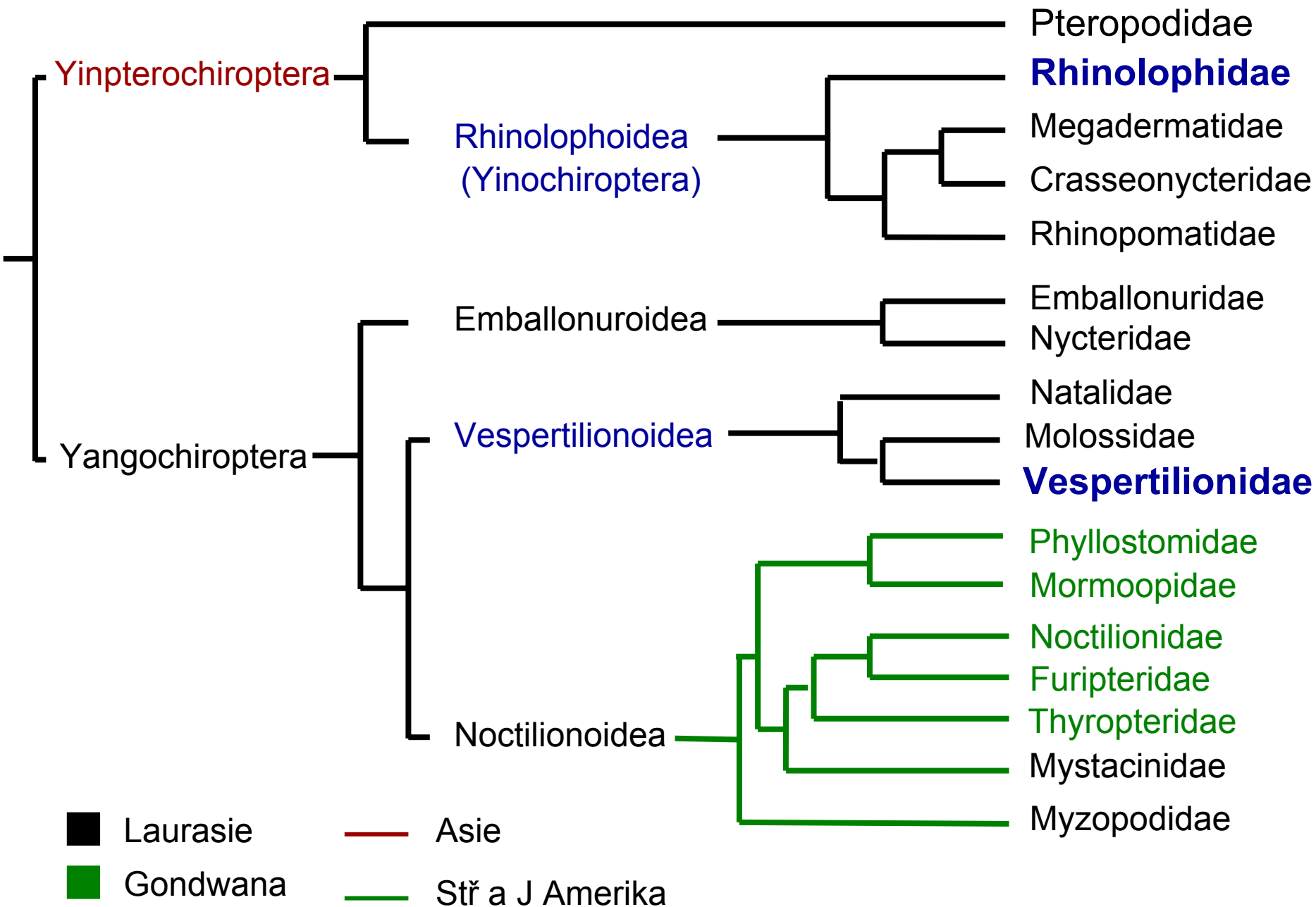

## **Rhinolophidae - vrápencovití**

*Rhinolophus hipposideros* (Bechstein, 1800) - vrápenec malý

*Rhinolophus ferrumequinum* (Schreber, 1774) - vrápenec velký

*Rhinolophus euryale* Blasius, 1853 - vrápenec jižní

## **Vespertilionidae - netopýrovití**

*Myotis mystacinus* (Kuhl, 1817) - netopýr vousatý

*Myotis brandtii* (Eversmann, 1845) - netopýr Brandtův

*Myotis alcathoe* Helversen & Heller, 2001 - netopýr menší

*Myotis bechsteinii* (Kuhl, 1817) - netopýr velkouchý

*Myotis emarginatus* (E. Geoffroy, 1806) - netopýr brvitý

*Myotis nattereri* (Kuhl, 1817) - netopýr řasnatý

*Myotis myotis* (Borkhausen, 1797) - netopýr velký

*Myotis blythii* (Tomes, 1857) - netopýr východní

*Myotis daubentonii* (Kuhl, 1817) - netopýr vodní

*Myotis dasycneme* (Boie, 1825) - netopýr pobřežní

*Vespertilio murinus* Linnaeus, 1758 - netopýr pestrý

*Eptesicus serotinus* Schreber, 1774 - netopýr večerní

*Eptesicus nilssonii* (Keyserling et Blasius, 1839) - netopýr severní

## Vespertilionidae - netopýrovití

*Nyctalus noctula* (Schreber, 1774) - netopýr rezavý

*Nyctalus leisleri* (Kuhl, 1817) - netopýr stromový

*Nyctalus lasiopterus* (Schreber, 1780) - netopýr obrovský

*Pipistrellus pipistrellus* (Schreber, 1774) - netopýr hvízdavý

*Pipistrellus pygmaeus* (Leach, 1825) - netopýr nejmenší

*Pipistrellus nathusii* (Keyserling et Blasius, 1839) – netopýr parkový

*Pipistrellus kuhlii* (Kuhl, 1817) - netopýr jižní

*Hypsugo savii* (Bonaparte, 1837) - netopýr Saviův

*Plecotus auritus* (Linnaeus, 1758) - netopýr (vrásnič) ušatý

*Plecotus austriacus* (Fischer, 1829) - netopýr (vrásnič) dlouhouchý

*Barbastella barbastellus* (Schreber, 1774) - netopýr černý

*Miniopterus schreibersii* (Kuhl, 1817) - létavec stěhovavý

# *Rhinolophus hipposideros* (Bechstein, 1800)

- vrápenec malý

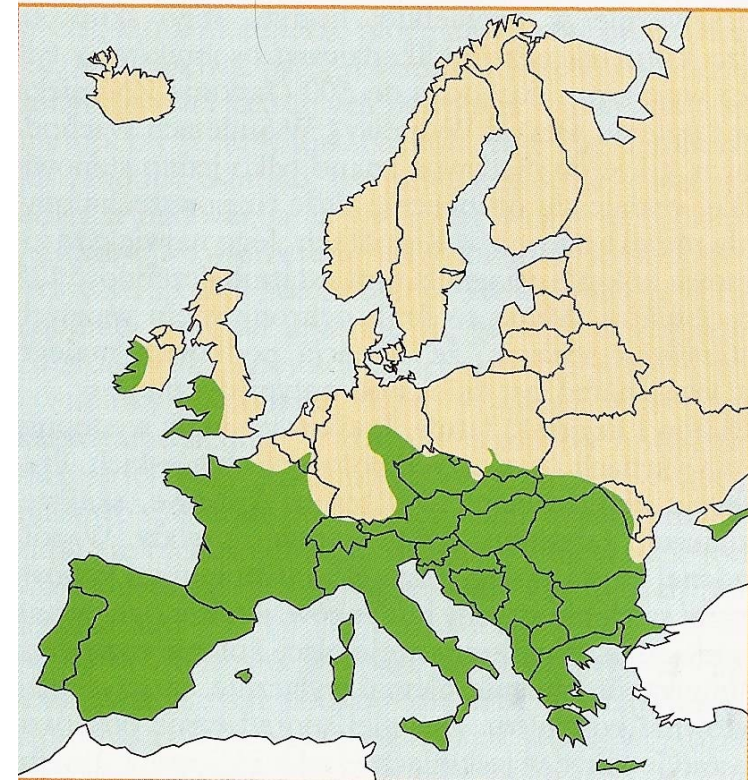
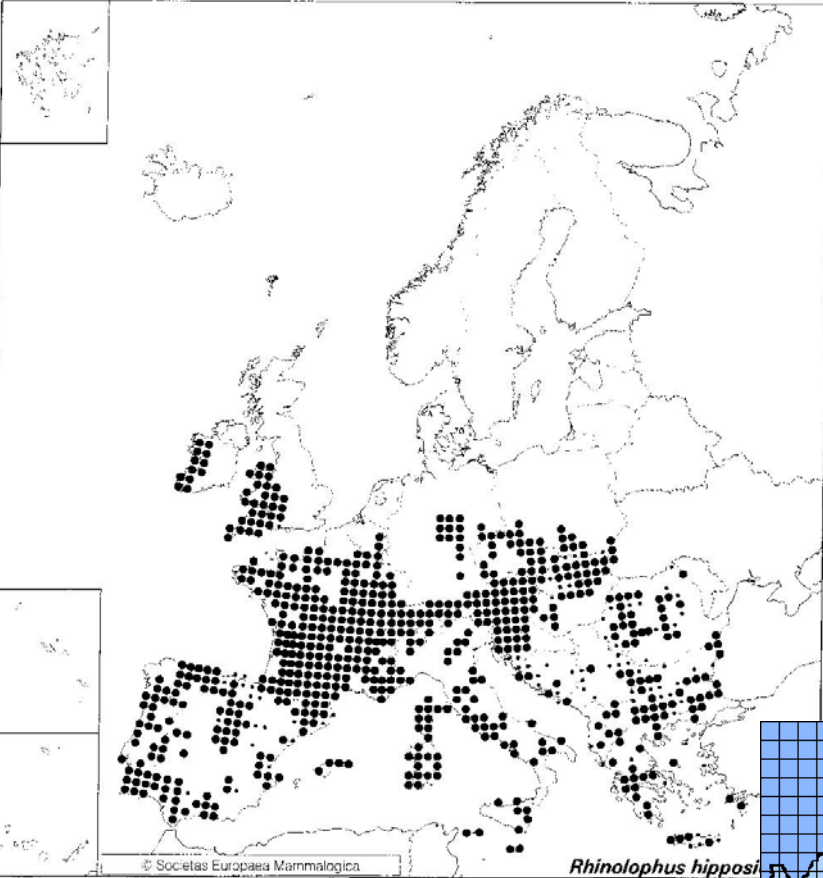

EN, LC, KO

37%

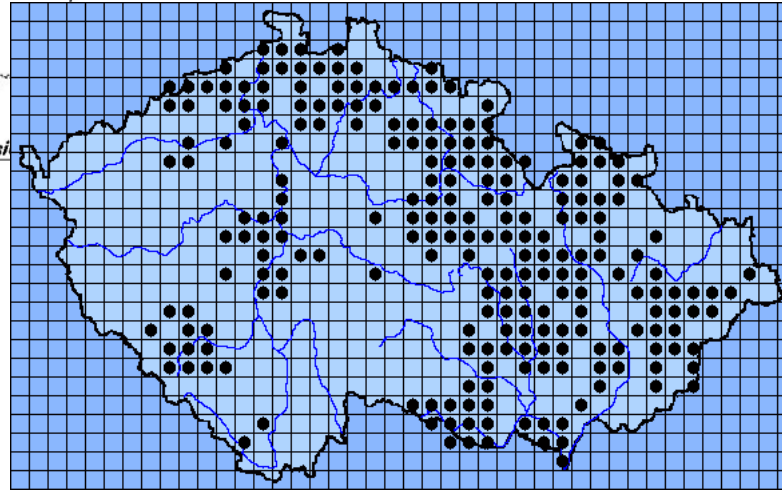

# Rhinolophus ferrumequinum (Schreber, 1774) - vrápenec velký

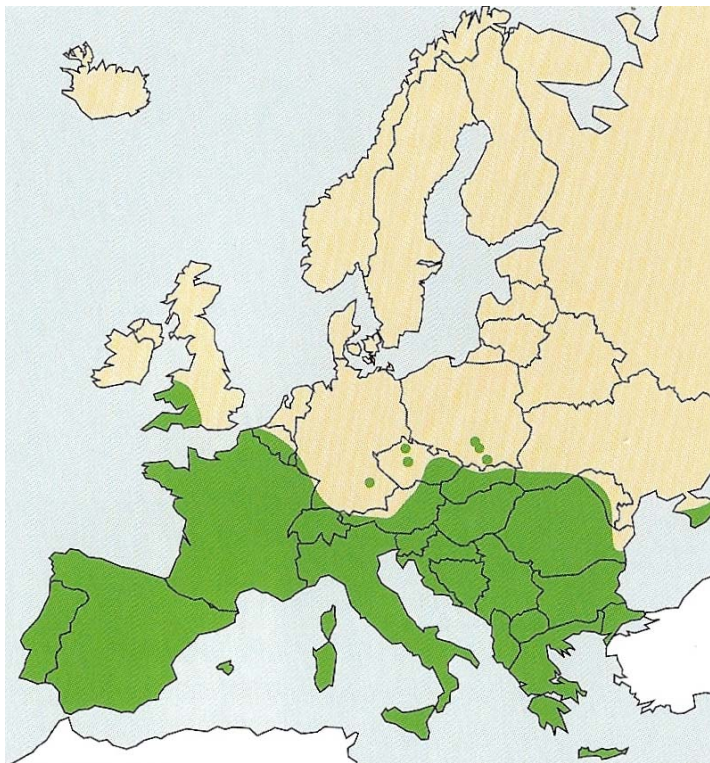
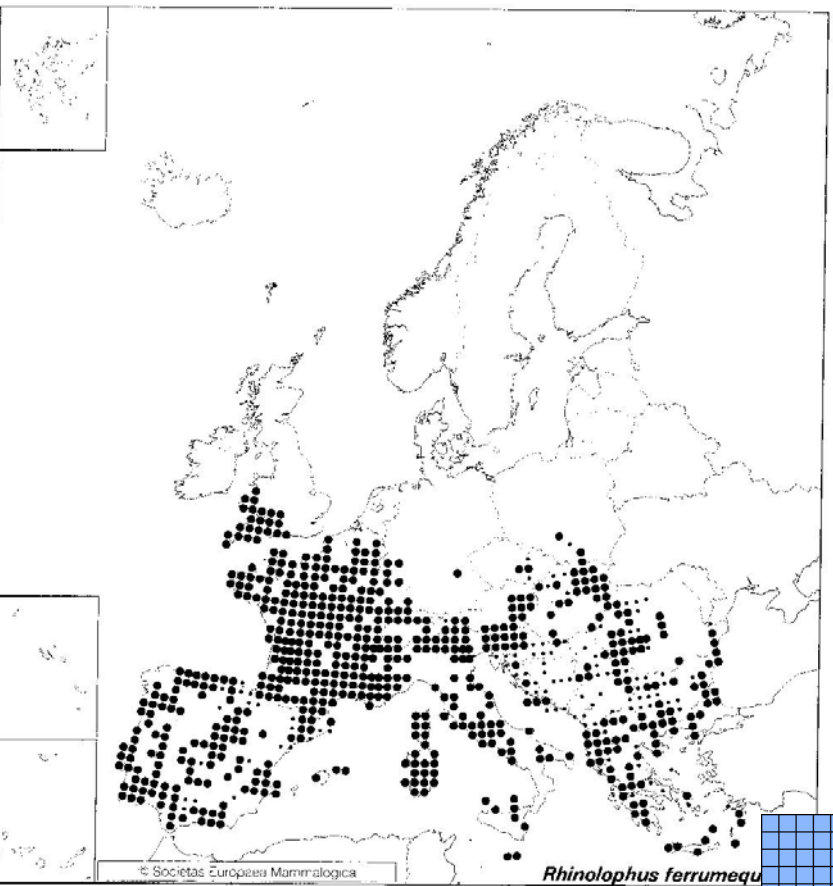

CR, LC, KO 1%

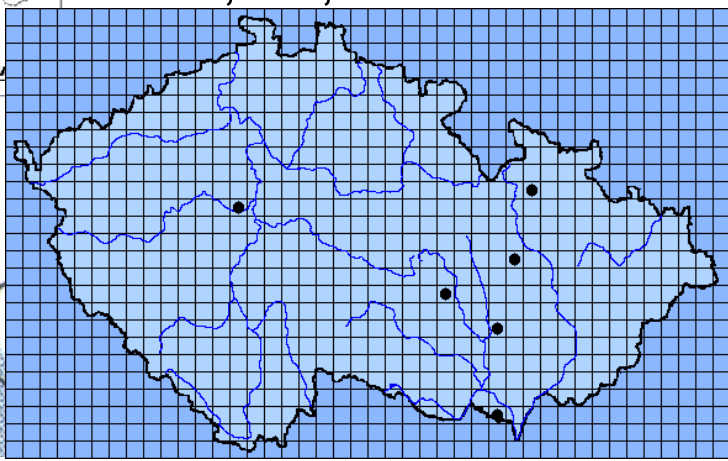

# *Rhinolophus euryale* Blasius, 1853

- vrápenec jižní

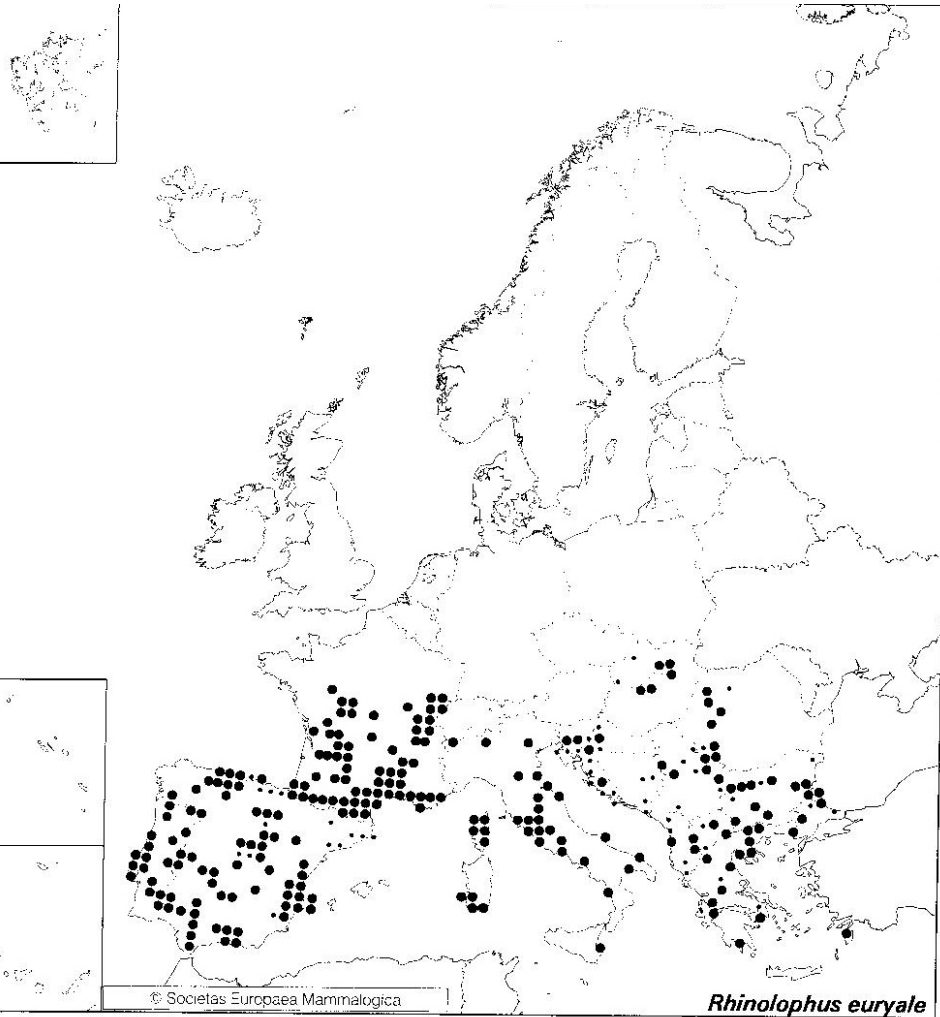

*Myotis mystacinus* (Kuhl, 1817)

- netopýr vousatý

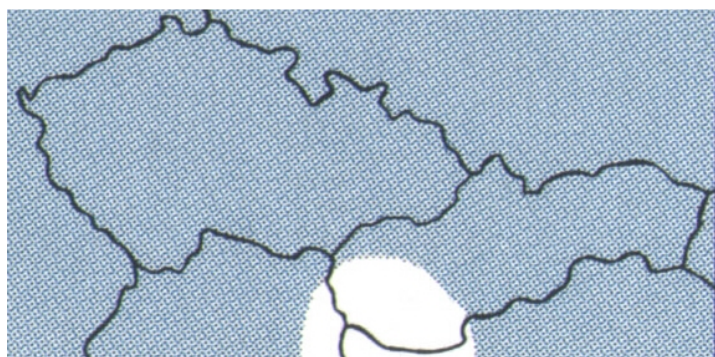
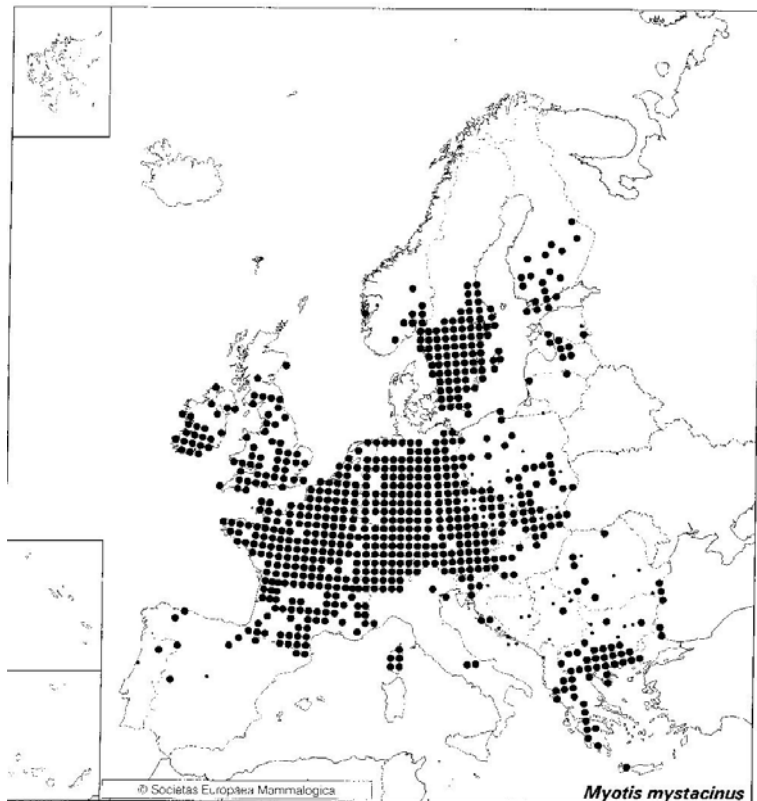

56%

- , - , SO

SR-2003

ČR-2005



*Myotis alcathoe* Helversen & Heller, 2001

- netopýr menší

*Myotis brandtii* (Eversmann, 1845)  
- netopýr Brandtův

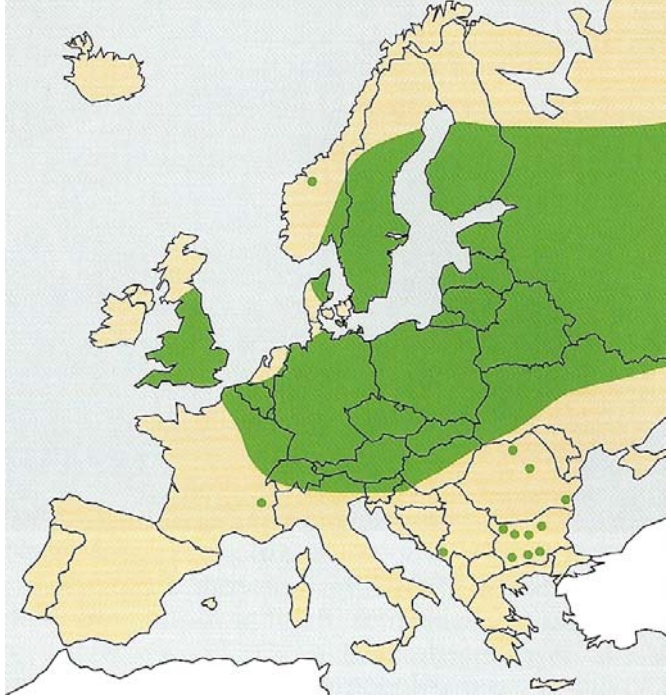
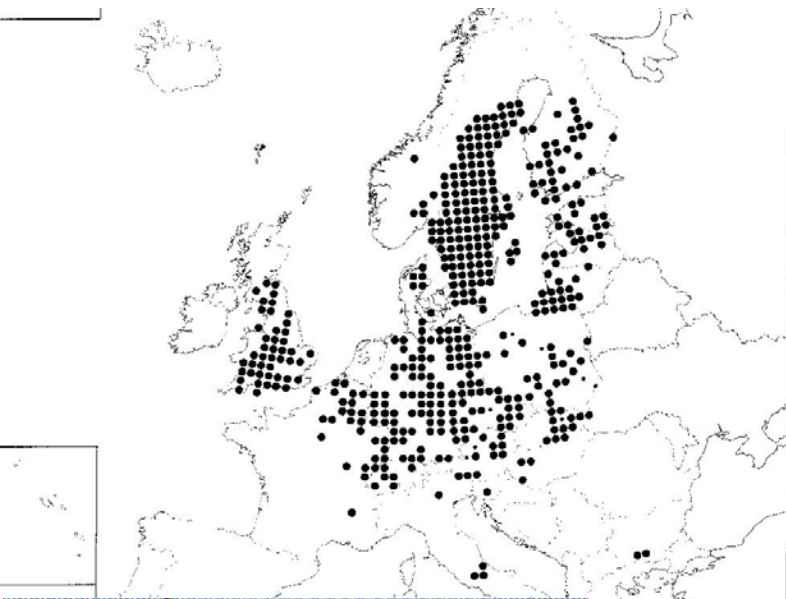

*Myotis brandtii*

25%

-, -, SO

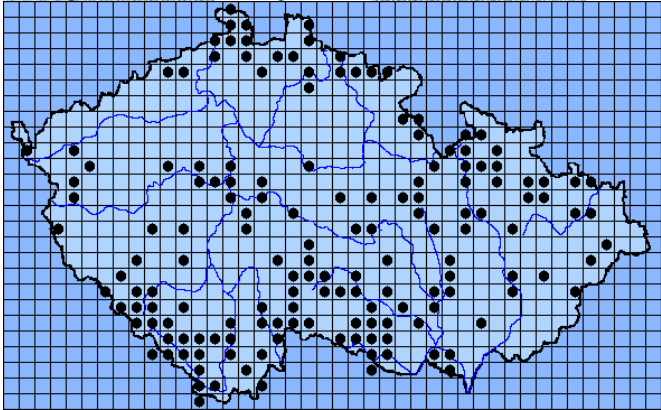



# *Myotis bechsteinii* (Kuhl, 1817)

- netopýr velkouchý

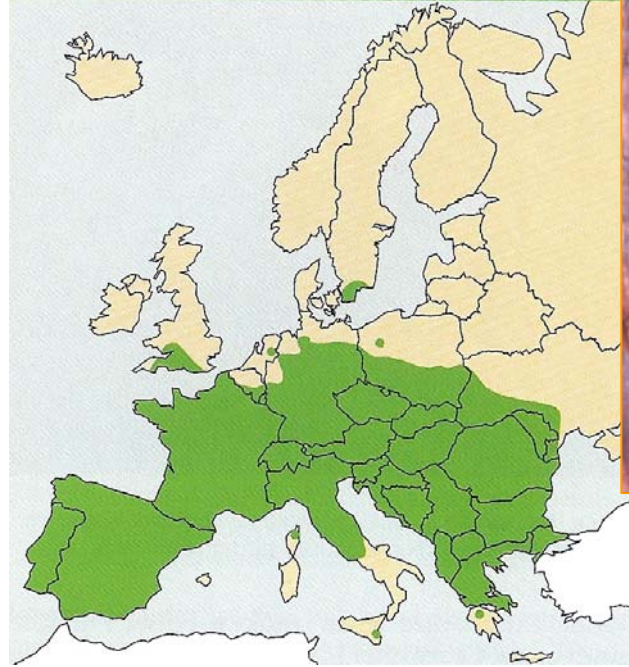
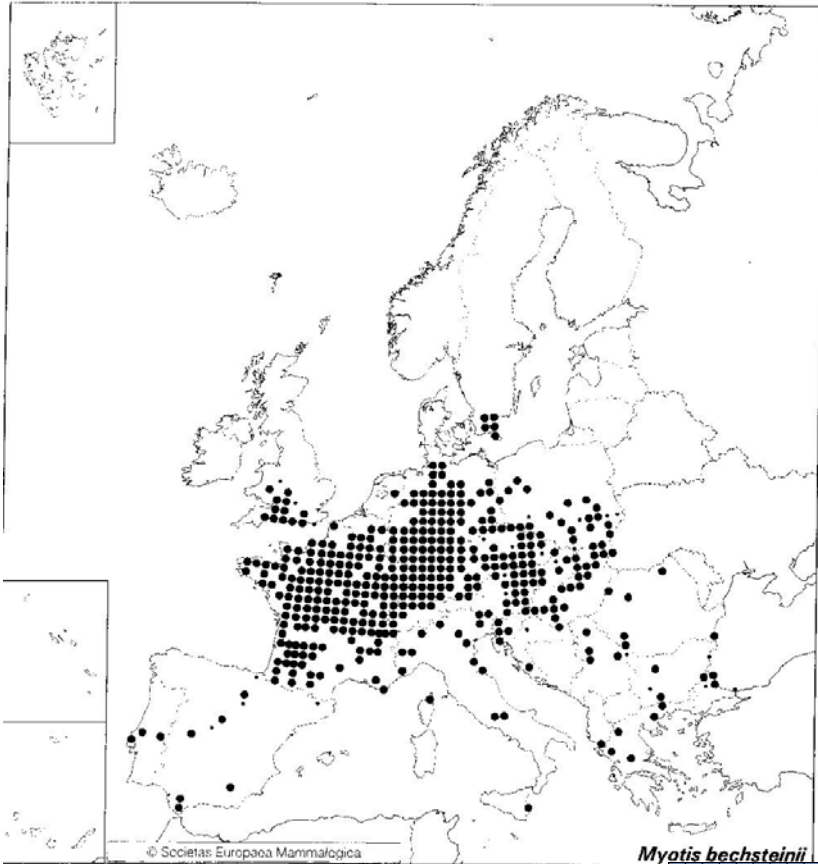

DD, NT, SO

23%

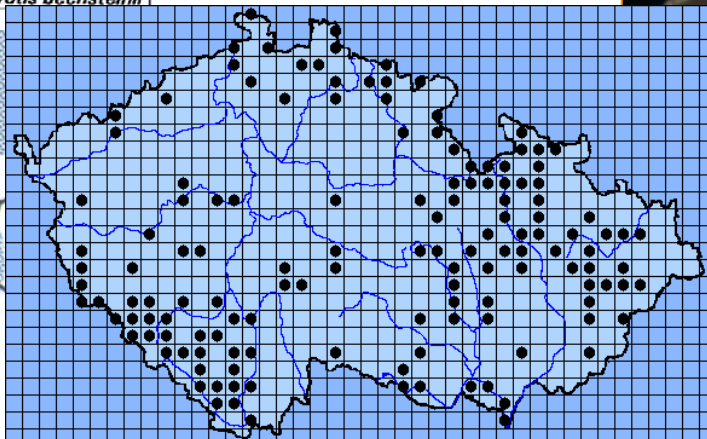

# *Myotis emarginatus* (E. Geoffroy, 1806) - netopýr brvitý

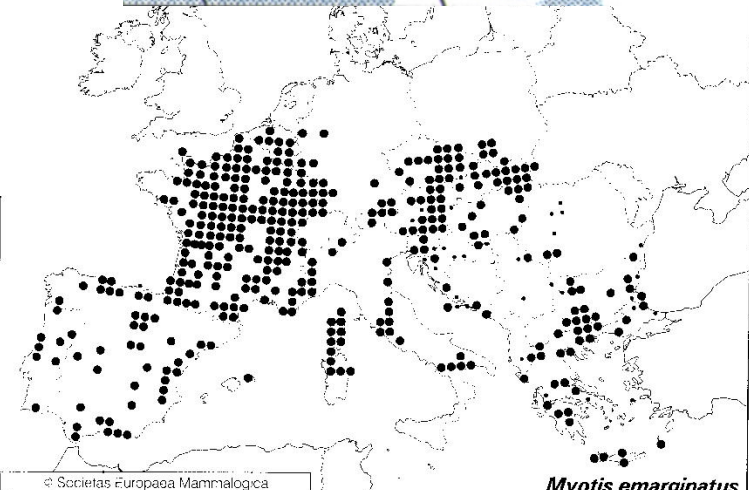
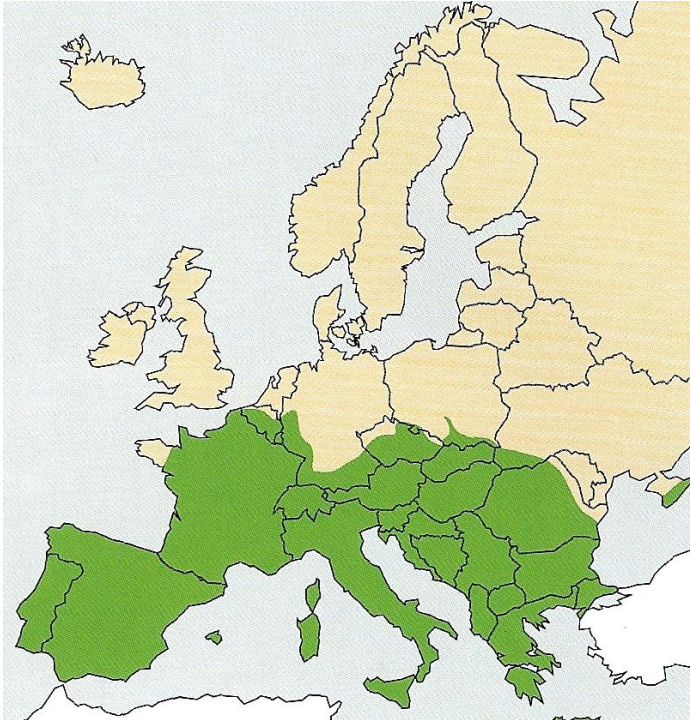

© Societas Europaea Mammalogica

*Myotis emarginatus*

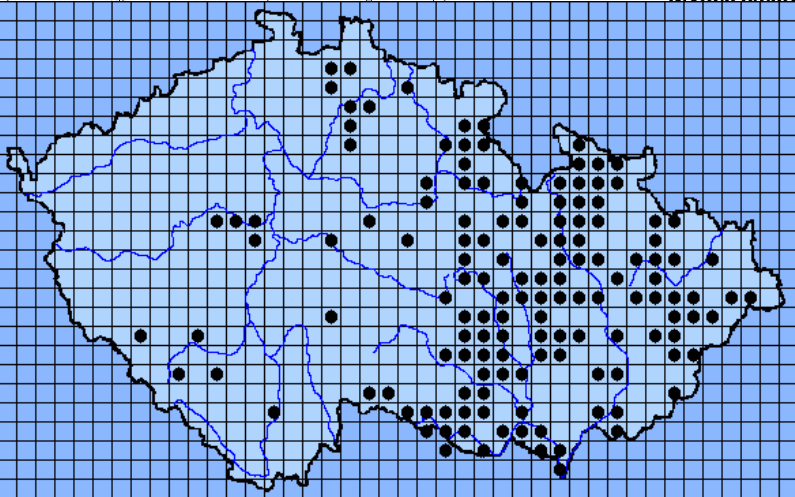

23%



VU, VU, KO

# *Myotis nattereri* (Kuhl, 1817)

- netopýr řasnatý

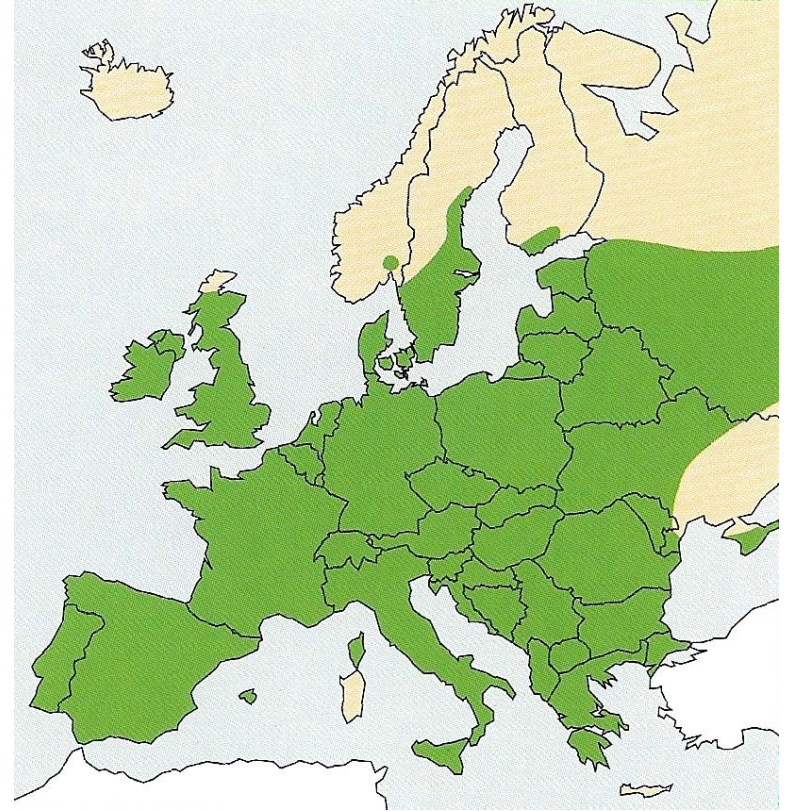
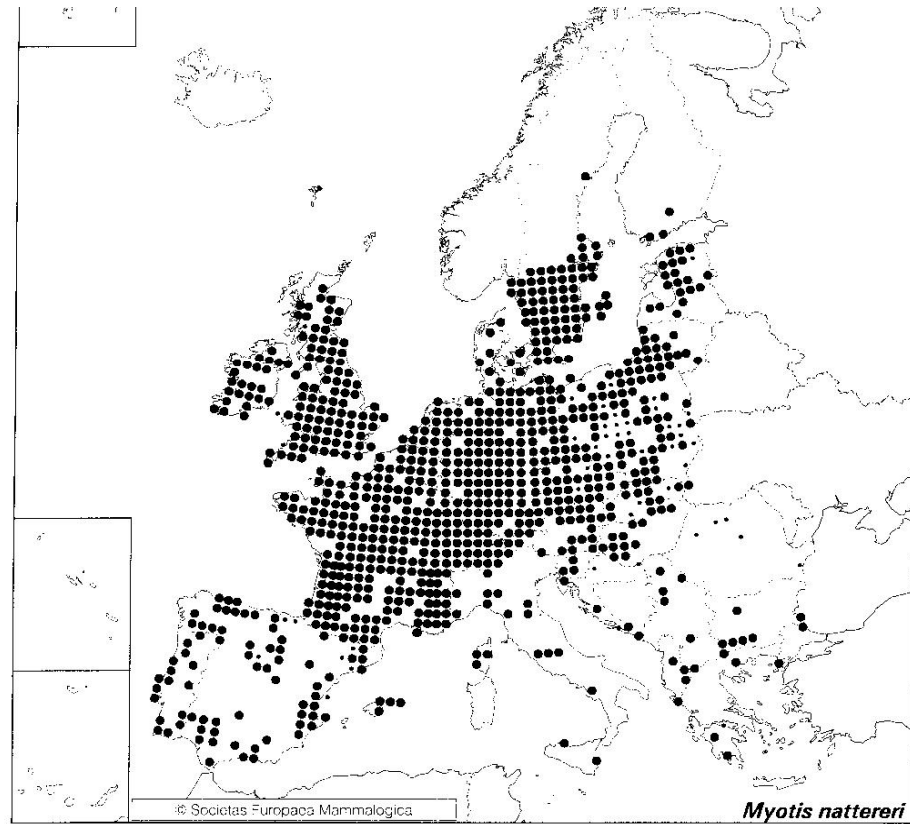

-, -, SO



43%

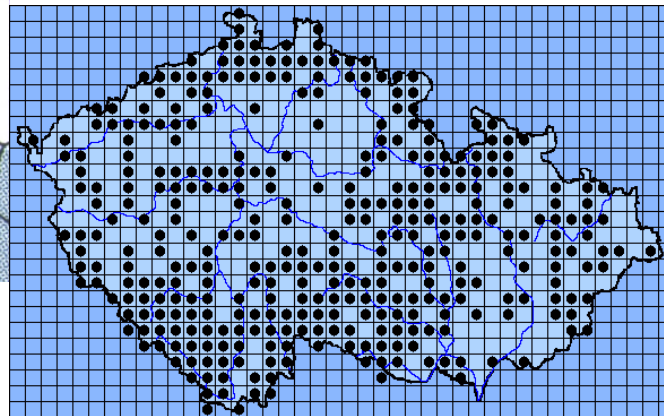

*Myotis myotis* (Borkhausen, 1797) -  
netopýr velký

VU, NT, KO

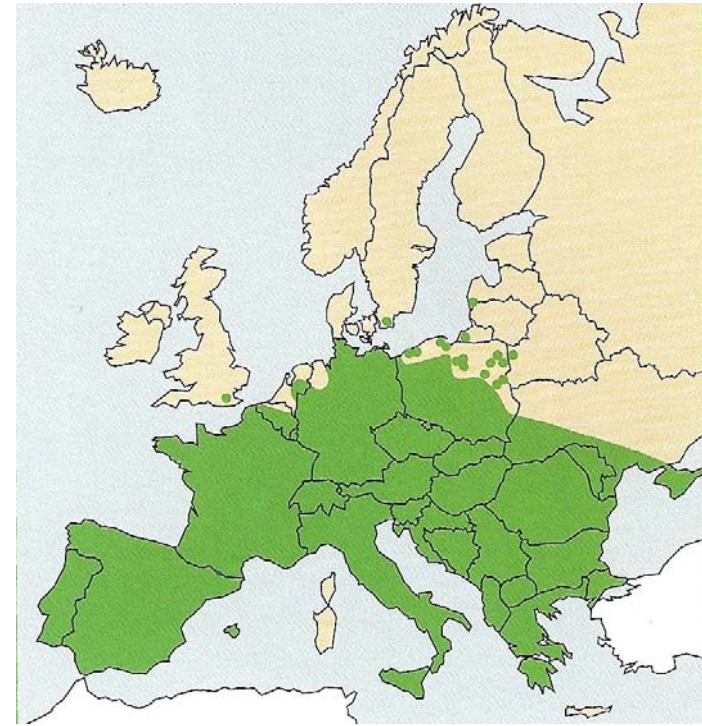
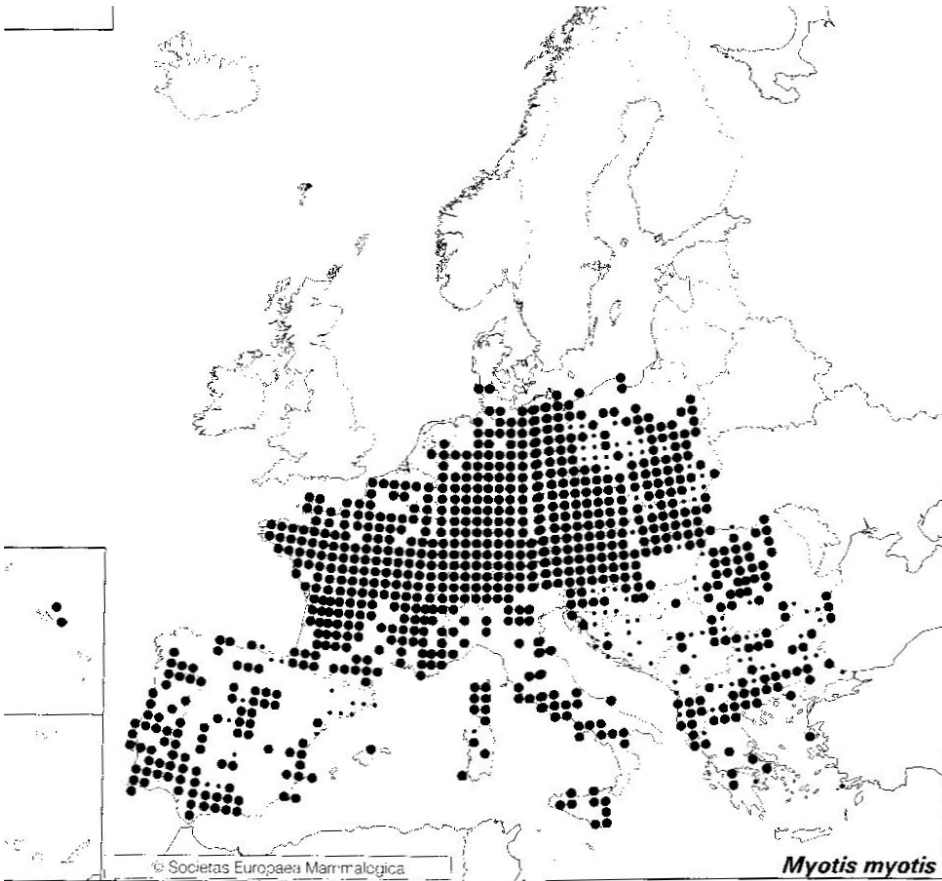

*Myotis myotis*

78%

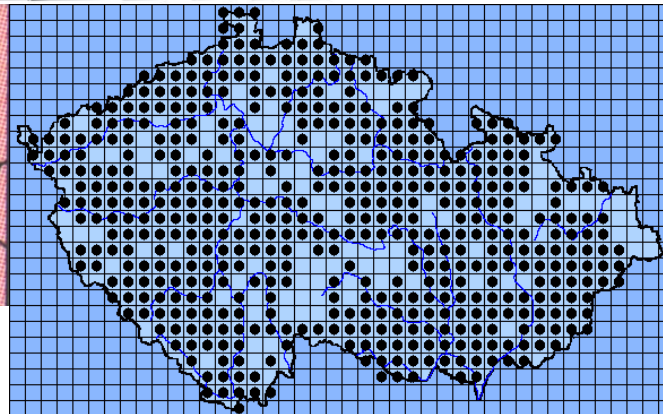
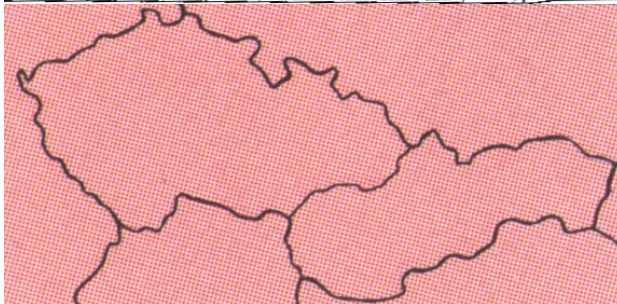

*Myotis blythii* (Tomes, 1857)

- netopýr východní

= *Myotis oxygnathus* (Monticelli, 1885)

- netopýr ostrouchý

CR, -, SO

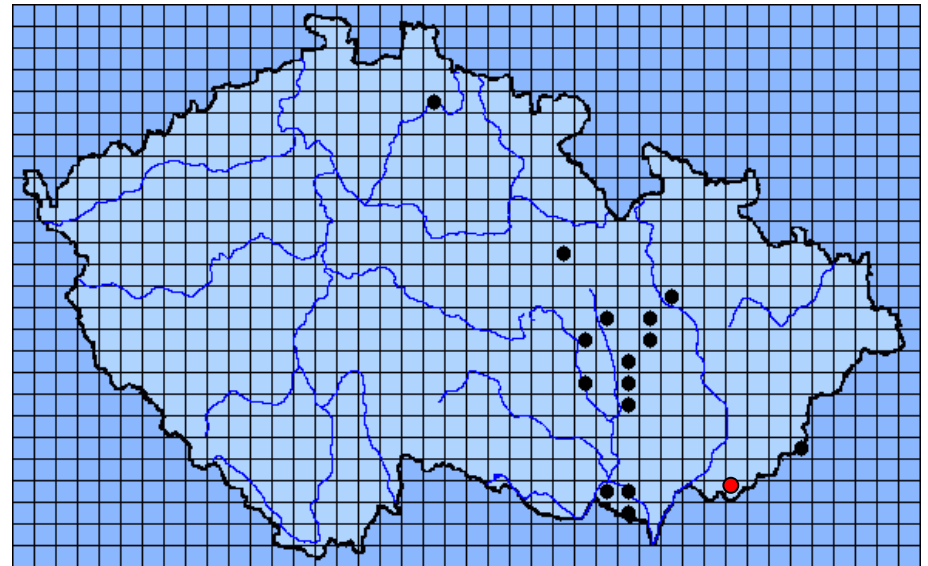
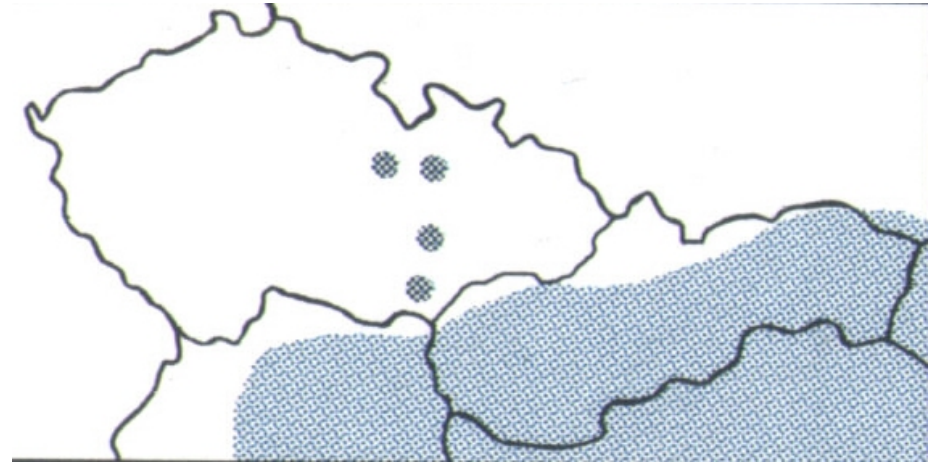
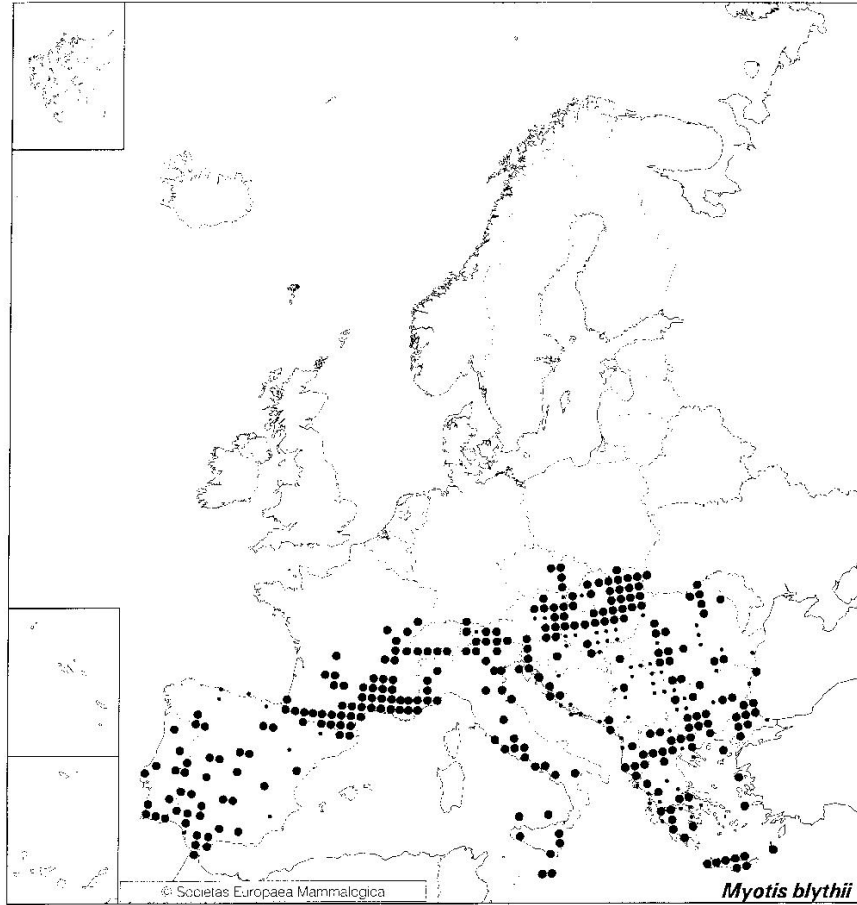

3%

19.7.2007

# *Myotis daubentonii* (Kuhl, 1817)

- netopýr vodní

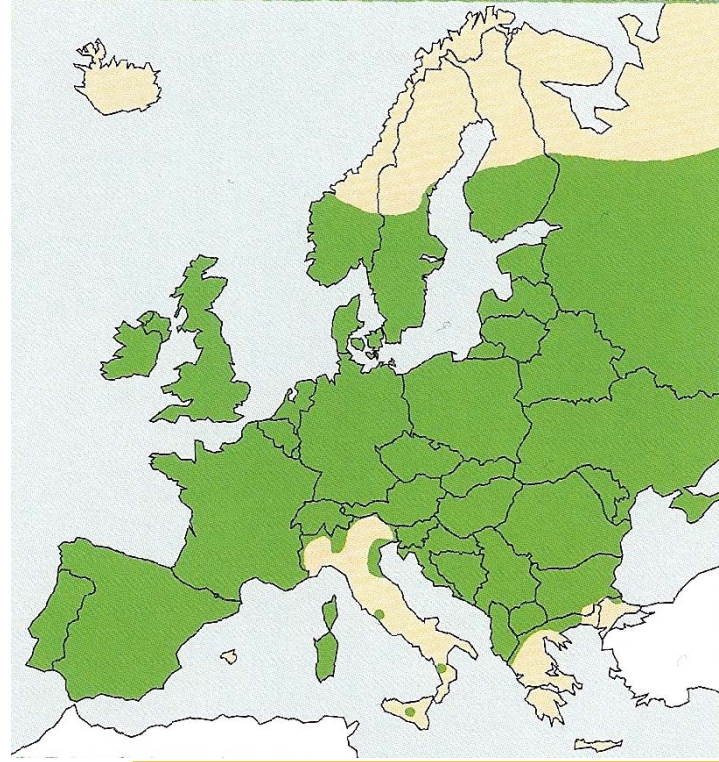
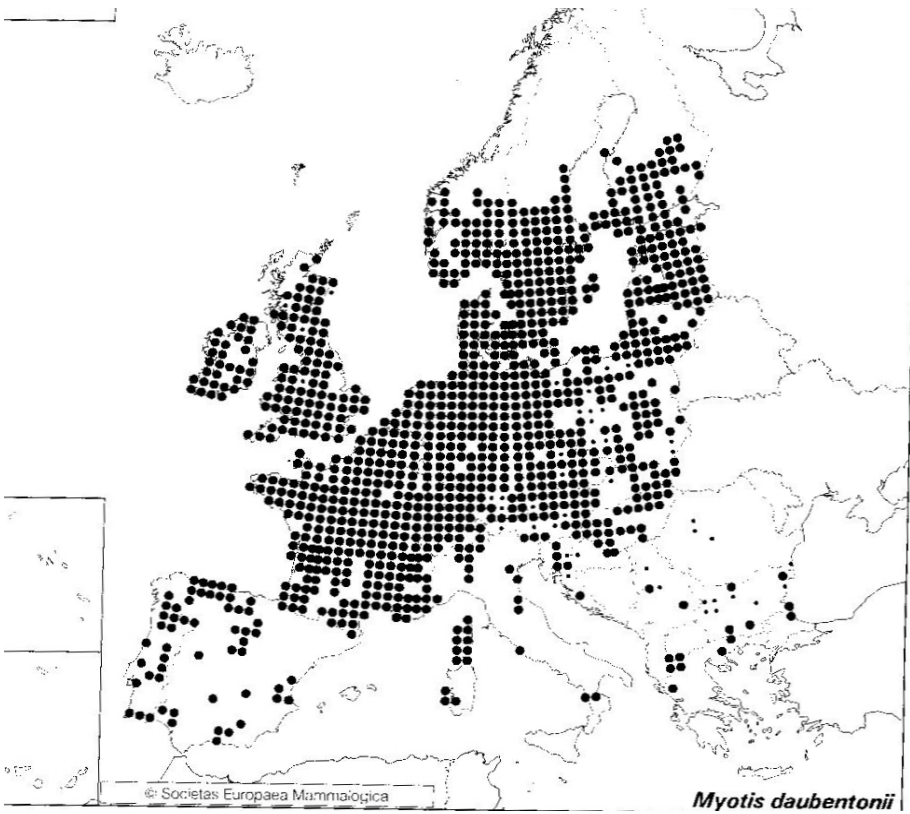

-, -, SO

65%

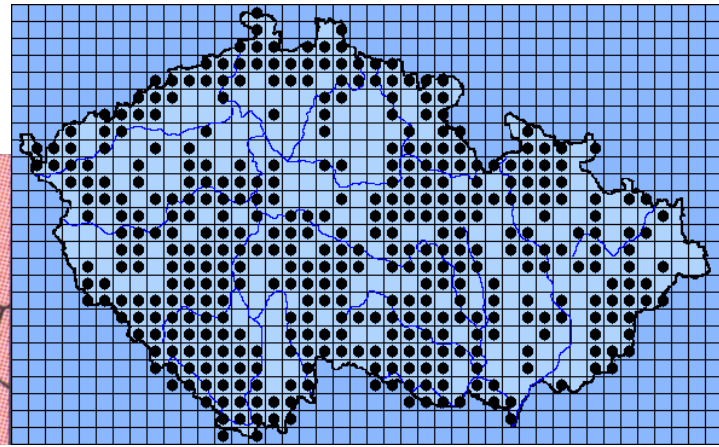
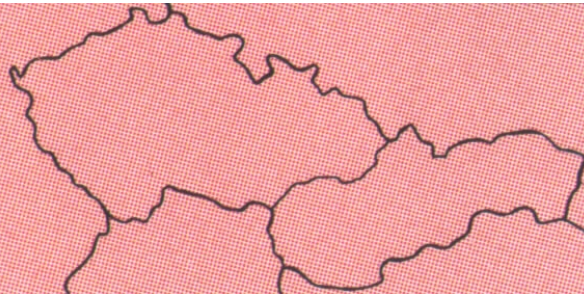

*Myotis dasycneme* (Boie, 1825) -  
netopýr pobřežní

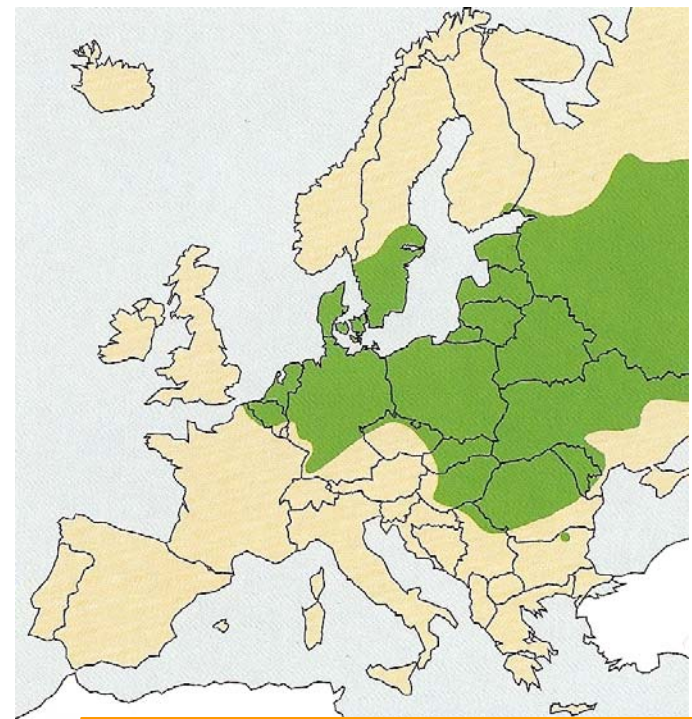
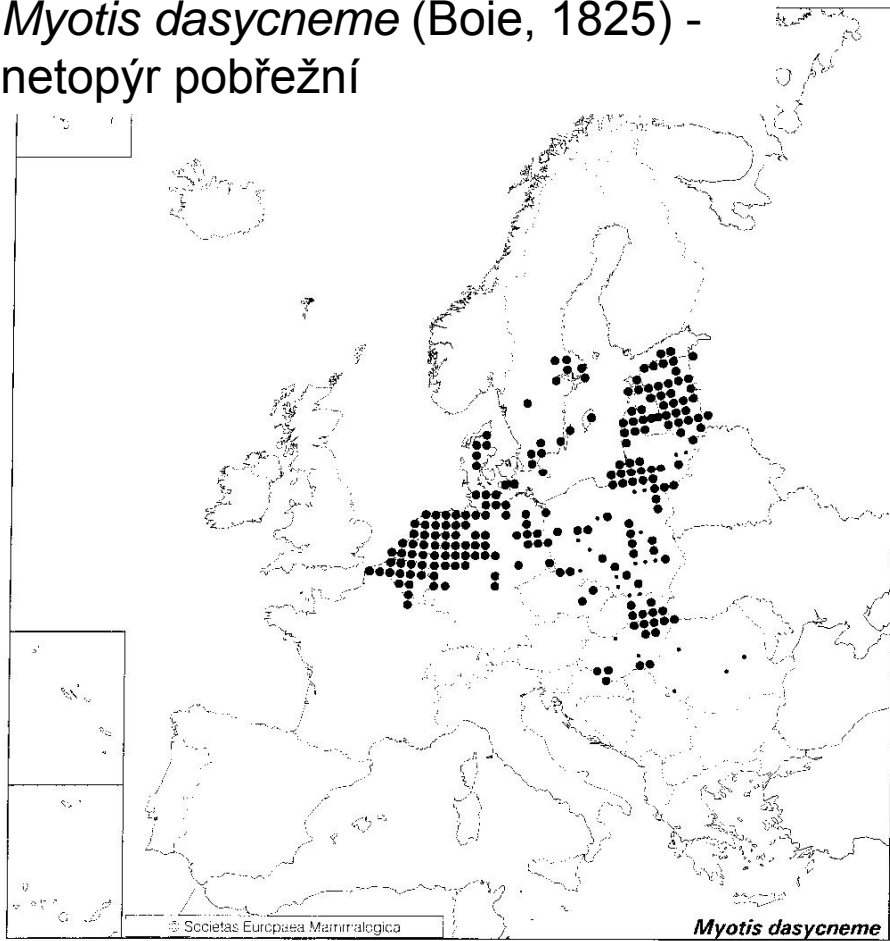

CR, VU, KO



2%

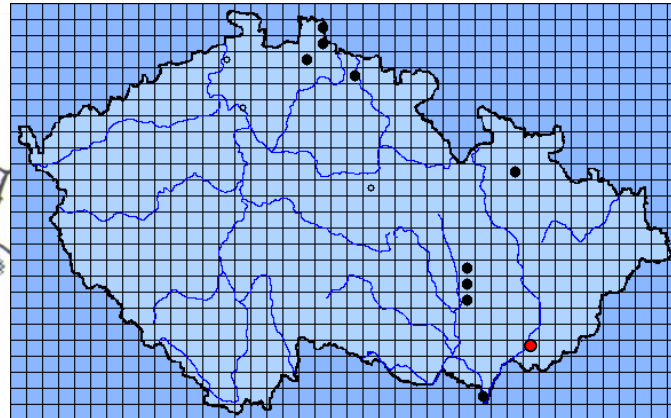

V. 2007

*Vespertilio murinus* Linnaeus, 1758  
- netopýr pestrý

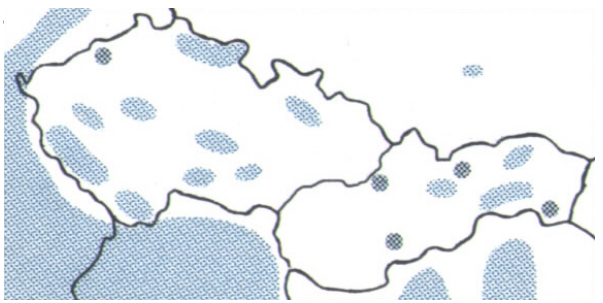
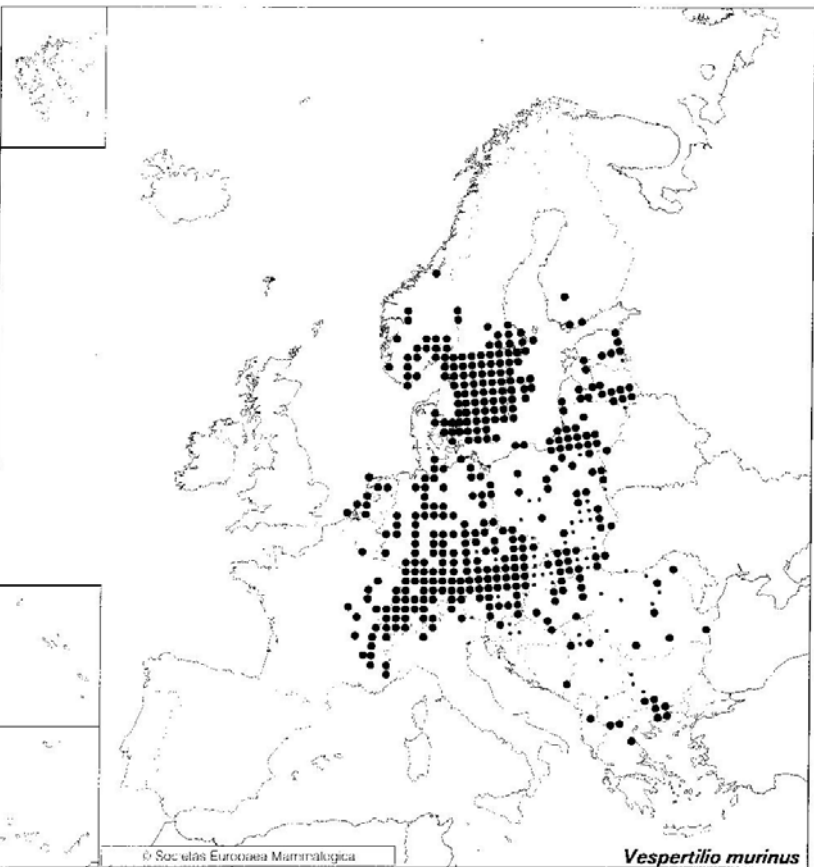

DD, -, SO

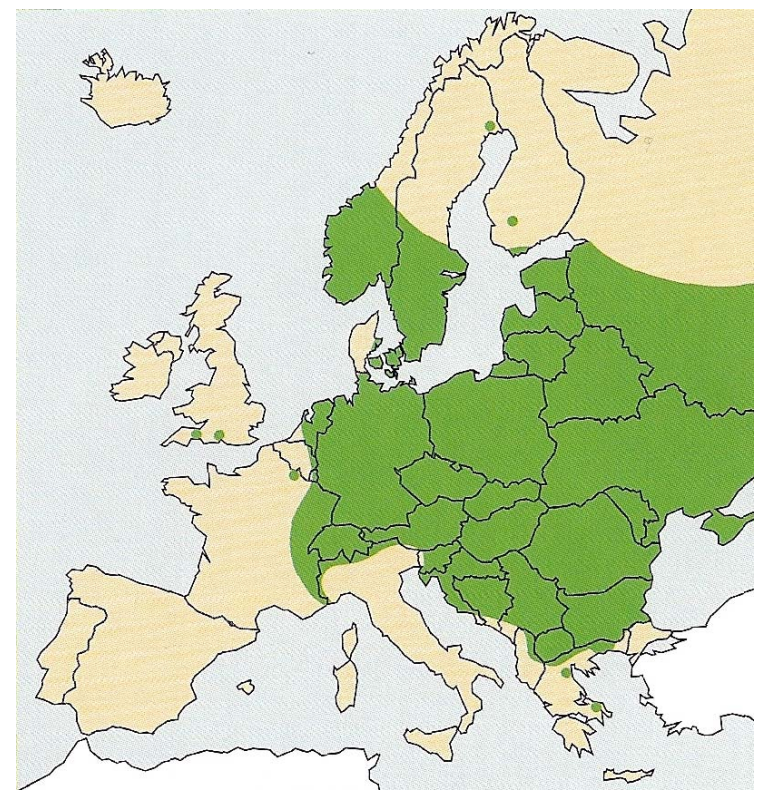



*Eptesicus serotinus* Schreber, 1774  
- netopýr večerní

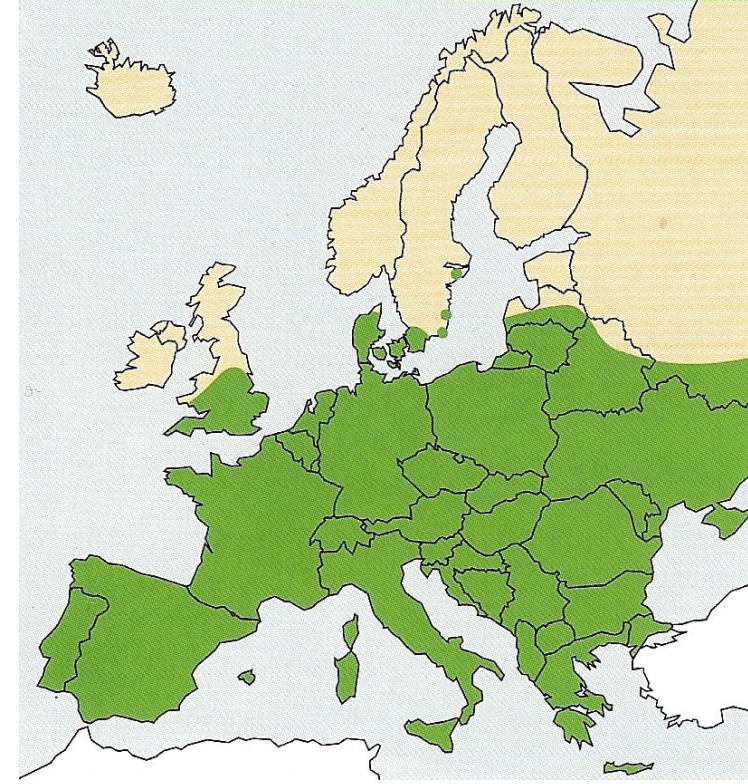
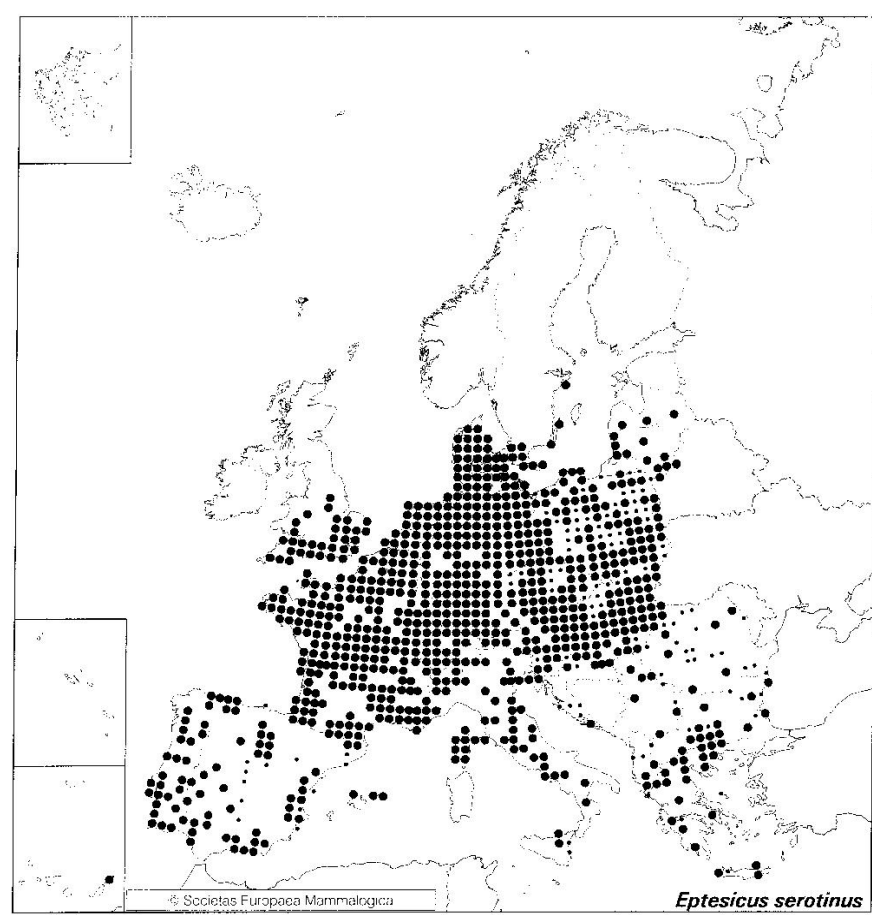

-, -, SO

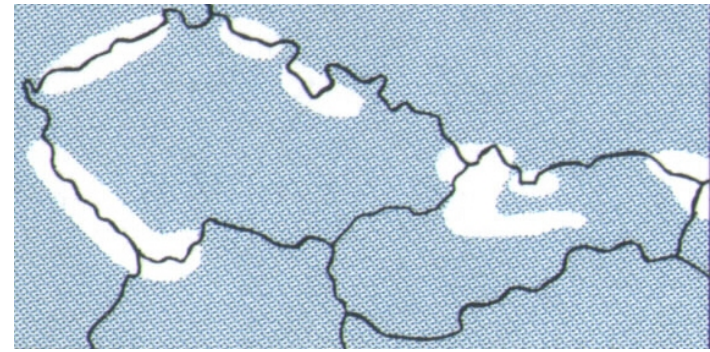

# *Eptesicus nilssonii* Keyserling et Blasius, 1839)

- netopýr severní

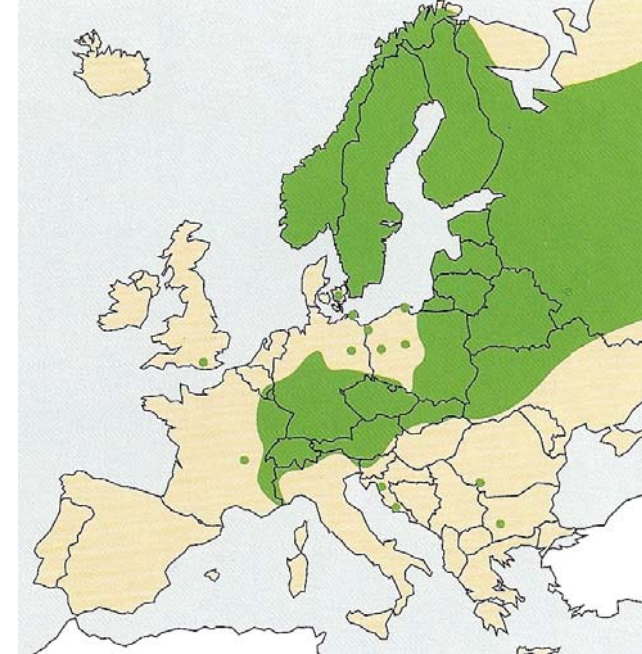

-, -, SO

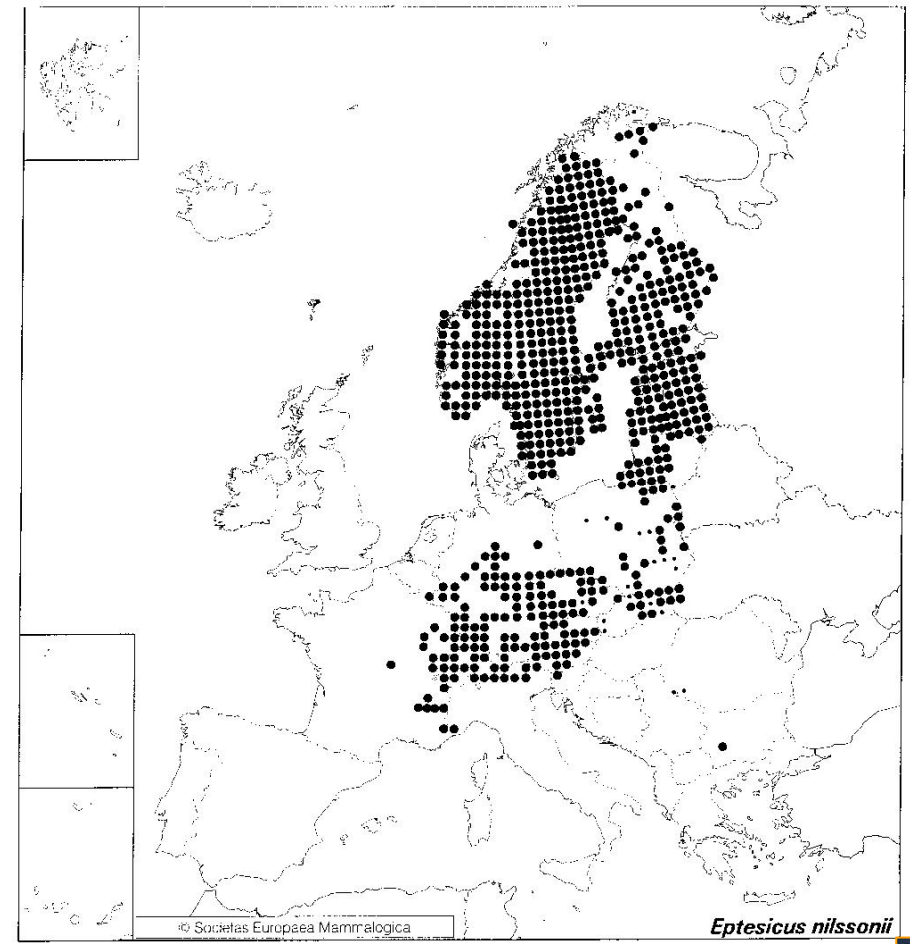

*Eptesicus nilssonii*

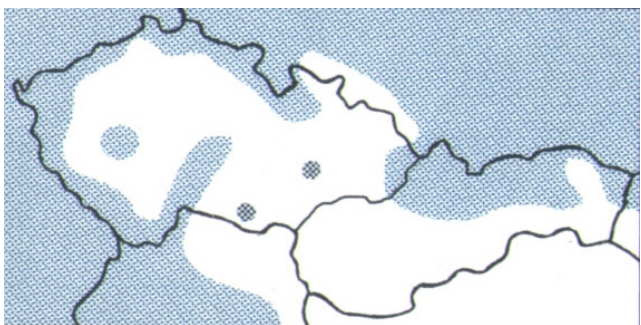

# *Nyctalus noctula* (Schreber, 1774)

- netopýr rezavý

-, -, SO

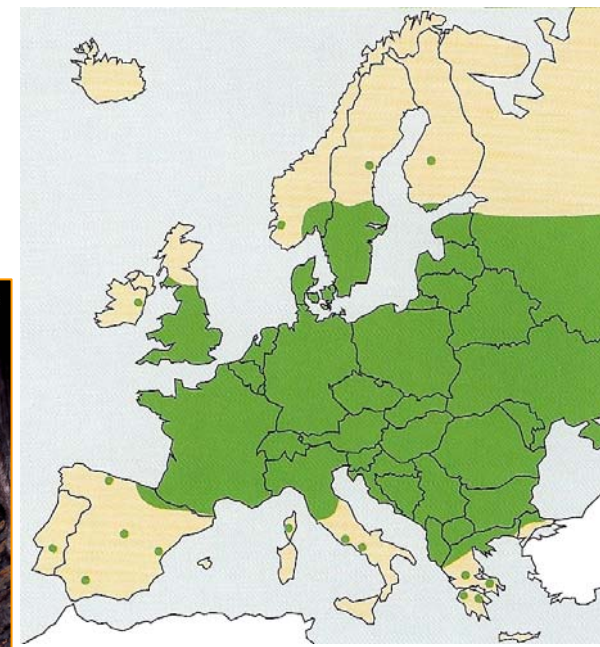
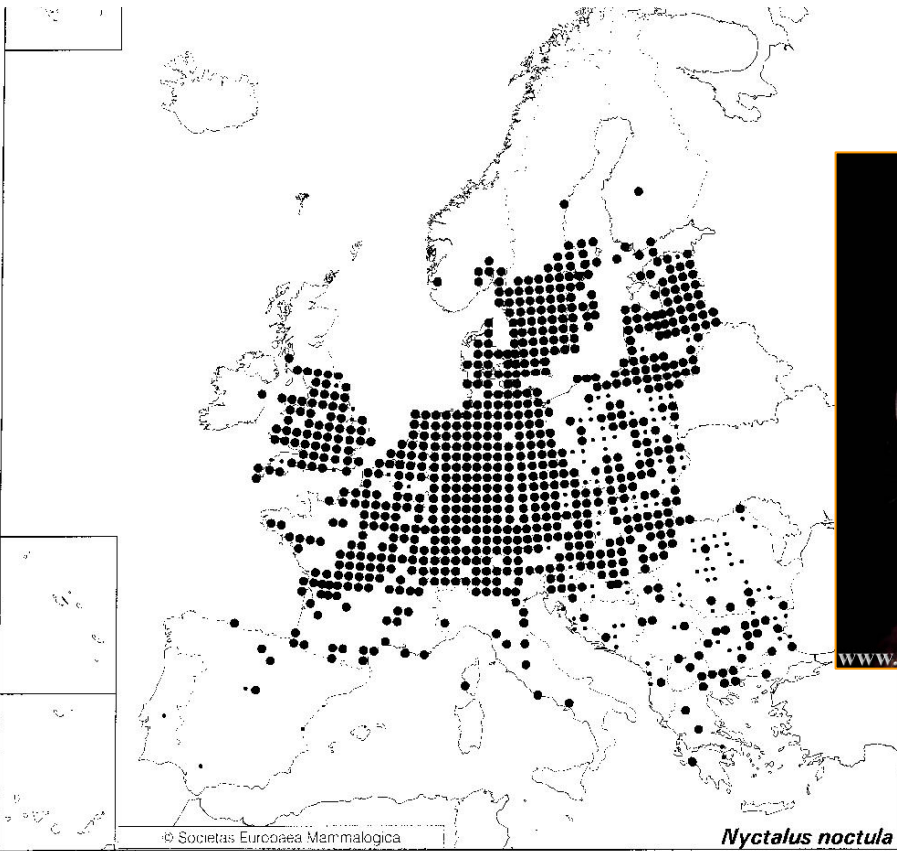

literature



*Nyctalus lasiopterus* (Schreber, 1780) -  
 netopýr obrovský

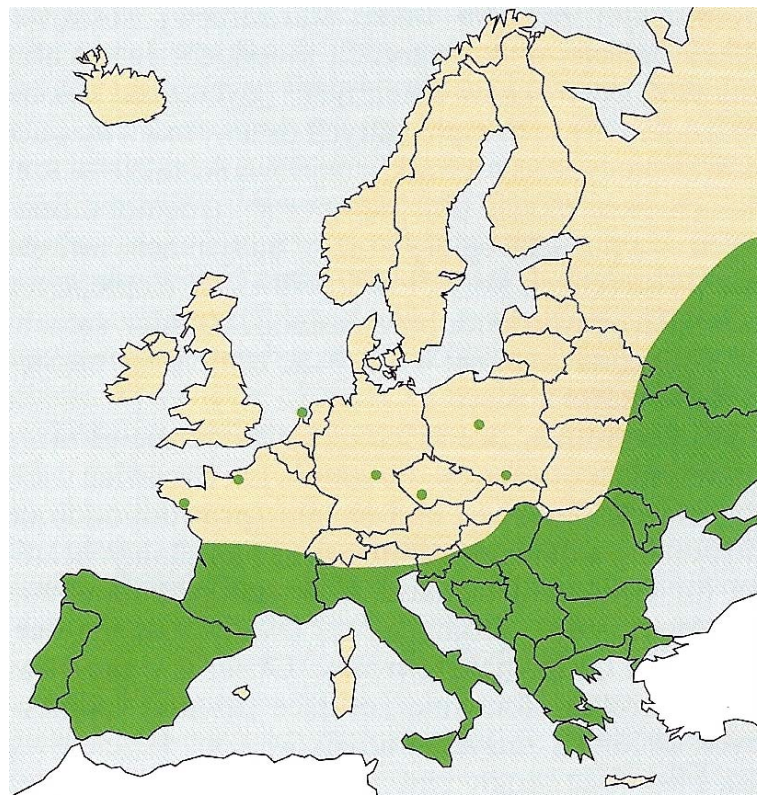
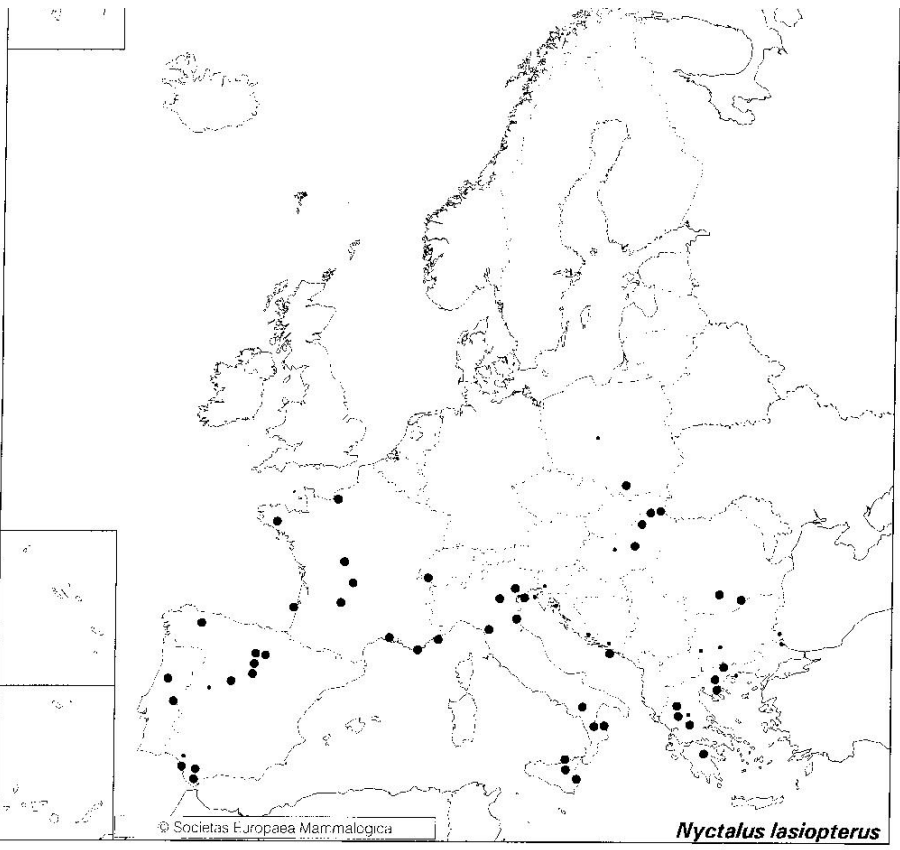

-, -, SO



(с) В. П. Вехник

# *Nyctalus leisleri* (Kuhl, 1817) - netopýr stromový

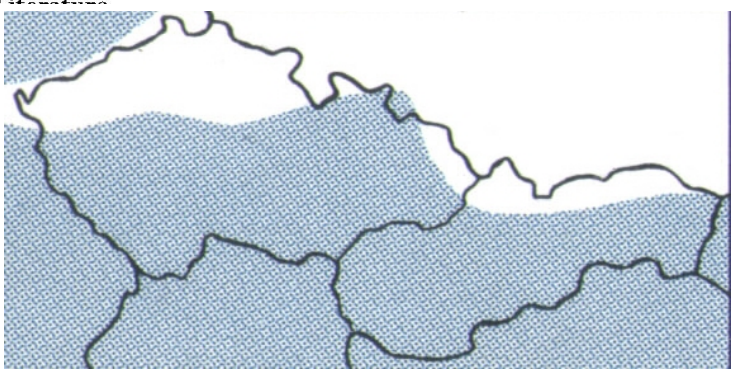
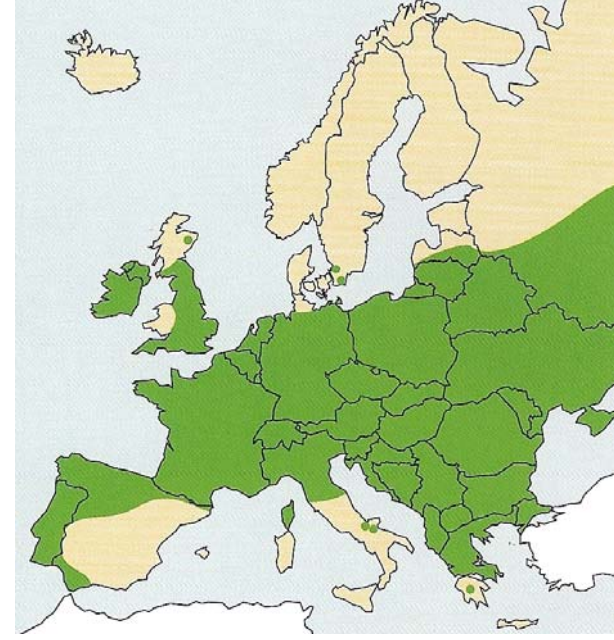
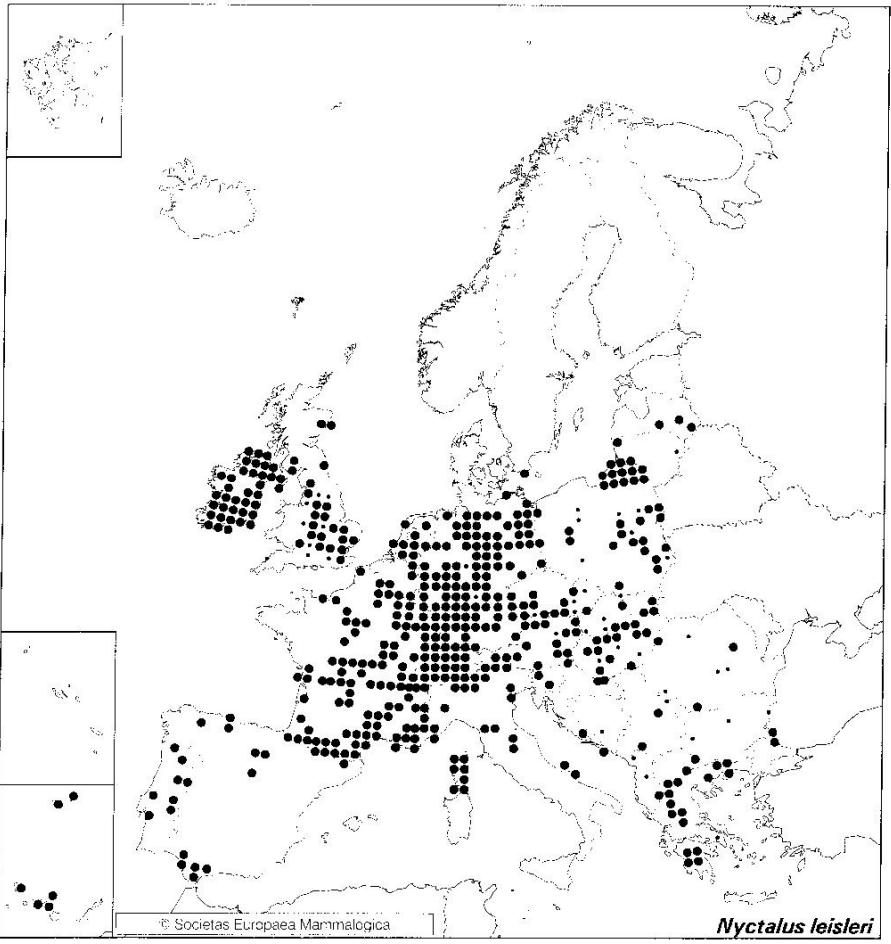

DD, LR/nt, SO



# *Pipistrellus pipistrellus* s.l.

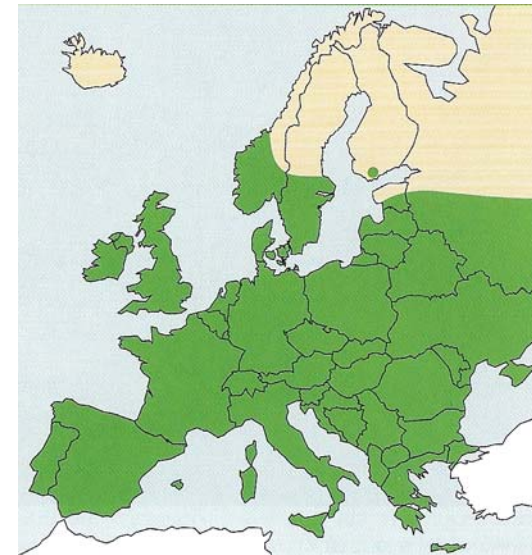
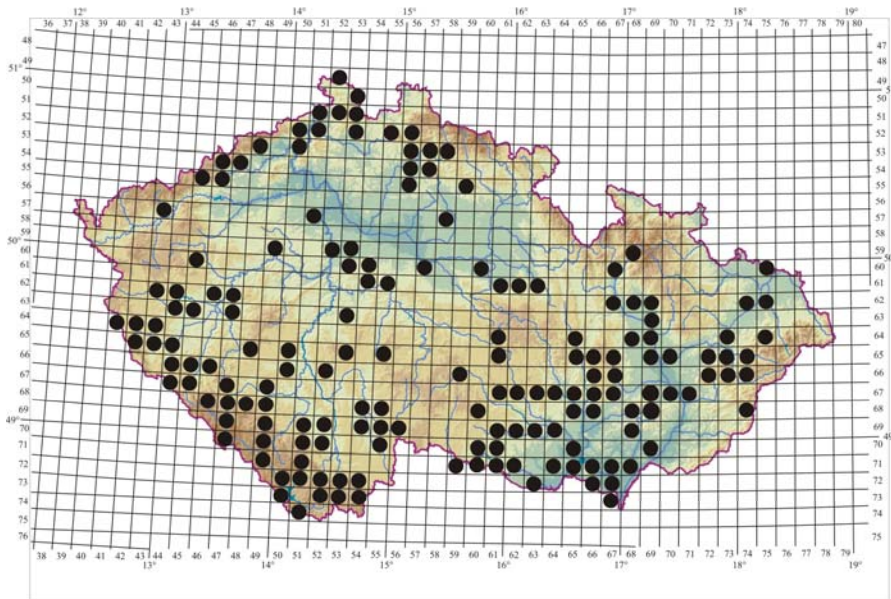
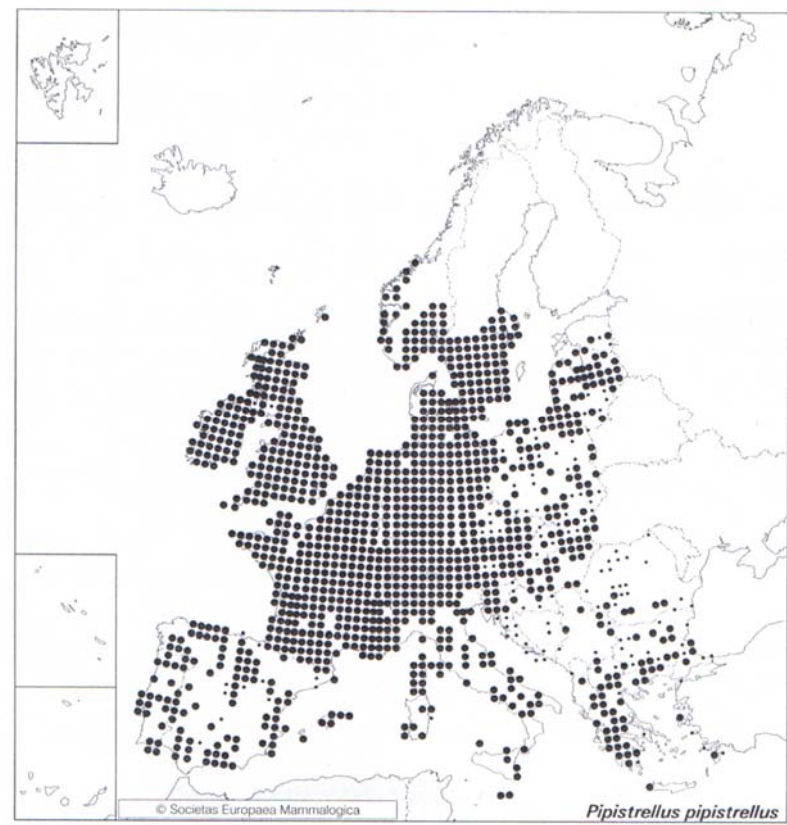
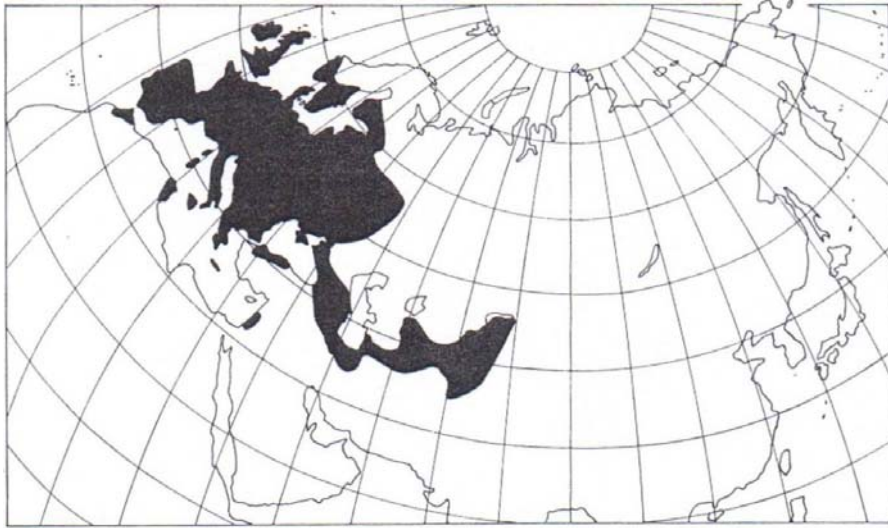

# *Pipistrellus pipistrellus* (Schreber, 1774)

- netopýr hvízdavý

# *Pipistrellus pygmaeus* (Leach, 1825)

- netopýr nejmenší

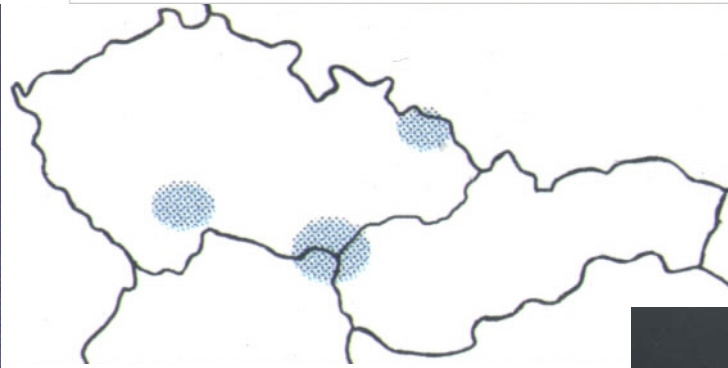
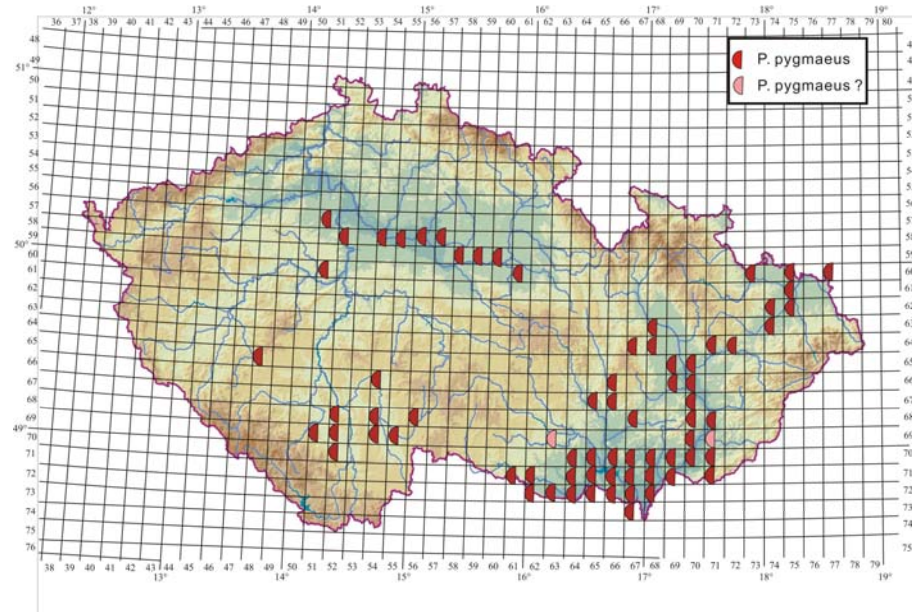
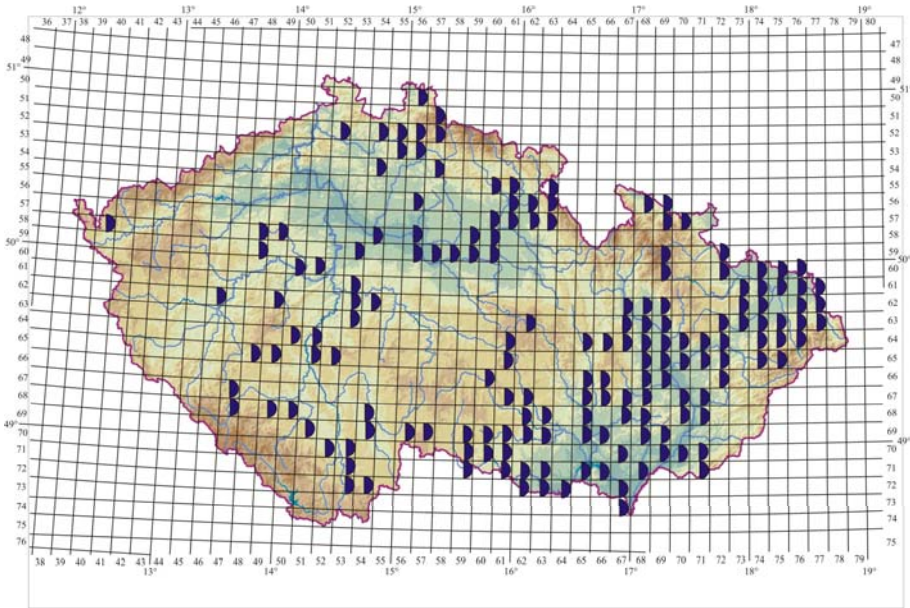

-, -, SO

DD, -, SO

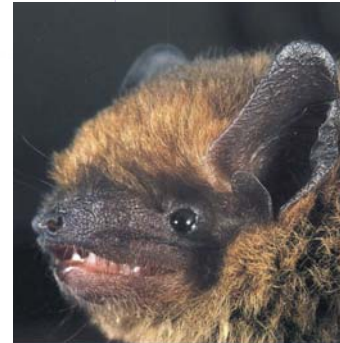

■ zóna allopatrie *P. pipistrellus*

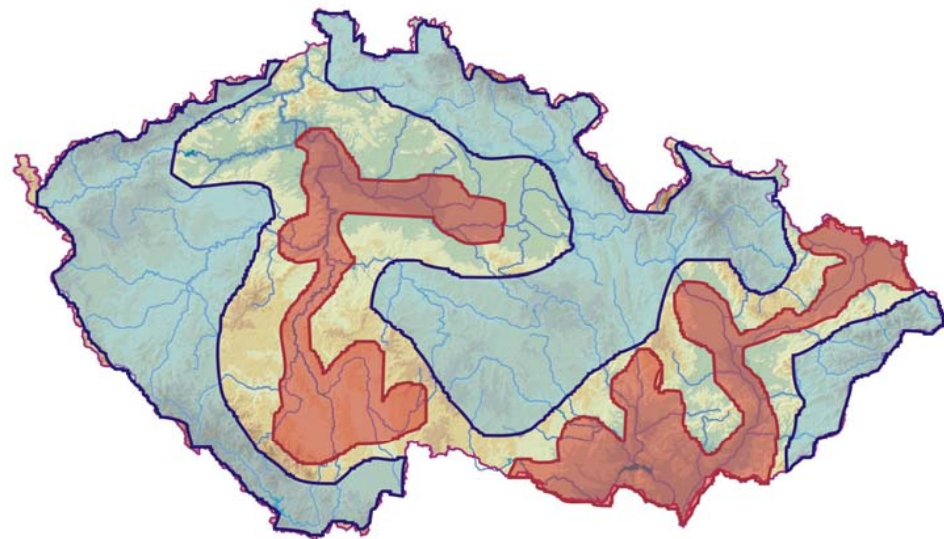

■ minimální zóna sympatrie

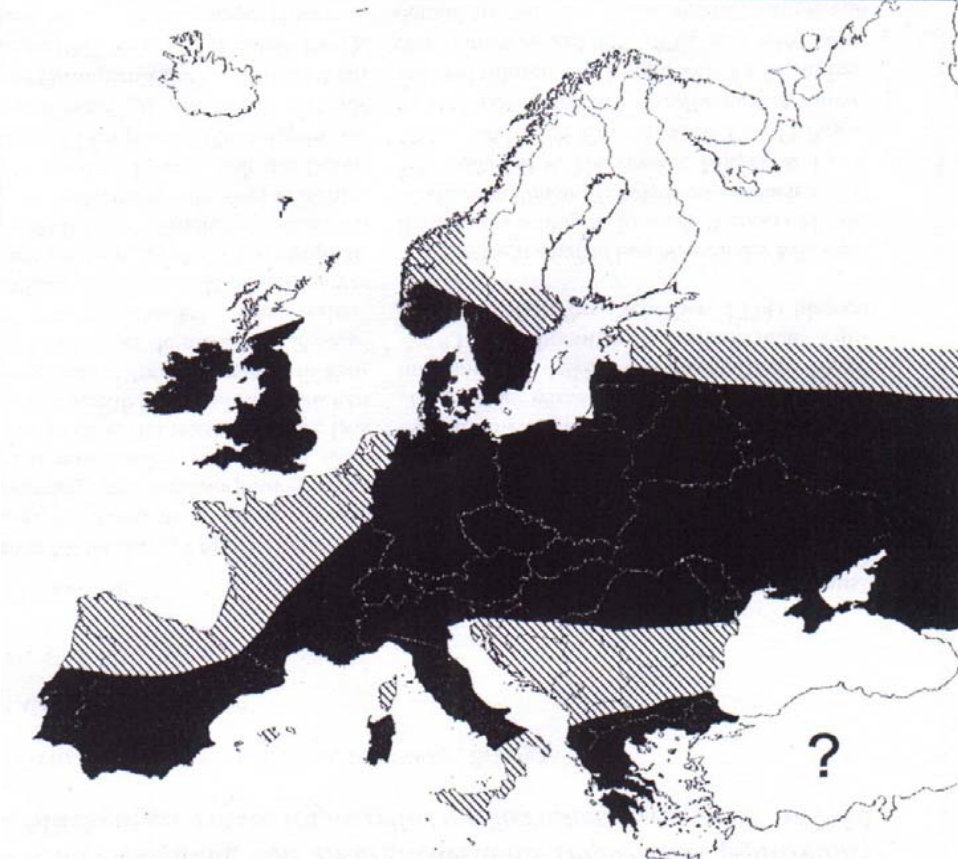

■ zóna sympatrie

▨ zóna allopatrie *P. pipistrellus* s.s.



# *Pipistrellus nathusii* (Keyserling et Blasius, 1839) – netopýr parkový

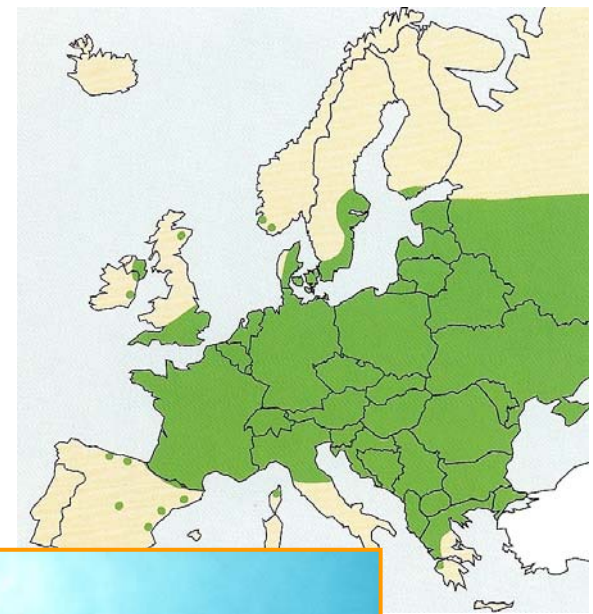
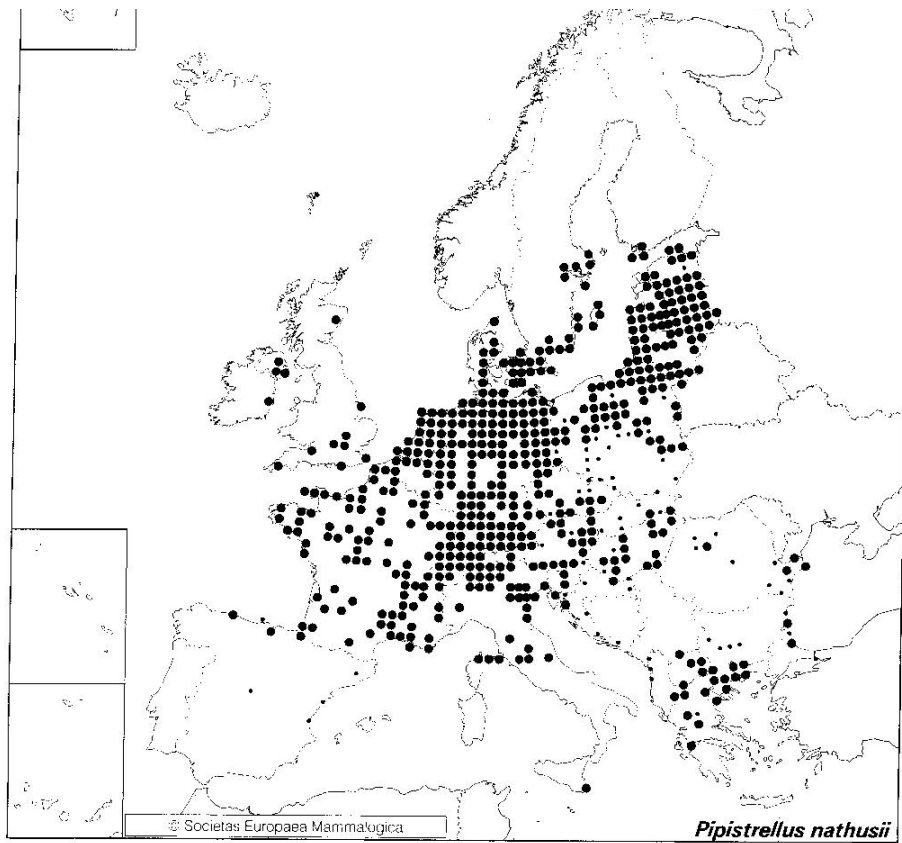

Literatura



DD, -, SO

*Pipistrellus kuhlii* (Kuhl, 1817)  
- netopýr jižní

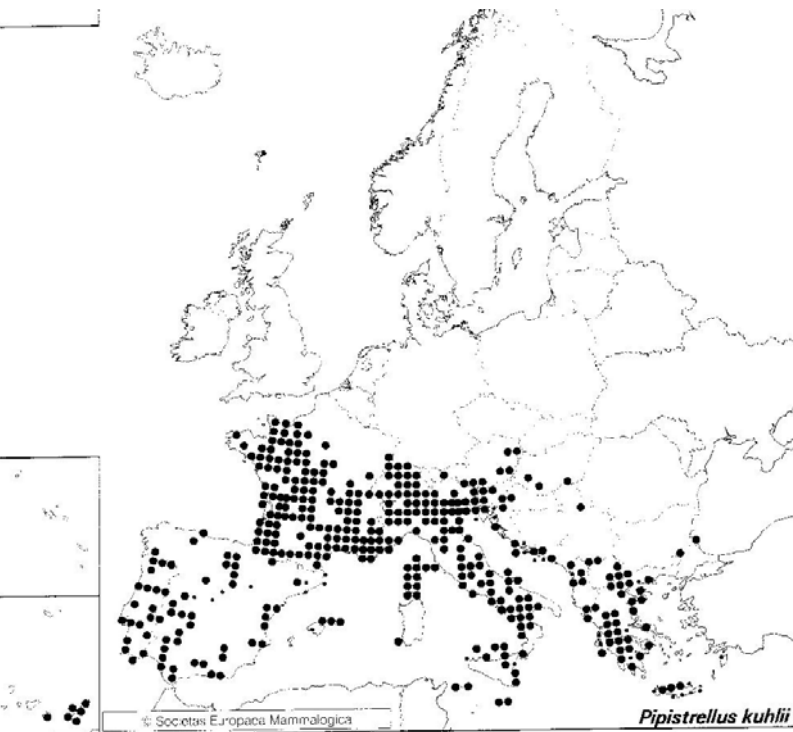

*Hypsugo savii* (Bonaparte, 1837) -  
netopýr Saviův

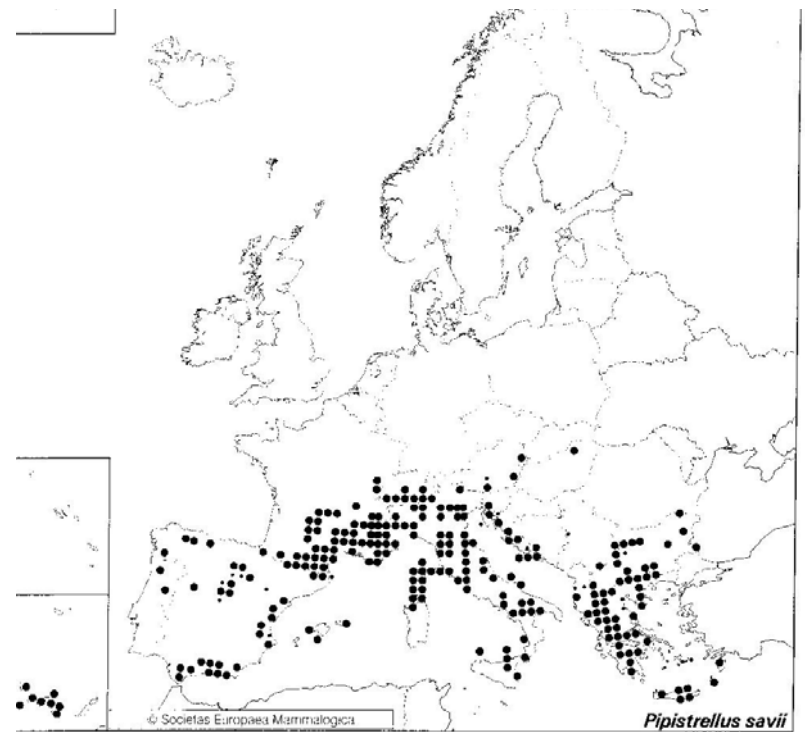

SR-2006 (r-2007)  
ČR-2007  
-, -, SO

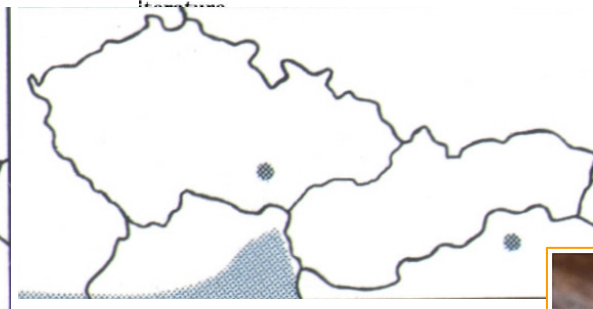

SR-2003 (r-2007)  
ČR-2001 (r-2006)  
DD, -, SO



*Plecotus auritus* (Linnaeus, 1758) -  
netopýr (vrásnič) ušatý

-, -, SO

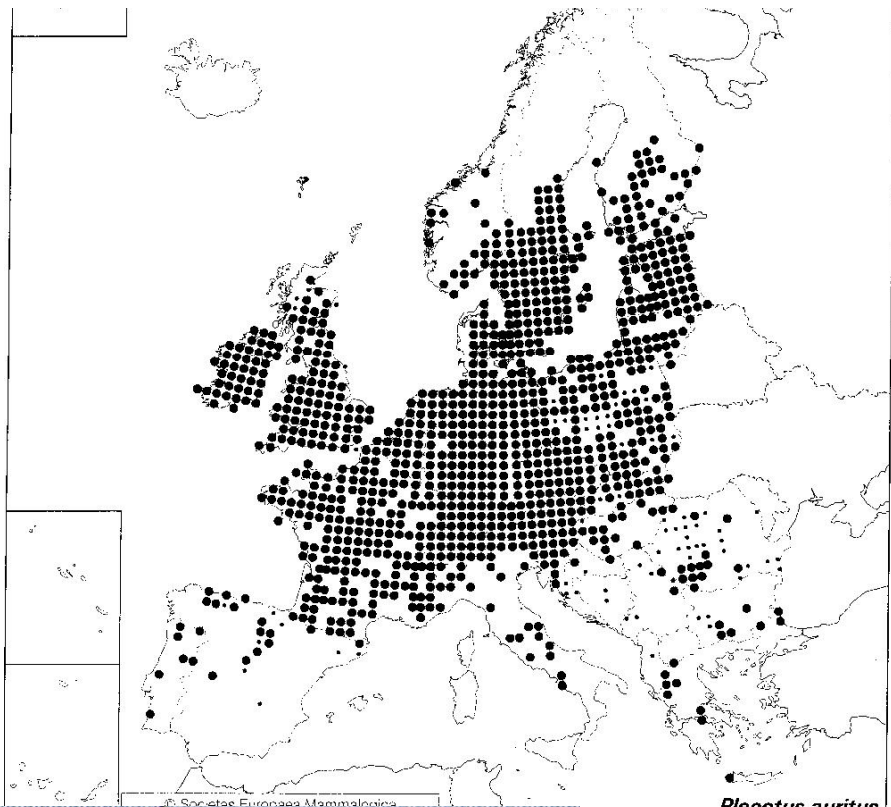
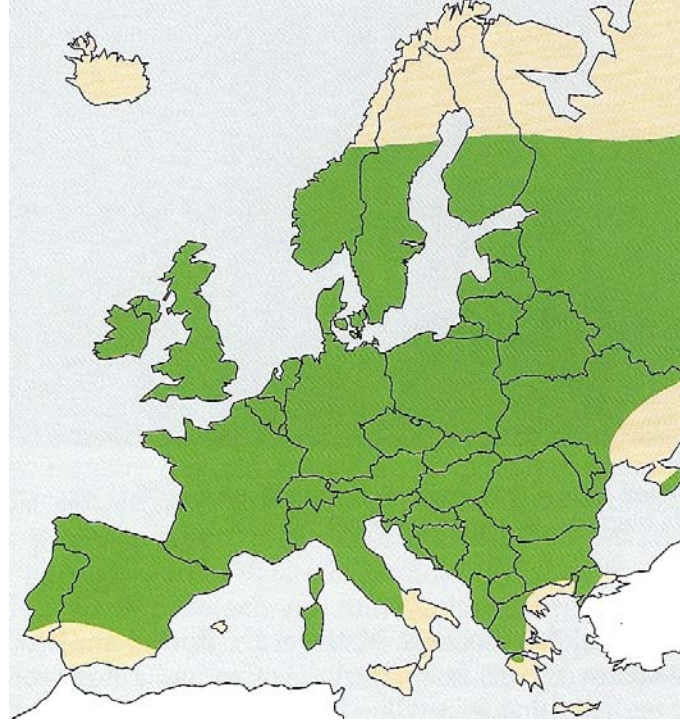

72%

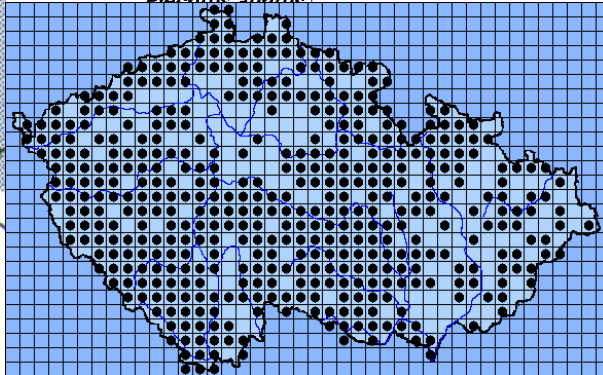

NABU S.H./T. Stephan

*Plecotus austriacus* (Fischer, 1829)

- netopýr (vrásnič) dlouhouchý

-, -, SO

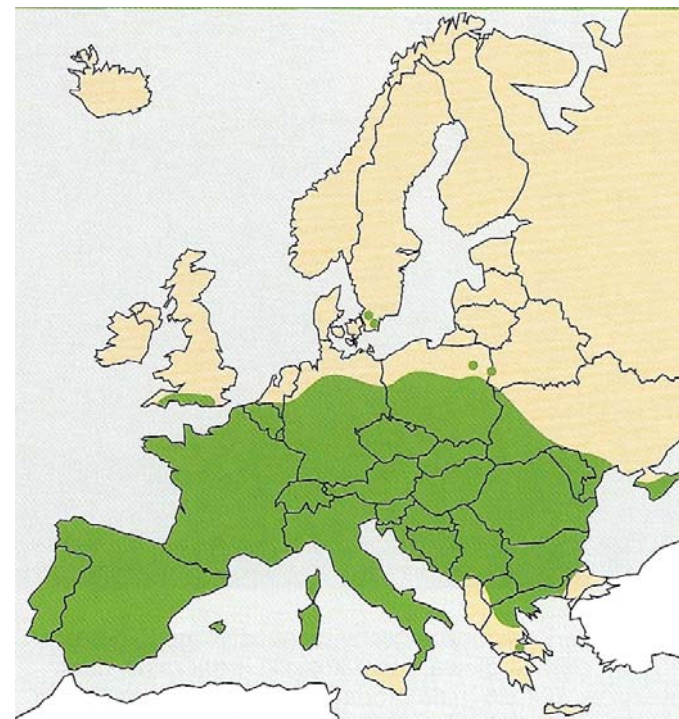
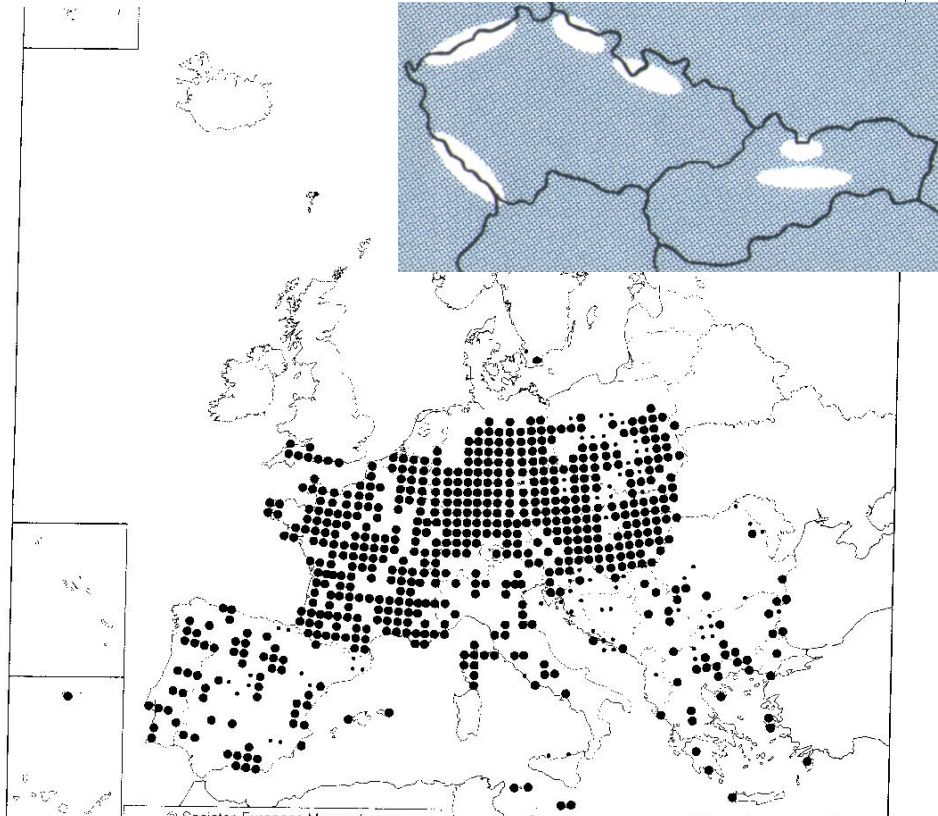

65%

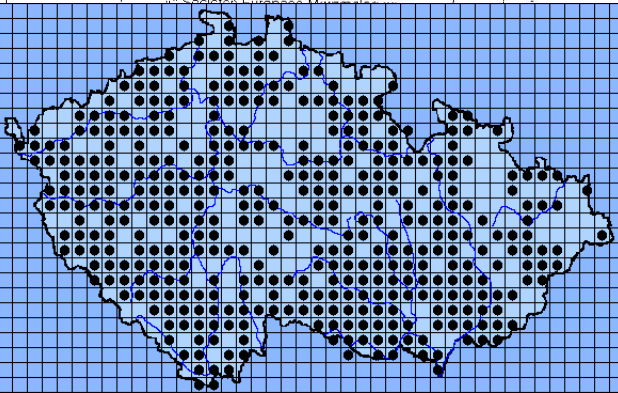

[www.naturfoto.cz](http://www.naturfoto.cz)

© Miloš Anděra

*Barbastella barbastellus* (Schreber, 1774) - -, NT, KO  
netopýr černý

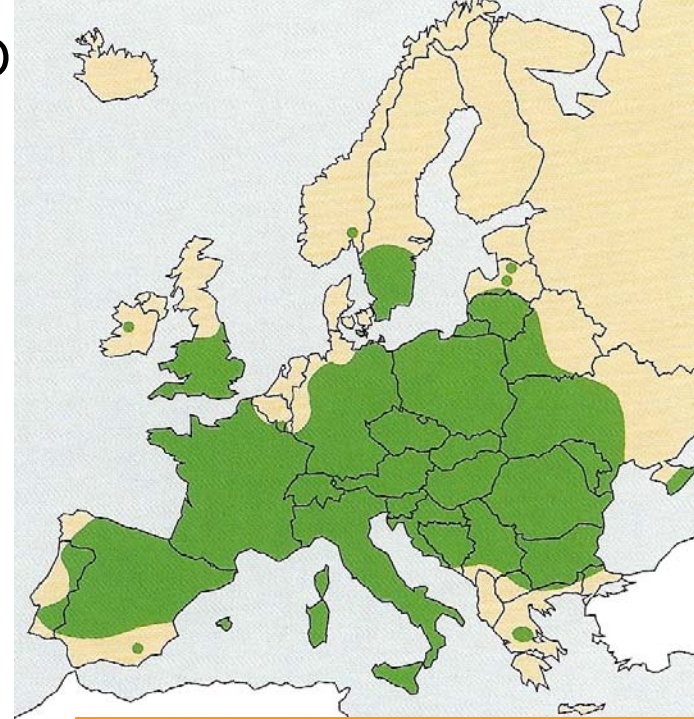
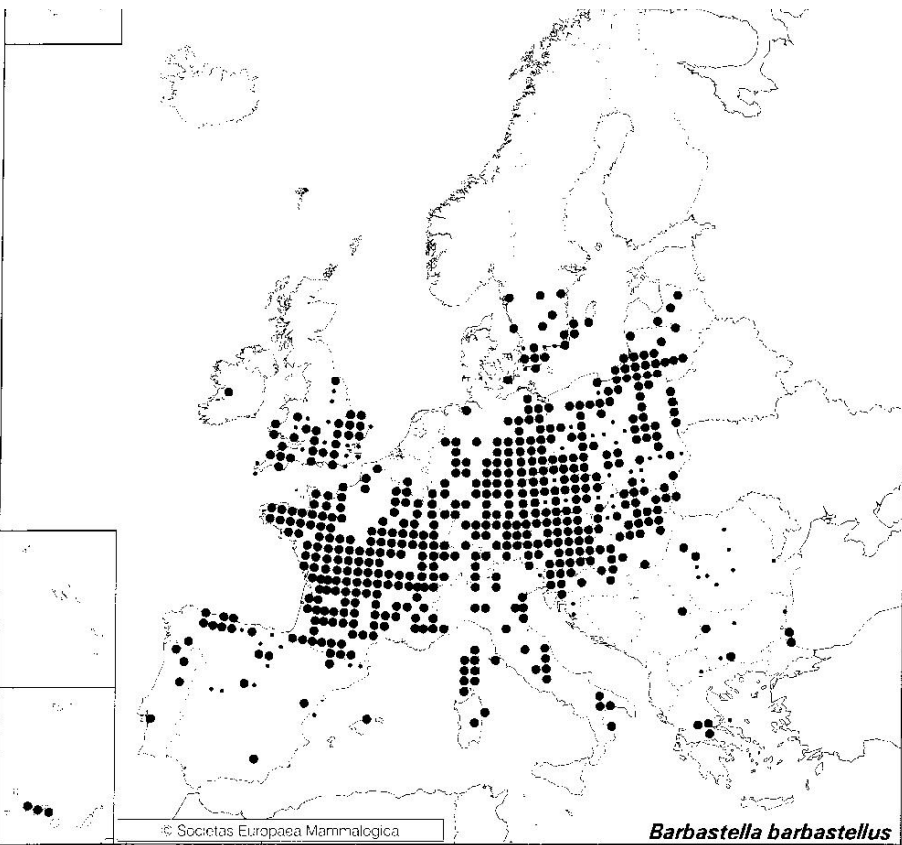

48%



NABU/K. Bogon

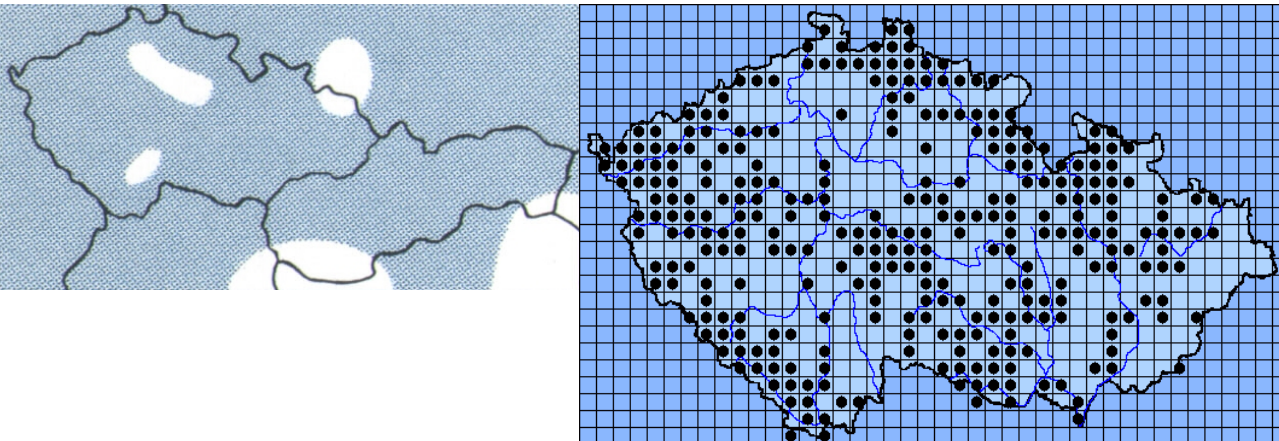

*Miniopterus schreibersii* (Kuhl, 1817) -  
létavec stěhovavý

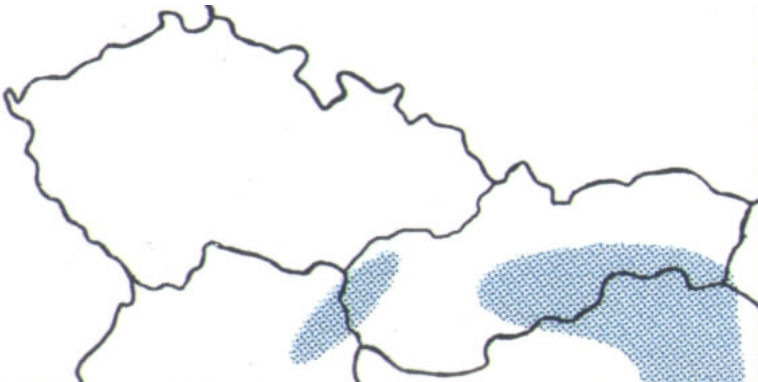
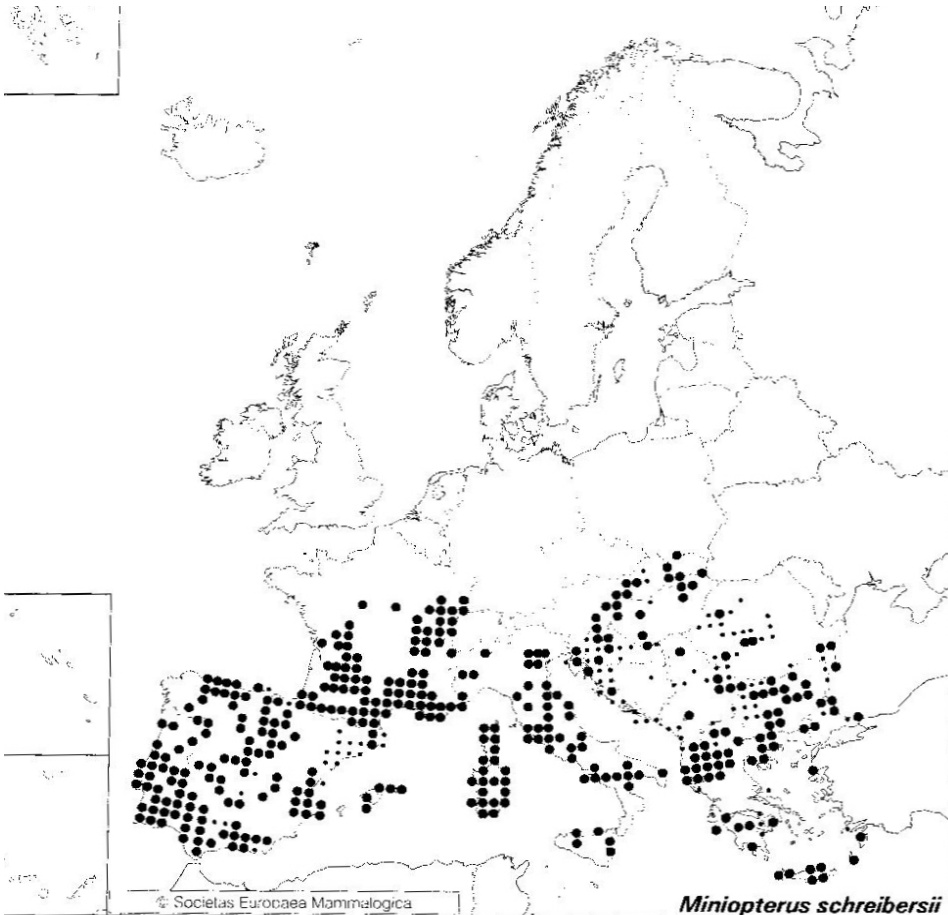

# Cetartiodactyla – sudokopytníci (+ kytovci)



## Ruminantia

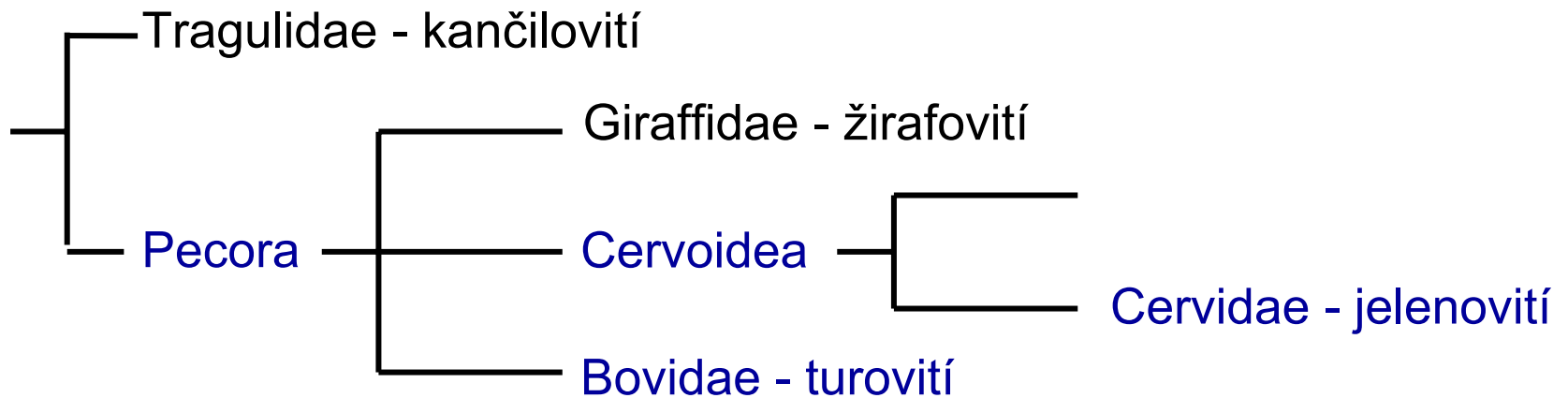

# Artiodactyla - sudokopytníci

## Suidae - prasatovití

*Sus scropha* Linnaeus, 1758 - prase divoké

## Corvidae - jelenovití

*Capreolus capreolus* (Linnaeus, 1758) - srnec obecný

*Alces alces* (Linnaeus, 1758) - los

*Odocoileus virginianus* (Zimmermann, 1780)

*Cervus elaphus* Linnaeus, 1758 - jelen lesní

*Cervus nippon* Temminck, 1838 - sika

*Dama dama* (Linnaeus, 1758) - daněk evropský

## Bovidae - turovití

*Capra aegagrus* Erxleben, 1777 - koza bezoárová

*Rupicapra rupicapra* (Linnaeus, 1758) - kamzík horský

*Ovis musimon* Pallas, 1811 - muflon

*Ammotragus lervia* (Pallas, 1777) - paovce hřivnatá

*Bison bonasus* (Linnaeus, 1758) - zubr



# *Sus scropha* Linnaeus, 1758

- prase divoké



- , - , -

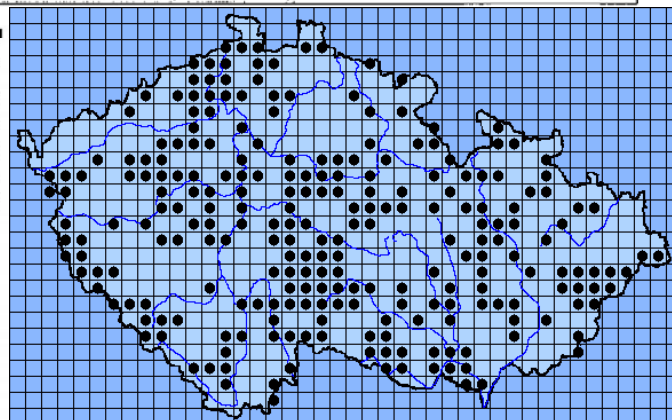
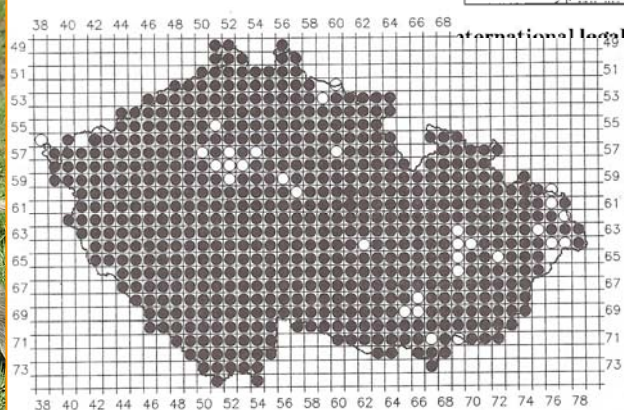
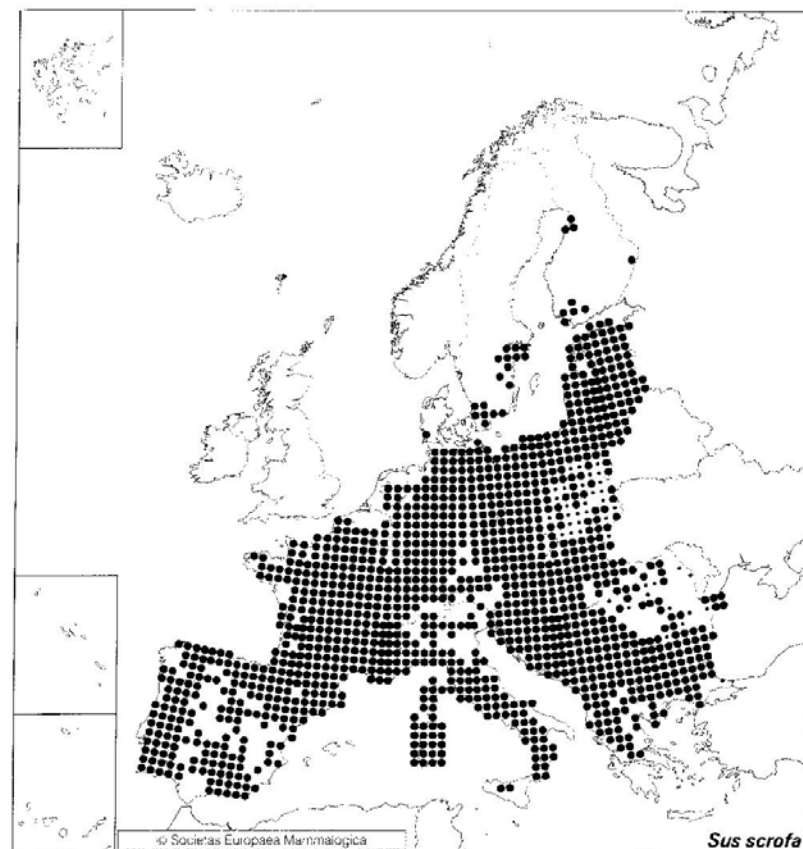

39 %

1801 – posl. Zástřel u Hluboké, od 1945-1952 šíření z Německa, Polska a Slovenska, dnes všude

*Capreolus capreolus* (Linnaeus, 1758) - srnec obecný



© - josef hlasek  
www.hlasek.com  
*Capreolus capreolus* aa3029

-, -, -

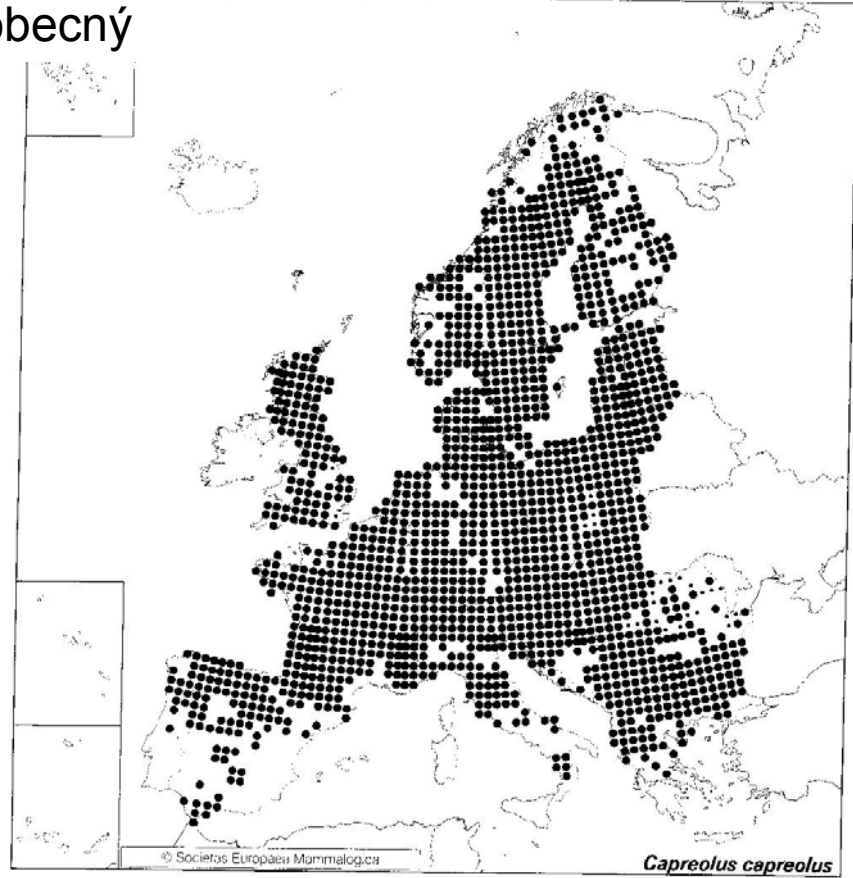

© Societas Europaea Mammalogica

*Capreolus capreolus*

250 000 ČR, 80 000 SR

85 %

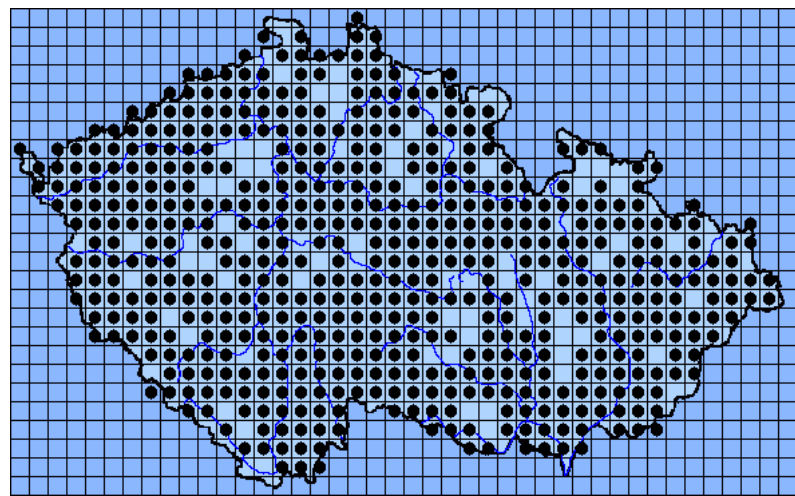
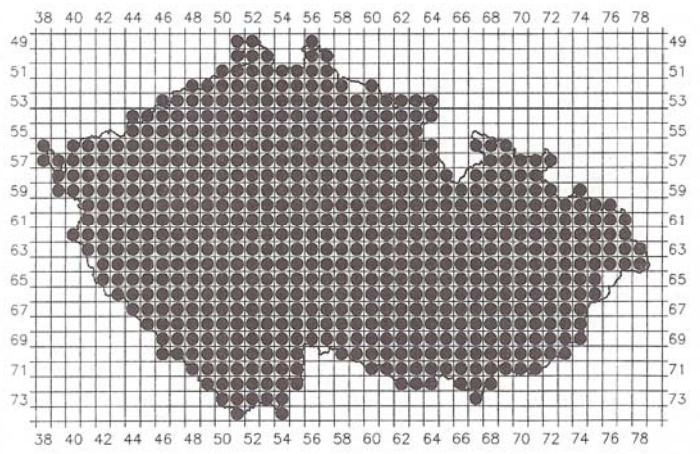

# *Alces alces* (Linnaeus, 1758) - los



© - josef hlasek  
www.hlasek.com  
*Alces alces* 6630

EN, -, SO

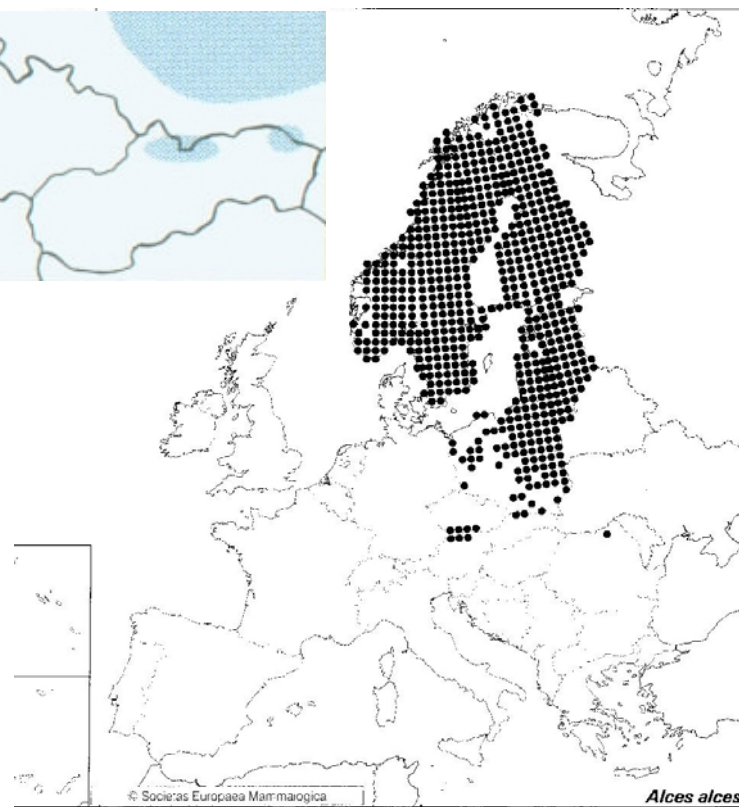

V ČR vyhuben mezi 12.-15. stol., introdukce v Polsku, odsud šíření ve 2. pol. 20. stol. na jih, V ČR 50 losů, v SR asi 10. Lipenská přehrada, Třeboňsko, 1974 JH – 1. mládě, v SR – Orava a SV, vlhké lesní nížiny.

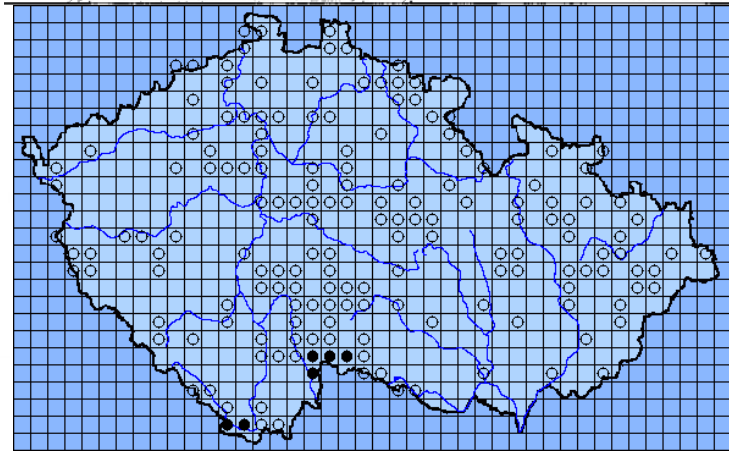
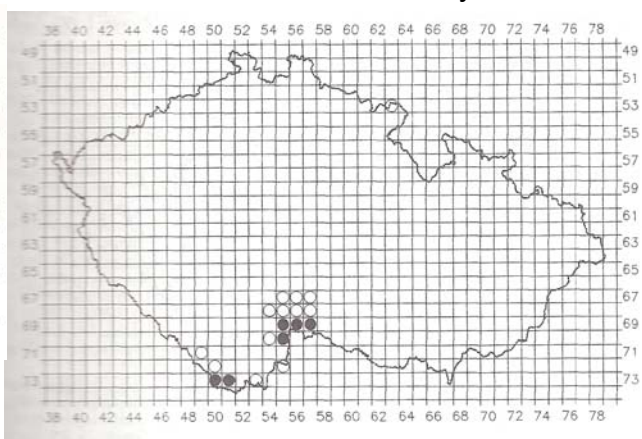
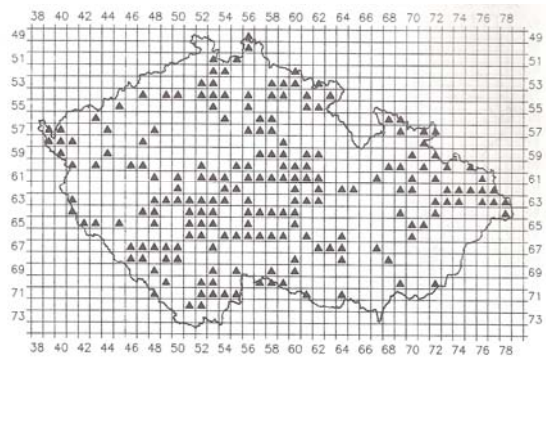

1 %

# *Odocoileus virginianus* (Zimmermann, 1780)

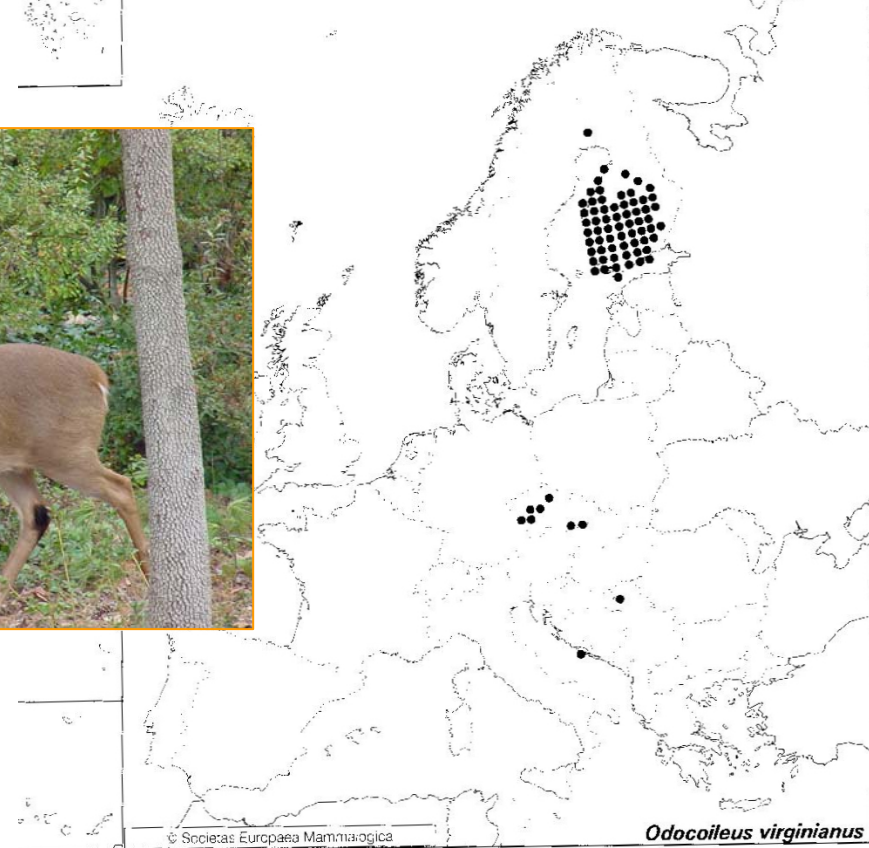

4 %

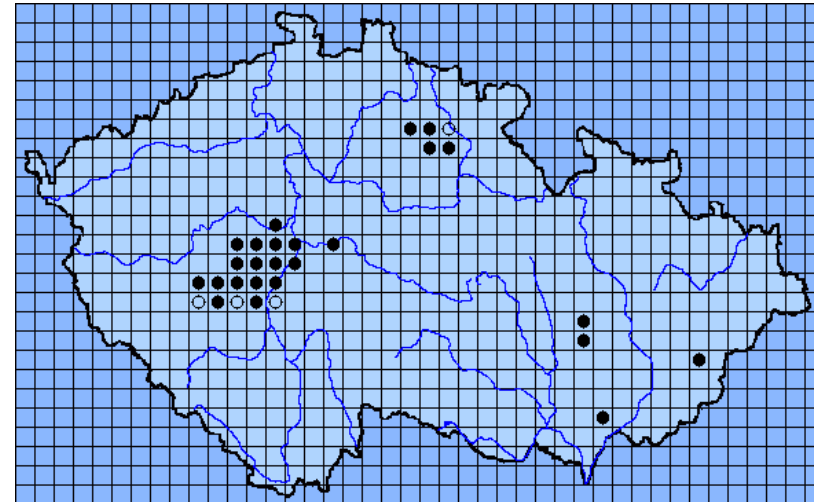

Obora Opočno 1884, Královská obora u Dobříše 1893,  
další importy ve 20.stol., i na Moravu, velká populace  
Brdy, SV Čechy, asi 200 ks v ČR

# *Cervus elaphus* Linnaeus, 1758 - jelen lesní

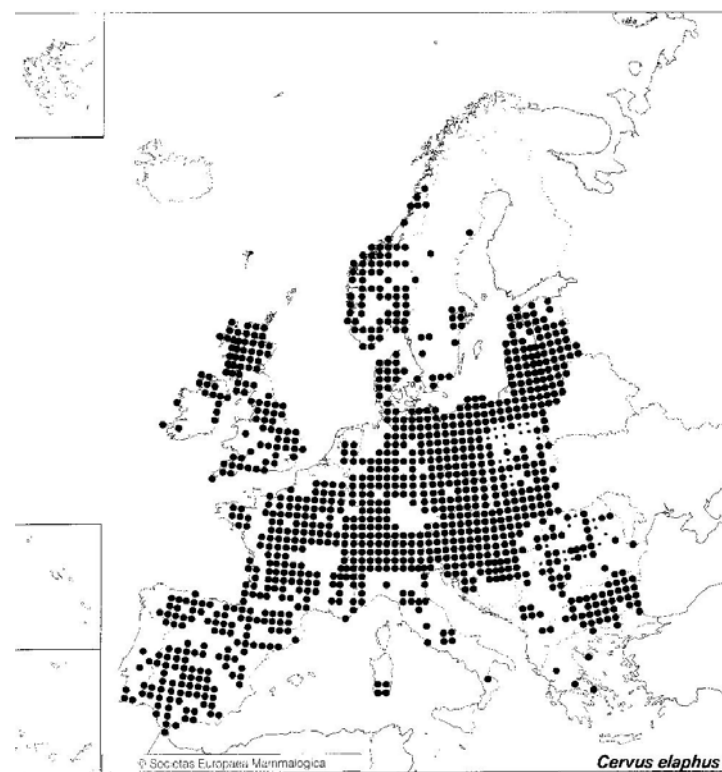

Šlechta, lesní správy a myslivecká sdružení, pův. lesostepní druh, dnes střední a vyšší polohy, výskyt druhotný, 30000 jelenů v ČR, i v SR, zástřel 50 % stavu, jelen západní – jelen karpatský

27 %

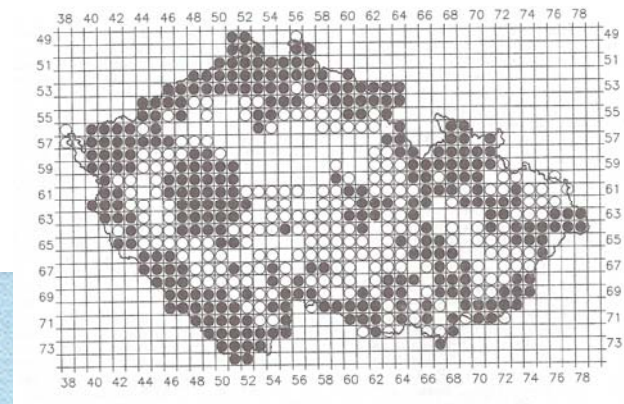
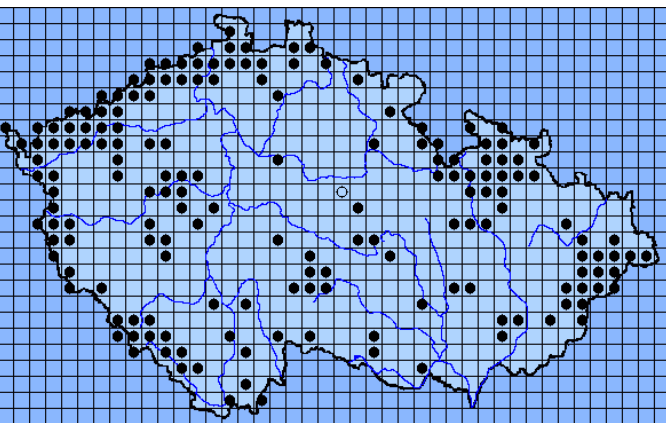

# *Cervus nippon* Temminck, 1838 - sika

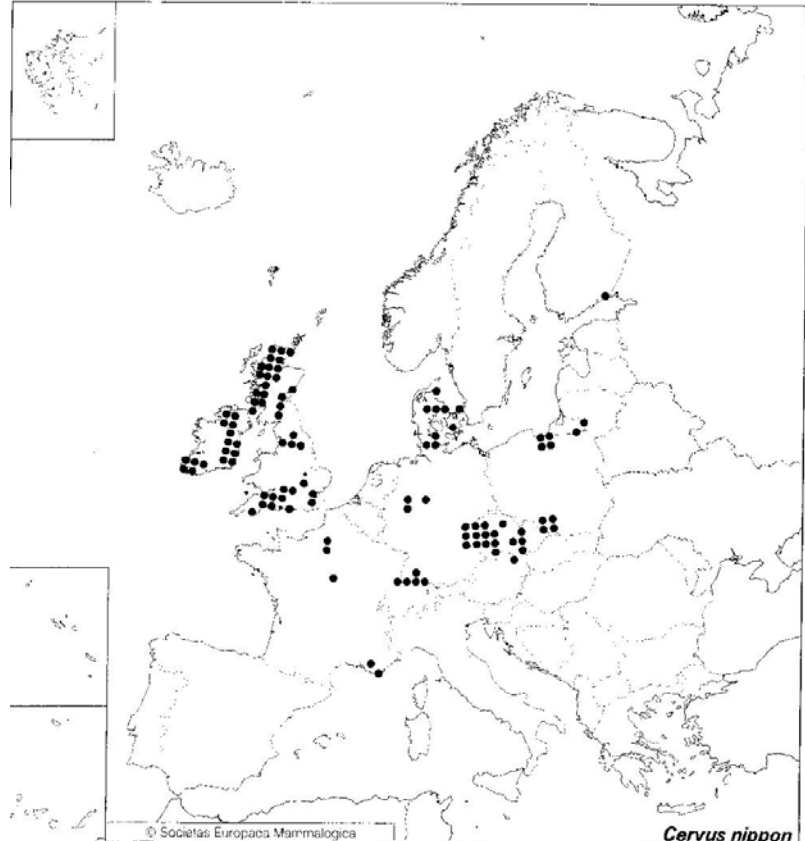

Původ V Asie, Poděbradsko 1890, nejvíce dnes Z Čechy, lesy parkového typu, zámecké obory

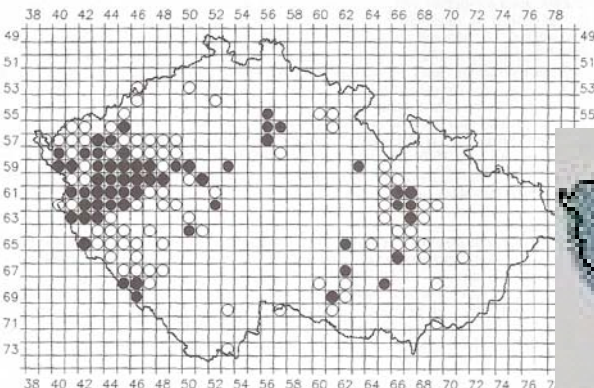

6 %

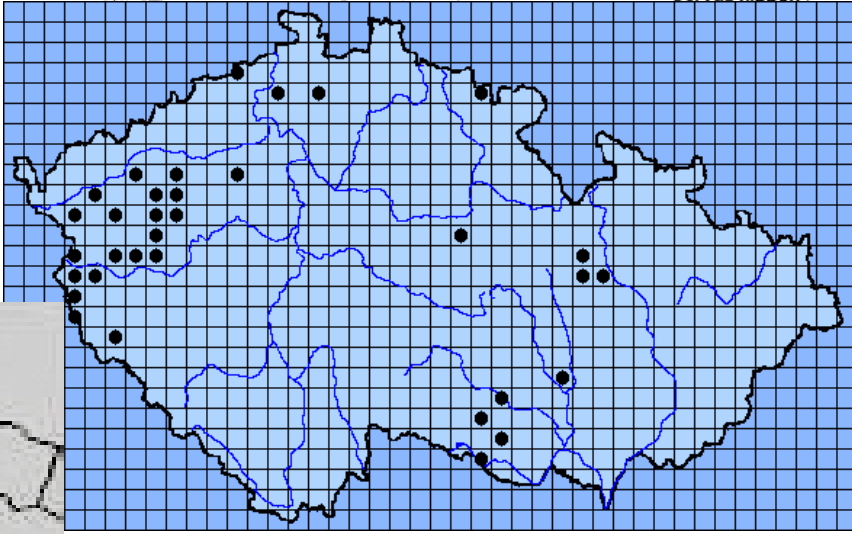
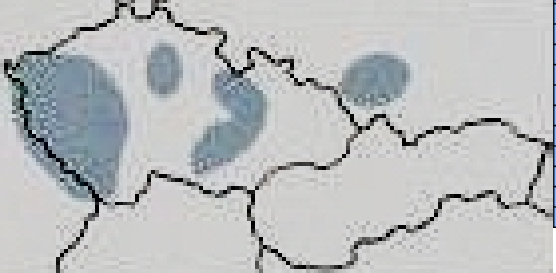

# *Cervus dama* (Linnaeus, 1758) - daněk evropský

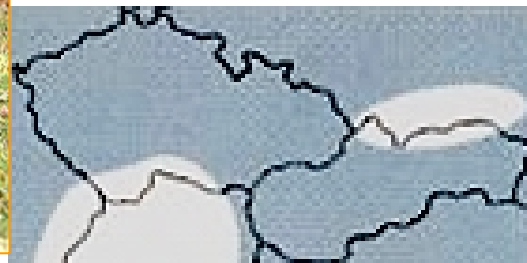
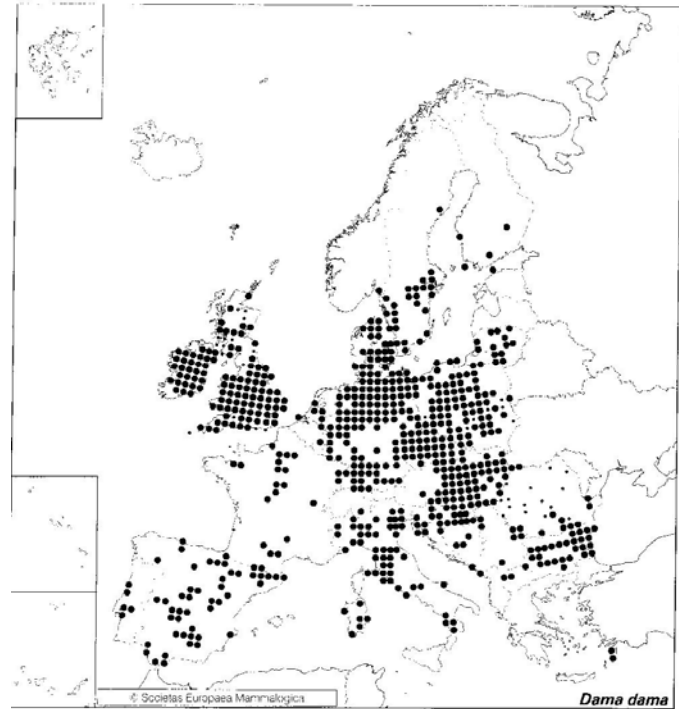

13 %

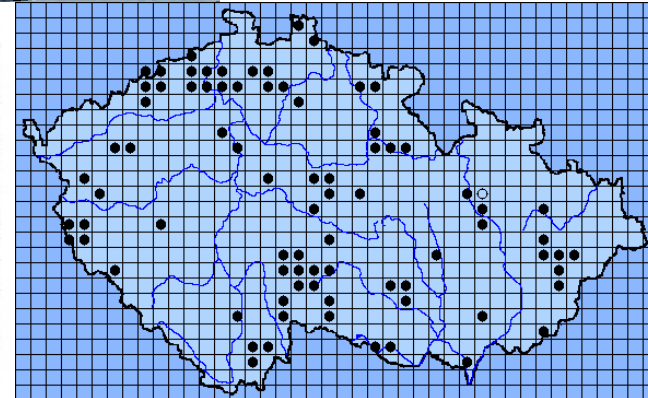
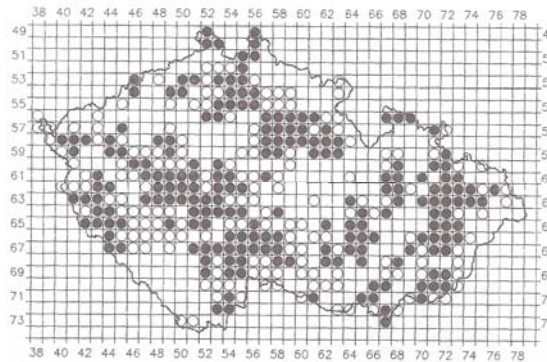

1465 – Vyškovsko, ze Z mediteránu, od 1548 KO ve Stromovce, 11 000 ks v ČR, 500 SR

*Rupicapra rupicapra* (Linnaeus, 1758) - kamzík horský

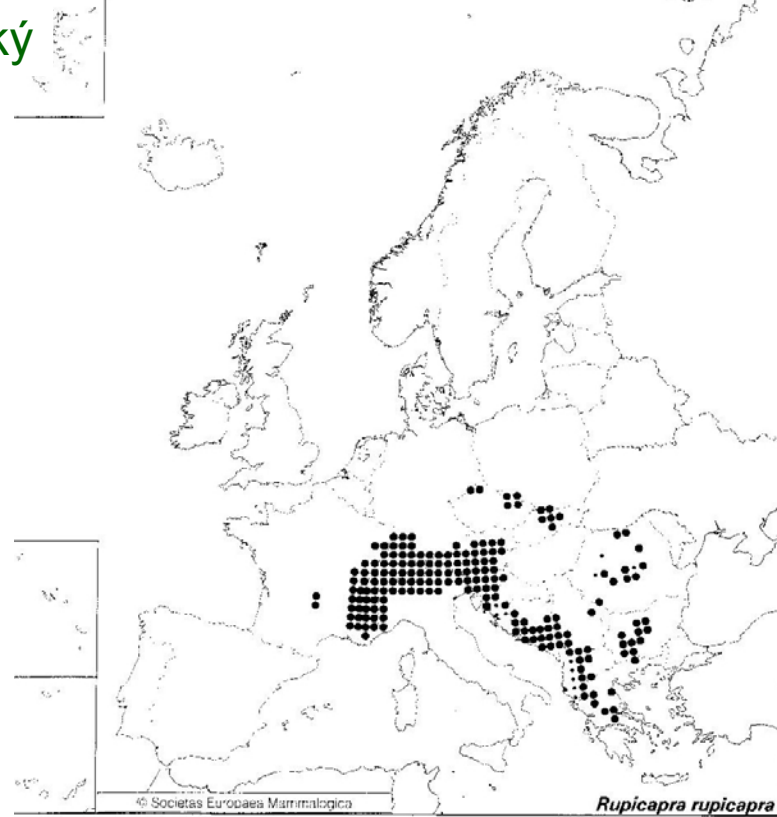

Lužické hory, Hrubý Jeseník v ČR

13 %

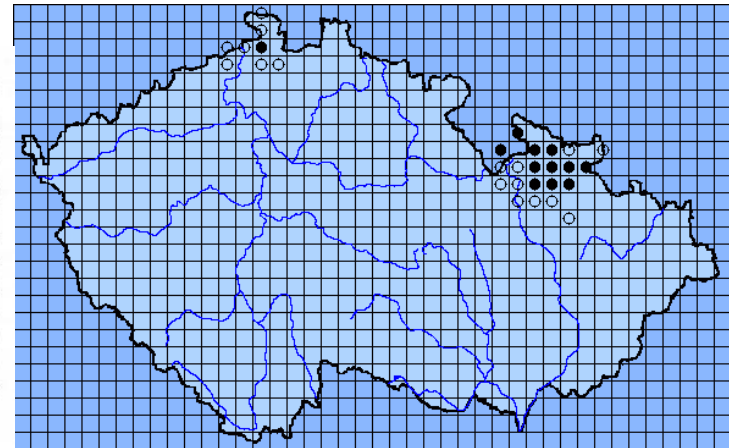
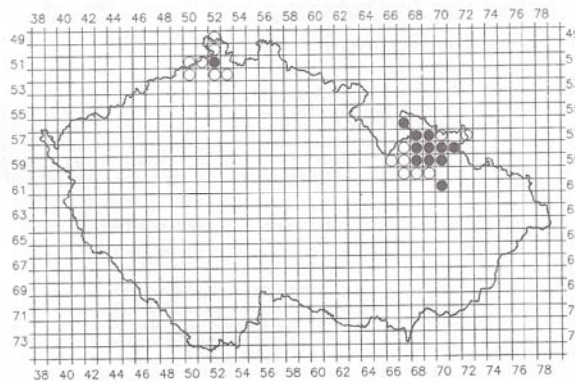



# *Ovis musimon* Pallas, 1811 - muflon



Domácí zvíře ze Sardinie a Korsiky, k nám v  
1. pol. 19 stol. Hluboká, resp. Trábeč)

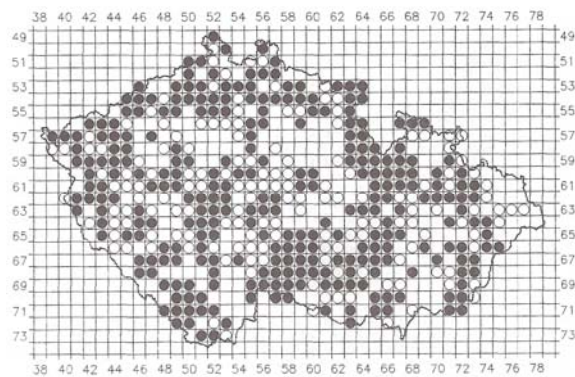

45 %

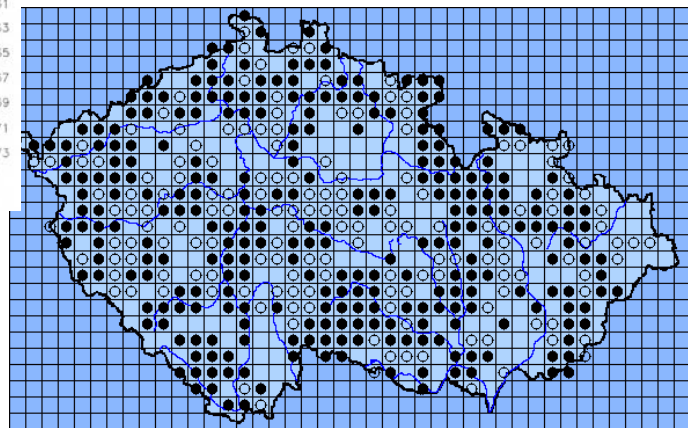
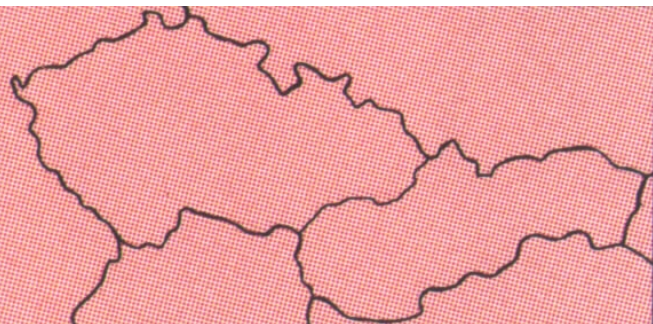

# *Ammotragus lervia* (Pallas, 1777) - paovce hřivnatá



Severní Afrika, 1980 únik z plzeňské Zoo

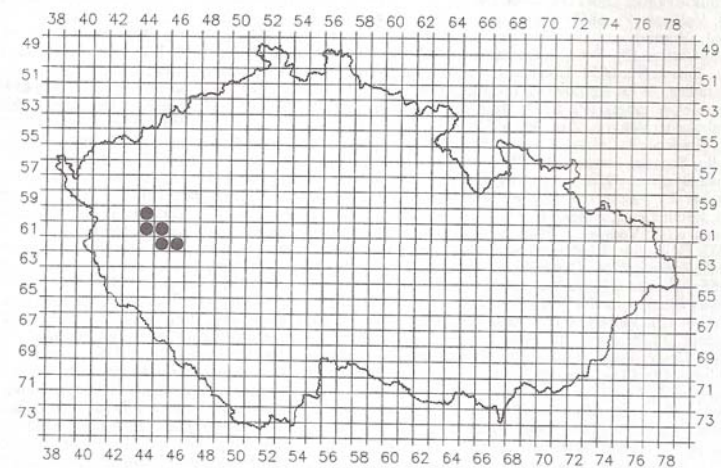

# *Capra aegagrus* Erxleben, 1777 - koza bezoárová



Přední Asie a V Mediterán, 1953-1967 introdukce ze zoo Praha a Brno na Děvín (Pálava), od 1994 obora Vřísek u Zahrádek na Českolipsku

*Bison bonasus* (Linnaeus, 1758) - zubr

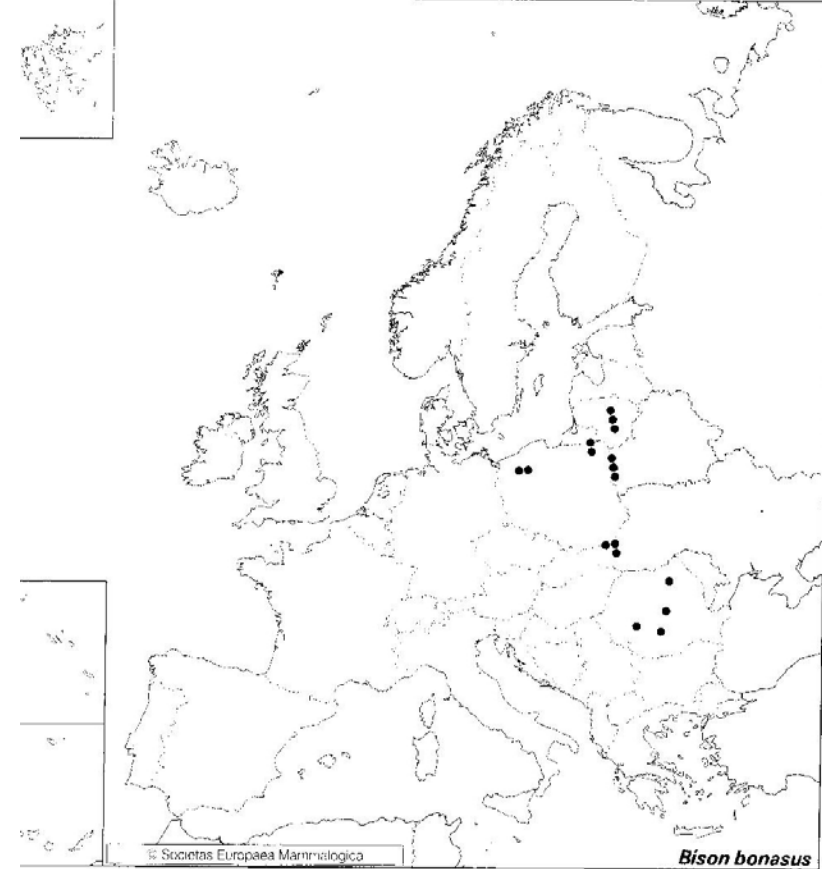

RE, EN , -

Introdukce po r. 2000 – Starina – V Karpaty (Bukovské vrchy)



# Carnivora - šelmy

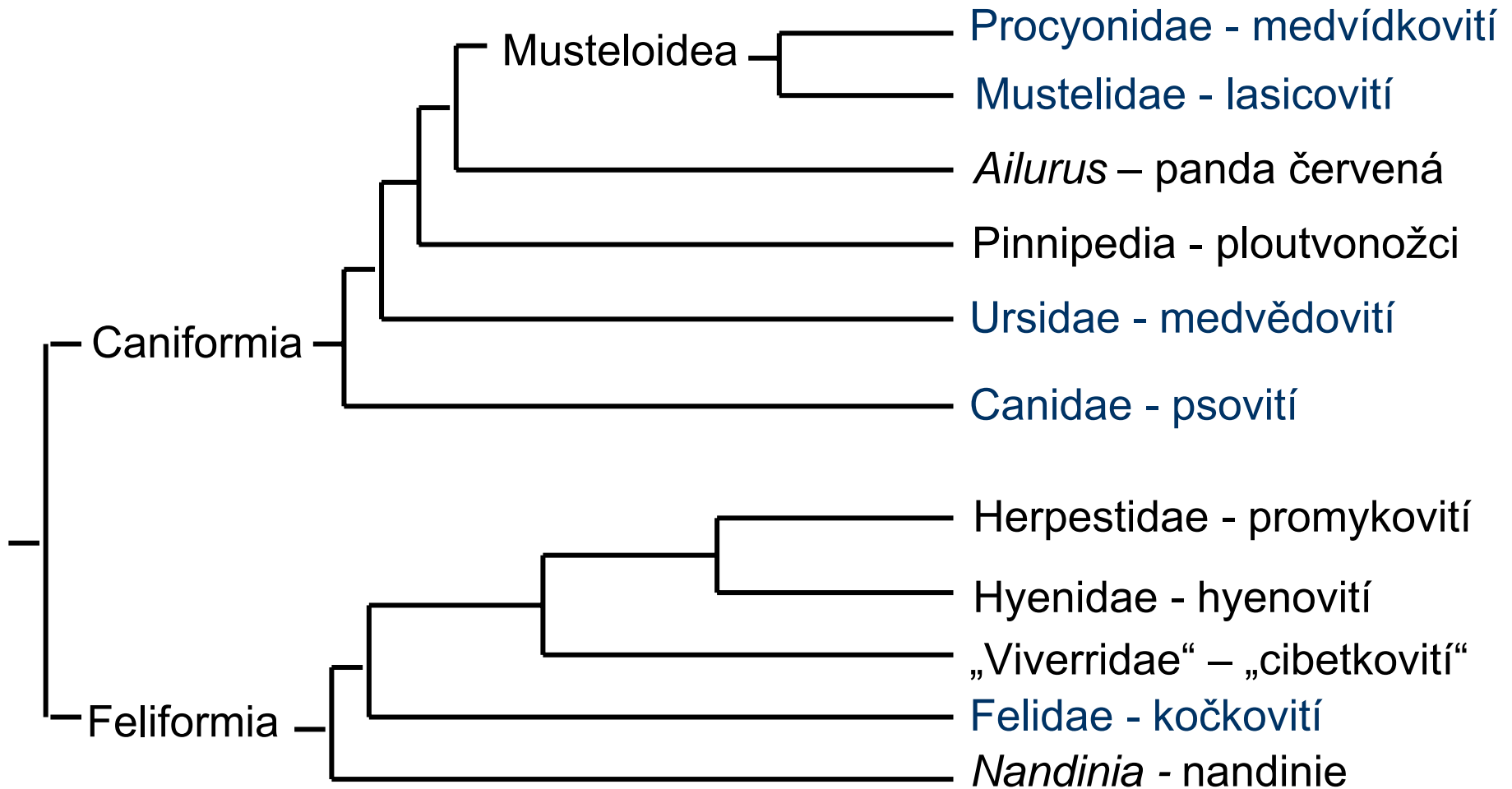

## Procyonidae - medvídkovití

*Procyon lotor* (Linnaeus, 1758) - mýval severní

## Mustelidae - lasicovití

*Mustela nivalis* Linnaeus, 1766 - kolčava

*Mustela erminea* Linnaeus, 1758 - hranostaj

*Mustela lutreola* (Linnaeus, 1761) - norek evropský

*Mustela vison* Schreber, 1777 - norek americký (mink)

*Mustela putorius* Linnaeus, 1758 - tchoř tmavý

*Mustela eversmannii* Lesson, 1827 - tchoř stepní

*Martes martes* (Linnaeus, 1758) – kuna lesní

*Martes foina* (Erxleben 1774) – kuna skalní

*Meles meles* (Linnaeus, 1758) - jezevec lesní

*Lutra lutra* (Linnaeus, 1758) - vydra říční

## Ursidae - medvědovití

*Ursus arctos* Linnaeus, 1758 - medvěd hnědý

## Canidae - psovití

*Canis lupus* Linnaeus, 1758 - vlk obecný

*Canis aureus* Linnaeus, 1758 - šakal obecný

*Nyctereutes procyonoides* (Gray, 1834) - psík mývalovitý

*Vulpes vulpes* (Linnaeus, 1758) - liška obecná

## **Felidae - kočkovití**

*Felis silvestris* Schreber, 1775 - kočka divoká

*Lynx lynx* (Linnaeus, 1758) - rys ostrovid

# *Procyon lotor* (Linnaeus, 1758) - mýval severní

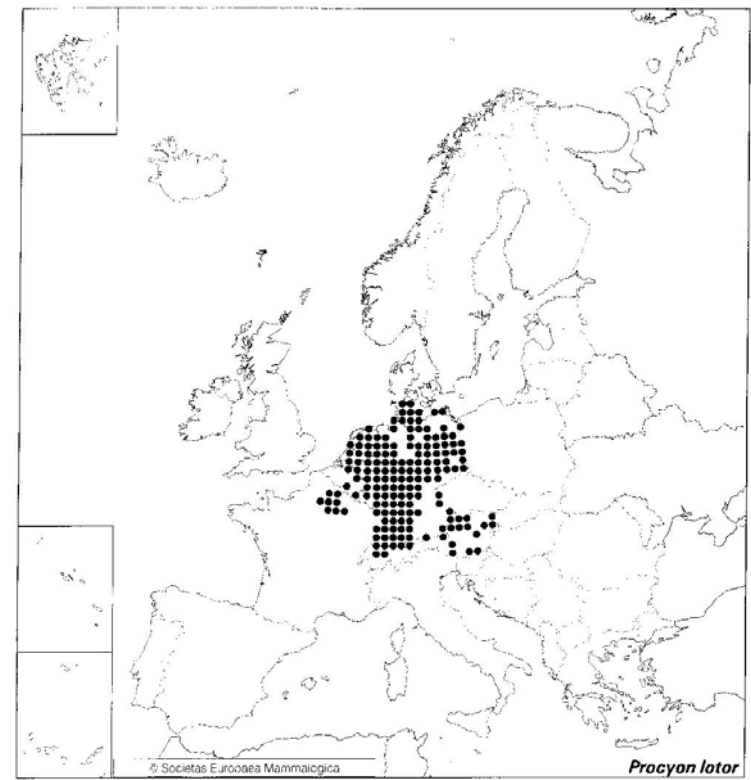

Duclos et al. (1972)

5 %

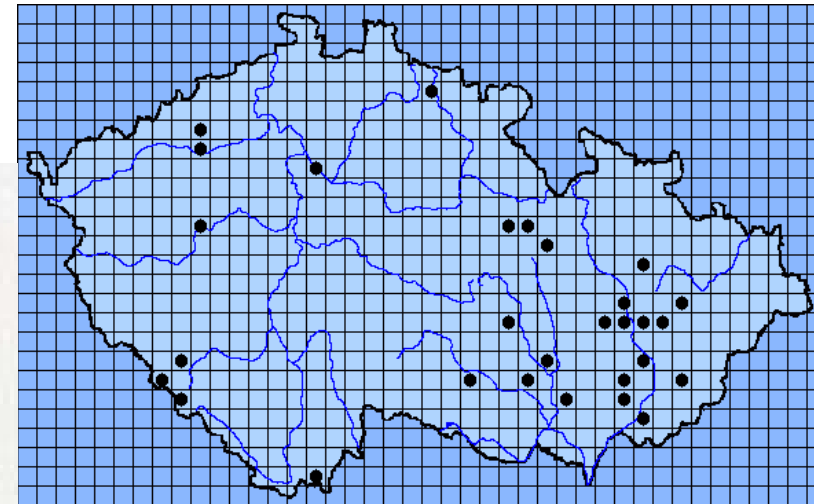
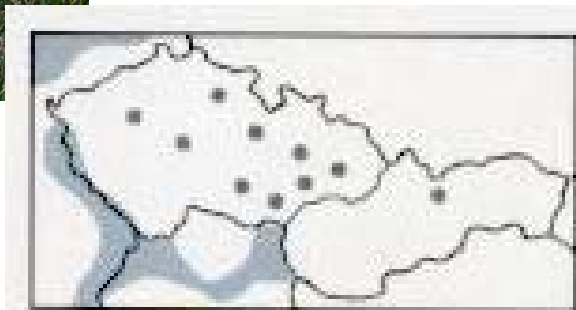



# *Mustela nivalis* Linnaeus, 1766

## - kolčava



- , - , -

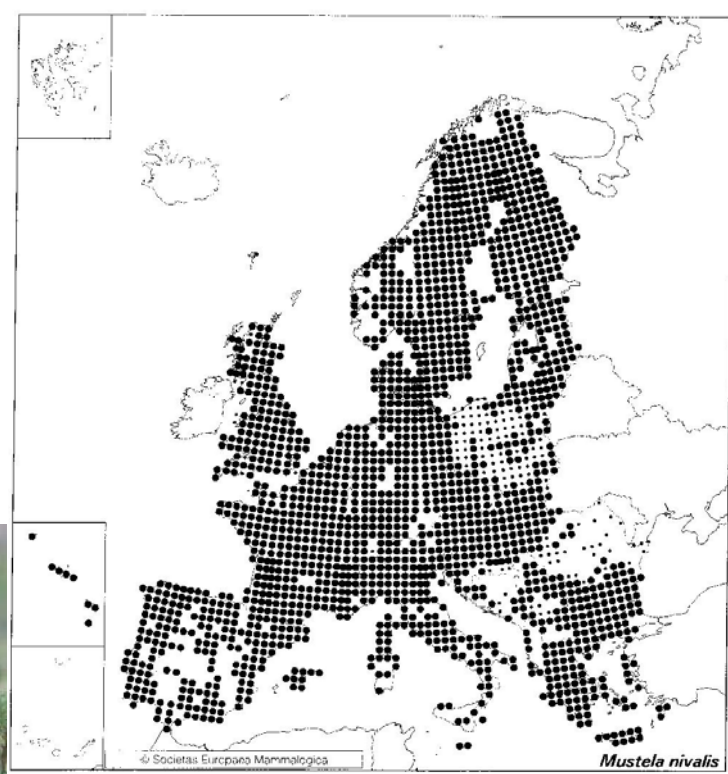

Stubbh & Stubbh (1998)

51 %

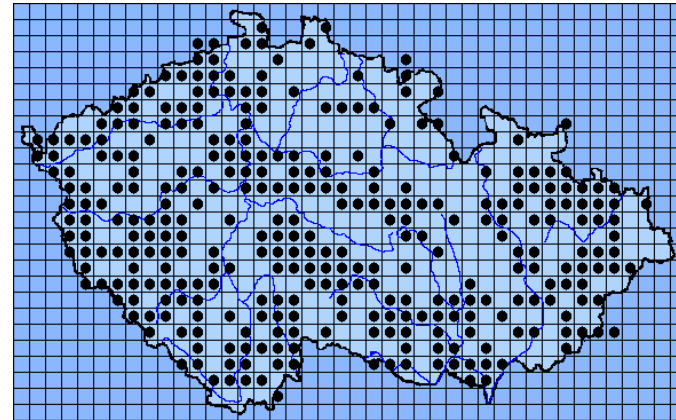
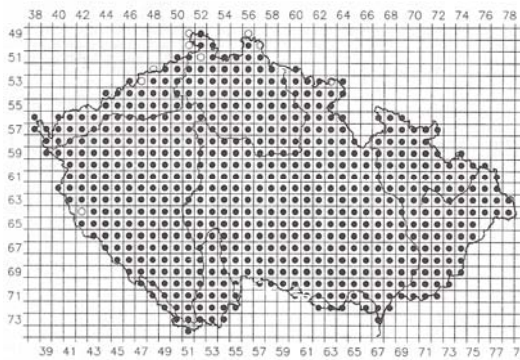
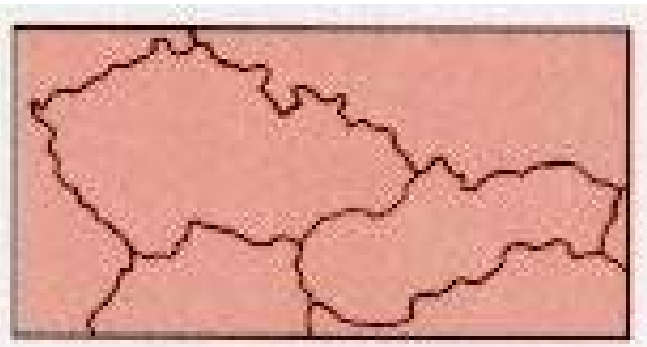

# *Mustela erminea* Linnaeus, 1758

- hranostaj

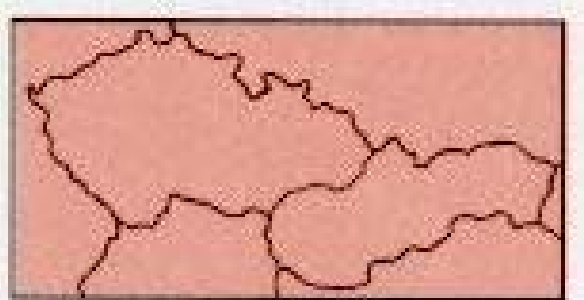
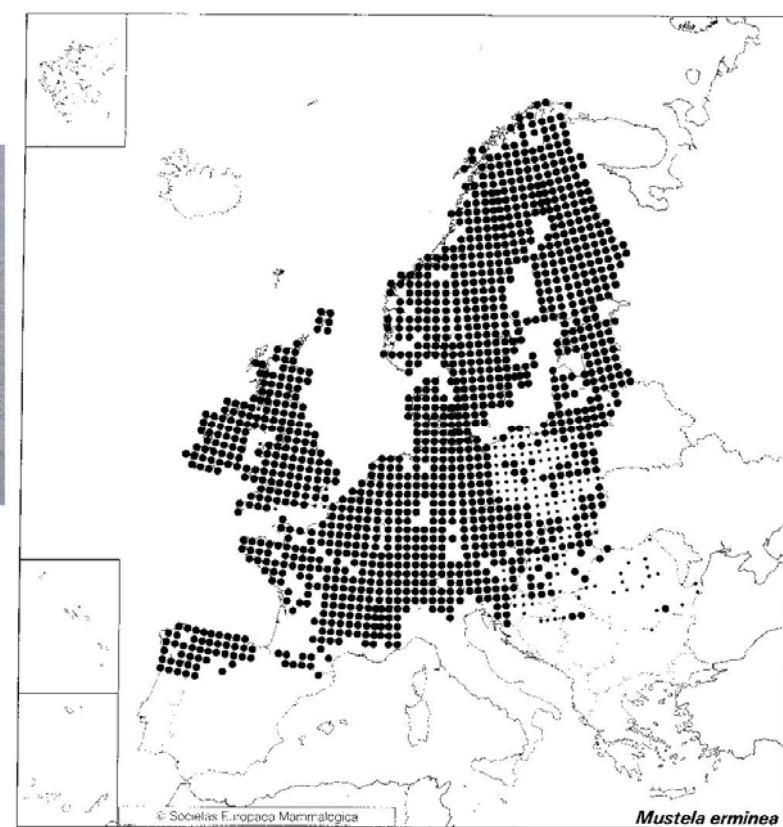

-, -, -

38 %

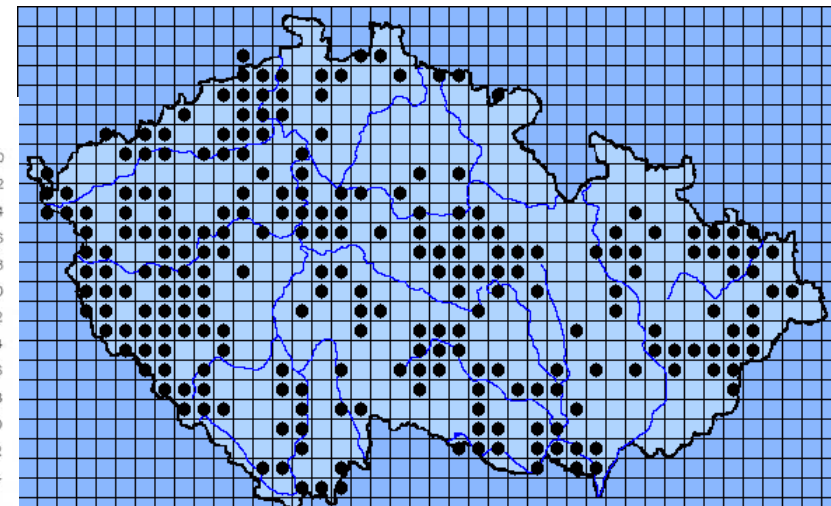
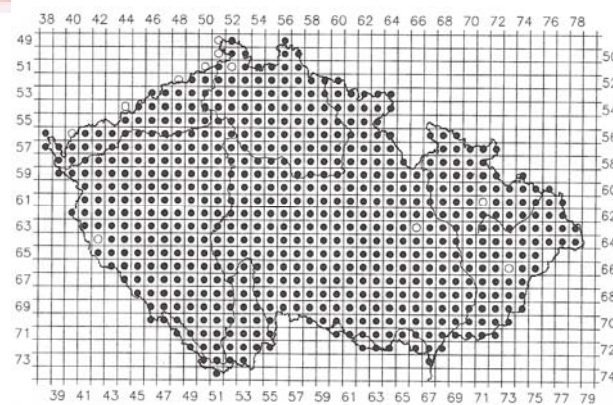

*Mustela lutreola* (Linnaeus, 1761) - norek evropský



RE, EN, -

*Mustela vison* Schreber, 1777 - norek americký (mink)



-, -, -

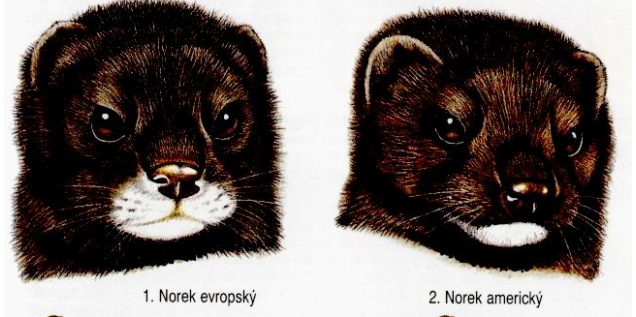

18 %

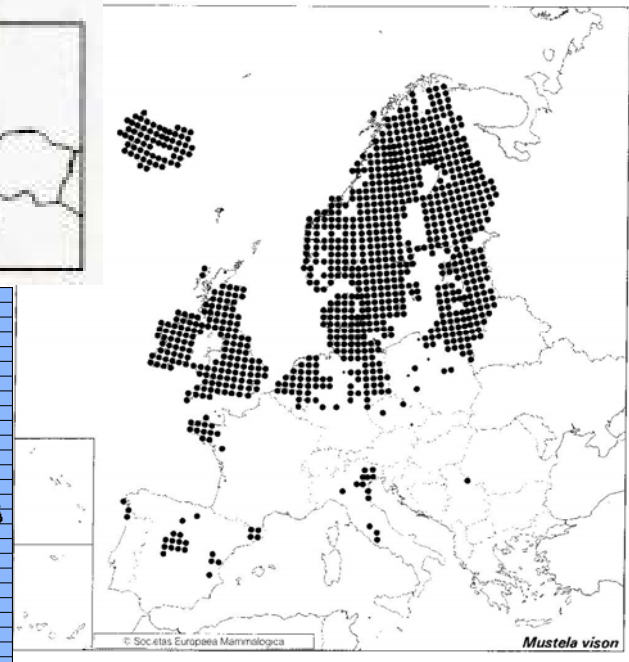
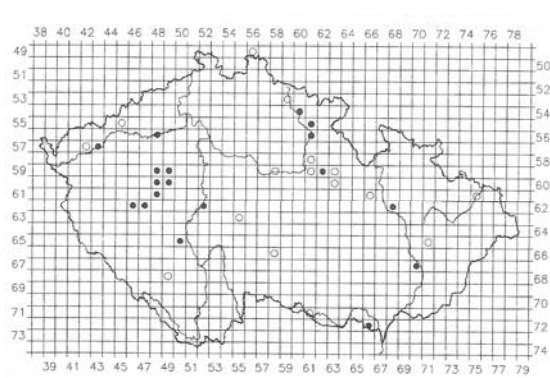
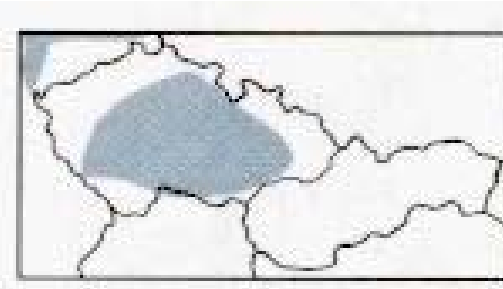

*Mustela putorius* Linnaeus, 1758 - tchoř tmavý

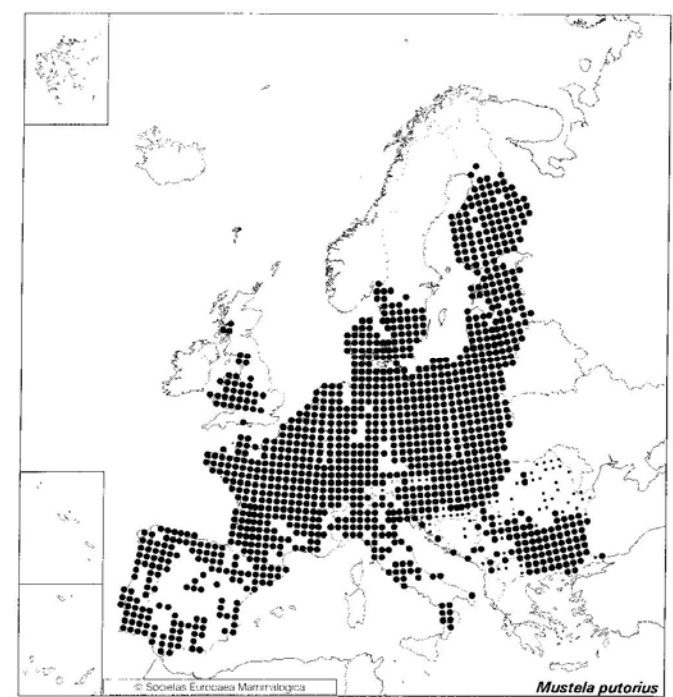

*Mustela eversmannii* Lesson, 1827 - tchoř stepní

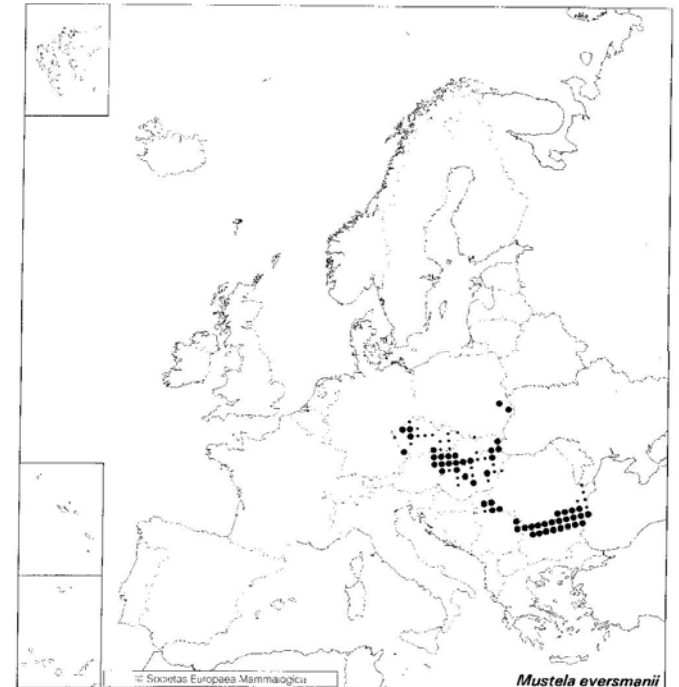

EN, - , KO

# *Mustela putorius* - tchoř tmavý

# *Mustela eversmannii* - tchoř stepní

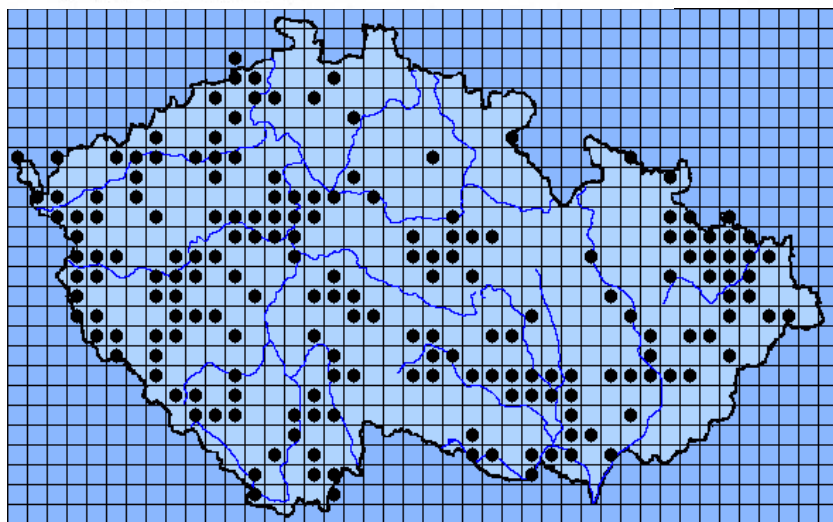
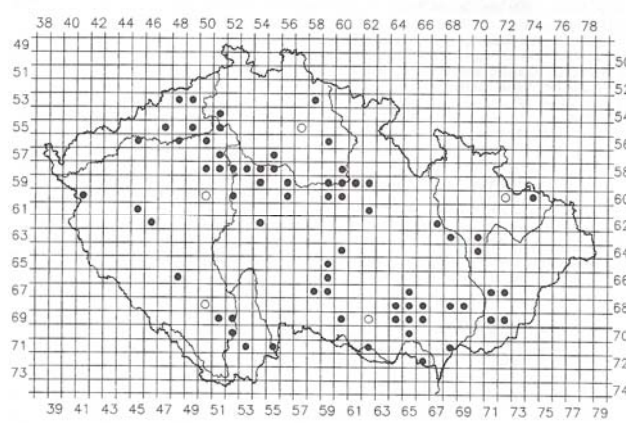
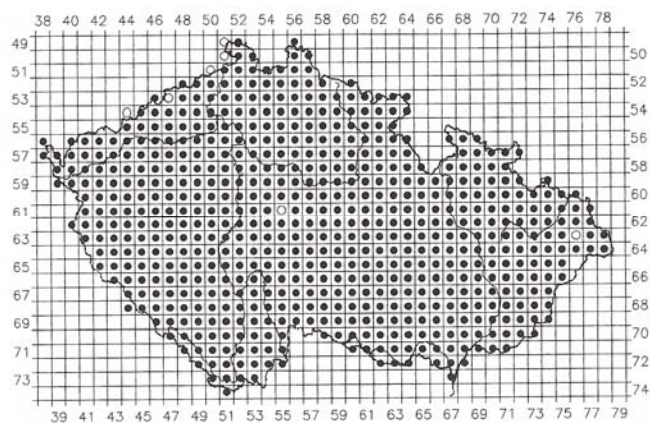
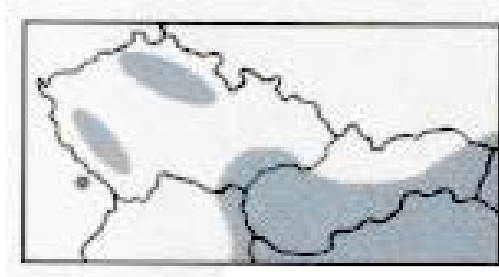
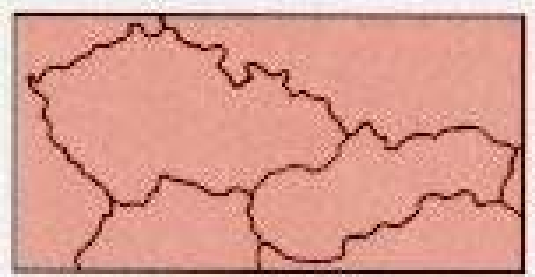

30 %

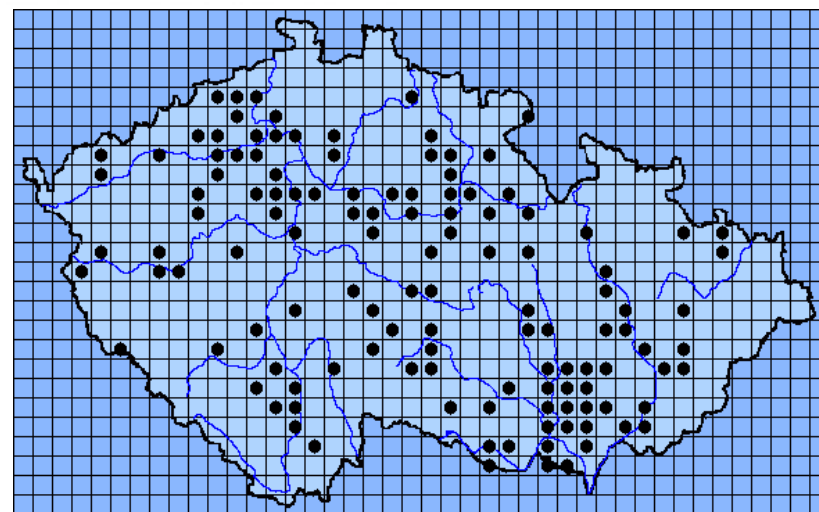

20 %

*Martes martes* (Linnaeus, 1758) – kuna lesní



© Rollin Verlinde - www.natuurbeleving.be

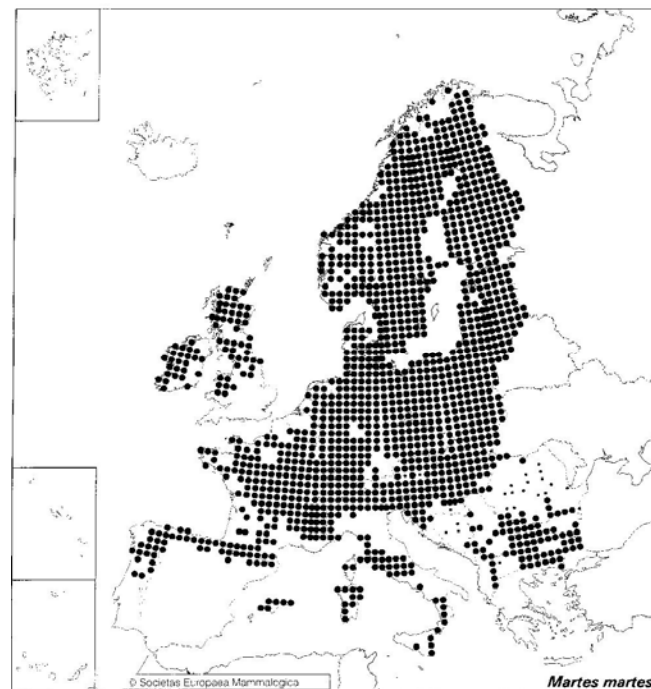

-, -, -

Urbelane & Benckhoven (1926)



-, -, -

*Martes foina* (Erxleben 1774) – kuna skalní

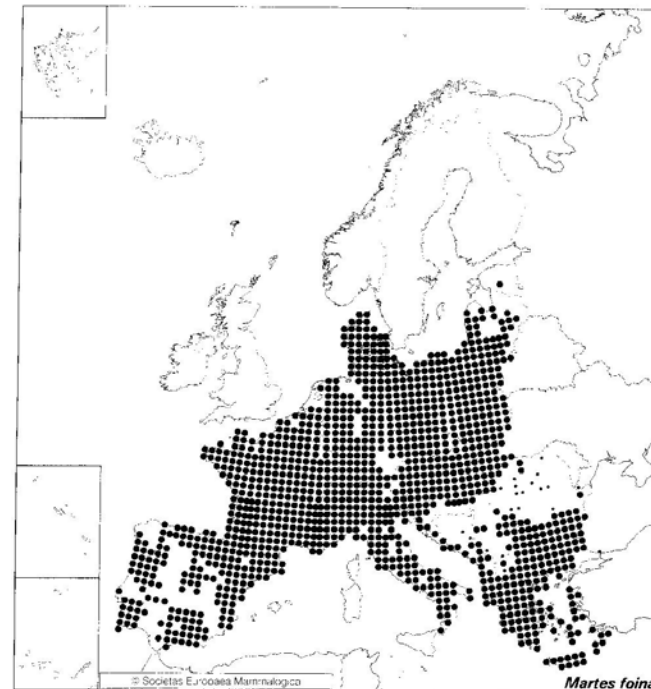

started in northern Switzerland and has spread to

# *Martes martes* (Linnaeus, 1758)

– kuna lesní

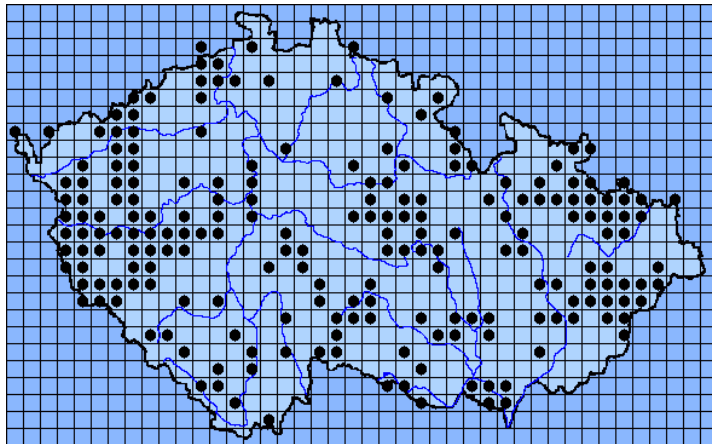
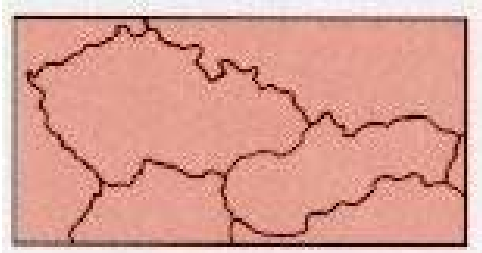

33 %

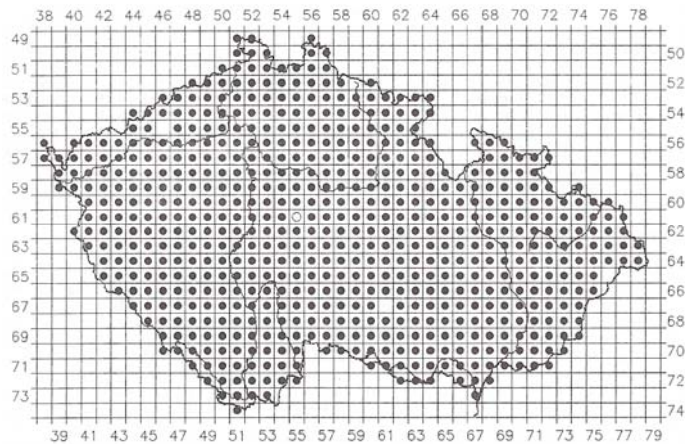

# *Martes foina* (Erxleben 1774)

– kuna skalní

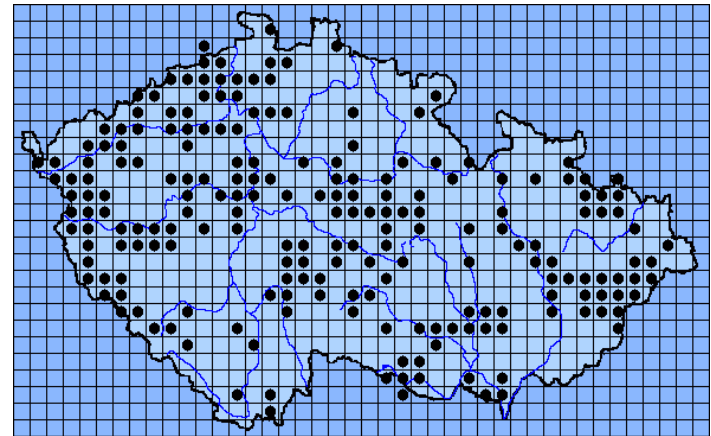
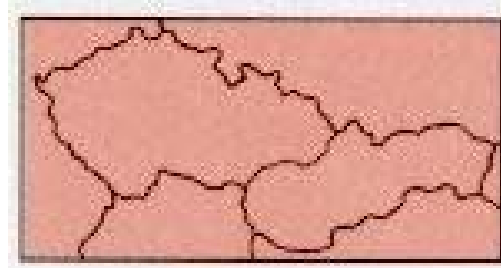

33 %

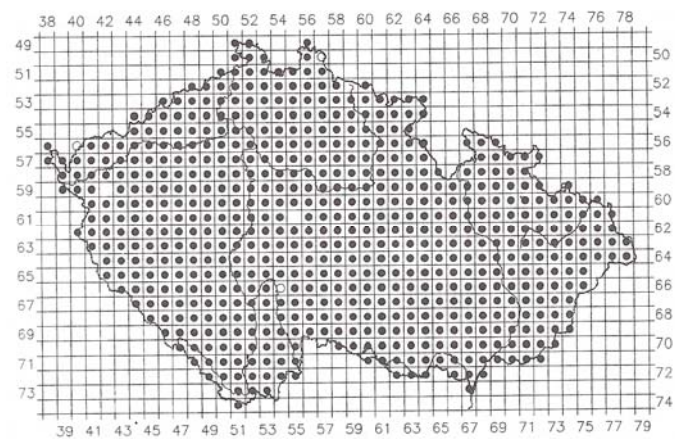

# *Meles meles* (Linnaeus, 1758)

- jezevec lesní

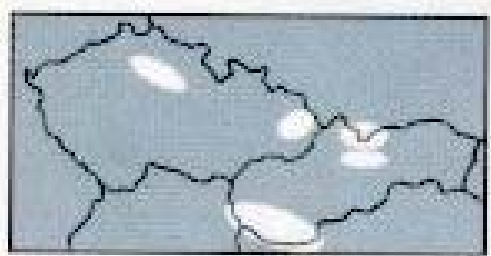

-, -, -

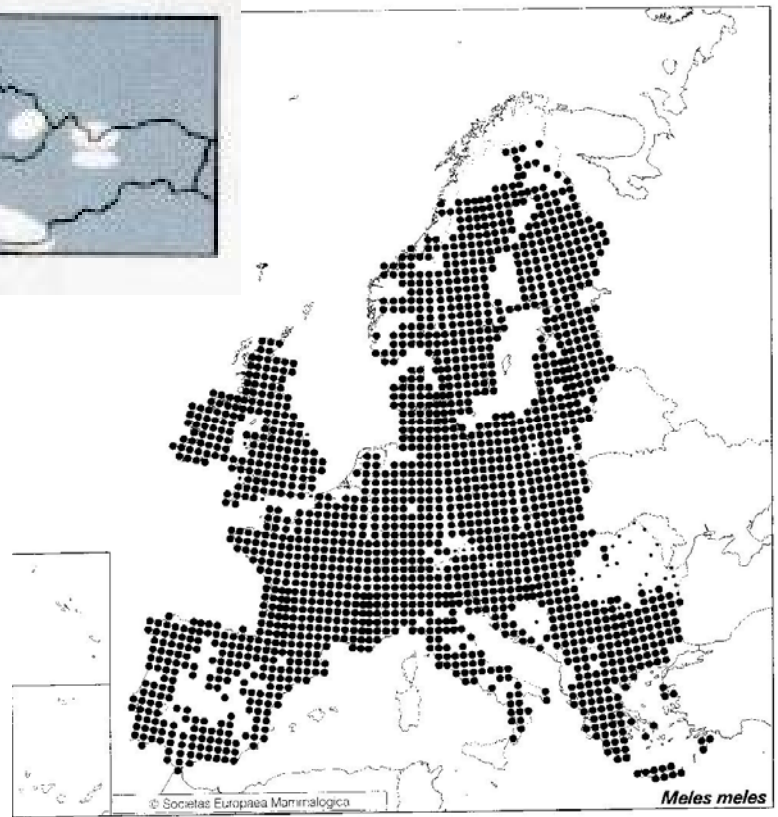

34 %

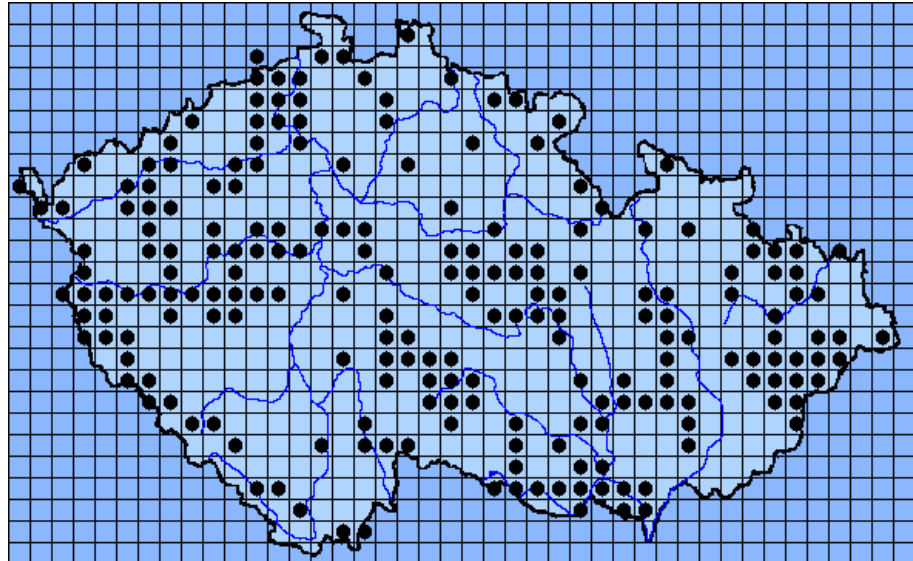
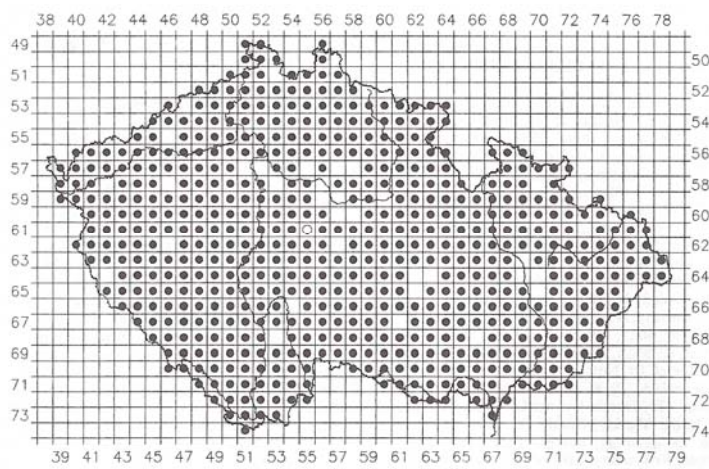



*Lutra lutra* (Linnaeus, 1758) - vydra říční



VU, VU, SO

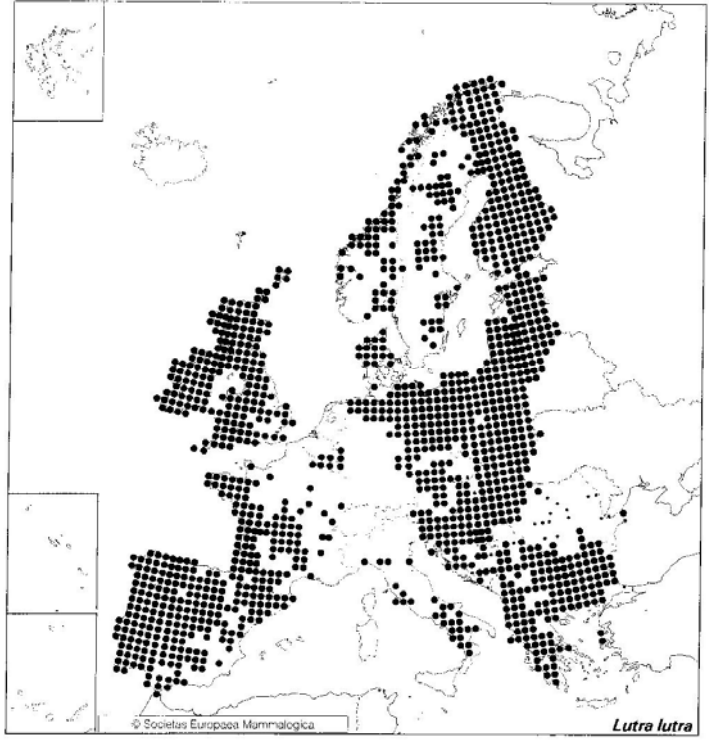

54 %

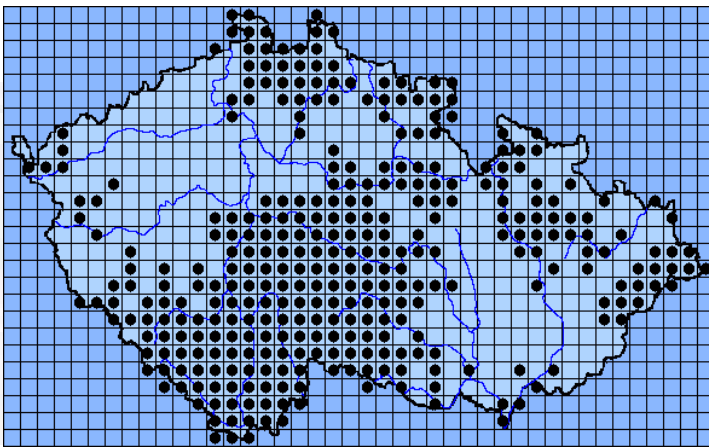
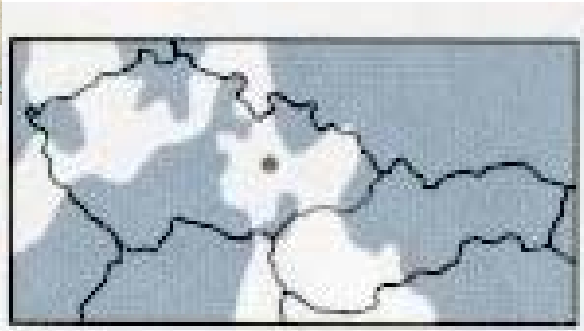

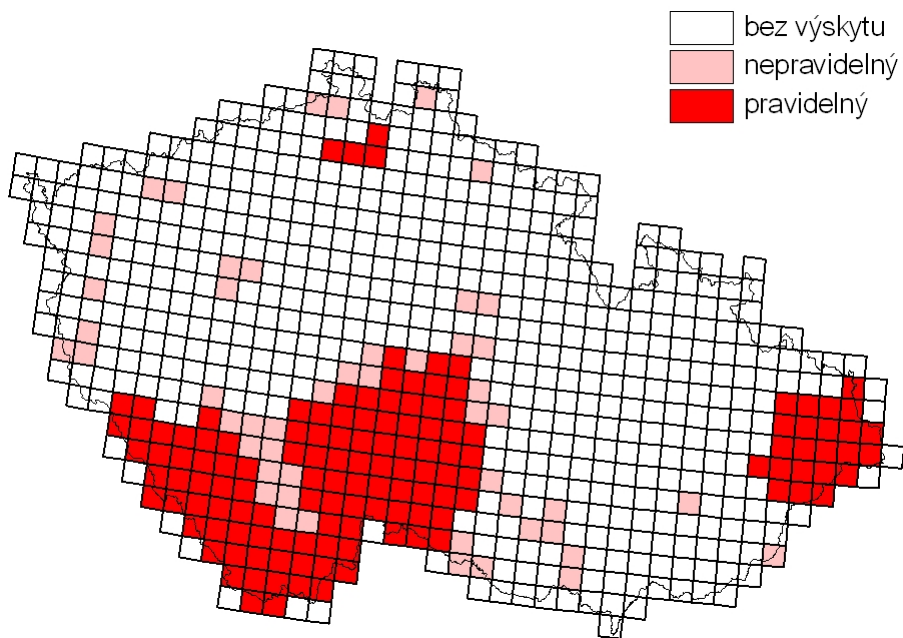

Výskyt vydry říční (*Lutra lutra*) na území České republiky v letech 1989-1992 (Toman 1992)

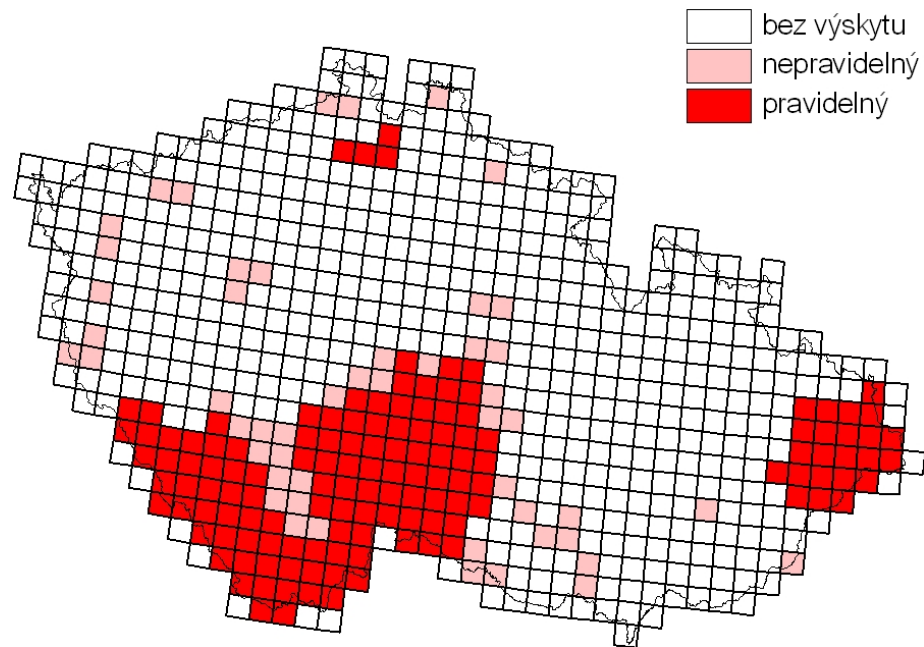

Výskyt vydry říční (*Lutra lutra*) na území České republiky v letech 1997-2001 (Kučerová et al. 2001, upraveno).

Výskyt vydry říční (*Lutra lutra*) na území České republiky v roce 2006 (Poledník et al. 2007).

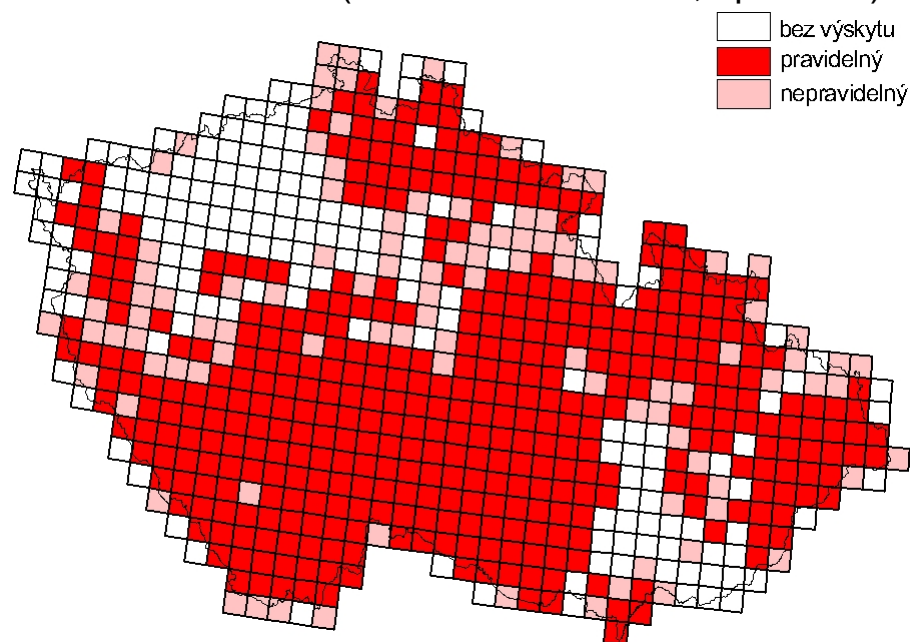

# *Ursus arctos*, Linnaeus, 1758 - medvěd hnědý



CR, - , KO

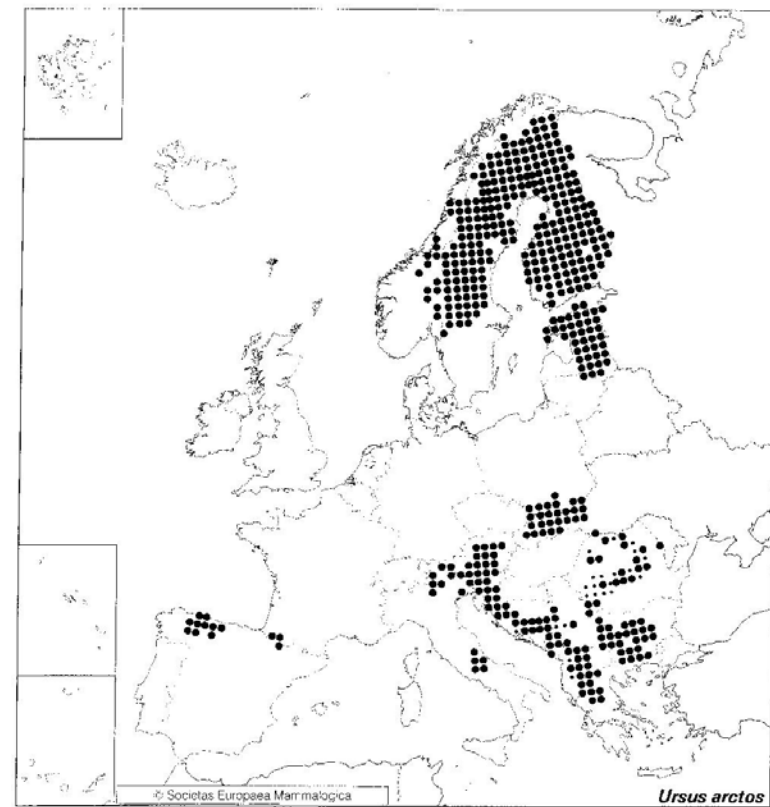

1 %

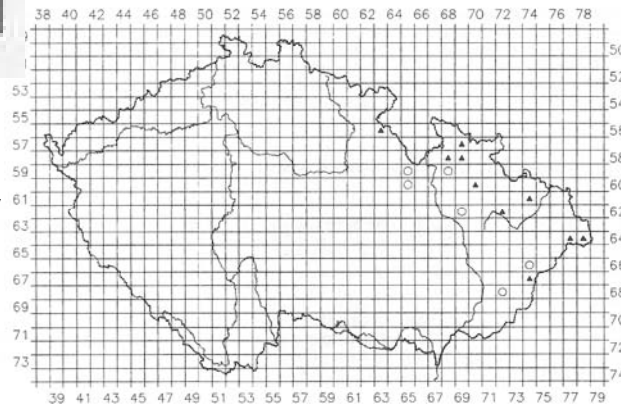
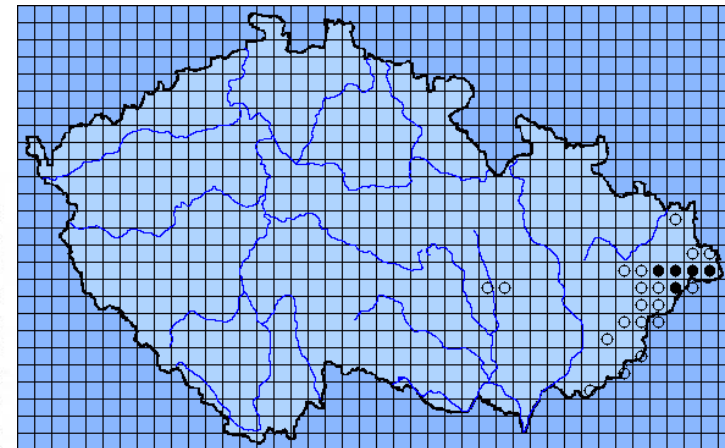

Poslední úlovek na území ČR – 1856 Šumava, 1890 Val. Bystřice, pak od 1963 Beskydy, pod Makytou, dnes SV MS-Beskydy, zatoulanci i dále na Z (Jeseníky, Náchodsko aj.), lesní komplexy, v ČR 2-5 ks, v SR 700-900 ks

*Canis lupus* Linnaeus, 1758 - vlk obecný

CR, - , KO



© Milan Kořínek



*Canis aureus* Linnaeus, 1758 - šakal obecný

# *Canis lupus* - vlk obecný

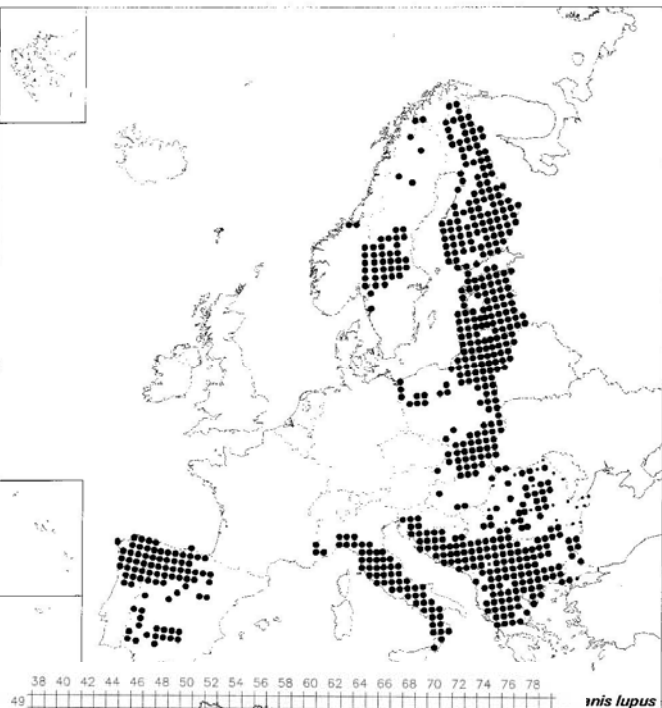

Poslední vlk na území ČR –  
1914 Bukov  
(Českotěšínsko), Šumava  
1874-1891, od 2. pol. 20.  
stol. imigranti z PL a SR,  
smečky v Beskydách, v ČR  
3-10 ks, v SR 400

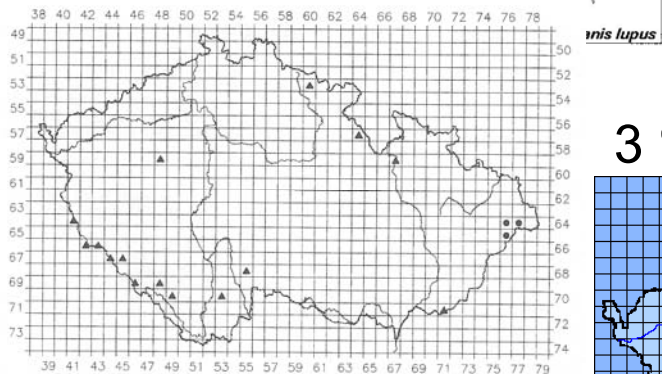

3 %

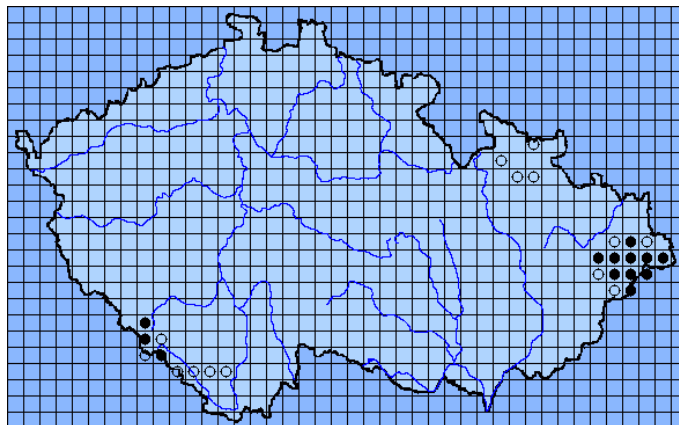

# *Canis aureus* - šakal obecný

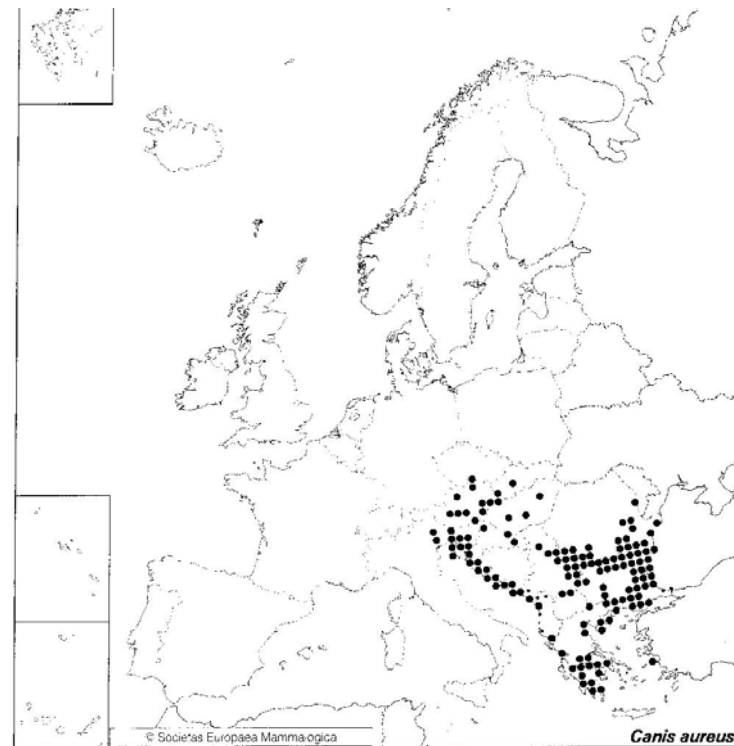

© Societas Europaea Mammalogica

*Canis aureus*

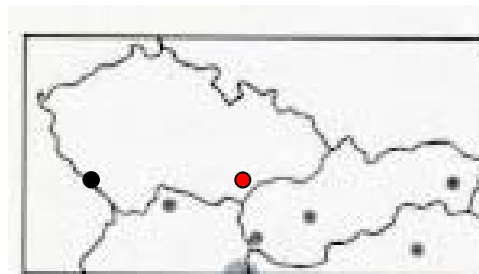

**Podolí (UH), 19.3.2006, mrtev**  
Dolní Ureš (Lipno, přehrada, na  
hranici s Rakouskem), obs.  
Kropáčova Vrutice (MB), mezi MB a  
Mělníkem, obs.  
V SR od 1989.



# *Nyctereutes procyonoides* (Gray, 1834) - psík mývalovitý



www-ezoo.cz

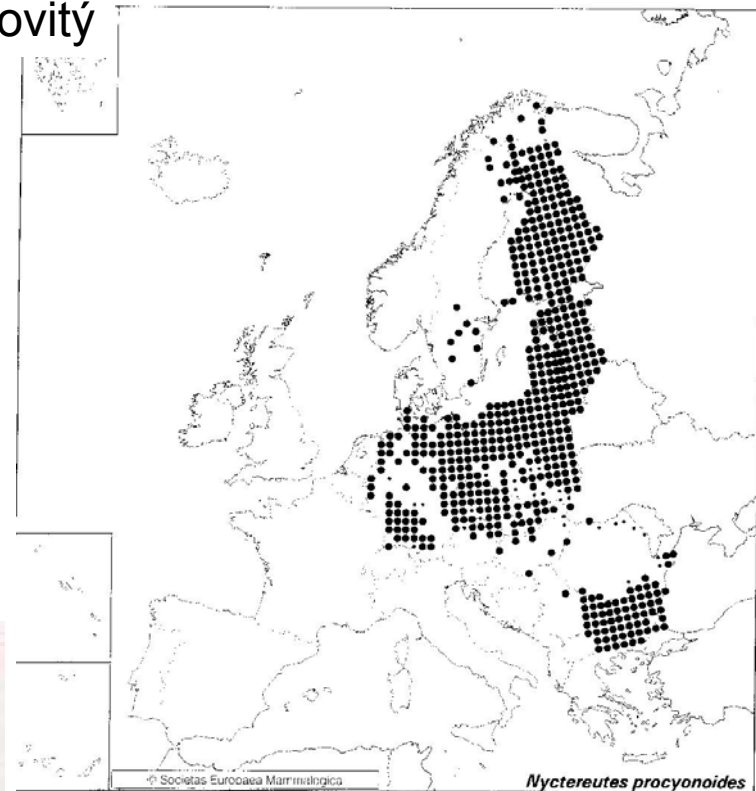
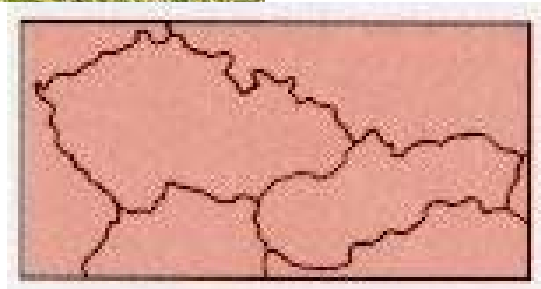

amazon to native fauna only occasionally and locally - currently more and more an important factor of their

60 %

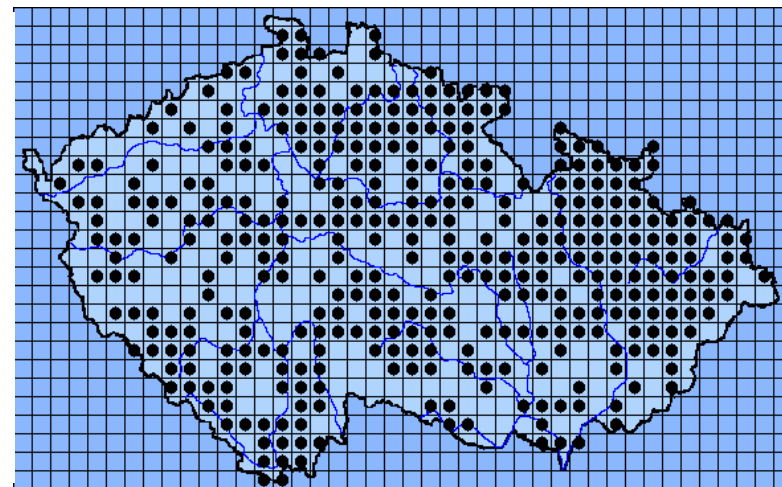
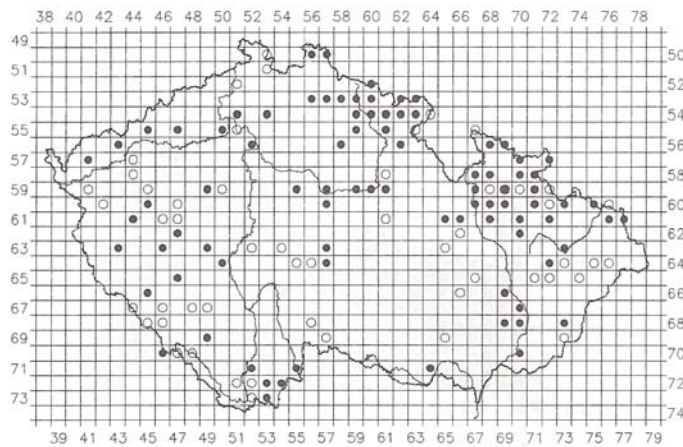

z JV-Asie, v ČR poprvé 1954 (z Polska), i úniky z farem, podmáčená stanoviště, u vody, listnaté lesy

# *Vulpes vulpes* (Linnaeus, 1758) - liška obecná

Faen (Vulpes vulpes)  
© Biopix.dk, J.C. Schou



Lesy, břehy vod, zem. krajina,  
ve městech, vzácně i tmavá  
forma

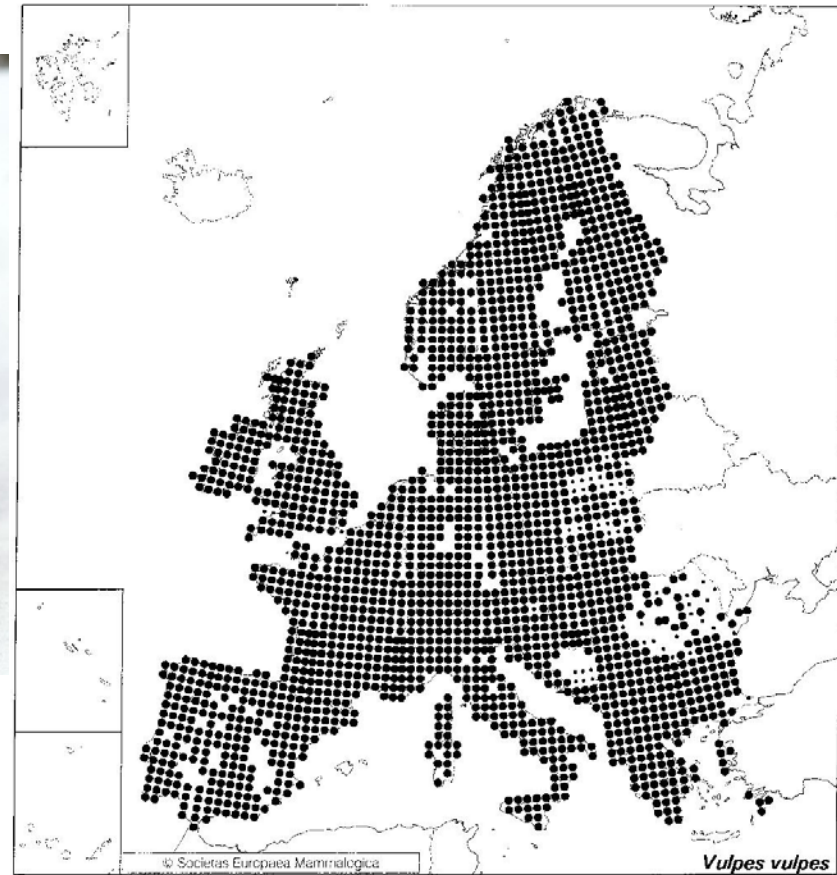

54 %

ČR 1999 uloveno 75000  
ks, SR 2001 18000 ks

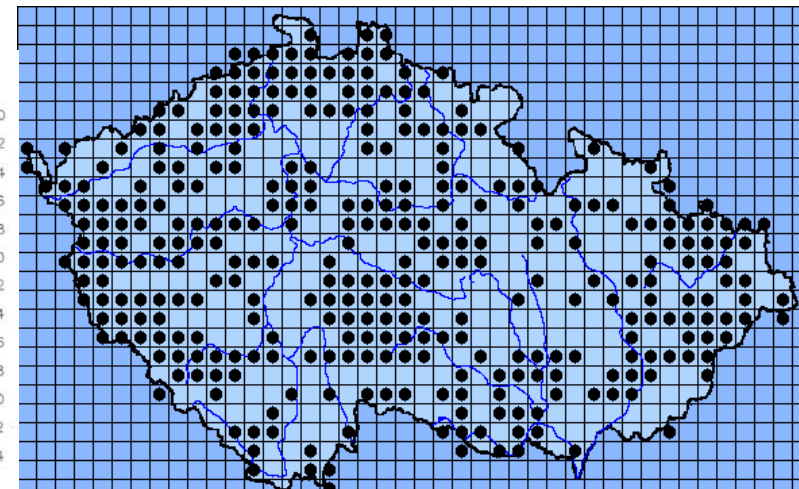
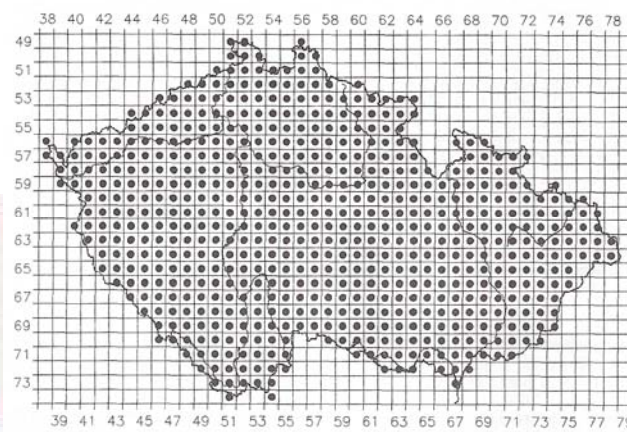
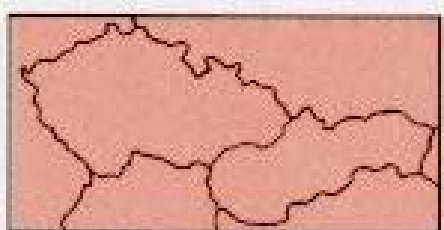

# *Felis silvestris* Schreber, 1775 - kočka divoká



www.naturfoto.cz

© Jiří Bohdal

DD, - , KO

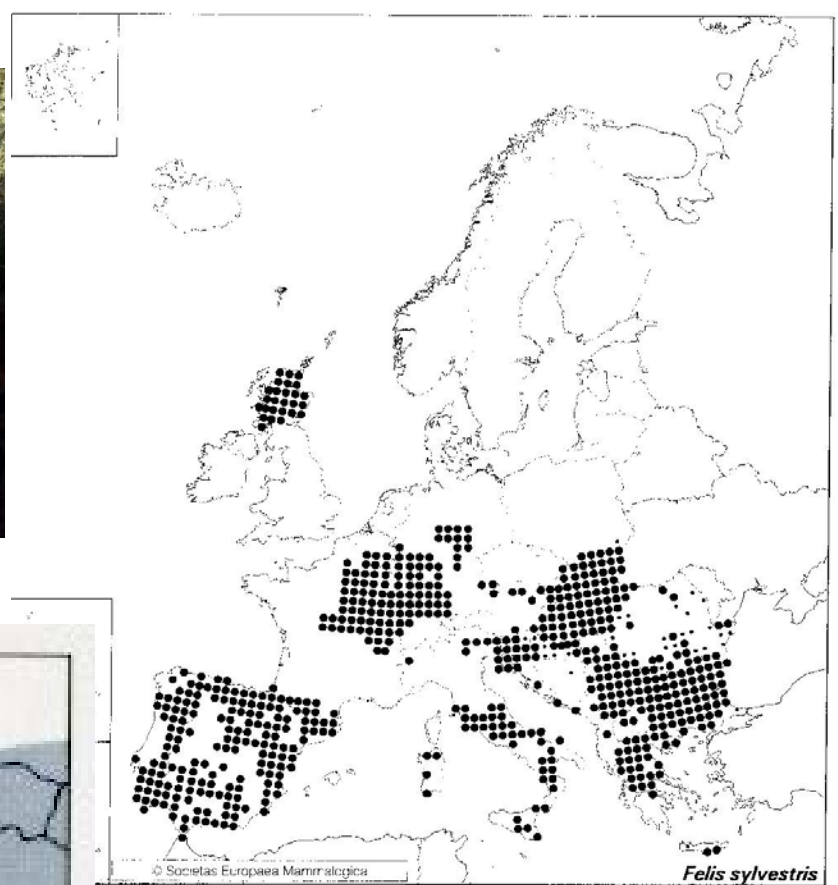

*Felis silvestris*

Control of feral domestic cats is a special

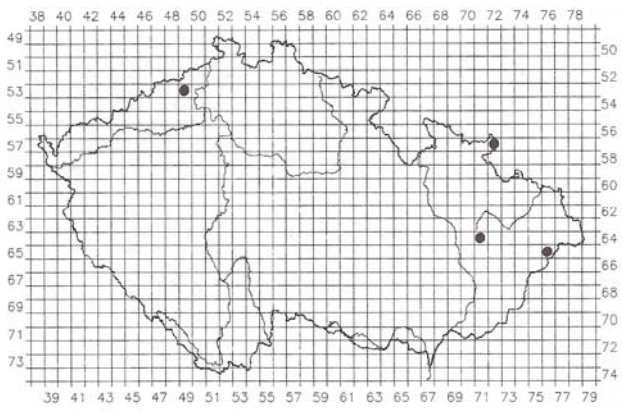

1 %

V Čechách vyhubena na přelomu 18. a 19. stol., na Moravě ??? – Beskydy a Bílé Karpaty, neúspěšná introdukce na Šumavě v 1970, v Pošumoví koncem 20. stol., na Slovensku listnaté a smíšené lesy, kde není rys. Zatoulanci ze Slovenska a Německa, v SR 1000 ks

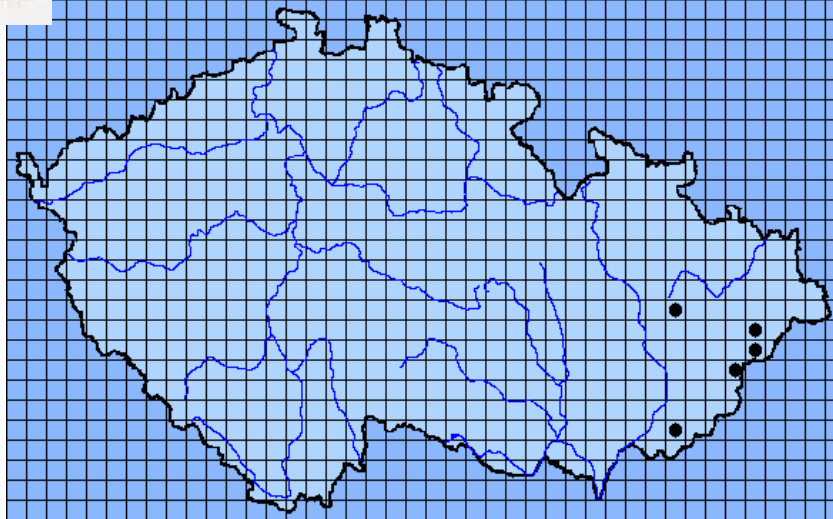



# *Lynx lynx* (Linnaeus, 1758) - rys ostrovid

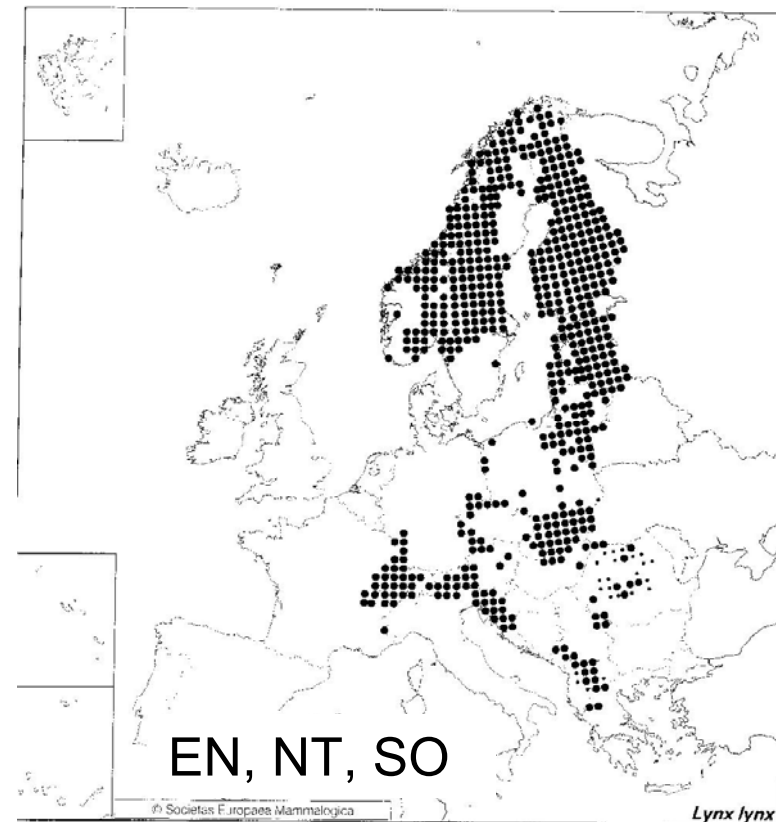
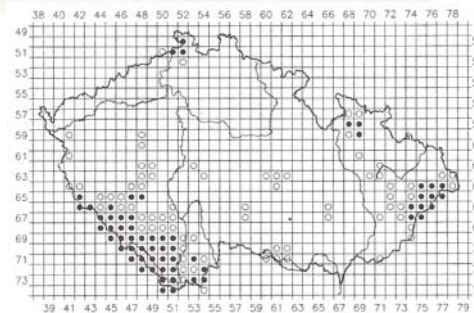
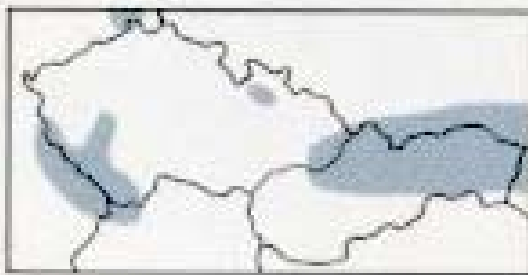

Other information

Literature

12 %

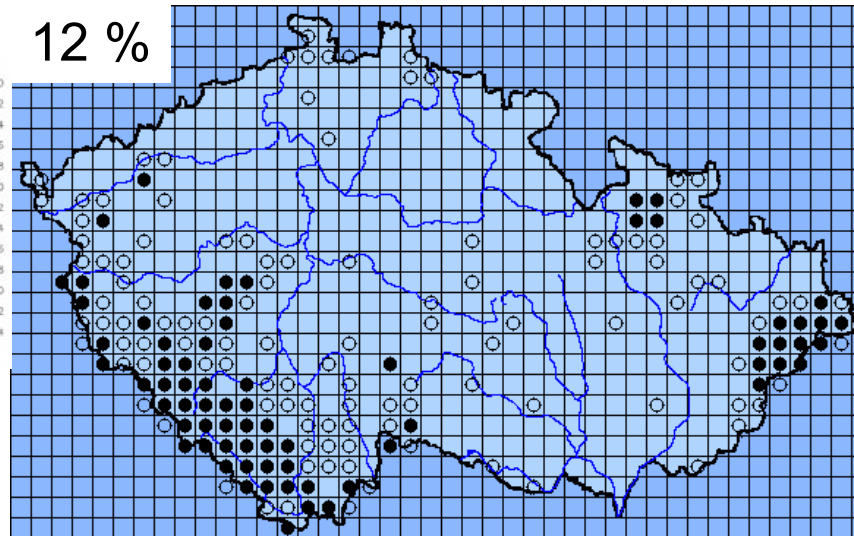

V Čechách vyhuben v 19. stol. (1835-1894), na Moravě – imigrace ze Slovenska v 1. pol. 20. stol., obnova od 1945 let, i díky reintrodukcii (Bavorsko 1970-1972, Šumava 1982-1989), dnes Šumava a okolí, Děčínská vrchovina, Jeseníky a Beskydy, v SR stále na S a V Slovensku; v ČR 100-150 ks, SR 300 ks

# Rodentia - hlodavci

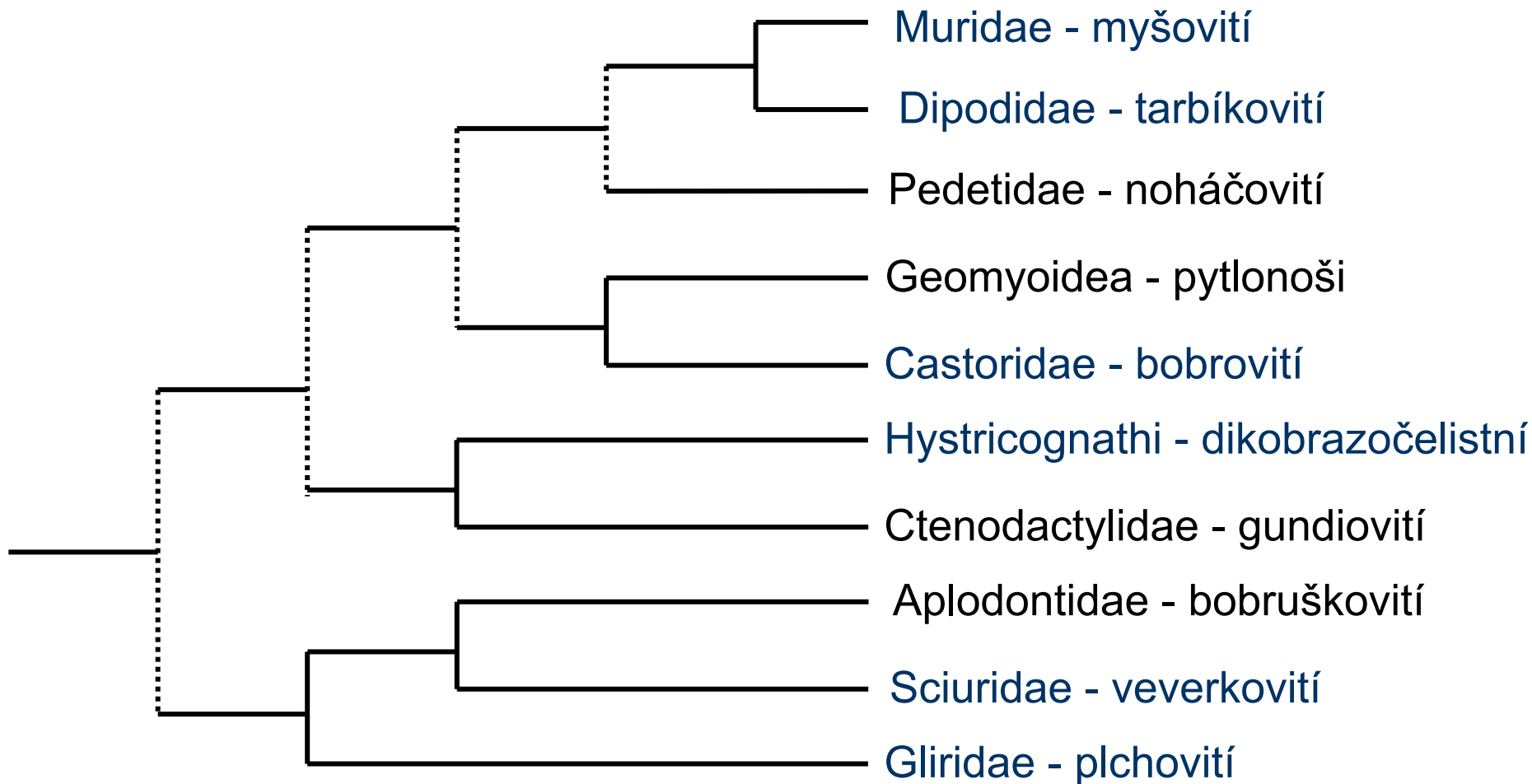

Rodentia = Sciurognathi + Hystricognathi

Muridae = Cricetidae + Arvicolidae + Muridae s.s.

# Rodentia - hlodavci

## Gliridae - plchovití

*Muscardinus avellanarius* (Linnaeus, 1758) – plšík lískový

*Glis glis* (Linnaeus, 1766) – plch velký

*Dryomys nitedula* (Pallas, 1778) – plch lesní

*Eliomys quercinus* (Linnaeus, 1766) – plch zahradní

## Sciuridae - veverkovití

*Sciurus vulgaris* Linnaeus, 1758 - veverka obecná

*Spermophilus citellus* (Linnaeus, 1766) - sysel obecný

*Marmota marmota* (Linnaeus, 1758) - svišť horský

## HYSTRICOGNATHI

### Myocastoridae - nutriovití

*Myocastor coypus* (Molina, 1782) – nutrie říční

### Castoridae - bobrovití

*Castor fiber* Linnaeus, 1758 - bobr evropský

*Castor canadensis* Kuhl, 1820 - bobr kanadský

## MURIDAE

### Cricetinae - křečkovití

*Cricetus cricetus* Linnaeus, 1758 - křeček polní

## Arvicolinae - hrabošovité

*Myodes glareolus* (Schreber, 1780) - norník rudý

*Arvicola terrestris* (Linnaeus, 1758) - hryzec vodní (*Arvicola amphibius*)

*Ondatra zibethicus* (Linnaeus, 1766) - ondatra pižmová

*Microtus arvalis* (Pallas, 1778) - hraboš polní

*Microtus agrestis* (Linnaeus, 1761) - hraboš mokřadní

*Microtus oeconomus* (Pallas, 1776) - hraboš hospodárny

*Microtus subterraneus* (de Sélys-Longchamps, 1836) - hrabošík podzemní

*Microtus tatricus* (Kratochvíl, 1952) - hrabošík tatranský

*Chionomys nivalis* (Martins, 1842) - hraboš sněžný

## Murinae - myšovité

*Apodemus flavicollis* (Melchior, 1834) - myšice lesní

*Apodemus sylvaticus* (Linnaeus, 1758) - myšice křovinná

*Apodemus agrarius* (Pallas, 1771) - myšice temnopásá

*Apodemus microps* Kratochvíl et Rosický, 1952 - myšice malooká

*Apodemus uralensis* Pallas, 1811

*Micromys minutus* (Pallas, 1771) - myška drobná

*Mus musculus* Linnaeus, 1758 - myš domácí

*Mus domesticus* Ruddy, 1772 - myš západoevropská

*Mus spicilegus* Petenyi, 1882 - myš panonská

*Rattus rattus* (Linnaeus, 1758) - krysa obecná

*Rattus norvegicus* (Berkenhout, 1769) - potkan

**Dipodidae - tarbíkoviť** (Zapodidae – myšivkovití)

*Sicista betulina* Pallas, 1779 – myšivka horská

*Sicista subtilis* (Pallas, 1773) – myšivka stepní

# *Muscardinus avellanarius* (Linnaeus, 1758)

– plšík lískový

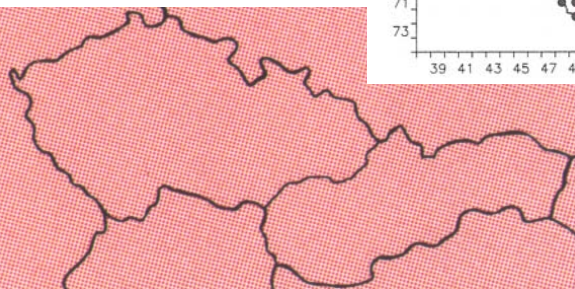
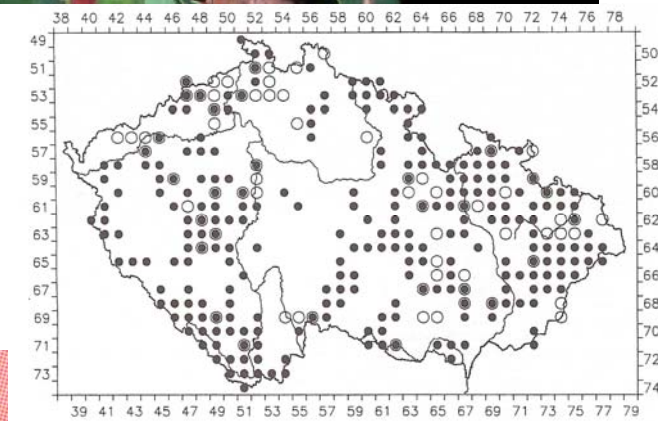
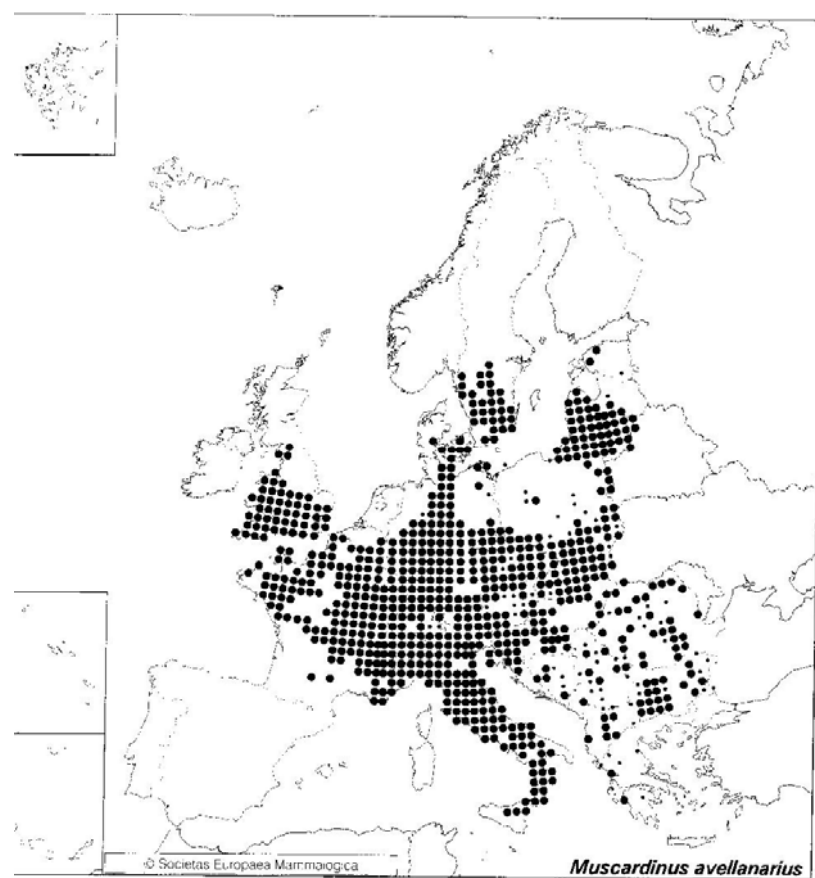

-, -, SO 52%

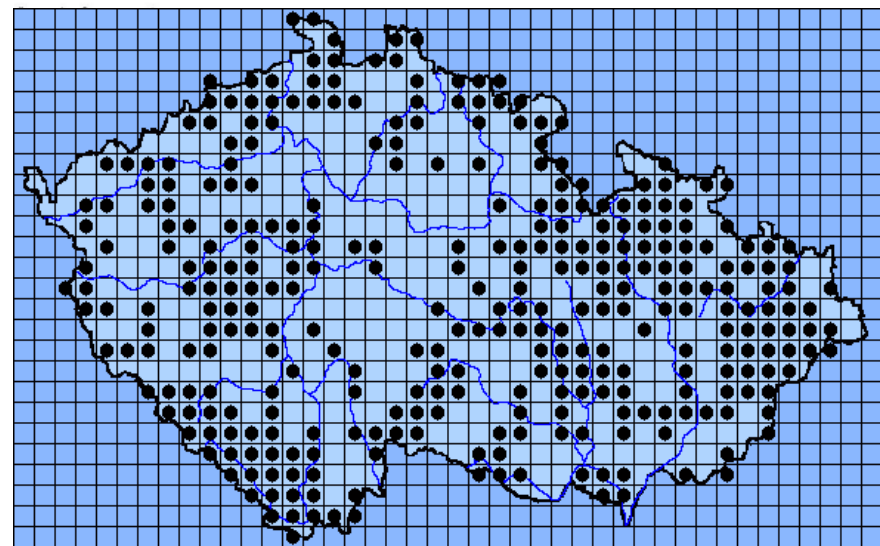

*Glis glis* (Linnaeus, 1766) – plch velký



DD, NT, O

19%

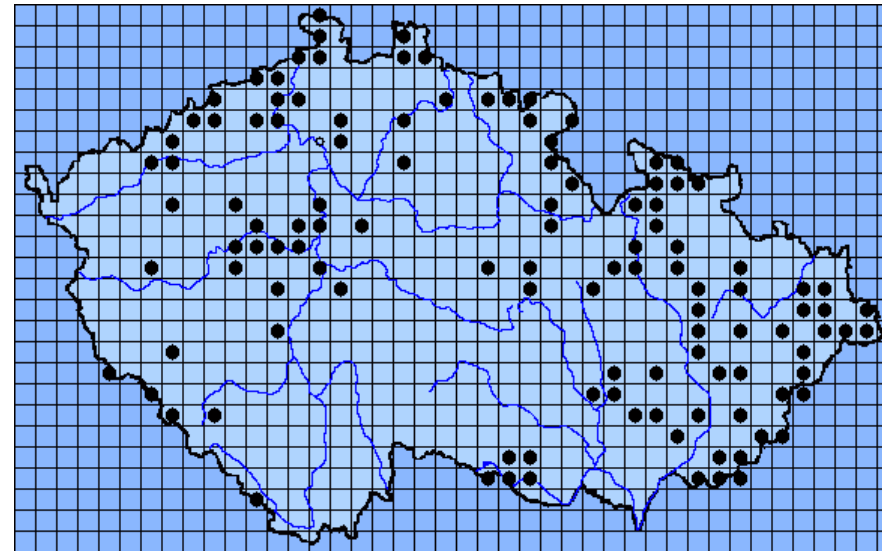
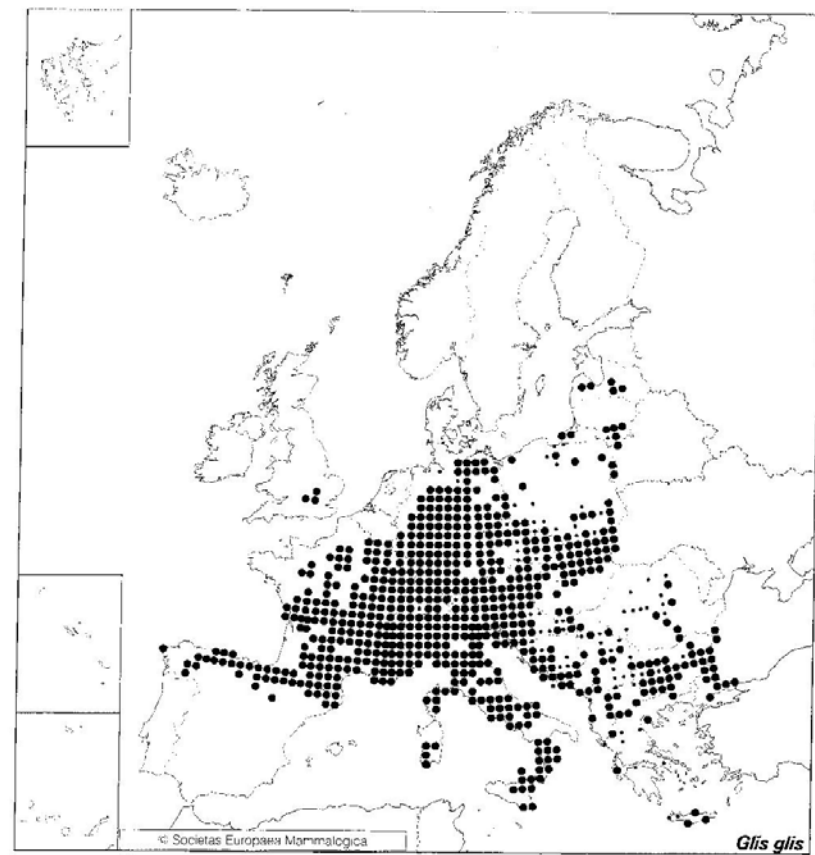

*Eliomys quercinus* (Linnaeus, 1766) – plch zahradní



*Dryomys nitedula* (Pallas, 1778) – plch lesní





# *Eliomys quercinus* – plch zahradní

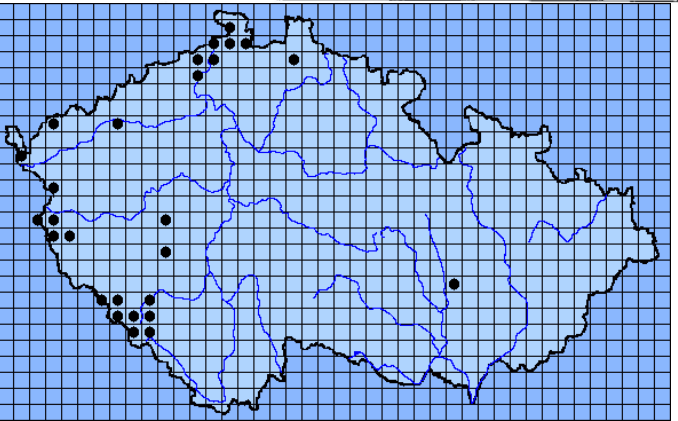
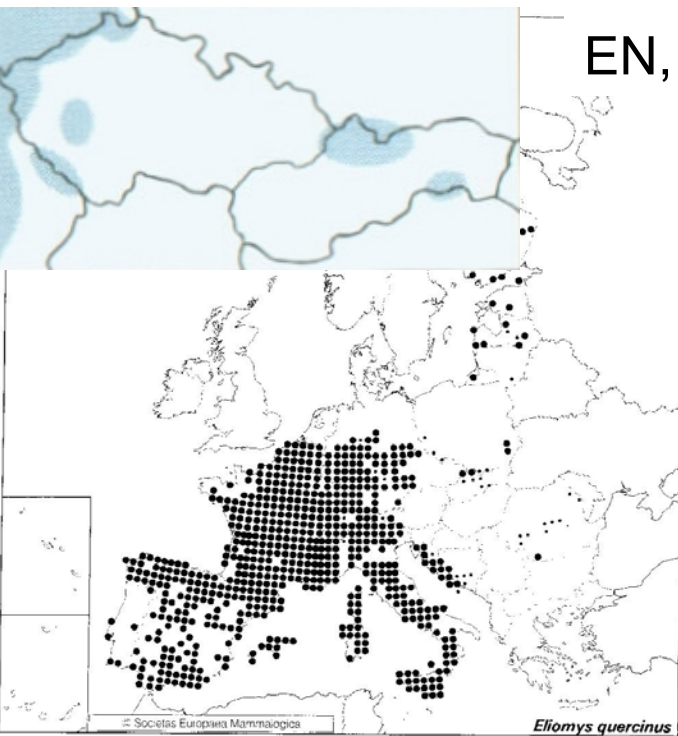

V ČR dnes jen Šumava, Český les, Krušné hory, S-Čechy, okraj Brd, Morava ???, SR – od 70. let 20. stol. znám jen z vývržků, předtím od Povážského Inovce po Slovesnký kras. Nejvíce masožravý (80%)

# *Dryomys nitedula* (Pallas, 1778) – plch lesní

-, -, SO

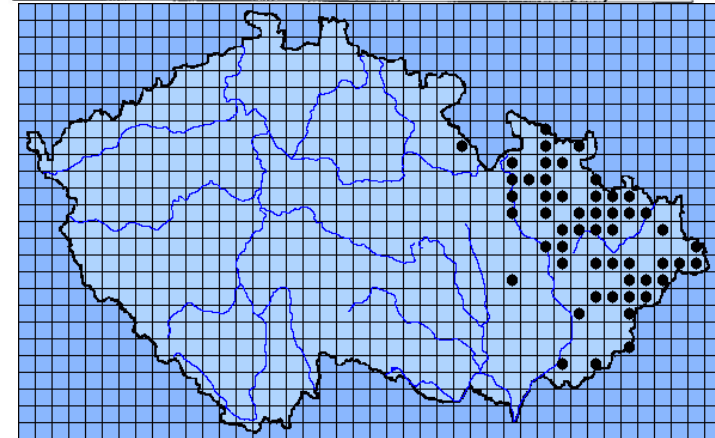
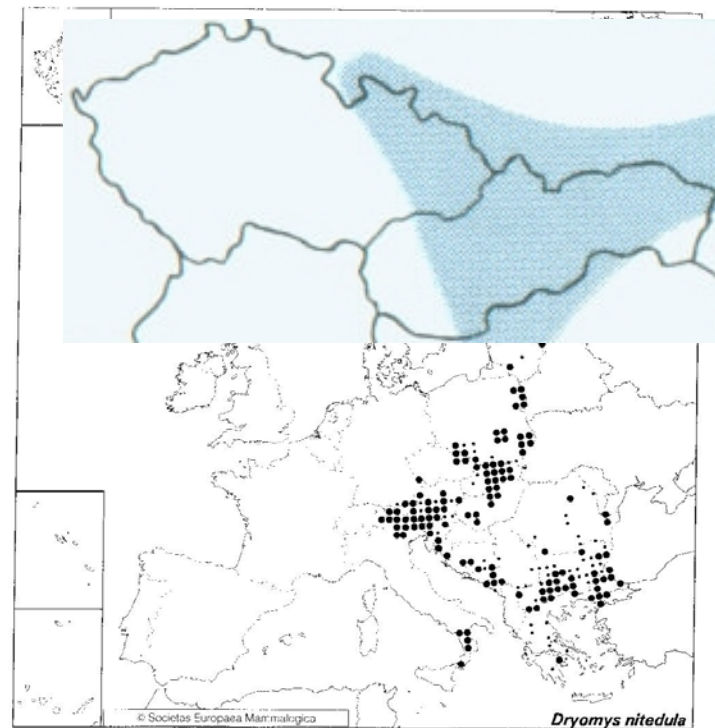

V ČR jen na Moravě – Slezsko, SV Morava, pohoří Z a stř. Slovenska a Východoslovenská nížina, i v ptačích budkách

*Sciurus vulgaris* Linnaeus, 1758) - veverka obecná

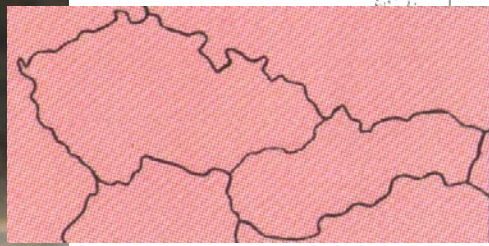

NE, NT, O

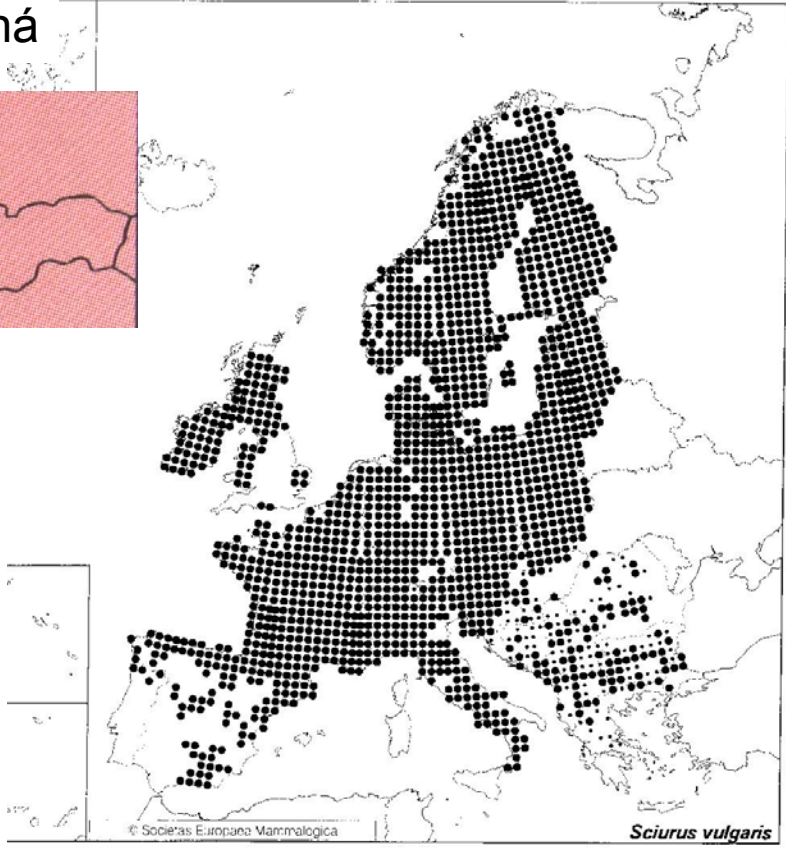

use it strips the bark from conifer trees, or feeds



1991-1992\_dotazník

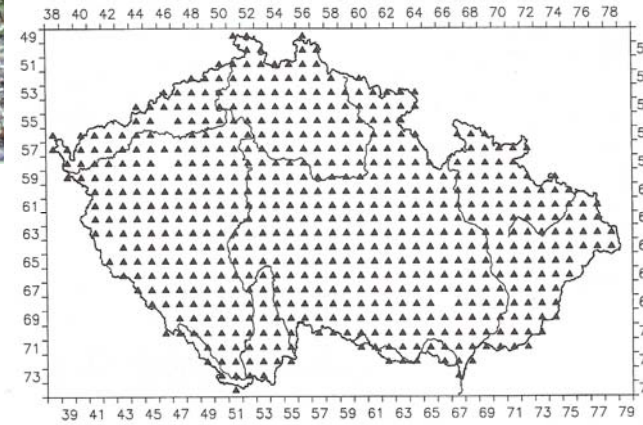

70%

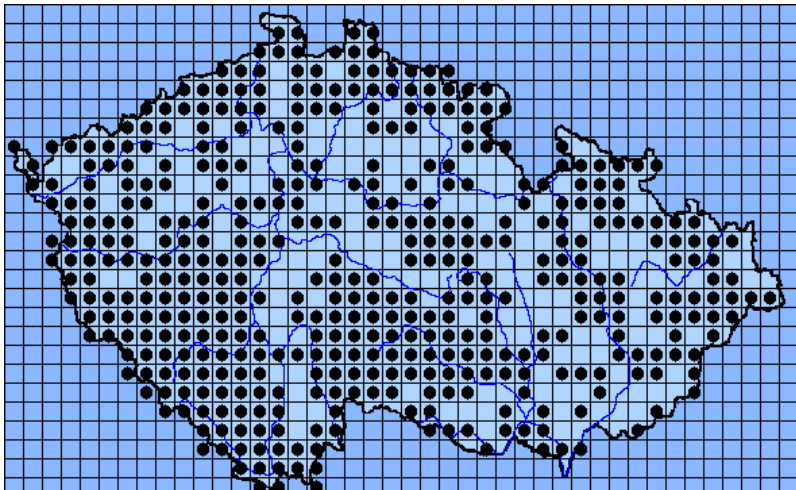

Lesy, parky, hřbitovy

# *Spermophilus citellus* (Linnaeus, 1766)

- sysel obecný

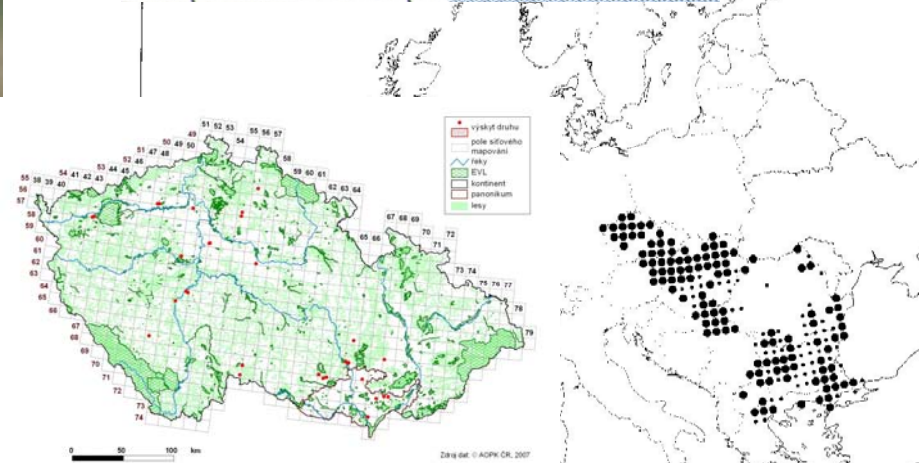
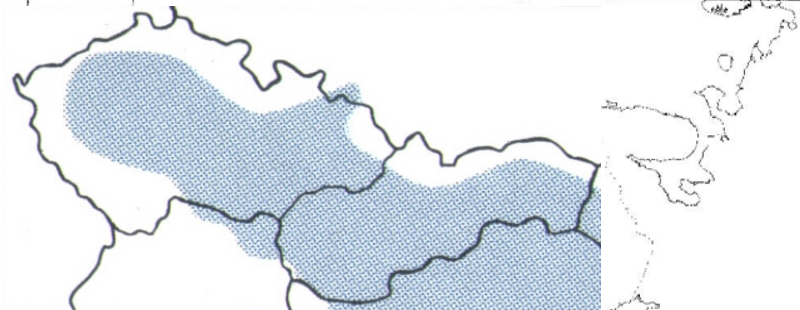

CR, NT, KO

Ostrůvkovitě na travnatých plochách,  
izolované kolonie

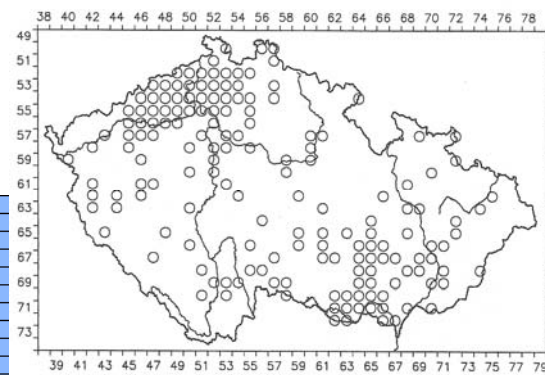
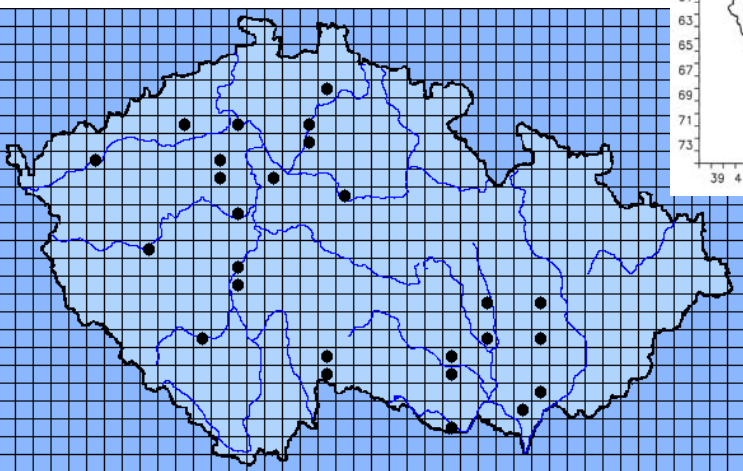

do 1950

5%

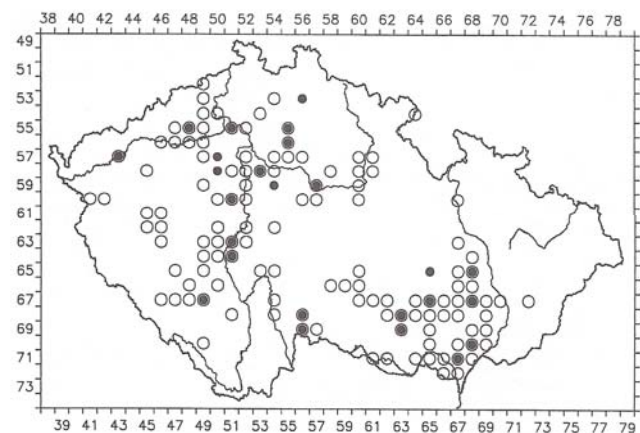

1951-2000; 2001-2005

Societas Europaea Mammalogica

*Spermophilus citellus*

# *Marmota marmota* (Linnaeus, 1758)

- svišť horský



© Jiří Bohdal  
www.naturfoto.cz

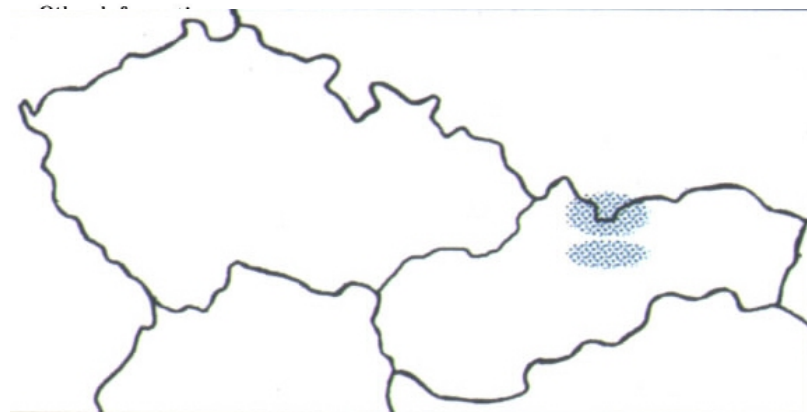
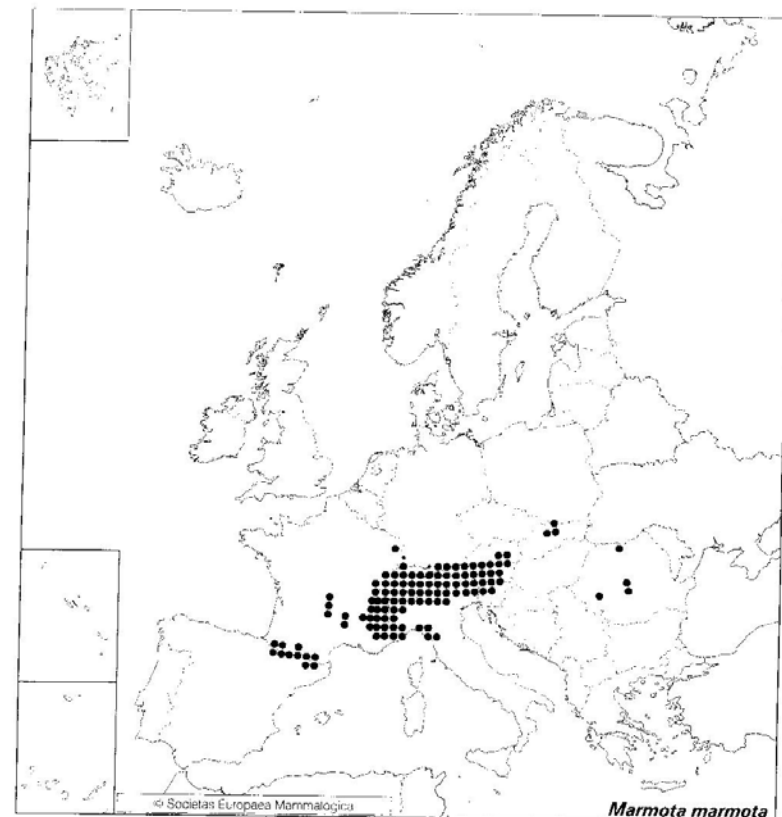

Jen SR- TANAP, v Nížkých Tatrách vyhuben, ale 1851-1881 reintrodukce, Aklimatizace v Krkonoších (1903) a Jeseníkách (1963) neúspěšné, ve Vys. Tatrách 1000 ks, Níz. Tatrách 100 ks.

# *Myocastor coypus* (Molina, 1782)

– nutrie říční

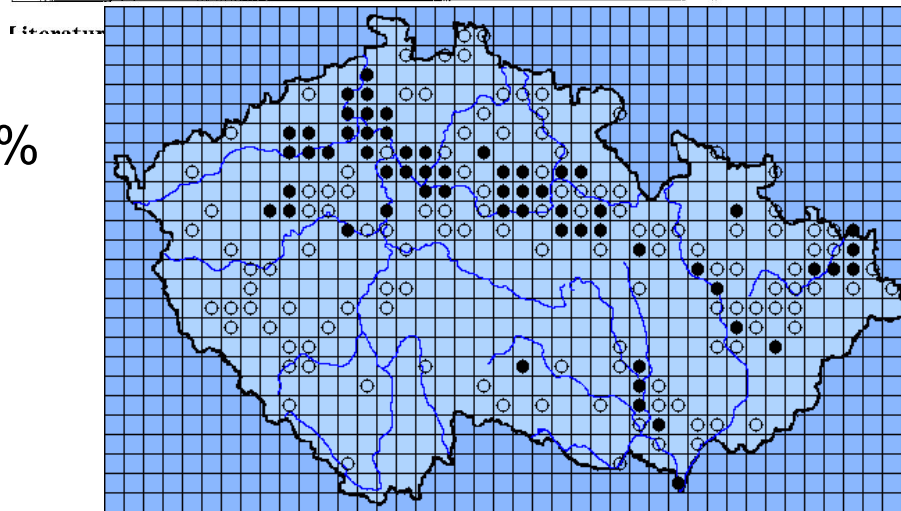
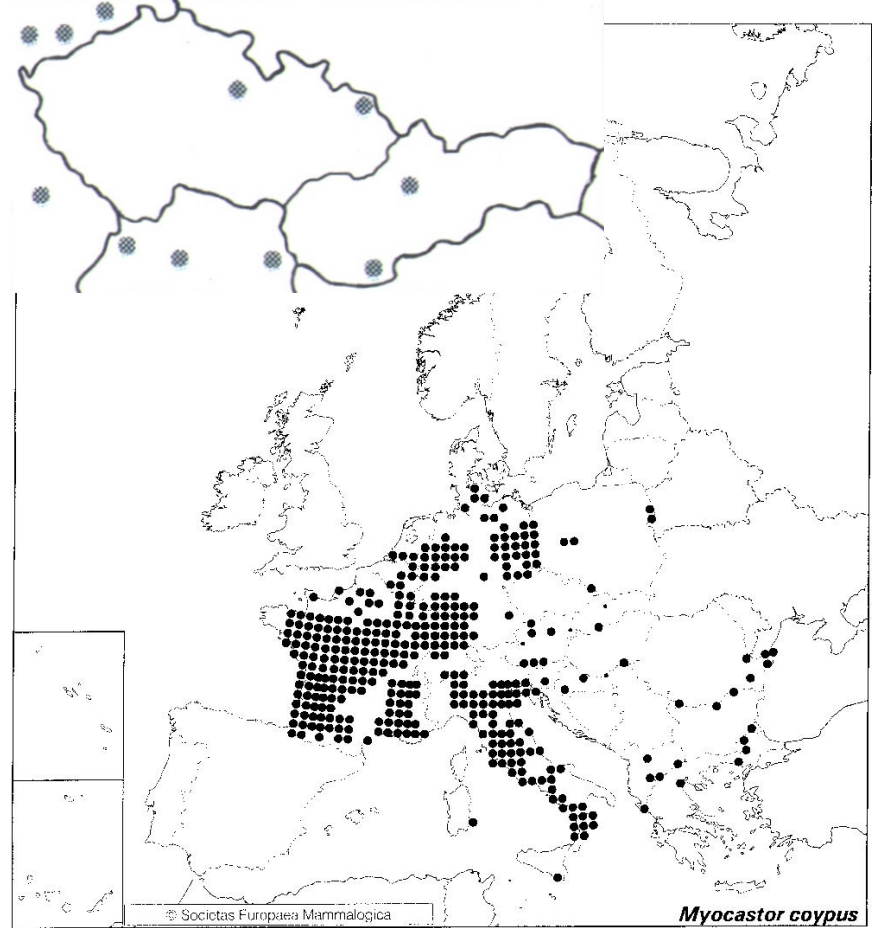

10%

Am, úniky z farem, neúspěšná introdukce 1955 do dolního Hronu, reprodukcující se populace ve V-Čechách, S a J Moravě, zimní mortalita

*Castor fiber* Linnaeus, 1758  
- bobr evropský



VU, NT, SO

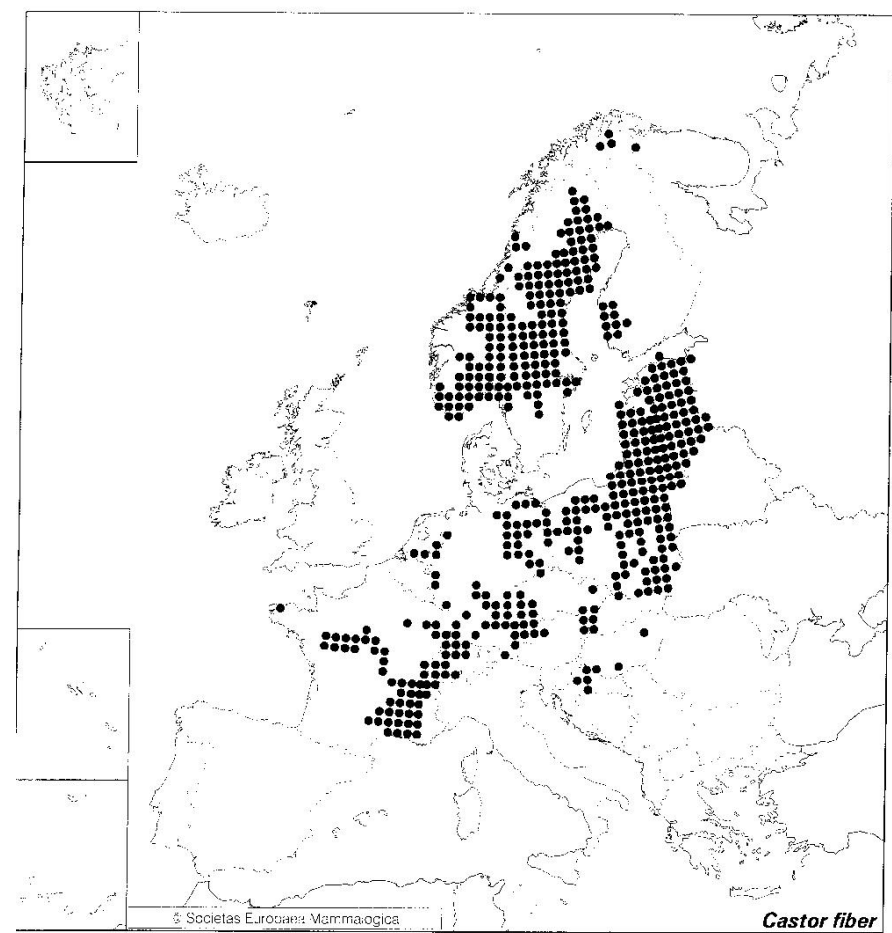
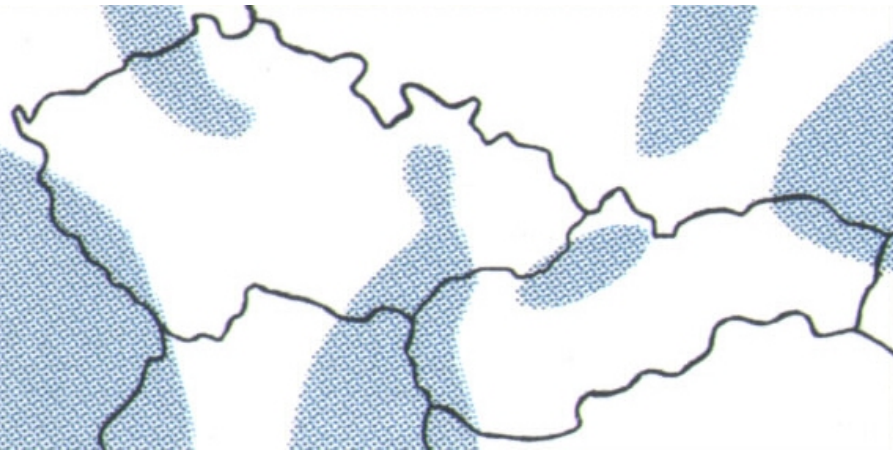

through building of dams, burrows, lodges and canals. **T. 1300-1400**

# Castor fiber Linnaeus, 1758

- bobr evropský

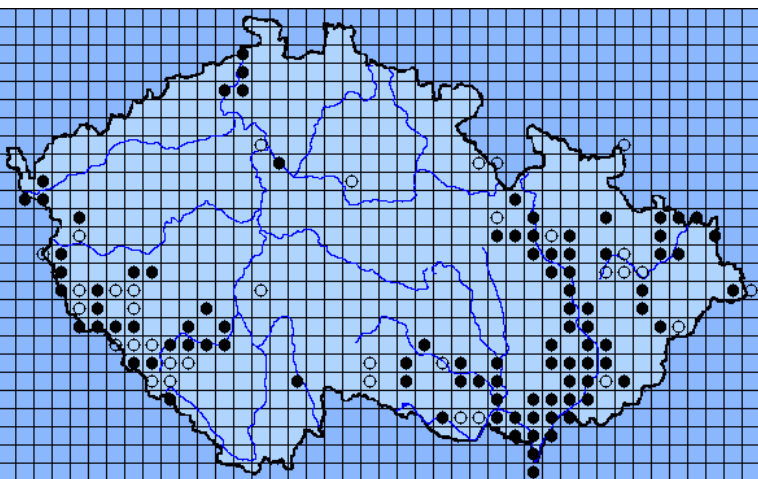

15%

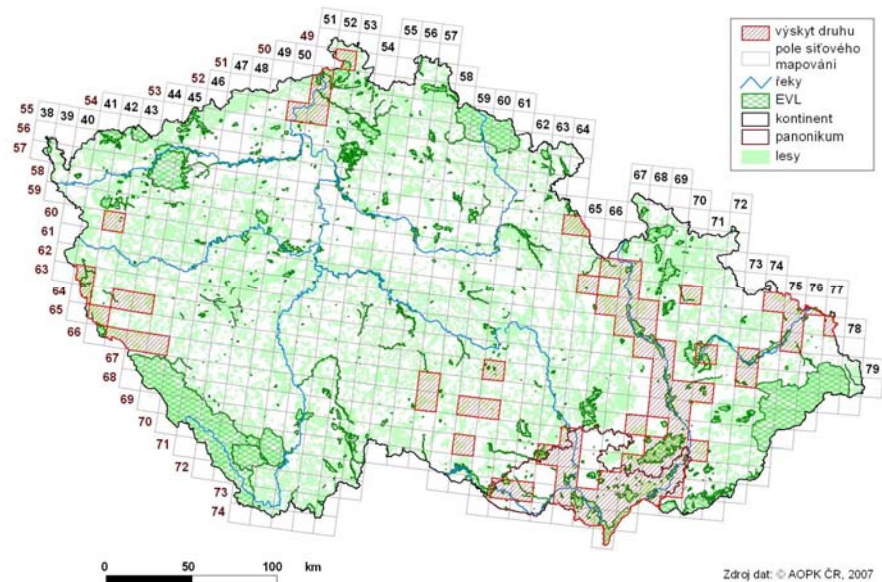

18.-19. st.

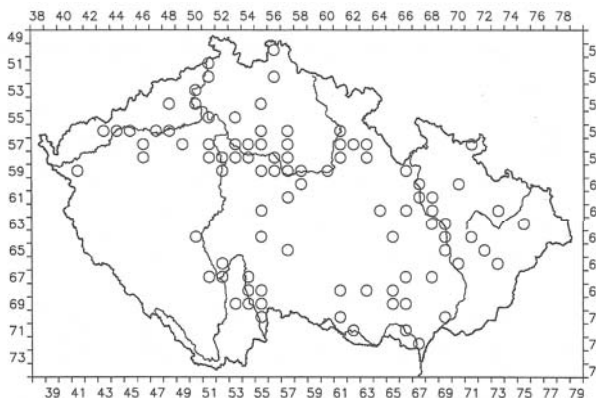

Obr. 5: Historický výskyt bobra evropského (*Castor fiber*) na území ČR (10.-19. století).

1975-1999

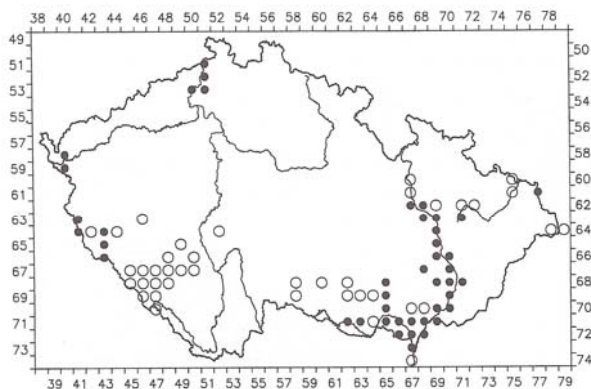

Obr. 6: Bobr evropský (*Castor fiber*) - výskyt v období 1975-1999 (○ - přechodný výskyt, ● - trvalý výskyt)

2000-2004

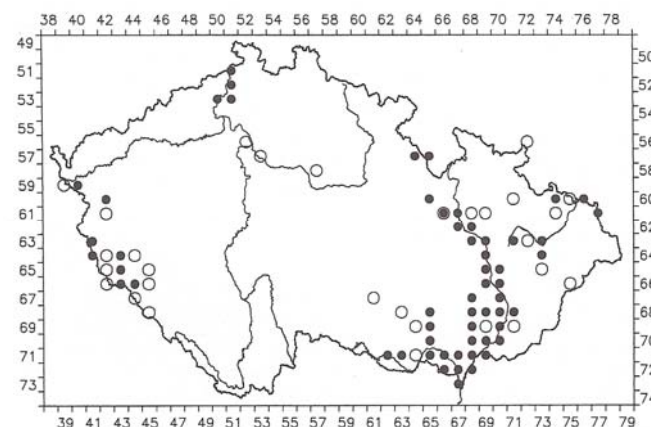

Cfib - V J-Čechách vyhuben už v pol. 18. stol., reintrodukce 1809 na Třeboňsku, ale poslední uloven 1871, na Slovensku na Žitném ostrově posl. zástřel 1858, introdukce 1991-1996 do Litovelského Pomoraví a na Odru 27 ks z PL a Litvy, šíření bobra na dolních a středních úsecích řek, starých ramenech a rybnících v povodí Labe, Odry a Dunaje, 2002 odhad po 150 ks v ČR i SR; dnes v ČR 200-300 ks

Ccan - introdukce do Finska a Rakouska na V od Vídně (12-15 ks) - vymření

# *Cricetus cricetus* Linnaeus, 1758

- křeček polní



-, -, SO

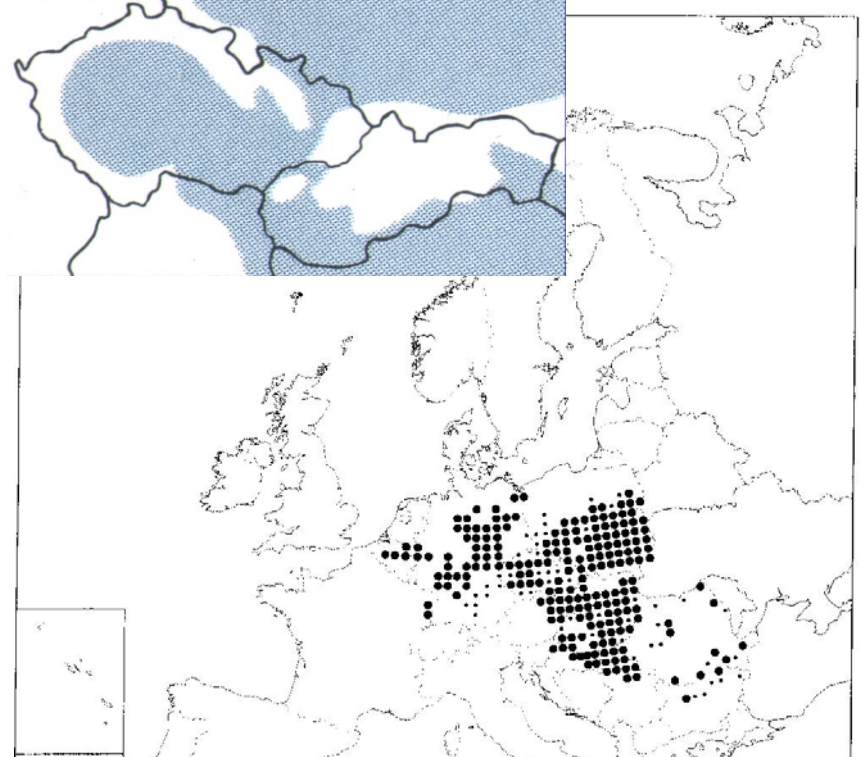
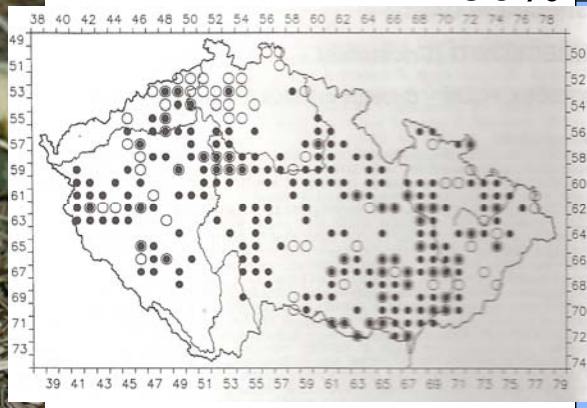

Odlesněná kulturní krajina, v ČR od 70. let 20. st. úbytek až lokální vymizení, od 90. let populace vzrůstá, šíření.  
Přemnožování – na Slovensku až 500 ks/ha (1971), hojný v nížinách.

36%

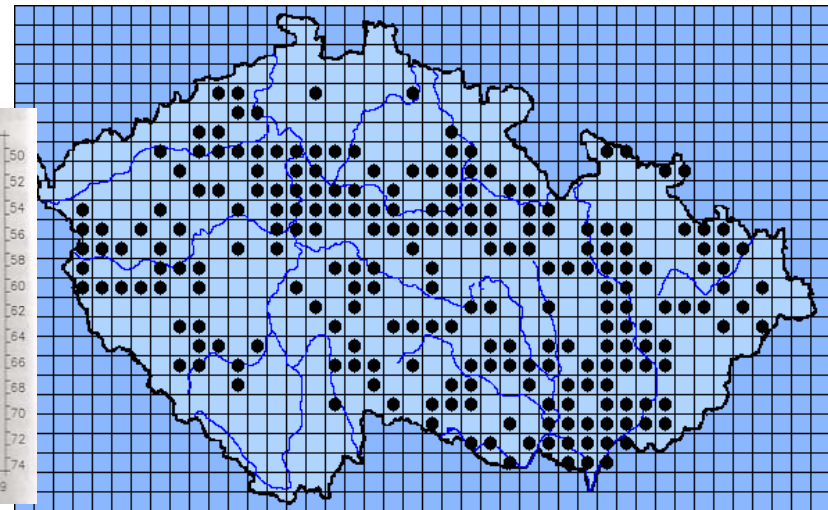



*Myodes glareolus* (Schreber, 1780)  
- norník rudý (*Clethrionomys glareolus*)

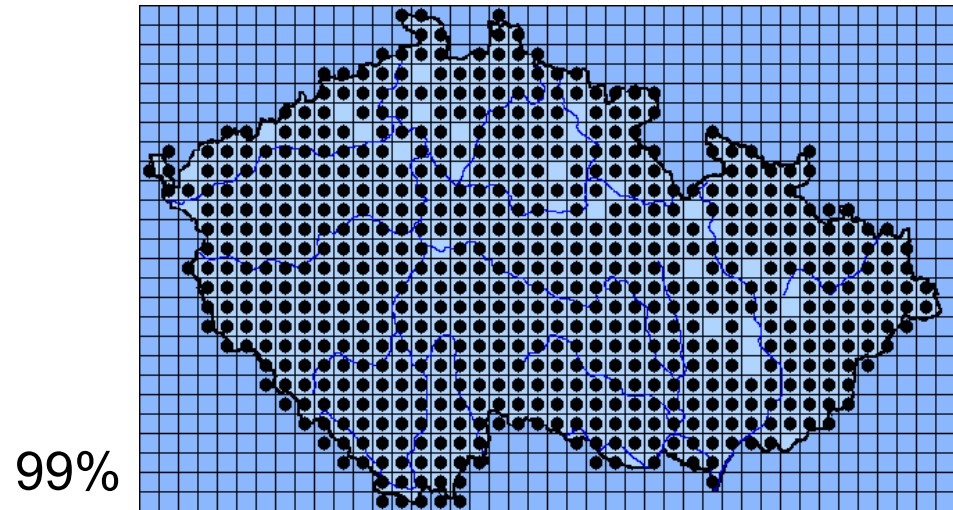
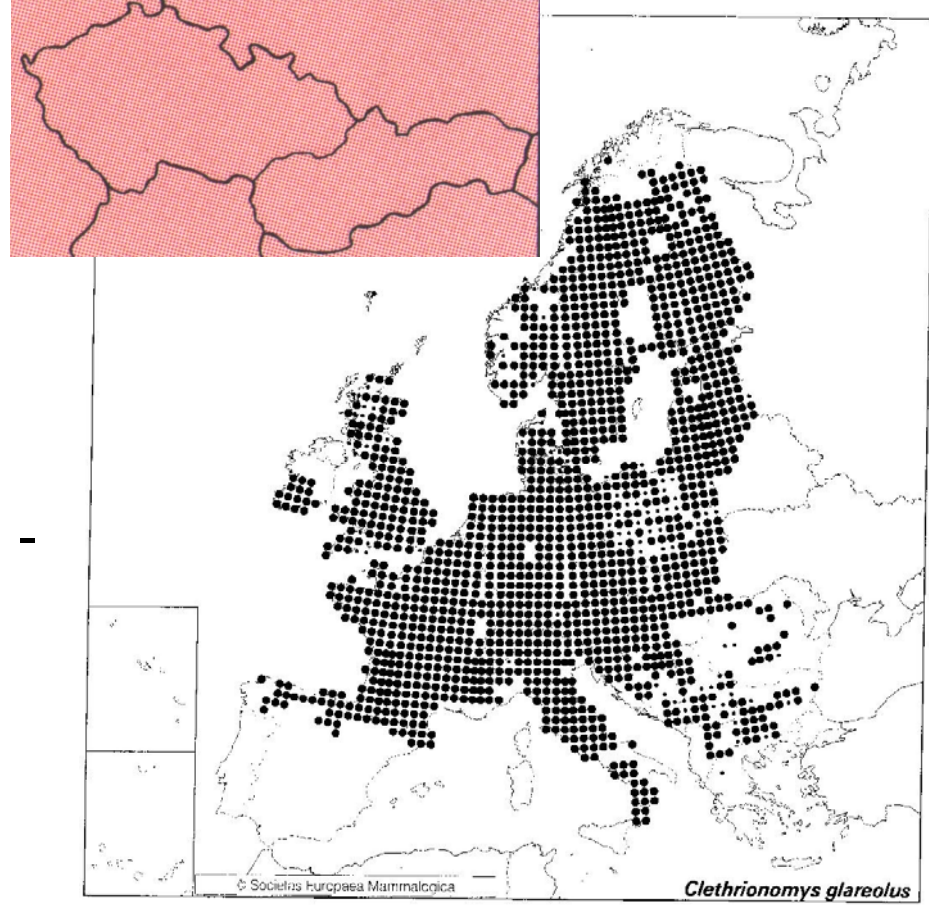

*Arvicola terrestris* (Linnaeus, 1758)  
- hryzec vodní (*A. amphibius*)



Mimo souvislé lesy, v blízkosti vody

-, -, -

67%

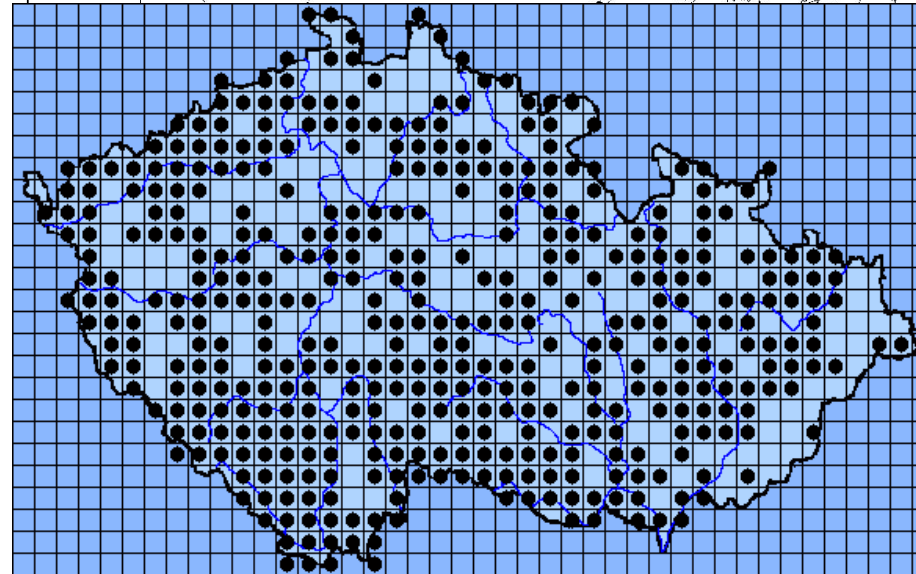
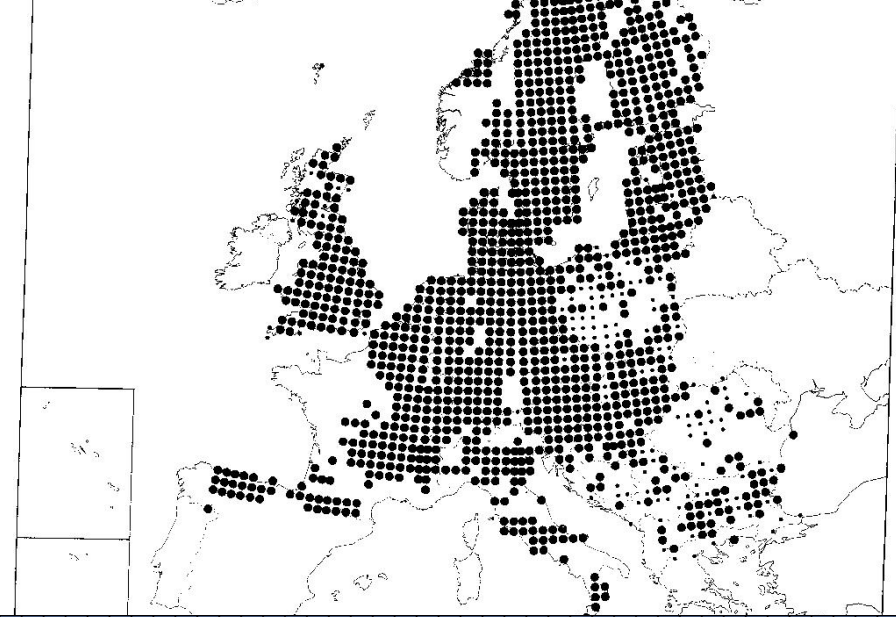
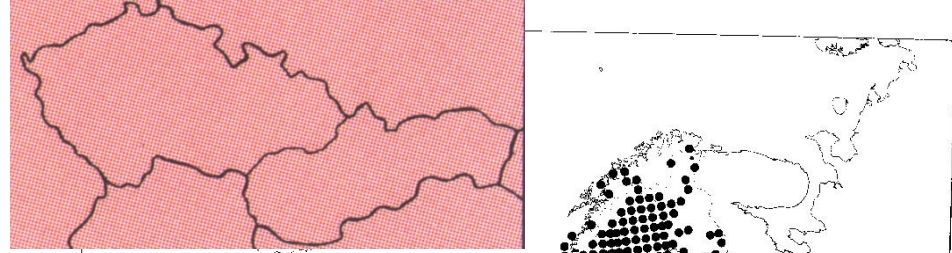

# *Ondatra zibethicus* (Linnaeus, 1766)

- ondatra pižmová



1905, 1906 vysázena u Dobříše,  
poprvé v Evropě, na Slovensku  
1921-1924

Úlovky – v Československu  
45 000 ks/ročně, dnes v ČR  
5 000; rákosiny.

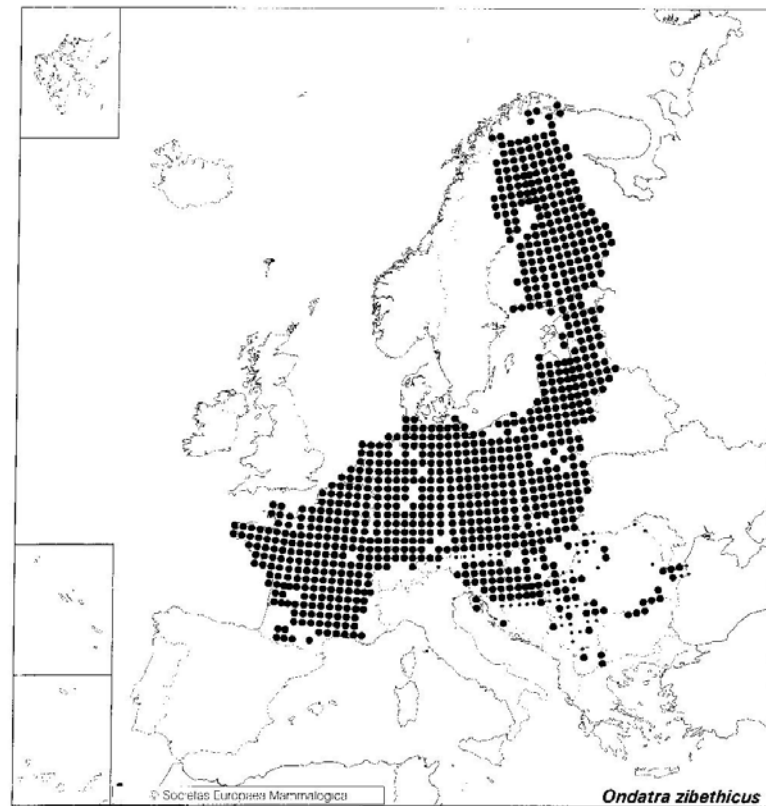

-, -, -

47%

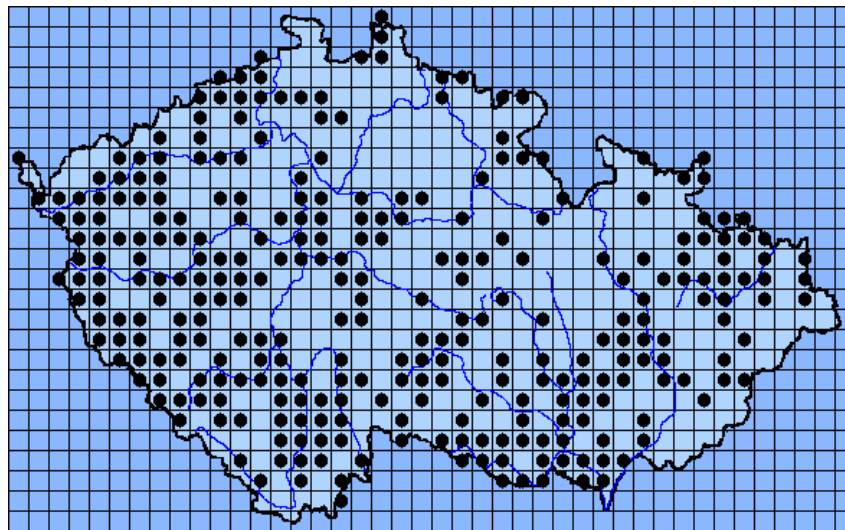

Am



*Microtus arvalis* (Pallas, 1778)

- hraboš polní



- , - , -

Zemědělská bezlesá krajina, stohy, i ve městech, na podzim v budovách, fluktuace početnosti (2-5 let) – gradace 2500 ks/ha, pesimum 2-5 ks/ha

*Microtus agrestis* (Linnaeus, 1761)

- hraboš mokřadní



- , - , -

Mozaikovitě, chladné a vlhké biotopy s hustým bylinným podrostem, lesy i louky, imisní holiny s *Calamagrostis villosa*

*Microtus arvalis* (Pallas, 1778)

- hraboš polní

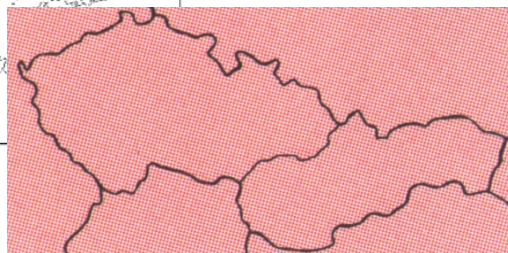
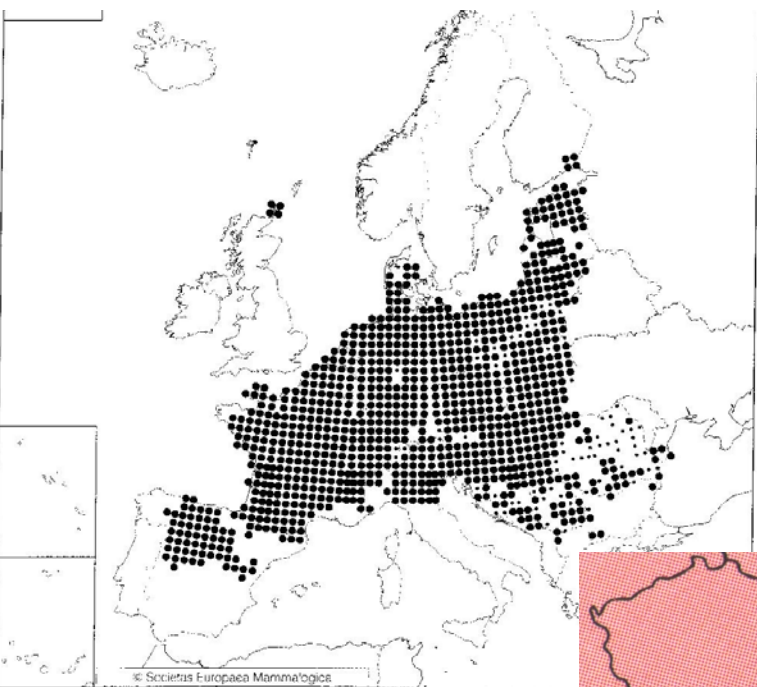

100%

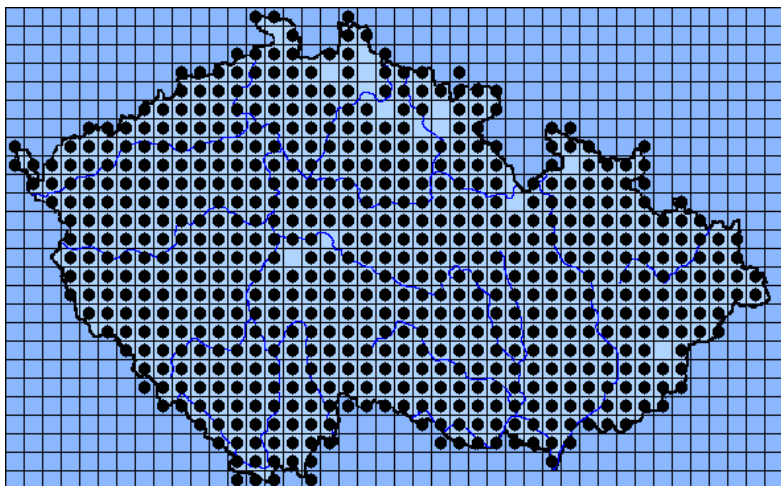

*Microtus agrestis* (Linnaeus, 1761)

- hraboš mokřadní

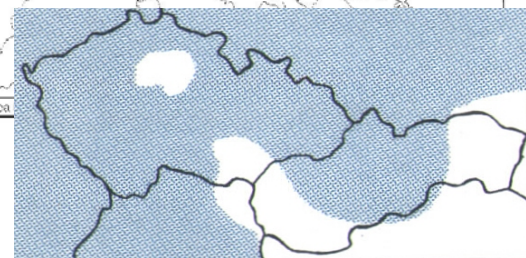
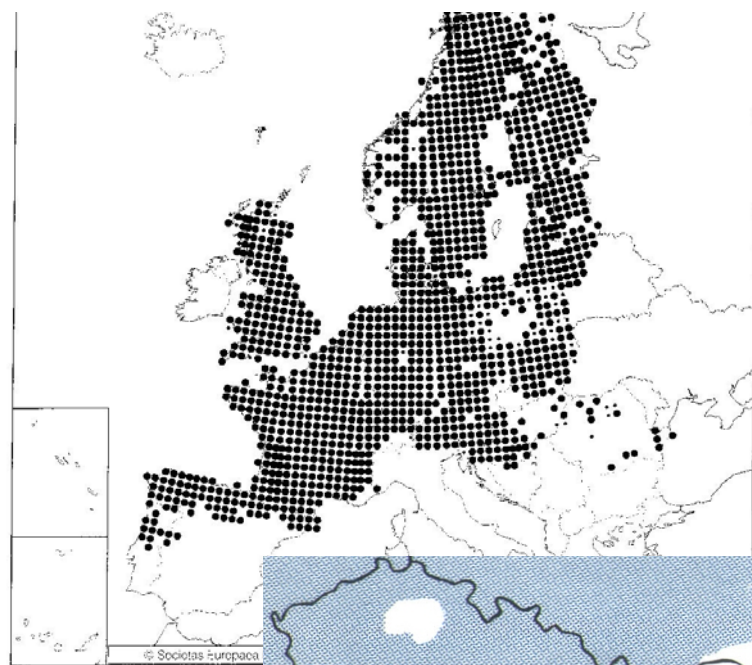

75%

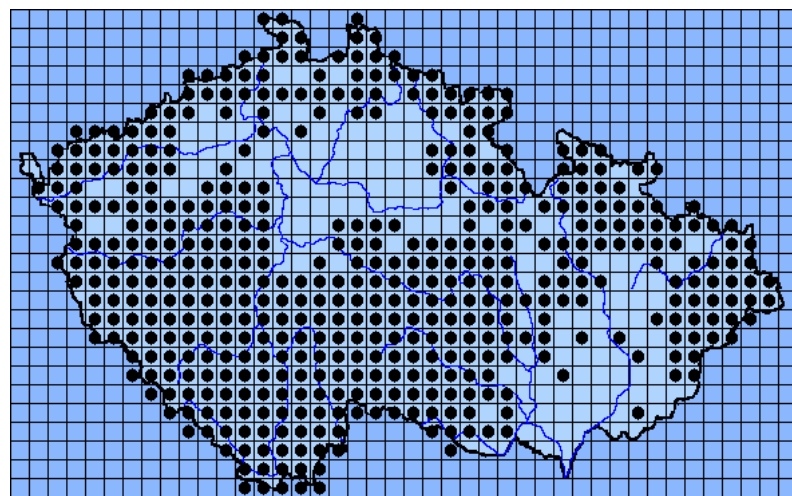

*Microtus oeconomus* (Pallas, 1776)  
- hraboš hospodárný



*Microtus tatricus* (Kratochvíl, 1952)  
- hrabošík tatranský



*Microtus oeconomus* (Pallas, 1776)  
- hraboš hospodárný

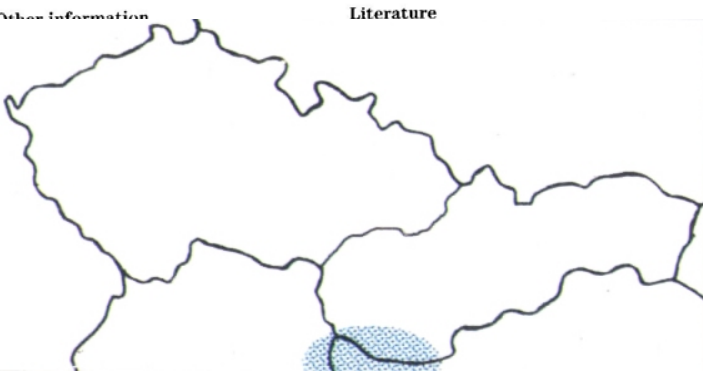
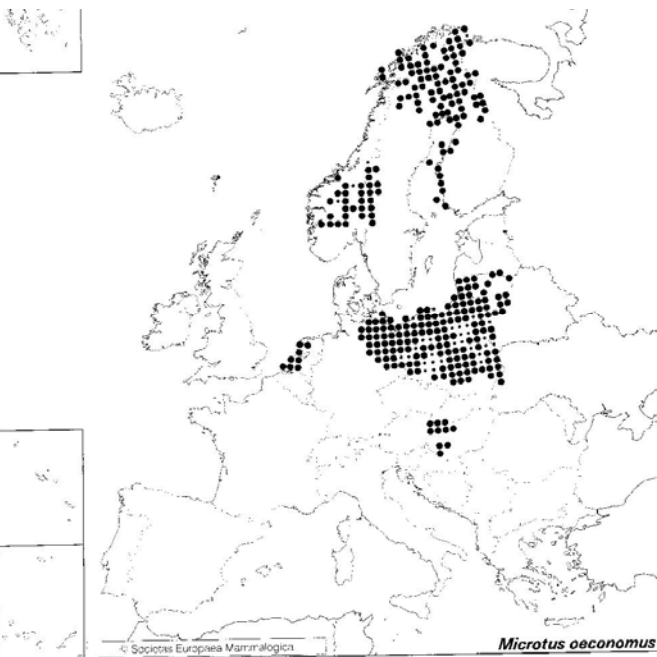

Jen Žitný ostrov a Podunajská nížina, v Rakousku a Maďarsku J-hranice areálu; vysoká voda – nadzemní kulovitá hnízda, nízká voda – podzemní nory.

*Microtus tatricus* (Kratochvíl, 1952)  
- hrabošík tatranský

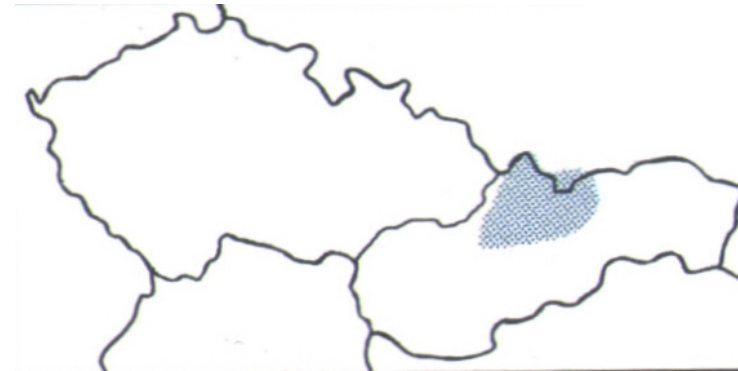
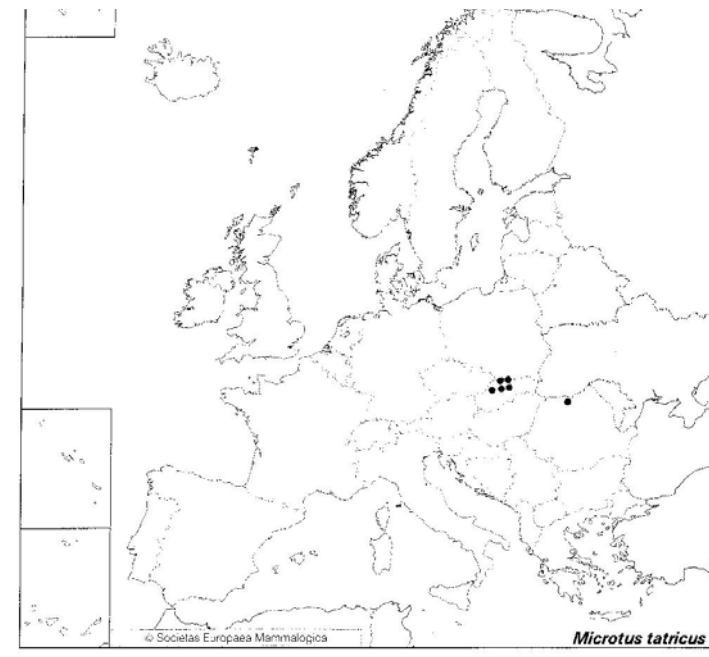

Jen na Slovesnku – Tatry, N Tatry, Oravské Beskydy, Fatra, Chočské vrchy, Kremnické vrchy, Muráňská planina, polské Tatry, horský druh

*Microtus subterraneus* (de Sélys-Longchamps, 1836)

- hrabošík podzemní



*Chionomys nivalis* (Martins, 1842)

- hraboš sněžný



-, -, -





*Microtus subterraneus*  
(de Sélys-Longchamps, 1836)  
- hrabošík podzemní

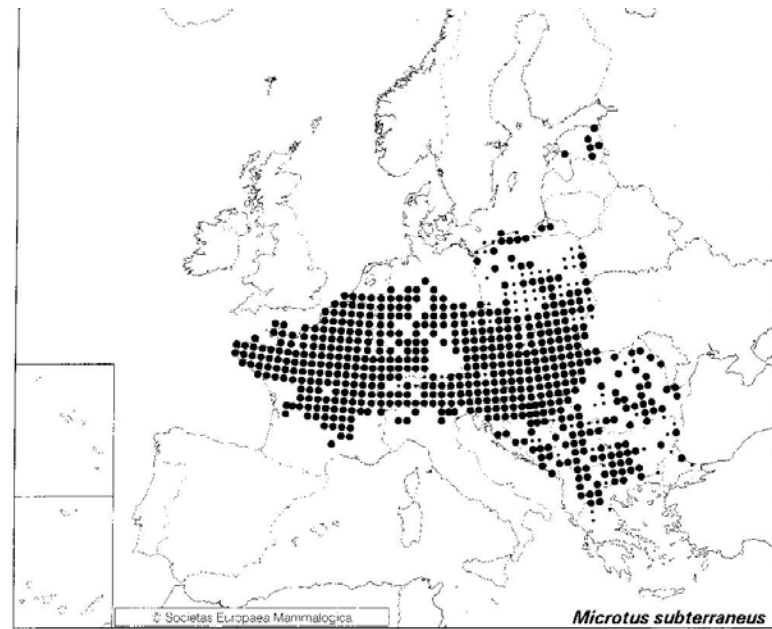

*Chionomys nivalis* (Martins, 1842)  
- hraboš sněžný

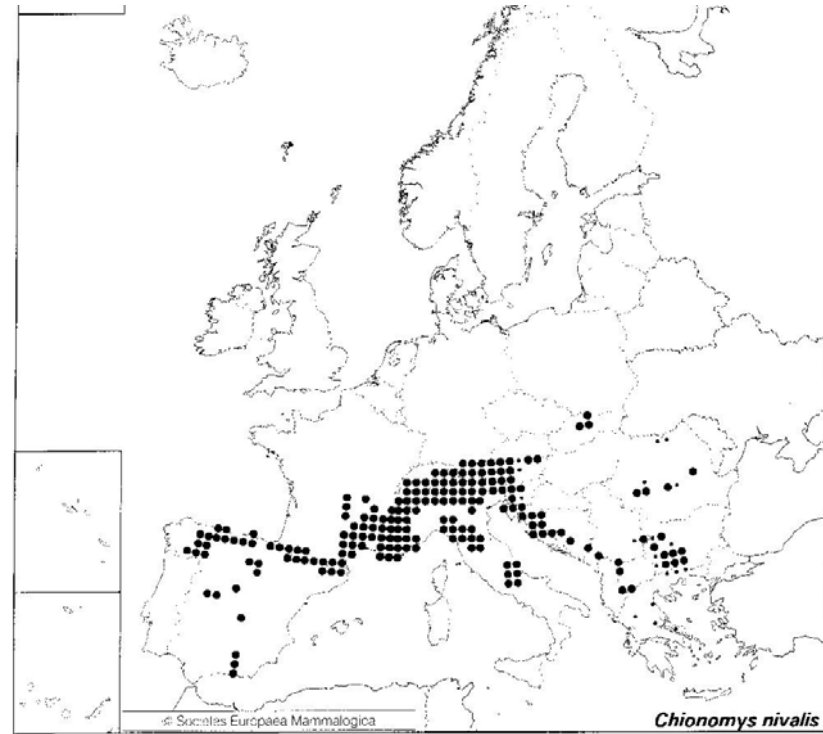

60%

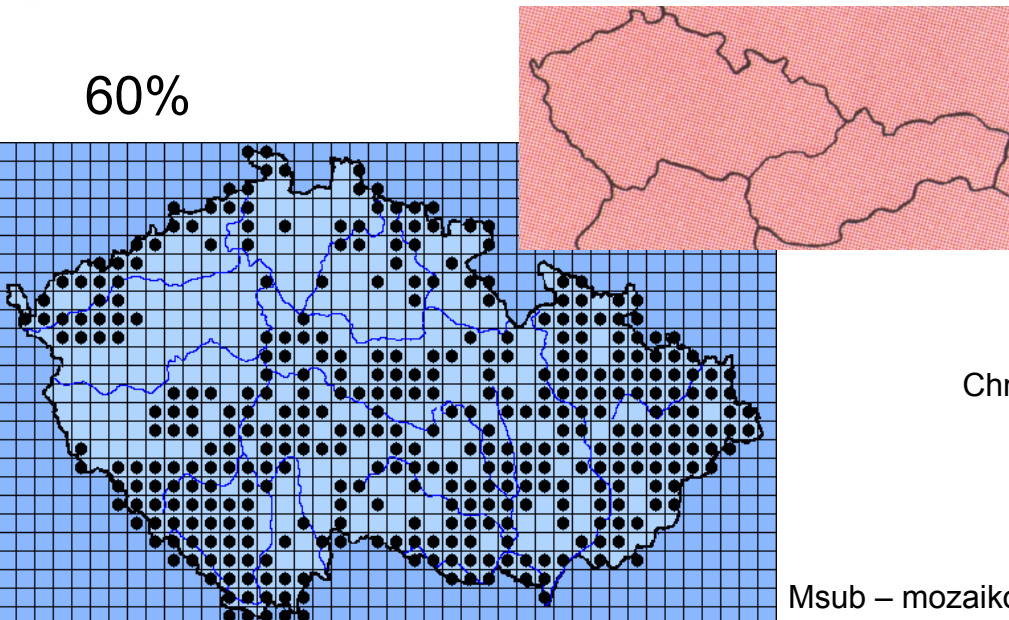

Chniv – TANAP a hřebeny NP Nízké Tatry, balvanité suti v horách

Msub – mozaikovitě, vlhká stanoviště různých biotopů.

*Apodemus flavicollis* (Melchior, 1834)  
- myšice lesní



*Apodemus sylvaticus* (Linnaeus, 1758)  
- myšice křovinná



© Miloš Anděra



© - josef hlasek  
www.hlasek.com  
*Apodemus flavicollis* a597



-, -, -

-, -, -

*Apodemus flavicollis* (Melchior, 1834)

- myšice lesní

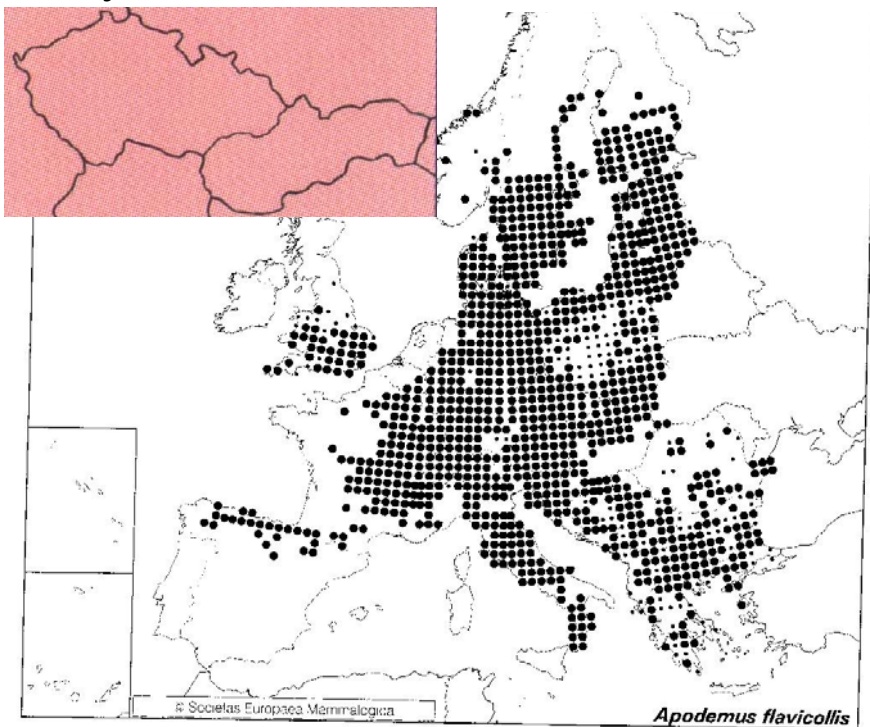

*Apodemus sylvaticus* (Linnaeus, 1758)

- myšice křovinná

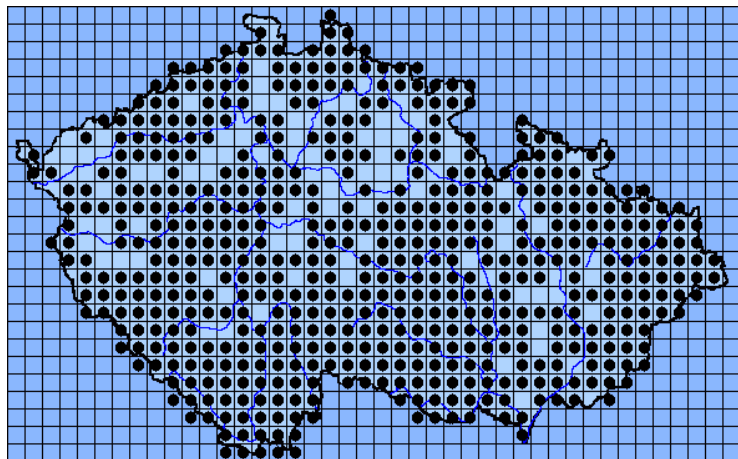
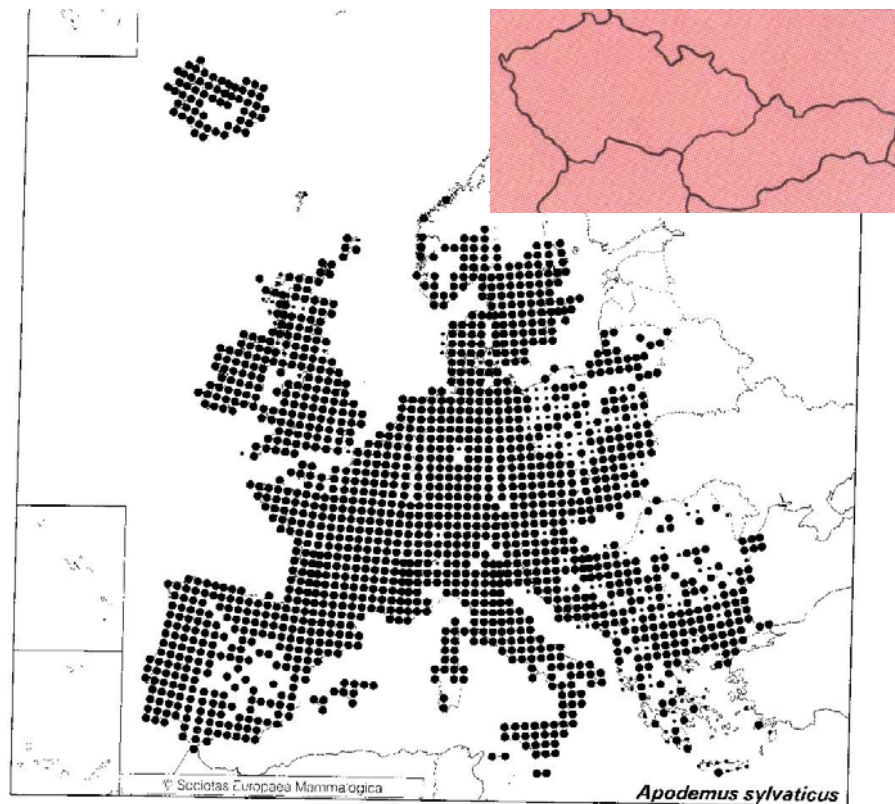

86%

93%

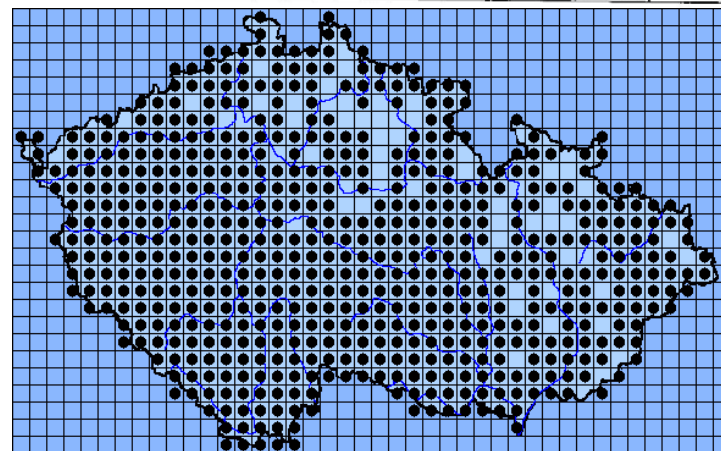

*Apodemus agrarius* (Pallas, 1771)  
- myšice temnopásá



-, -, -

*Apodemus microps* Kratochvíl et Rosický,  
1952 - myšice malooká

*A. uralensis* Pallas, 1811



-, -, -

# *Apodemus agrarius* - myšice temnopásá

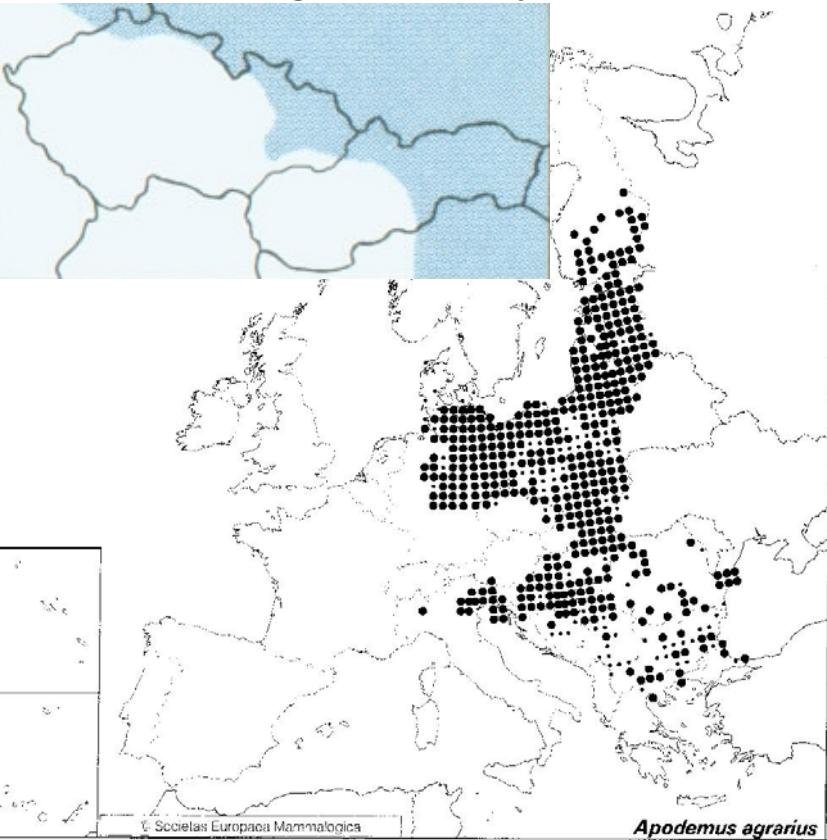

Vlhká místa, v blízkosti vod, nížiny až střední polohy

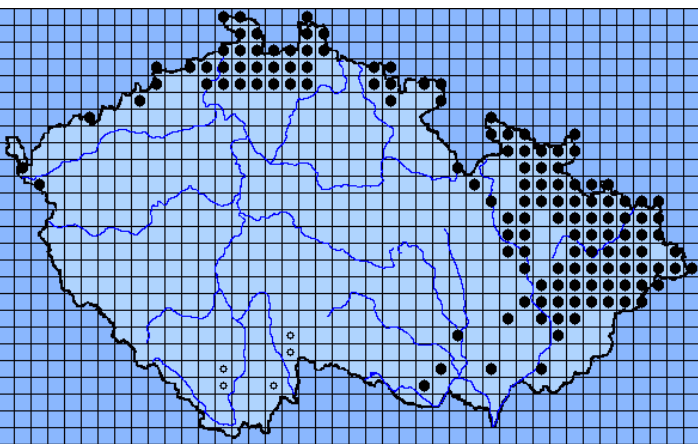

22%

# *Apodemus microps* - myšice malooká

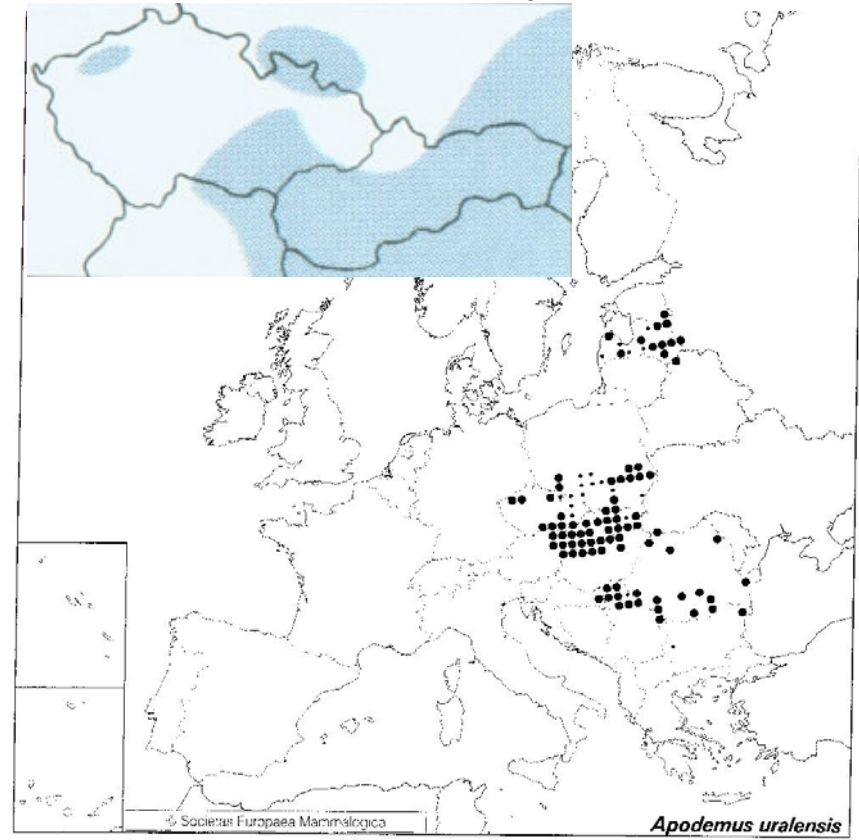

Teplé nížiny, v Čechách ostrůvkovitě, Morava a Slezsko, nížiny Slovenska, snad i Západní Tatry, známa až z J-Uralu.

8%

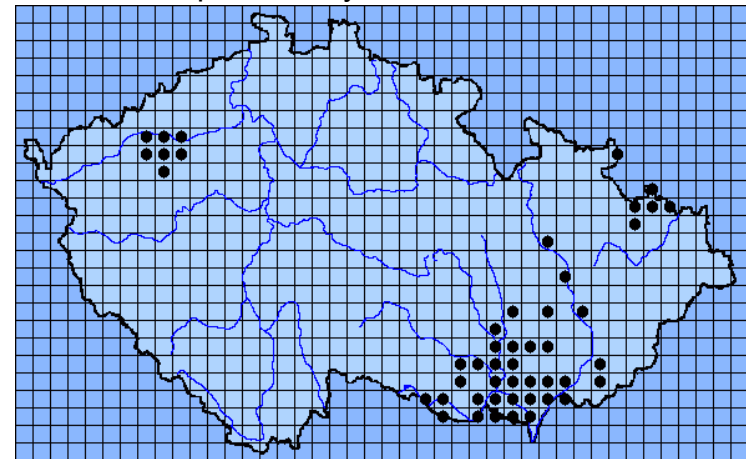

*Mus domesticus* Ruty, 1772  
- myš západoevropská



*Mus musculus* Linnaeus, 1758  
- myš domácí



-, -, -

-, -, -

© Miloš Anděra

www.naturfoto.cz

© - Josef Hlasek  
www.hlasek.com  
Mus musculus ag6966

*Mus domesticus* Ruty, 1772  
- myš západoevropská

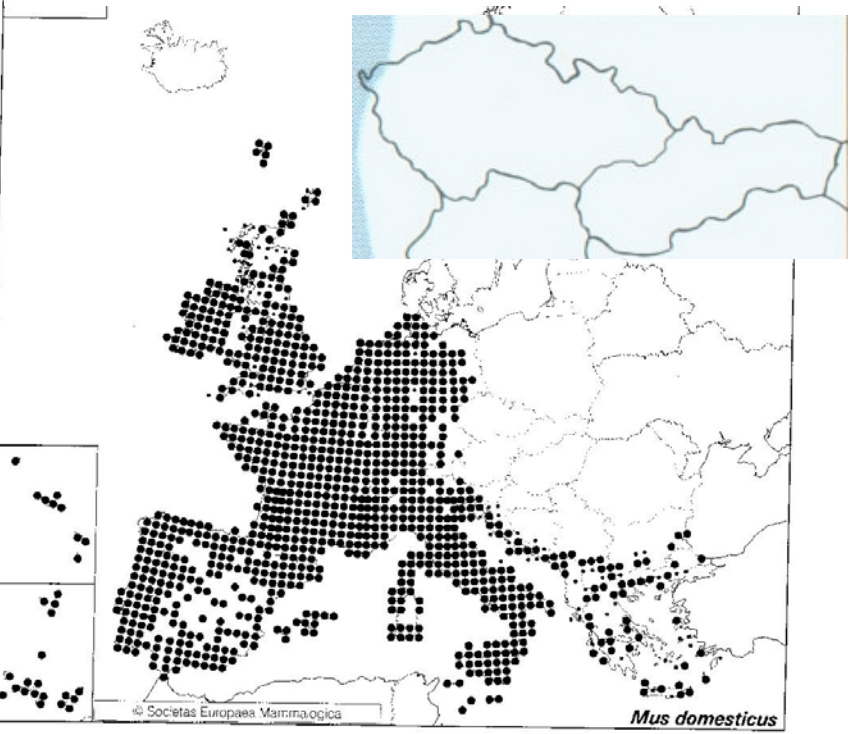

Other information Literature

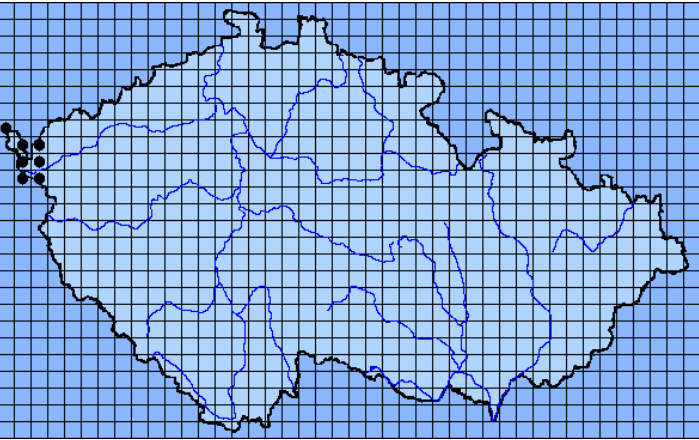

Okolí Aše a Chebu, synantrop

2%

*Mus musculus* Linnaeus, 1758  
- myš domácí

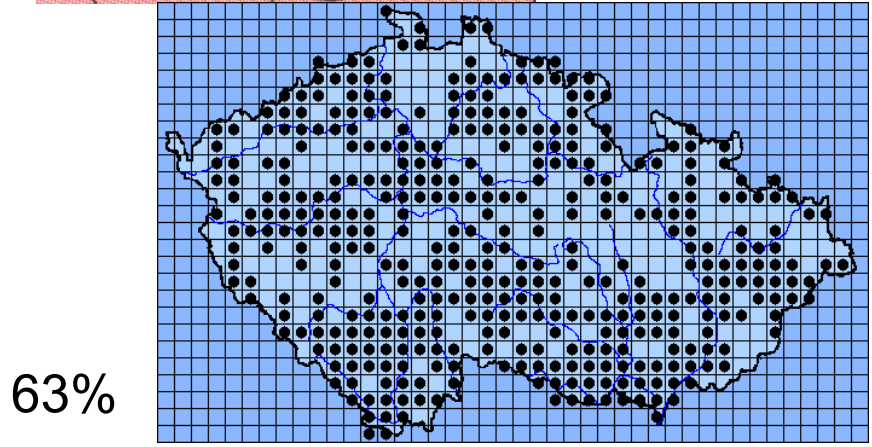
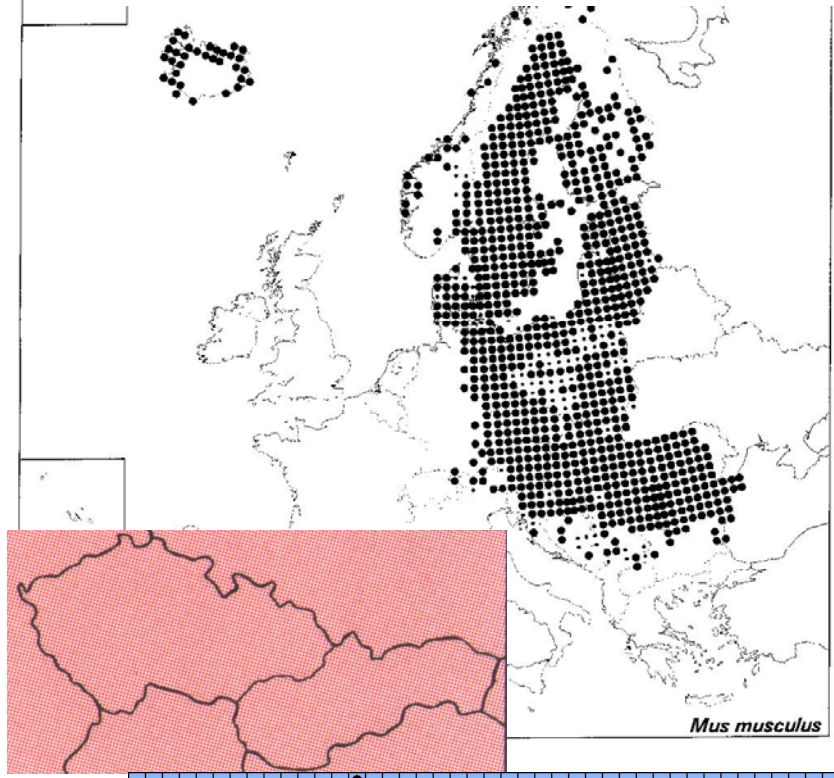

63%

Všude, ze stepí J Evropy a Asie, šíření se zemědělstvím

*Mus spicilegus* Petenyi, 1882  
- myš panonská

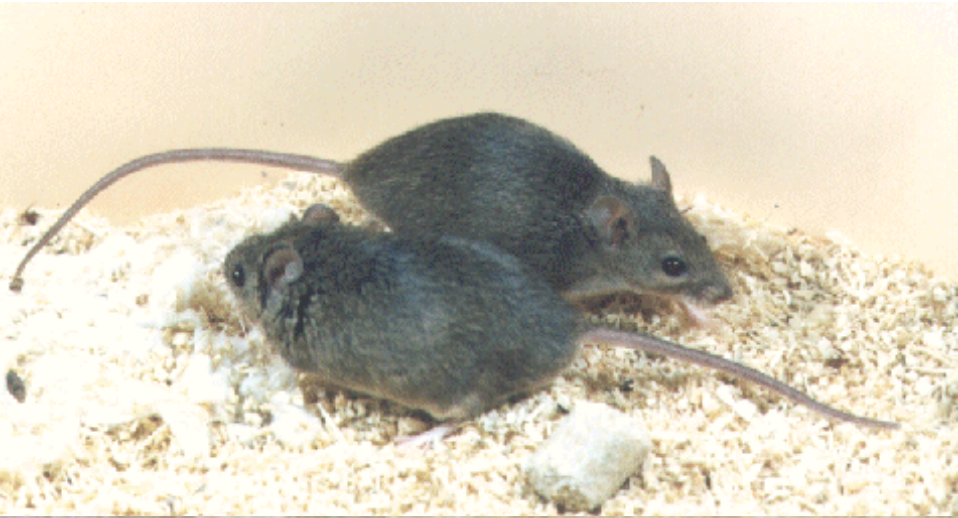

JZ Slovensko od Komárna po Nitrú a Levice, Košická kotlina, stepní druh, kupky (kurgančiky, 80 cm x 40 cm), pole, úhory, kupky na podzim

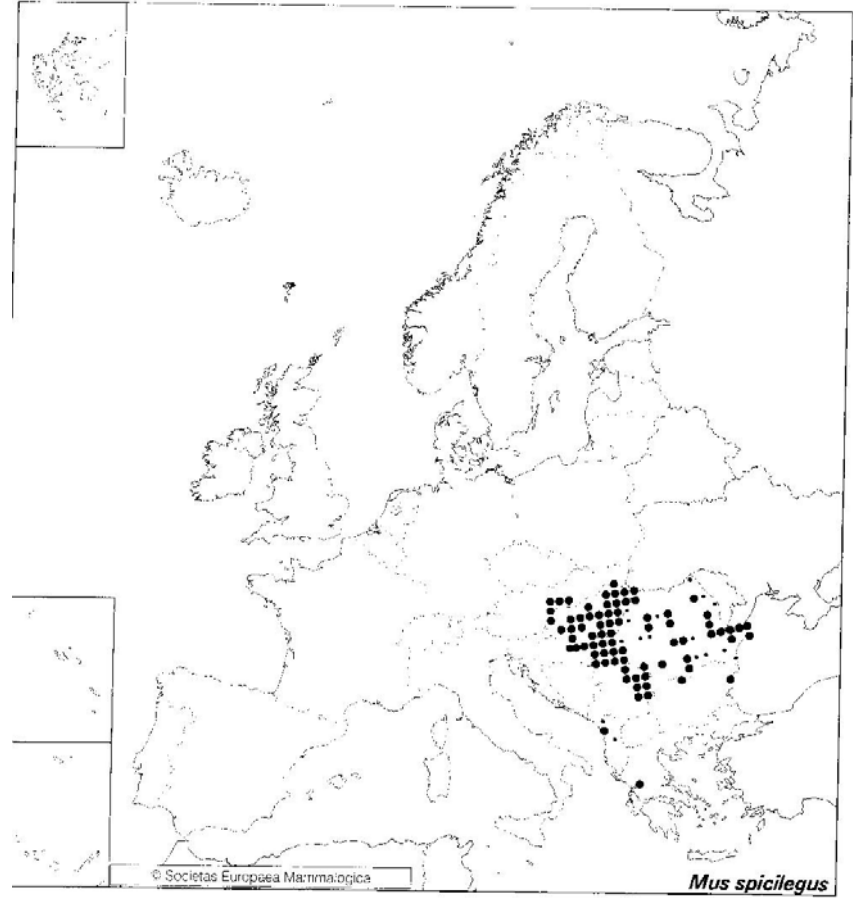



# Micromys minutus (Pallas, 1771)

- myška drobná

-, -, -



© Jiří Bohdal



© Miroslav Anděra

www.naturfoto.cz

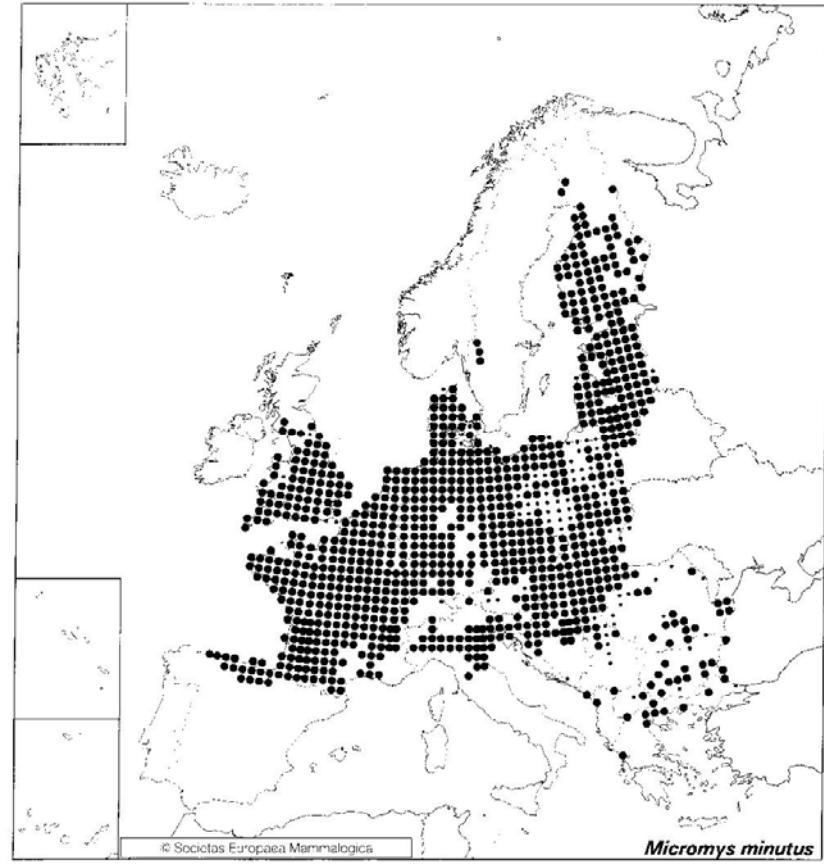

64%

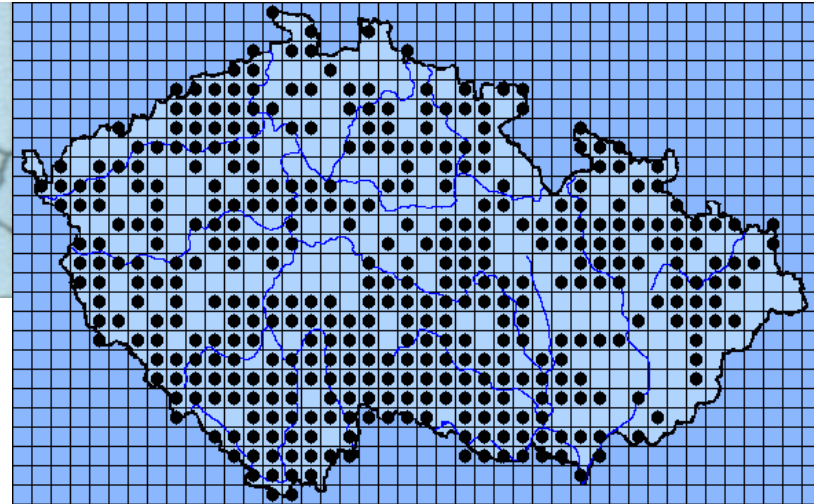

Nížiny u vod, rákosiny, louky, lužní lesy, kulovitá nadzemní hnízda až 1m nad zemí, v zimě ve stozích i norách jiných hlodavců

*Rattus rattus* (Linnaeus, 1758)

- krysa obecná



*Rattus norvegicus* (Berkenhout, 1769)

- potkan



*Rattus norvegicus*  
© Biopix.dk: JC Schou

Rrat - Z J-Asie, synantrop, v Evropě již 2-3000let, na konci středověku z Evropy vymizela, i díky potkanovi, opět od 1929 (Praha), zavlečení lodní dopravou po Labi, šíření 1945-1991 – okolí Labe, Ohře, Vltavy od Děčína po Prahu a MB, v SR – Bratislava – přístav (50. leta 20. st.)

Uvnitř budov – půdy, suchá skladiště, fytofág

Rnor – bažinaté obl. V-Asie, šíření potkana až po kryse – kanalizace ve městech, od 18. stol., loví i myši, dobře plave, šplhá, klany, omnivor



*Rattus rattus* (Linnaeus, 1758)

- krysa obecná

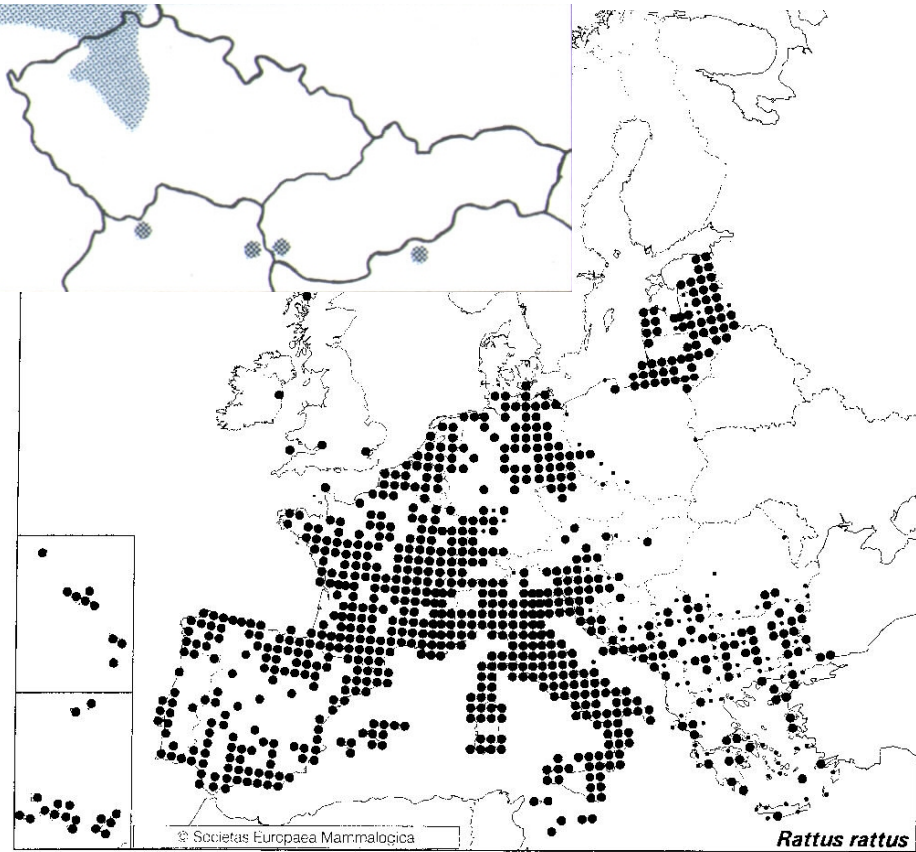

*Rattus norvegicus* (Berkenhout, 1769)

- potkan

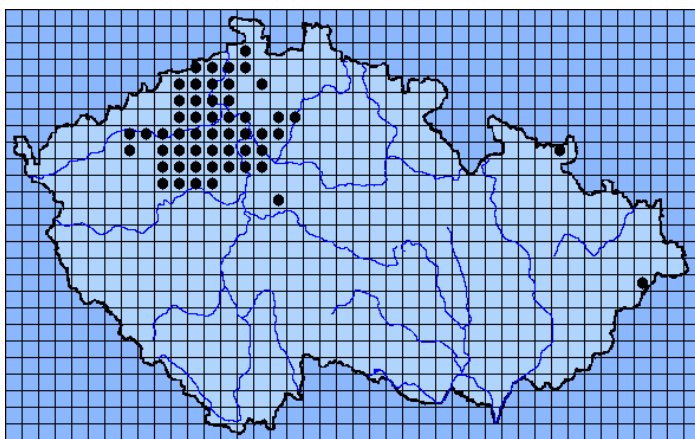
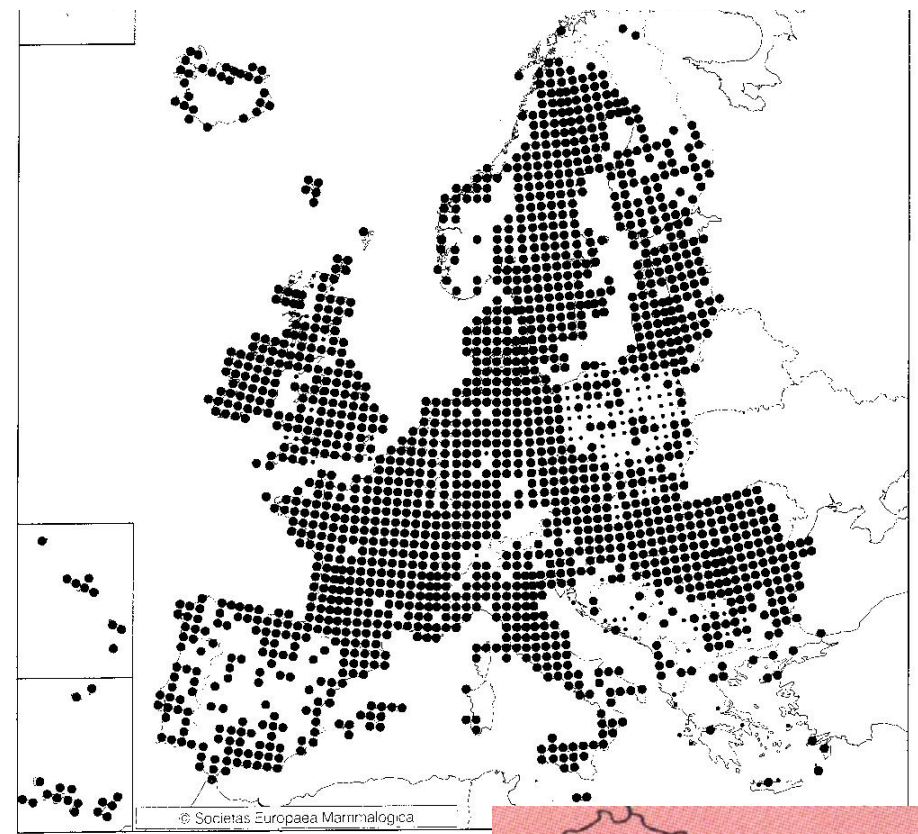

9%

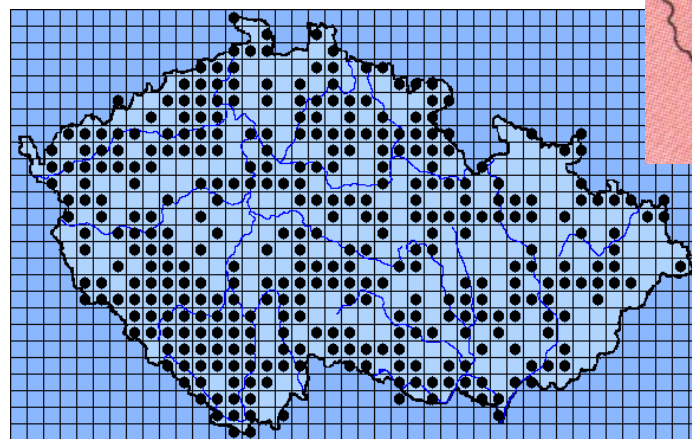

57%

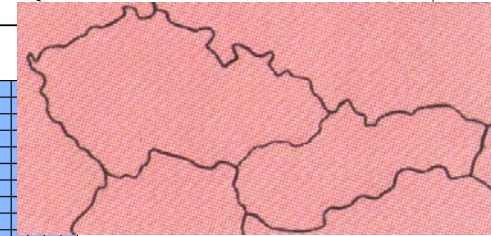

*Sicista betulina* Pallas, 1779  
– myšivka horská



VU, NT, SO

*Sicista subtilis* (Pallas, 1773)  
– myšivka stepní



# *Sicista betulina* Pallas, 1779

– myšivka horská

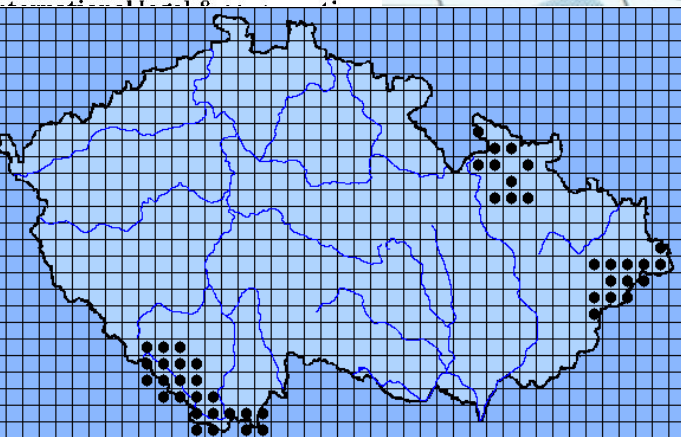
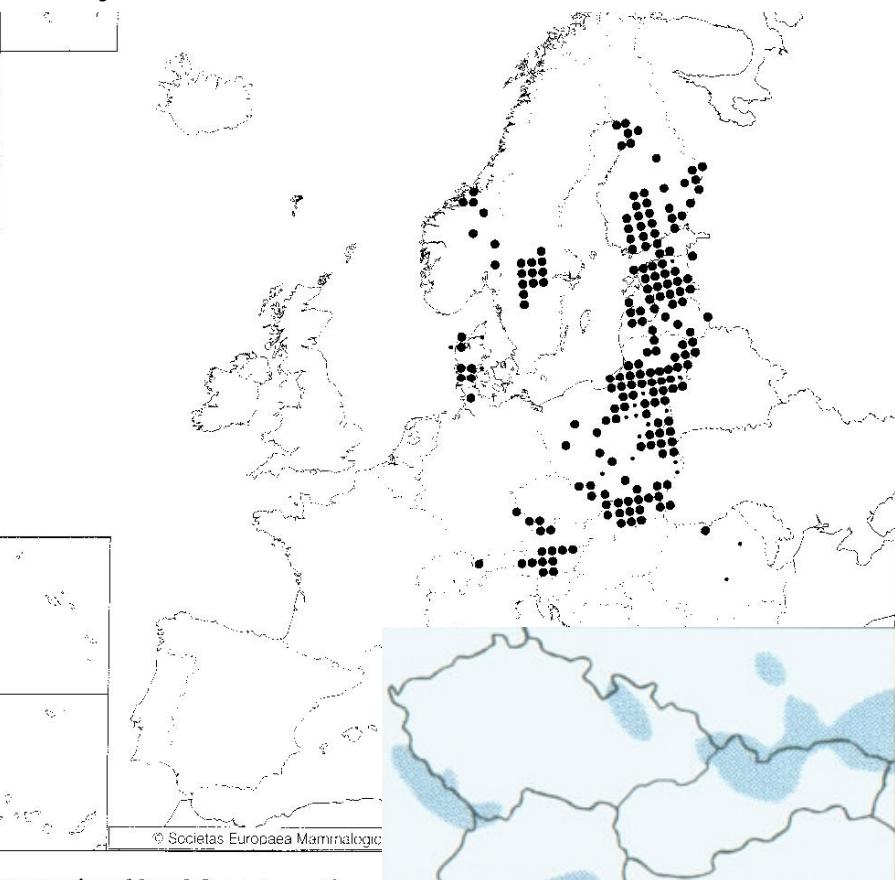

# *Sicista subtilis* (Pallas, 1773)

– myšivka stepní

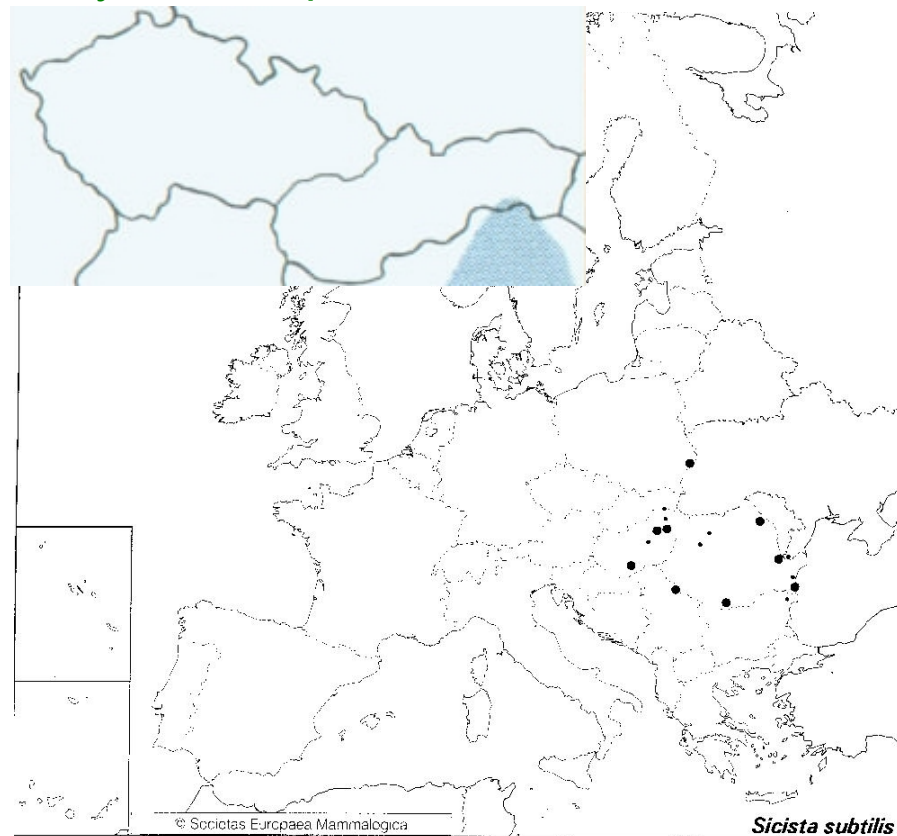

Sbet: Hory – Šumava, Novohradské h., Rychlebské h., Králický Sněžník, Jeseníky, Beskydy; Slovesné Beskydy, Fatra, Nízké tatry, Tatry, Slovenské rudohoří, Východní Karpaty; vlhká stanoviště

Ssub: jen 1x na Slovesnku 3.9.1935 u Lubice, dnes jen v Maďarsku, v SV Rakousku vymřela

# Lagomorpha - zajíci

## Leporidae - zajícovití

*Lepus europaeus* Pallas, 1778 - zajíc polní

*Oryctolagus cuniculus* (Linnaeus, 1758) – králík divoký

# *Lepus europaeus* Pallas, 1778

- zajíc polní

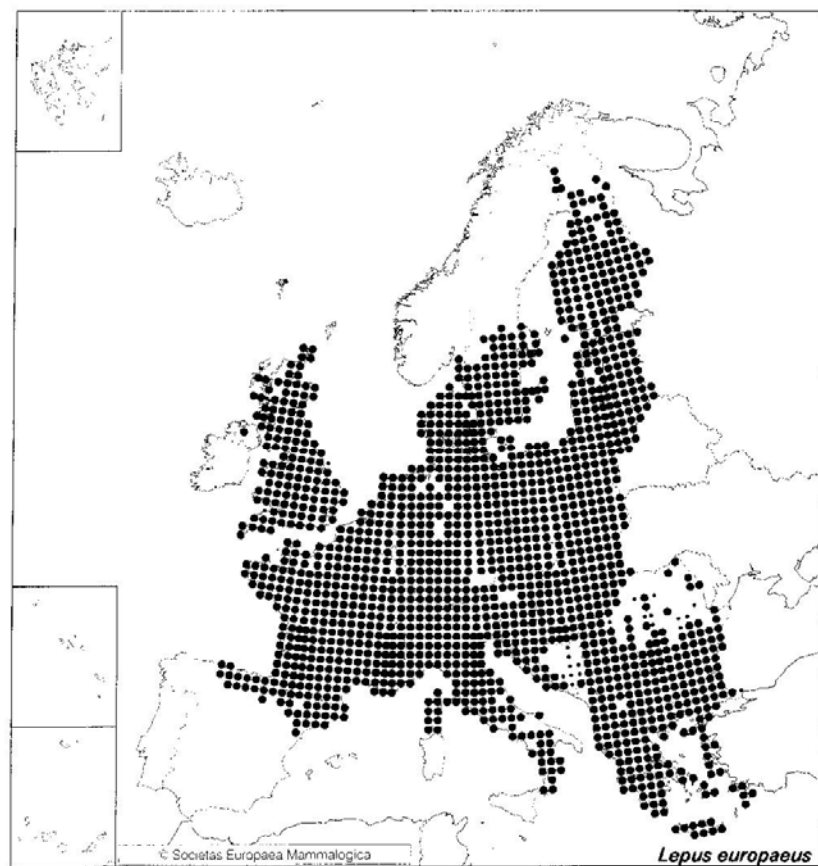

NT, -, -

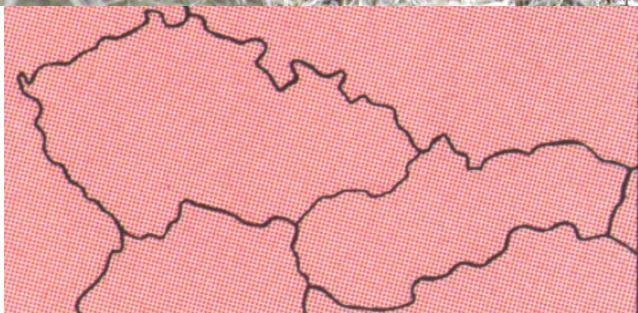

50%

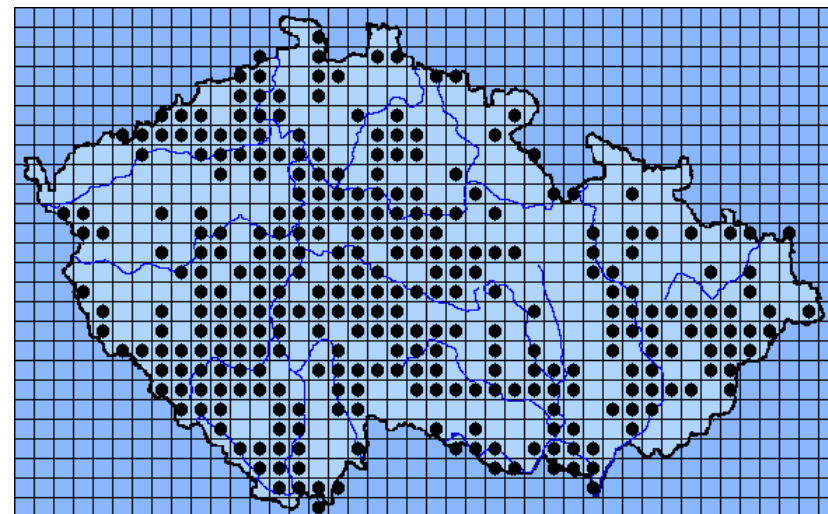

Středoevropský druh, preference otevřených biotopů v nižších nadm. výškách, superfetace, ještě v roce 1974 – roční odstřel v Československu přes 1 mil. ks., pak prudký pokles početnosti (choroby, nevhodný lov), dnes početnost ustálena, ale nižší než v 70. letech, regulovaný odstřel, dnes v ČR celkem asi 0,5 mil. Ks, v SR asi 200 000 ks

# *Oryctolagus cuniculus* (Linnaeus, 1758) - králík divoký

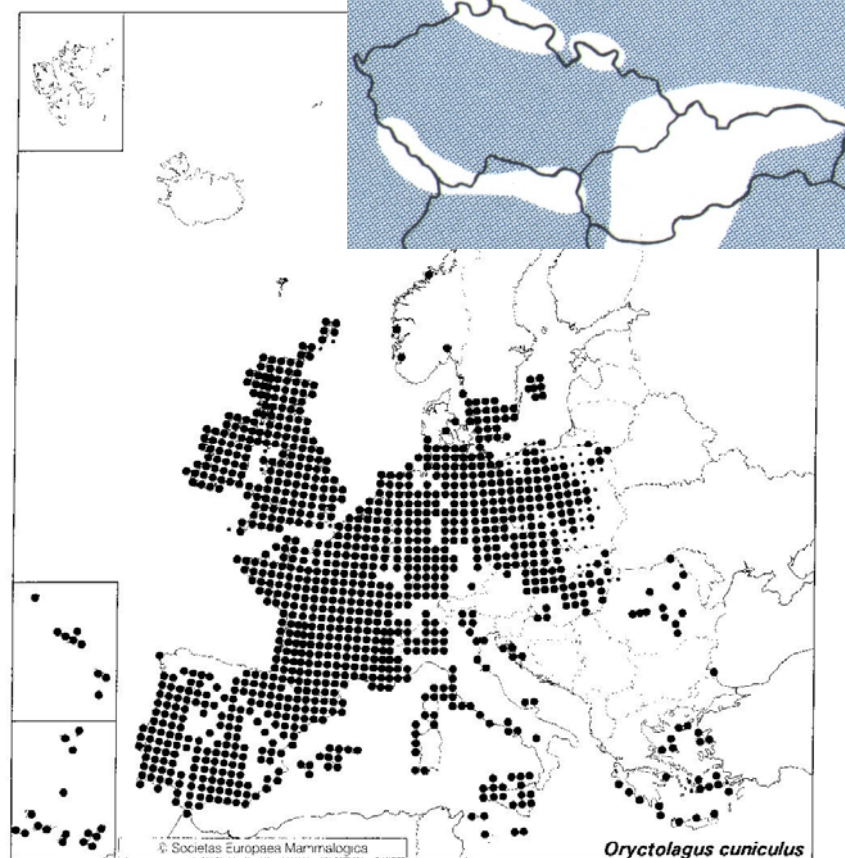

Allochtonní druh z mediteránu, ve středověku již ve volné přírodě stř. Evropy, dnešní rozšíření od 19. stol., teplá suchá místa s písčitou půdou do středních poloh, skupinová teritoria, do 1952 – roční odstřel okolo 200 000 ks, myxomatóza – snižování početnosti, koncem 20. století místy vymizel nebo je vzácný, v ČR v r. 1999 odstřel 231 kus, v SR v r. 2001 stav 705 ks, odstřel 84 ks.

71%

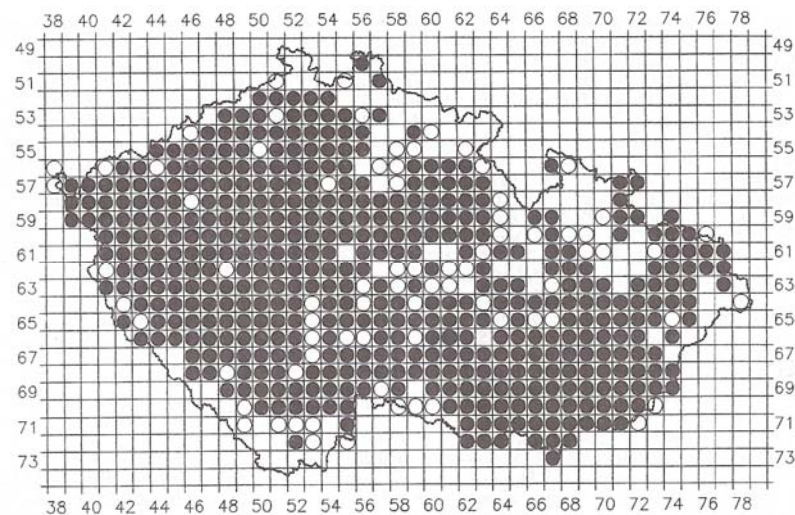



## ČR, SR - současný výskyt ve volných vodách

ČS a IUCN Plesník et al., 2004: Červený seznam obratlovců z území ČR, Příroda, Praha, 22; 2008 IUCN Red List of Threatened Species ([www.redlist.org](http://www.redlist.org))

EX	Extinct	Vyhynulý
EW	Extinct in the wild	Vyhynulý nebo vyhubený ve volné přírodě
RE	Regionally extinct	Regionálně vymizelý
CR	Critically endangered	Kriticky ohrožený
EN	Endangered	Ohrožený
VU	Vulnerable	Zranitelný
NT	Near threatened	Téměř ohrožený
LC	Least concern	Málo dotčený
DD	Data deficient	Nedostatečné údaje
NE	Not evaluated	Nevyhodnocený

### Vyhláška č. 395/92, zákon č. 114/92, o ochraně přírody a krajiny

KO	kriticky ohrožený
SO	silně ohrožený
O	ohrožený

### MD - mezinárodní úmluvy a dohody

Bern	druh zařazený v přílohách (II, III)	Úmluvy o ochraně evropské fauny a flóry
Bonn	druh zařazený v přílohách (II)	Úmluvy o ochraně stěhovavých druhů volně žijících živočichů
Cites	druh zařazený v přílohách (I, II)	Úmluvy o mezinárodním obchodu ohroženými druhy volně žijících živočichů a planě rostoucích rostlin (Washington)

### ES - legislativa ES

Habitats	druh zařazený v přílohách (II, V)	Směrnice č. 79/409/EC o ochraně přírodních stanovišť volně žijících živočichů a planě rostoucích rostlin
----------	-----------------------------------	--

- druh s přirozeným výskytem
- nepůvodní druh člověkem vysazený, příp. chovaný v zajetí, nebo uniklý z chovu
- druh, který se nikdy nevyskytoval

Druh		Species	ČR	SR	ČS	IUCN	vyhl. 395	vyhl. 175	MD	ES
ježek západní	jež tmavý	<i>Erinaceus europaeus</i>	+	+			-	-		
ježek východní	jež bledý	<i>Erinaceus concolor</i>	+	+			-	-		
rejsek obecný	piskor lesný	<i>Sorex araneus</i>	+	+			-	-		
rejsek malý	piskor malý	<i>Sorex minutus</i>	+	+			-	-		
rejsek horský	piskor horský	<i>Sorex alpinus</i>	+	+	VU	-	SO	SO	Bem III	-
rejsec vodní	dulovnica vodná	<i>Neomys fodiens</i>	+	+			-	-		
rejsec černý	dulovnica menšia	<i>Neomys anomalus</i>	+	+			-	-		
bělozubka šedá	bielozubka bielobruchá	<i>Crociodura suaveolens</i>	+	+			-	-		
bělozubka bělobřichá	bielozubka krpátá	<i>Crociodura leucodon</i>	+	+			O	O		
bělozubka tmavá	bielozubka tmavá	<i>Crociodura russula</i>	-	-						
krtek obecný	krt podzemný	<i>Talpa europaea</i>	+	+			-	-		
vrápenec malý	podkovár krpátý	<i>Rhinolophus hipposideros</i>	+	+	EN	VU	KO	KO	Bem II, EUROBATS	Habitats II
vrápenec velký	podkovár štíhlokridly	<i>Rhinolophus ferrumequinum</i>	+	+	CR	LR	KO	KO	Bem II, EUROBATS	Habitats II
vrápenec jižní	podkovár južný	<i>Rhinolophus euryale</i>	-	+						
netopýr vousatý	netopier fúzatý	<i>Myotis mystacinus</i>	+	+			-	SO		
netopýr menší		<i>Myotis alcathoe</i>	?	+			-	SO		
netopýr Brandtův	netopier Brandtov	<i>Myotis brandtii</i>	+	+			O	SO		
netopýr velkouchý	netopier veľkouchý	<i>Myotis bechsteinii</i>	+	+	DD	VU	SO	SO	EUROBATS	Habitats IV
netopýr brvitý	netopier brvitý	<i>Myotis emarginatus</i>	+	+	VU	VU	O	KO	Bem II, EUROBATS	Habitats
netopýr řasnatý	netopier riasnatý	<i>Myotis nattereri</i>	+	+			-	SO		
netopýr velký	netopier veľký	<i>Myotis myotis</i>	+	+	VU	NT	SO	KO	Bem II, EUROBATS	Habitats II
netopýr východní (ostr)	netopier ostrouchý	<i>Myotis blythii</i>	+	+	CR		SO	SO	Bem I, EUROBATS	Habitats II
netopýr vodní	netopier vodný	<i>Myotis daubentonii</i>	+	+			-	SO		
netopýr pobřežní	netopier pobrežný	<i>Myotis dasycneme</i>	+	+	CR	VU	SO	KO	Bem II, EUROBATS	Habitats II
netopýr pestrý	netopier pestrý	<i>Vespertilio murinus</i>	+	+	DD	-	O	SO	Bem II, EUROBATS	Habitats IV
netopýr večerní	netopier pozdný	<i>Eptesicus serotinus</i>	+	+			-	SO		
netopýr severní	netopier severský	<i>Eptesicus nilssonii</i>	+	+			-	SO		
netopýr rezavý	netopier hrdzavý	<i>Nyctalus noctula</i>	+	+			-	SO		
netopýr stromový	netopier stromový	<i>Nyctalus leisleri</i>	+	+	DD	NT	SO	SO	Bem II, EUROBATS	Habitats IV
netopýr obrovský	netopier východný	<i>Nyctalus lasiopterus</i>	?	+			-	SO		
netopýr hvízdavý	netopier hvízdavý	<i>Pipistrellus pipistrellus</i>	+	+			-	SO		
netopýr nejmenší	netopier najmenší	<i>Pipistrellus pygmaeus</i>	+	+	DD		-	SO	Bem II, EUROBATS	Habitats IV
netopýr parkový	netopier parkový	<i>Pipistrellus nathusii</i>	+	+	DD		SO	SO	Bem II, EUROBATS	Habitats IV
netopýr jižní	netopier južný	<i>Pipistrellus kuhlii</i>	-	-	-		-	SO		
netopýr Saviův	netopier horský	<i>Hypsugo savii</i>	+	+	DD		-	SO	Bem II, Bonn II, EUROBATS	-
netopýr ušatý	netopier svetlý	<i>Plecotus auritus</i>	+	+			-	SO		
netopýr dlouhouchý	netopier sivý	<i>Plecotus austriacus</i>	+	+			O	SO		
netopýr černý	netopier čierny	<i>Barbastella barbastellus</i>	+	+			SO	KO		
létavec stěhovavý	netopier sťahovavý	<i>Miniopterus schreibersii</i>	-	+						
prase divoké	diviak lesný	<i>Sus scropha</i>	+	+			-	-		
srnec obecný	srnec lesný	<i>Capreolus capreolus</i>	+	+			-	-		
los	los mokrad'ový	<i>Alces alces</i>	+	+	EN	-	SO	SO	-	-
jelenec běloocasý	pasrnec viržinský	<i>Odocoileus virginianus</i>	+	-						
jelen lesní	jeleň lesný	<i>Cervus elaphus</i>	+	+			-	-		
sika	jeleň sika	<i>Cervus nippon</i>	+	-						
daněk evropský	daniel škvmitý	<i>Cervus dama</i>	+	+						
koza bezoárová	koza bezoárová	<i>Capra aegagrus</i>	-	-						
kamzík horský	kamzík vrchovský	<i>Rupicapra rupicapra</i>	+	+			-	-		
muflon	muflón hôrny	<i>Ovis musimon</i>	+	+						
paouec hrivnatá	ovca hrivnatá	<i>Ammotragus lervia</i>	+	-						
zubr	zubor hrivnatý	<i>Bison bonasus</i>	-	+	RE	EN	-	-	Bem III	-

Druh		Species	ČR	SR	ČS	IUCN	vyhl. 395	vyhl. 175	MD	ES
mýval severní	medvedík čistotný	<i>Procyon lotor</i>	+	+						
kolčava	lasica myšožravá	<i>Mustela nivalis</i>	+	+			-	-		
hranostaj	hranostaj čiernochovstý	<i>Mustela erminea</i>	+	+			-	-		
norek evropský	norok európsky	<i>Mustela lutreola</i>	-	-	RE	-	-	-	Bern II	Habitats II
norek americký	norok americký	<i>Mustela vison</i>	+	?						
tchoř tmavý	tchoř tmavý	<i>Mustela putorius</i>	+	+	DD	-	-	-	-	-
tchoř stepní	tchoř stepný	<i>Mustela eversmannii</i>	+	+	EN	-	O	KO	Bern II	-
kuna lesní	kuna lesná	<i>Martes martes</i>	+	+			-	-		
kuna skalní	kuna skalná	<i>Martes foina</i>	+	+			-	-		
jezevec lesní	jazvec lesný	<i>Meles meles</i>	+	+			-	-		
vydra říční	vydra riečna	<i>Lutra lutra</i>	+	+	VU	VU	SO	SO	Bern II, Cites I	Habitats II
medvěd hnědý	medveď hnedý	<i>Ursus arctos</i>	+	+	CR	-	KO	KO	Bern II, Cites II	Habitats II
vlk obecný	vlk dravý	<i>Canis lupus</i>	+	+	CR	-	KO	KO	Bern II, Cites II	Habitats
šakal obecný	šakal obyčajný	<i>Canis aureus</i>	-	+						
psík mývalovitý	psík medvedíkovitý	<i>Nyctereutes procyonoides</i>	+	+						
liška obecná	liška hrdzavá	<i>Vulpes vulpes</i>	+	+			-	-		
kočka divoká	mačka lesná	<i>Felis silvestris</i>	?	+	DD	-	KO	KO	Bern II, Cites II	Habitats IV
rys ostrovid	rys ostrovid	<i>Lynx lynx</i>	+	+	EN	NT	SO	SO	-	-
plšík lískový	plch lieskový	<i>Muscardinus avellanarius</i>	+	+			-	SO		
plch velký	plch sivý	<i>Glis glis</i>	+	+	DD	NT	O	O	Bern III	-
plch lesní	plch lesný	<i>Dryomys nitedula</i>	+	+			O	SO		
plch zahradní	plch záhradný	<i>Eliomys quercinus</i>	+	+	EN	VU	KO	KO	Bern III	-
veverka obecná	veverka stromová	<i>Sciurus vulgaris</i>	+	+	NE	NT	O	O	Bern III	-
sysel obecný	sysel' pasienkový	<i>Spermophilus citellus</i>	+	+	CR	VU	KO	KO	Bern II	-
svíšť horský	svíšť vrchovský	<i>Marmota marmota</i>	-	+						
nutria říční	nutria riečna	<i>Myocastor coypus</i>	+	+						
bobr evropský	bobor vodný	<i>Castor fiber</i>	+	+	VU	NT	KO	SO	Bern III	Habitats II
bobr kanadský	bobor kanadský	<i>Castor canadensis</i>	-	-						
křeček polní	škřeček pol'ný	<i>Cricetus cricetus</i>	+	+			O	SO		
normík rudý	hrdziak lesný	<i>Myodes glareolus</i>	+	+			-	-		
hryzec vodní	hryzec vodný	<i>Arvicola terrestris</i>	+	+			-	-		
ondatra pižmová	ondatra pižmová	<i>Ondatra zibethicus</i>	+	+			-	-		
hraboš polní	hraboš pol'ný	<i>Microtus arvalis</i>	+	+			-	-		
hraboš mokřadní	hraboš močiarny	<i>Microtus agrestis</i>	+	+			-	-		
hraboš hospodárny	hraboš severský	<i>Microtus oeconomus</i>	-	+						
hrabošík podzemní	hraboš podzemný	<i>Microtus subterraneus</i>	+	+			-	-		
hrabošík tatranský	hraboš tatranský	<i>Microtus tatricus</i>	-	+						
hraboš sněžný	hraboš snežný	<i>Chionomys nivalis</i>	-	+						
myšice lesní	ryšavka lesná	<i>Apodemus flavicollis</i>	+	+			-	-		
myšice křovinná	ryšavka křovinná	<i>Apodemus sylvaticus</i>	+	+			-	-		
myšice temnopásá	ryšavka tmavopása	<i>Apodemus agrarius</i>	+	+			-	-		
myšice malooká	ryšavka myšovitá	<i>Apodemus uralensis (microps)</i>	+	+			-	-		
myška drobná	myš drobná	<i>Micromys minutus</i>	+	+			-	-		
myš domácí	myš domová	<i>Mus musculus</i>	+	+			-	-		
myš západoevropská	myš západoeurópska	<i>Mus domesticus</i>	+	-			-	-		
myš panonská	myš panónska	<i>Mus spicilegus</i>	-	+						
krysa obecná	potkan tmavý	<i>Rattus rattus</i>	+	?			-	-		
potkan	potkan hnedý	<i>Rattus norvegicus</i>	+	+			-	-		
myšivka horská	myšovka horská	<i>Sicista betulina</i>	+	+	VU	NT	SO	SO	-	Habitats
myšivka stepní	myšovka stepná	<i>Sicista subtilis</i>	-	+						
zajíc polní	zajac pol'ný	<i>Lepus europaeus</i>	+	+	NT	-	-	-	Bern III	-
králík divoký	králík divý	<i>Oryctolagus cuniculus</i>	+	+			-	-		