

Crystal Defects

Perfect crystal - every atom of the same type in the correct equilibrium position
(does not exist at $T > 0$ K)

Real crystal - all crystals have some imperfections - **defects**
most atoms are in ideal locations, a small number are out of place

- **Intrinsic** defects – present for thermodynamic reasons
- **Extrinsic** defects – not required by thermodynamics, can be controlled by purification or synthetic conditions
- Chemical defects (foreign atom, mixed crystals, nonstoichiometry)
- Geometrical defects (vacancy, interstitials, dislocations, boundaries, surface)

Defects dominate the material properties:

Mechanical, Chemical, Electrical, Diffusion

Defects can be added intentionally

Crystal Defects

Perfect crystal

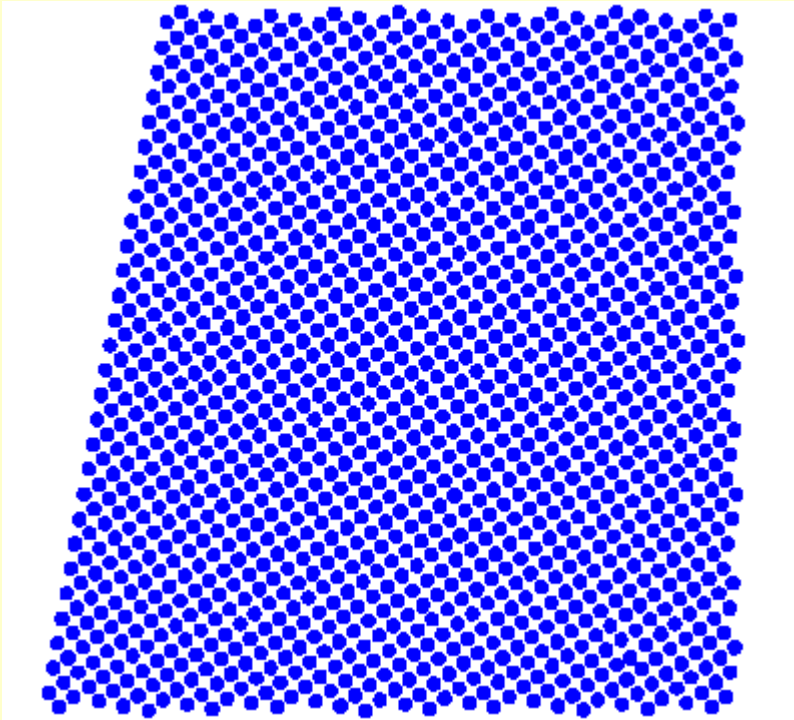

Real crystal

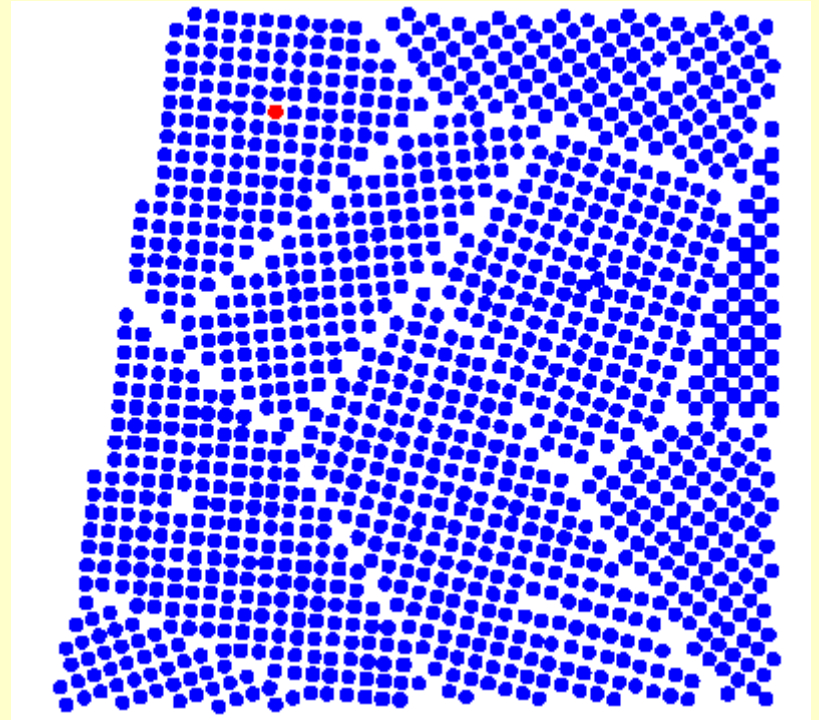

Classes of Crystal Defects

Point defects (0D) places where an atom is missing or irregularly placed in the lattice structure – lattice vacancies, self-interstitial atoms, substitution impurity atoms, interstitial impurity atoms

Linear defects (1D) groups of atoms in irregular positions – dislocations

Planar defects (2D) interfaces between homogeneous regions of the material - grain boundaries, stacking faults, external surfaces

Volume defects (3D) spaces of foreign matter – pores, inclusions

Classes of Crystal Defects

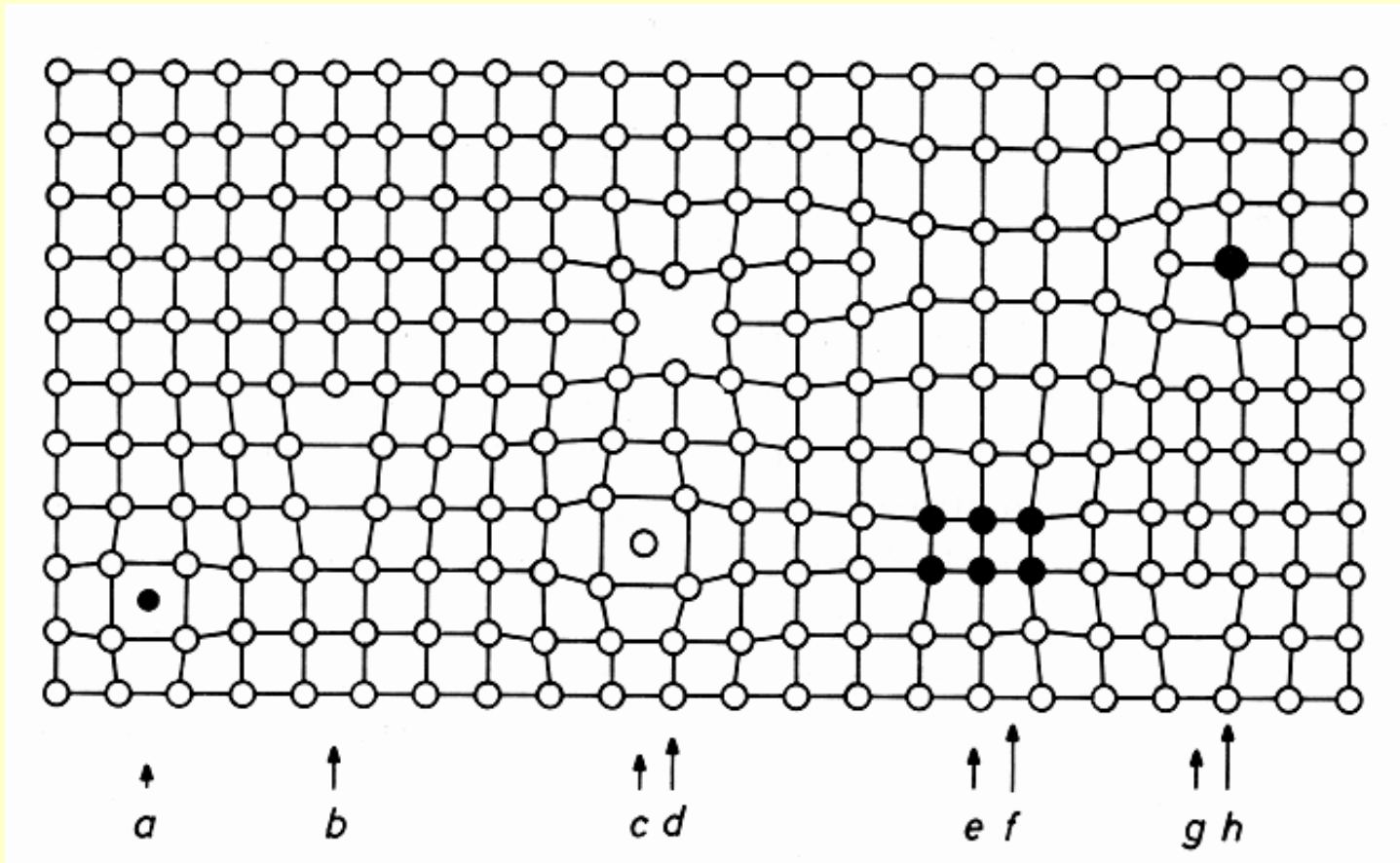

Point Defects

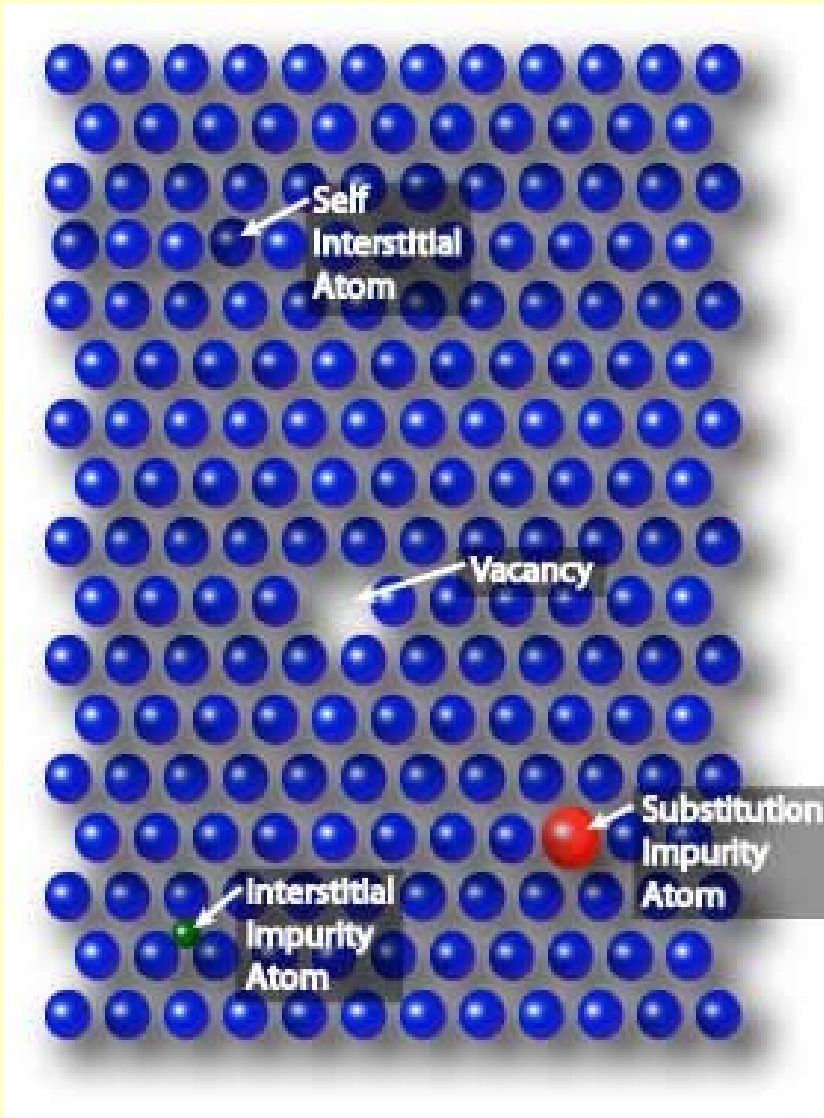

Point defects - an atom is missing or is in an irregular position in the lattice

- self interstitial atoms
- interstitial impurity atoms
- substitutional atoms
- vacancies

Point Defects

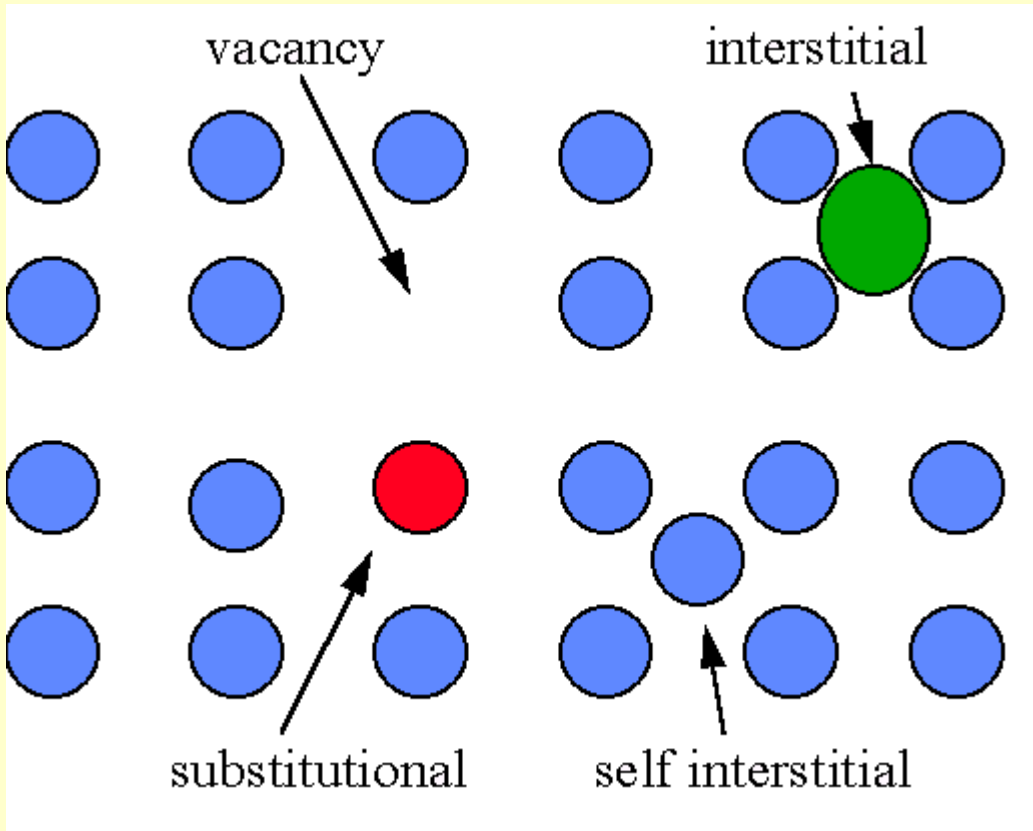

Point defects - an atom is missing or is in an irregular position in the lattice

- self interstitial atoms
- interstitial impurity atoms
- substitutional atoms
- vacancies

Point Defects – Ionic Compounds

perfect crystal lattice AB

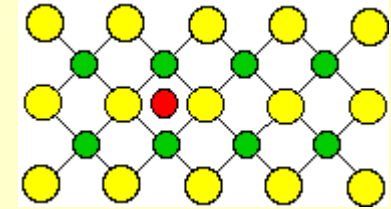
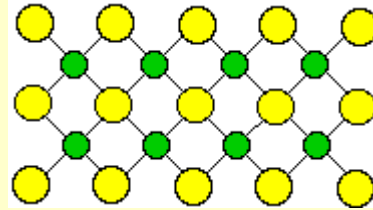

interstitial impurity

cation vacancy

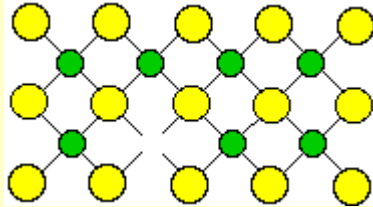

anion vacancy

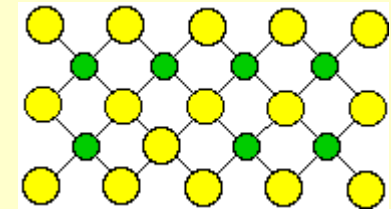
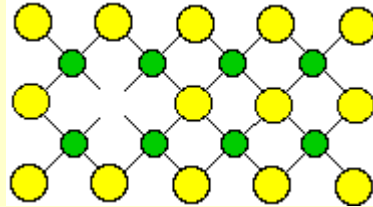

B_A antisite defect

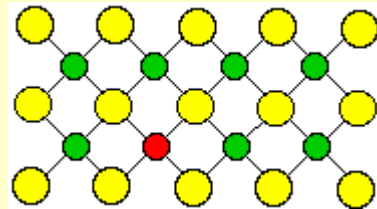

substitution of a cation

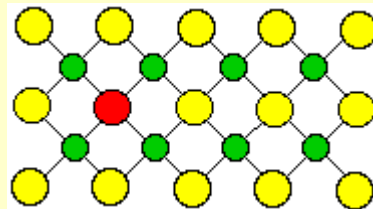

substitution of an anion

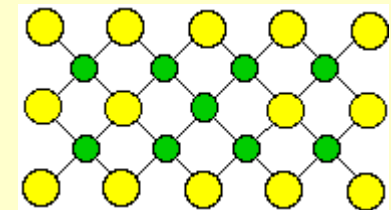

A_B antisite defect

Types of Point Defects in Ionic Compounds

- Vacancy
- Interstitial
- Substitutional
- Frenkel
- Schottky

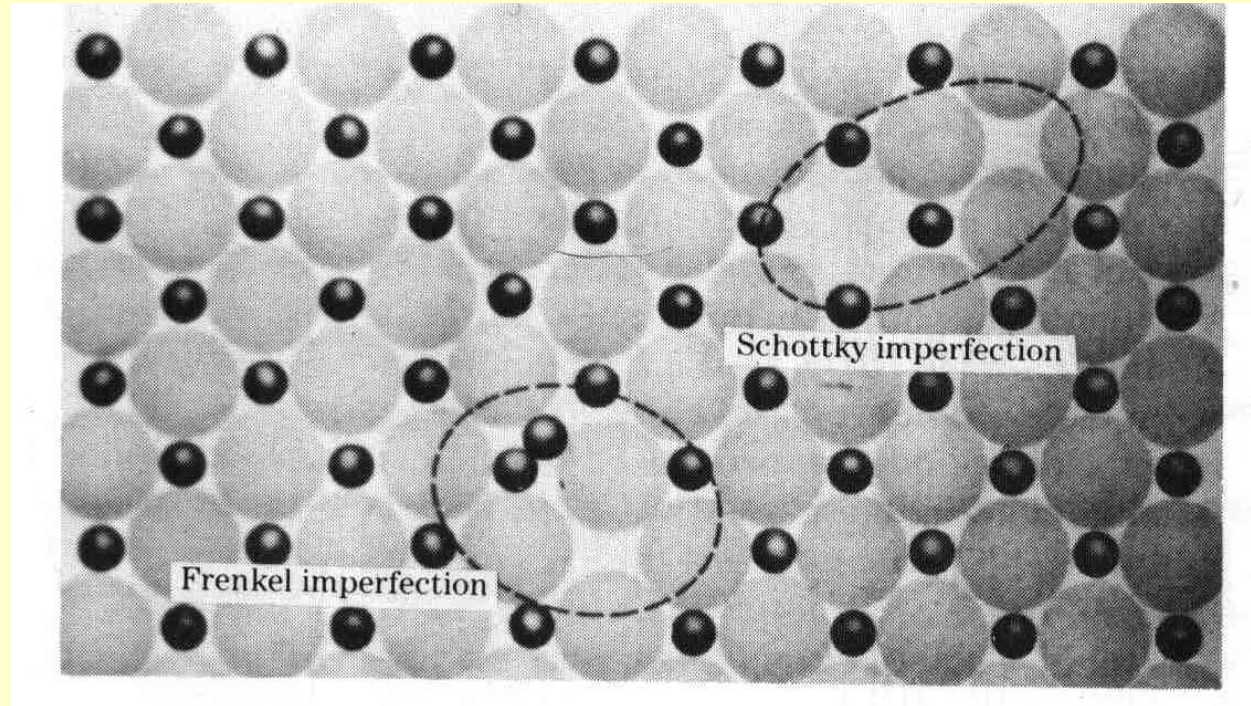

Schottky: a pair of vacancies, missing cation/anion moved to the surface

Frenkel: ions moved to interstitial positions, vacancies

Point Defects

Schottky - equal numbers of vacancies at both A and B sites preserving charge balance, found in compounds where metal ions are able to assume multiple oxidation states

Frenkel – found in open structures (wurtzite, sphalerite, etc) with low coordination numbers, open structure provides room for interstitial sites to be occupied

Schottky

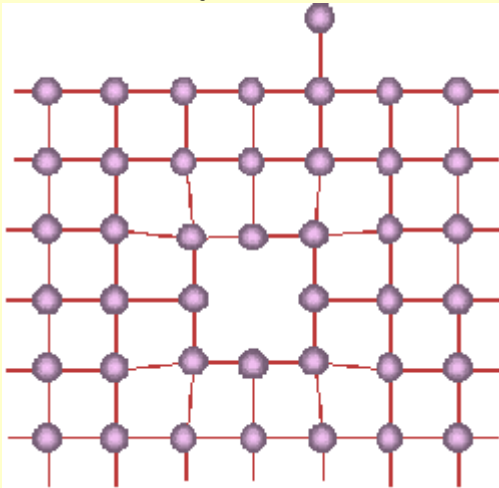

Frenkel

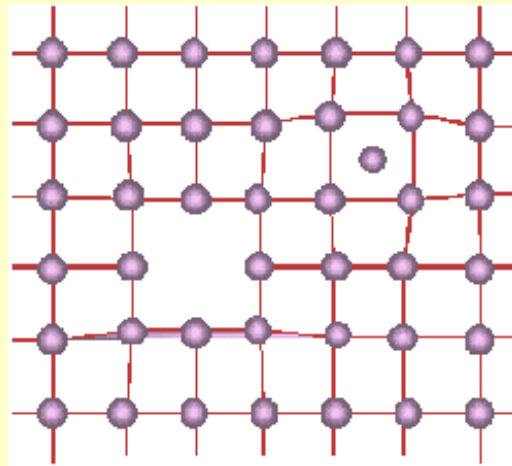

Vacancies

There are naturally occurring vacancies in all crystals

Equilibrium defects – thermal oscillations of atoms at $T > 0$ K

The number of vacancies increases as the temperature goes up

The number of vacancies:

$$N_V = N \exp\left(-\frac{\Delta H^a}{RT}\right)$$

- N = the total number of sites in a crystal
- N_V = the number of vacancies
- ΔH^a = the activation energy for the formation of a vacancy
- R = the gas constant

N_V goes up exponentially with temperature T

Crystal Energies

$$\Delta G = \Delta H - T\Delta S$$

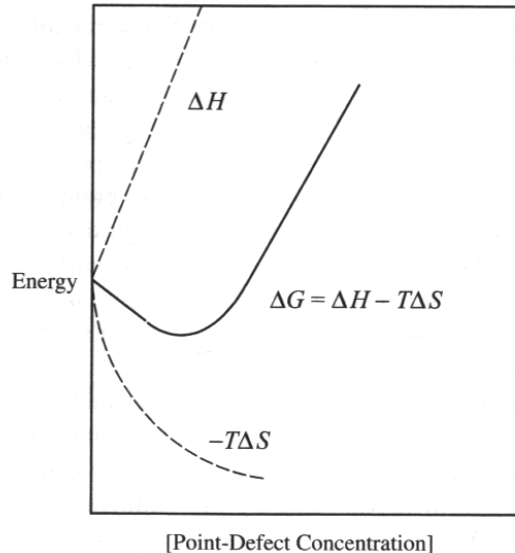

(a)

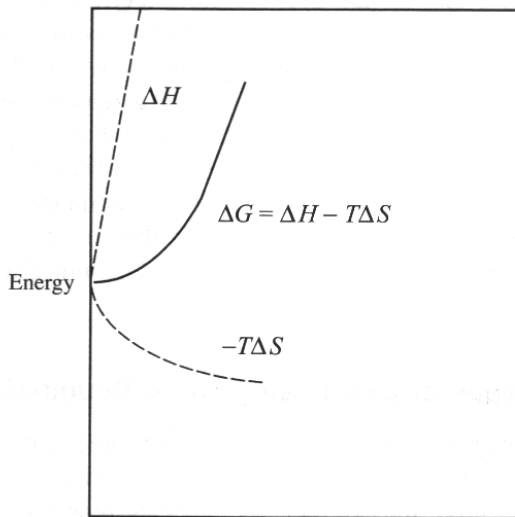

[Extended Defect Concentration]

(b)

Point defects = equilibrium concentration,
Enthalpy is positive, configurational entropy positive
Minimum on free energy

Extended defects = no equilibrium concentration,
Enthalpy is HIGHLY positive, configurational
entropy cannot outweigh
No minimum on free energy

Metastable – dislocations, grain boundaries, surface

Heating - minimize free energy:
polycrystalline → single crystal grain growth
Grains with high dislocation density consumed
Atoms move across grain boundary

Typical point defects in crystals

Alkali halides	Schottky (cations and anions)
Alkaline earth oxides	Schottky (cations and anions)
Silver halides	Frenkel (cations)
Alkaline earth fluorides	Frenkel (anions)

Typical activation energies for ion diffusion

Na⁺ in NaCl	~ 0,7 eV
Cl⁻ in NaCl	~ 1 eV
Schottky pair	~ 2,3 eV

(1 eV/molecule = 96.49 kJ/mol)

Extrinsic Defects

The addition of the **dopant** (an impurity) into a perfect crystal = point defects in the crystal

NaCl heated in Na vapors

Na is taken into the crystal and changes the composition

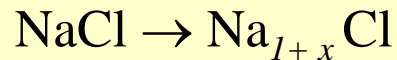

Na atoms occupy cation sites

an equivalent number of unoccupied anion sites

Na atoms ionize, Na^+ ions occupy the cation sites,

the electrons occupy the anion vacancies – **F centers** – color

This solid is now a **non-stoichiometric** compound as the ratio of atoms is no longer the simple integer

Non-stoichiometric Compounds

Non-stoichiometry can be caused by

- introducing an impurity (doping)
- the ability of an element to show multi-valent character.

Vanadium oxide

varies from $\text{VO}_{0.79}$ to $\text{VO}_{1.29}$

other examples: TiO_x , Ni_xO , UO_x and Li_xWO_3

Covalent compounds - held to together by very strong covalent bonds which are difficult to break, do not show a wide range of composition

Ionic compounds - do not show a wide range because a large amount of energy is required to remove / add ions

Non-stoichiometric Compounds

Non-stoichiometric ionic crystals

a multi-valent element - changes in the number of ions can be compensated for by changes in the charge on the ions, therefore maintaining charge balance but changing the stoichiometry

non-stoichiometric compounds have formulae with non-integer ratios and can exhibit a range of compositions.

The electronic, optical, magnetic and mechanical properties of non-stoichiometric compounds can be controlled by varying their composition.

Non-stoichiometric Compounds

Non-stoichiometric superconductor YBCO

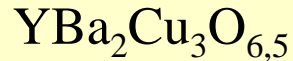

a multi-valent element = Cu

$\text{YBa}_2\text{Cu}_3\text{O}_{6,8-7,0}$ 90 K superconductor

$\text{YBa}_2\text{Cu}_3\text{O}_{6,45-6,7}$ 60 K superconductor

$\text{YBa}_2\text{Cu}_3\text{O}_{6,0-6,45}$ antiferromagnetic semiconductor

T_{critical}

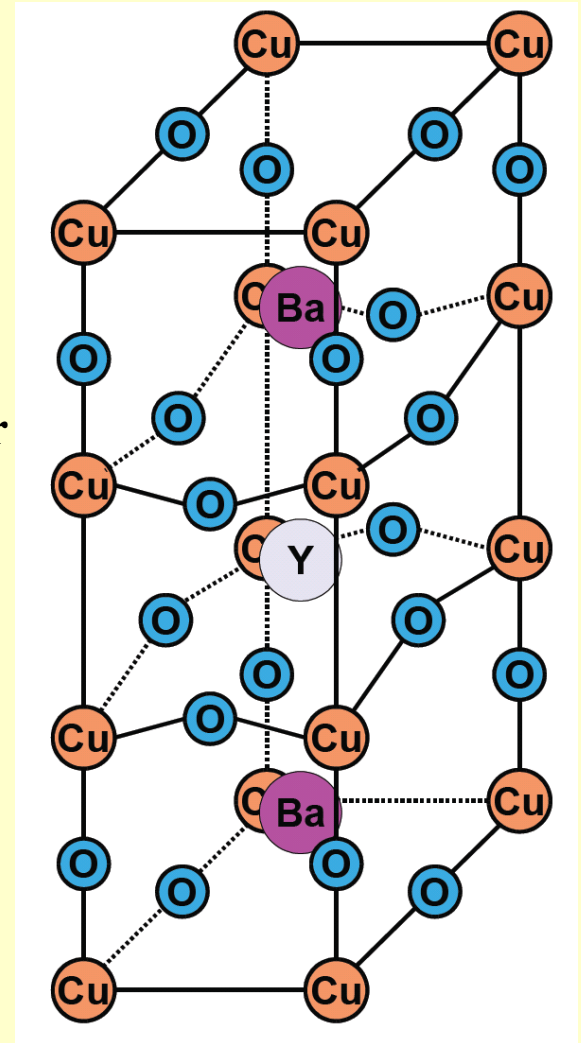
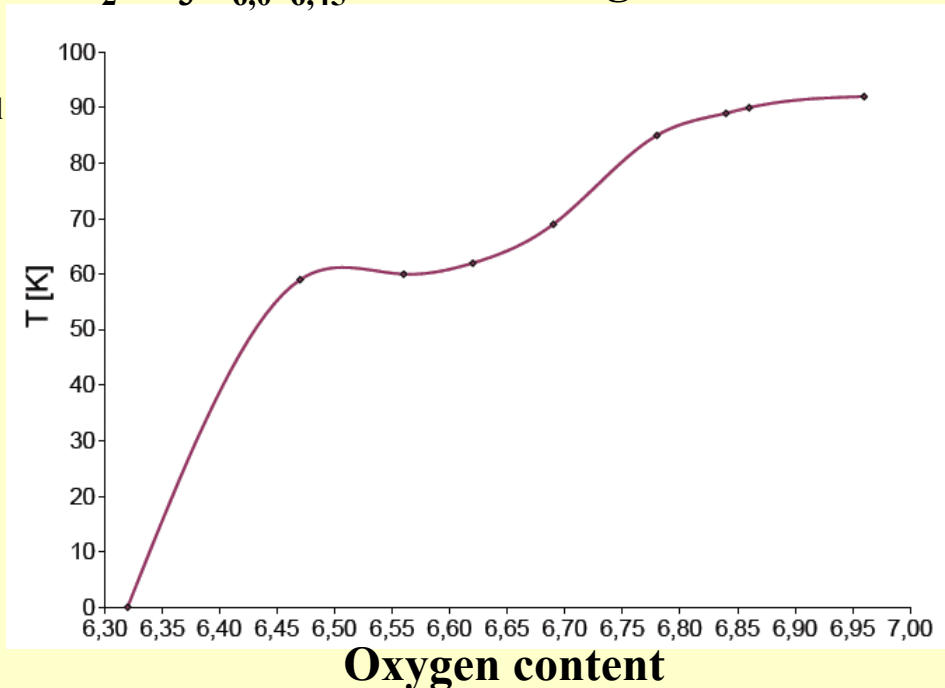

Dislocations

Line imperfections in a 3D lattice

- Edge
- Screw
- Mixed

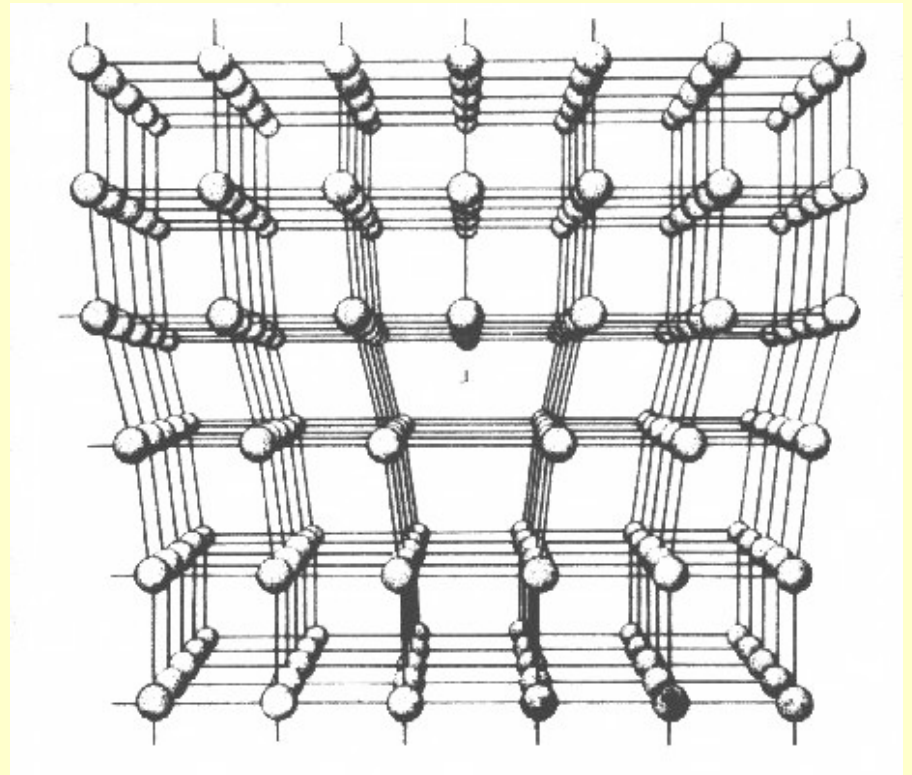
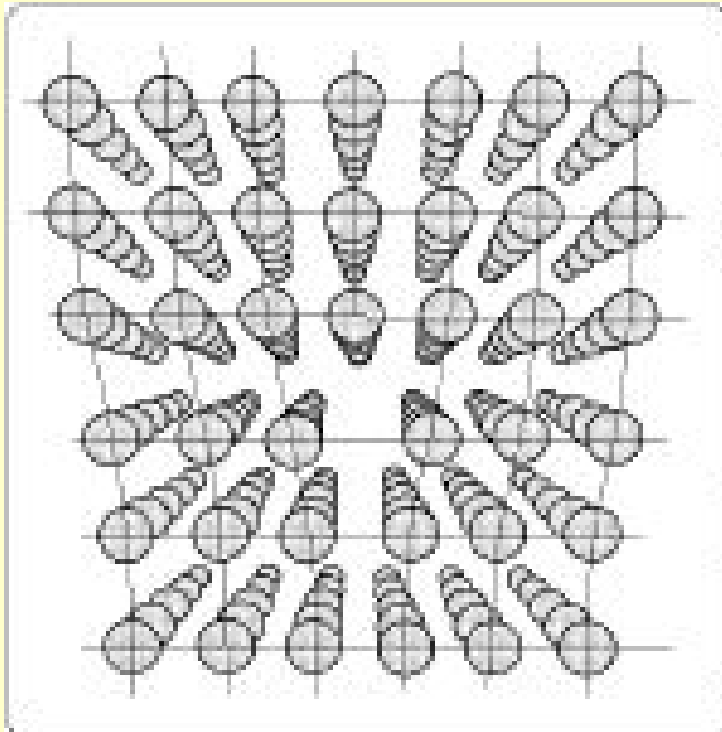

Edge Dislocation

- Extra plane of atoms
- Burgers vector
 - Deformation direction
 - For edge dislocations it is perpendicular to the dislocation line

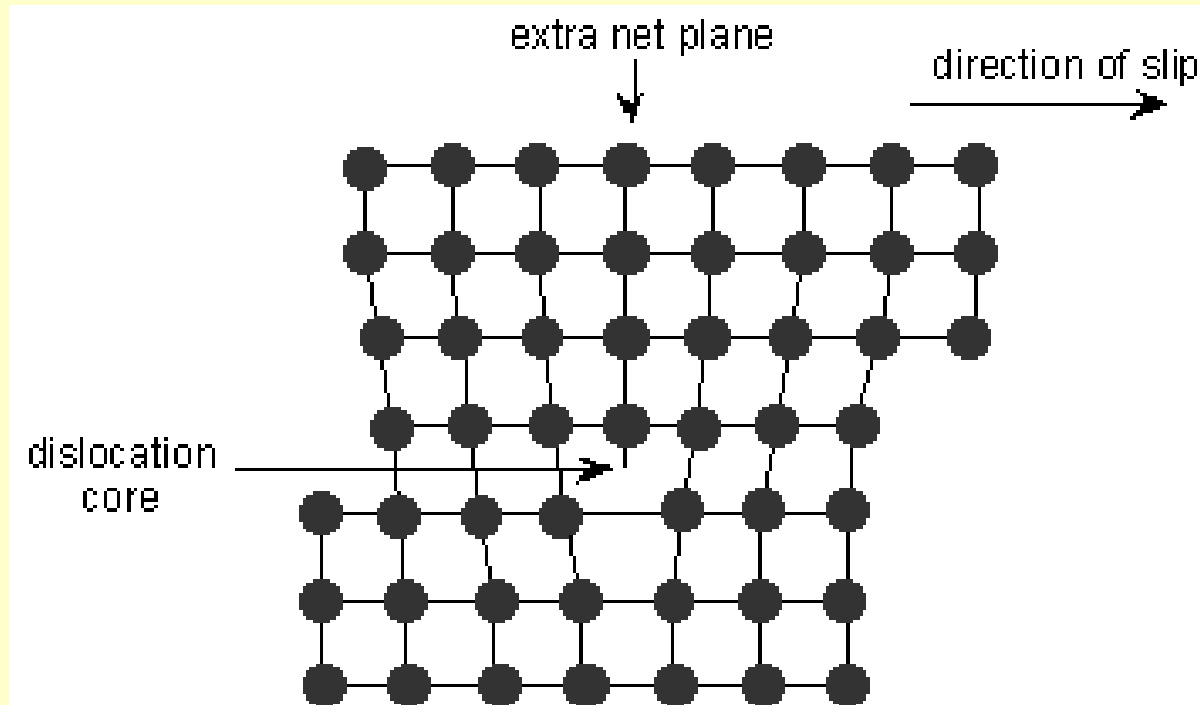

Edge Dislocation

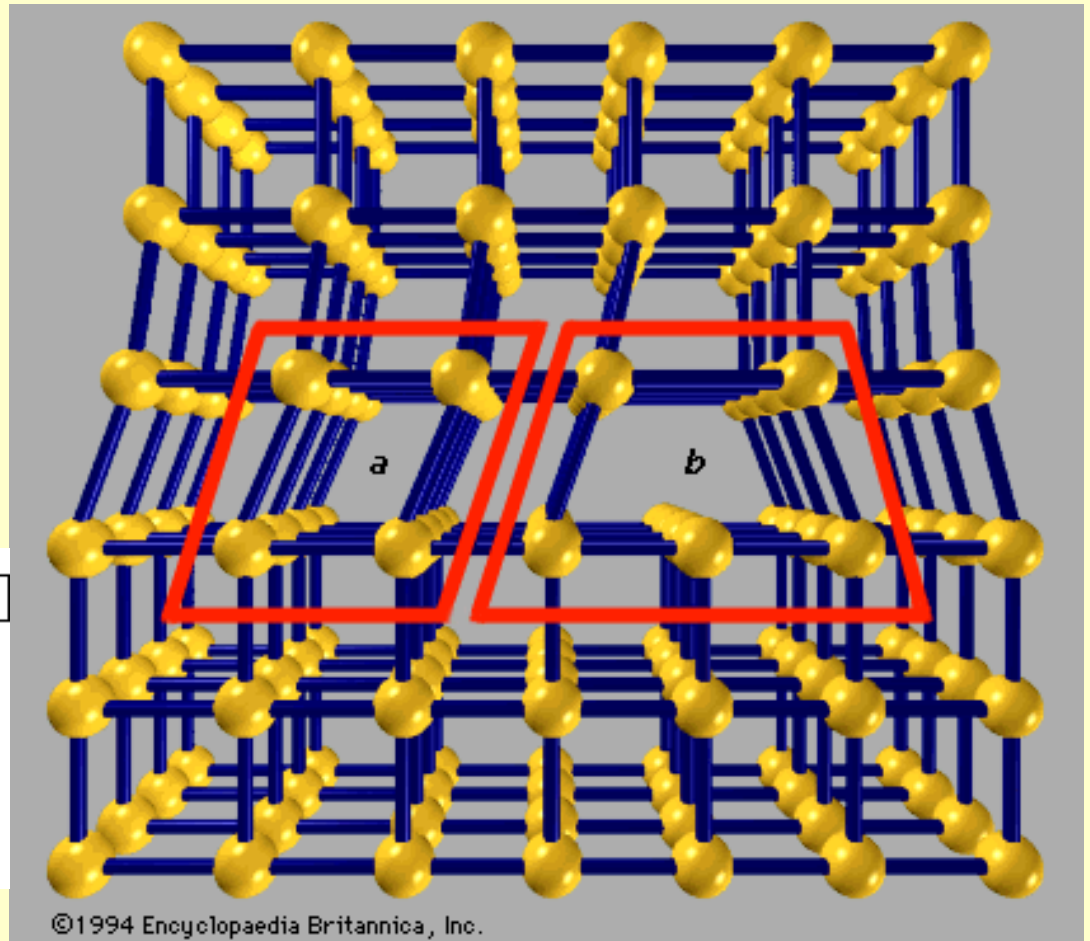
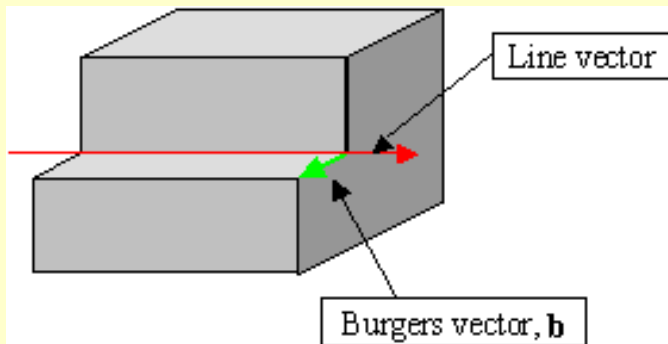
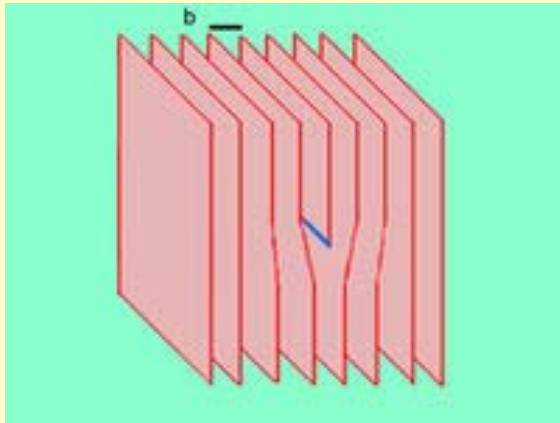

Screw Dislocation

- A ramped step
- Burgers vector
 - Direction of the displacement of the atoms
 - For a screw dislocation it is parallel to the line of the dislocation

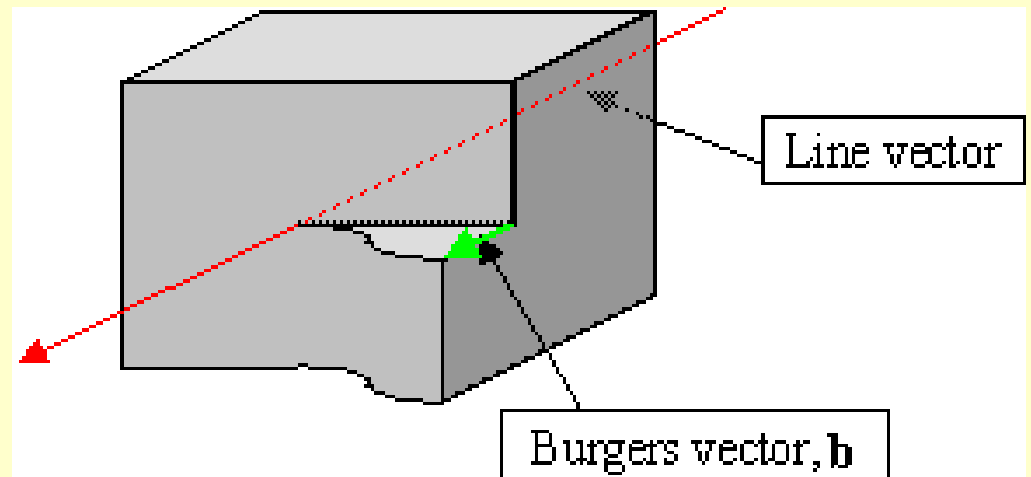
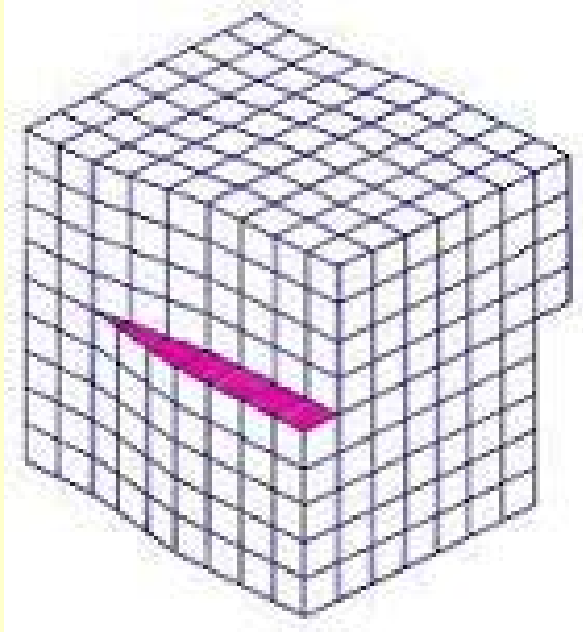

Screw Dislocation

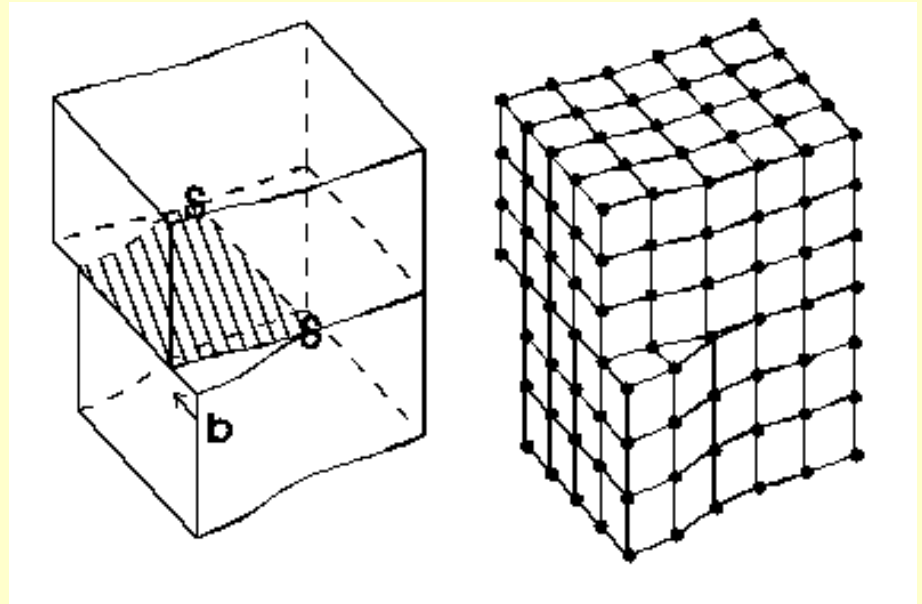
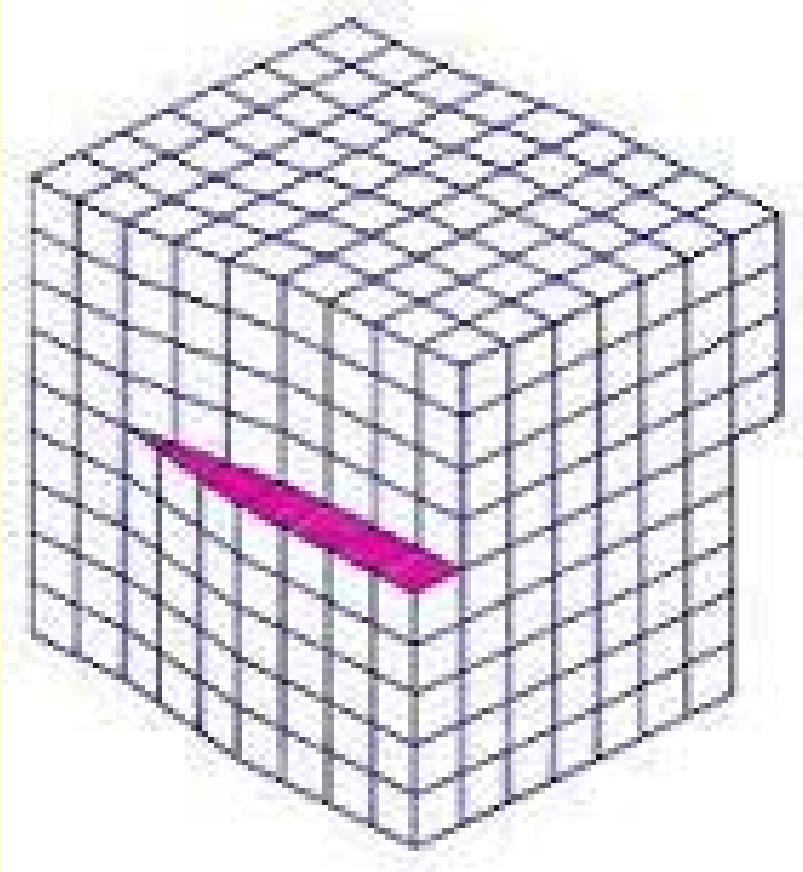

Deformation

When a shear force is applied to a material, the dislocations move

Plastic deformation = the movement of dislocations (linear defects)

The strength of the material depends on the force required to make the dislocation move, not the bonding energy

Millions of dislocations in a material - result of plastic forming operations (rolling, extruding,...)

Any defect in the regular lattice structure (point, planar defects, other dislocations) disrupts the motion of dislocation - makes slip or plastic deformation more difficult

Deformation

Dislocation movement produces additional dislocations

Dislocations collide – entangle – impede movement of other dislocations - the force needed to move the dislocation increases - the material is strengthened

Applying a force to the material increases the number of dislocations

Called “strain hardening” or “cold work”

Slip

- When dislocations move slip occurs
 - Direction of movement – same as the Burgers vector
- Slip is easiest on close packed **planes**
- Slip is easiest in the close packed **direction**

- Affects
 - Ductility
 - Material Strength

Schmidt's Law

- In order for a dislocation to move in its slip system, a shear force acting in the slip direction must be produced by the applied force.

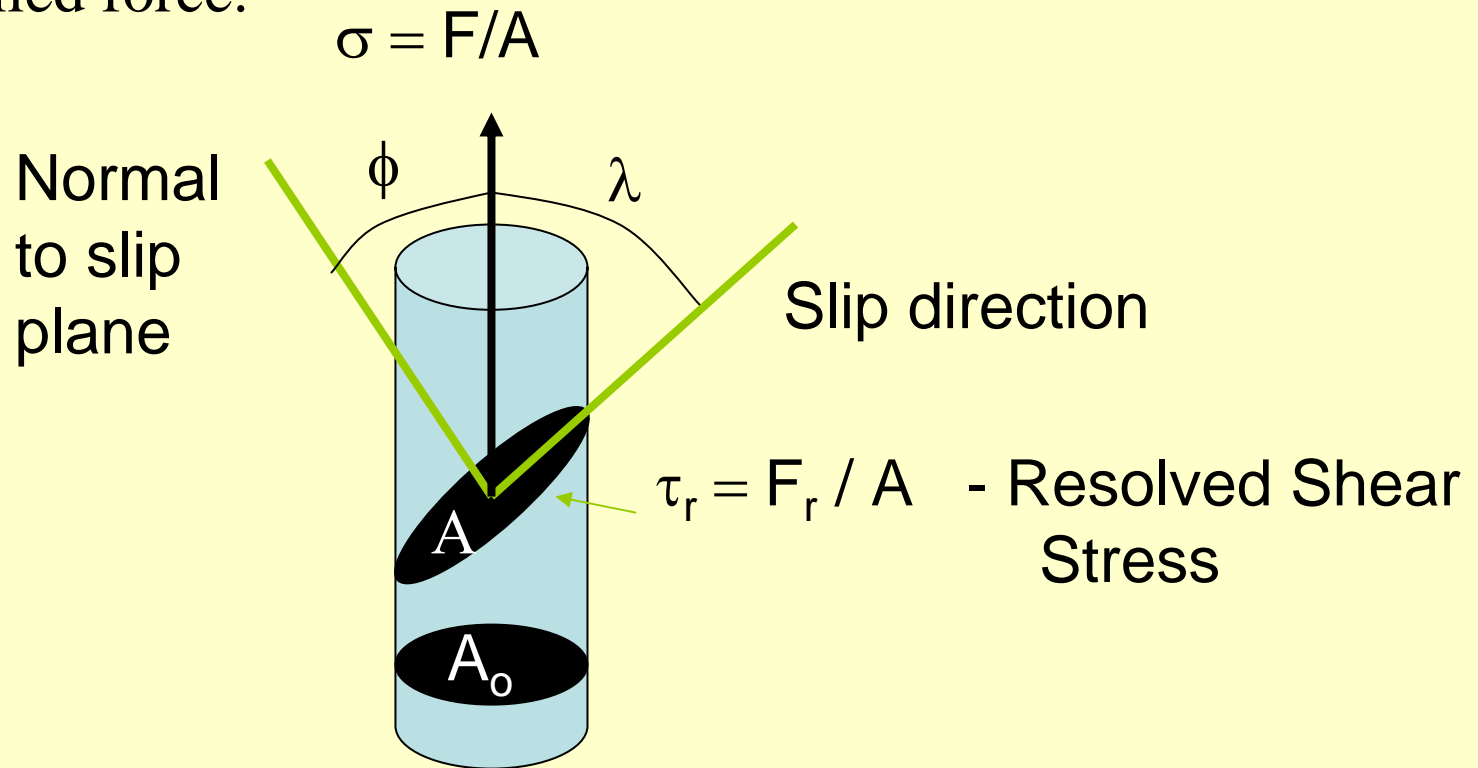

Schmidt's Law

$$F_r = F \cos(\lambda)$$

$$A = A_0 / \cos(\phi)$$

$$\tau = \sigma \cos(\phi) \cos(\lambda)$$

Where:

$\tau = F_r / A =$ resolved shear stress in the slip direction

$\sigma = F/A_0 =$ unidirectional stress applied to the cylinder

Surface and Grain Boundaries

- The atoms at the boundary of a grain or on the surface are not surrounded by other atoms – lower CN, weaker bonding
- Grains line up imperfectly where the grain boundaries meet
- Dislocations can not cross grain boundaries
- Tilt and Twist boundaries
- Low and High angle boundaries

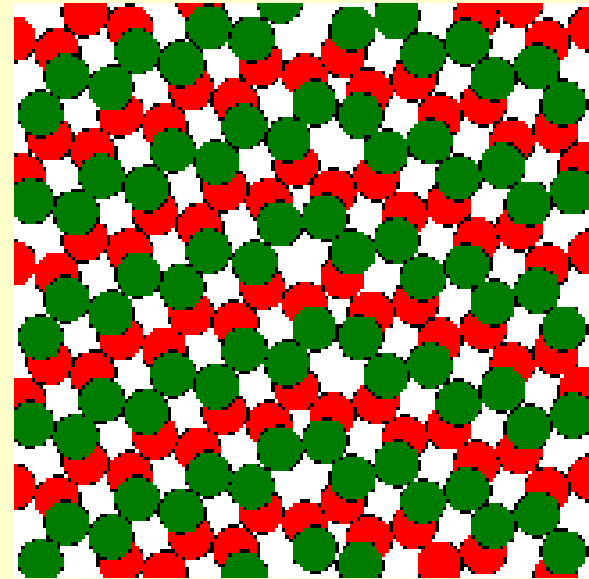

Low Angle Tilt Boundary

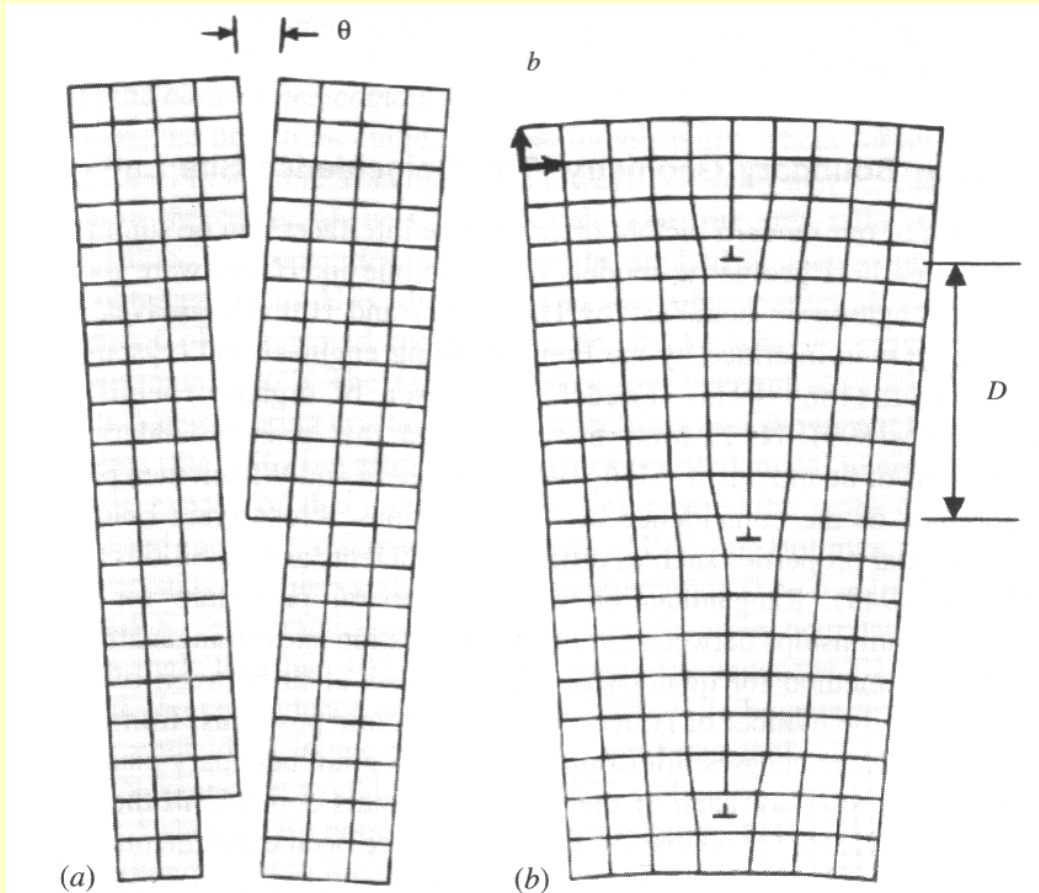

**Low Angle Tilt Boundary =
Array of Edge dislocations**

$$D = \frac{b}{\sin \theta}$$

**D = dislocation spacing
b = Burgers vector
 θ = misorientation angle**

Low Angle Twist Boundary

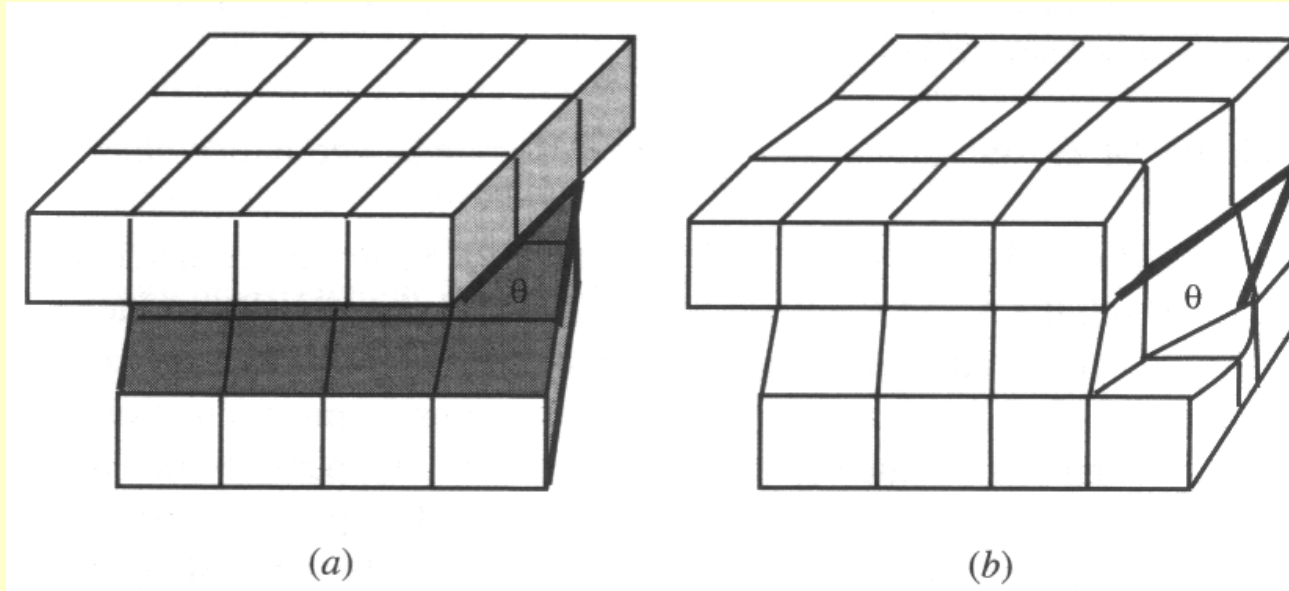

**Low Angle Twist Boundary = a
Screw dislocation**

Crystal Energies

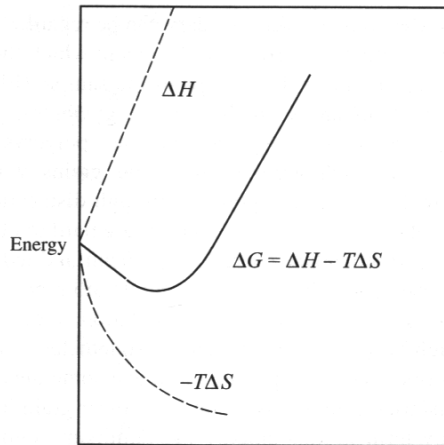

[Point-Defect Concentration]
(a)

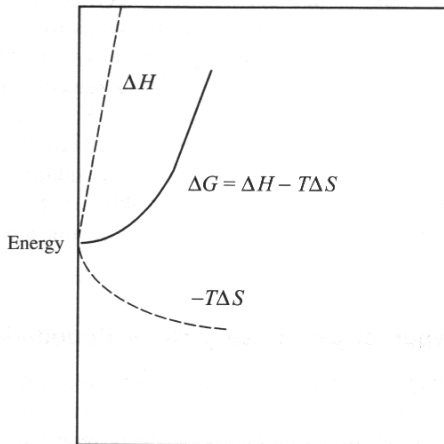

[Extended Defect Concentration]
(b)

**Point defects = equilibrium concentration,
Enthalpy is positive, configurational entropy positive
Minimum on free energy**

**Extended defects = no equilibrium concentration,
Enthalpy is HIGHLY positive, configurational
entropy cannot outweigh, no minimum on free
energy**

Metastable – dislocations, grain boundaries, surface

Heating - minimize free energy:

polycrystalline → single crystal grain growth

Grains with high dislocation density consumed

Atoms move across grain boundary

Effect of Grain Size on Strength

- Material with a small grain = a dislocation moves to the boundary and stops – slip stops
- Material with a large grain = the dislocation can travel farther
- Small grain size = more strength

Hall-Petch Equation

$$\sigma_y = \sigma_0 + K d^{-1/2}$$

σ_y = yield strength

(stress at which the material permanently deforms)

d = average grain diameter

σ_0 , K = constants

Control of the Slip Process

- Strain hardening
- Solid Solution strengthening
- Grain Size strengthening

Amorphous Structures

- Cooling a material off too fast - it does not have a chance to crystallize
- Forms a glass
- Easy to make a ceramic glass
- Hard to make a metallic glass
- There are no slip planes, grain boundaries in a glass

Amorphous Structures

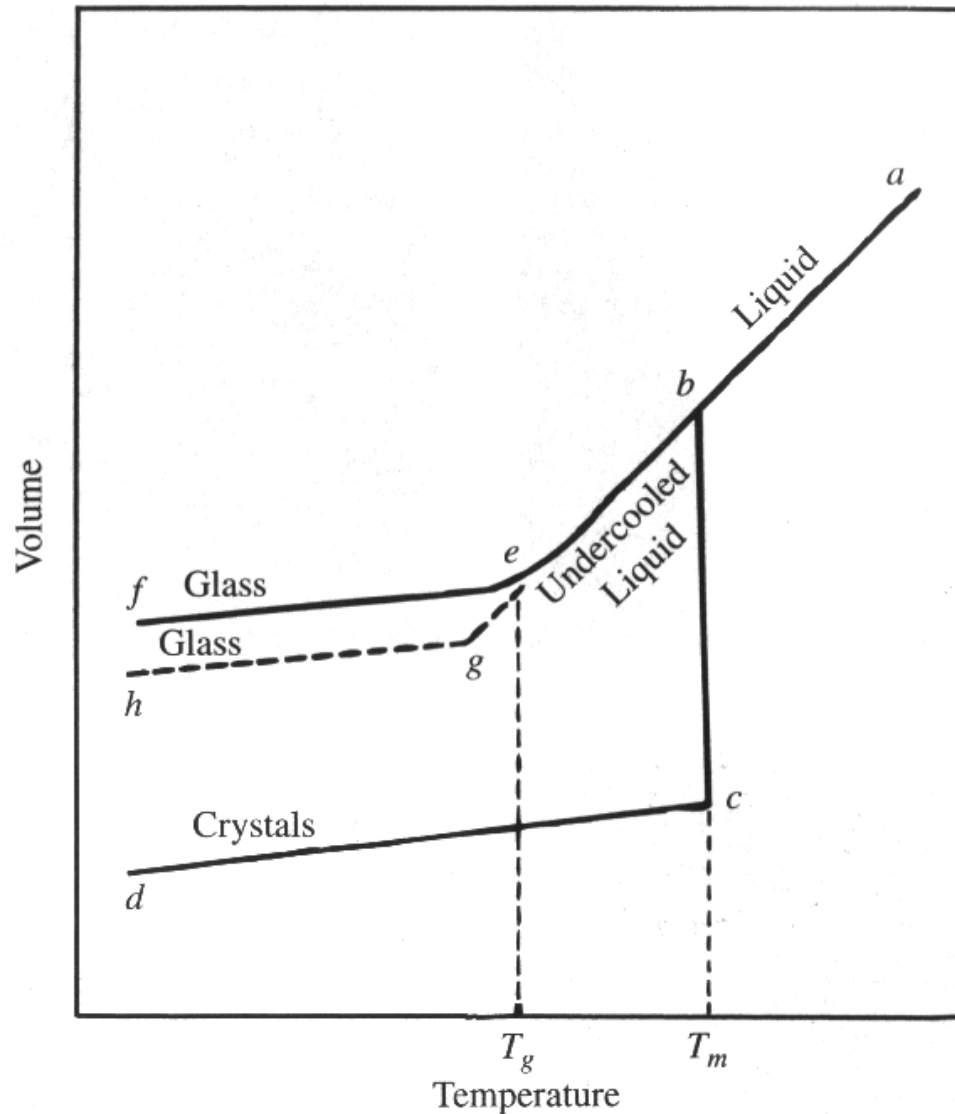

Diffusion

Interdiffusion: atoms migrate from regions of large to lower concentration

Initial state (diffusion couple)

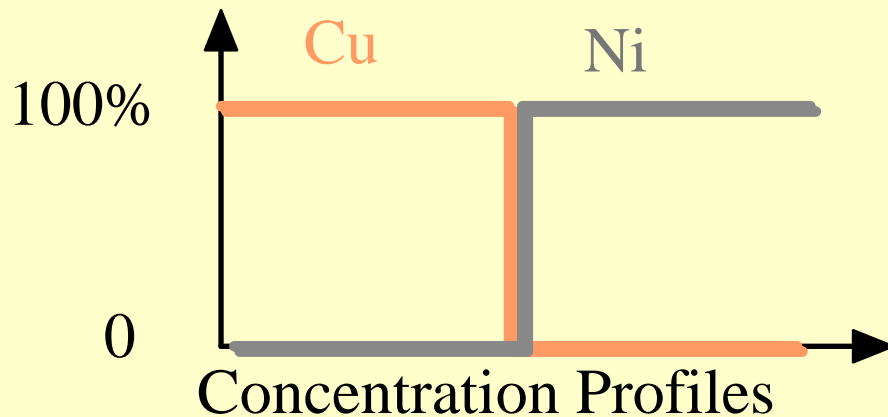
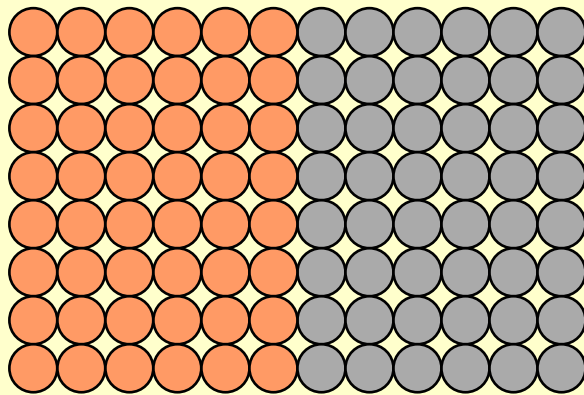

After elapsed time

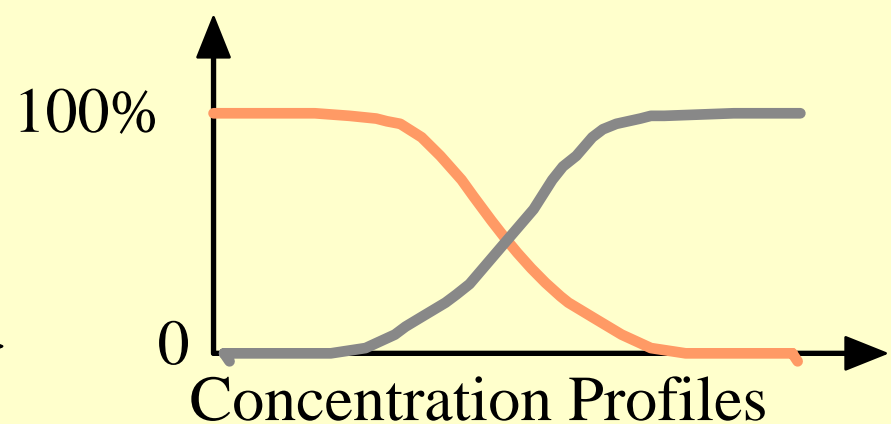
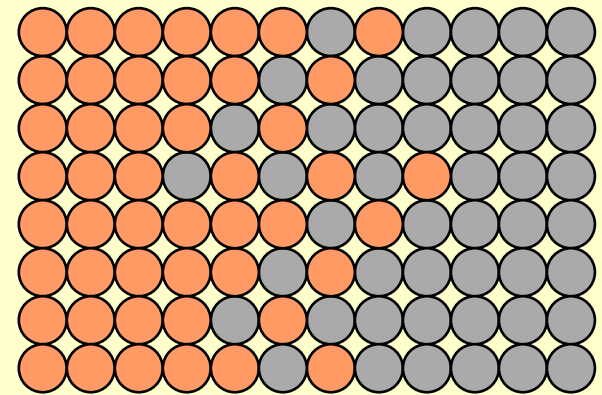

Diffusion

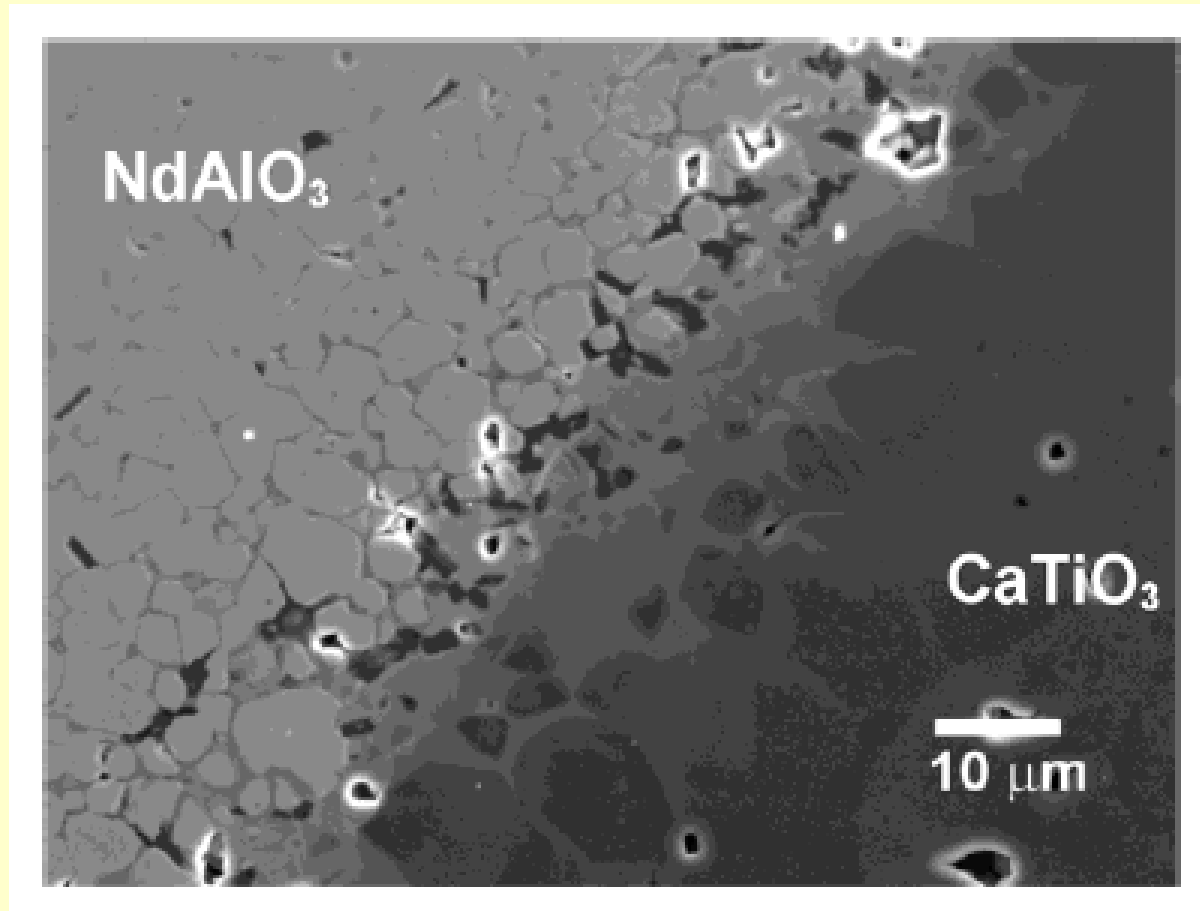

CaTiO_3 - NdAlO_3 diffusion couple fired at $1350\ \text{°C}/6\ \text{h}$

Diffusion - Fick's First Law

Fick's first law describes **steady-state diffusion**

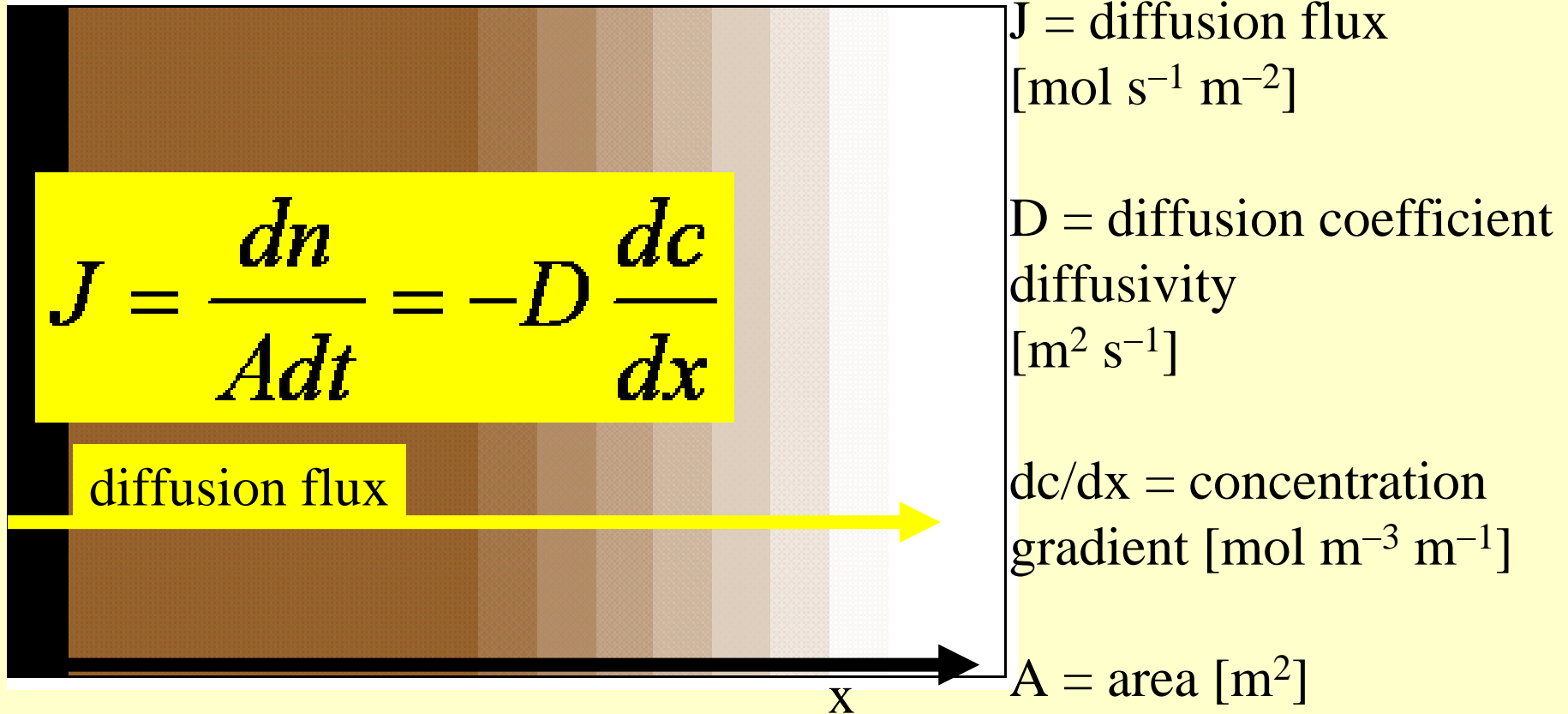

Velocity of diffusion of particles (ions, atoms ...) in a solid
mass transport and concentration gradient for a given point in a solid

Diffusion - Fick's First Law

Typical diffusion coefficients for ions (atoms) in a solid at room temperature

$$10^{-13} \text{ cm}^2 \text{ s}^{-1}$$

In solid state ionic conductors (e.g. Ag-ions in α -AgI) the values are greater by orders of magnitude ($\approx 10^{-6} \text{ cm}^2 \text{ s}^{-1}$)

Mechanisms of Diffusion

Diffusion = the mechanism by which matter is transported into or through matter

Diffusion at the atomic level is a step-wise migration of atoms from lattice site to lattice site

Conditions for diffusion:

- an adjacent **empty site**
- atom possesses sufficient **energy** to break bonds with its neighbors and migrate to adjacent site (activation energy)

The higher the **temperature**, the higher is the probability that an atom will have sufficient energy

Diffusion rates increase with temperature

Mechanisms of Diffusion

- **Along Defects = Vacancy (or Substitutional) mechanism**
 - **Point Defects**
 - **Line Defects**
- **Through Interstitial Spaces = Interstitial mechanism**
- **Along Grain Boundaries**
- **On the Surface**

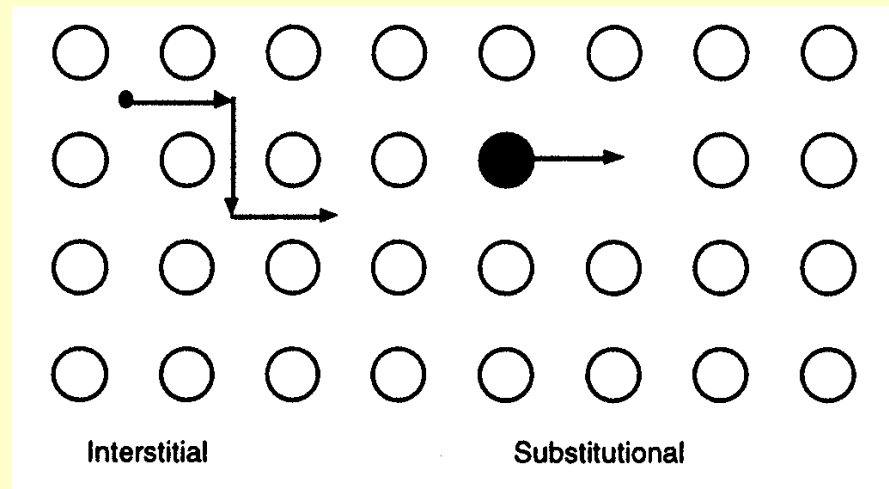

Vacancy Mechanisms of Diffusion

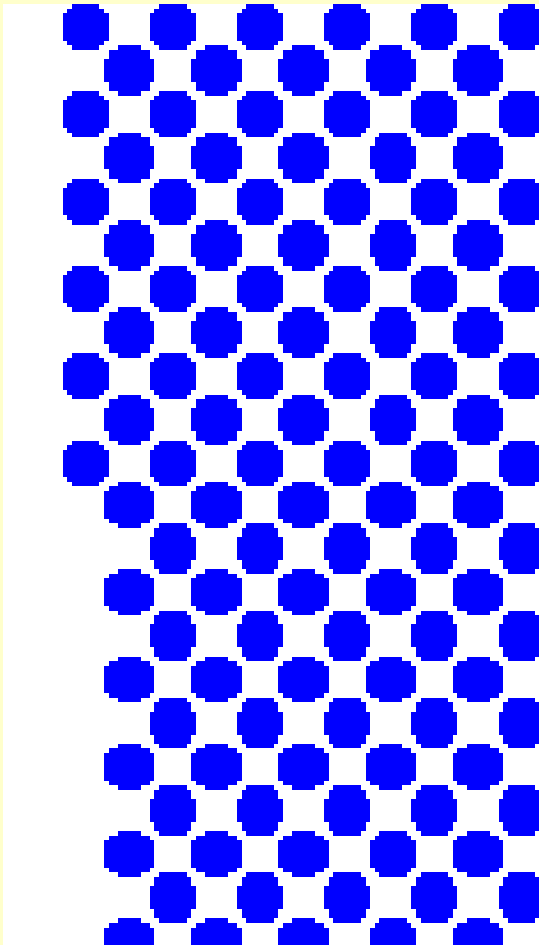

- Vacancies are holes in the matrix
- Vacancies are always moving
- An impurity can move into the vacancy
- Diffuse through the material

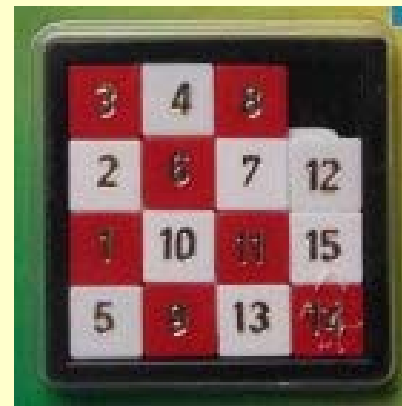

Vacancy Mechanisms of Diffusion

Atoms can move from one site to another if there is sufficient energy present for the atoms to overcome a local activation energy barrier and if there are vacancies present for the atoms to move into.

The activation energy for diffusion is the sum of the energy required to form a vacancy and the energy to move the vacancy.

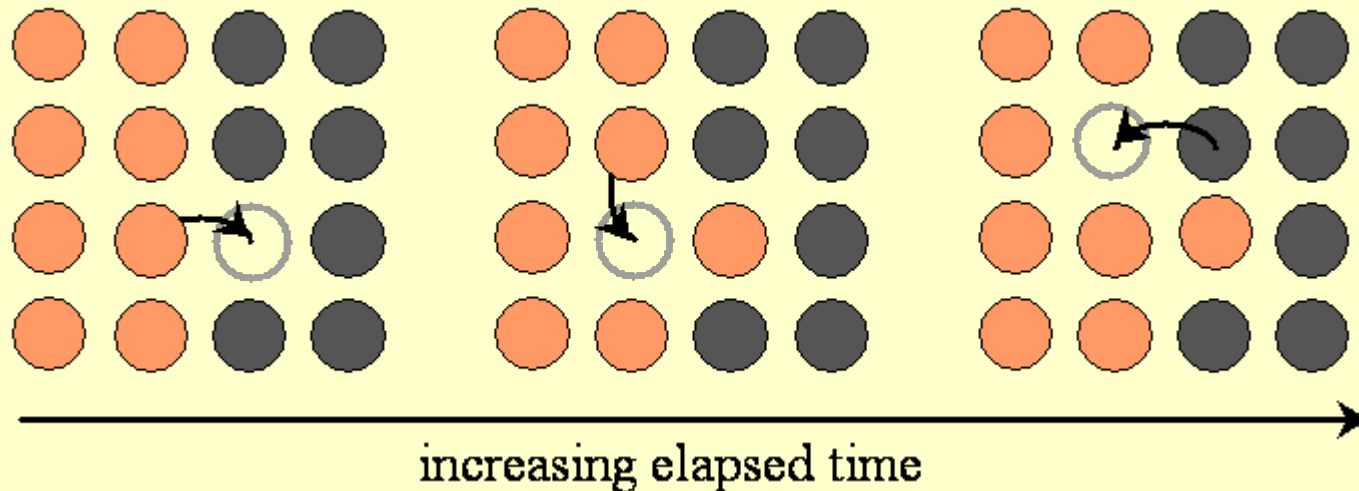

Interstitial Mechanisms of Diffusion

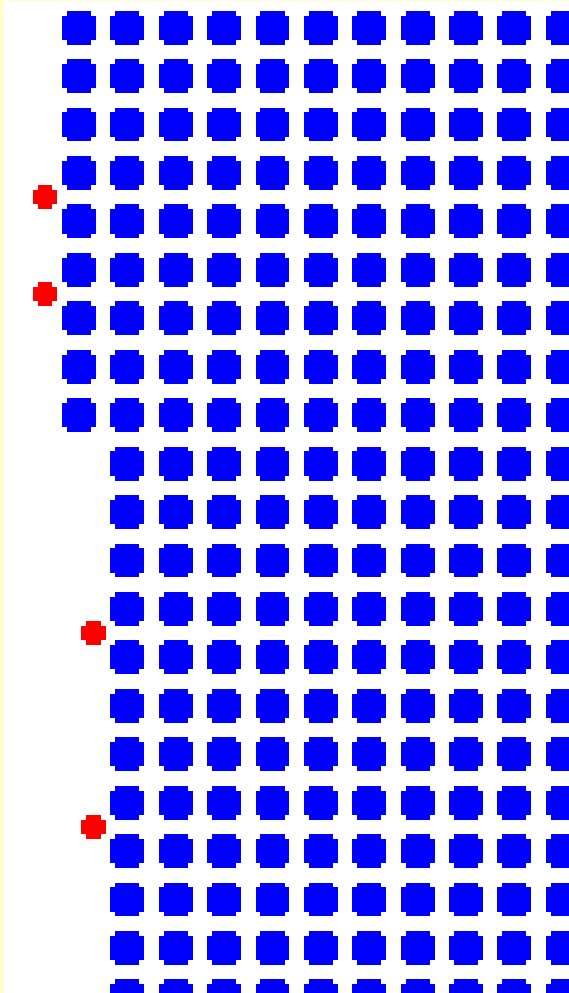

- There are holes between the atoms in the matrix
- If the atoms are small enough, they can diffuse through the interstitial holes
- Fast diffusion

Interstitial Atoms

- **An atom must be small to fit into the interstitial voids**
 - **H and He can diffuse rapidly through metals by moving through the interstitial voids**
 - **Interstitial atoms like hydrogen, helium, carbon, nitrogen, etc. must squeeze through openings between interstitial sites to diffuse around in a crystal**
 - **The activation energy for diffusion is the energy required for these atoms to squeeze through the small openings between the host lattice atoms.**
-
- **Interstitial C is used to strengthen Fe = steel, it distorts the matrix**
 - **The ratio of r/R is 0.57 – needs an octahedral hole**
 - **Octahedral and tetrahedral holes in both FCC and BCC – however the holes in BCC are not regular polyhedra**
 - **The solubility of C in FCC-Fe is much higher than in BCC-Fe**

Interstitial Atoms

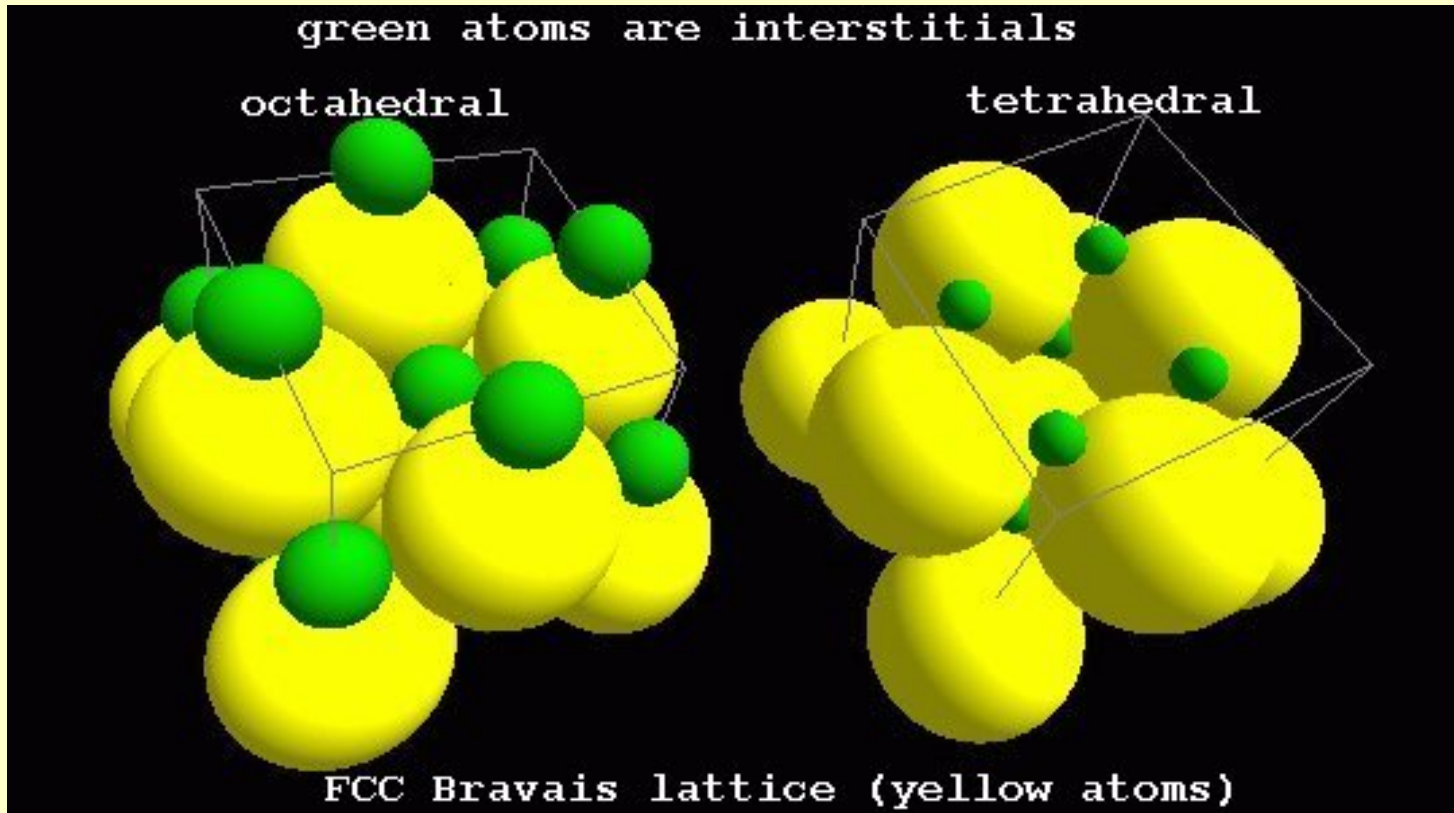

Interstitial Atoms

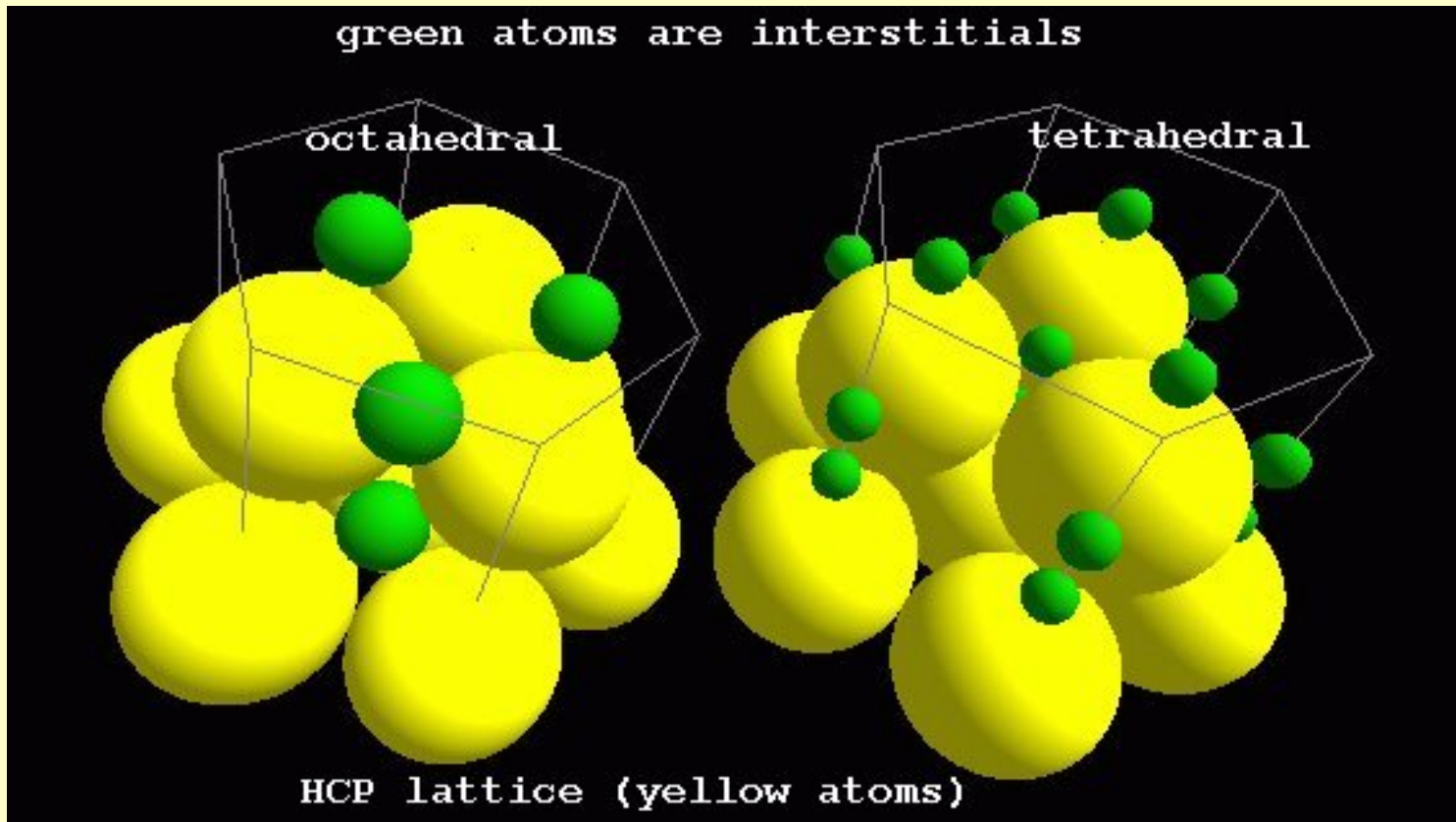

Interstitial Atoms

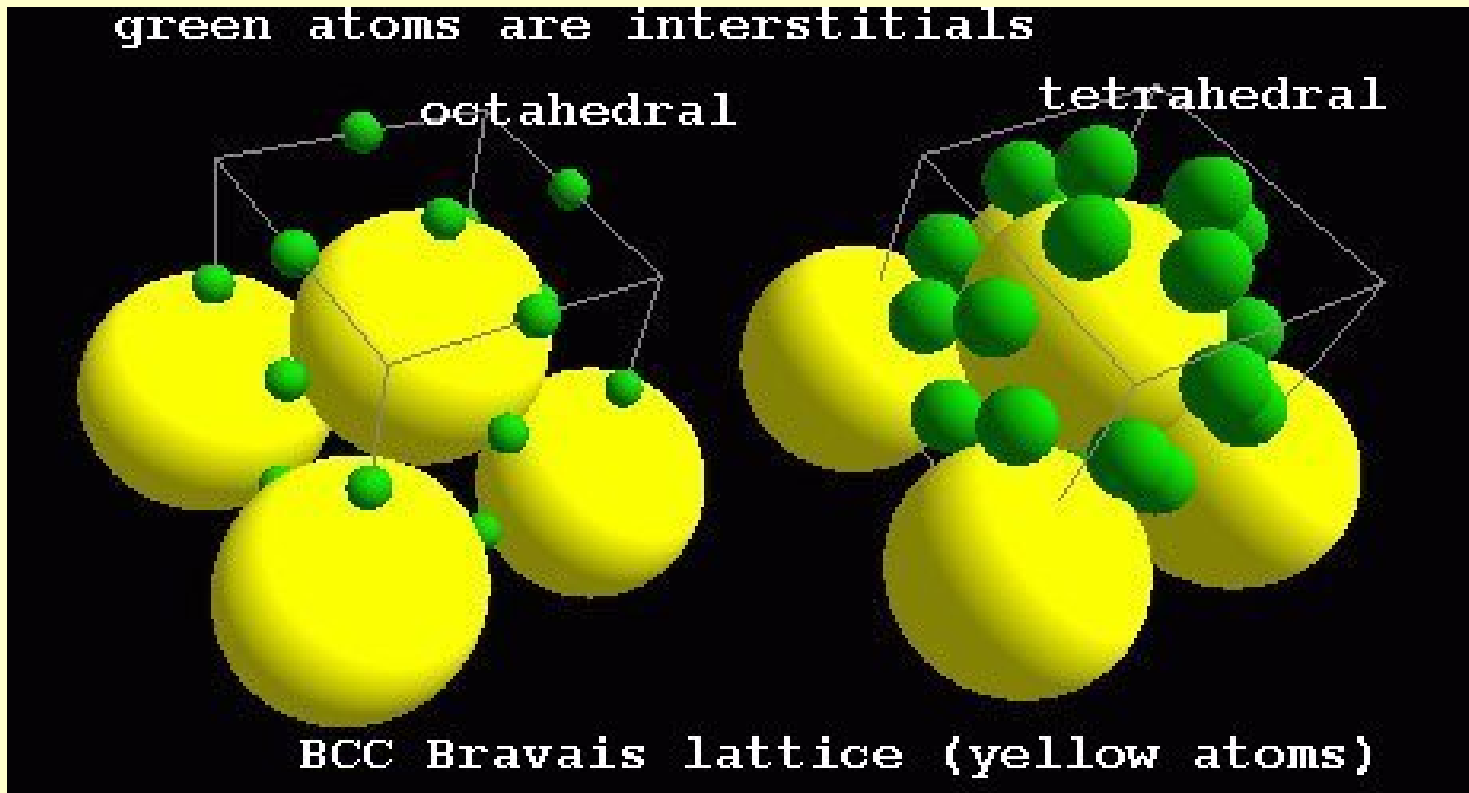

Activation Energy

- **All the diffusion mechanisms require a certain minimum energy to occur**
- **The activation energy**
- **The higher the activation energy, the harder it is for diffusion to occur**
- **The highest energy is for volume diffusion**
 - **Vacancy**
 - **Interstitial**
- **Grain Boundary diffusion requires less energy**
- **Surface Diffusion requires the least**

Activation Energy

Initial state

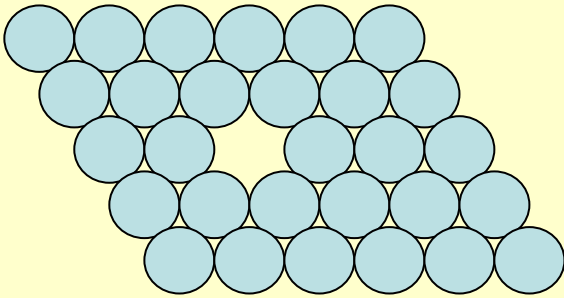

Intermediate state

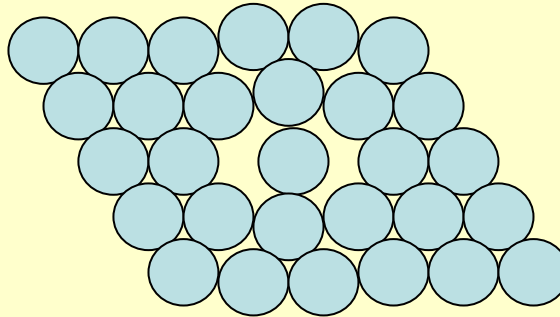

Final state

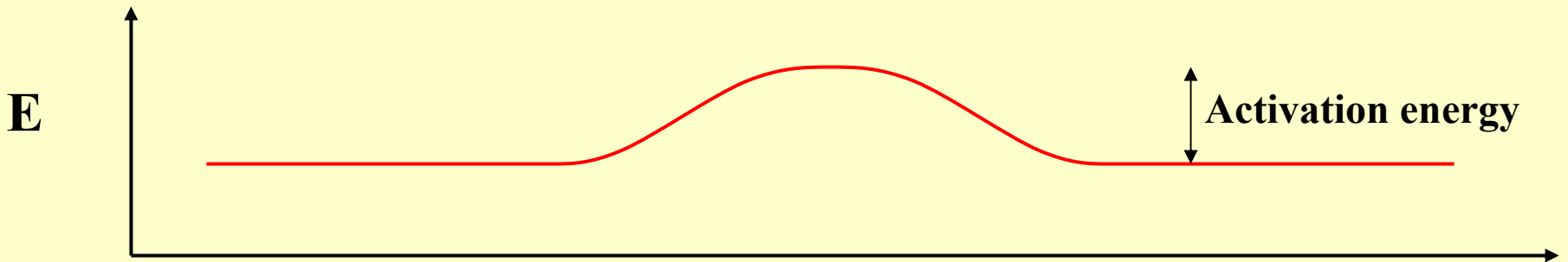
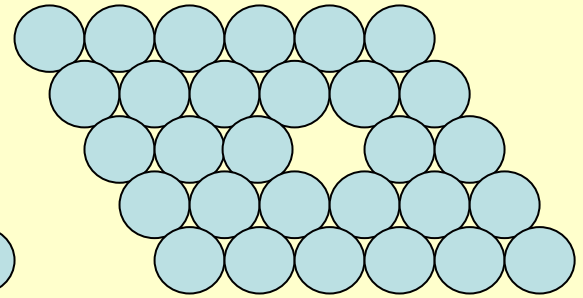

Energy barrier for diffusion

Energy Barrier for Diffusion

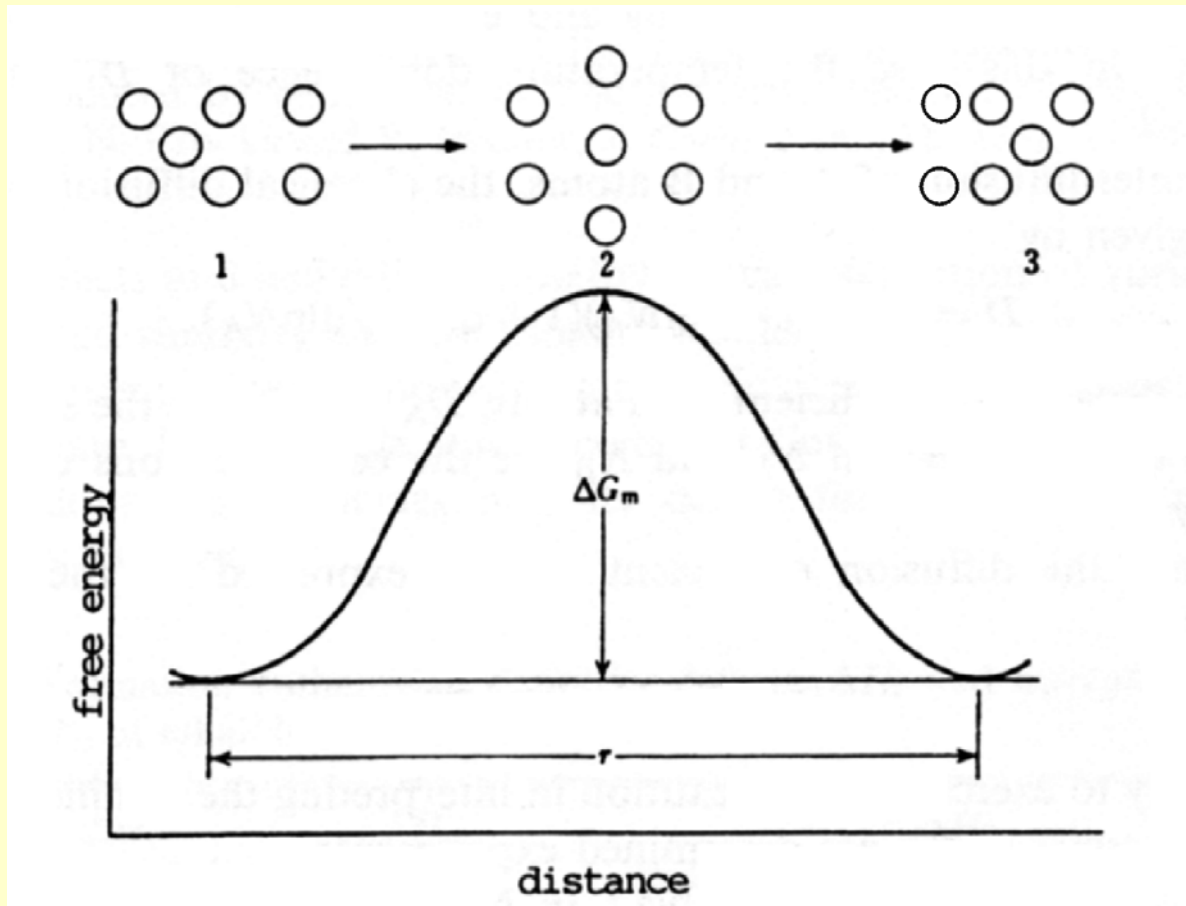

Diffusion Rate

$$D = D_{\infty} \exp\left(-\frac{Q}{RT}\right)$$

Diffusion coefficients show an exponential temperature dependence (Arrhenius type)

D = the diffusivity, which is proportional to the diffusion rate

$D_{\infty} = D$ for $T \rightarrow \infty$

Q = the activation energy

R = the gas constant

T = the absolute temperature

D is a function of temperature

Thus the flux (J) is also a function of temperature

High activation energy corresponds to low diffusion rates

The logarithmic representation of D versus 1/T is linear, the slope corresponds to the activation energy and the intercept to D_{∞}

Diffusion Coefficients

C in Fe

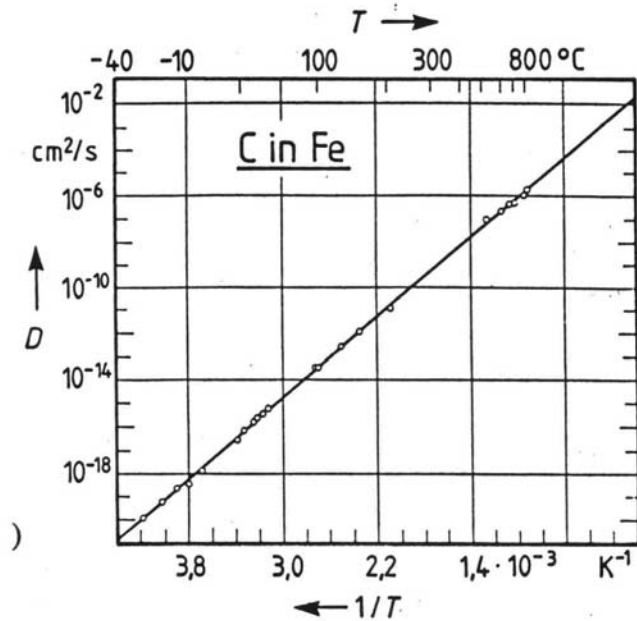

Ag in Ag

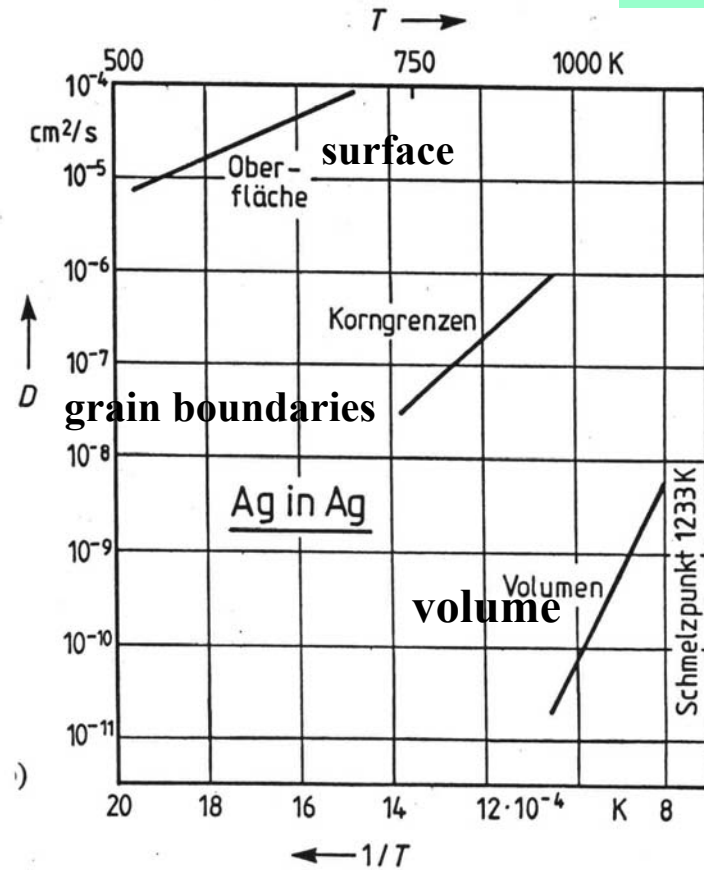

Diffusion coefficients show an exponential temperature dependence (Arrhenius type):

$$D = D_{\infty} \exp(-Q/kT) \quad (D_{\infty}: D \text{ for } T \rightarrow \infty, Q: \text{activation energy of diffusion, } k: \text{ Boltzmann-faktor})$$

The logarithmic representation of D versus $1/T$ is linear, the slope corresponds to the activation energy and the intercept to D_{∞} .

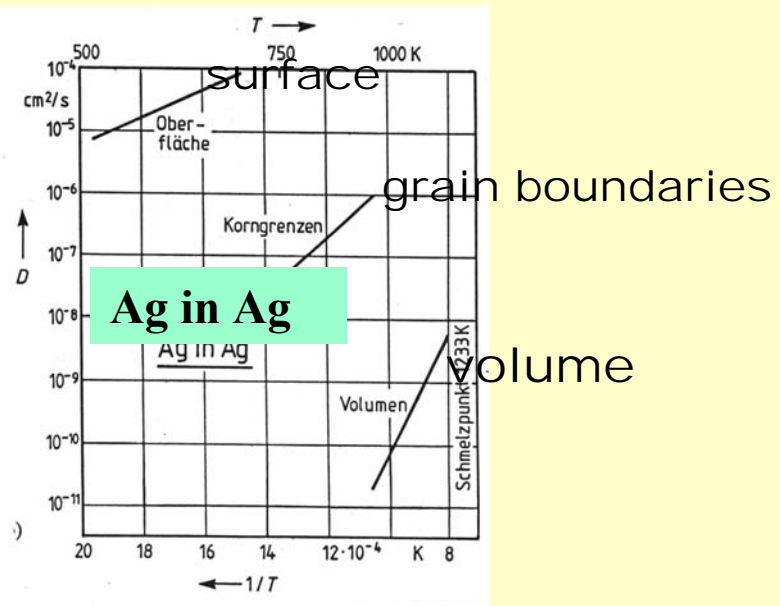
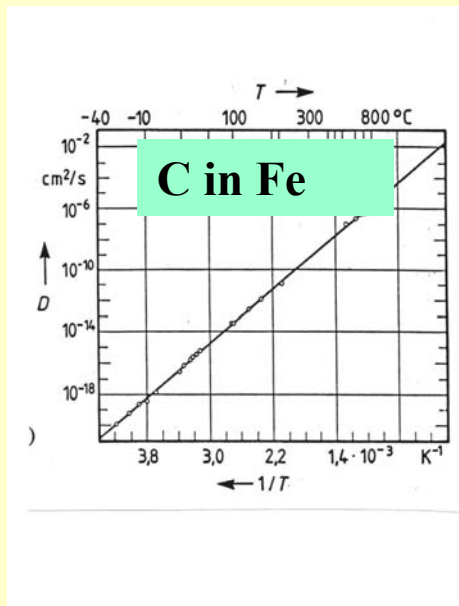

Diffusion

Velocity of diffusion of particles (ions, atoms ...) in a solid

- mass transport and concentration gradient for a given point in a solid!

$$J = \frac{dn}{A dt} = -D \frac{dc}{dx} \quad [\text{mol cm}^{-2} \text{ s}^{-1}] \quad (\text{const. T})$$

J_i : flow of diffusion ($\text{mol s}^{-1} \text{ cm}^{-2}$); D_i : diffusion coefficient ($\text{cm}^2 \text{ s}^{-1}$)

$\delta c_i / \delta x$: concentration gradient ($\text{mol cm}^{-3} \text{ cm}^{-1}$) (i.e. change of concentration along a line in the solid!)

Knowledge of D allows an estimation of the average diffusion length for the migrating particles:

$$\langle x^2 \rangle = 2Dt \quad (\langle x^2 \rangle: \text{average square of diffusion area; } t: \text{time})$$

Diffusivity of Fe and Carbon in Iron

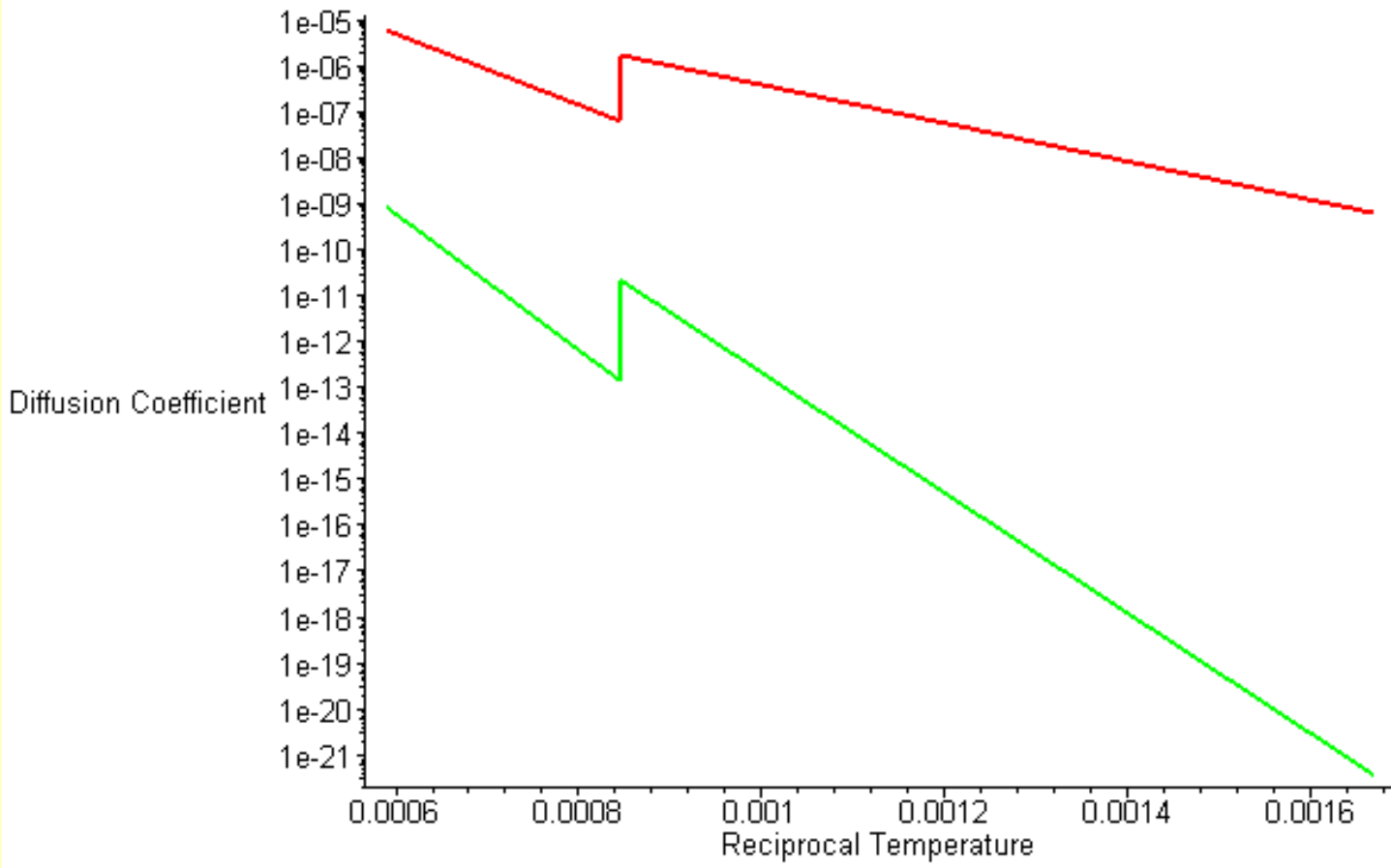

Diffusion

Diffusion FASTER for:

- open crystal structures
- lower melting T materials
- materials w/secondary bonding
- smaller diffusing atoms
- lower density materials

Diffusion SLOWER for:

- close-packed structures
- higher melting T materials
- materials w/covalent bonding
- larger diffusing atoms
- higher density materials