

Fauna obratlovců ČR (+SR)

4. Lissamphibia - Obojživelníci

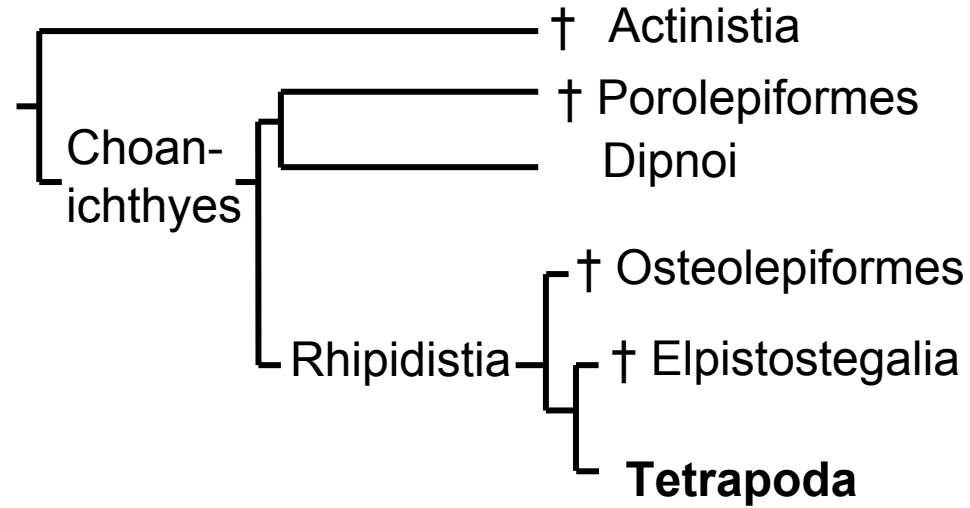

Sarcopterygii

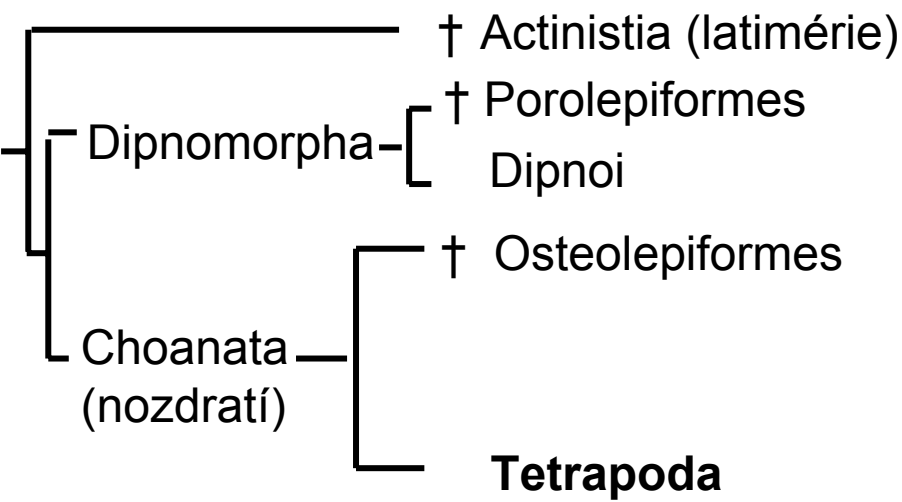

Tetrapoda

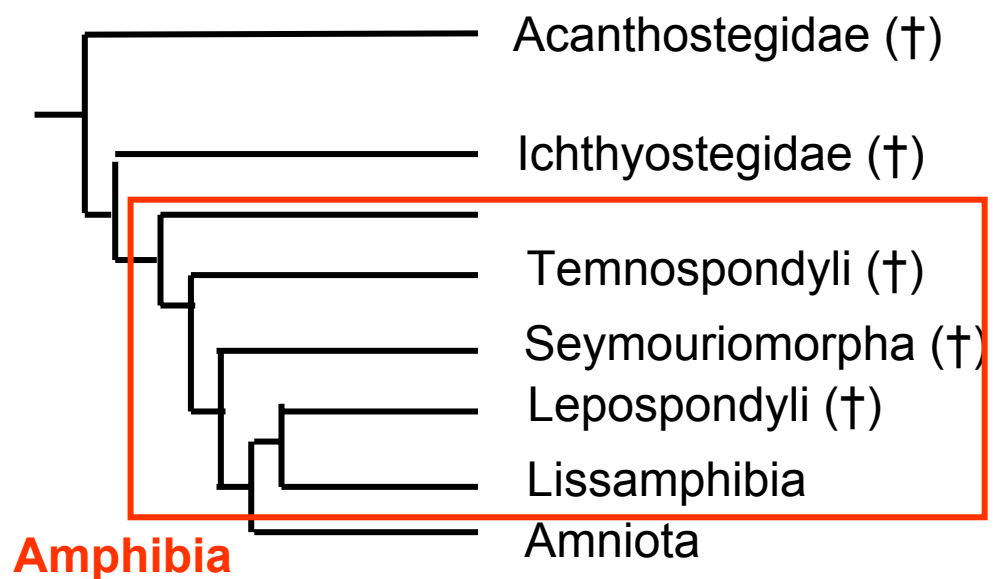
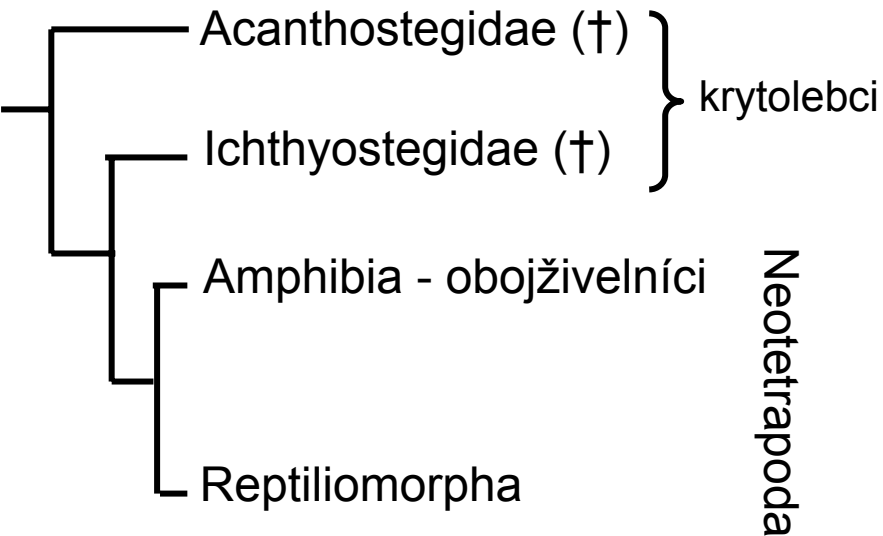

Amphibia

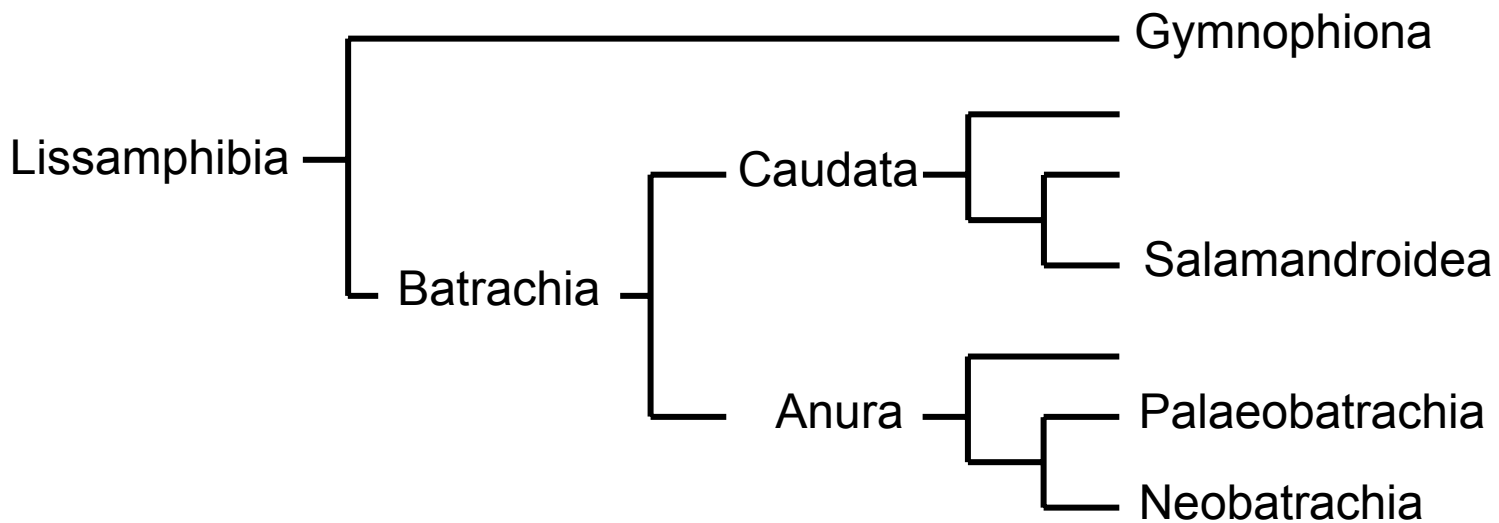
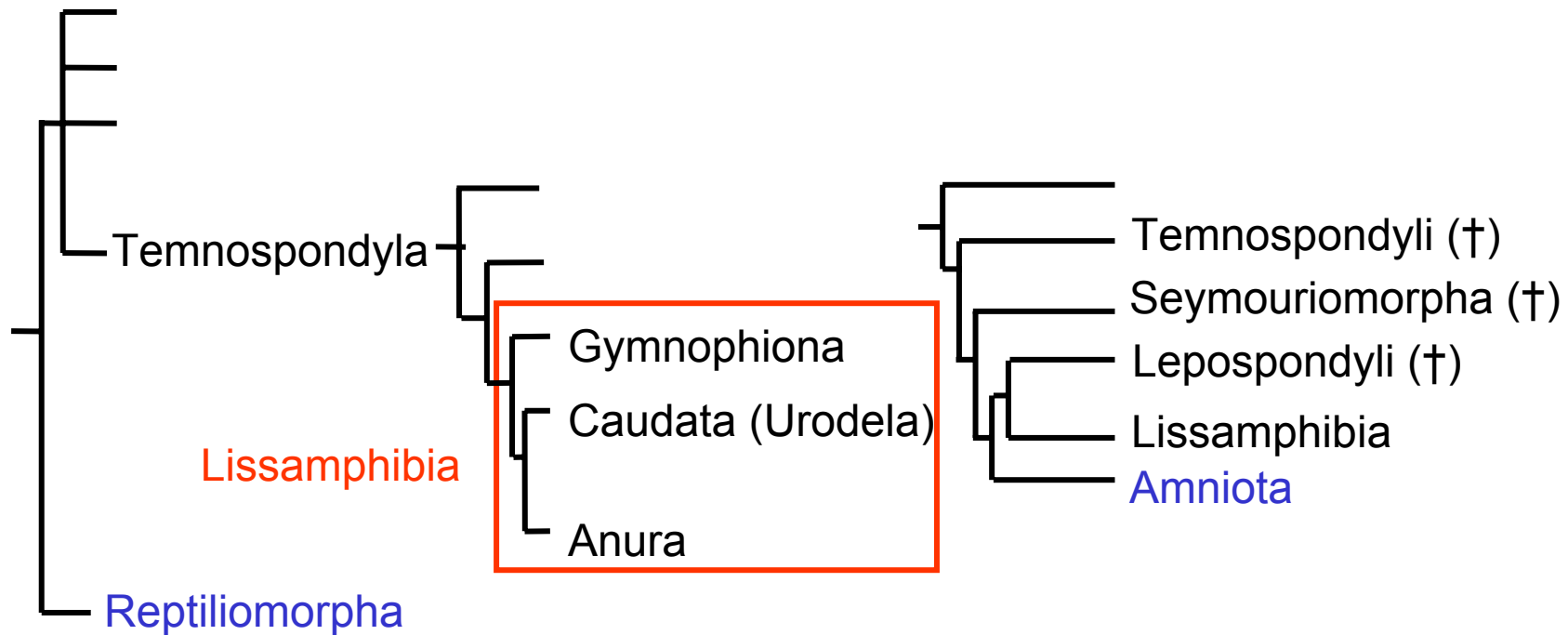

Obojživelníci – Lissamphibia

Ocasatí – Caudata

Čeď: mlokovití (Salamandridae)



Salamandra salamandra (Linnaeus, 1758) – mlok skvrnitý

Triturus carnifex (Laurenti, 1768) – čolek dravý

Triturus cristatus (Laurenti, 1768) – čolek velký

Triturus dobrogicus (Kiritzescu, 1903) – čolek dunajský

Ichthyosaura alpestris

Mesotriton alpestris (Laurenti, 1768) – čolek horský

Lissotriton helveticus (Razoumovsky, 1789) – čolek hranatý

Lissotriton montandoni (Boulenger, 1880) – čolek karpatský

Lissotriton vulgaris (Linnaeus, 1758) - čolek obecný



Mlok skvrnitý - *Salamandra salamandra*

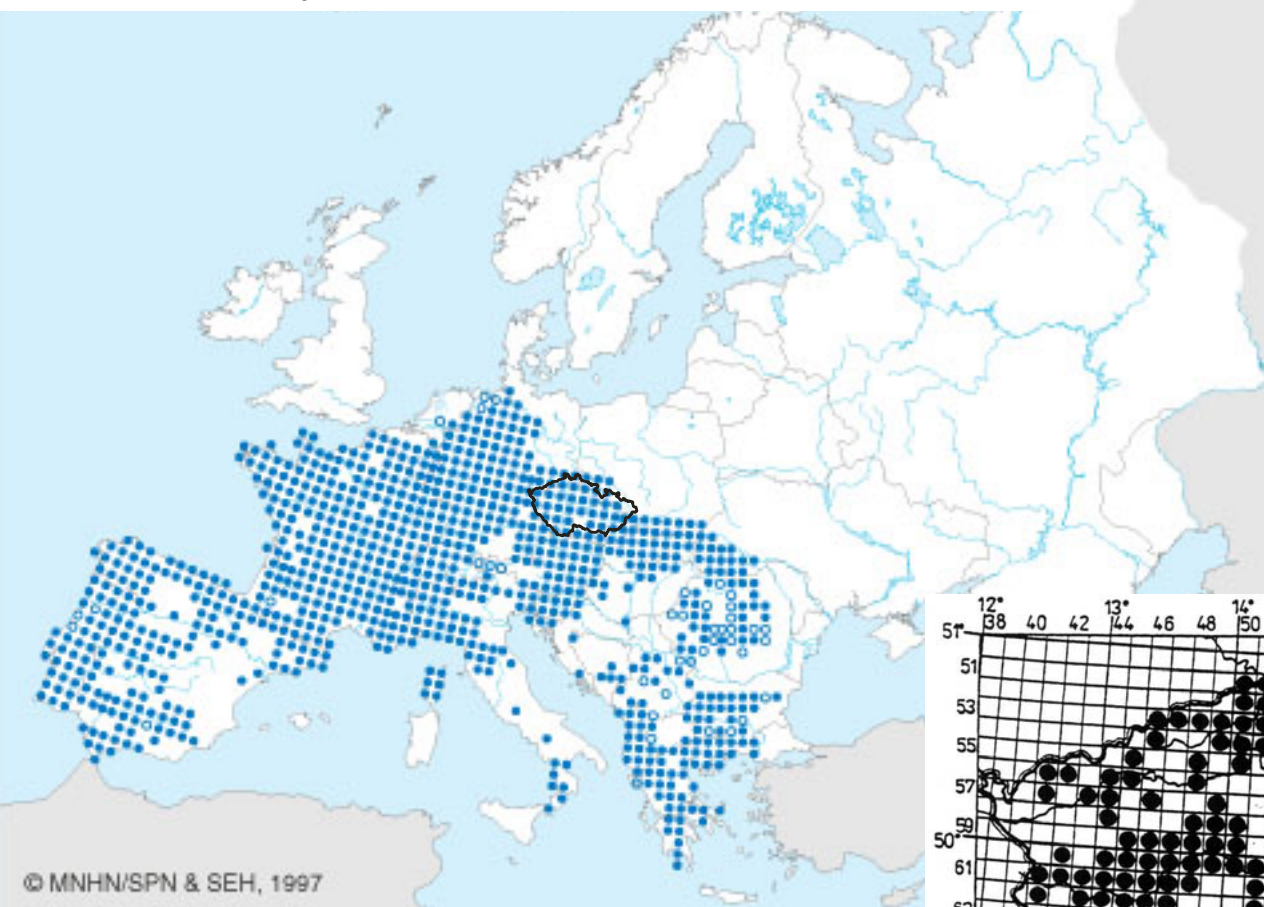

© MNHN/SPN & SEH, 1997

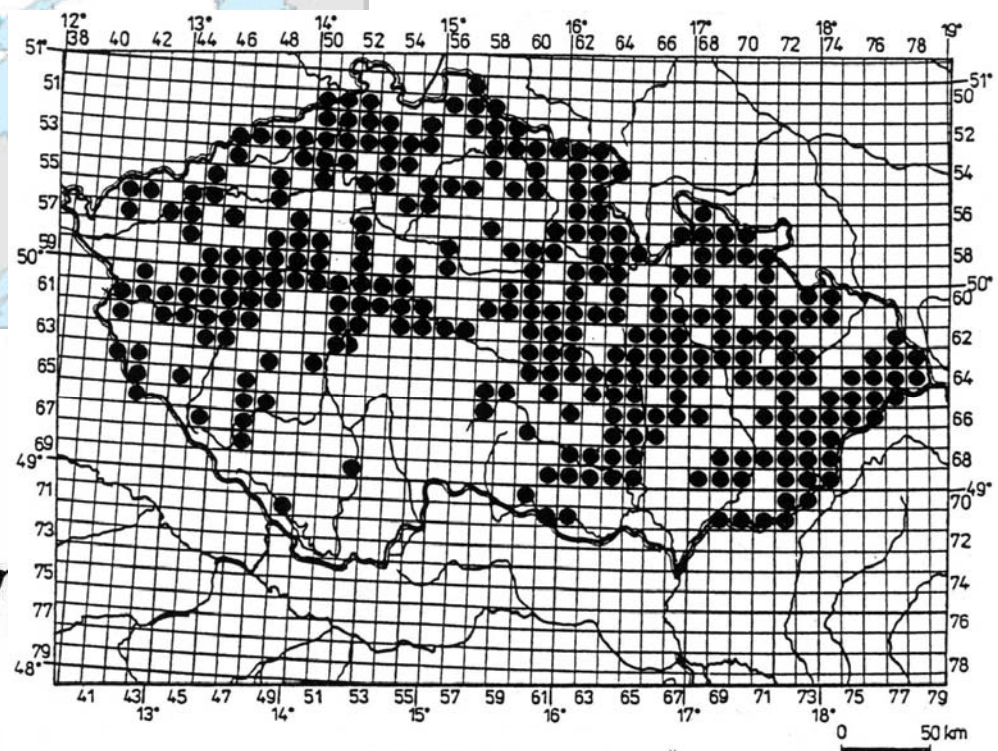

Obr. 2. Rozšíření *S. salamandra* v ČR

Obojživelníci – Lissamphibia

Ocasatí – Caudata

mlokovití (Salamandridae)

Triturus

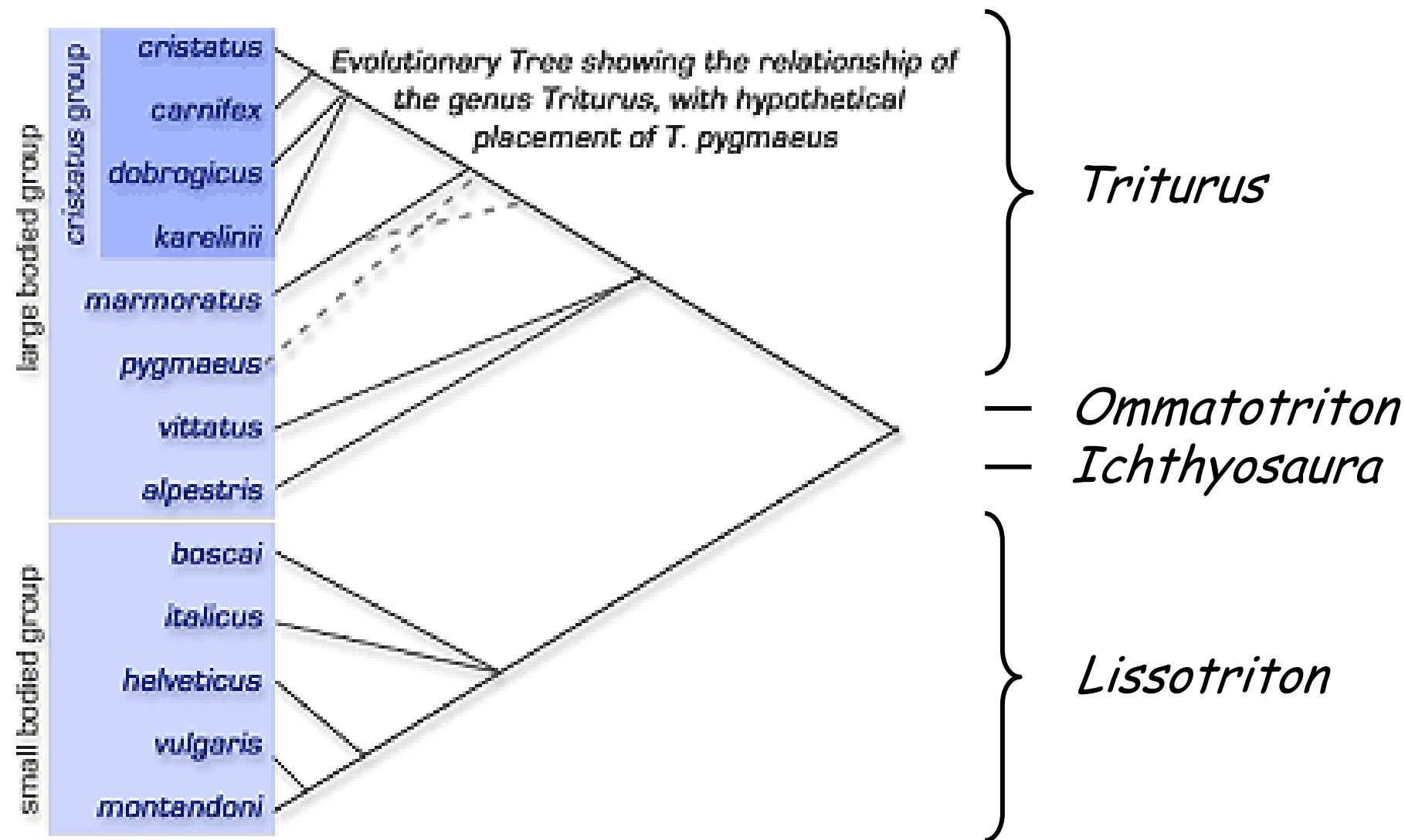



Čolek velký - *Triturus cristatus*
(Laurenti, 1768)

EN, LR, SO

Čolek dunajský - *Triturus dobrogicus*
(Kiritzescu, 1903)

CR, DD, ?

Čolek dravý - *Triturus carnifex*
(Laurenti, 1768)

CR, -, KO

Čolek dravý - *Triturus carnifex*
 Čolek velký - *Triturus cristatus*
 Čolek dunajský - *Triturus dobrogicus*

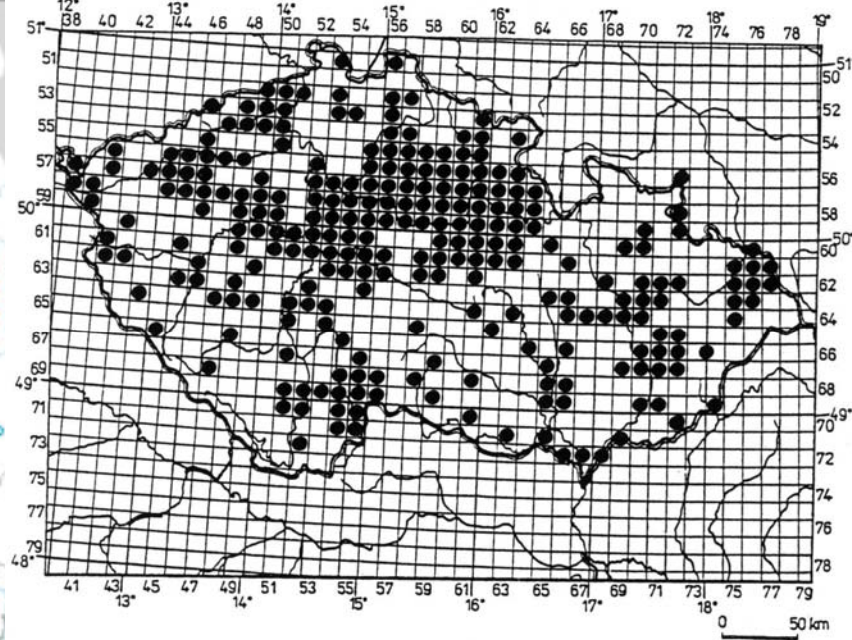
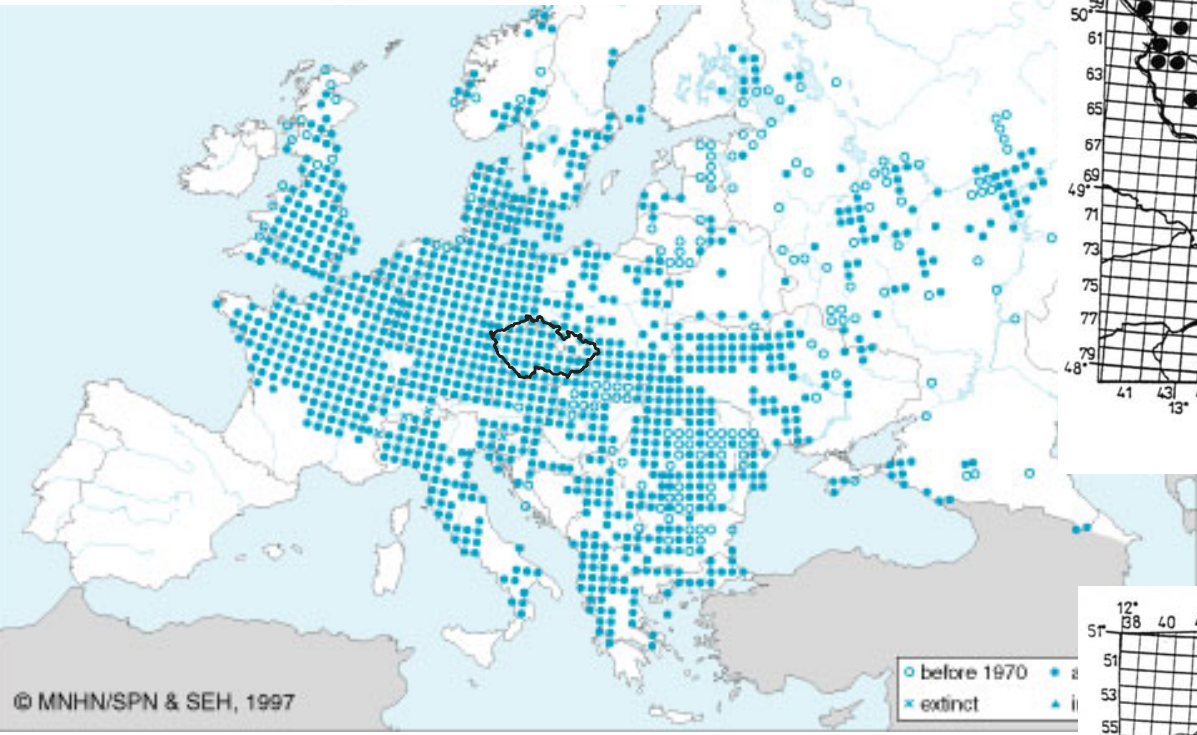

Obr. 7. Rozšíření *T. cristatus* v ČR

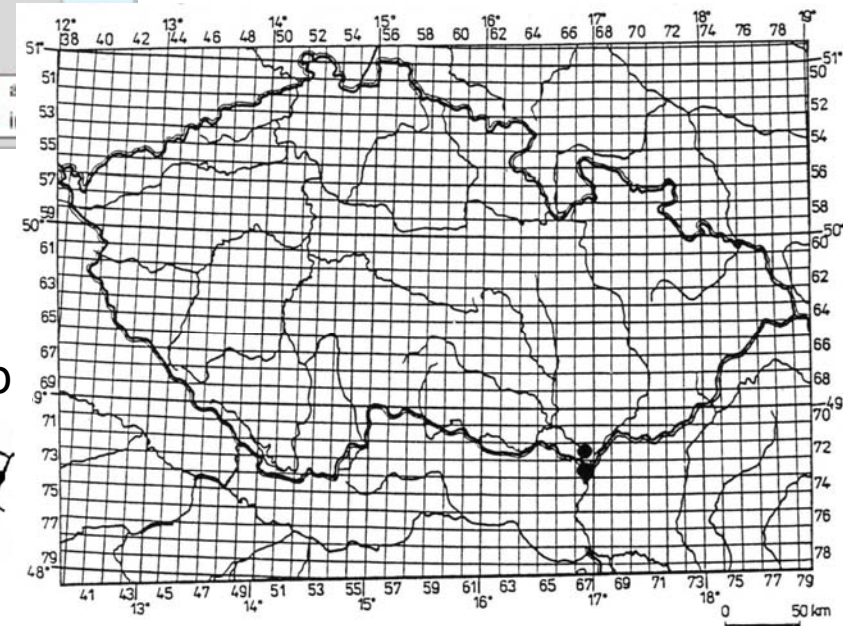
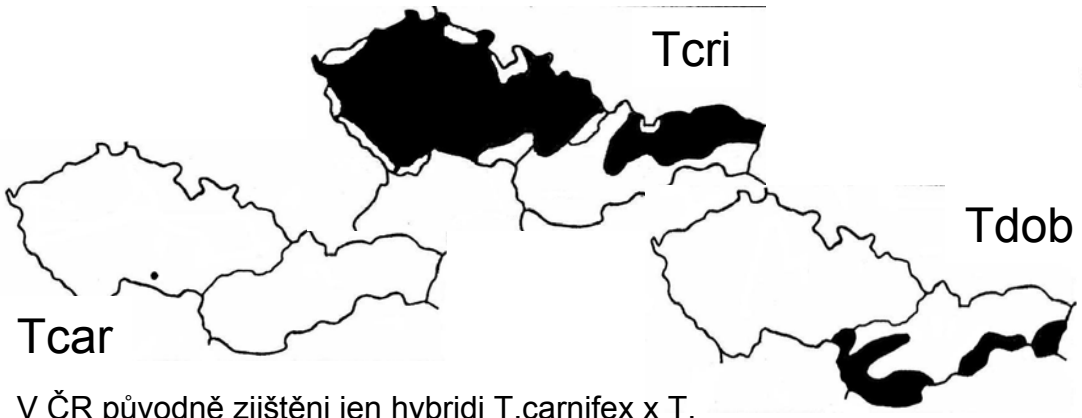

Obr. 8. Rozšíření *T. dobrogicus* v ČR

V ČR původně zjištěni jen hybridy *T. carnifex* x *T. cristatus*, dnes již i čistá populace *T. carnifex*, na V Slovensku i hybridy *T. dobrogicus* x *T. cristatus*

Čolek horský – *Mesotriton alpestris* (Laurenti, 1768)

NT,-, SO

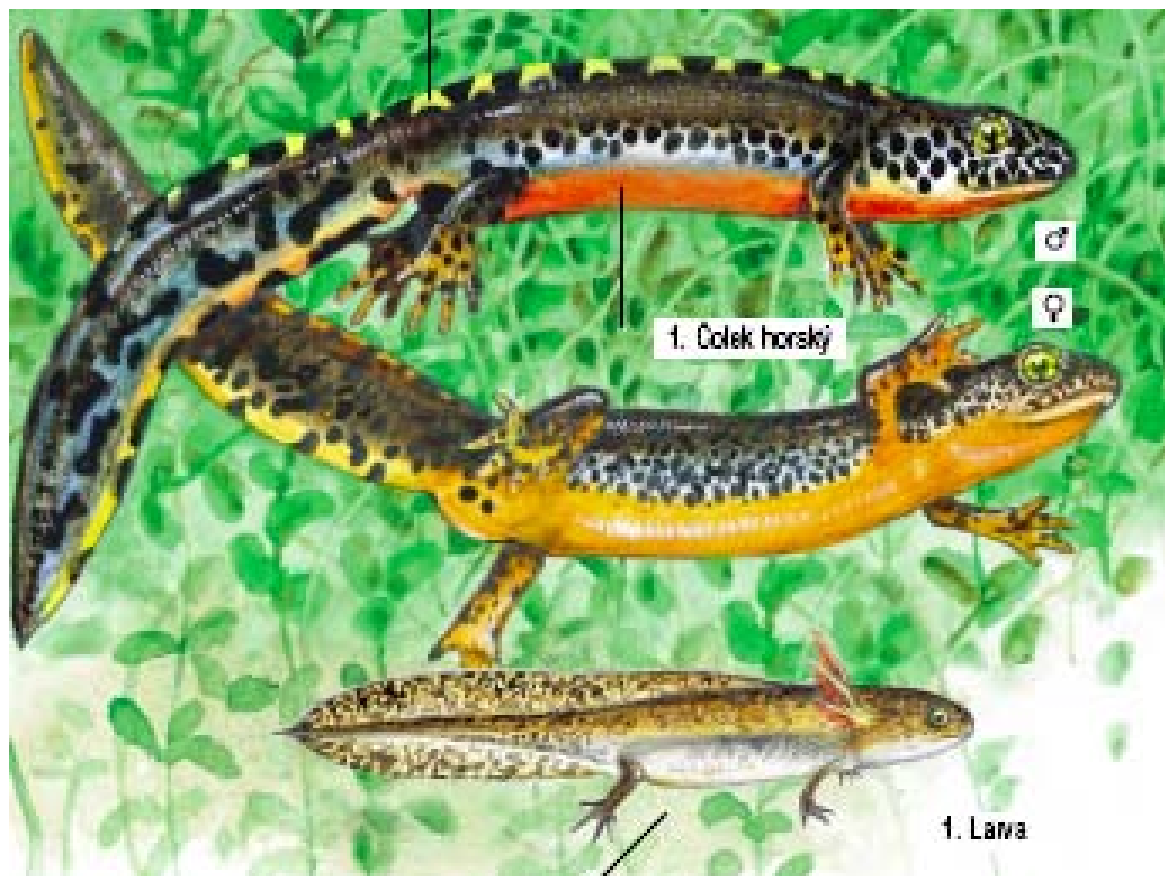

Čolek horský - *Mesotriton alpestris*

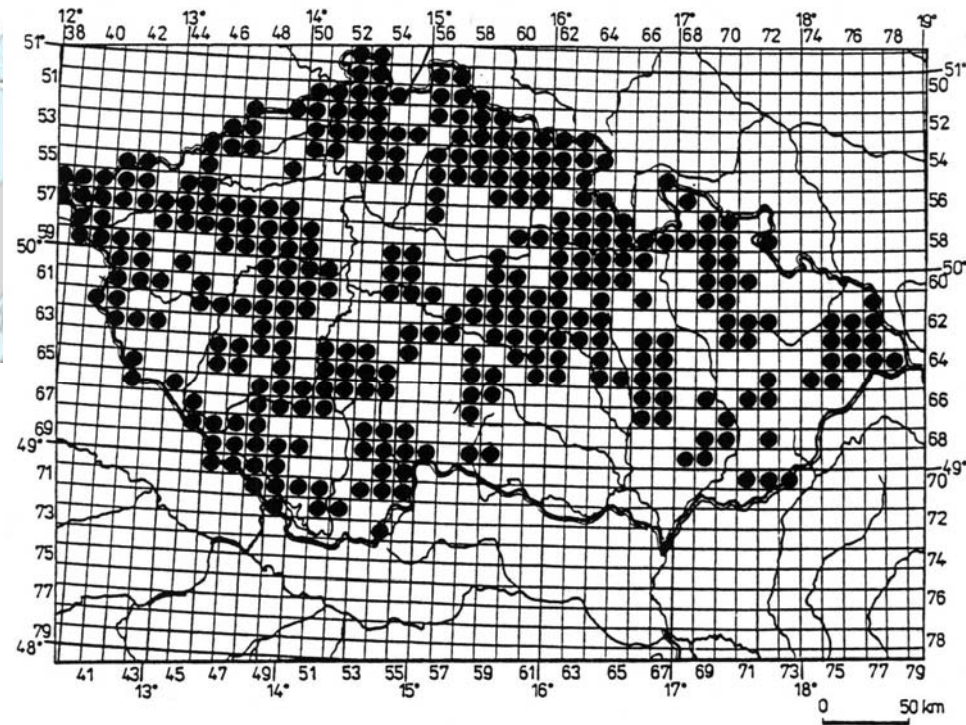

Obr. 3. Rozšíření *T. alpestris* v ČR

Čolek hranatý - *Lissotriton helveticus* (Razoumovsky, 1789)

CR,-, KO

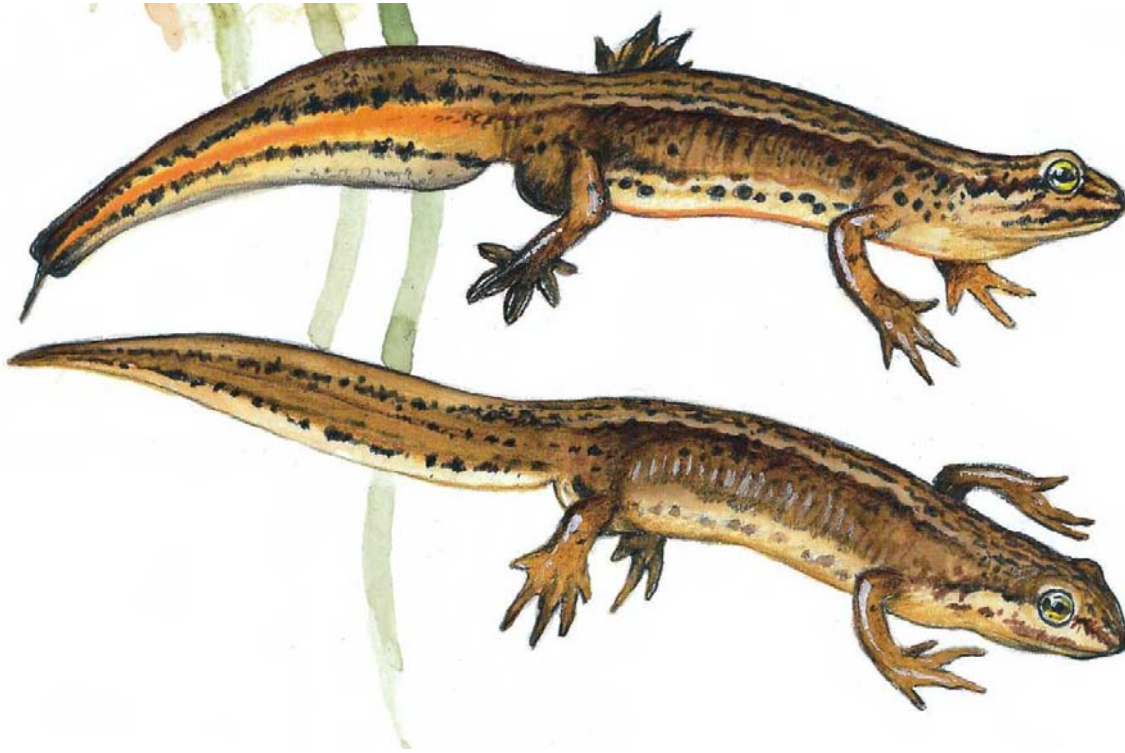

Čolek hranatý - *Lissotriton helveticus*

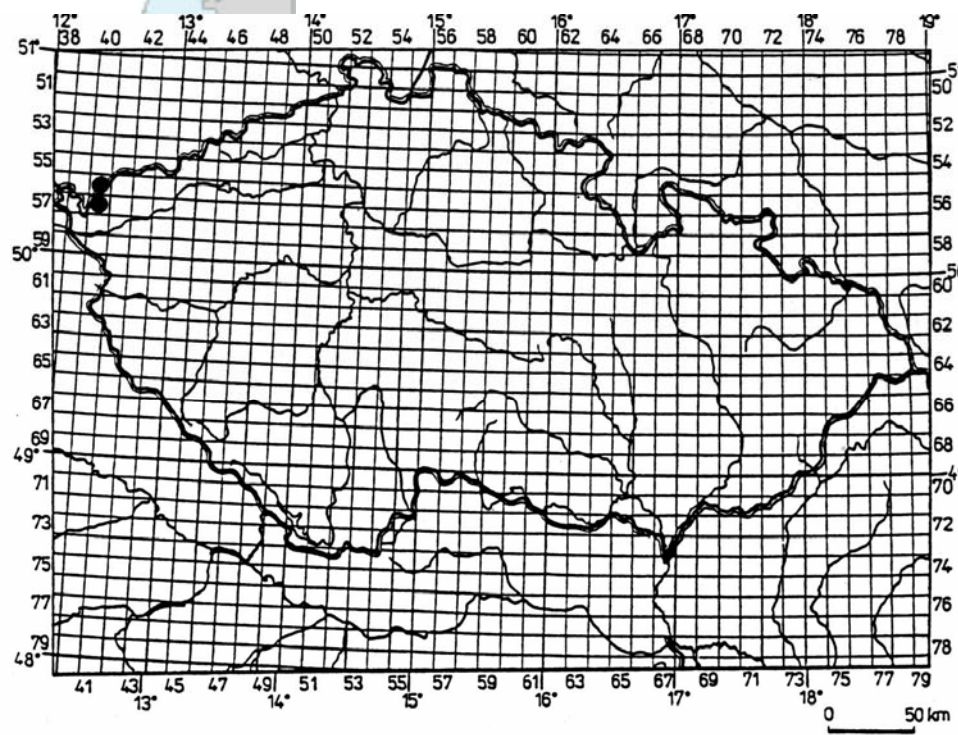
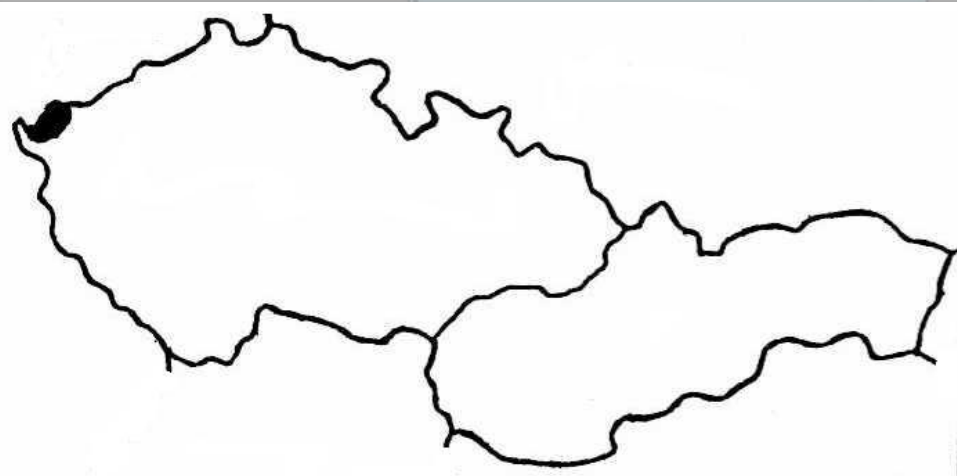
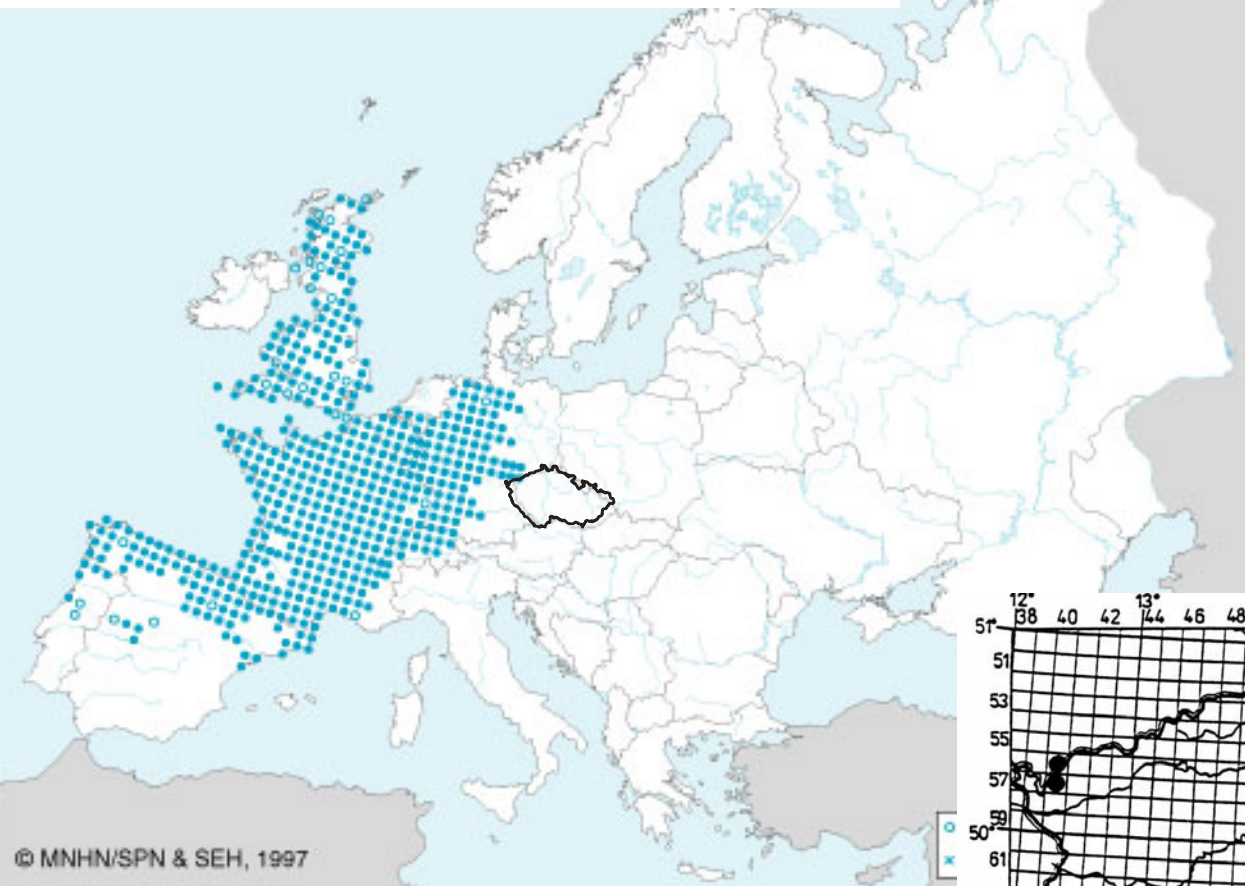

Obr. 4. Rozšíření *T. helveticus* v ČR

Čolek karpatský - *Lissotriton montandoni* (Boulenger, 1880)

CR/EN,-, KO

CR – sudetská populace, EN – karpatská populace

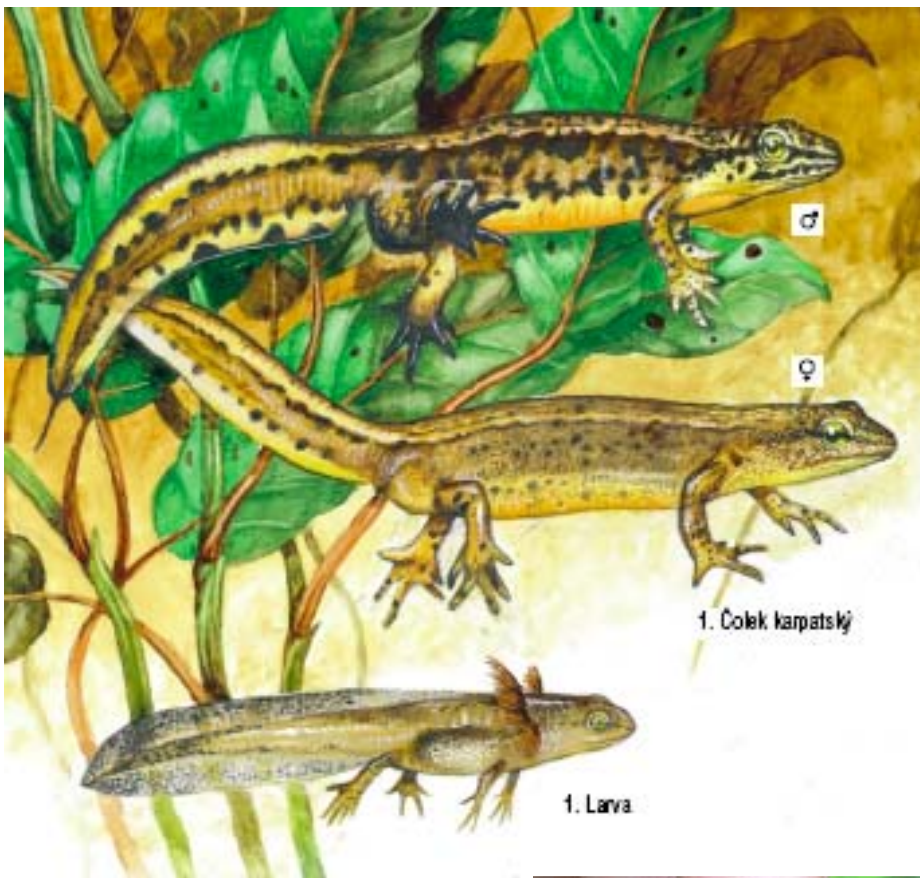

Čolek karpatský - *Lissotriton montandoni*

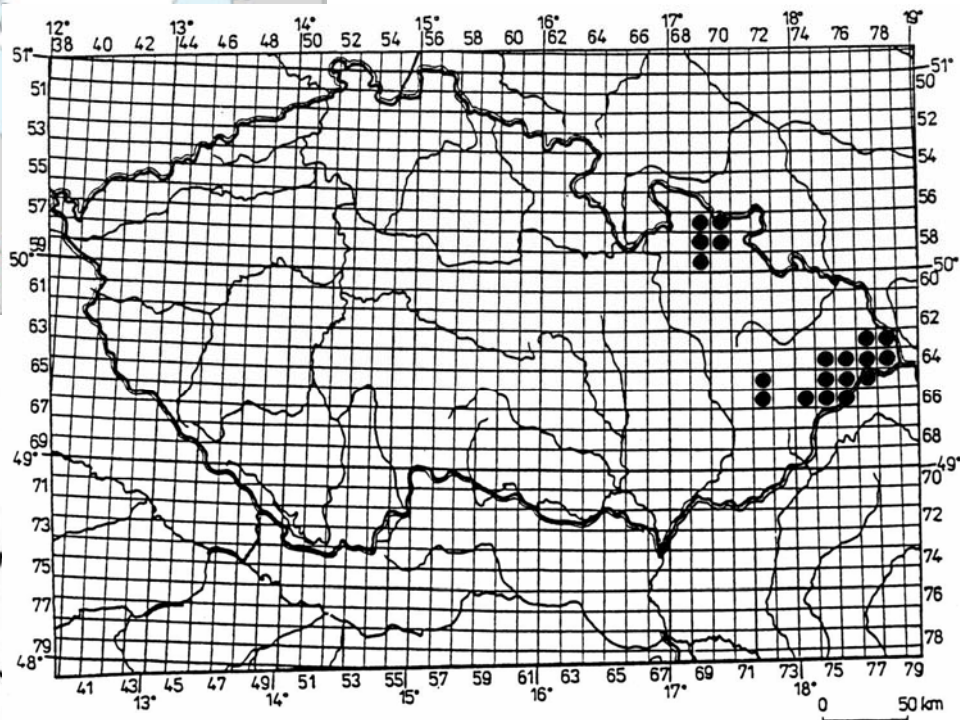
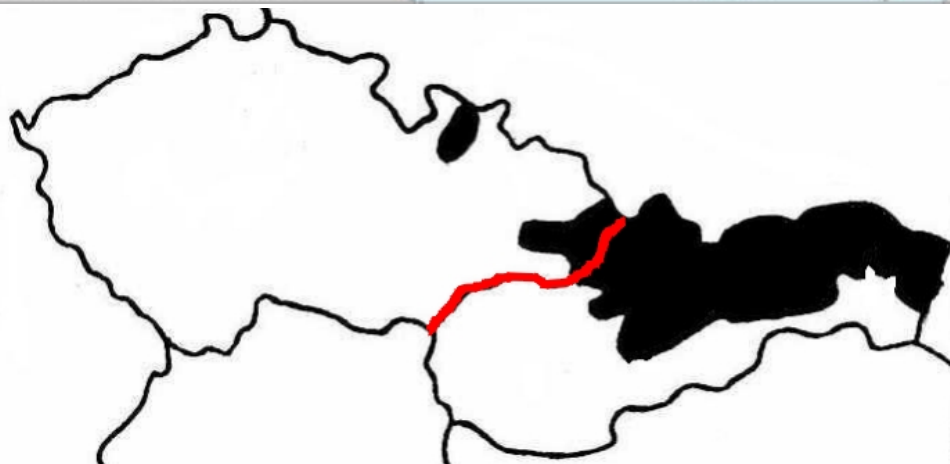

Obr. 5. Rozšíření *T. montandoni* v ČR

Čolek obecný - *Triturus vulgaris* (Linnaeus, 1758)

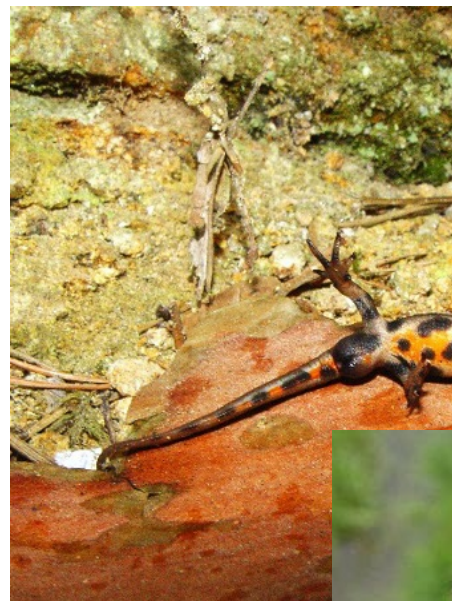
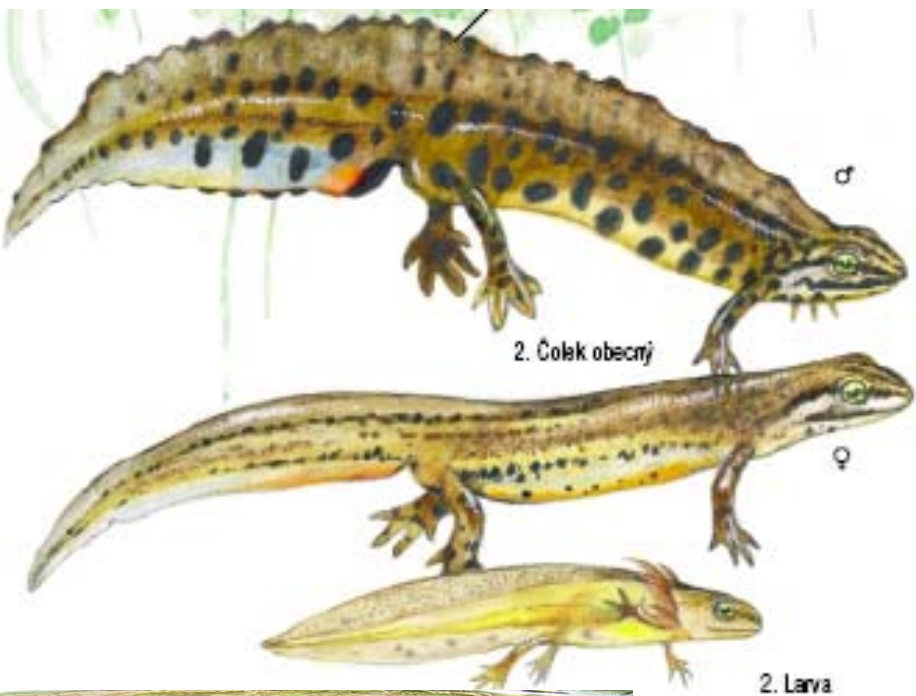

LC,-, SO



Čolek obecný - *Triturus vulgaris*

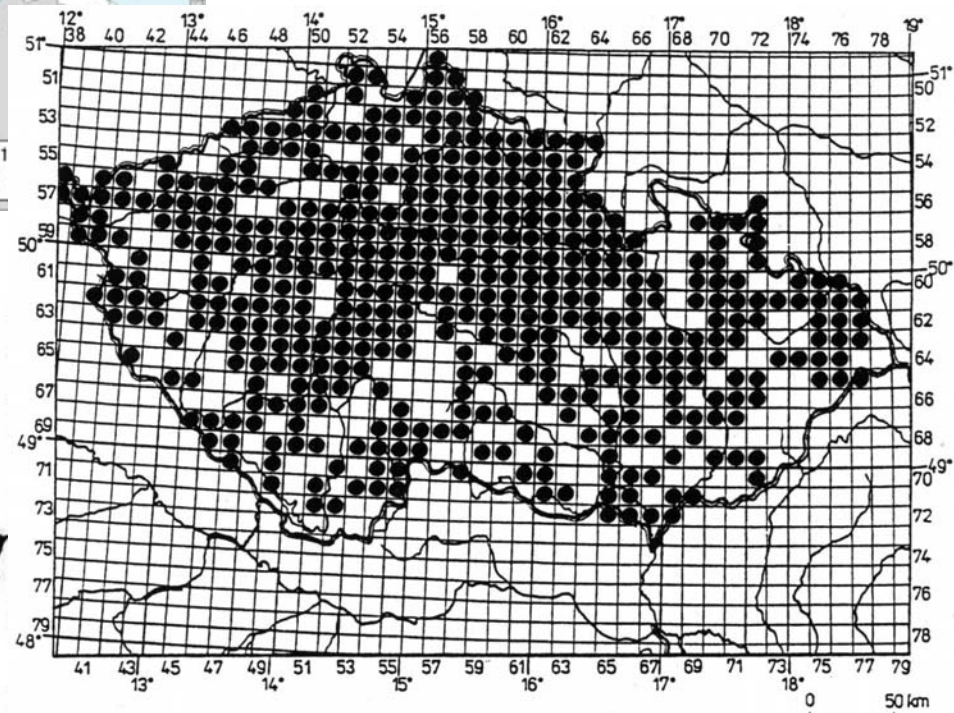
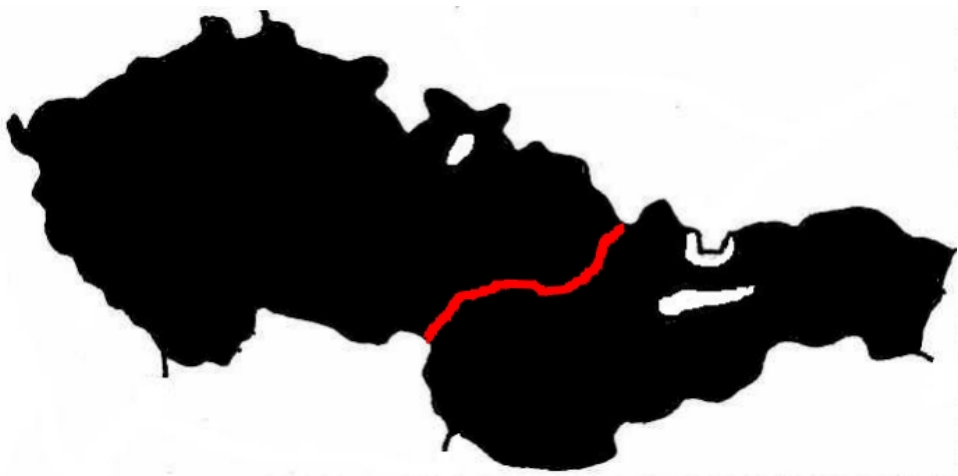
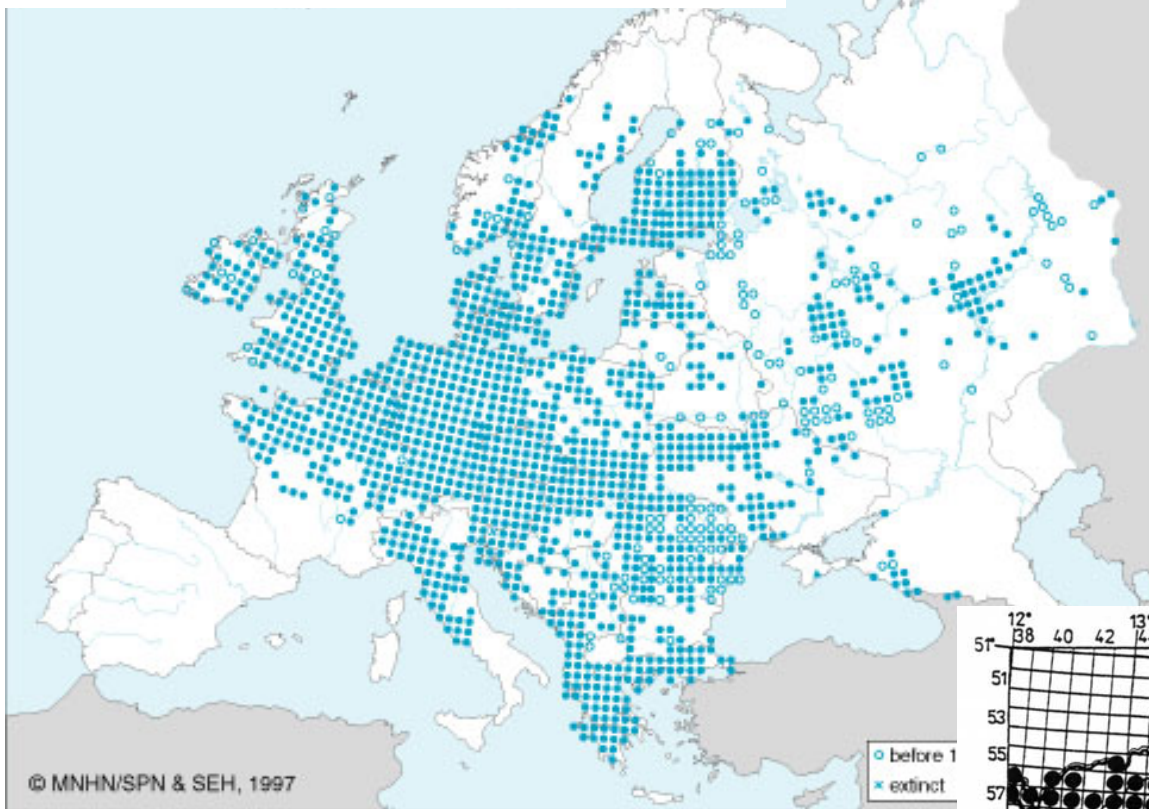

Obr. 6. Rozšíření *T. vulgaris* v ČR

Řád: **Žáby – Anura**

Palaeobatrachia

Čeď: kuňkovití (Bombinatoridae, Discoglossidae)

Bombina bombina (Linnaeus, 1761) – kuňka obecná (ohnivá)

Bombina variegata (Linnaeus, 1758) – kuňka žlutobřichá

Čeď: blatnicovití (Pelobatidae)

Pelobates fuscus (Laurenti, 1768) – blatnice skvrnitá

Neobatrachia

Čeď: ropuchovití (Bufonidae)

Bufo bufo (Linnaeus, 1758) – ropucha obecná

Epidalea calamita (Laurenti, 1768) – ropucha krátkonohá

Epidalea viridis (Laurenti, 1768) – ropucha zelená

Čeď: rosníčkovití (Hylidae)

Hyla arborea (Linnaeus, 1758) – rosnička zelená

Čeď: skokanovití (Ranidae)

Rana arvalis Nilsson, 1842 – skokan ostronosý

Rana dalmatina Fitzinger in Bonaparte, 1839 – skokan štíhlý

Rana temporaria Linnaeus, 1758 – skokan hnědý

Pelophylax lessonae (Camerano, 1882) – skokan menší (krátkonohý)

Pelophylax ridibundus (Pallas, 1771) – skokan skřehotavý

Pelophylax kl. *esculentus* (Linnaeus, 1758) – skokan zelený

Kuňka obecná - *Bombina bombina* (Linnaeus, 1761)

EN,-, SO

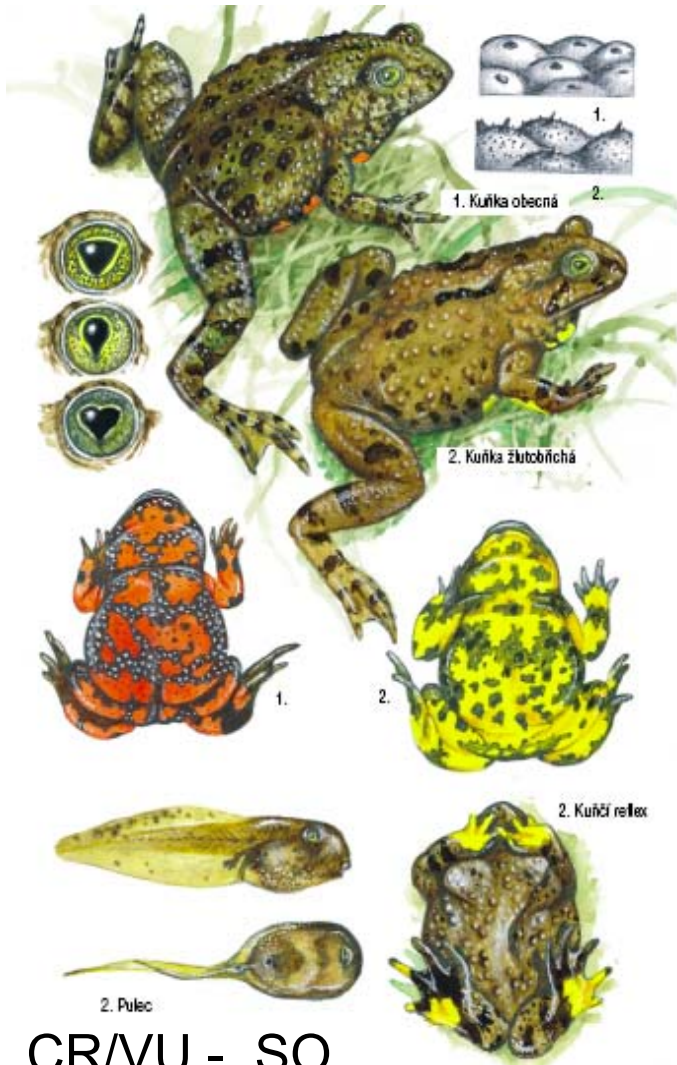

CR/VU,-, SO

CR – alpská větev, VU – karpatská větev



Kuňka žltobřichá - *Bombina variegata* (Linnaeus, 1758)

Kuňka obecná - *Bombina bombina*

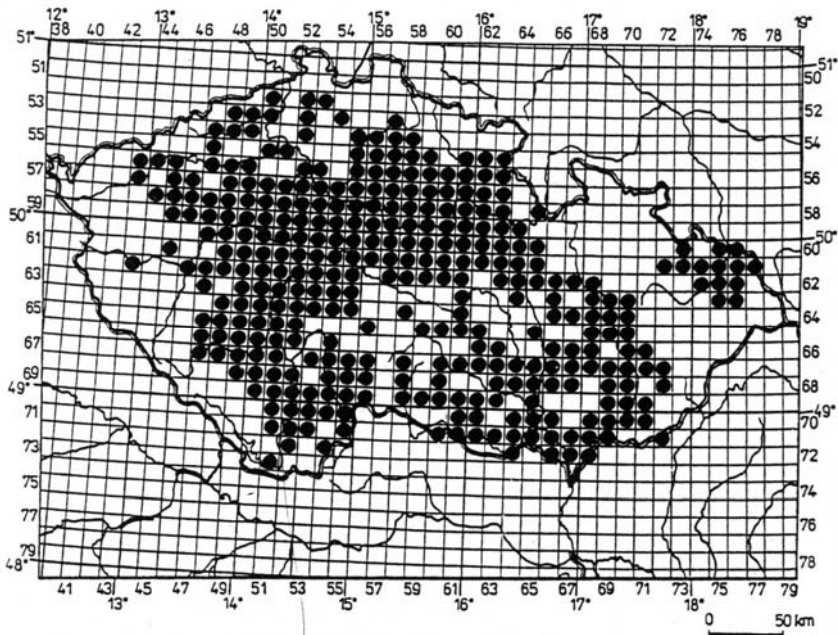
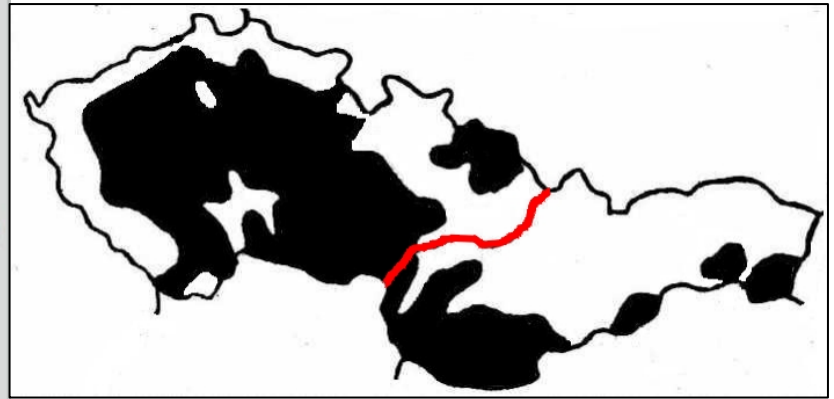
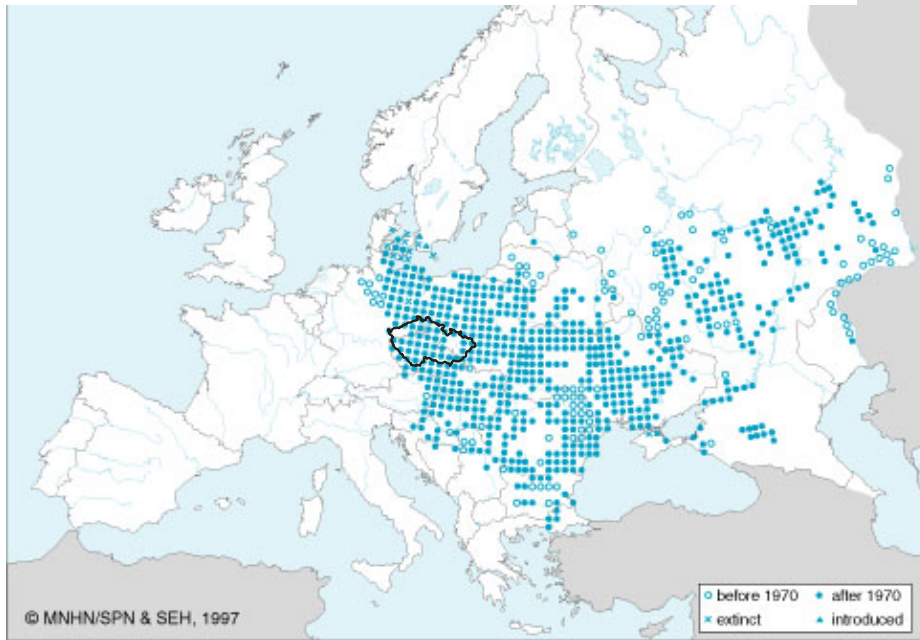

Bombina bombina

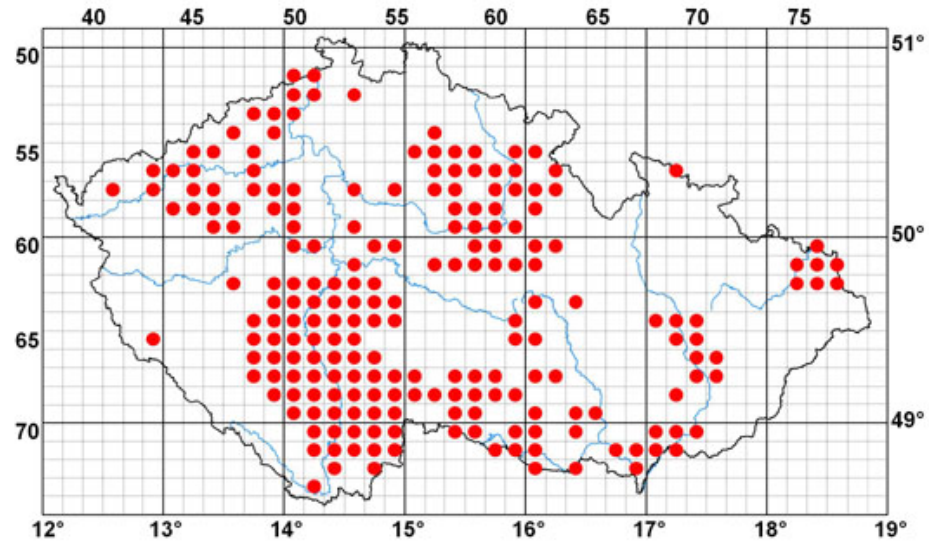

Obr. 9. Rozšíření *B. bombina* v ČR

Kuňka žlutobřichá - *Bombina variegata*

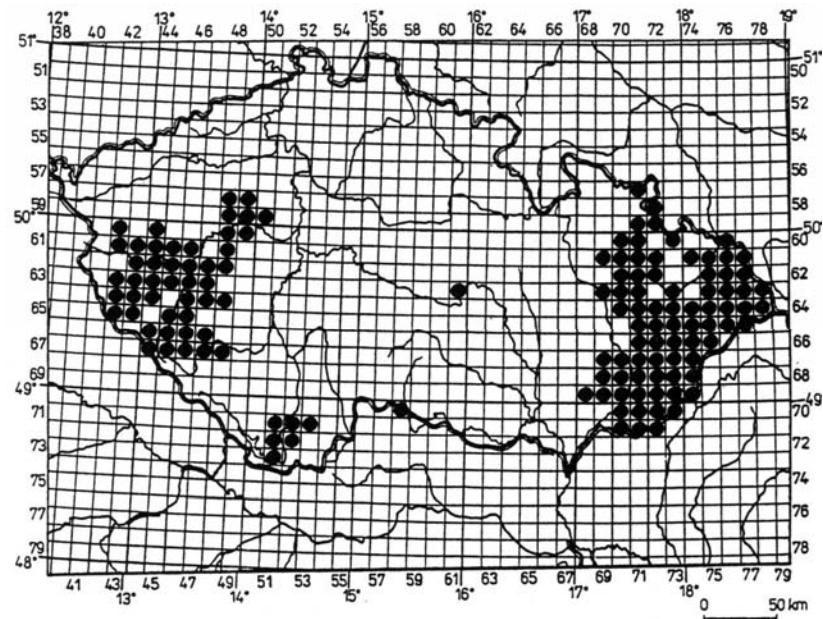
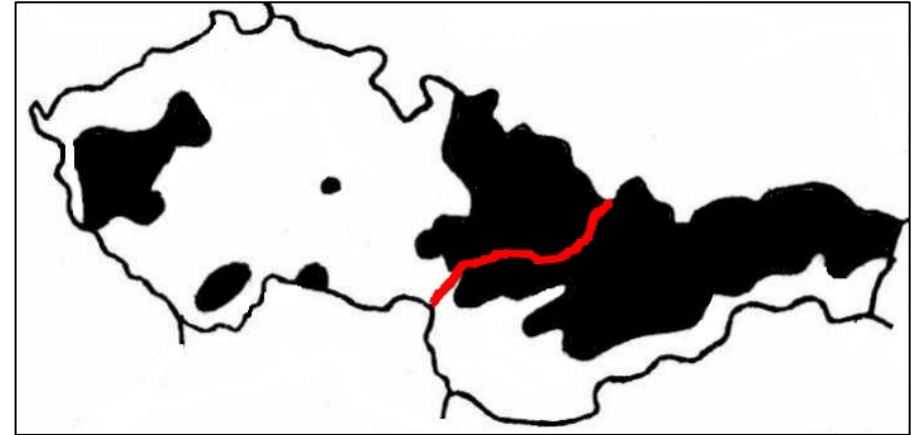
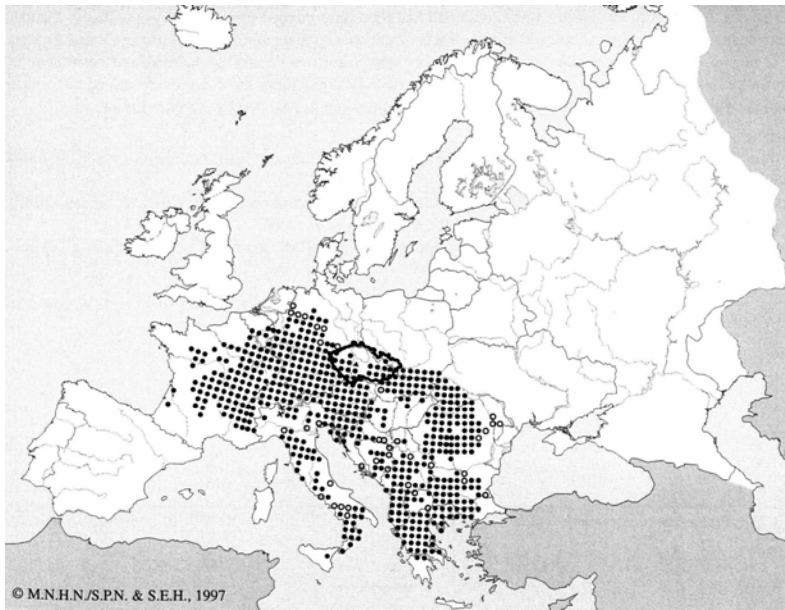

Bombina variegata

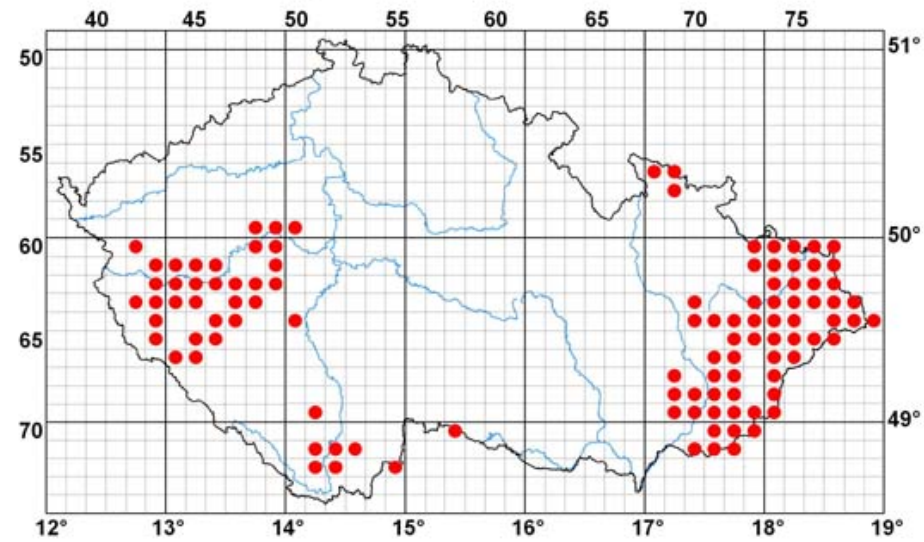

Obr. 10. Rozšíření *B. variegata* v ČR

Kuňka ohnivá - - *Bombina bombina*

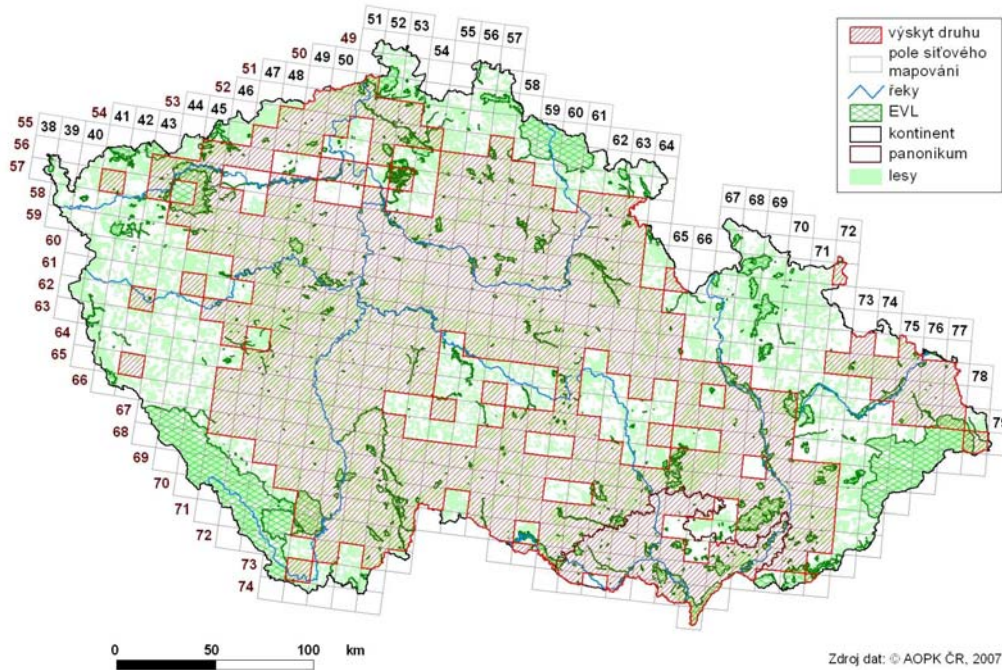

Kuňka žlutobřichá - - *Bombina variegata*

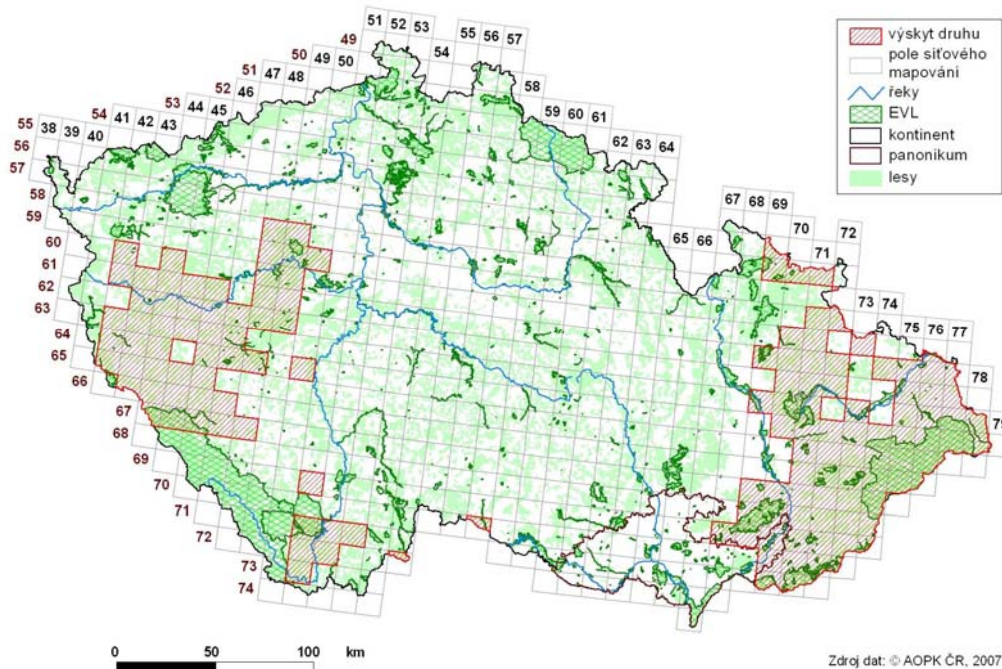

Blatnice skvrnitá - *Pelobates fuscus* (Laurenti, 1768)

NT,-, SO

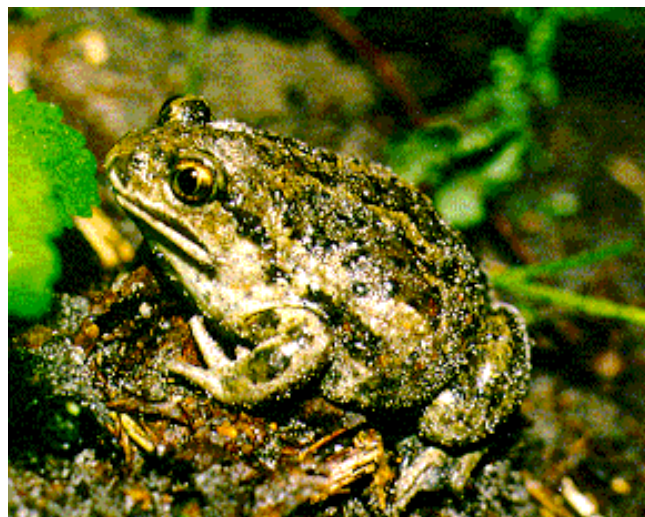

Blatnice skvrnitá - *Pelobates fuscus*

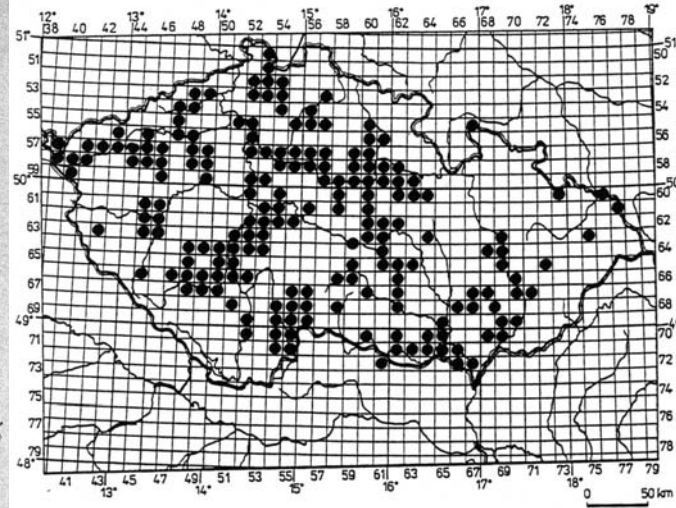
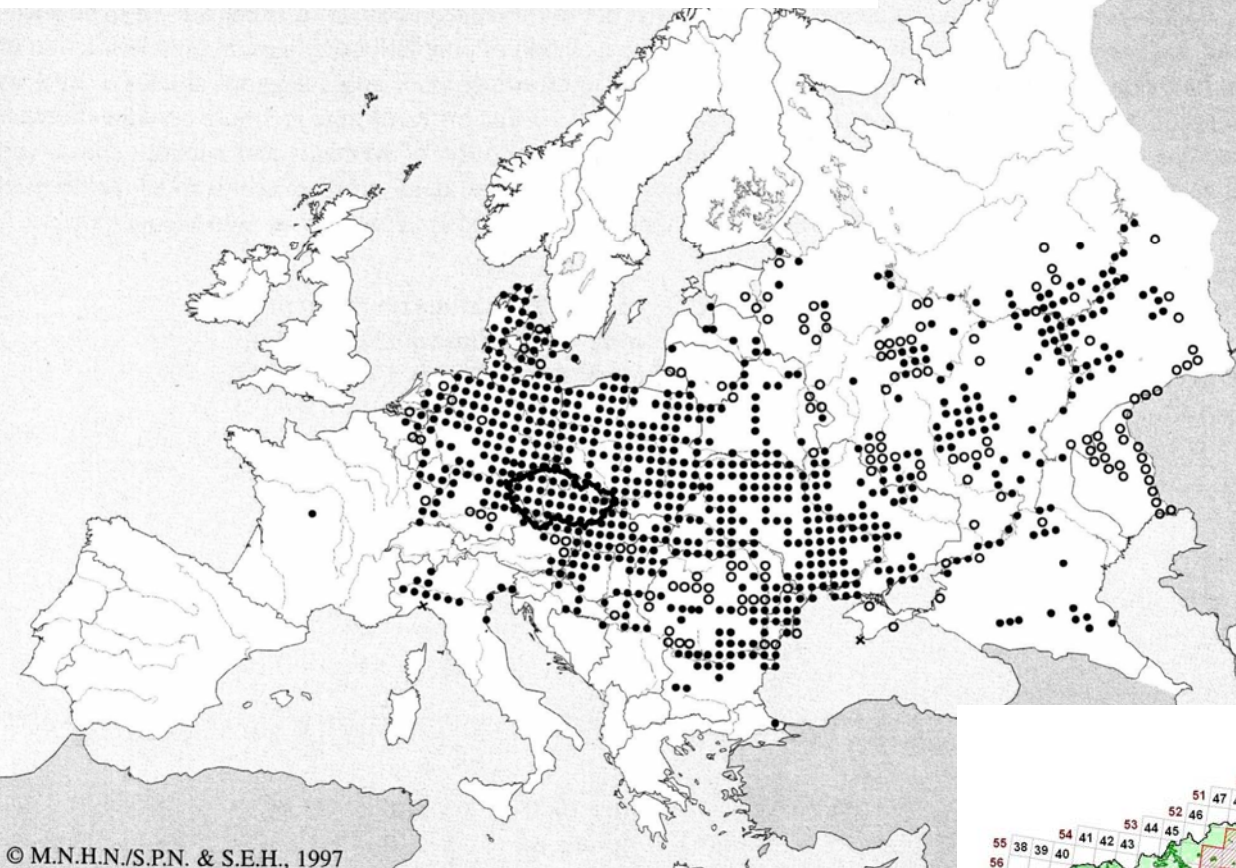

Obr. 11. Rozšíření *P. fuscus* v ČR

© M.N.H.N./S.P.N. & S.E.H., 1997

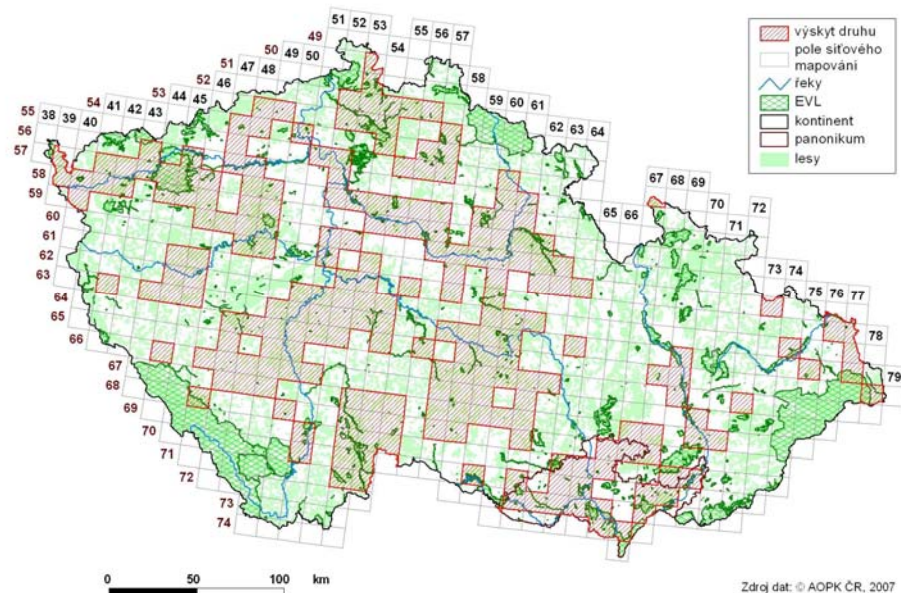

Zdroj dat: © AOPK ČR, 2007

Ropucha obecná - *Bufo bufo* (Linnaeus, 1758)

LC,-, O



Ropucha obecná - *Bufo bufo*

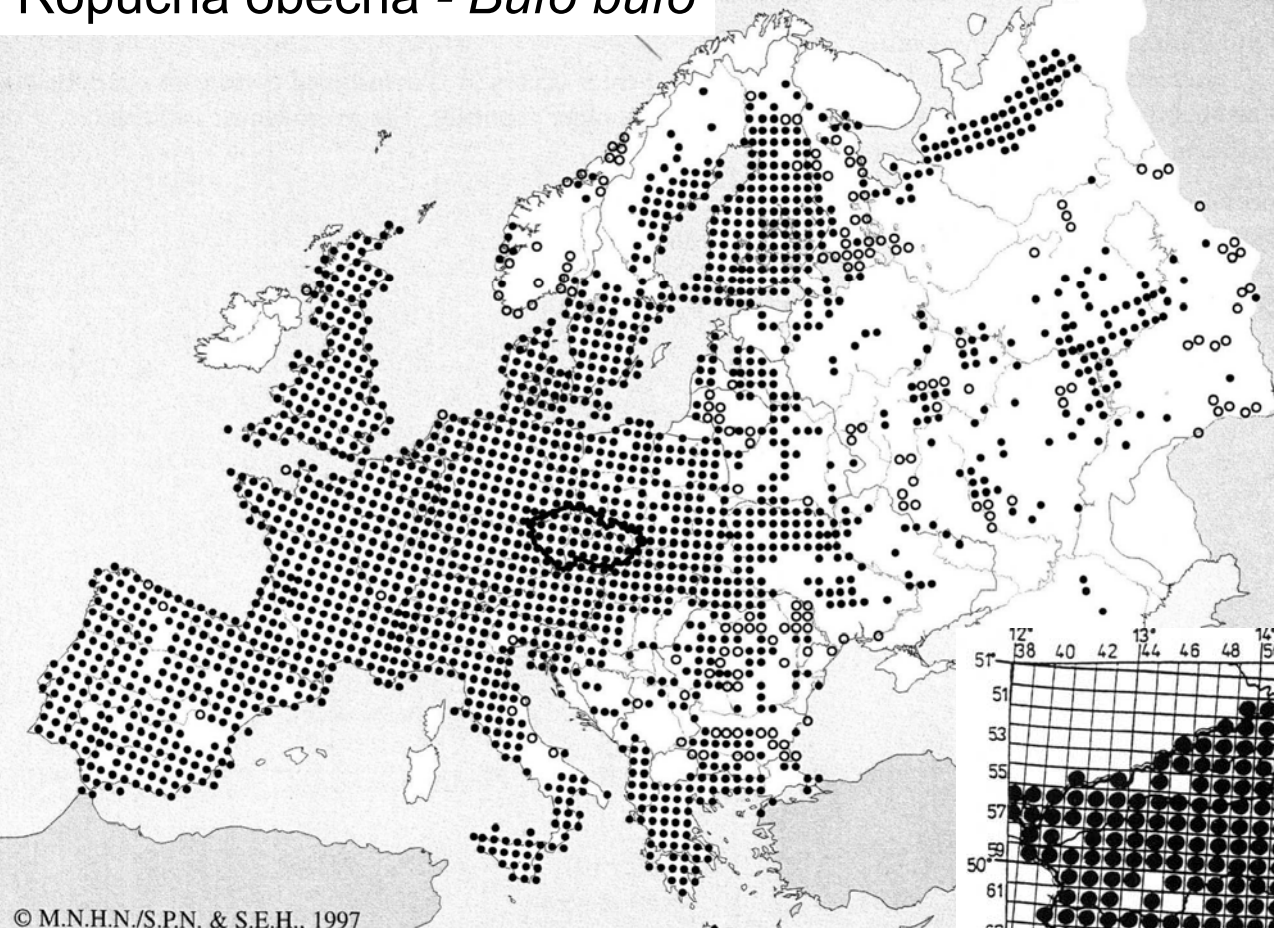

© M.N.H.N./S.P.N. & S.E.H., 1997

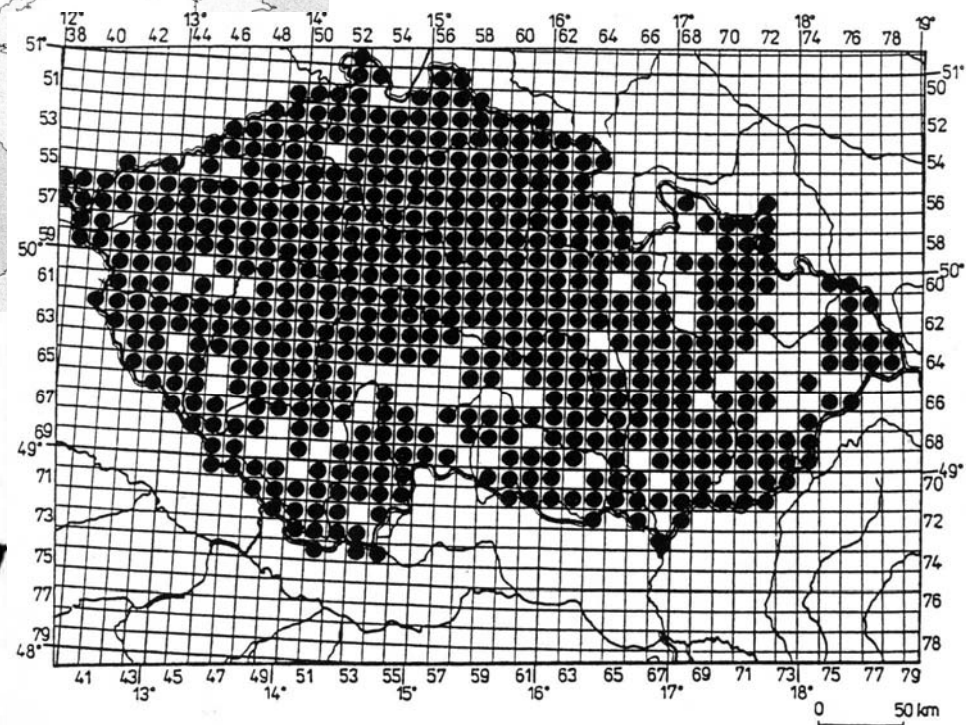

Obr. 12. Rozšíření *B. bufo* v ČR

Ropucha krátkonohá - *Epidalea calamita* (Laurenti, 1768)

EN,-, KO



Ropucha krátkonohá - *Epidalea calamita* (= *Bufo calamita*)

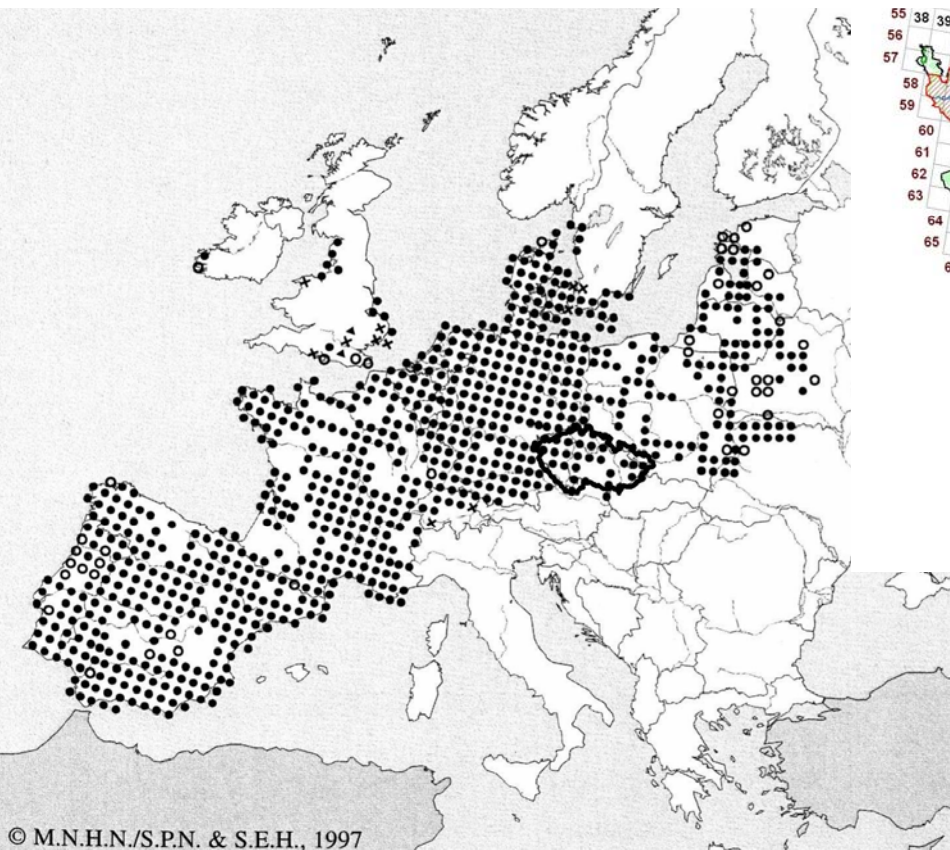

© M.N.H.N./S.P.N. & S.E.H., 1997

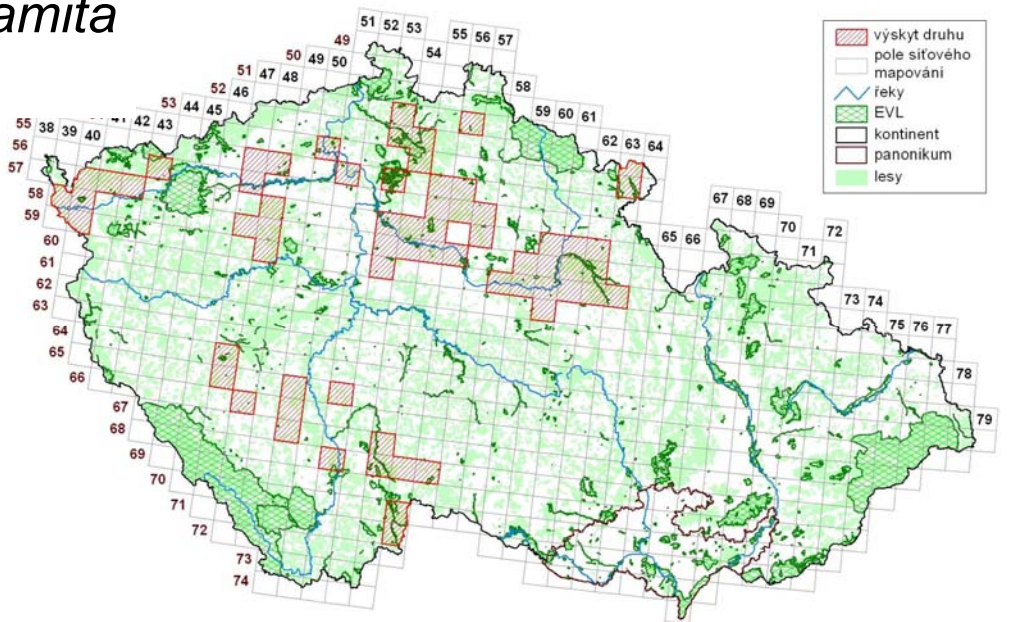

Zdroj dat: © AOPK ČR, 2007

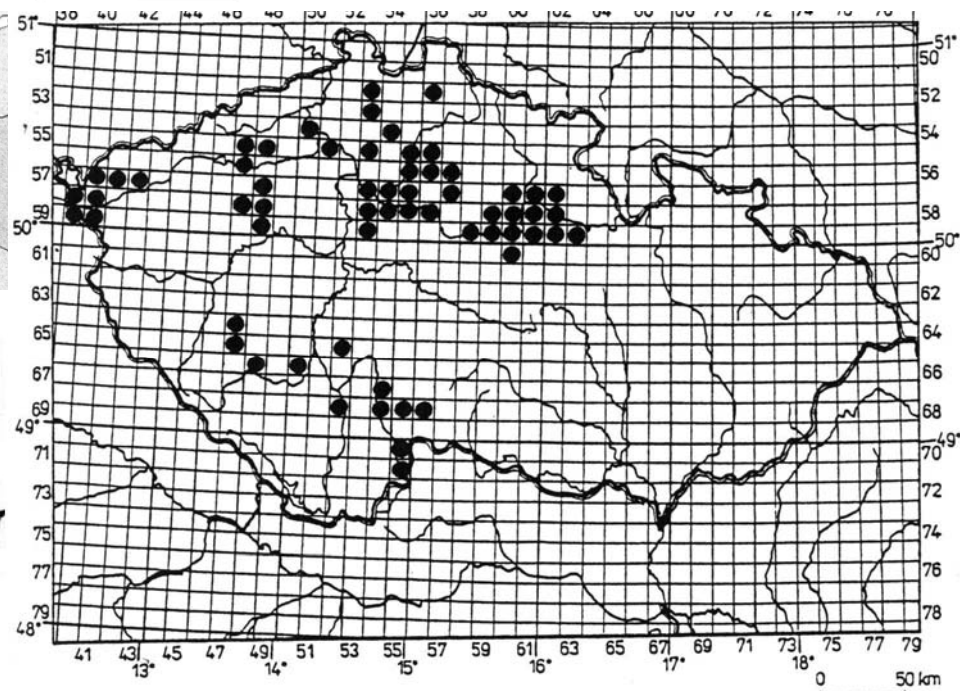

Obr. 13. Rozšíření *B. calamita* v ČR

Ropucha zelená - *Epidalea viridis* (Laurenti, 1768) (= *Bufo viridis*)



NT,-, SO



Ropucha zelená - *Epidalea viridis*

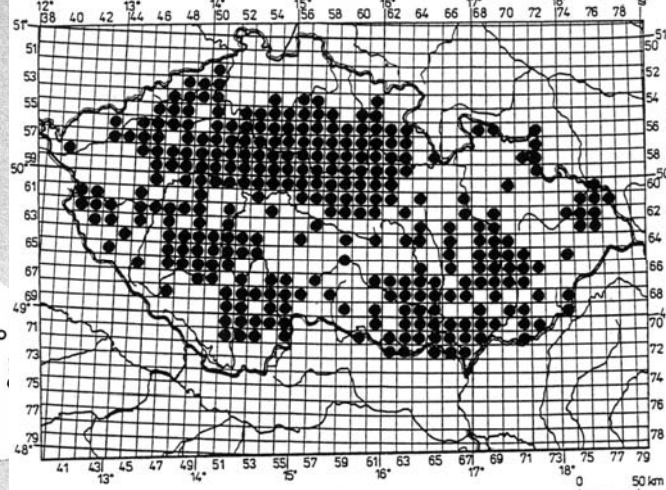
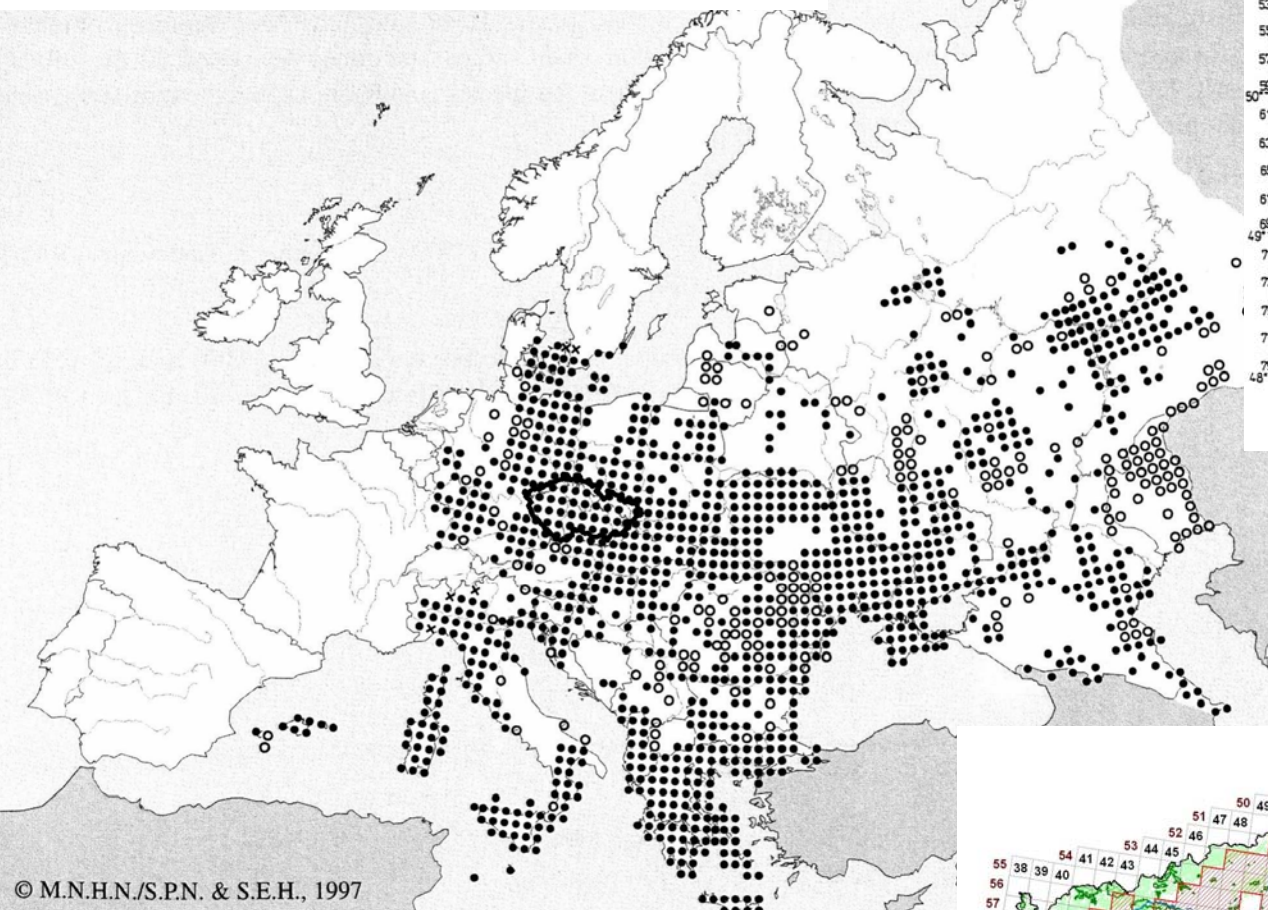

Obr. 14. Rozšíření *B. viridis* v ČR

© M.N.H.N./S.P.N. & S.E.H., 1997

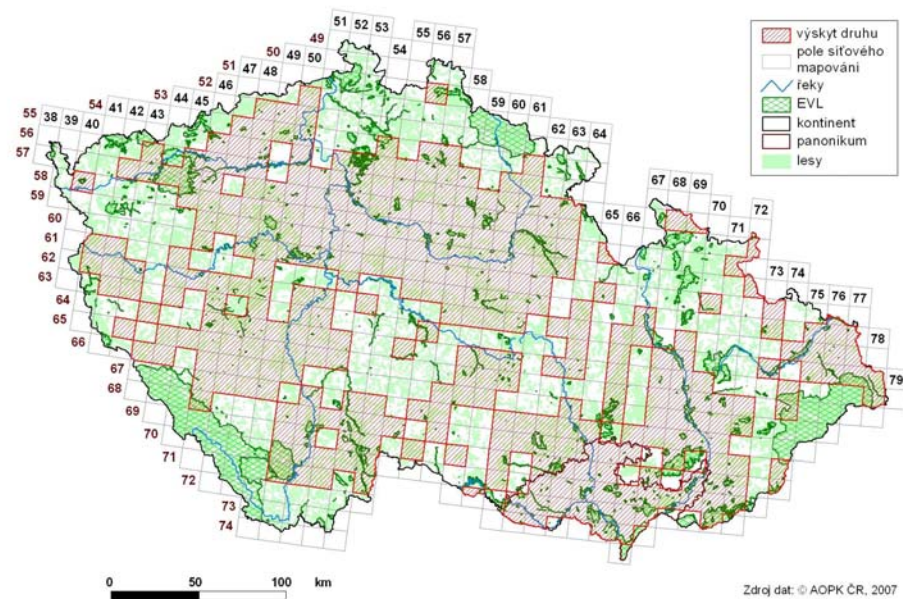

Zdroj dat: © AOPK ČR, 2007

Rosnička zelená - *Hyla arborea* (Linnaeus, 1758)

NT,LR/nt, SO



Rosnička zelená - *Hyla arborea*

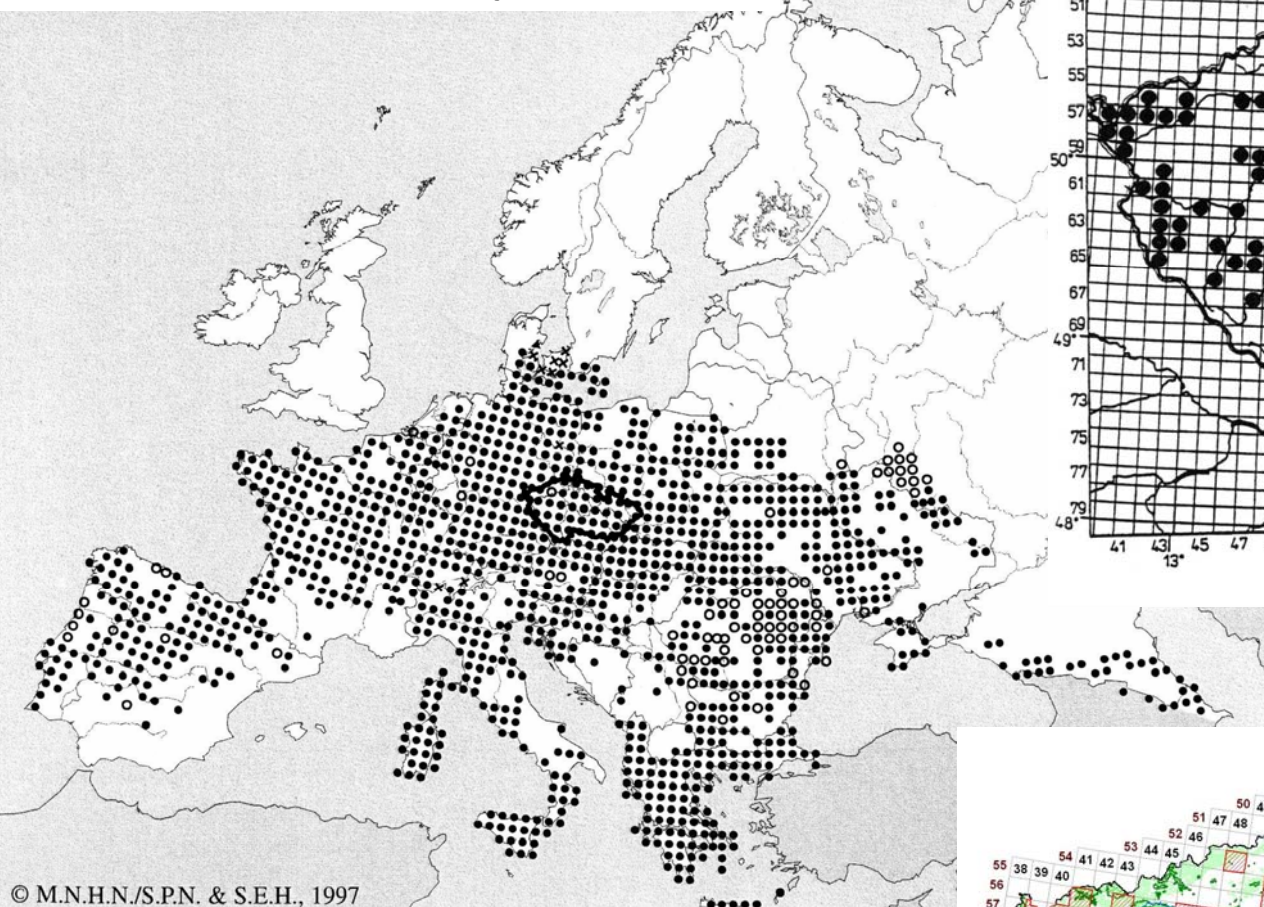

© M.N.H.N./S.P.N. & S.E.H., 1997

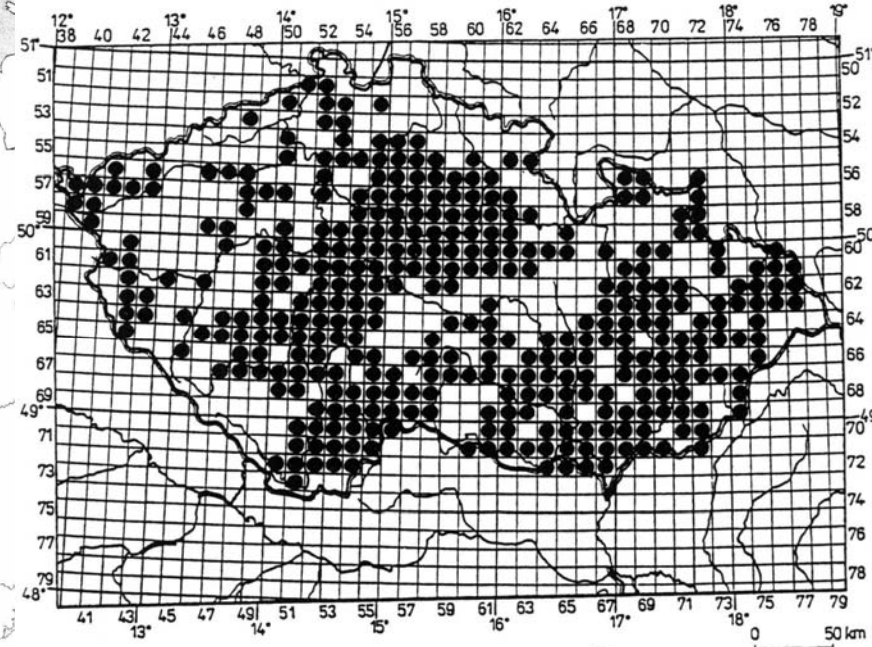

Obr. 15. Rozšíření *H. arborea* v ČR

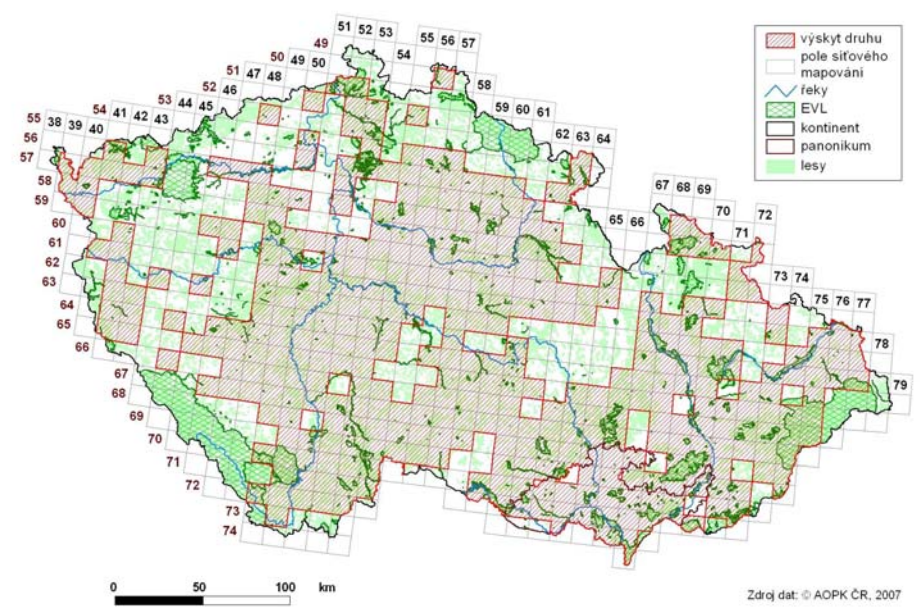

Zdroj dat: © AOPK ČR, 2007

Skokan ostronosý - *Rana arvalis* Nilsson, 1842

EN,-, KO



Skokan štíhlý - *Rana dalmatina* Fitzinger in Bonaparte, 1839

NT,-, SO

Skokan ostronosý - *Rana arvalis*

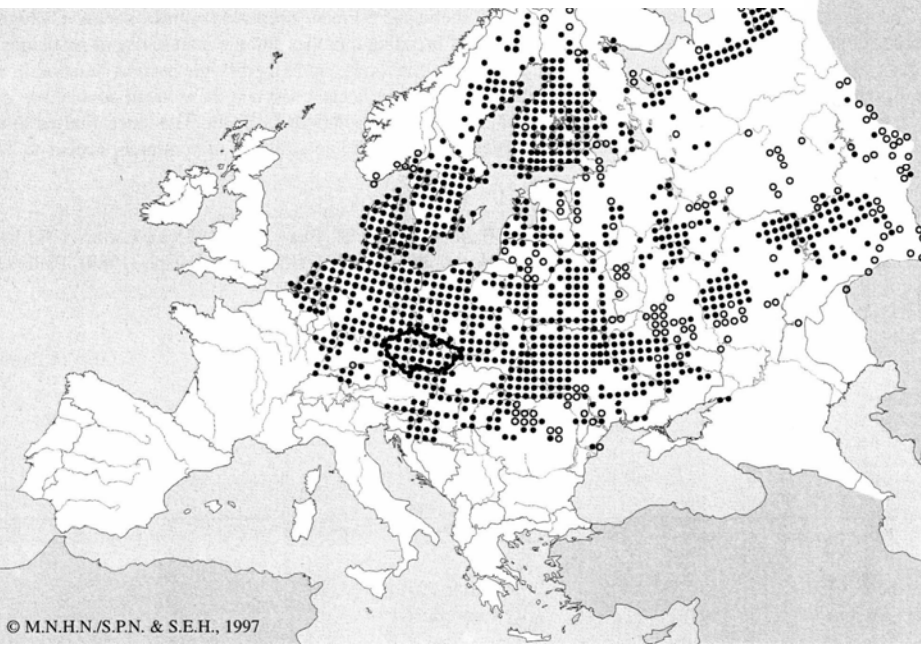

© M.N.H.N./S.P.N. & S.E.H., 1997

Skokan štíhlý - *Rana dalmatina*

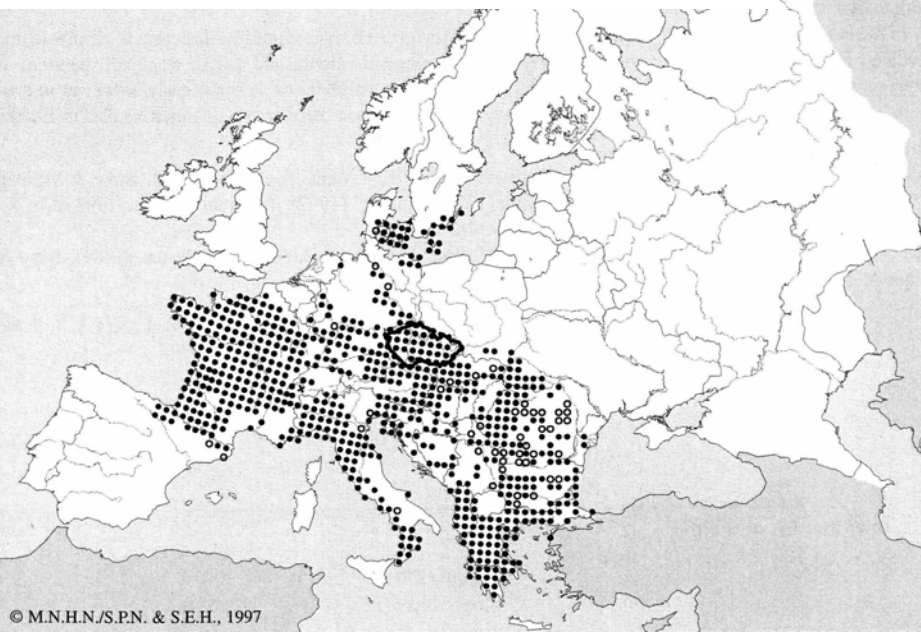

© M.N.H.N./S.P.N. & S.E.H., 1997

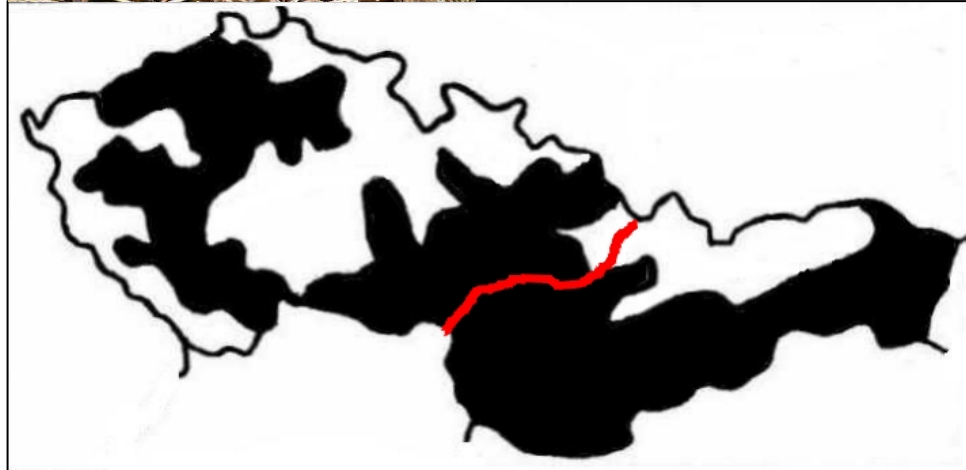

Skokan ostronosý - *Rana arvalis*

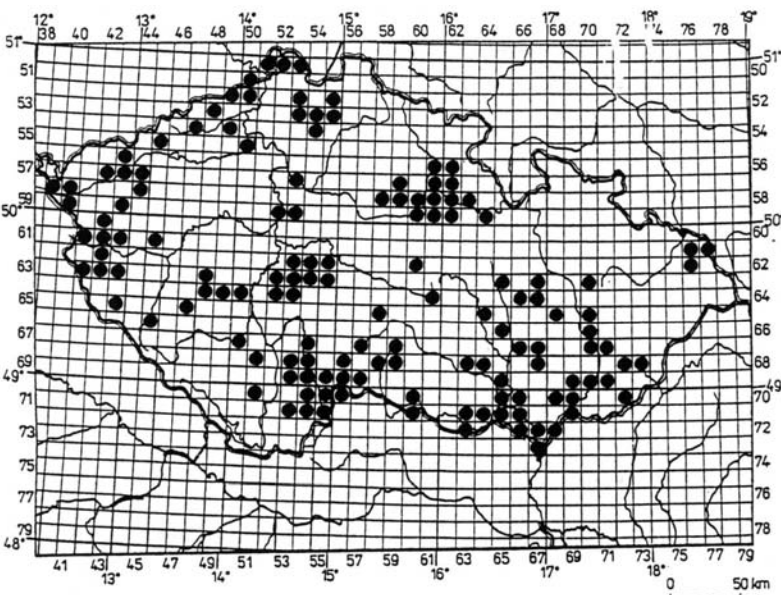

Obr. 16. Rozšíření *R. arvalis* v ČR

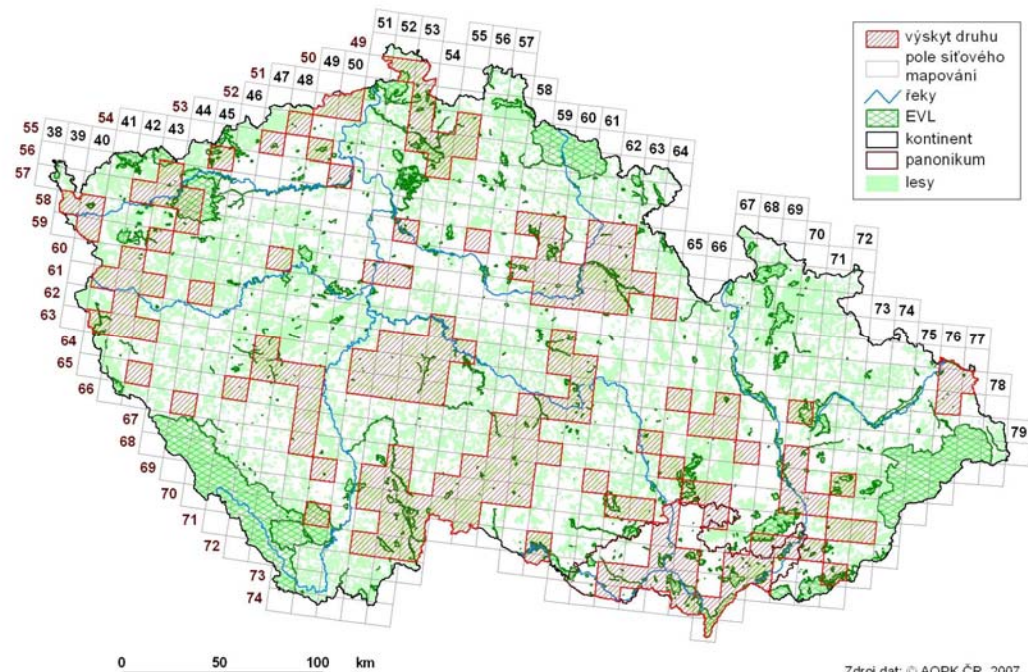

Skokan štíhlý - *Rana dalmatina*

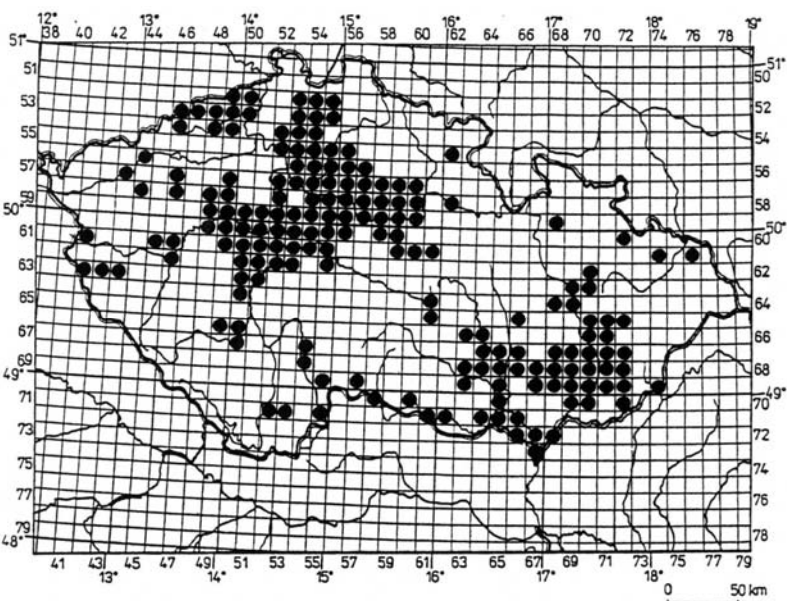

Obr. 17. Rozšíření *R. dalmatina* v ČR

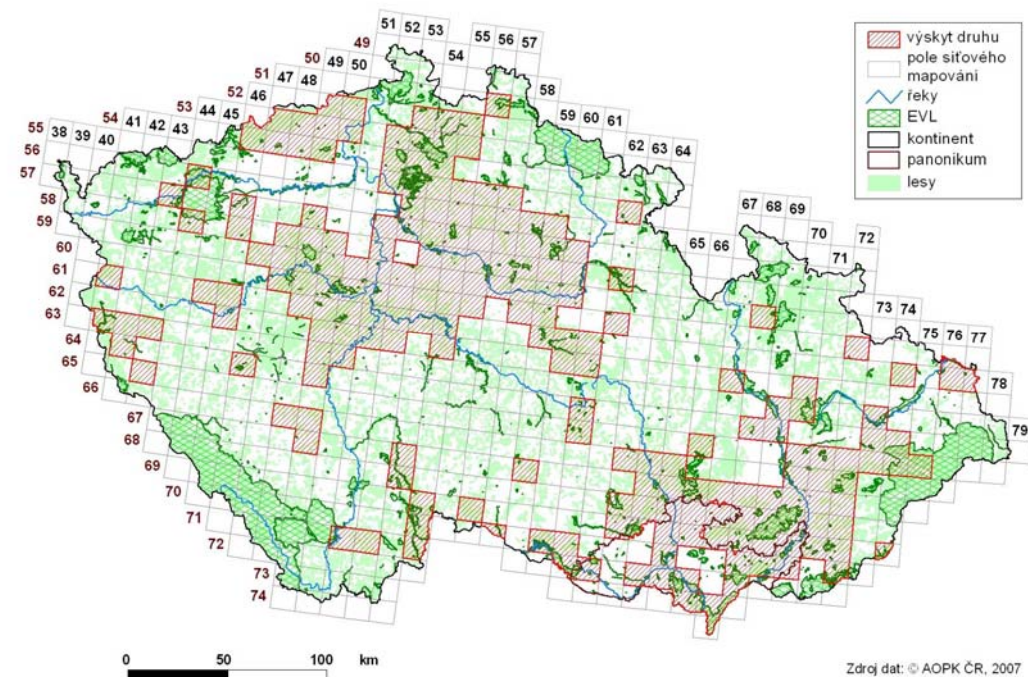



Skokan hnědý



Skokan hnědý - *Rana temporaria*

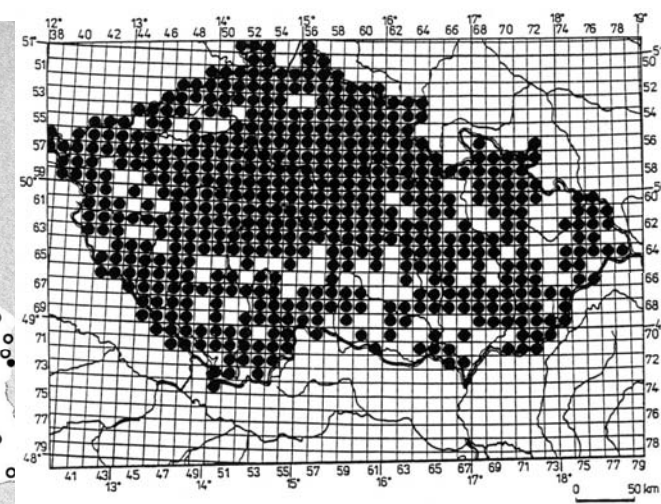
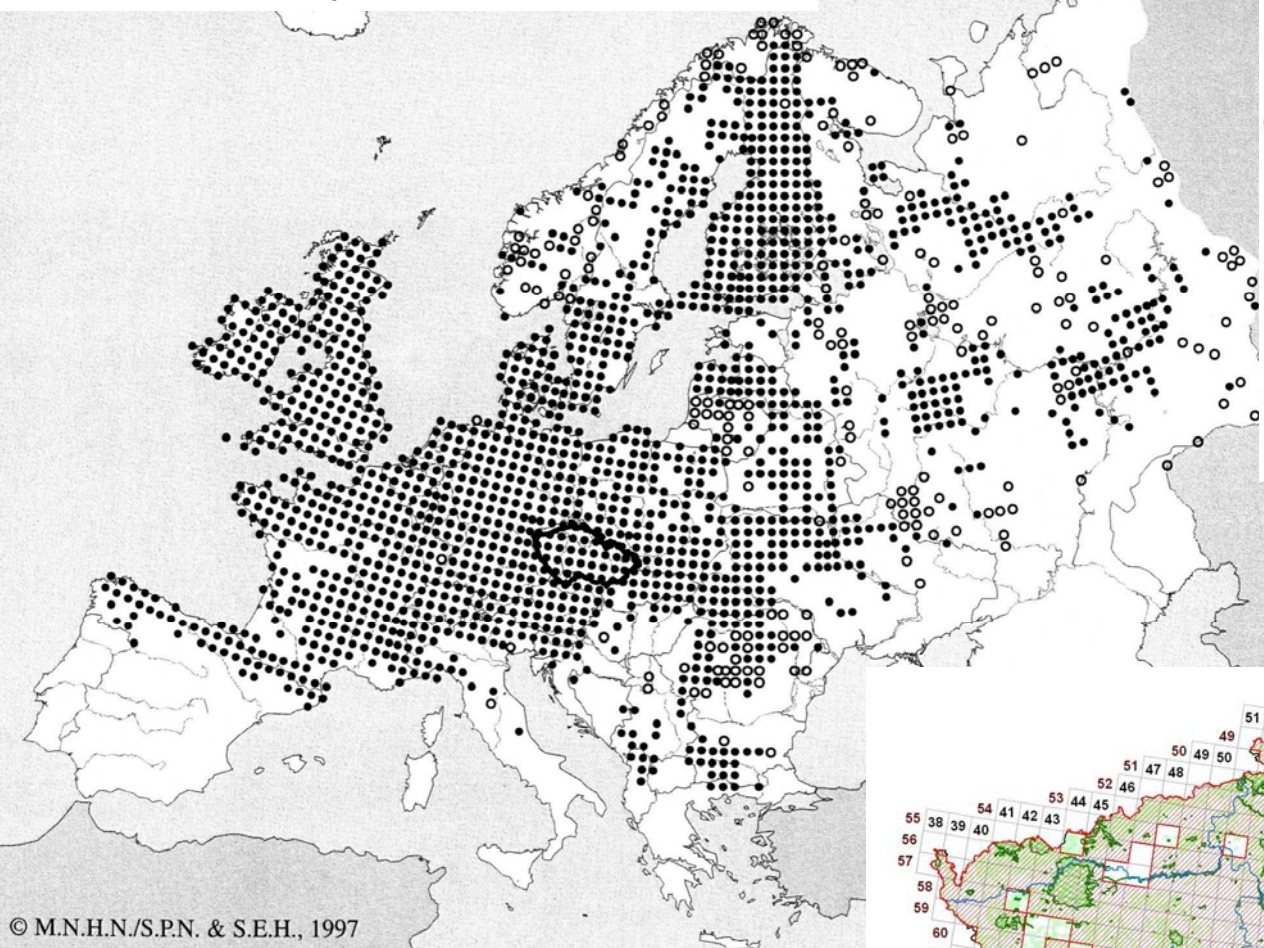

Obr. 18. Rozšíření *R. temporaria* v ČR

© M.N.H.N./S.P.N. & S.E.H., 1997

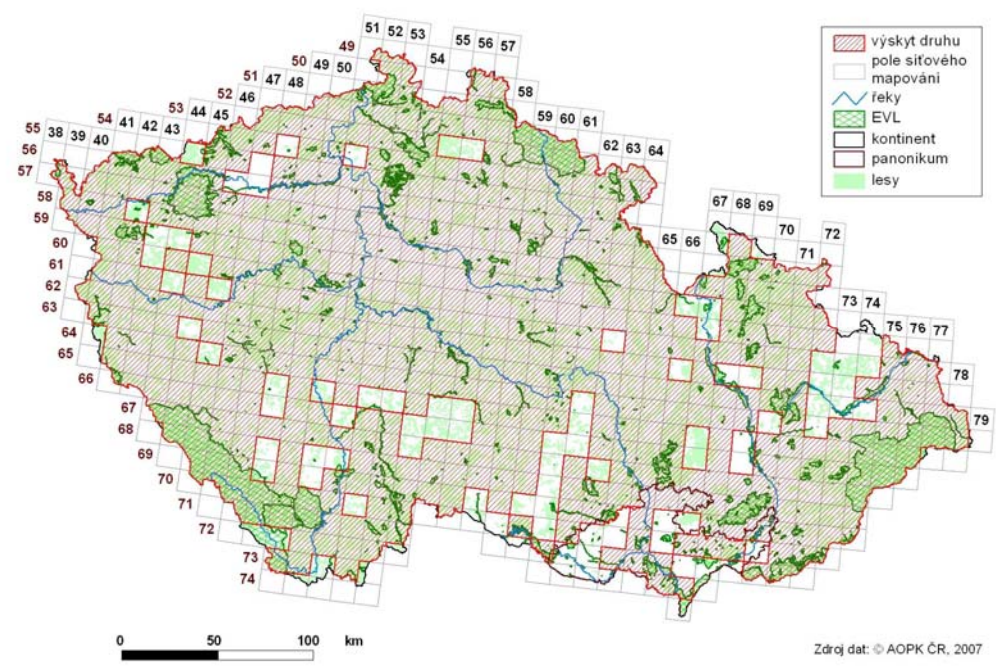

Zdroj dat: AOPK ČR, 2007

Vodní (zelení) skokani – *Pelophylax* spp.

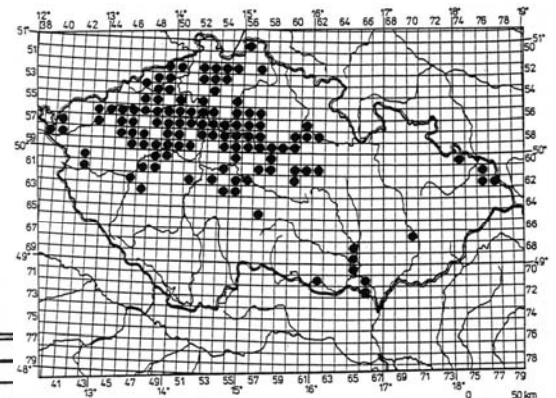
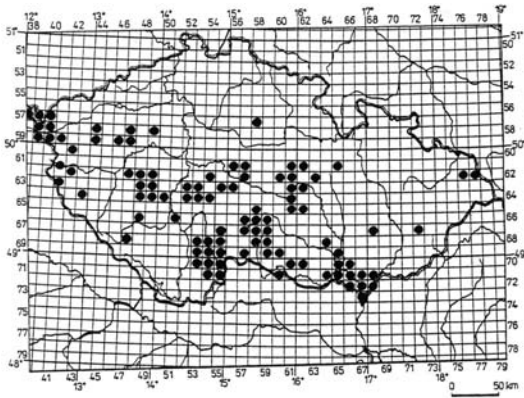

Obr. 20. Rozšíření *R. ridibunda* v ČR

P. lessonae

P. ridibundus

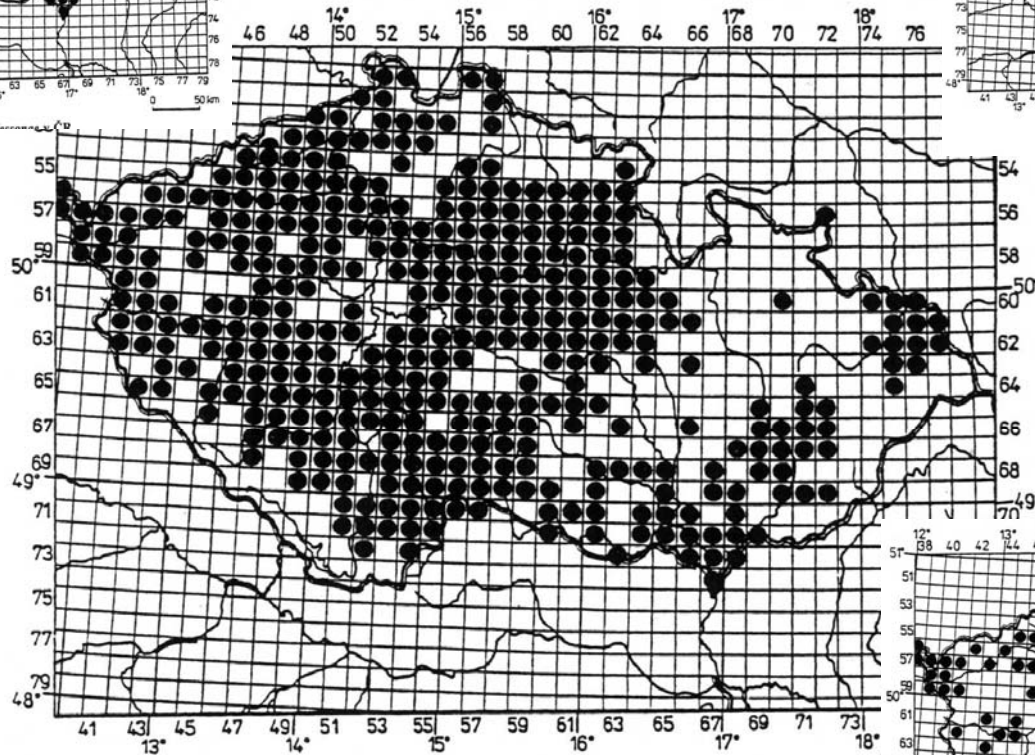

Obr. 23. Rozšíření *R. esculenta* synklepton v ČR

P. kl. esculentus

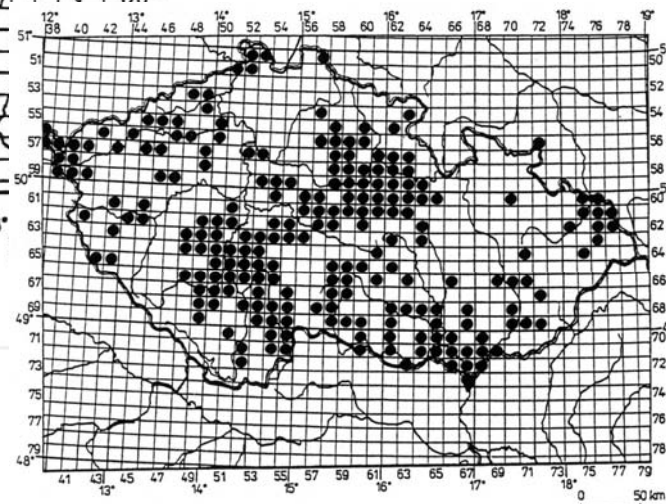

Obr. 22. Rozšíření *R. kl. esculenta* v ČR

Skokan menší (krátkonohý) - *Pelophylax lessonae* (Camerano, 1882) VU,-, SO
(= *Rana lessonae*)



Skokan menší (krátkonohý) - *Pelophylax lessonae*

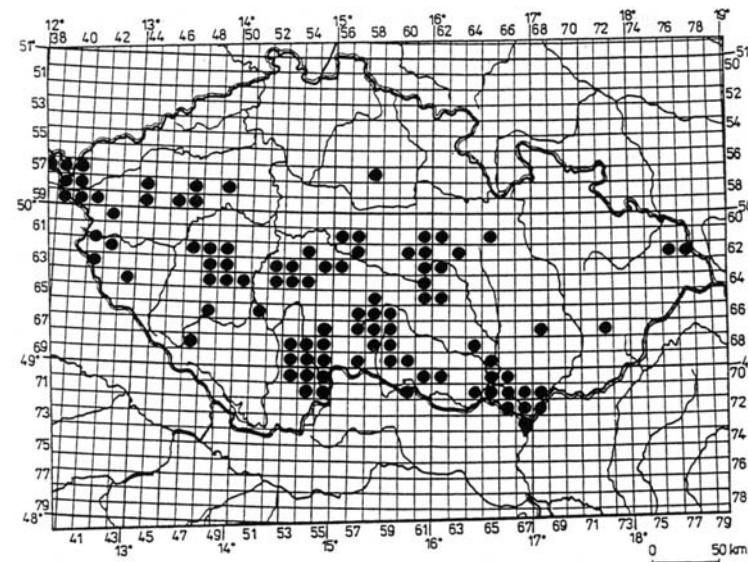
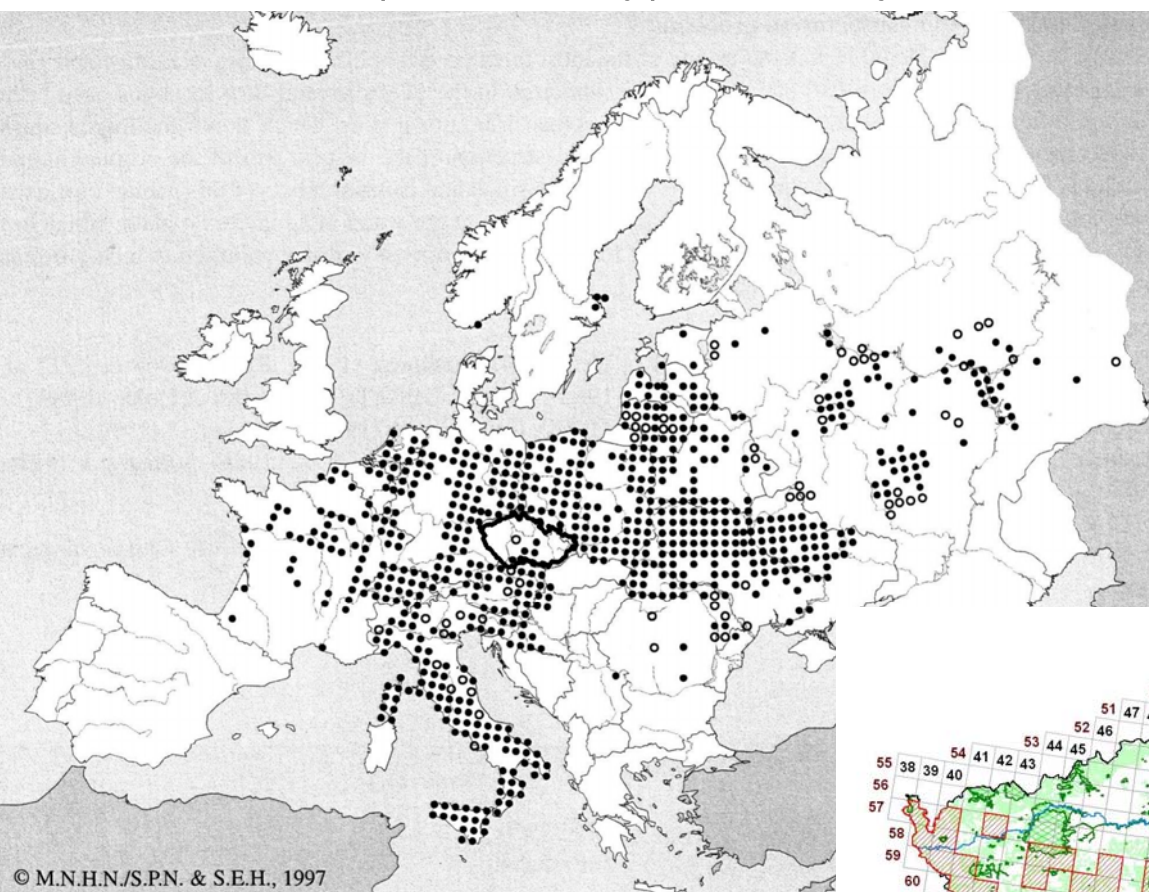

Mapa 10. Rozšíření *P. lessonae* v ČR

© M.N.H.N./S.P.N. & S.E.H., 1997

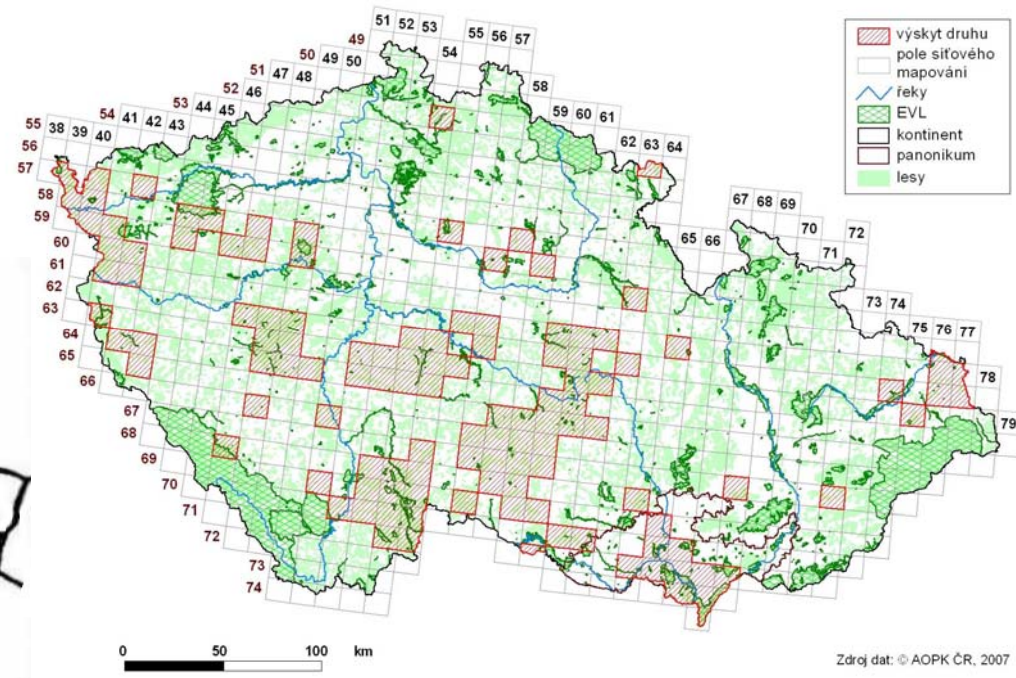

Zdroj dat: © AOPK ČR, 2007

Skokan skřehotavý - *Pelophylax ridibundus* (Pallas, 1771)
(= *Rana ridibunda*)

NT,-, KO



Skokan skřehotavý – *Pelophylax ridibundus*

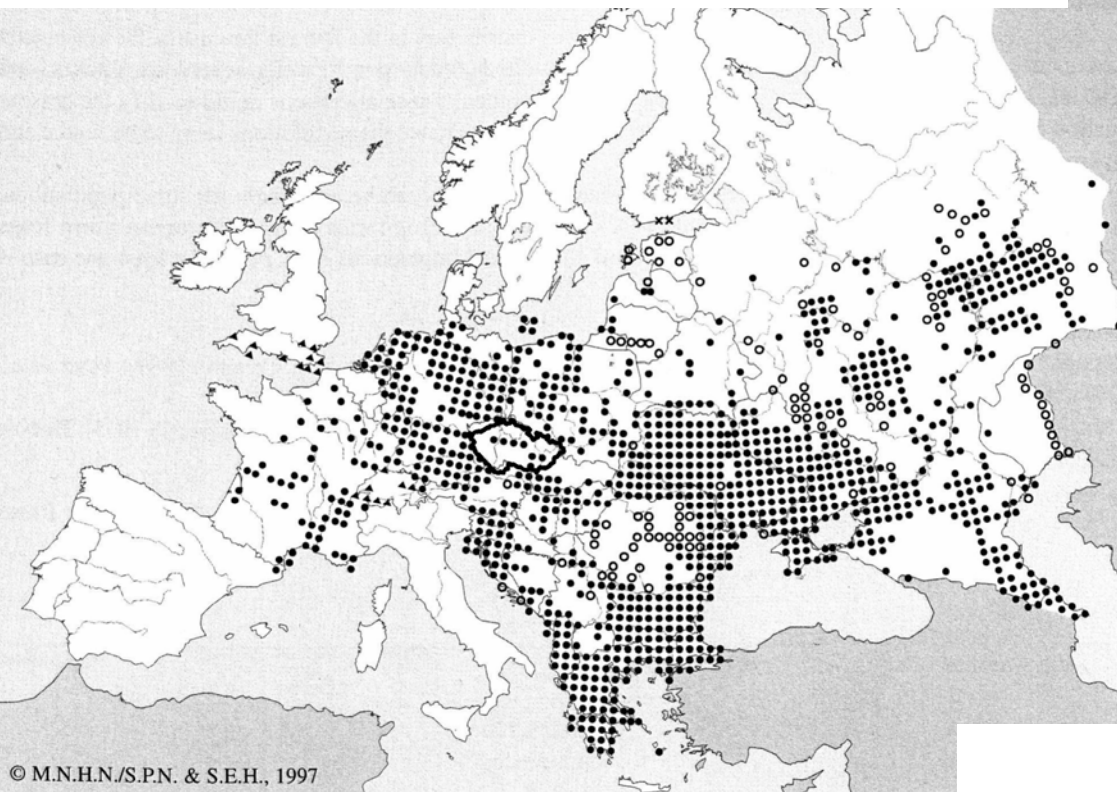

© M.N.H.N./S.P.N. & S.E.H., 1997

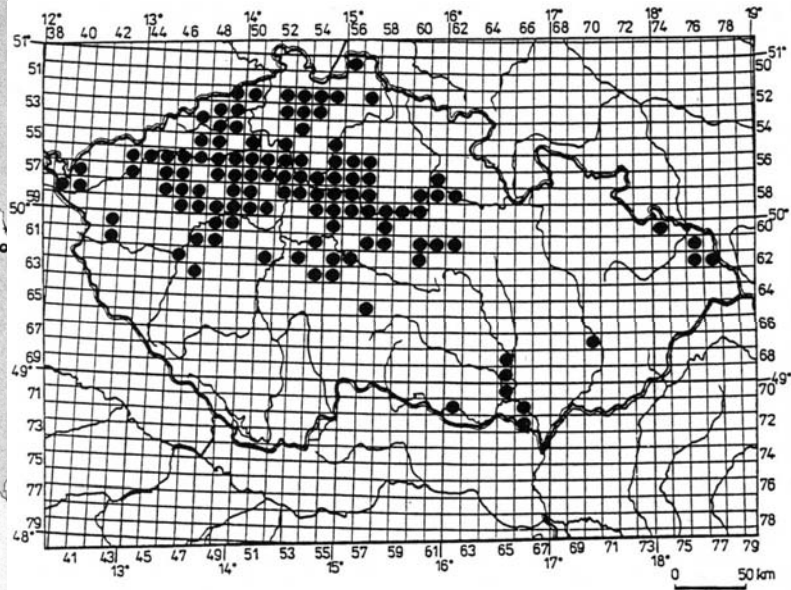

Obr. 20. Rozšíření *R. ridibunda* v ČR

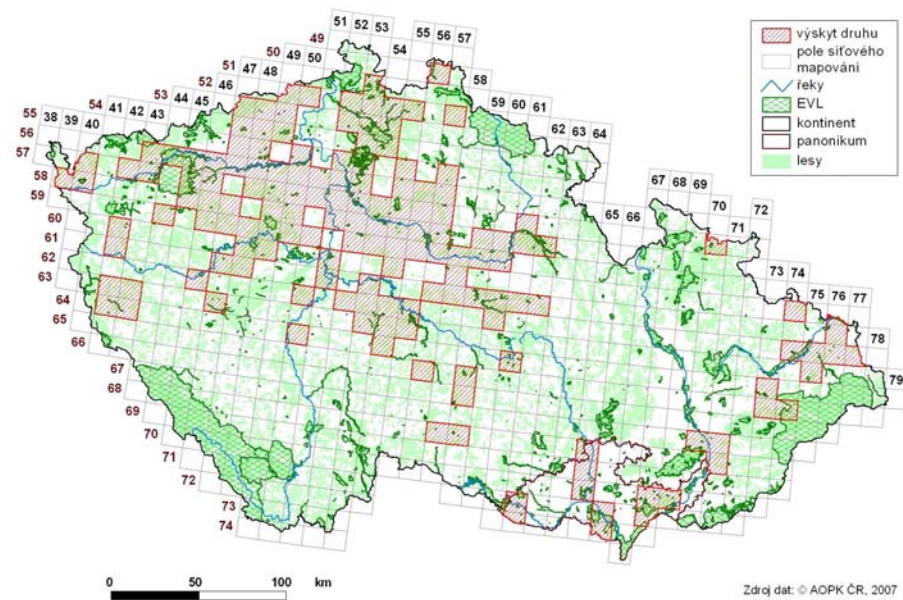
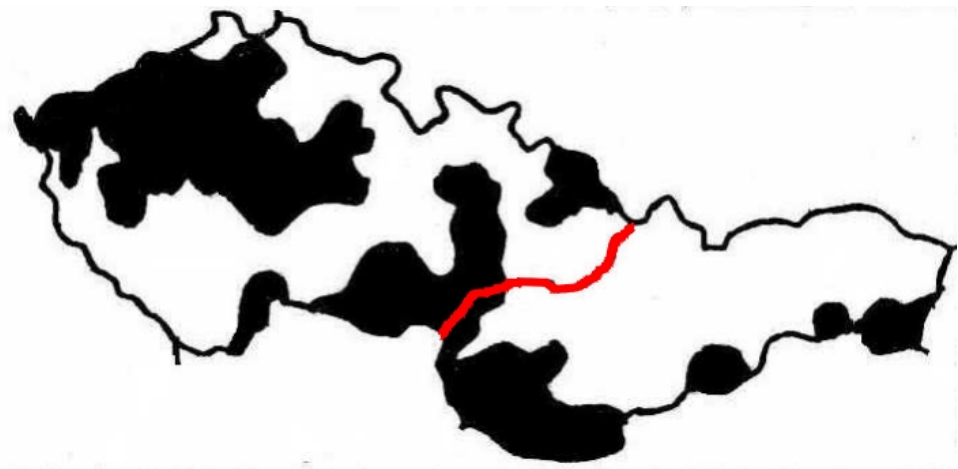

Zdroj dat: © AOPK ČR, 2007



hybridogenní
hybrid



Skokan zelený - *Pelophylax kl. esculentus*

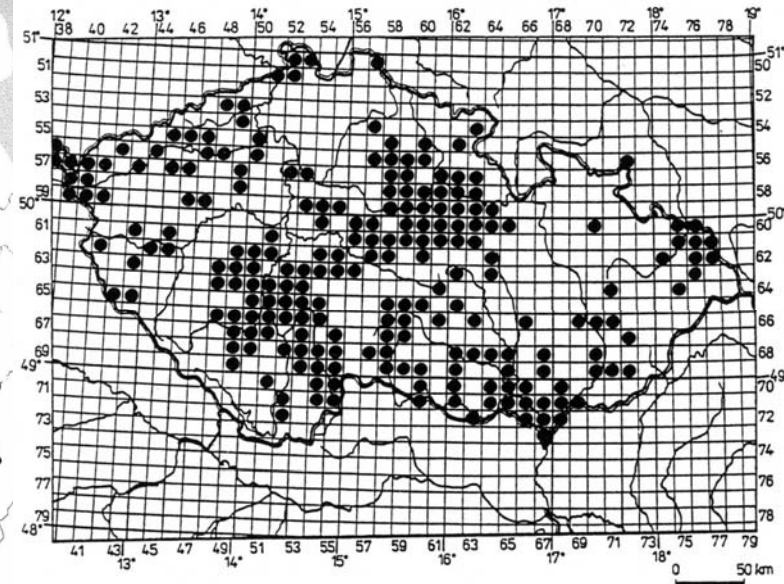
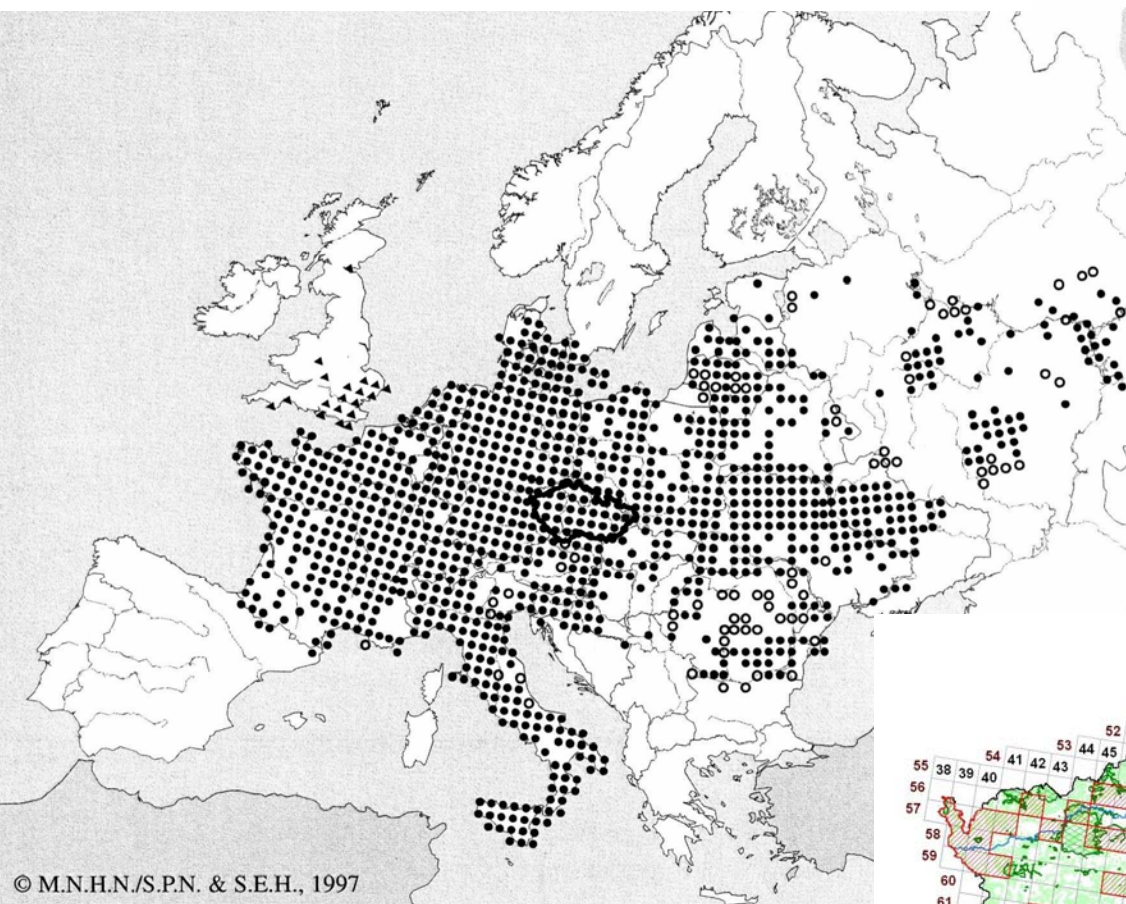

Obr. 22. Rozšíření *R. kl. esculenta* v ČR

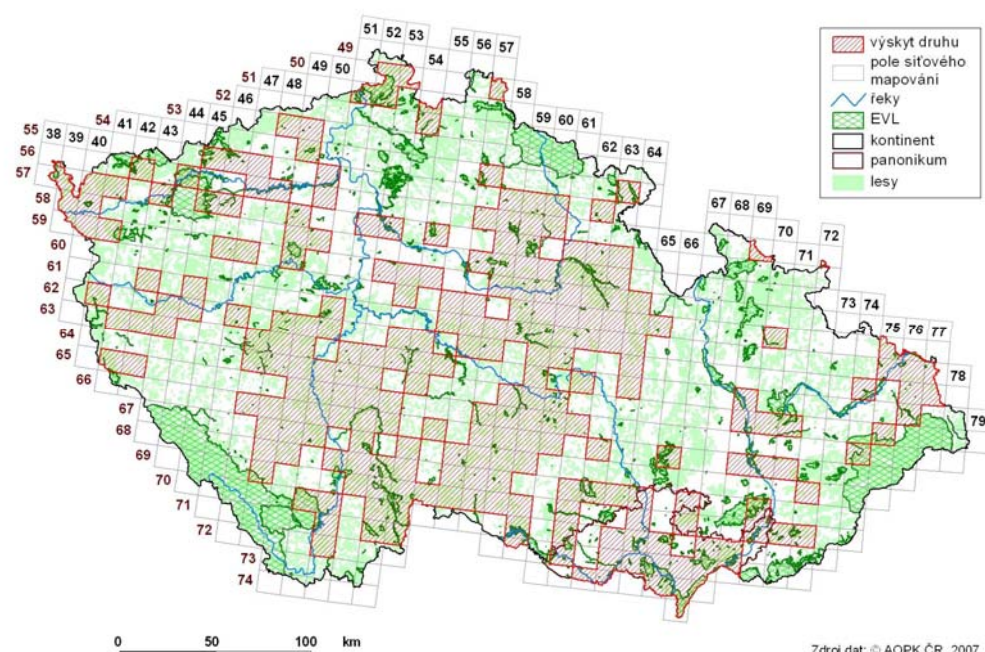
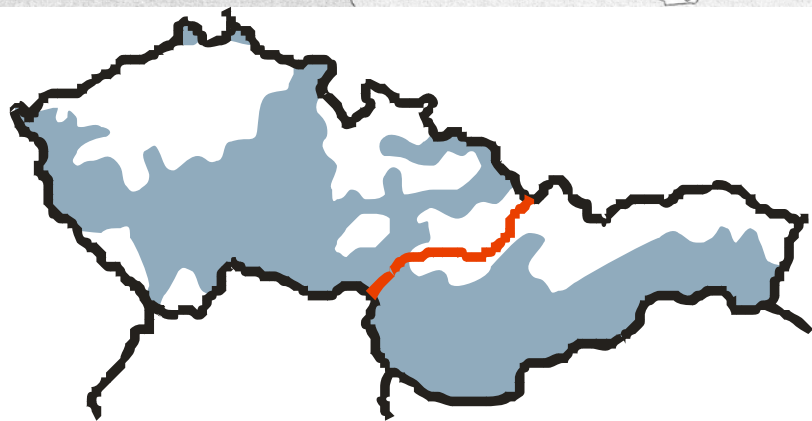

Výskyt, ohrožení a ochrana

ČR, SR - současný výskyt ve volných vodách		
ČS a IUCN	Plesník et al., 2004: Červený seznam obratlovců z území ČR, Příroda, Praha, 22; 2004 IUCN Red List of Threatened Species (www.redlist.org)	
EX	Extinct	Vyhynulý
EW	Extinct in the wild	Vyhynulý nebo vyhubený ve volné přírodě
RE	Regionally extinct	Regionálně vymizelý
CR	Critically endangered	Kriticky ohrožený
EN	Endangered	Ohrožený
VU	Vulnerable	Zranitelný
NT	Near threatened	Téměř ohrožený
LC	Least concern	Málo dotčený
DD	Data deficient	Nedostatečné údaje
NE	Not evaluated	Newhodnocený
Vyhláška č. 395/92, zákon č. 114/92, o ochraně přírody a krajiny		
KO	kriticky ohrožený	
SO	silně ohrožený	
O	ohrožený	
MD - mezinárodní úmluvy a dohody		
Bern	druh zařazený v přílohách (II, III) Úmluvy o ochraně evropské fauny a flóry	
Bonn	druh zařazený v přílohách (II) Úmluvy o ochraně stěhovavých druhů volně žijících živočichů	
ES - legislativa ES		
Habitats	druh zařazený v přílohách (II, IV, V) Směrnice č. 79/409/EC o ochraně přírodních stanovišť volně žijících živočichů a planě rostoucích rostlin	

Výskyt, ohrožení a ochrana

Druh		Species	ČR	SR	ČS	IUCN	vyhl. 395	vyhl. 175	MD	ES
mlok skvrnitý	salamandra škvřitá	<i>Salamandra salamandra</i>	+	+	VU	-	SO	SO	-	-
čolek velký	mlok hřebenatý	<i>Triturus cristatus</i>	+	+	CR, EN	LR	KO	SO	Bern II	Habitats II
čolek dunajský	mlok dunajský	<i>Triturus dobrogicus</i>	+	+	CR	DD	-	?	Bern II	Habitats II
čolek dravý	mlok dravý	<i>Triturus carnifex</i>	+	-	CR	-	-	KO	Bern II	Habitats II
čolek horský	mlok horský	<i>Mesotriton alpestris</i>	+	+	NT	-	SO	SO	-	-
čolek obecný	mlok bodkovaný	<i>Lissotriton vulgaris</i>	+	+	LC	-	SO	SO	Bern III	-
čolek karpatský	mlok karpatský	<i>Lissotriton montandoni</i>	+	+	CR/EN	-	KO	KO	Bern II	-
čolek hranatý	mlok hranatý	<i>Triturus helveticus</i>	+	-	CR	-	-	KO	Bern III	-
kuňka ohnivá (obecná)	kunka červenobruchá	<i>Bombina bombina</i>	+	+	EN	-	O	SO	Bern II	-
kuňka žlutobřichá	kunka žltobruchá	<i>Bombina variegata</i>	+	+	CR/VU	-	O	SO	Bern II	Habitats II
blatnice skvrnitá	hrabavka škvřitá	<i>Pelobates fuscus</i>	+	+	NT	-	KO	SO	Bern II	Habitats II
ropucha obecná	ropucha bradavičnatá	<i>Bufo bufo</i>	+	+	LC	-	SO	O	Bern III	-
ropucha zelená	ropucha zelená	<i>Epidalea viridis</i>	+	+	NT	-	O	SO	Bern II	Habitats IV
ropucha krátkonohá	ropucha krátkonohá	<i>Epidalea calamita</i>	+	-	EN	-	KO	KO	Bern II	Habitats IV
rosnička zelená	rosnička zelená	<i>Hyla arborea</i>	+	+	NT	LR	SO	SO	Bern II	Habitats IV
skokan hnědý	skokan hnědý	<i>Rana temporaria</i>	+	+	LC	-	-	-	Bern III	-
skokan ostronosý	skokan ostropyský	<i>Rana arvalis</i>	+	+	EN	-	SO	KO	-	Habitats IV
skokan štíhlý	skokan štíhly	<i>Rana dalmatina</i>	+	+	NT	-	SO	SO	Bern II	Habitats IV
skokan skřehotavý	skokan rapotavý	<i>Pelophylax ridibundus</i>	+	+	NT	-	KO	KO	-	-
skokan menší (krátkonohý)	skokan krátkonohý	<i>Pelophylax lessonae</i>	+	+	VU	-	KO	SO	-	Habitats IV
skokan zelený	skokan zelený	<i>Pelophylax</i> kl. <i>Esculentus</i>	+	+	NT	-	SO	SO	-	-

Literatura:

- Arnold E.N., Burton J.A., 1978:** *Pareys Reptilien und Amphibienführer Europas*. Paul Parey, Hamburg und Berlin, 270 pp.
- Baruš V., Oliva O. (eds) et al., 1992:** *Obojživelníci (Amphibia)*. Fauna ČSFR, Academia, Praha, 338 pp.
- Baruš V., Oliva O. (eds) et al., 1992:** *Plazi (Reptilia)*. Fauna ČSFR, Academia, Praha, 222 pp.
- Duellman W.E, Trueb L., 1986:** *Biology of amphibians*. McGraw-Hill, New York.
- Dungel J. & Řehák Z., 2005:** *Atlas ryb, obojživelníků a plazů České a Slovenské republiky*. Academia, Praha, 181 pp.
- Engelmann W.-E. et al., 1985:** *Lurche und Kriechtiere Europas*. Neumann Verlag, Leipzig, Radebeul, 420 pp.
- Frost D.R. (ed), 2007:** *Amphibian species of the world (research.amph.org/herpetology/amphibia/index.html)*.
- Gasc J. et al., 1997:** *Atlas of Amphibians and Reptiles in Europe*. Museum National d'Historie Naturelle, Societas Europea Herpetologica, Paris, 494 pp.
- Gruber U.:** *Obojživelníci a plazi. Všechny evropské druhy*. NS Svoboda, 96 str.
- IUCN 2004:** *2004 IUCN Red List of Threatened Species (www.redlist.org, 5 July 2005)*.
- Mikátová B., Vlašín M., Zavadil V. (eds), 2001:** *Atlas rozšíření plazů v České republice*. AOPK Brno – Praha, 257 pp.
- Moravec J., 1994:** *Atlas rozšíření obojživelníků v České republice*. Národní muzeum, Praha, 148 pp.
- Moravec J., 1999:** *Svět zvířat VII. Obojživelníci a plazi*. Albatros, Praha, 183 pp.
- Nečas P., Modrý D., Zavadil V., 1997:** *Czech Recent and Fossil Amphibians and Reptiles. An Atlas and Field Guide*. Chimaira, Frankfurt am Main, 94 pp. and CD.
- Pough F. H. et al., 2001:** *Herpetology*. 2nd edition. Prentice Hall, Upper Saddle River.
- Uetz P. et al., 2007:** The European Molecular Biology laboratory Reptile Database (www.embl-heidelberg.de/~uetz/livingReptiles.html)
- Vlašín M., 2007:** *Klíč k určování obojživelníků a plazů*. Rezekvítek, Brno, 40 str.
- Zavadil V., Moravec J., 2004:** Červený seznam obojživelníků (Amphibia) a plazů (Reptilia) z území České republiky. *Příroda* 22.
- Zug G.R., 1993:** *Herpetology*. Academic Press, San Diego.
- Zwach I., 1990:** *Naši obojživelníci a plazi ve fotografii*. SZN, Praha, 144 pp.
- Zwach I., 2009:** *Obojživelníci a plazi České republiky*. Grada Publishing, Praha, 493 str.