

# PTÁCI

2.část

# Řád: PĚVCI (*Passeriformes*)

- více jak polovina ptačích druhů (skoro 6000 druhů v asi 100 čeledích), rozmanitá skupina
- většinou menší ptáci, zpěvné svaly v syrinxu (zpívají samci - stř. Evropa)
- anisodaktylní noha (3+1 prsty bez blan, stejně vysoko a stejně dlouhé)
- samci většinou větší a pestřejší
- staví hnízdo, nidikolní ml., většinou se starají oba rodiče, rozmanitá potrava
- u nás zjištěno 150 druhů (97 hnízdí)



Členění do 2 skupin:  
Suboscines (Tyranni)  
Oscines (Passeri)

-původ v Gondwaně?  
(Acanthisittidae)

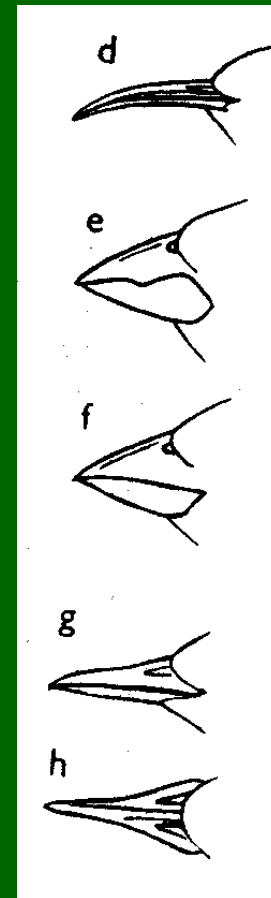
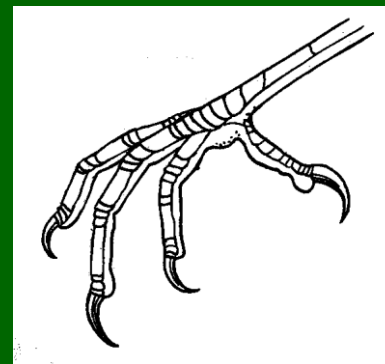
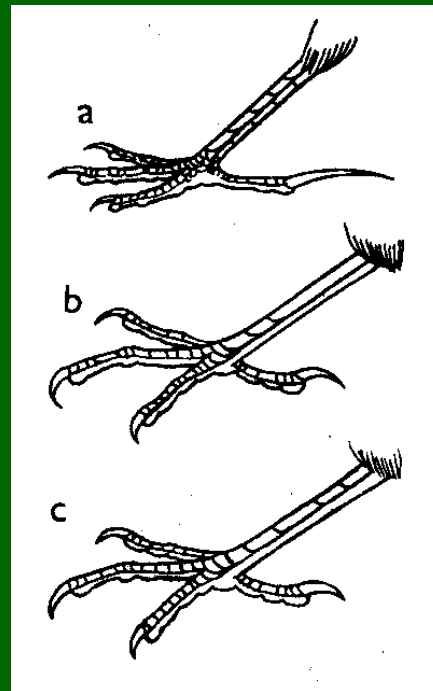

## Oscines - zpěvní (859/4530)

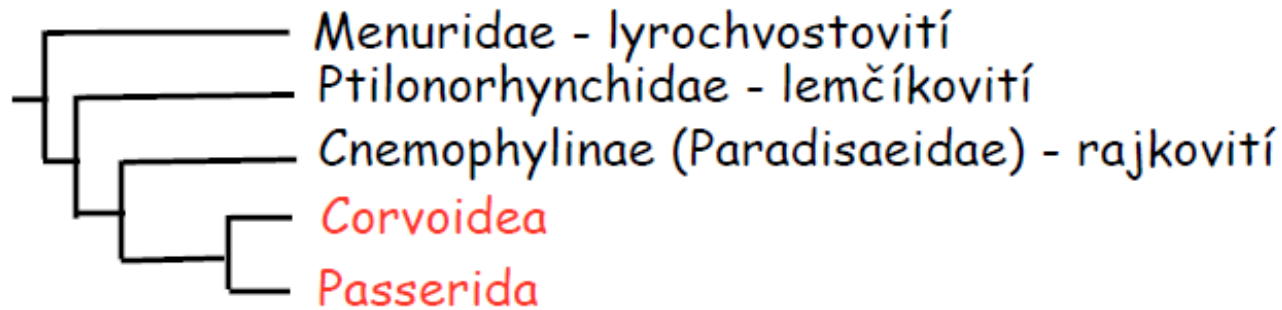

### Corvoidea - převážně Nový svět

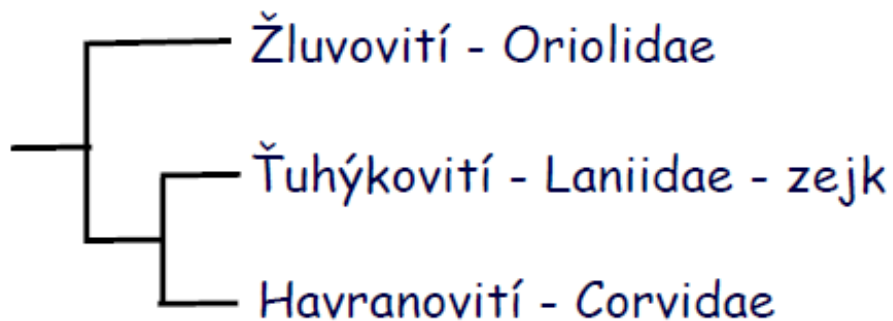

### Passerida - Starý svět

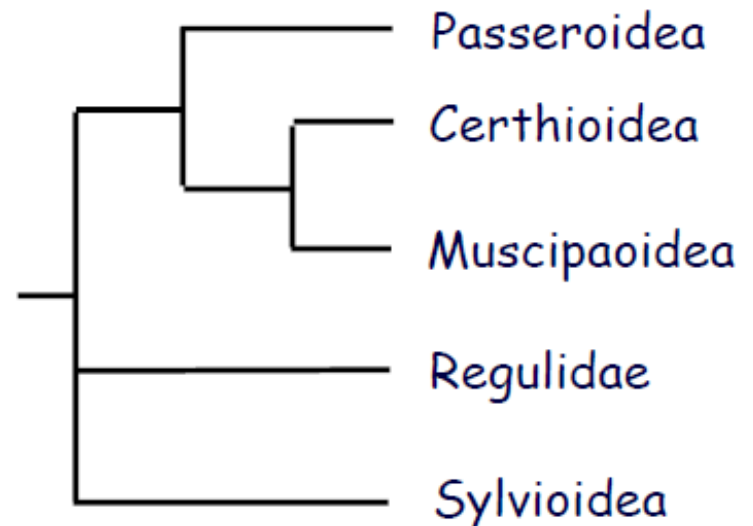

## Passerida

### a) Sylvioidea:

Sýkorovití - Paridae

Moudivláčkovití - Remizidae

Skřivanovití - Alaudidae

*Panurus* - sýkořice

Mlynaříkovití - Aegithalidae

Sýkořicovití - Timaliidae

„Pěnicovití“ - Sylviidae

Vlaštovkovití - Hirundinidae

### b) Králíčkovití - Regulidae

### c) Muscicapoidea:

Brkoslavovití - Bombycillidae?

Skorcovití - Cinclidae

Drozdovití - Turdidae

Lejskovití - Muscicapidae

Špačkovití - Sturnidae

### d) Certhioidea

Brhlíkovití - Sittidae

Zedníčkovití - Tichodromatidae

Šoupáلكovití - Certhiidae

Střízlíkovití - Troglodytidae

### e) Passeroidea:

Vrabcovití - Passeridae

Konipasovití - Motacillidae

Pěvuškovití - Prunellidae

Pěnkavovití - Fringillidae

Strnadovití - Emberizidae



# Č: Žluvovití – *Oriolidae*

- středně velcí, stromoví
- silný zobák, pestré zbarvení
- samci větší a pestřejší
- potravou hlavně hmyz
- hluboké hnízdo z trávy vysoko na stromech (u nás 1 druh)



Žluva hajní (*Oriolus oriolus*)



# Č: Ťuhýkovití – Laniidae

- statní masožraví ptáci, velká hlava, ostrý zobák se zejkem, vibrisy
- silné ostré drápy, delší ocas, pestré zbarvení
- někdy pohl. dimorfismus, hnízdo v keřích či na stromech
- potravou bezobratlí i drobní obratlovci (zásobárny)
- u nás 4 druhy (2 hnízdí)



Ťuhýk obecný (*Lanius collurio*)



# Ťuhák šedý (*Lanius excubitor*)





# Řuhák menší (*Lanius minor*)



© - lubomir hlasek  
www.hlasek.com  
Lanius minor 8548



# Řuhák rudohlavý (*Lanius senator*)



# Č: Krkavcovití – Corvidae

- středně velcí až velcí ptáci (největší pěvci), silný zobák
- často tmavé zbarvení, hnízda vysoko na stromech, často stálé páry
- všežravci i mrchožrouti, vospělé chování, u nás 9 druhů (8 hnízdí)



Krkavec velký (*Corvus corax*)



# Vrána černá (*Corvus corone*)



# Vrána šedivka (*Corvus cornix*)





# Havran polní (*Corvus frugilegus*)





# Kavka obecná (*Corvus monedula*)



# Sojka obecná (*Garrulus glandarius*)





# Straka obecná (*Pica pica*)





# Ořešník kropenatý (*Nucifraga caryocatactes*)

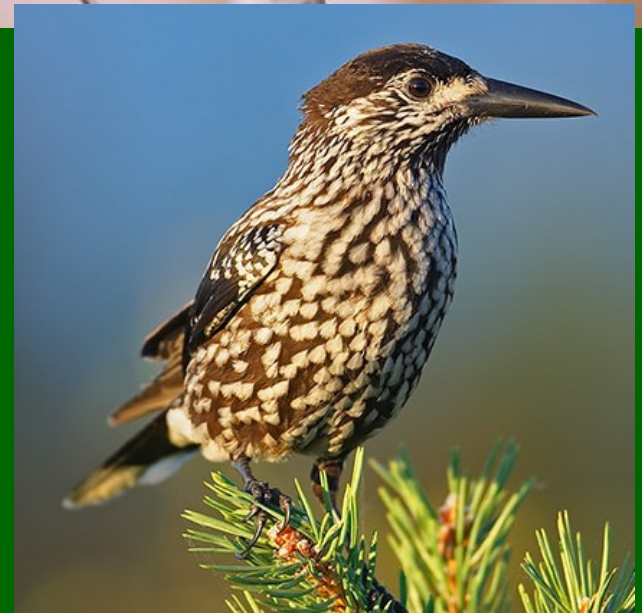

# Č: Brkoslavovití – *Bombycillidae*

- středně velcí pěvci, měkké pestré opeření, krátký zobák, chocholka
- pospolití, plodožraví specialisté, u nás zimní hosté (1 druh – invaze)



Brkoslav severní  
(*Bombycilla garrulus*)



# Č: Skorcovití – Cinclidae

- zavalití pěvci, vázaní na vodu, silná chodidla s drápy, husté prachové peří, krátká špičatá křídla
- rychle tekoucí úseky toků, potravou hl. vodní bezobratlí – lov pod vodou
- kupolovitá hnízda ve výklencích břehů a pod.
- u nás 1 hnízdící druh



Skorec vodní  
(*Cinclus cinclus*)

# Č: Lejskovití – *Muscicapidae*

- malí stromoví ptáci s velkou hlavou a očima
- zploštělý zobák s vibrisy, lov hmyzu v letu – „Fly – catching“
- hnízdí v dutinách či polodutinách stromů
- u nás 4 hnízdící druhy (nověji sem někdy řazeni i Saxicolinae: bělořiti, slavíci, bramborníčci a rehci)



Lejsek šedý (*Muscicapa striata*)



# Lejsek bělokrký (*Ficedula albicollis*)





# Lejsek černohlavý (*Ficedula hypoleuca*)





# Lejsek malý (*Ficedula parva*)



Lejsek  
m  
4255

# Č: Drozdovití – *Turdidae*

- malí až středně velcí stromoví ptáci, štíhlý špičatý zobák, vibrisy
- dlouhé nohy s botkou (splynutí štítků na přední straně běháků)
- výrazný zpěv, samci někdy pestřejší
- hnízdí v keřích či stromech, potravu sbírají hlavně na zemi (bezobratlí, plody)
- u nás 22 druhů (15 hnízdí)

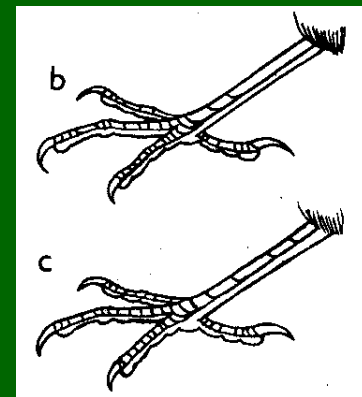

Červenka obecná  
(*Erithacus rubecula*)



# Slavík obecný (*Luscinia megarhynchos*)



# Slavík tmavý (*Luscinia luscinia*)





# Slavík modráček (*Luscinia svecica*)



# Rehek domácí (*Phoenicurus ochruros*)





# Rehek zahradní (*Phoenicurus phoenicurus*)





# Bramborníček černohlavý (*Saxicola torquatus*)



# Bramborníček hnědý (*Saxicola rubetra*)





# Bělořit šedý (*Oenanthe oenanthe*)



Skalník zpěvný  
(*Monticola saxatilis*)





# Kos černý (*Turdus merula*)





# Kos horský (*Turdus torquatus*)





# Drozd zpěvný (*Turdus philomelos*)



banir hlasek  
hlasek.com



k  
n  
los d 168





# Drozd brávník (*Turdus viscivorus*)



# Drozd kvíčala (*Turdus pilaris*)





# Drozd cvrčala (*Turdus iliacus*)



# Č: Špačkovití – *Sturnidae*

- menší stromoví ptáci, silný zobák, trojúhelníkovitá křídla, kovový lesk peří
- hnízdí v dutinách stromů, potravu hledají na zemi (všežravci)
- sociální chování, imitují zpěv
- u nás 2 druhy (1 hnízdí)



Špaček obecný (*Sturnus vulgaris*)





# Č: Skřivanovití – *Alaudidae*

- pozemní ptáci s dlouhými drápy – hlavně na palci
- nenápadné zbarvení, většinou otevřená krajina, vysoké zpěvné lety
- hnízdo na zemi, potravou semena a bezobratlí
- u nás 6 druhů (3 hnízdí)

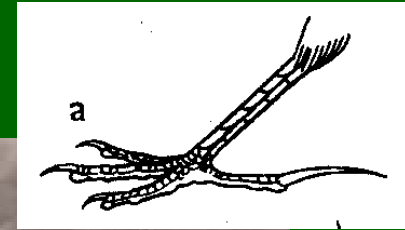

Chocholouš obecný (*Galerida cristata*)

# Skřivan polní (*Alauda arvensis*)





# Skřivan lesní (*Lullula arborea*)



# Č: Vlaštokovití – *Hirundinidae*

- štíhlí ptáci, adaptace na rychlý let – úzká špičatá křídla, dlouhý vidličnatý ocas, malé nohy
- lov hmyzu v letu – široký zobák s vibrisy
- koloniální hnízdění, hnízdo z bláta, synantropizace
- u nás 5 druhů (3 hnízdí)



Vlašťovka obecná  
(*Hirundo rustica*)





# Jiříčka obecná (*Delichon urbicum*)



# Břehule říční (*Riparia riparia*)





# Č: Králíčkovití – *Regulidae*

- drobní zavalití ptáčci (nejmenší pěvci)
- krátký špičatý zobák, nenápadné zbarvení, barevná korunka
- jehličnaté lesy, hnízdo vysoko na stromech, hmyzožravci, v zimě pospolití
- u nás 2 hnízdící druhy (někdy řazeni k pěnicovitým)



Králíček obecný (*Regulus regulus*)



# Králíček ohnivý (*Regulus ignicapilla*)

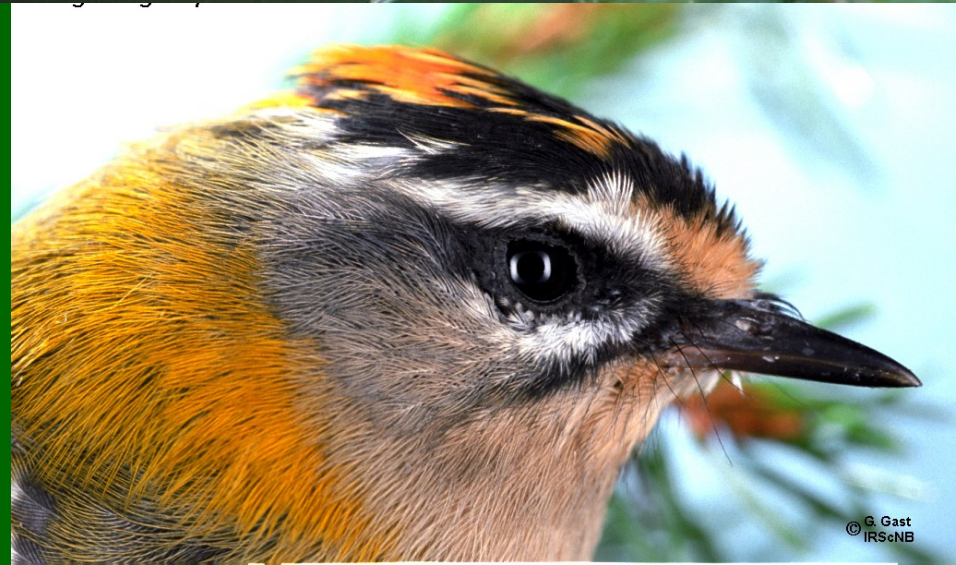



# Č: Pěnicovití – Sylviidae

- drobní štíhlí, nenápadně zbarvení ptáci, úzký špičatý zobák
- výrazný zpěv, tažní hmyzožravci
- život i hnízdění v husté vegetaci
- u nás 28 druhů (17 hnízdí)
- dnes někdy členění na Cettiidae, Phylloscopidae, Acrocephalidae, Cisticolidae a Sylviidae



Cvrčilka říční  
(*Locustella fluviatilis*)



# Cvrčilka zelená (*Locustella naevia*)





# Cvrčilka slavíková (*Locustella luscinioides*)



# Rákosník obecný (*Acrocephalus scirpaceus*)





# Rákosník zpěvný (*Acrocephalus palustris*)



Rousserolle verderolle  
(*Acrocephalus palustris*)



# Rákosník velký (*Acrocephalus arundinaceus*)





# Rákosník proužkovaný (*Acrocephalus schoenobaenus*)



Rákosník tamaryškový  
(*Acrocephalus melanopogon*)



Rákosník ostřicový  
(*Acrocephalus paludicola*)





# Sedmihlásek hajní (*Hippolais icterina*)



# Pěnice černohlavá (*Sylvia atricapilla*)





# Pěnice slavíková (*Sylvia borin*)





# Pěnice hnědokřídlá (*Sylvia communis*)





# Pěnice pokřovní (*Sylvia curruca*)





# Pěnice vlašská (*Sylvia nisoria*)





# Budníček menší (*Phylloscopus collybita*)



# Budníček větší (*Phylloscopus trochilus*)





# Budníček lesní (*Phylloscopus sibilatrix*)



# Budníček zelený (*Phylloscopus trochiloides*)





# Č: Mlynaříkovití – *Aegithalidae*

- drobní ptáčci s dlouhým ocáskem a krátkým zobáčkem
- společenští, kulovité hnízdo s postranním vchodem
- vlnovitý let, potravou hlavně hmyz
- u nás 1 hnízdící druh



Mlynařík dlouhoocasý  
(*Aegithalos caudatus*)

# Č: Sýkořicovití – *Panuridae*

(= *Paradoxornithidae*)

- drobní společenší ptáci, krátký zobák, dlouhý stupňovitý ocas
- rákosiny, mimo hnízdění potulky
- potravou hmyz, semena, plody
- u nás 1 hnízdící druh
- nevyjasněné zařazení (součást Timaliidae, monotypická čeleď?)



Sýkořice vousatá (*Panurus biarmicus*)



# Č: Moudivláčkovití - *Remizidae*

- malí podsadití ptáčci, v blízkosti vod
- visící vakovité hnízdo z chmýří, potravou hmyz a semena
- u nás 1 hnízdící druh



Moudivláček lužní (*Remiz pendulinus*)

# Č: Sýkorovití – Paridae

- drobní podsadití stromoví ptáci s ostrým silným zobáčkem
- samci větší a pestřejší, vícedruhová hejna, různé biotopy
- hnízdí v dutinách či štěrbinách
- potravou hmyz, v zimě hlavně olejnatá semena
- u nás 7 druhů (6 hnízdí)



Sýkora koňadra (*Parus major*)



# Sýkora modřinka (*Cyanistes caeruleus*)



# Sýkora uhelníček (*Periparus ater*)



© - lubomir hlasek  
www.hlasek.com  
Parus ater 11034



# Sýkora parukářka (*Lophophanes cristatus*)





# Sýkora babka (*Poecile palustris*)





# Sýkora lužní (*Poecile montanus*)



# Č: Brhlíkovití – *Sittidae*

- podsadití stromoví ptáci, šplh po stromech a větvích, i hlavou dolů
- dlouhý silný zobák, krátký ocas, silné zahnuté drápy
- lesní biotopy, teritoriální, hnízdí v dutinách (zedník)
- potravou bezobratlí, semena
- u nás 1 hnízdící druh

*Sitta europaea* ♀



Brhlík lesní (*Sitta europaea*)





# Č: Šoupálkovití – Certhiidae

- malí štíhlí stromoví ptáci, dlouhý zahnutý zobák
- krátké nohy s dlouhými zahnutými drápy, dlouhý pevný ocas
- šplh hlavou nahoru, hnízdo ve štěrbinách (za kůrou)
- potravou hlavně bezobratlí, vícedruhová hejna
- u nás 2 hnízdící druhy



Šoupálek dlouhoprstý  
(*Certhia familiaris*)



# Šoupálek krátkoprstý (*Certhia brachydactyla*)





# Č: Zedníčkovití – *Tichodromadidae*

- středně velký pták, dlouhý zahnutý zobák, silné drápy
- šedivé zbarvení, červená křídla
- vysokohorské habitaty, šplh po skalách
- hmyzožravci, hnízda ve skalních štěrbinách
- u nás vzácně zimující 1 druh



Zedníček skalní  
(*Tichodroma muraria*)



# Č: Střízlíkovití – Troglodytidae

- drobní, podsaditá ptáčci s krátkým ocáskem vztyčeným nahoru
- hnědé zbarvení, tmavé příčkování, úzký špičatý zobák
- teritoriální, hlasitý zpěv, potravou bezobratlí
- křoviny, kupolovité hnízdo s postranním vchodem
- u nás 1 hnízdící druh



Střízlík obecný (*Troglodytes troglodytes*)



# Č: Vrabcovití – *Passeridae*

- menší ptáci se silným kuželovitým zobákem, pozemní
- hlavně semenožraví, méně plody, hmyz
- společenšší – komplex sociálního chování
- koloniální hnízdění – v keřích či dutinách, synantropní
- u nás 3 druhy (2 hnízdí)



Vrabc domácí  
(*Passer domesticus*)

# Vrabec polní (*Passer montanus*)





# Pěnkavák sněžní (*Montifringilla nivalis*)



# Č: Pěvuškovití – *Prunellidae*

- drobní převážně vysokohorští pěvci, lehce podhrnutý zobák
- nevýrazné zbarvení, pozemní nebo v keřích
- hnízdo ve vegetaci nebo ve skalách
- potravou hmyz, semena, plody
- u nás 3 druhy (2 hnízdí)



Pěvuška modrá (*Prunella modularis*)



# Pěvuška podhorní (*Prunella collaris*)



# Č: Konipasovití – *Motacillidae*

- většinou pozemní štíhlí ptáci s dlouhýma nohama a ocasem
- kontrastní (konipasi) nebo nenápadné zbarvení (lindušky)
- otevřené biotopy, let ve vlnkách, hnízdo na zemi, ve štěrbinách
- všežravci, u nás 11 druhů (7 hnízdí)



Konipas bílý (*Motacilla alba*)



# Konipas luční (*Motacilla flava*)



# Konipas horský (*Motacilla cinerea*)



Konipas citrónový (*Motacilla citreola*)



# Linduška lesní (*Anthus trivialis*)





# Linduška luční (*Anthus pratensis*)





# Linduška úhorní (*Anthus campestris*)



# Linduška horská (*Anthus spinoletta*)





# Č: Pěnkavovití - *Fringillidae*

- menší podsadití stromoví ptáci, silný krátký zobák – semenožravci
- samci většinou pestřejší, různé biotopy, vlnovkový let
- potravu hledají na zemi, otevřené miskovité hnízdo v keřích či stromech
- u nás 19 druhů (11 hnízdí)



Pěnkava obecná (*Fringilla coelebs*)

# Pěnkava jíkavec (*Fringilla montifringilla*)





# Zvonohlík zahradní (*Serinus serinus*)



# Zvonek zelený (*Carduelis chloris*)





# Stehlík obecný (*Carduelis carduelis*)



# Čížek lesní (*Carduelis spinus*)



www.hl  
Carduel



# Konopka obecná (*Carduelis cannabina*)



Konopka žlutozobá  
(*Carduelis flavirostris*)

# Čečetka tmavá (*Carduelis cabaret*)





# Čečetka zimní (*Carduelis flammea*)





# Křivka obecná (*Loxia curvirostra*)



SVO. Manu Polo.



mir hlasek  
asek.com



© J.FOUCARGE



# Hýl rudý (*Carpodacus erythrinus*)

*Pinicola enucleator*



# Hýl obecný (*Pyrrhula pyrrhula*)



d21





# Dlask tlustozobý (*Coccothraustes coccothraustes*)



RGE



# Č: Strnadovití – *Emberizidae*

- menší pozemní ptáci s tlustým zobákem, dlouhý ocas
- různě proužkované zbarvení, samci většinou pestřejší
- semenožravci, otevřená krajina, hnízdo nízko nad zemí
- u nás 14 druhů (4 hnízdí)



Strnad obecný (*Emberiza citrinella*)





# Strnad rákosní (*Emberiza schoeniclus*)





# Strnad zahradní (*Emberiza hortulana*)





# Strnad luční (*Emberiza calandra*)



# Sněhule severní (*Plectrophenax nivalis*)

