

Monitoring of POPs in the ambient air



Jana Klánová

The objectives of the POPs Global Monitoring Plan

To evaluate **whether the POPs actually were *reduced or eliminated*** as requested in Articles 3 and 5 of the Convention, information on environmental levels of the chemicals listed in the annexes should **enable detection of *trends* overtime.**

Therefore focus is upon **monitoring of background levels** of POPs at locations not influenced by local sources.

Reliable identification of trends will require that statistical evaluation is carried out **on the design of each national monitoring programme** contributing to the Global Monitoring Plan, to ensure that it is powerful enough to detect trends in time.

Air sampling

Air is a key medium - **responds quickly** to sources

Air **concentrations fluctuate** widely in the space and time

Various concentrations in the **gas/particulate phases** -
compromise over the sample time/volume/technique

Short-term sampling/bulking

Air sampling

- **ambient air** - permanent gases
 - **volatile/semivolatile compounds**
 - **particules**
- **indoor air**
- **working environment**
- **emissions**
- **imissions**

Sampling and sampling preparation methodology

Experimental **design**

Sample matrices - choice of **equipment**

All **sampling procedures** have to be agreed upon and **documented**

Representativeness and **integrity** of the sample during the entire sampling process has to be assured

Quality requirements (equipment, transportation, pre-analytical treatment, storage, GPS referencing, standardization, documentation)

Personal protection, waste management

Sample **handling**

High volume samplers for active POPs sampling



Dust aerosols samplers



Dust aerosols samplers

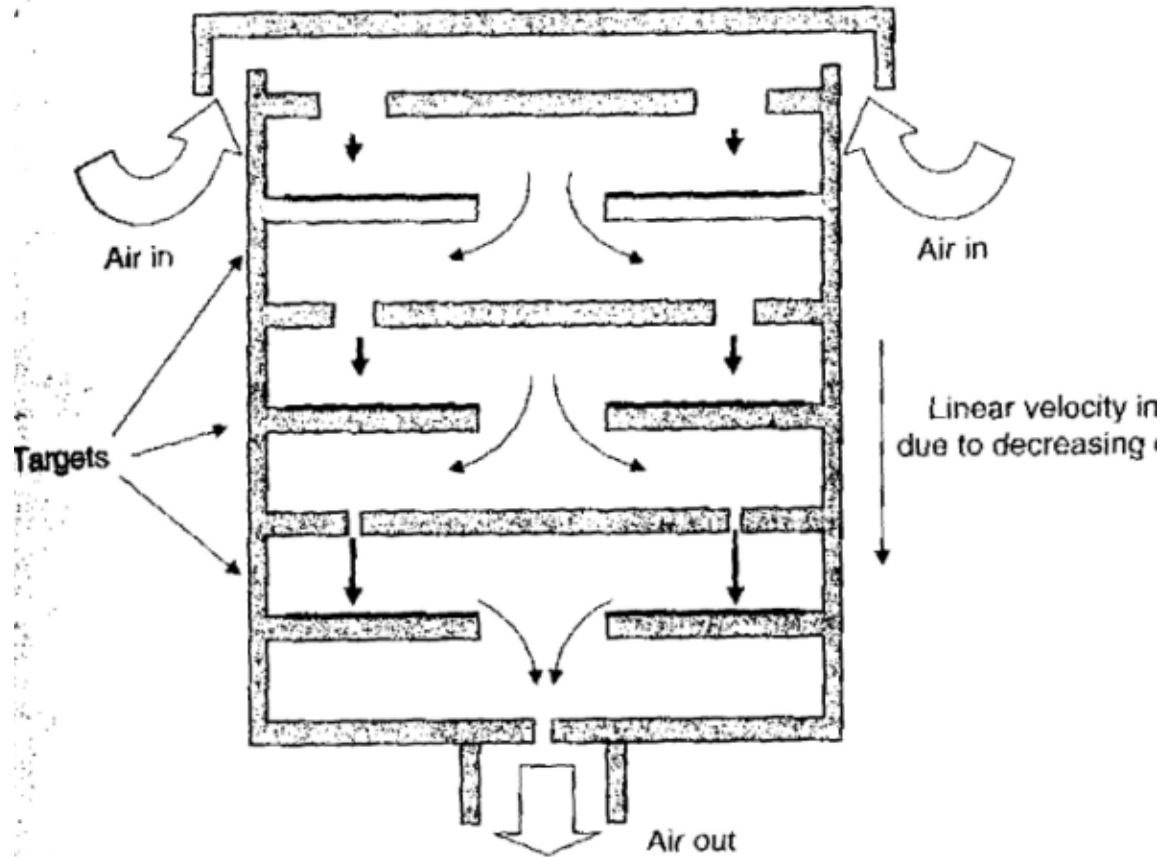
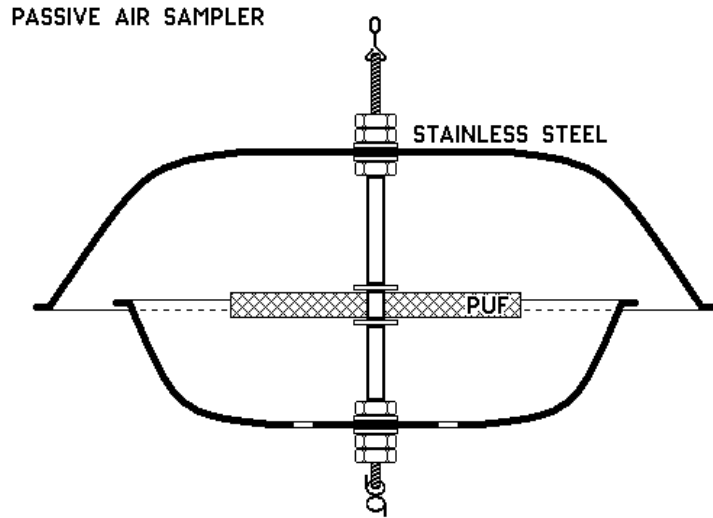

Figure 7.3 Schematic showing the operation of a cascade impactor.

Passive Air Samplers



- **filter (polyurethane foam)** – captures pollutants from the surrounding air
- **sampler body** – filter protecting chamber (wind, rainwater, solar radiation)

Analytical methodology

Extraction and clean-up

POPs analysis

Organization of quality control

Data treatment

Basic requirements

Competence for **infrastructure, instrumentation, and trained staff**

- **Validation** of the analytical methods including in-house methods
- Standard operating procedures (**SOPs**) for the validated methods
- Quality criteria for quality assurance and quality control (**QA/QC**)

Recommended analytes

Chemical Parent POPs

Aldrin
Chlordane *cis*- and *trans*-chlordane
DDT 4,4'-DDT, 2,4'-DDT
Dieldrin
Endrin
HCB
Heptachlor
Mirex
Polychlorinated PCBs
PCB with TEFs*

Polychlorinated 2,3,7,8-PCDD/PCDF
Toxaphene Congeners

Transformation products

(*cis*- and *trans*-nonachlor, oxychlordane)
(4,4'-DDE, 2,4'-DDE, 4,4'-DDD, 2,4'-DDD)

(Heptachlor, heptachlorepoxyde)

(7 congeners: 28, 52, 101, 118, 138, 153, and 180)
(12 congeners: 77, 81, 105, 114, 118, 123, 126,
156, 157, 167, 169, and 189)

(17 congeners)
P26, P50, P62

Extraction

The appropriately prepared sample can be extracted by **any of a number of techniques** (Soxhlet, automatic extraction, pressurized extractions, MAE, SFE).

The main points to consider are to allow **adequate time** of exposure of the solvent system in the sample matrix.

Cross contamination from residues left behind by high levels of POPs in other samples is a concern at this stage and equipment must be thoroughly cleaned and checked from batch to batch.

Purity of extraction solvents is also a major consideration. Only high purity glass distilled solvents should be used.

Standards should be added to the sample as early as possible in the process.

If the results are reported on a **lipid weight basis**, the determination of the lipid content in the sample is critical.

Standards

should be added **before extraction** to control the extraction efficiency (the recoveries differ with POP and matrix, for PCB and pesticides: 80 % - 120 %, for tetra- and penta-chlorinated PCB, recoveries down to 60 % can be accepted, for PCDD/PCDF: 50 % - 130 % (for hepta- and octa-chlorinated PCDD/PCDF 40 % - 150 % can be accepted).

For PCB analysis and ECD detection, a **minimum of two standards** - one eluting at the beginning and one at the end of the chromatogram – should be used.

Concentration (evaporation under vacuum or with nitrogen – control of temperature, flow of nitrogen, **drying of the extract should be avoided** - keeper)

Elimination of water (sodium sulphate), lipids (sulphuric acid or permeation in gels), proteins (denaturation with oxalate), and sulfur (activated copper)

Clean-up is performed with various combinations of adsorbents and solvents depending on selectivity, conditioning and column flow in order to remove interfering substances/materials from the analyte. Sample clean-up procedures **should be efficient to prevent contamination of the detector.**

Separation of POPs

is conducted using gas chromatography with electron capture detector (**ECD**), mass selective detector (**MS** detector) or, if available, high-resolution mass spectrometry (**HRMS**).

Other separation techniques, such as high pressure liquid chromatography (HPLC), have not been found adequate.

An **appropriate stationary phase** has to be selected and enough peak separation must be achieved to allow accurate quantification (capillary columns lengths of 30-60 m, internal diameters of 0.15-0.25 mm, a film thickness of 0.1-0.3 μm , helium or hydrogen as a carrier gas, **cleanliness** of injector - deactivated glass insert).

Verification of chromatographic conditions include resolution, symmetric peak shape, reproducibility of retention times; verification of the linear range of the instrument.

Identification

The information available to identify the compounds eluted from the gas Chromatographic column depends on the type of detector being used.

Retention time should match between sample and internal standard;

Confirmation of peaks can be performed on a **second column with different polarity**;

Matrix spikes are recommended to verify components;

For GC-MS detection combinations, positive identification should be done on **isotopic ratios** within 20 % of theoretical value;

The retention time of the **labeled internal standard** to the native compound should be within 3 seconds ;

The use of **MS libraries** is useful if using full scan.

Quantification

In general, quantification of the analyte should be done according to the **internal standard methodology**;

At least one standard representative for the POPs analyte group analyzed should be added at the normal level of quantification ;

Verification that the **concentration of blanks** is significantly lower than the samples (recommendation **< 10%**).

Calibration:

Multi-point calibrations should be carried out, labeled internal standards are an added value;

Daily calibration checks in connection with analyzing a series of samples should be done ;

Suitable **laboratory reference material** should be used to verify the performance. The **maintenance of the analytical equipment** is considered as one of the most important aspects in POPs analysis.

Quality assurance and quality control

are important factors in sampling and analysis;

Internal and recovery stds have to be used;

Any method performance must be verified through control tables where optimal operational ranges are defined ;

Periodical analysis of **blank samples** and **certified reference materials**;

Own laboratory **reference materials**, and blind or divided samples should be included in routine QA/QC;

The **inter-calibration exercises** are an essential component in quality assurance of the results and are deemed indispensable in the implementation of a regional laboratory network;

A recommendation would be that **at least once a year** such an intercalibration study is performed for each matrix and persistent organic pollutant of interest to the Region.

Data treatment

There are a number of parameters that have to be reported together with the analytical results.

These include the efficiency of the extraction and clean-up, and the blank values, but the results should not be compensated for these parameters.

The uncertainty of the results should also be at least estimated, but preferably determined, using results from inter- or intralaboratory comparisons.

Terminology

Calibration

Linearity

Sensitivity and specificity

Robustness and repeatability

Limit of detection and quantification

Accuracy, trueness, precision

Standard deviation $\sigma^2 = \frac{\sum R_i^2}{2n}$ RSD = $\frac{100 \sigma}{\bar{X}}$

Regulation diagram – Warning interval $\bar{X} \pm 2 \sigma$ (95.5% results)
 Regulation interval $\bar{X} \pm 3 \sigma$ (99.7% results)

Confidence interval $R = 2,8 \sigma$

Z-score $Z = \frac{y - \bar{y}}{\sigma}$ $-2 < z < 2$

RSZ- rescaled sum of z-scores $RSZ = \frac{\sum z}{\sqrt{m}}$

SSZ - sum of squared z-scores $SSZ = \sum z^2$

LOD, LOQ

The lowest concentration at which a **compound can be detected** (limit of detection, LOD) is defined as that corresponding to a signal three times the noise.

The lowest concentration that **can quantitatively be determined** (limit of quantification LOQ) is three times higher than LOD.

Compounds found at levels between LOD and LOQ can be reported as present, or possibly as being present at an estimated concentration, but in the latter case the result has to be clearly marked as being below LOQ (“LOD-LOQ”), data below LOD as “<LOD”;

Results for sum parameters where one or several individual compounds are <LOQ should be reported as intervals with a lower bound limit calculated with the <LOQ set to 0, and the upper bound limit with <LOQ set equal to LOQ.

There are, however, several statistical techniques for treating censored data when the true detection limit is known, e.g. by using a robust statistic such as the median which is unaffected by small numbers reported as below LOD. “<LOD” can be substituted by $\frac{1}{2}$ LOD

Data treatment

There are a number of parameters that have to be reported together with the analytical results. These include the efficiency of the extraction and clean-up, and the blank values.

Recovery efficiency should be reported but reporting values should not be corrected for percentage of recovery;

It should be demonstrated that the **blank is 10-times lower** than the value that is reported but reporting values should not be corrected by laboratory blanks ;

The uncertainty of the results should also be at least estimated, but preferably determined, using results from inter- or intralaboratory comparisons.

There are two methods available to provide information on uncertainty:

- Quantification of uncertainty for each step;
- Overall uncertainty derived from inter- and intra-laboratory results.

Terminology

Primary GMP data: are the results of measurements made on samples

GMP meta-data: are any other data or information that describe the *primary GMP data* in some way. This can include information on the methodologies employed (e.g., for sampling and analysis) and the laboratories responsible for a particular set of analyses.

Supplementary data: Are any other data or information that may be accepted for use in the Stockholm Convention evaluation process. This might include relevant information and/or data from published sources (e.g. the peer reviewed scientific literature, existing assessment, etc), results of modelling activities.

Un-aggregated data: individual sample measurement values (concentration of PCB153 in the liver tissue of a specific individual fish, sampled at location x at time y).

Aggregated data: (statistically) summarised data, e.g. averaged values that summarise the measurements on a number of individual samples.

The main goal of the Global Monitoring Plan data strategy is to compile **unaggregated - primary GMP data**.

Un-aggregated data permit data to be treated in a transparent and consistent manner.

If these methodologies are modified or further developed at some point in the future, the availability of un-aggregated – primary GMP data provides the **best possibilities for re-calculation** or for repeating previous data treatment.

To the greatest extent possible, data should be reported for **individual compounds or congeners or isomers**.

Data on contaminant concentrations should be reported together with a clear indication of both the units and the basis of determination (wet weight, lipid weight).

Mokrá - půdy 2002 - 4

vyhodnoceno: 25.4.2003

Koncentrace ng/g

Číslo vzorku	toluen	02-753	02-752	02-740	02-741	02-742	02-743	02-744	02-745	02-746	02-747	02-748	02-749	02-750	02-751	
Lokalita	GC blank	Lab. blank	RM	454 Hosten	Čihálky	332 Vodojem	Velká Bata1	Velká Bata2	Prostřed kopec	420Vel Bata	Chlumeck 1	Chlumeck 2	Horák mysl.	Nové pole	jižní CVM	LOQ
Číslo zadavatele				303S	304S	305S	306S	307S	308S	309S	310S	311S	312S	313S	314S	
Datum odběru				14.11.02	14.11.02	14.11.02	14.11.02	14.11.02	14.11.02	14.11.02	14.11.02	14.11.02	14.11.02	14.11.02	14.11.02	KALIB30
Navážka (g)	5,0	5,0	5,0	5,0	5,0	5,0	5,0	5,0	5,0	5,0	5,0	5,0	5,0	5,0	5,0	5,0
Ředění	1	1	1	1	1	1	1	1	1	1	1	1	1	1	1	1
Naftalen	0,10	1,86	26,74	12,5	6,6	7,5	5,2	5,5	11,8	13,5	7,1	6,6	8,6	5,9	8,5	0,10
Acenaftyle	-	0,02	0,58	0,8	0,3	0,7	0,4	0,5	2,2	1,8	0,6	0,5	1,2	2,4	0,8	0,10
Acenaften	-	0,04	1,22	1,4	0,3	1,4	1,6	0,6	5,3	3,4	2,5	0,8	2,0	5,4	1,2	0,10
Fluoren	-	0,04	2,26	1,7	0,6	1,4	1,3	0,7	4,9	3,8	2,0	1,0	2,2	4,7	1,5	0,10
Fenantren	-	0,12	23,96	24,9	6,4	20,5	18,8	8,4	69,1	59,4	14,2	13,6	29,5	109,3	16,8	0,10
Antracen	-	-	1,12	2,0	0,4	1,9	3,4	1,1	6,1	5,2	2,1	1,4	2,9	16,9	1,8	0,10
Fluoranten	-	-	27,78	68,2	13,7	58,0	42,0	24,2	213,0	162,5	40,7	37,6	82,5	450,2	42,9	0,10
Pyren	-	-	19,38	50,5	9,7	45,6	35,4	20,2	159,3	123,6	32,0	28,6	63,8	377,2	33,0	0,10
Benz(a)ant	-	-	4,60	17,9	2,9	14,4	14,7	9,1	61,5	49,3	18,3	13,1	26,3	206,3	13,6	0,10
Chrysen	-	-	11,50	32,4	7,3	25,6	18,4	12,2	102,6	75,9	22,3	16,8	41,2	204,2	20,0	0,10
Benzo(b)flu	-	-	18,30	61,0	11,7	32,2	23,6	20,4	169,5	128,2	28,0	29,4	67,7	261,1	31,2	0,10
Benzo(k)flu	-	-	6,04	18,1	3,8	14,4	11,0	7,9	56,4	41,9	13,0	11,2	22,4	134,8	11,6	0,10
Benzo(a)py	-	-	8,34	27,6	3,5	23,6	20,3	13,3	92,8	71,6	24,2	18,4	38,4	285,9	21,3	0,10
Indeno(123	-	-	8,22	33,1	6,4	21,4	14,8	11,1	98,7	72,0	22,6	19,6	41,0	216,1	20,7	0,10
Dibenz(ah)	-	-	0,82	2,7	0,6	2,4	1,6	0,9	7,1	8,3	1,8	2,3	4,1	25,8	1,8	0,10
Benzo(ghi)	-	-	11,26	29,7	5,3	20,6	14,8	11,4	83,9	61,4	19,4	16,3	36,0	181,8	18,5	0,10
Suma PAH	0,10	2,08	172,12	384,5	79,5	291,6	227,3	147,5	1144,2	881,8	250,8	217,2	469,8	2488,0	245,2	1,60
100% D-PAH	2 000	2 000	2 000	2 000	2 000	2 000	2 000	2 000	2 000	2 000	2 000	2 000	2 000	2 000	2 000	2 000
ředění	1	1	1	1	1	1	1	1	1	1	1	1	1	1	1	1
D8-naftalen	0%	0%	88%	72%	79%	66%	65%	80%	62%	66%	21%	61%	75%	81%	81%	
D10-fenant	0%	0%	90%	77%	91%	68%	72%	86%	77%	79%	88%	79%	85%	94%	92%	
D12-peryle	0%	0%	86%	74%	34%	67%	73%	86%	83%	83%	89%	82%	93%	101%	96%	

GC blank slepý vzorek přístroje GC-MS - nástřík čistého rozpouštědla do plynového chromatografu

Lab. blank laboratorní slepý vzorek - analyzovaný celým analytickým postupem s čistými rozpouštědly a všemi použitými materiály

GPC blank slepý vzorek GPC chromatografu

blank, GF blank terénní slepé vzorky - pasivní odběr na polyuretanovou pěnu a skleněné vlákno

CRM analýza certifikovaného referenčního materiálu

RM analýza laboratorního referenčního materiálu

NQ nekvantifikováno - analyt byl překryt interferentem

LOQ meze stanovitelnosti

Regional monitoring reports

Introduction, background

Description of the region

Regional strategy for information gathering

Arrangements to address global and regional transport

Methodology for sampling, analysis and handling of data

Results

Summary of findings and discussion

GMP should in each region strive for at least

Three to five stations with active high-volume sampling

A network of 10 to 15 passive sampling stations arranged in a grid with spacing of approximately 200 x 200 km for enhancing geographical coverage .

Passive samplers should be co-located at the high volume sites for comparison purposes.

Cumulative sampling (for 1 to 2 days every week or continuously over periods of 1 to 2 weeks) by active high volume sampling (~0.5-1 m³/min. flow rate) at a few sites in each region. These samples would be separated into particulate and gaseous fractions.

Continuous, cumulative passive (diffusive) sampling for integration periods of 3 months to 1 year using passive samplers deployed at a large number of sites, including the high volume sampling sites.

POP monitoring EMEP network, 2000

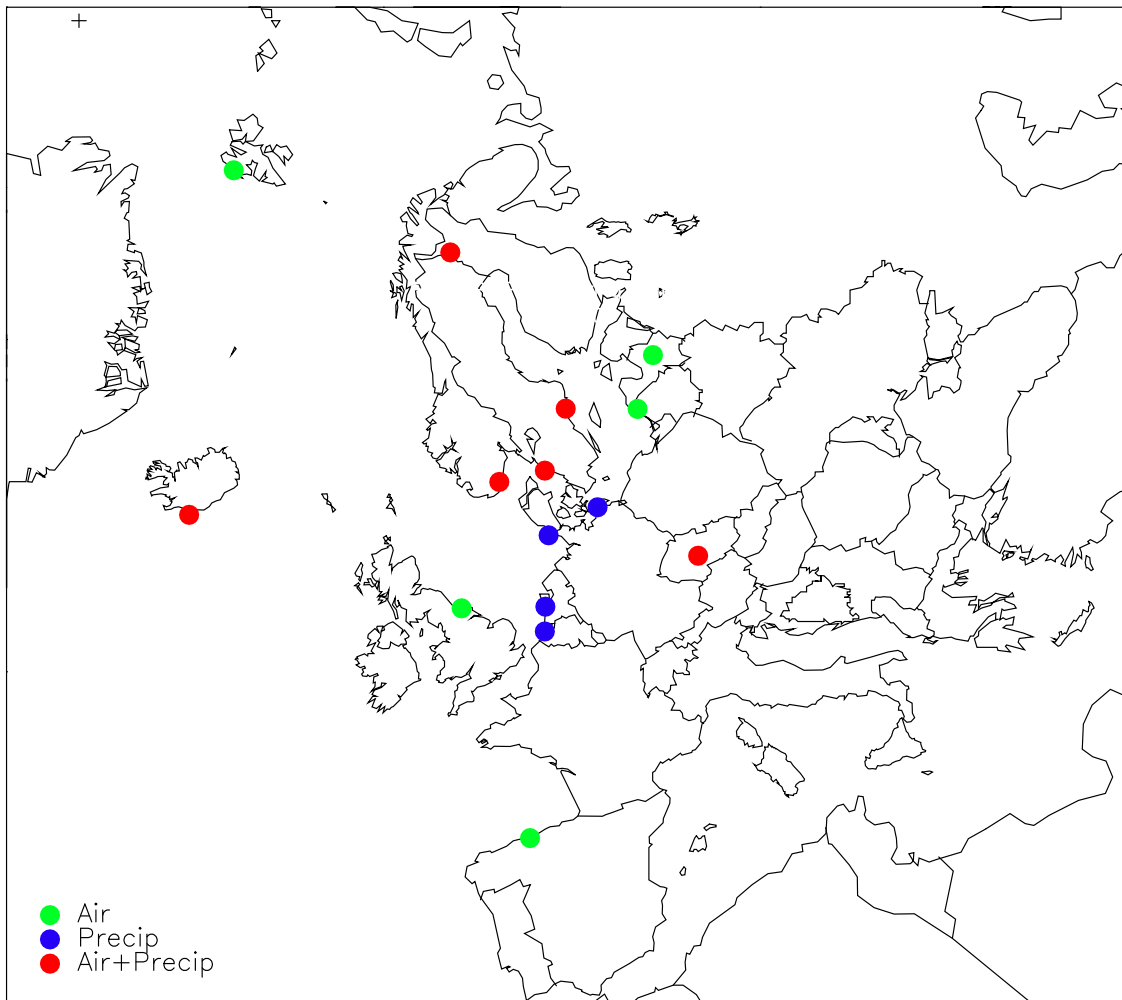

PAHs in the ambient air, Košetice observatory, 1996-2008

PAHs in Ambient Air - Košetice 1996-2008
Weekly Sampling

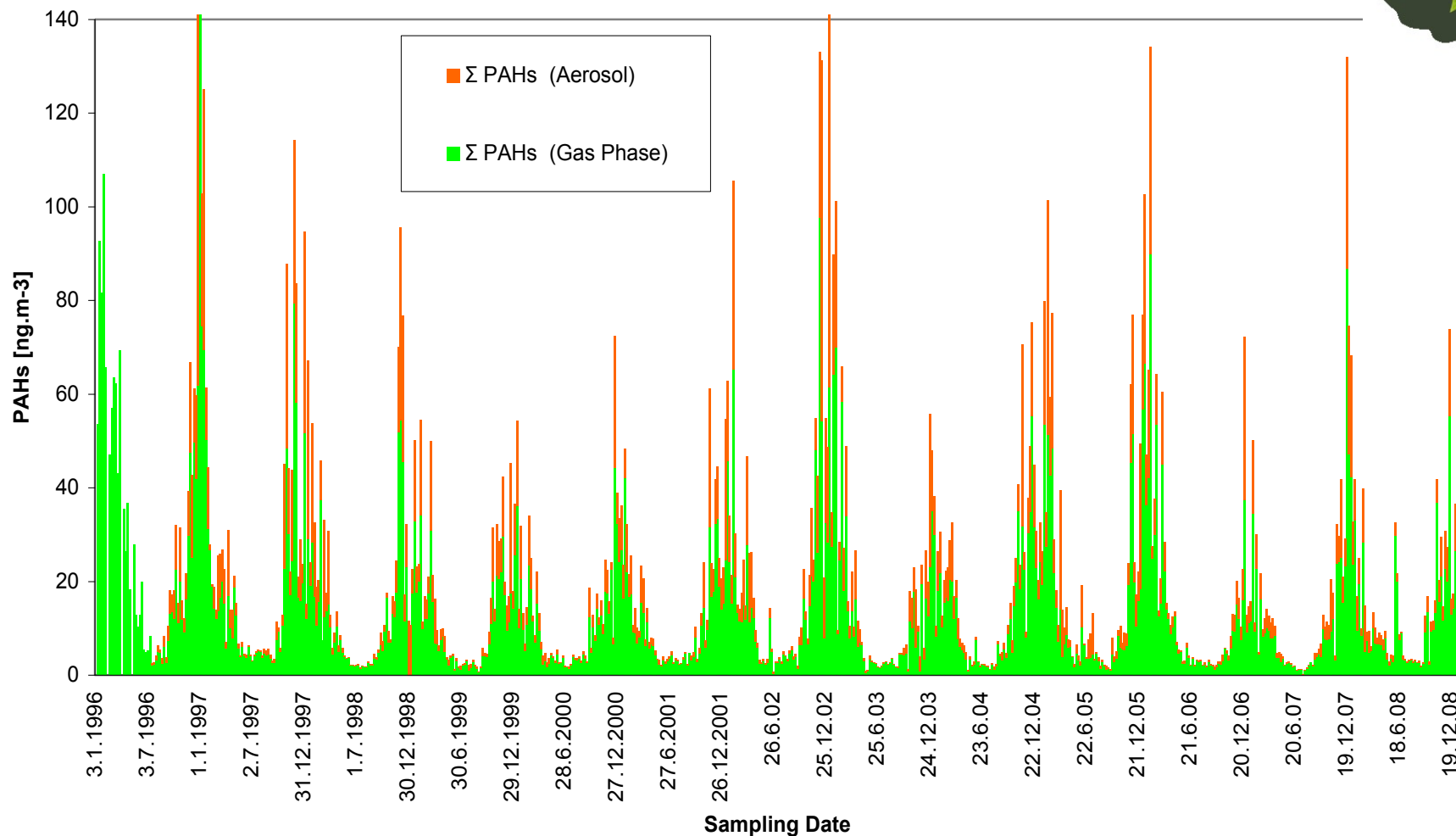

Holoubek, I., Klánová, J., Jarkovský, J., Kohoutek, J.: Trends in background levels of persistent organic pollutants at Košetice observatory, Czech Republic. Part I. Ambient air and wet deposition 1988-2005. *Journal of Environmental Monitoring* 9 (6), 557 – 563 (2007)

DDTs in the ambient air, Košetice observatory, 1996-2008

p,p'-DDE, p,p'-DDD and p,p'-DDT in Ambient Air - Košetice 1996-2008

Weekly Sampling

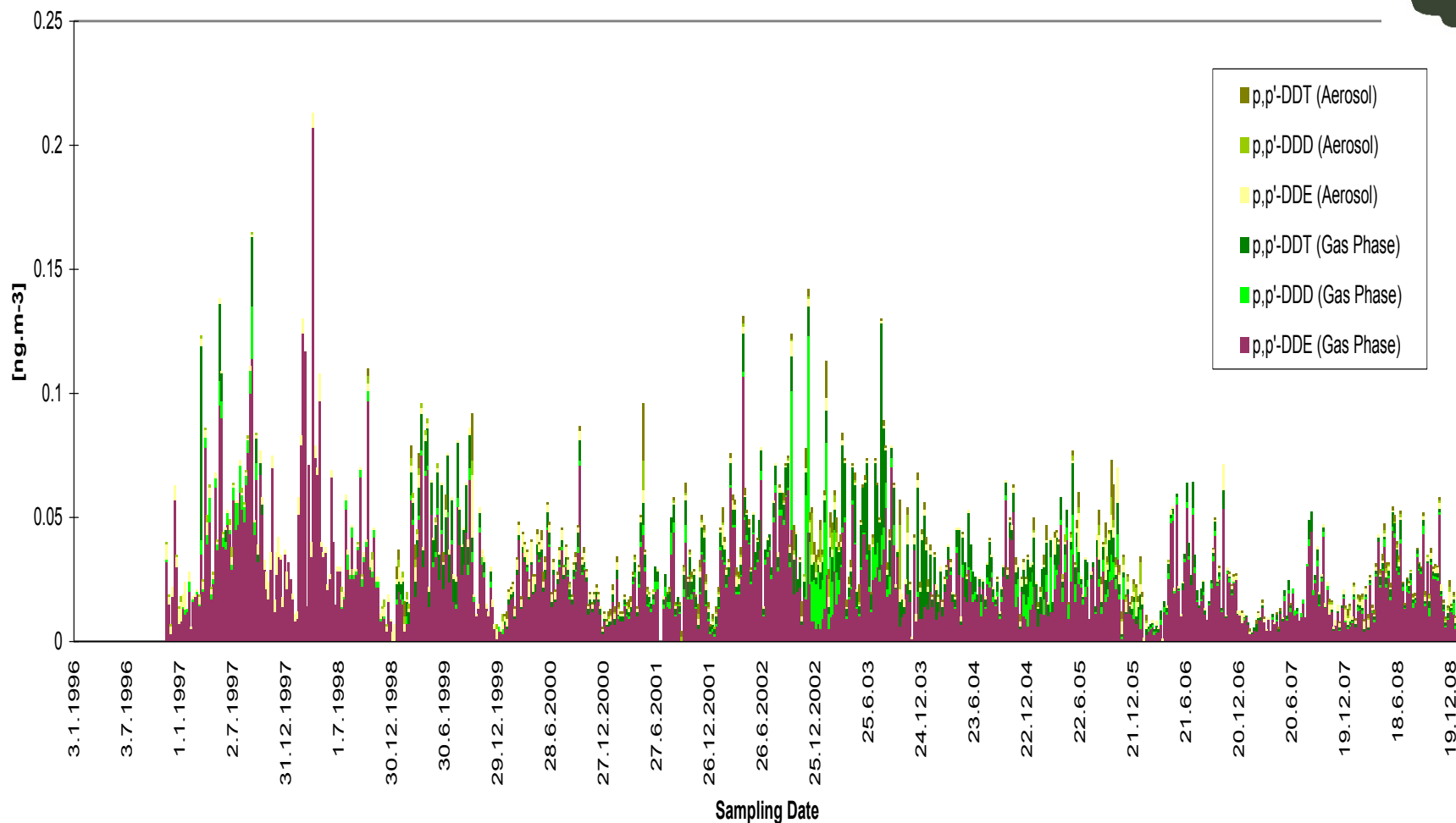

Holoubek, I., Klánová, J., Jarkovský, J., Kohoutek, J.: Trends in background levels of persistent organic pollutants at Košetice observatory, Czech Republic. Part I. Ambient air and wet deposition 1988-2005. *Journal of Environmental Monitoring* 9 (6), 557 – 563 (2007)

PAHs in rain (monthly means), Kosetice, 1996-08

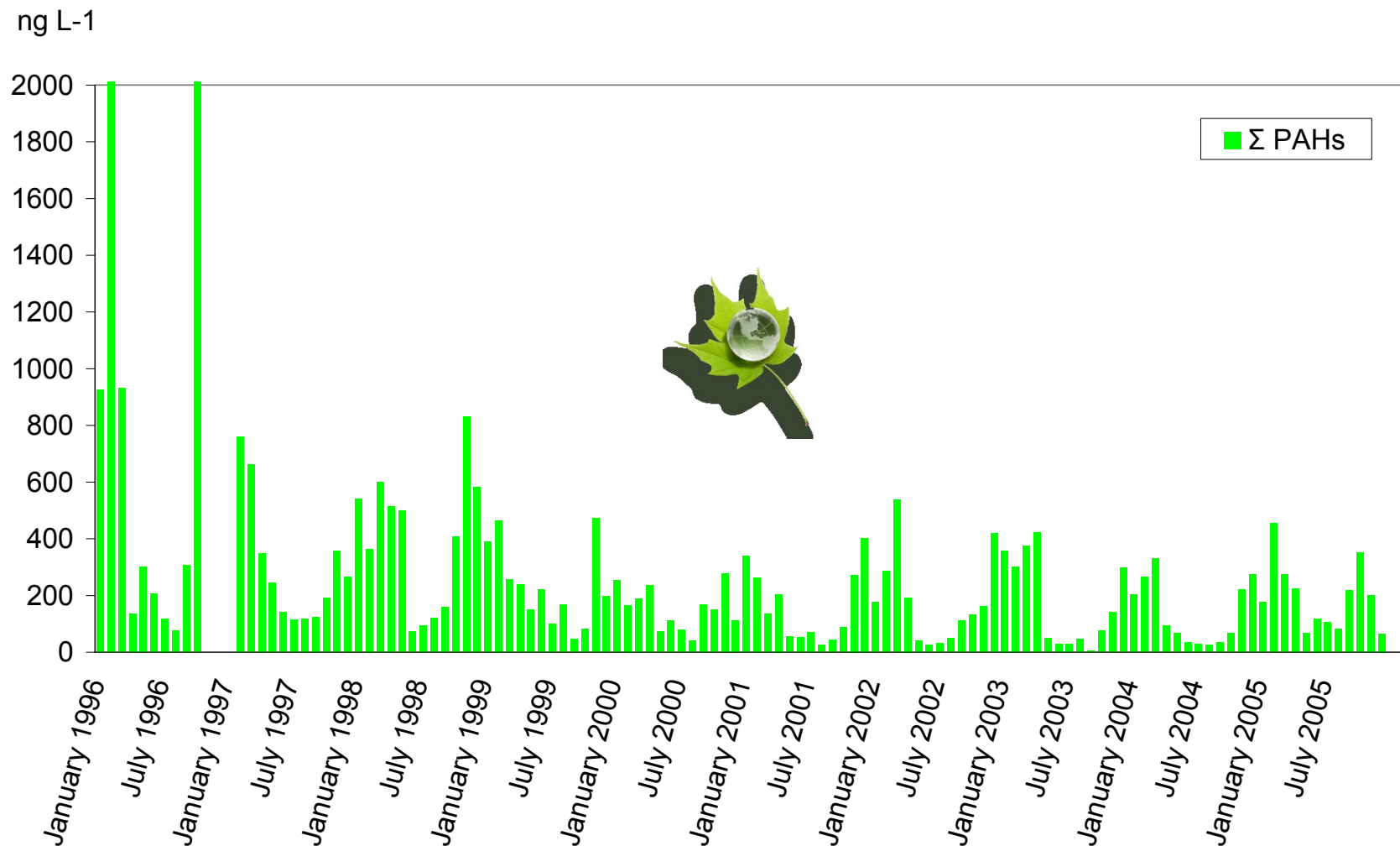

Holoubek, I., Klánová, J., Jarkovský, J., Kohoutek, J.: Trends in background levels of persistent organic pollutants at Kosetice observatory, Czech Republic. Part I. Ambient air and wet deposition 1988-2005. *Journal of Environmental Monitoring* 9 (6), 557 – 563 (2007)

Time related trends of POPs in the air, gas and particle phase.

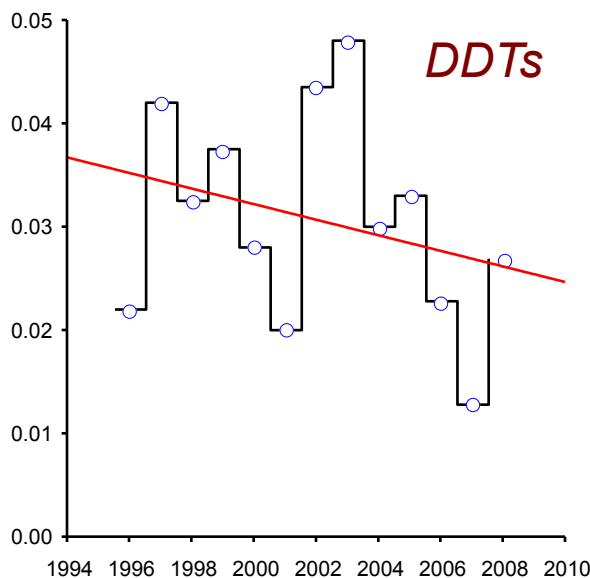
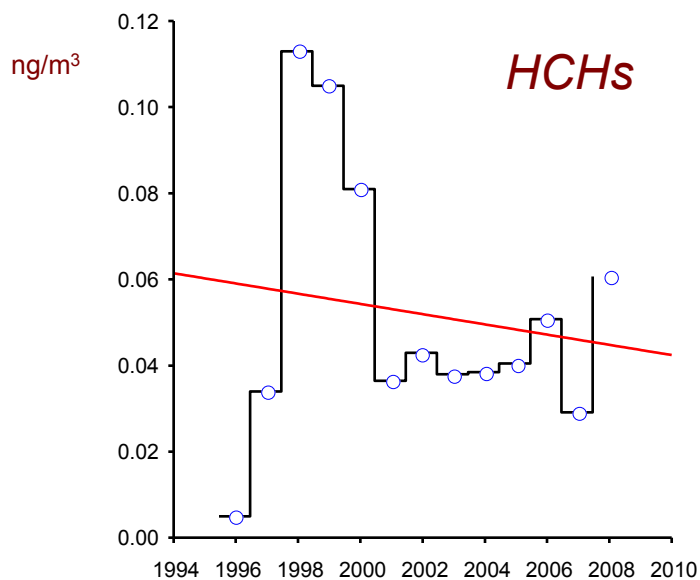
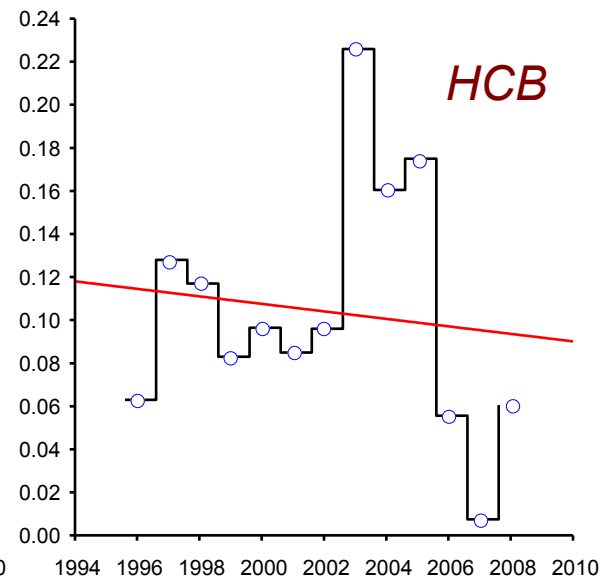
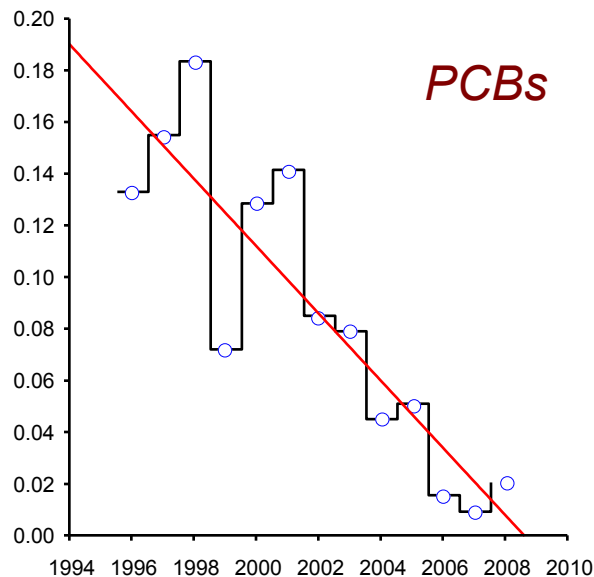
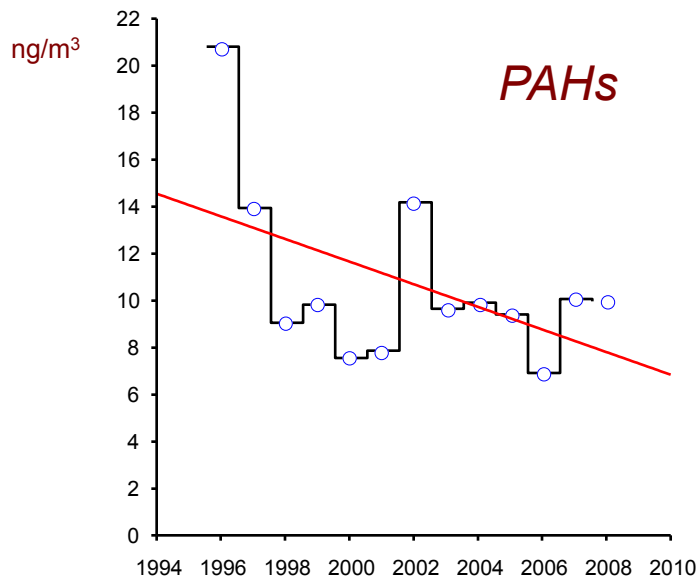

Holoubek, I., Klánová, J., Jarkovský, J., Kohoutek, J.: Trends in background levels of persistent organic pollutants at Kosetice observatory, Czech Republic. Part I. Ambient air and wet deposition 1988-2005. *Journal of Environmental Monitoring* 9 (6), 557 – 563 (2007)



Map of the sampling sites



Spatial and temporal variations of PCB concentrations in needles and moss, Košetice observatory, 1996-2005

Sum of PCBs in Needles from Košetice 1996-2008

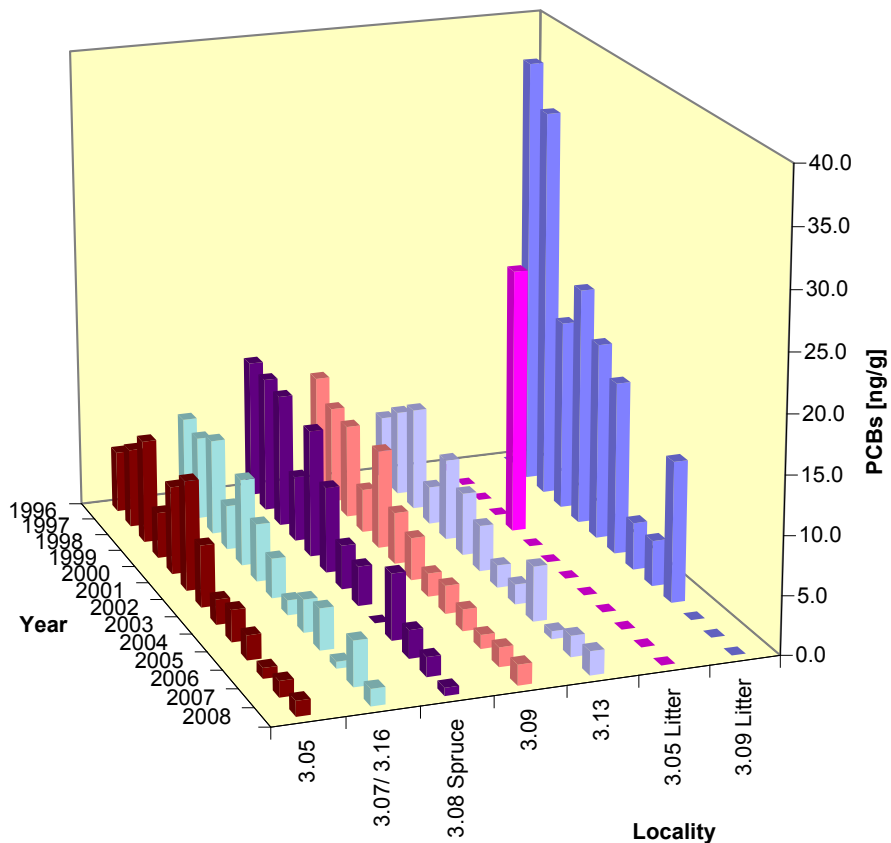

Sum of PCBs in Mosses from Košetice 1996-2008

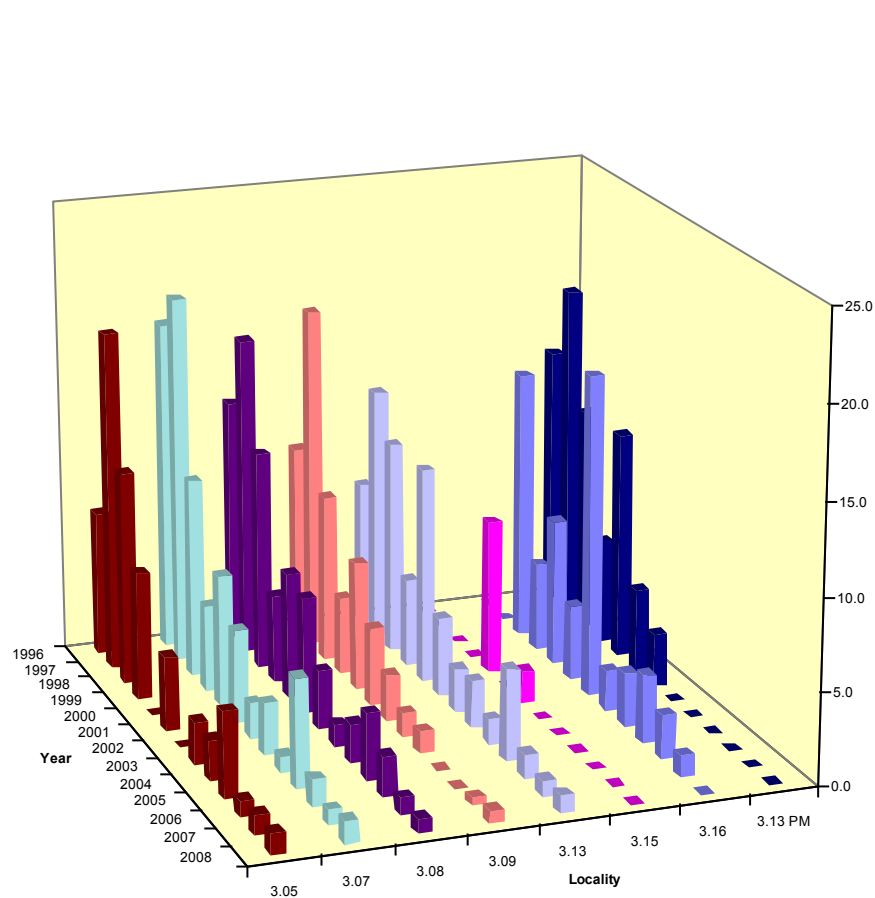

Spatial and temporal variations of PCB concentrations in soil and sediment, Košetice observatory, 1996-2005

Sum of PCBs in Sediments from Košetice 1996-2008

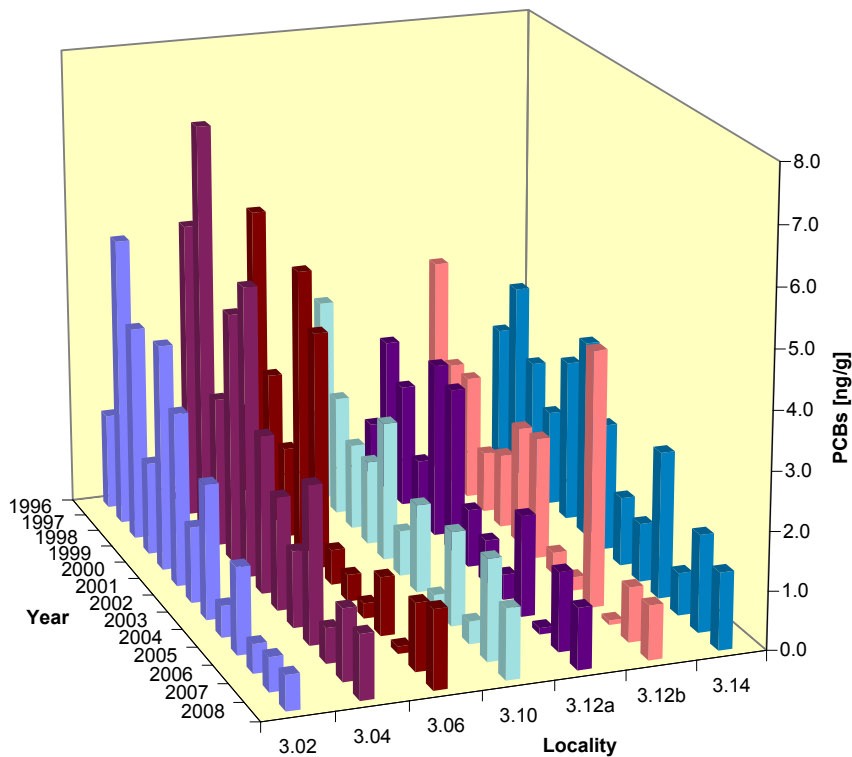

Sum of PCBs in Soils from Košetice 1996-2008

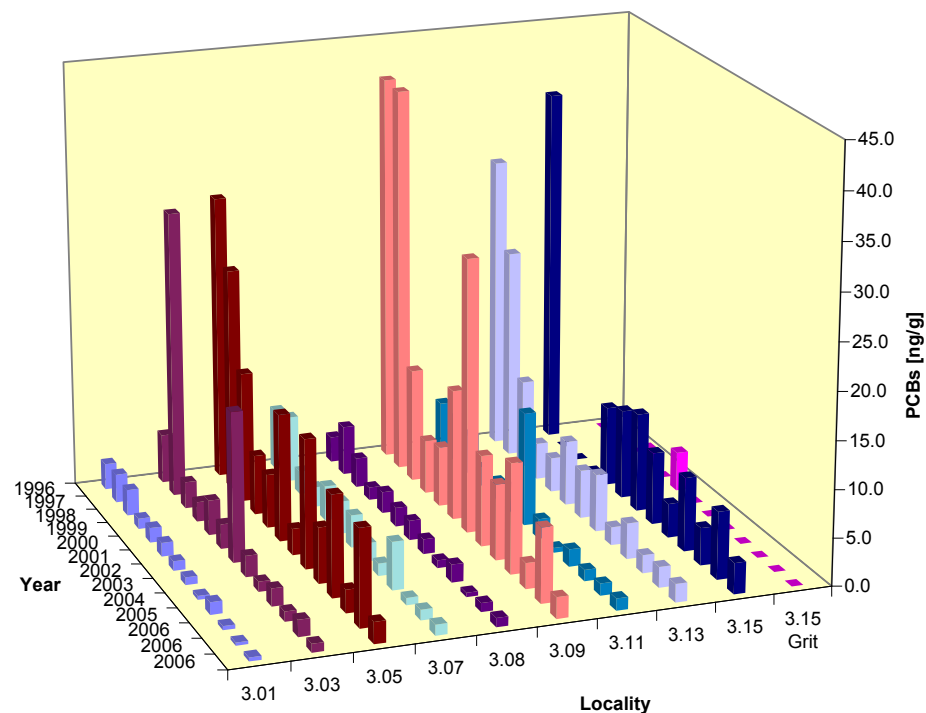



Time related trends

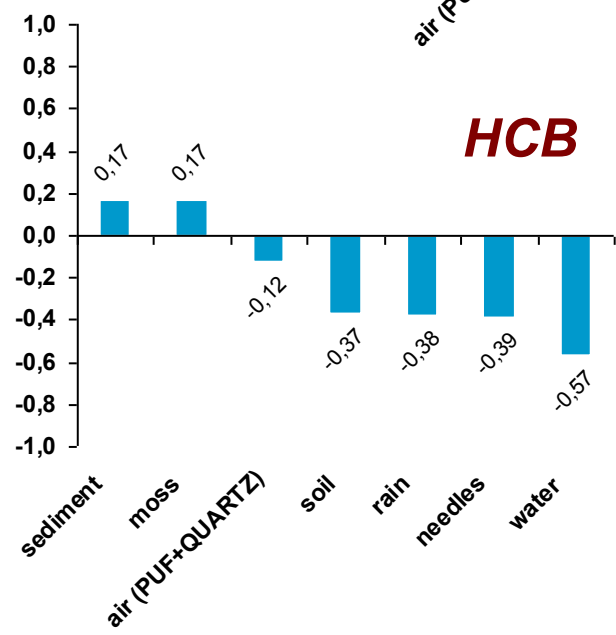
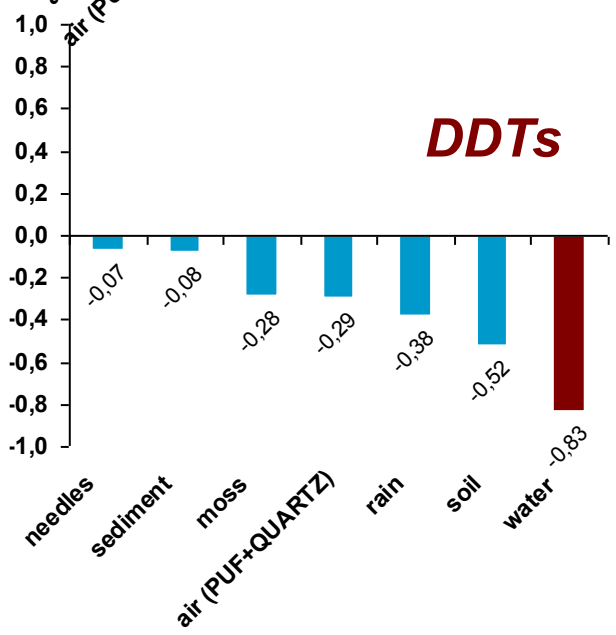
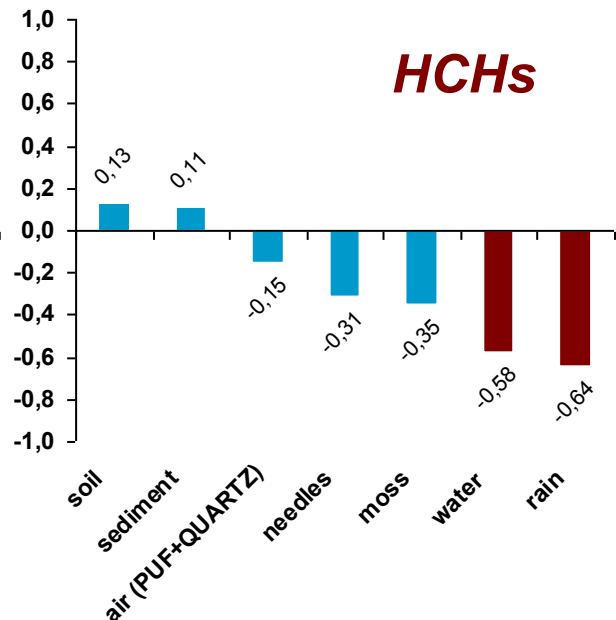
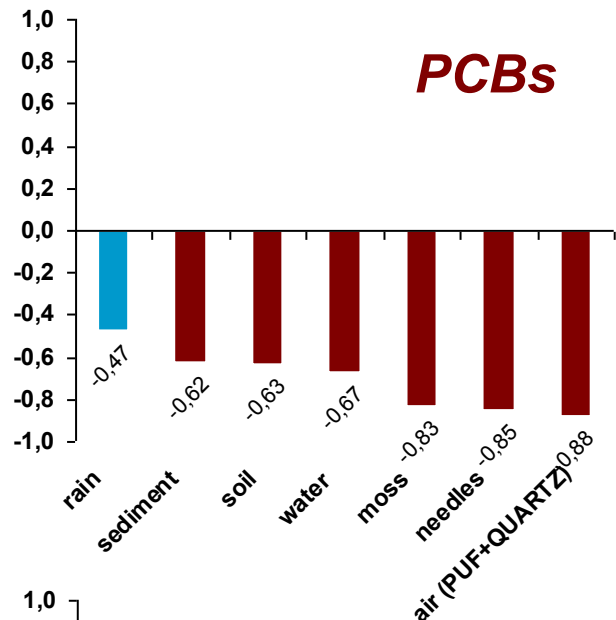
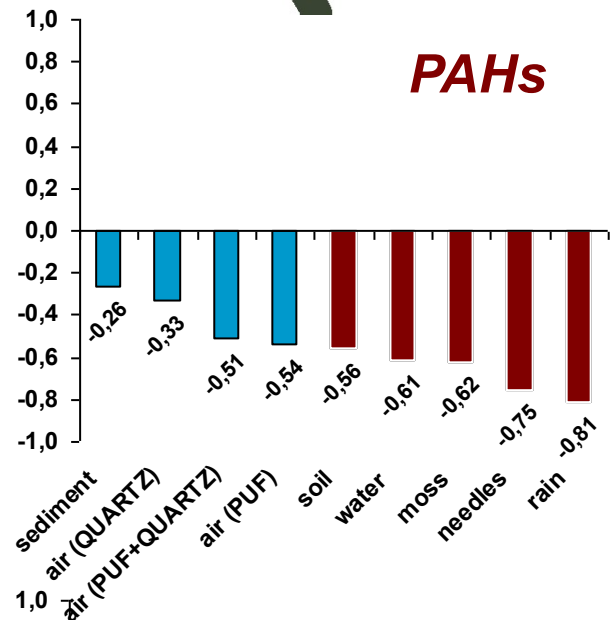

Statistically significant trend

Holoubek, I., Klánová, J., Jarkovský, J., Kubík, V., Helešic, J.: Trends in background levels of persistent organic pollutants at Kosečice observatory, Czech Republic. Part II. Aquatic and terrestrial environments 1988-2005. *Journal of Environmental Monitoring* 9 (6), 564 – 571 (2007)

Seasonal variation of PAH concentrations in the ambient air, Košetice observatory, 2003-2006

PAS - PAHs

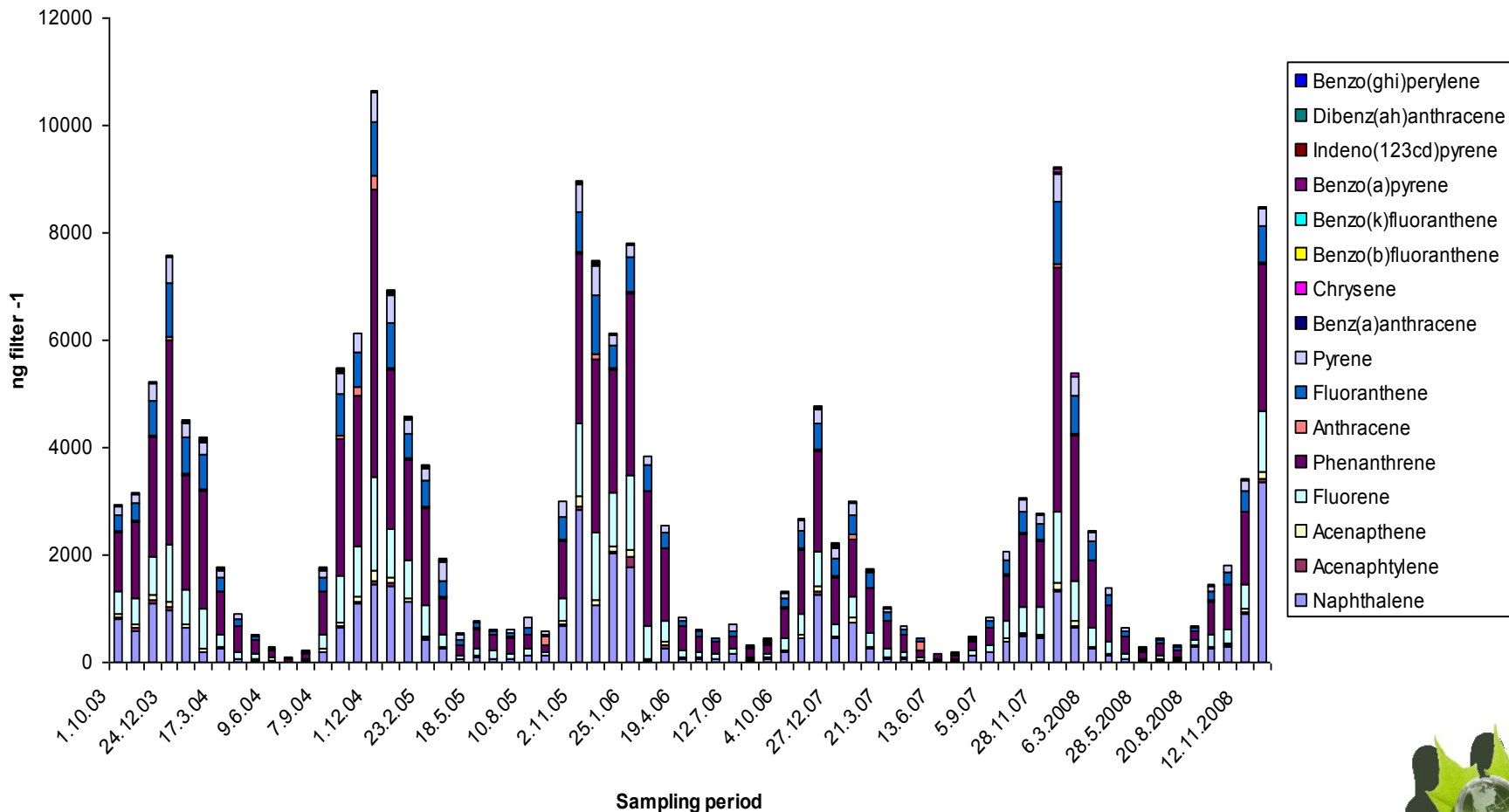

Passive sampling 2006-2008, CZ

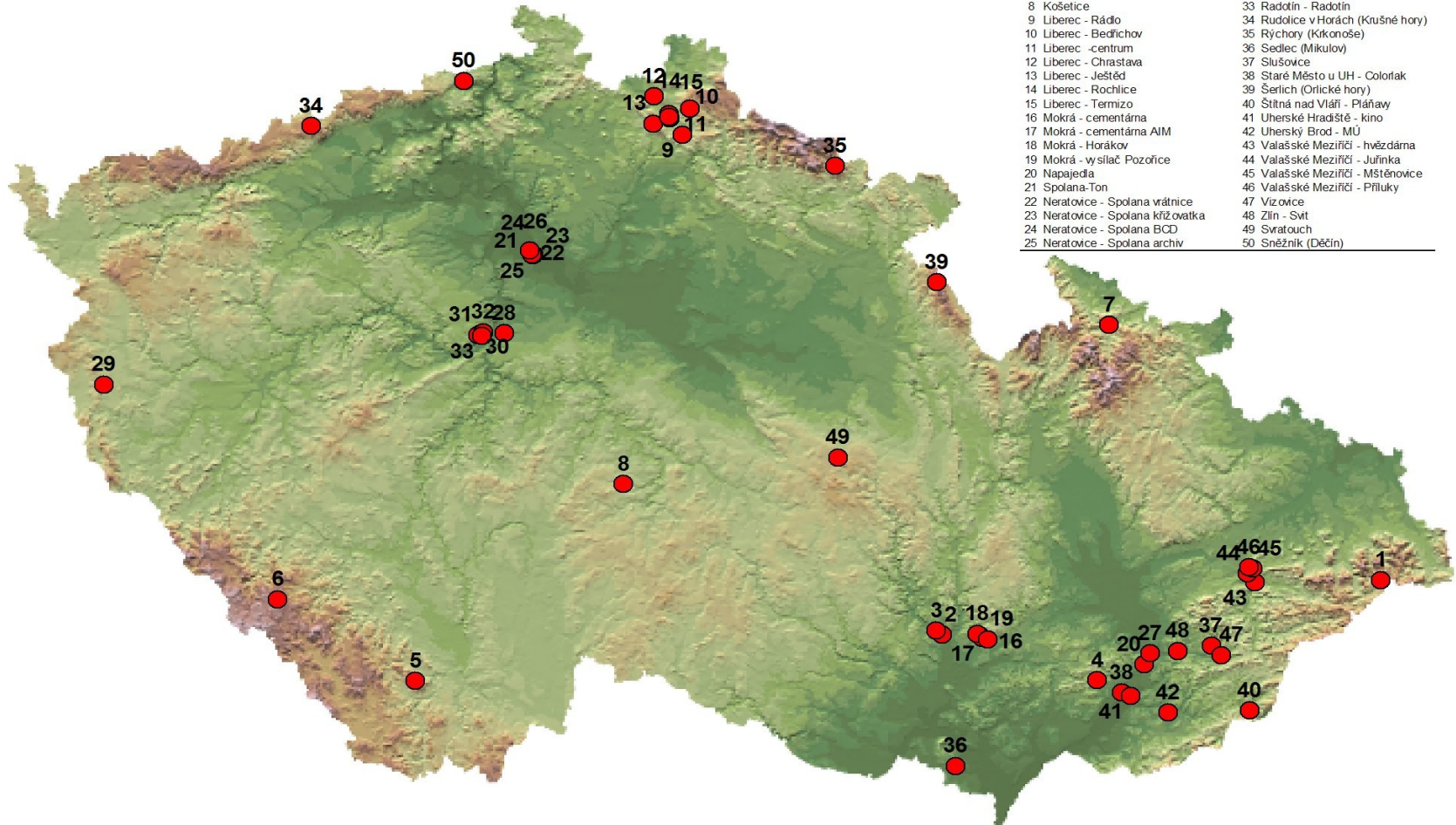

Klanova, J., Cupr, P., Borůvková, J., Kohoutek, J., Kareš, R., Příbylová, P., Prokeš, R., Holoubek, I.: Application of passive sampler for monitoring of POPs in ambient air. IV. Model monitoring network in the Czech Republic (MONET_CZ 2007), 2008. Masaryk Univerzity, Brno, Czech Republic. ISBN 978-80-210-4696-2



Passive sampling 2006-2008, CZ, PAHs

SAMPLING_S	No	SAMPLING_S	No
Bělý Kříž	1	Pláňavy, Štítná nad Vláří	40
Děčínský Sněžník	50	Praha, Libuš	28
Churáňov	6	Přimda	29
Jeseník	7	Rudolice	34
Kleť	5	Rýchory	35
Košetice, EMEP station	8	Sedlec, Mikulov	36
Liberec, Ještěd	13	Svratouch	49
		Šerlich	39

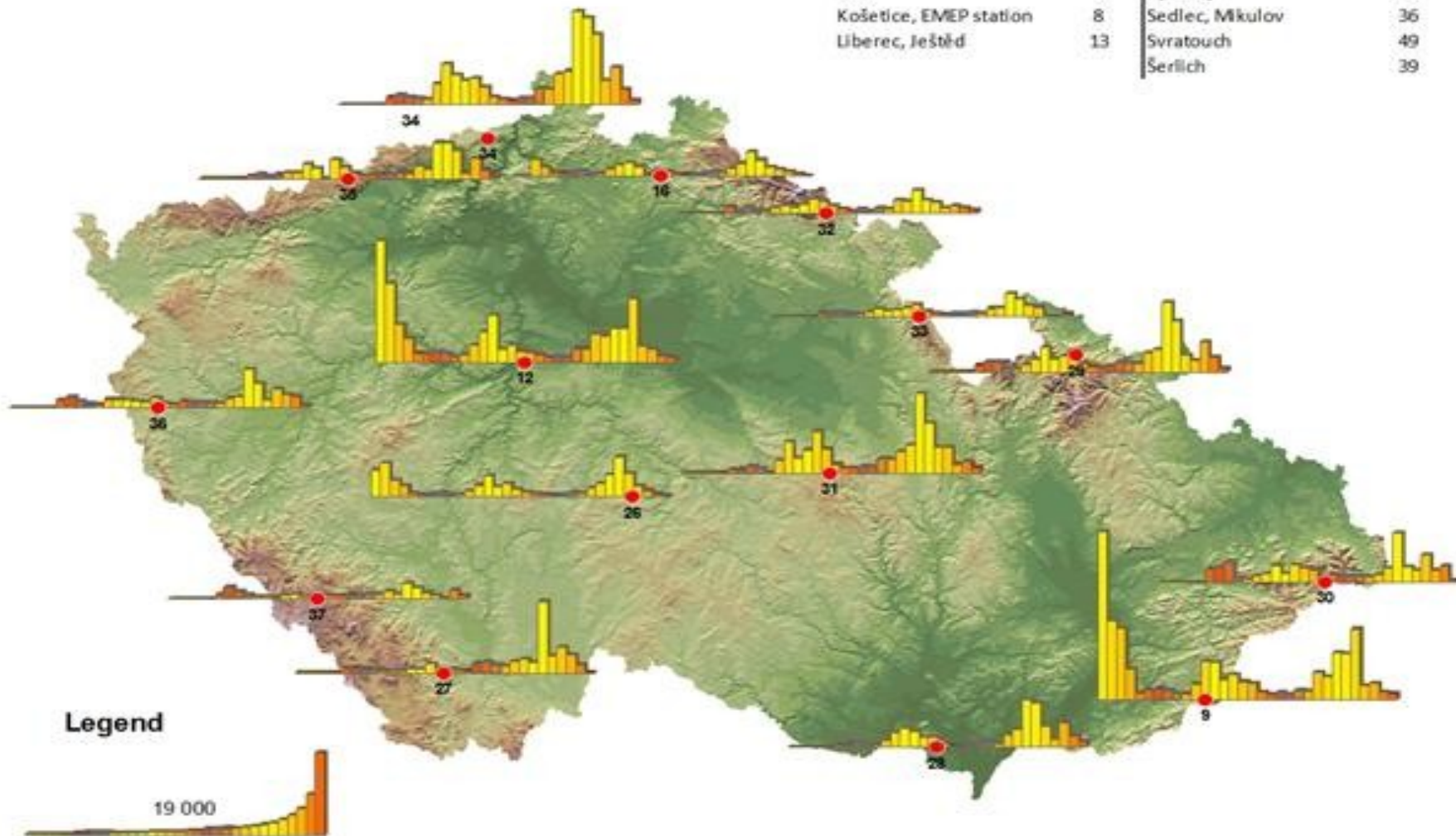

Regional strategy for information gathering

A **regional organisation group** will be established in each region to be responsible for implementing the global guidance document and the Global Monitoring Plan implementation plan within that region, taking into account regional realities.

The duties of the regional organisation groups would include

- identifying where **existing suitable monitoring data** are and are not available,
- developing a **regional strategy** for implementation of the GMP,
- establishing regional, sub-regional and inter-regional **monitoring networks,**
- **coordinating** sampling and analytical arrangements,
- ensuring compliance with protocols for **QA/QC,**
- data **archiving** and accessibility,
- maintaining the interaction with other **regional organization groups,**
- developing elements to encourage **capacity building,**
- preparing **regional reports**

Central and Eastern European Network 2006-2008

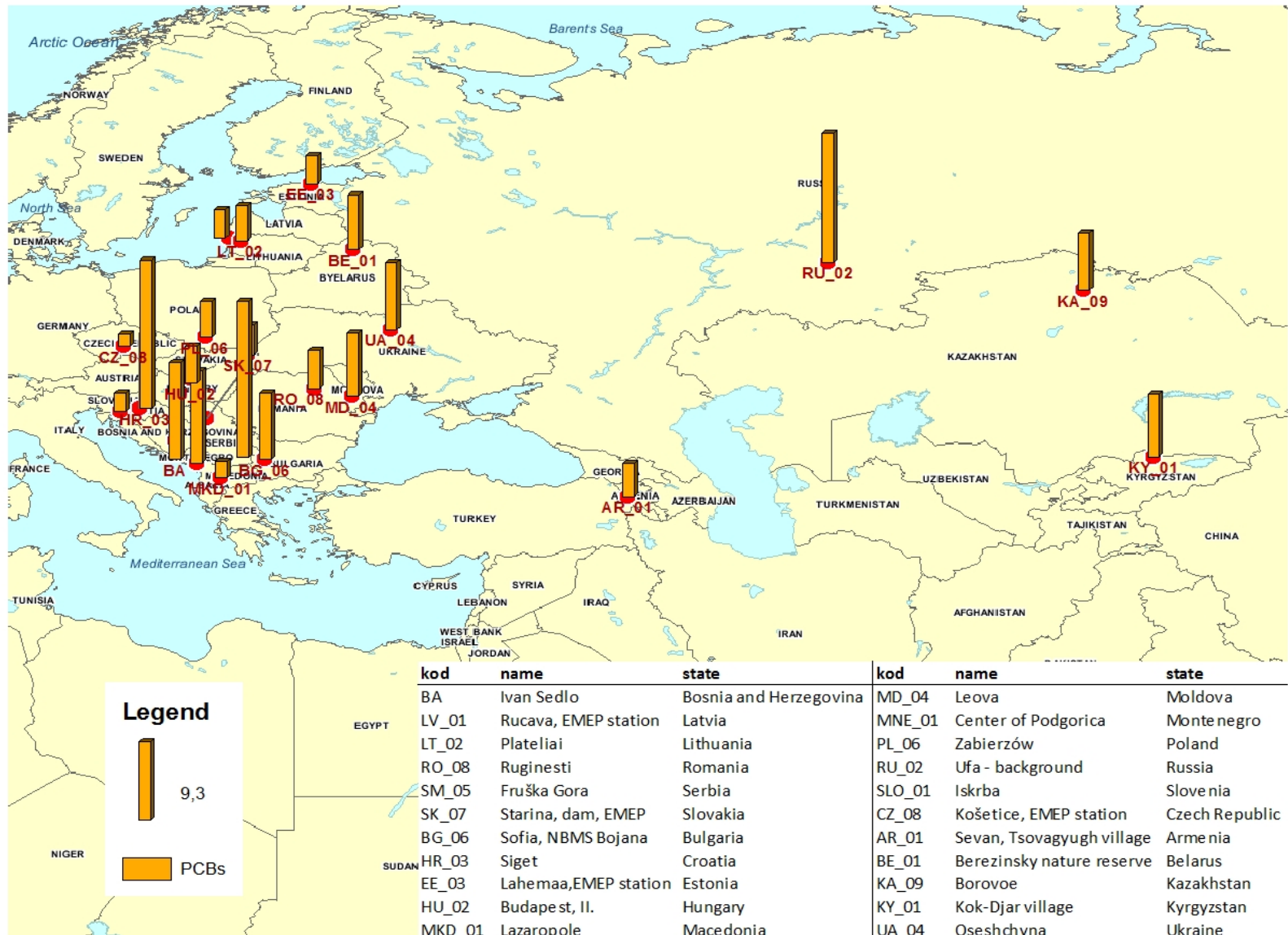

Klanova, J., Cupr, P., Holoubek, I., Borůvková, J., Příbylová, P., Kareš, R., Kohoutek, J.: Application of passive sampler for monitoring of POPs in ambient air. V. Pilot study for development of the monitoring network in the Central and Eastern Europe (MONET_CEEC 2007), 2008. Masarykova Univerzita, Brno, Czech Republic. ISBN 978-80-210-4697-9

Central and Eastern Europe, Africa, Fiji

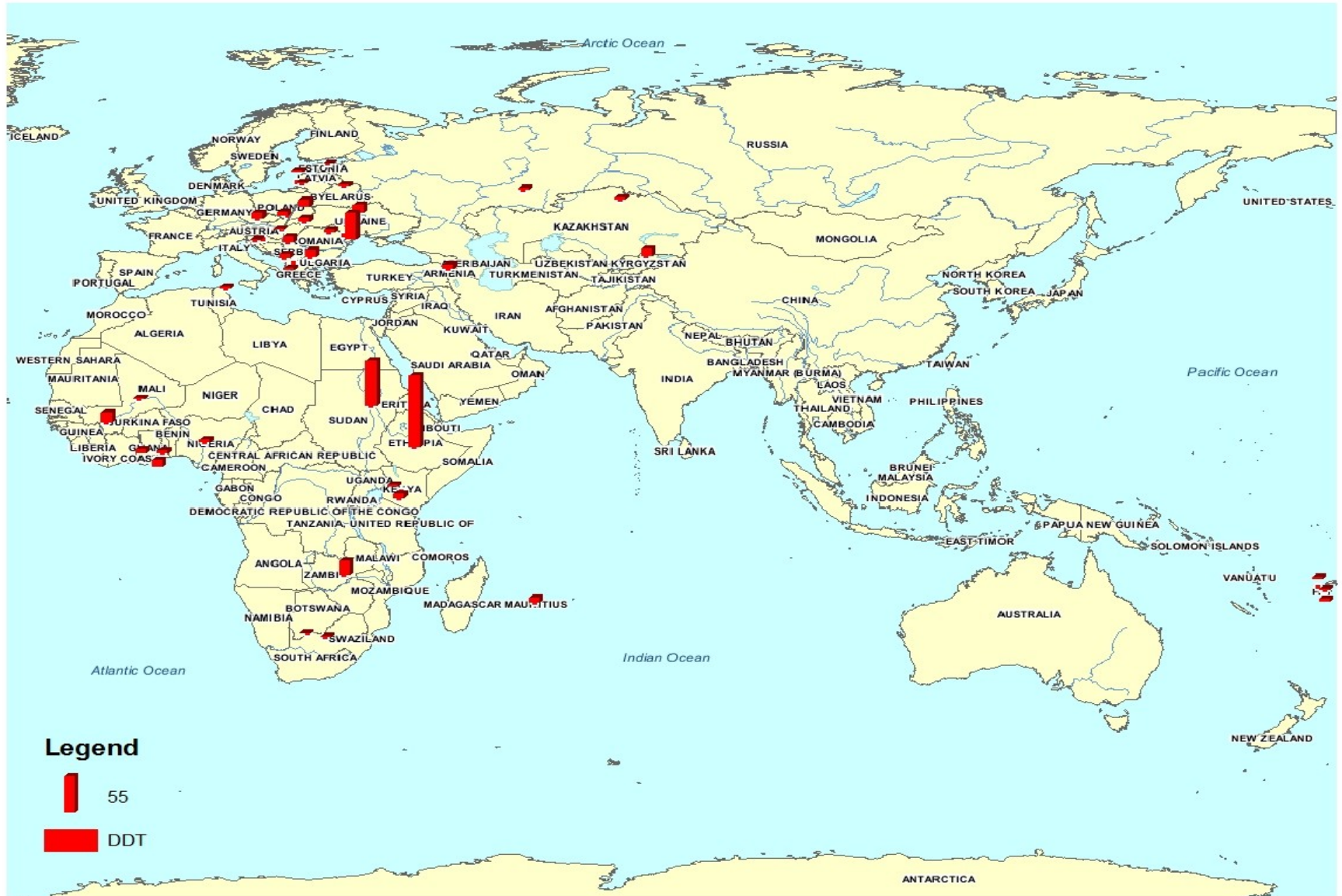

Global Passive Air Sampling Programs

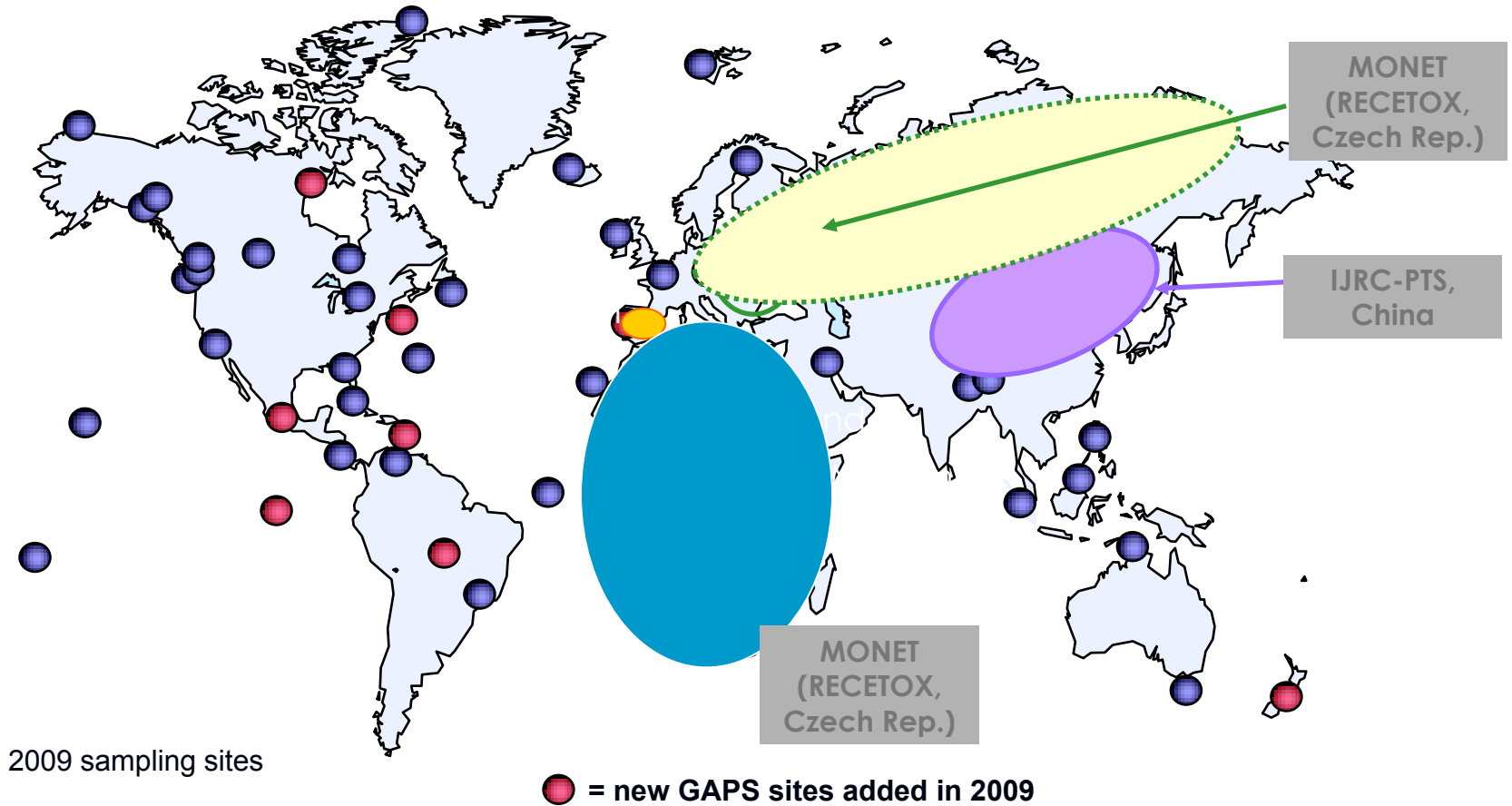

GMP Report on the first phase of the Effectiveness Evaluation of the Stockholm Convention: Conclusions and Recommendations.

Long-range transport

- *The coordination group concluded that **knowledge on long-range transport was key to assessing changes in POPs levels over time** and to assess the effectiveness of the Convention.*
- *A plan or process **to develop a coordinated cross-regional approach to assess long-range transport is needed.***
- *Long-range transport is also **linked to variable climate and meteorology.***

GMP Report on the first phase of the Effectiveness Evaluation of the Stockholm Convention: Conclusions and Recommendations.

Comparability issues

- *To interpret POPs concentrations in air, it was required that programs would remain consistent in their methods over time and thus **ensure that the data collected within a program remained comparable and thus suitable for assessing changes in levels over time.***
- *It was **noted that it would be very difficult to achieve comparability between various programs due to many sources of variability** including the use of different laboratories, different sampling methods or analytical protocols.*

GMP Report on the first phase of the Effectiveness Evaluation of the Stockholm Convention: Conclusions and Recommendations.

New POPs

*When the Conference of the Parties decides to add new substances to the Annexes of the Convention, it would be necessary to include those new POPs into the effectiveness evaluations and **monitoring of those {new} POPs would have to be initiated as soon as possible so that effective baselines could be established.** The inclusion of additional POPs would be likely to require modification or amendments to the current guidelines for global monitoring and the implementation plan. Meeting such requirements would undoubtedly increase the cost of the monitoring programs.*

Future of Global Air Monitoring” – Workshop Summary (TF HTAP Workshop)



March 31st, 2009, St. Petersburg, Russia.

The timing of the workshop coincided well with the recently completed first implementation of the Global Monitoring Plan, a mechanism for the effectiveness evaluation (EE) of the SC.

Expert opinion from this group on several issues that were agreed to be relevant to the future of global air monitoring was summarized.

- 1. Data comparability issues.**
- 2. Particle-bound compounds.**
- 3. New POPs.**
- 4. LRT, climate variability and meteorological variability.**
- 5. Existing and new air programs.**
- 6. Data Availability.**



Data comparability issues.

- **within-program comparability is crucial for producing reliable temporal trends .**
- **intercomparison exercises and improving comparability between programs (overlaps)**
- **passive vs active air sampling (co-location of passive/active at one site in each region)**
- **selection of common/comparable reporting format**

Temporal variations of PAH concentrations in air, Kosetice observatory, 1996-2005

PAHs in Ambient Air - Košetice 1996-2008
Weekly Sampling

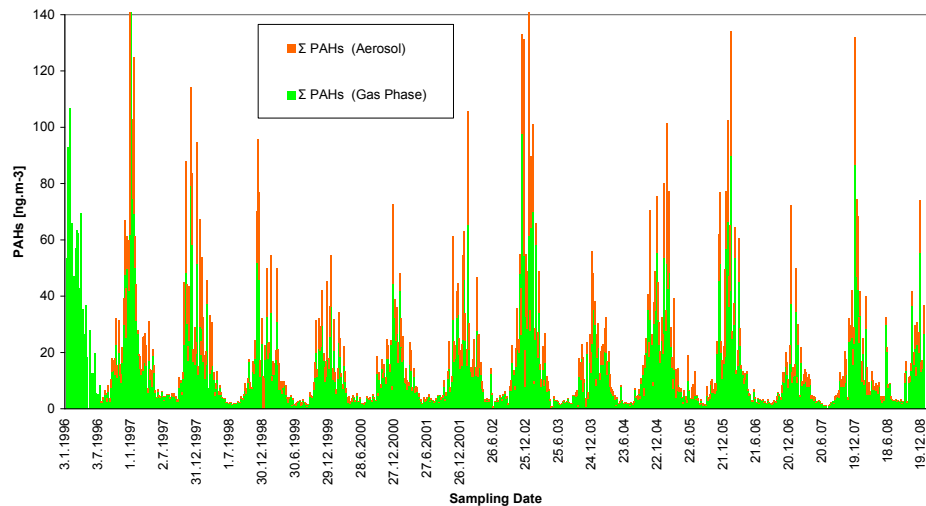

PAS - PAHs

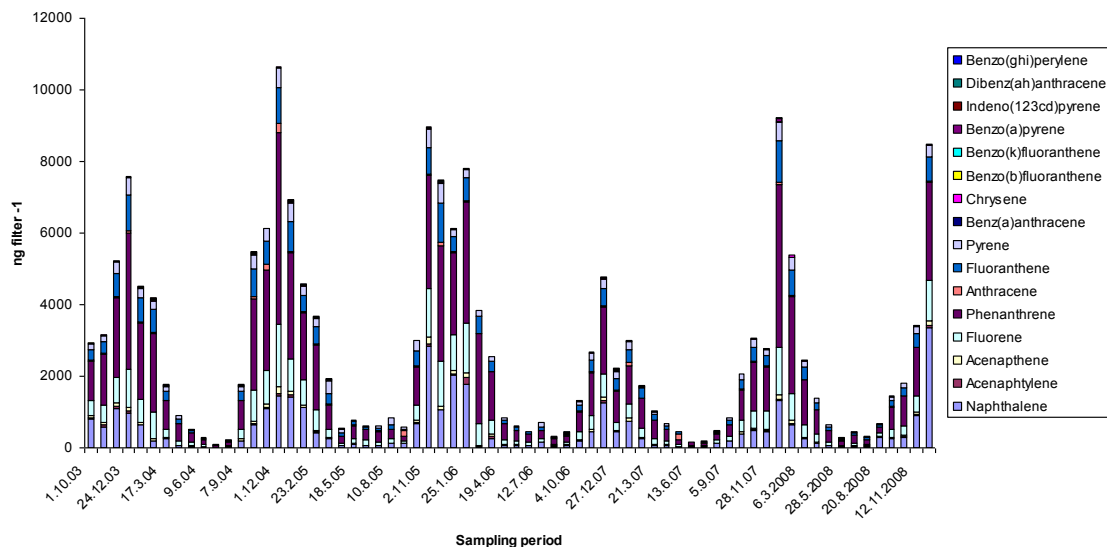



Particle-bound compounds

Difficulties exist in interpreting passive sampler data for chemicals that partition between gas and particles (e.g. high molecular weight components of: PAHs, PCDD/Fs, and BFRs). So far, the air monitoring of such chemicals requires active air sampling techniques.

Although some groups have begun to investigate particle-phase sampling by PAS, this is an area that requires further study.

Seasonal variability of the **sampling rates** ($\text{m}^3 \text{day}^{-1}$) for selected compounds in 5 years.

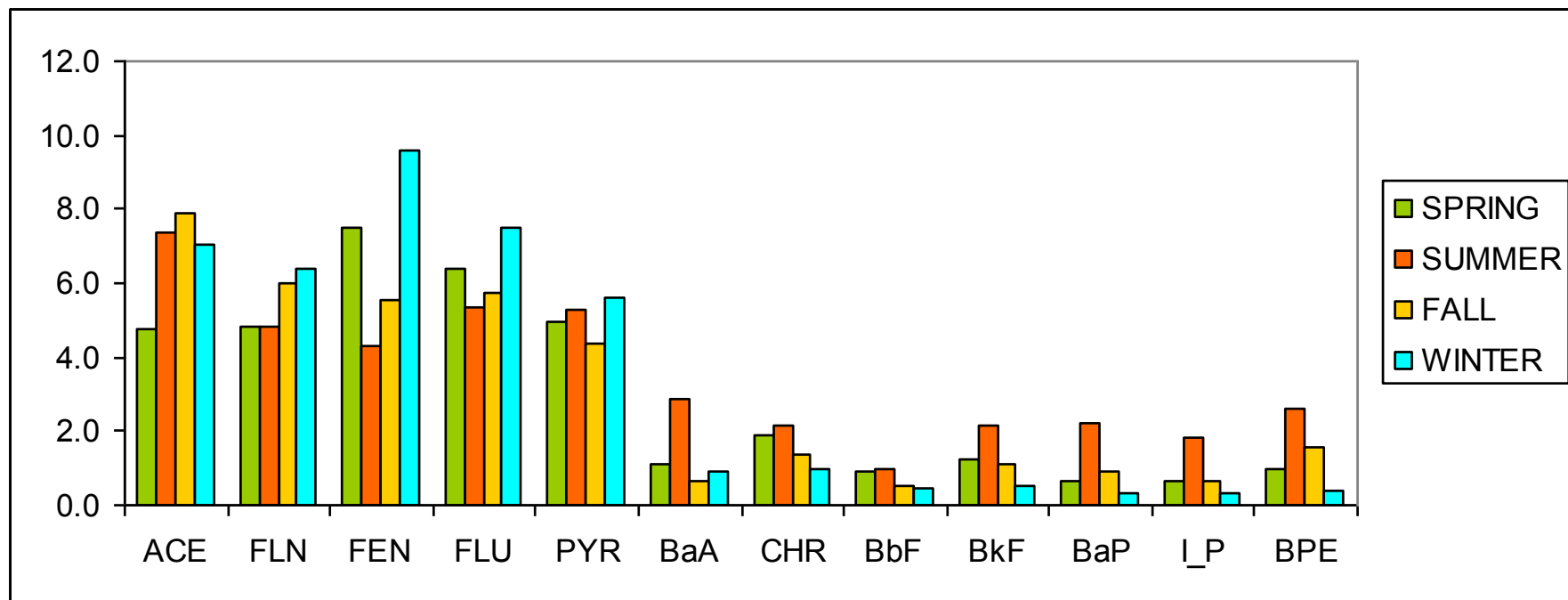

Klanova, J., Čupr, P., Kohoutek, J., Harner, T., 2008. Assessing the influence of meteorological parameters on the performance of polyurethane foam-based passive air samplers. ES&T 42, 550-555.



New POPs

It was recognized that in the near future new POPs maybe added to the existing POPs listed under the SC on POPs and CLRTAP POPs protocol. This will add to air monitoring obligations and challenges of existing programs.



Long range transport, climate variability and meteorological variability

Understanding data is more important than just reporting levels and trends, especially for the purpose of assessing effectiveness of regulatory efforts on POPs.

It is important to develop tools (e.g. back trajectory techniques, multimedia and transport models and investigations of meteorological and climate variability) to better interpret monitoring data.

Analysis of the back trajectories

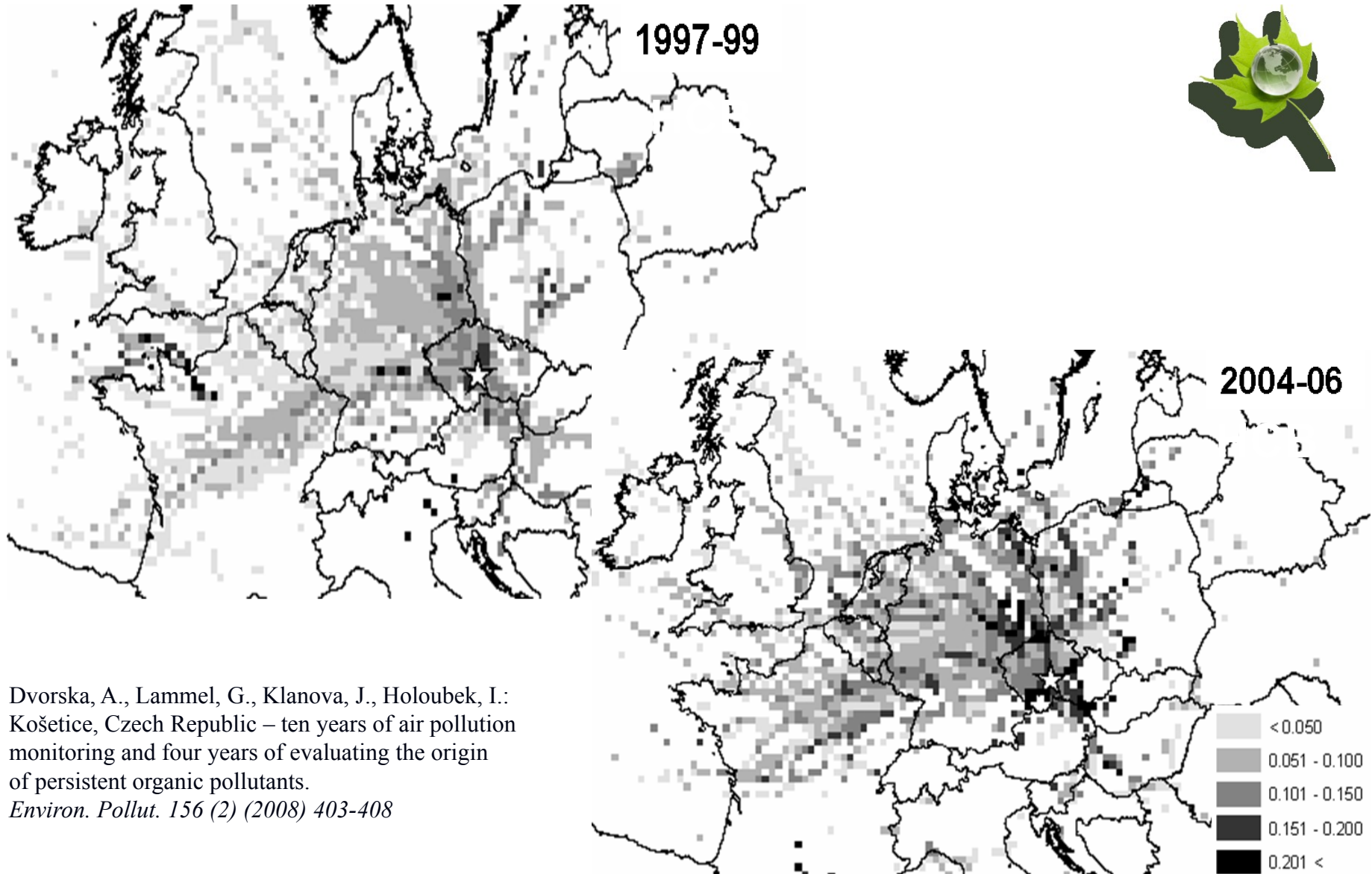

Dvorska, A., Lammel, G., Klanova, J., Holoubek, I.:
Košetice, Czech Republic – ten years of air pollution
monitoring and four years of evaluating the origin
of persistent organic pollutants.

Environ. Pollut. 156 (2) (2008) 403-408

Long term temporal trends of soil concentrations result of simulation and measured soil concentrations

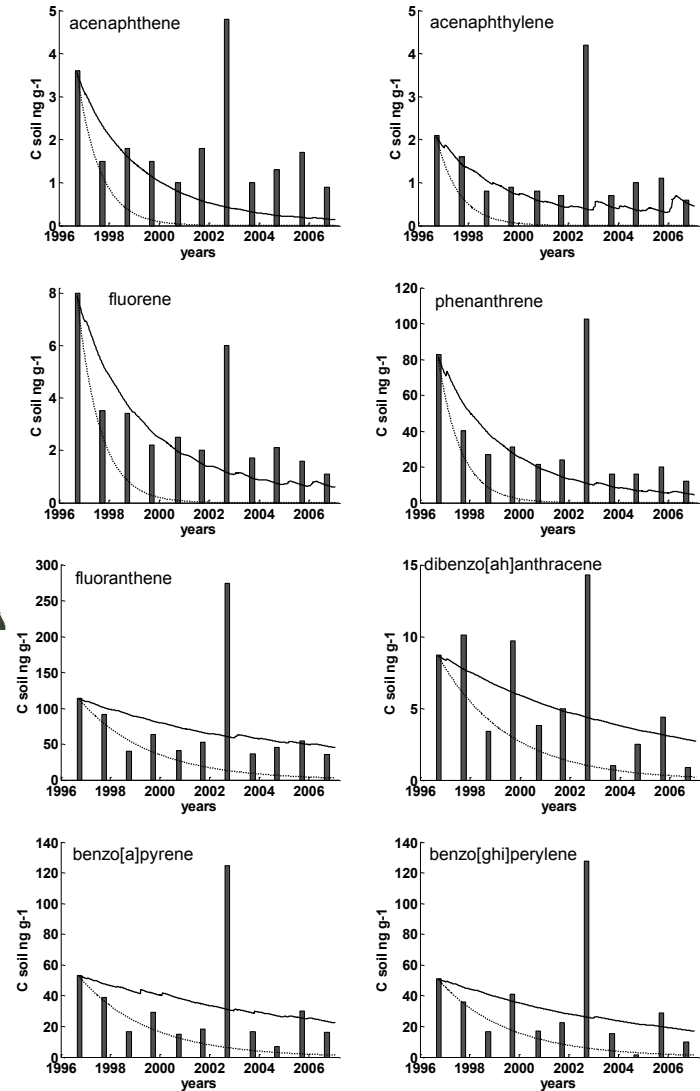
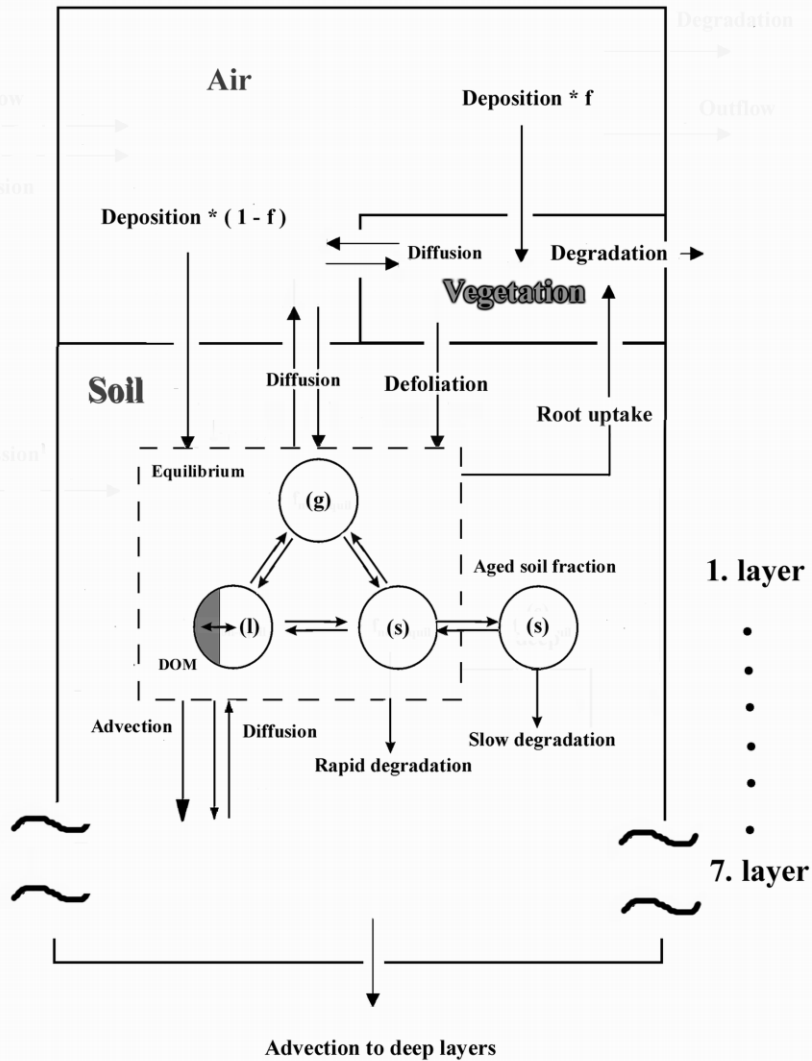

GIS based models (1x1 km) of various parameters

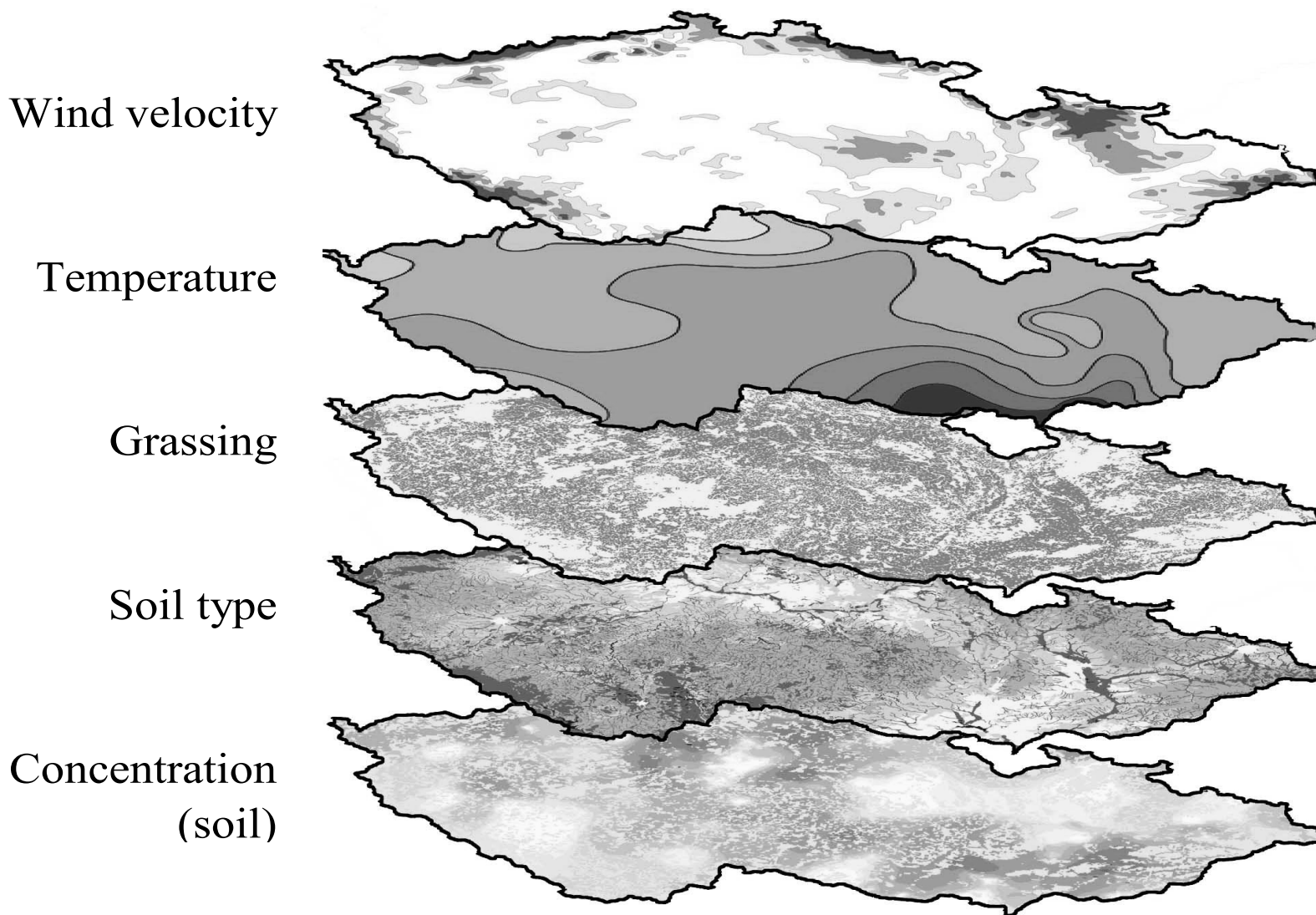



Existing and new air programs

To help ensure long term sustainability and comparability of results, it is recommended that new programs grow from strategic partnerships with existing programs, and benefit from their experiences.

Training visits for the purpose of capacity building/technology transfer are encouraged and should be supported.

Central and Eastern Europe, Africa, Fiji

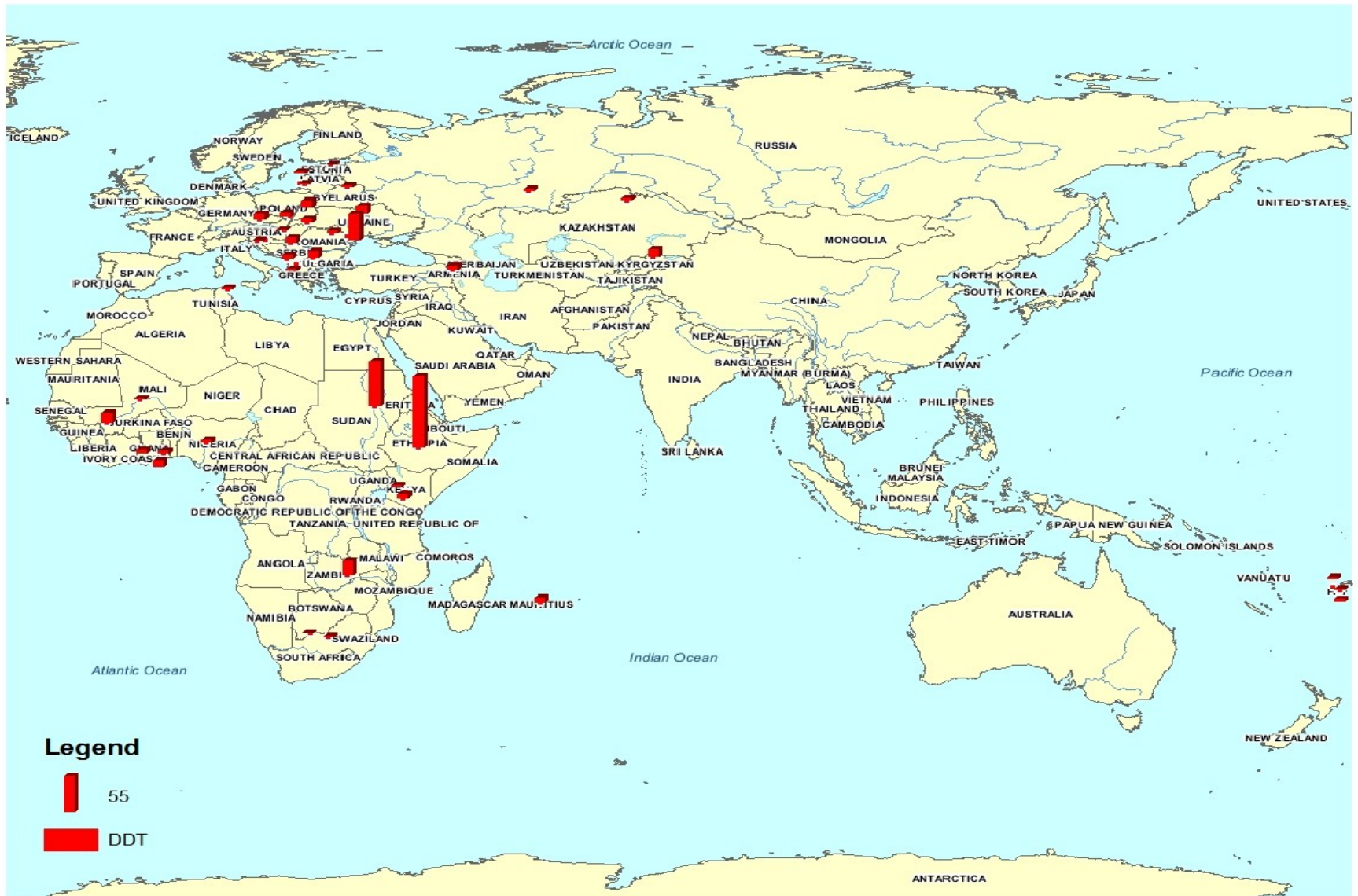



Data Availability

The group agreed that better access to data would be useful for several purposes e.g. model development.

Existing and new programs are strongly encouraged to incorporate data management in their programs, i.e. employ sustainable databases.

Consideration should be given to the most suitable format and interface for end users of the data e.g. modelers.

European PAS Network

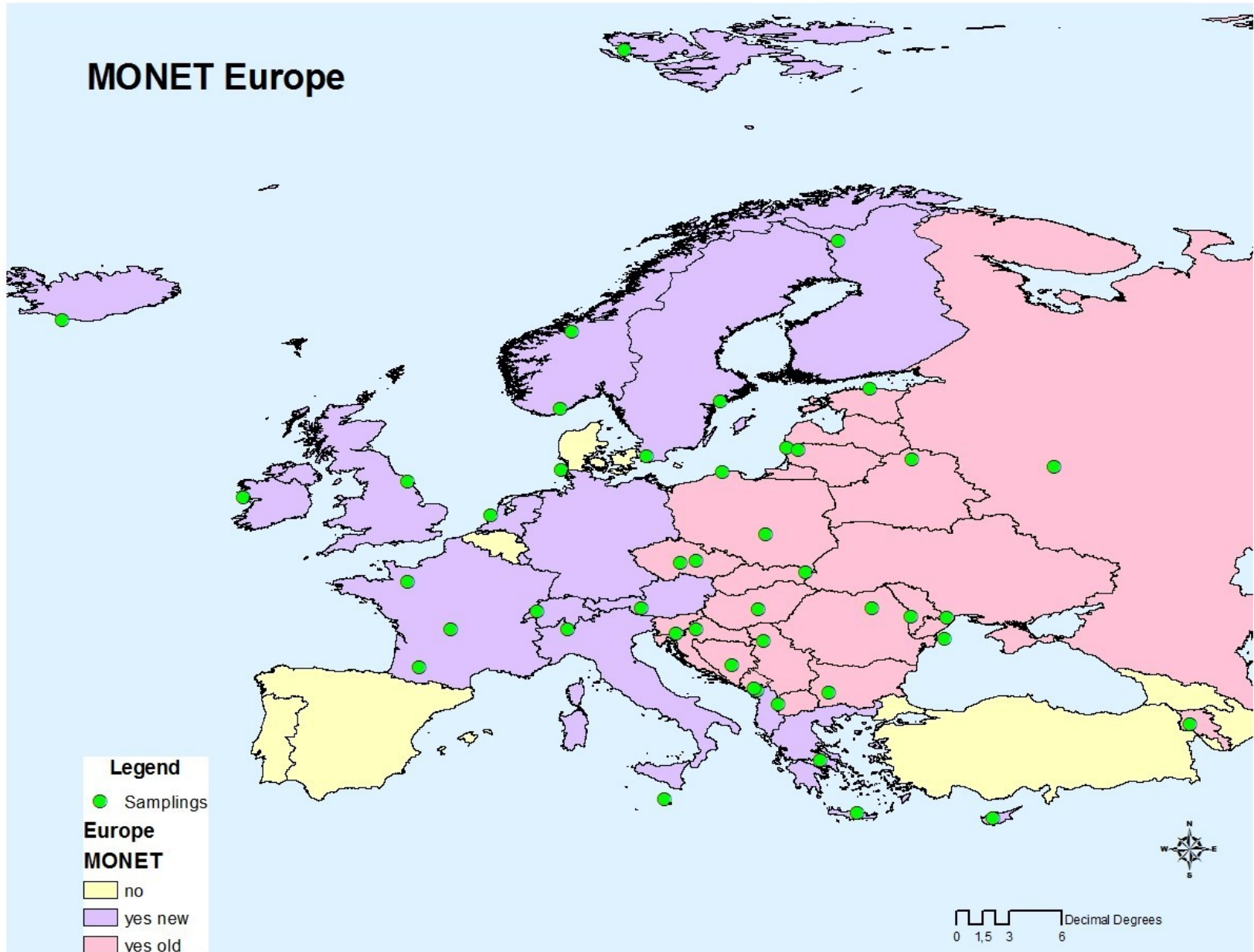



Description of more than one site

GENESIS - Mozilla Firefox
http://genesis.recetox.muni.cz

Description of sites

Matrix: Freshwater
Compounds: PAHs
Region: Czech Republic
Time: 1988 - 2007
Map selection: Active
Selection: N=35

Analytical tools

- Σ
- Bar chart
- Network
- Bar chart
- Network
- Chemical structures
- Chemical structures
- 3D model

Sites overview

Number of sites: 35
Number of samples: 386
Sampling networks - Monet: 35 / 386

Sites stratification

15% Rural bcg.
18% Urban bcg.
21% Mountain bcg.
46% Contaminated

Altitude

Altitude (m above sea level)

Geographical position

Košetice, EMEP station
zemědělské oblasti s přirozenou vegetací
Zobrazit měření

Permalink: -703523.31253, -1106669.98560

Table with number of samples

List of selected sites | Report | Help

- Description of sites set includes:
- Number of sites and samplings and their affiliation to monitoring networks. Display of a table with sites list is also possible.
- Range of samplings in individual years
- Map with position (interactive map with options of zoom and turning on/off different layers)
- Distribution of sites altitude