

# SACHARIDY

Sacharidy - *saccharum* - *cukr*

**Synonyma** : cukry - glycidy - uhlohydráty *carbohydrates* -  $(\text{CH}_2\text{O})_n$

**Funkce** - zdroj energie  
zásobní látky  
stavební a podpůrná funkce  
složky nukleotidů, koenzymů, glyko-proteinů, -lipidů  
prekurzory aminokyselin, lipidů  
antigenní determinanty buněk

MONOSACHARIDY



DI, TRI, .....OLIGOSACHARIDY



POLYSACHARIDY

**Monosacharidy :**

chemicky - polyhydroxyaldehydy

- polyhydroxyketony

## Rozdělení

A. podle povahy karbonylové skupiny

- ALDOSY
- KETOSY

B. podle počtu uhlíkových atomů - TRIOSY, TETROSY,  
PENTOSY, HEXOSY, HEPTOSY,

ALDOHEXOSA



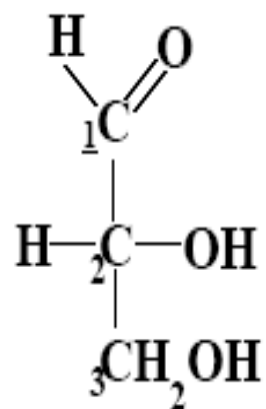

**D - glyceraldehyd**

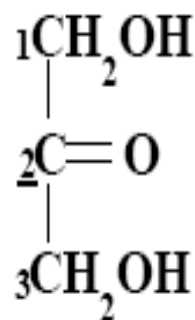

**dihydroxyaceton**

**Názvosloví : triviální**

aldosa -OSA

ketosa -ULOSA

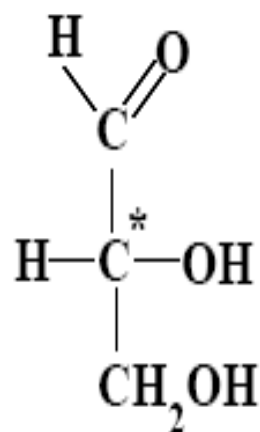

D - glyceraldehyd

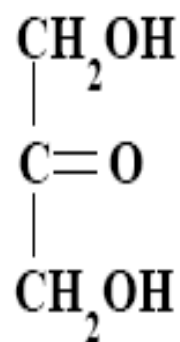

dihydroxyaceton

počet stereoizomerů =  $2^x$  (x = počet  $\text{C}^*$ )

aldosy -  $x = n - 2$

ketosy -  $x = n - 3$

n = počet C atomů

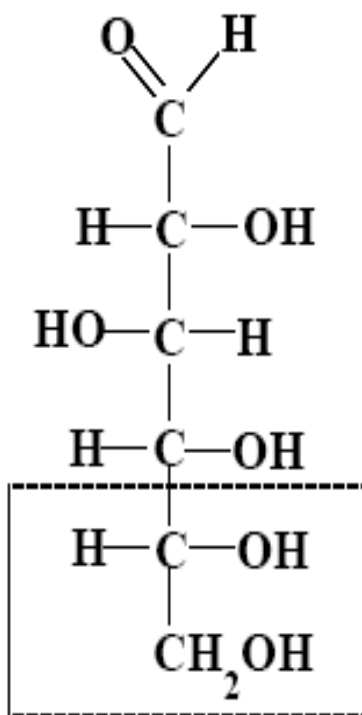

D - glukosa

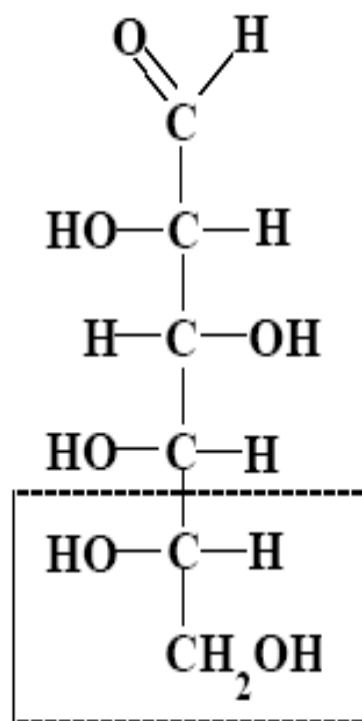

L - glukosa

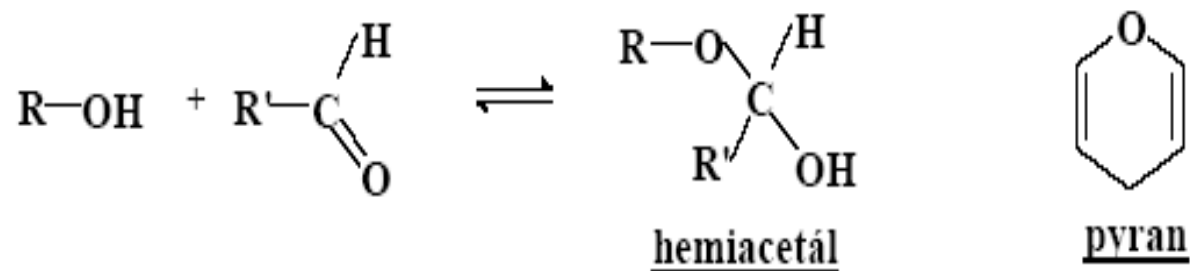

*Fischerovy vzorce*

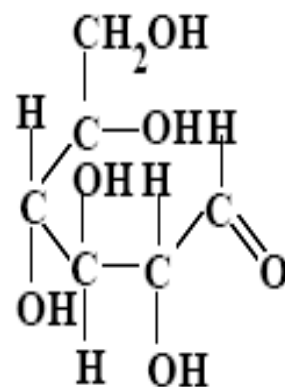
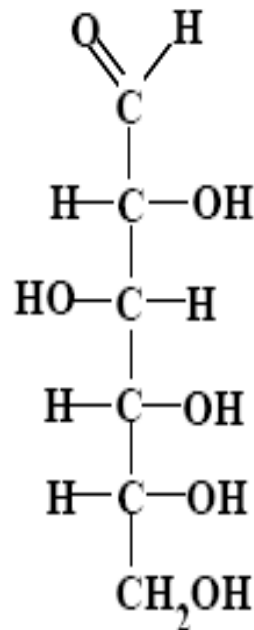

*Haworthovy vzorce*

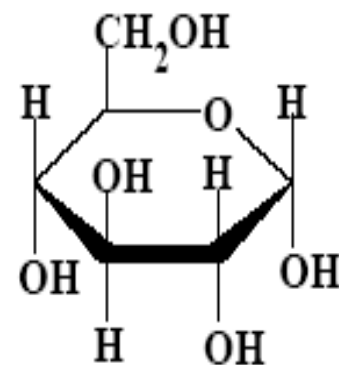

D-glukopyranosa





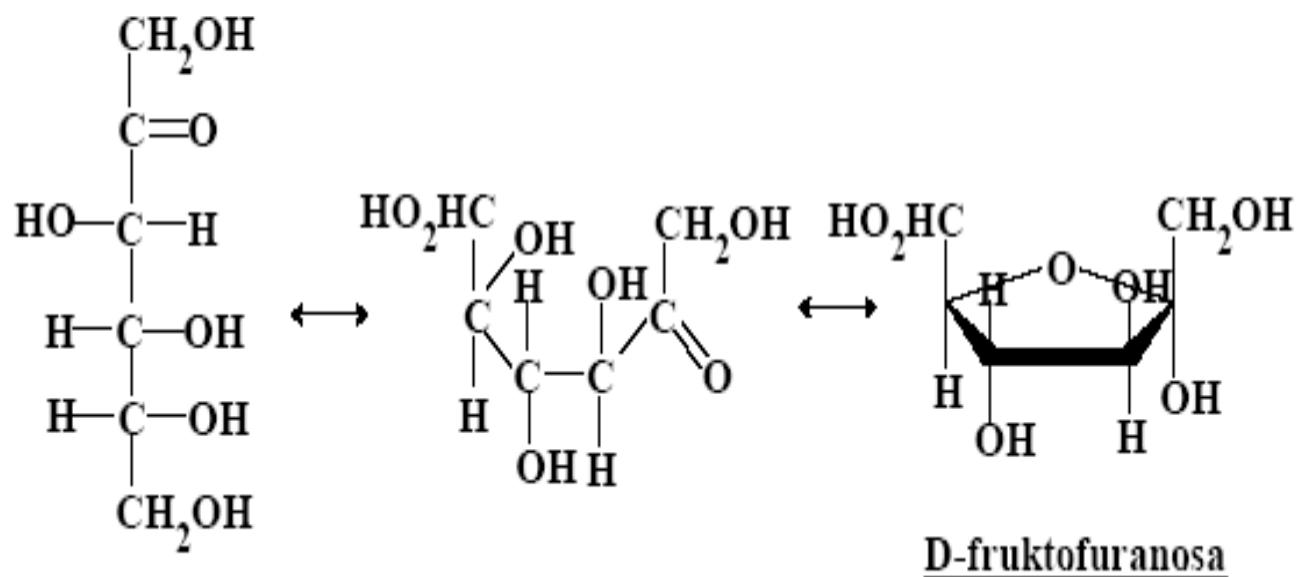
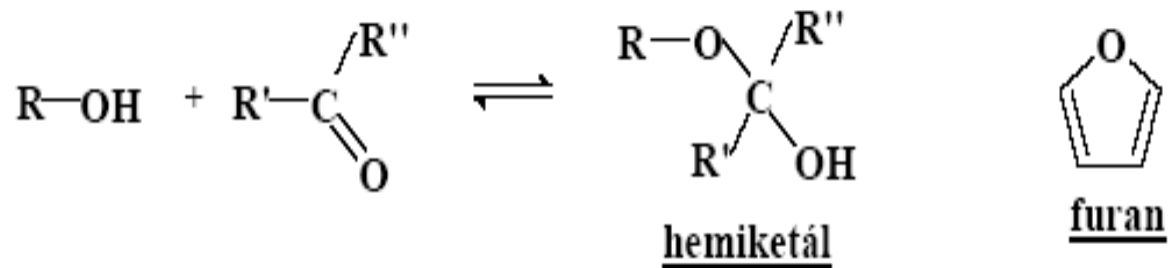

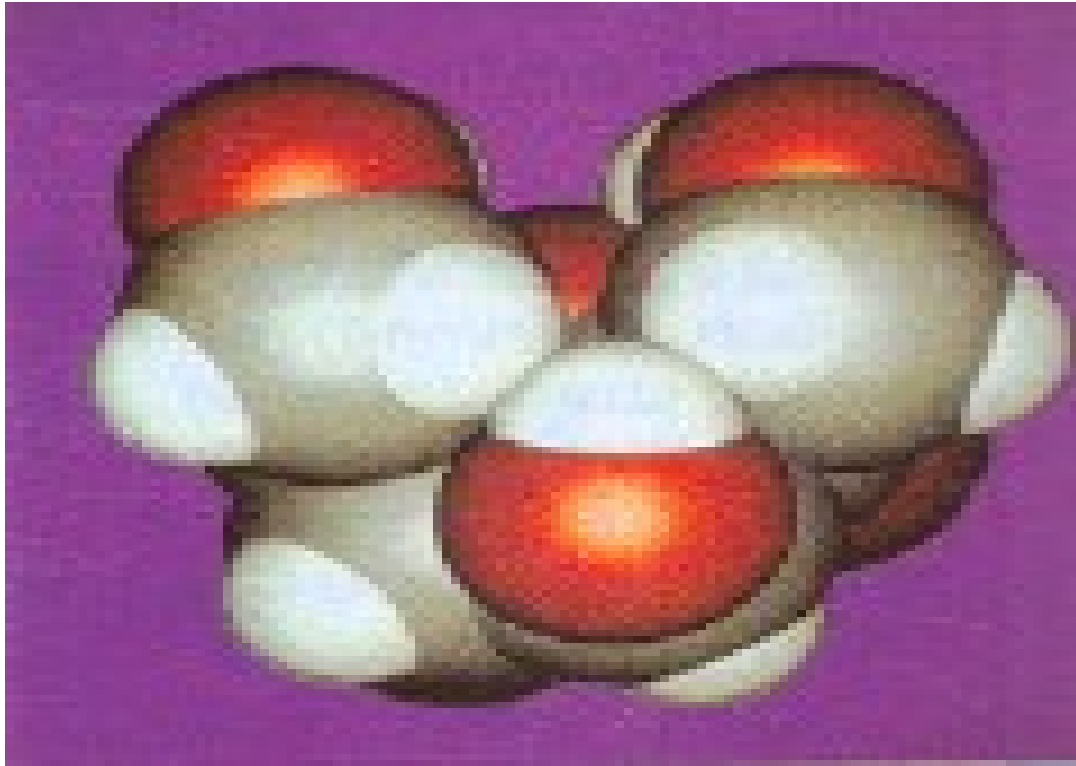

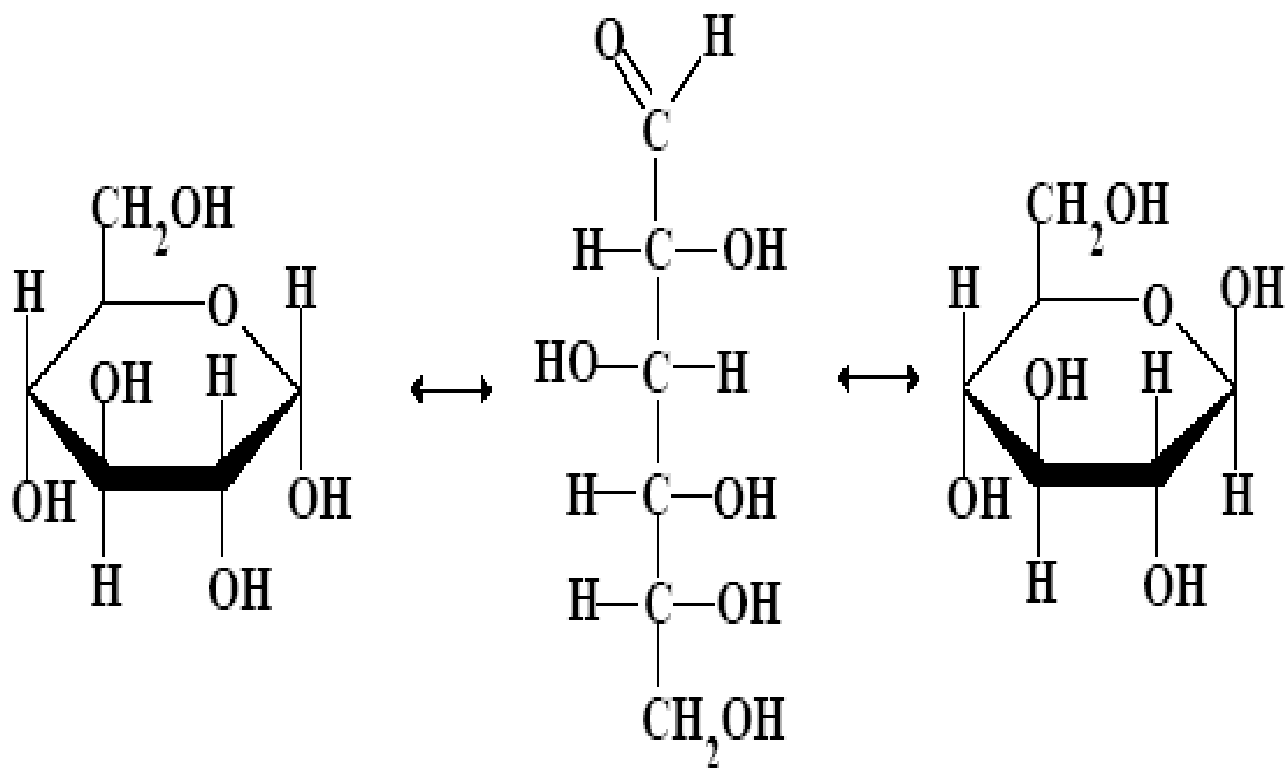

$\alpha$ -anomer (63 %)  $\longleftrightarrow$  MUTAROTACE  $\longleftrightarrow$   $\beta$ -anomer (36 %)

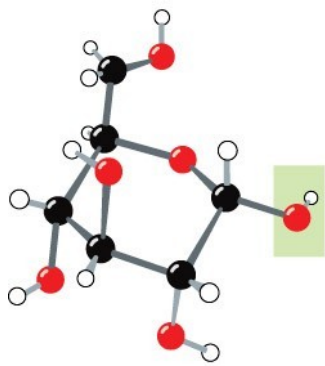

**$\alpha$ -D-Glucopyranose**

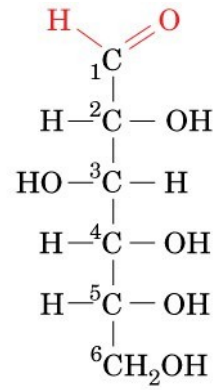
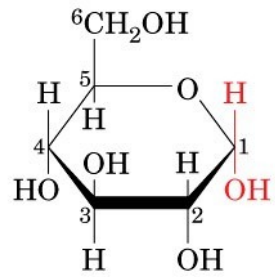

**D-Glucose  
(linear form)**

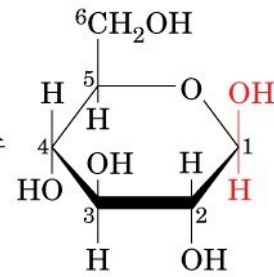

**$\beta$ -D-Glucopyranose**

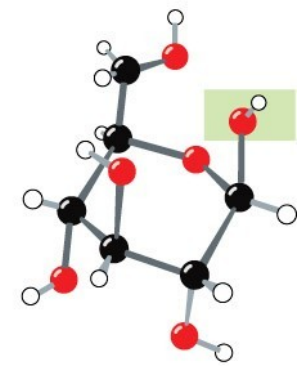

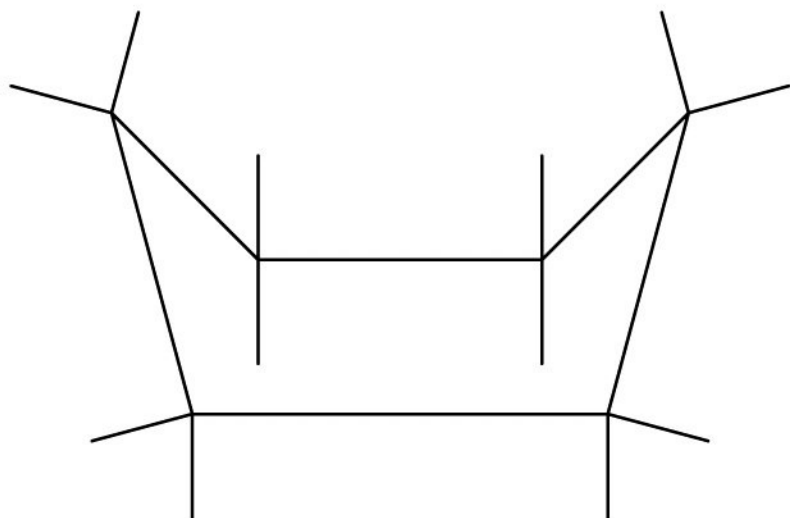

Boat

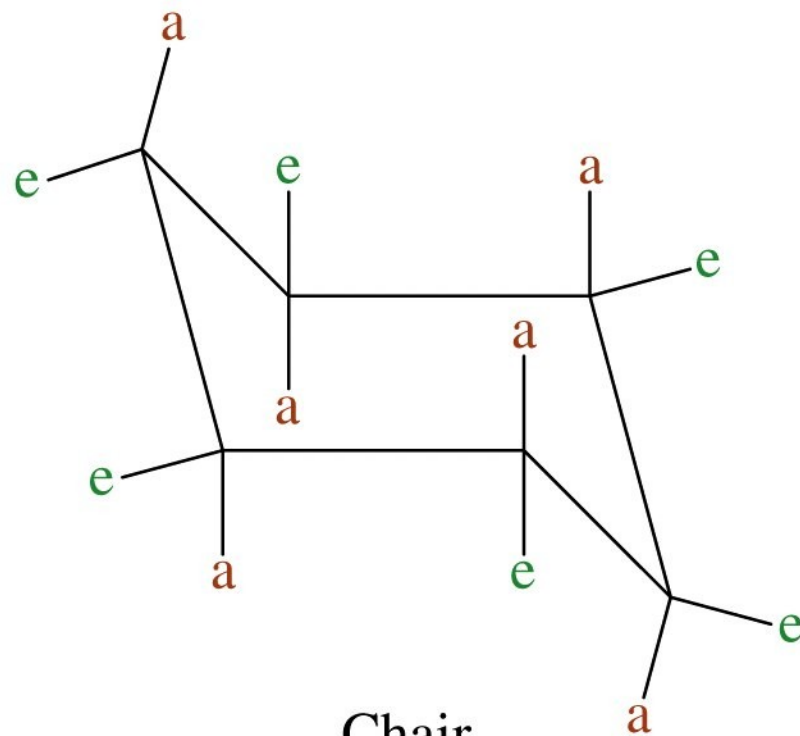

Chair

Figure 7-10a Concepts in Biochemistry, 3/e  
© 2006 John Wiley & Sons

## Přehled

Triosy - glycerinaldehyd, dihydroxyaceton

Tetrosy - threosa, erythrosa

Pentosy - ribosa, deoxyribosa

Hexosy - glukosa, manosa, galaktosa

fruktosa

Heptosa - sedoheptulosa

# Aldosy

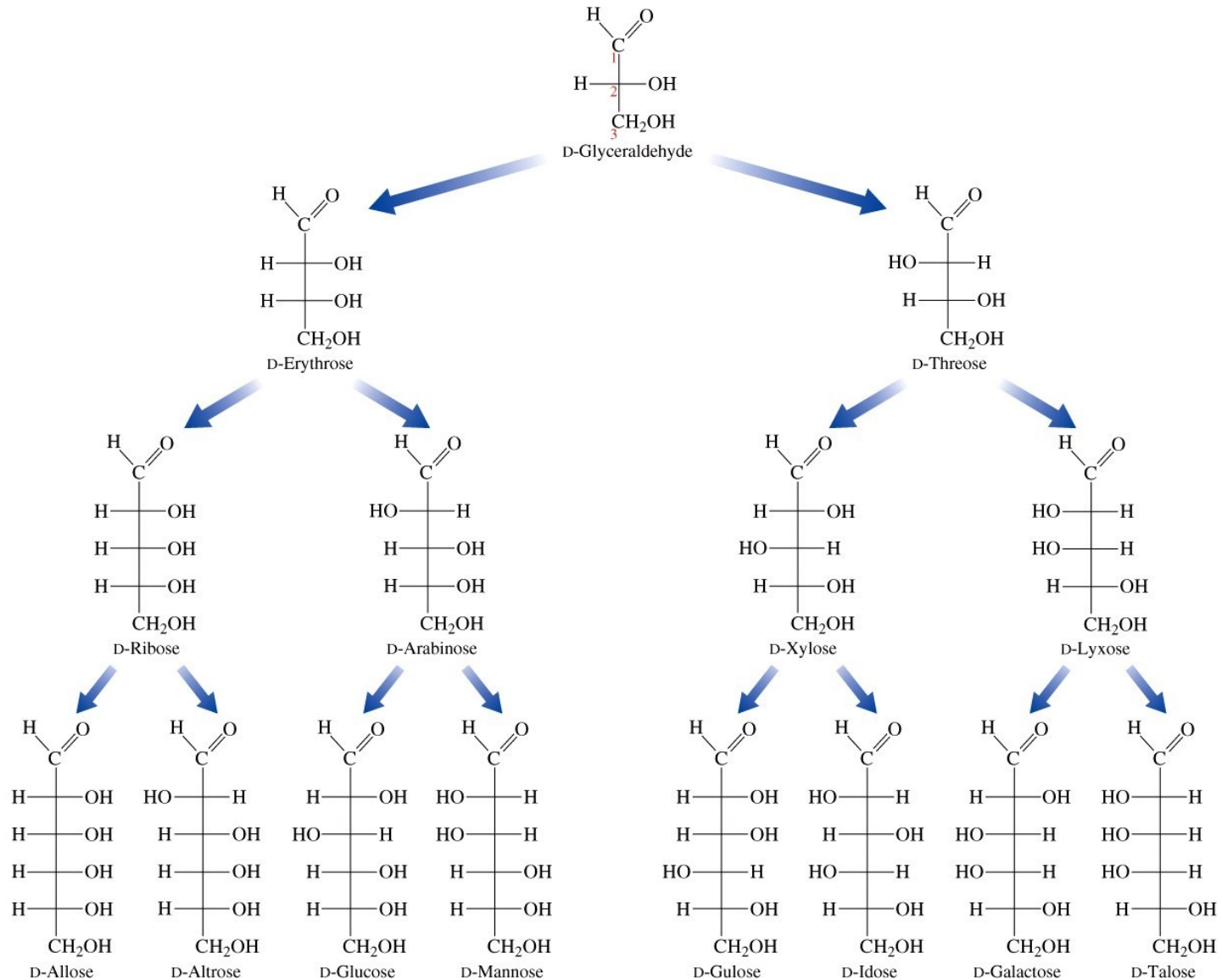

Figure 7-5 Concepts in Biochemistry, 3/e

# Ketose

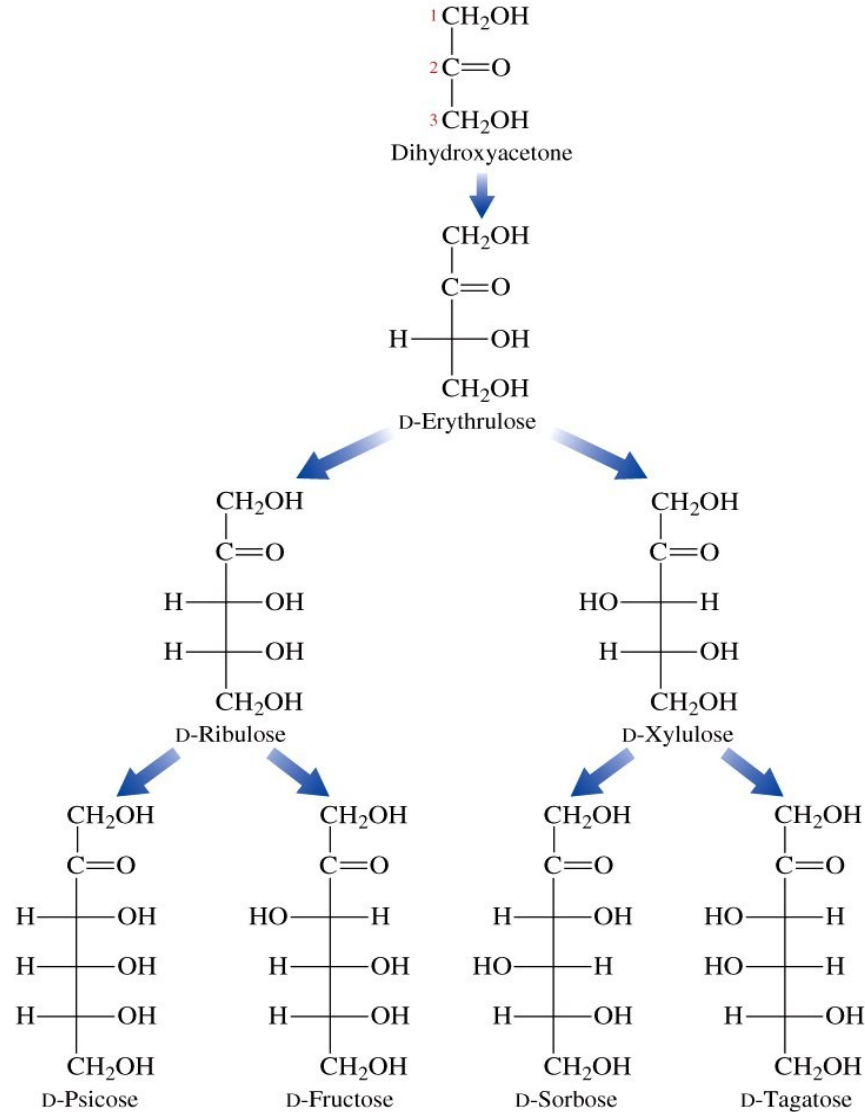

Figure 7-6a Concepts in Biochemistry, 3/e  
© 2006 John Wiley & Sons



## Deriváty monosacharidů

### Oxidace :

A. Mírná  $\Rightarrow$  aldehydická skupina  $\rightarrow$  karboxylovou skupinu

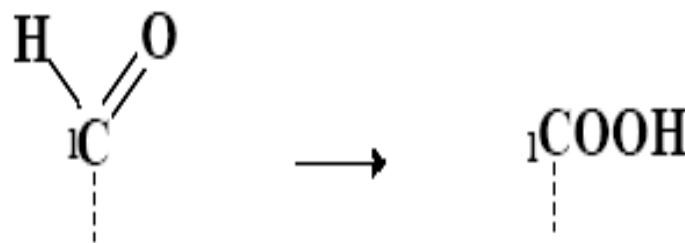

**ALDONOVÉ KYSELINY** - glukosa  $\rightarrow$  k. glukonová

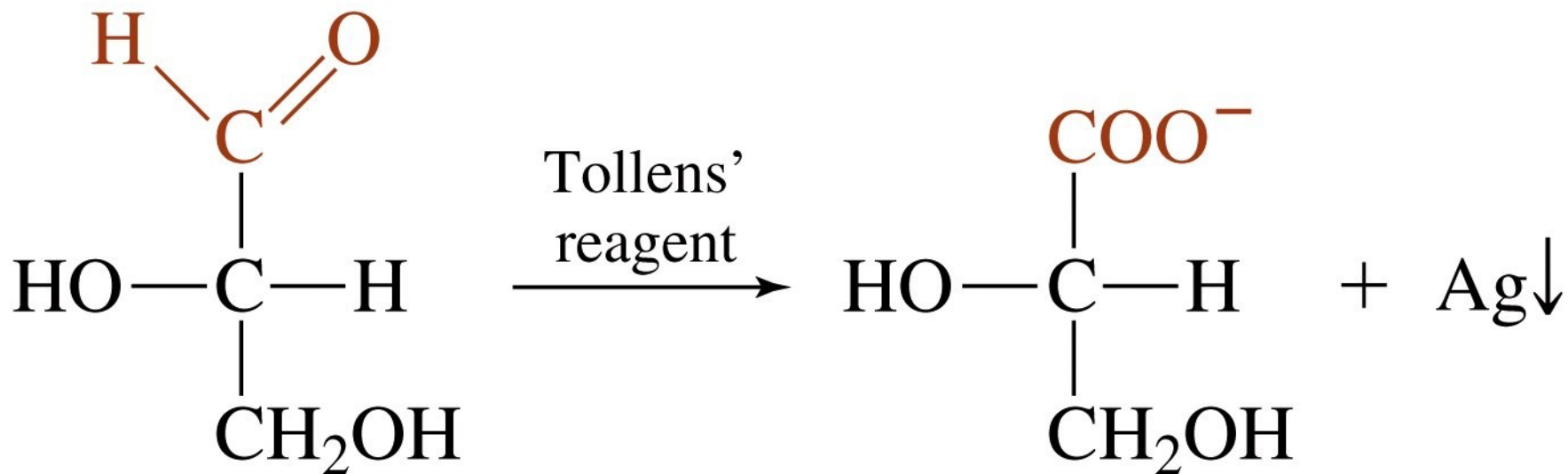

Figure 7-11a Concepts in Biochemistry, 3/e  
© 2006 John Wiley & Sons

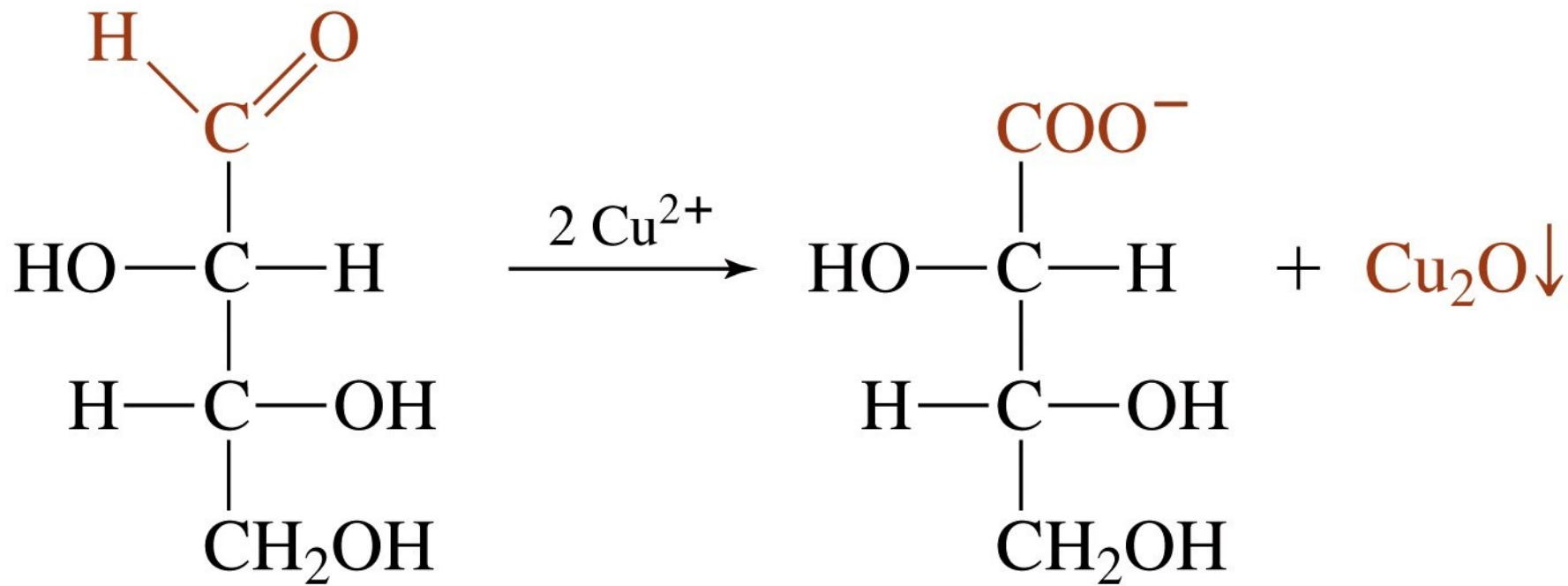

Figure 7-11b Concepts in Biochemistry, 3/e  
© 2006 John Wiley & Sons

B. Specifická  $\Rightarrow$  primární OH skupina  $\rightarrow$  karboxylovou skupinu



URONOVÉ KYSELINY - glukosa  $\rightarrow$  k. glukuronová

C. Silná  $\Rightarrow$  aldehydická skupina + primární OH skupina

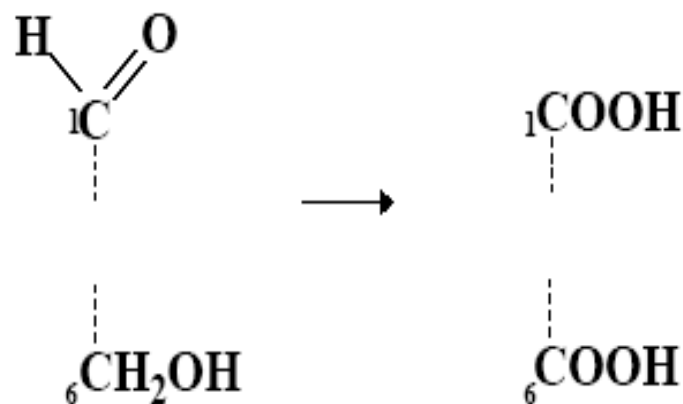

ALDAROVÉ KYSELINY - glukosa  $\rightarrow$  k. glukarová

## Tvorba laktonů u aldonových a uronových kyselin

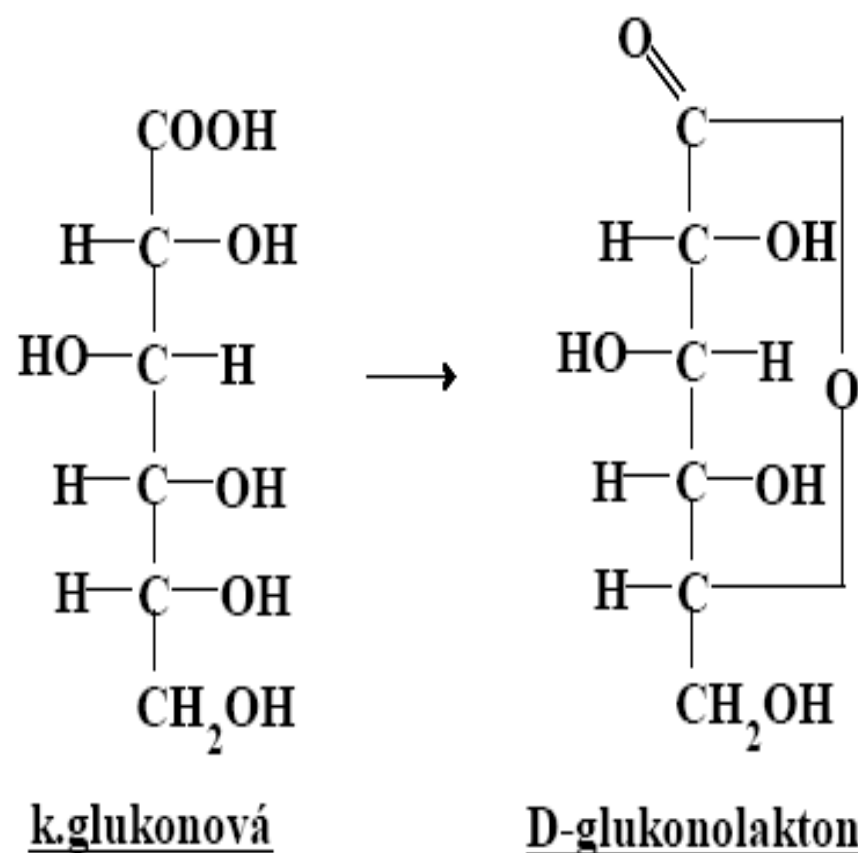

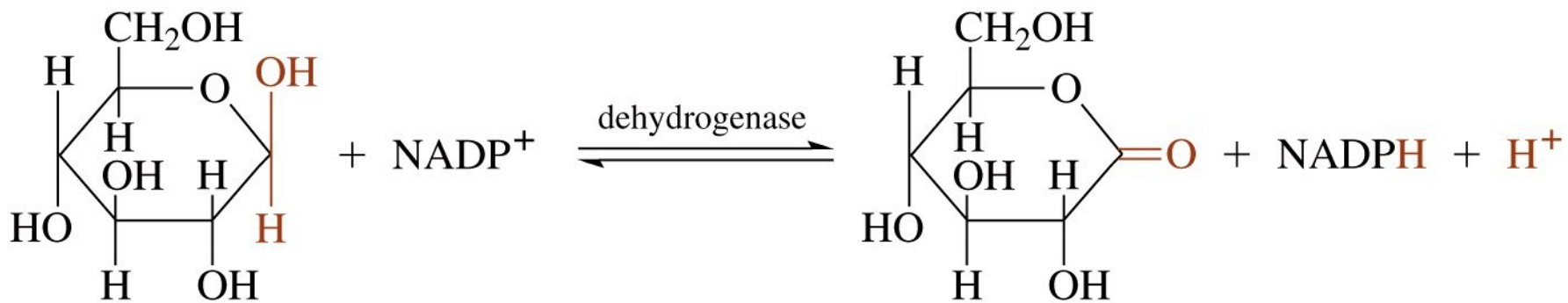
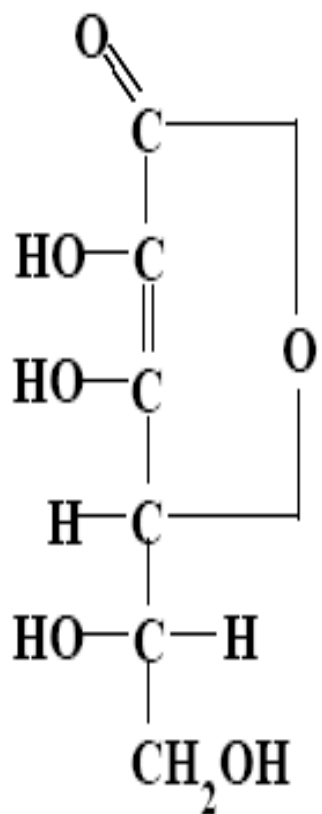
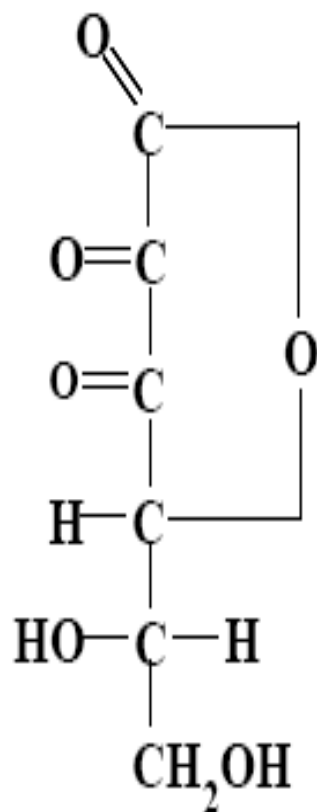
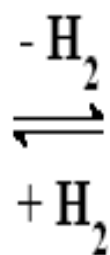

Figure 7-11c Concepts in Biochemistry, 3/e  
 © 2006 John Wiley & Sons



k. askorbová



k. dehydroaskorbová

## Redukce :

mírná  $\Rightarrow$  karbonylová skupina  $\rightarrow$  hydroxy skupinu

**POLYHYDROXYALKOHOLY - ALDITOLY -itol**

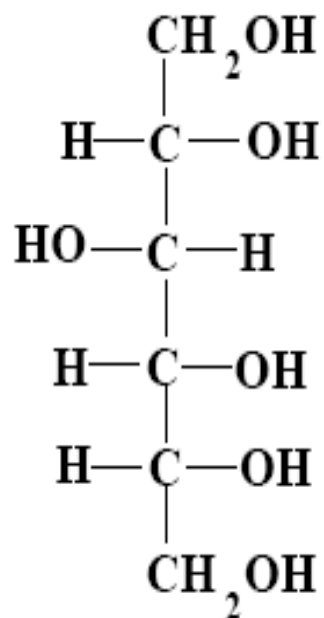

GLUCITOL - SORBITOL

Deoxycukry - OH skupina nahrazena H

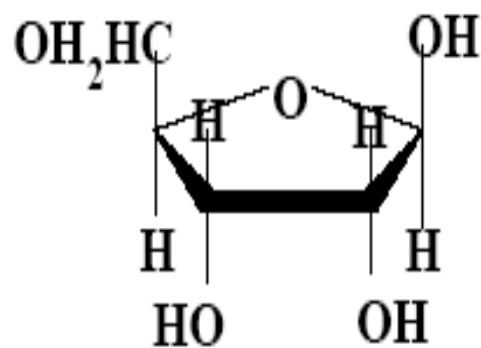

RIBOSA

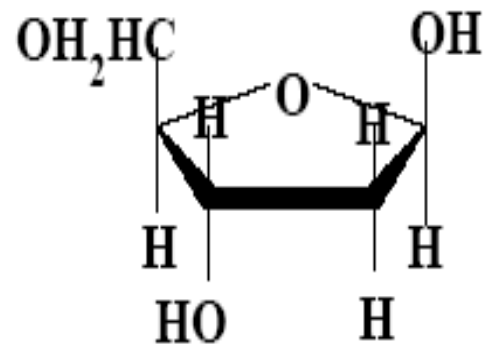

DEOXYRIBOSA



Aminocukry - OH skupina nahrazena NH<sub>2</sub> skupinou

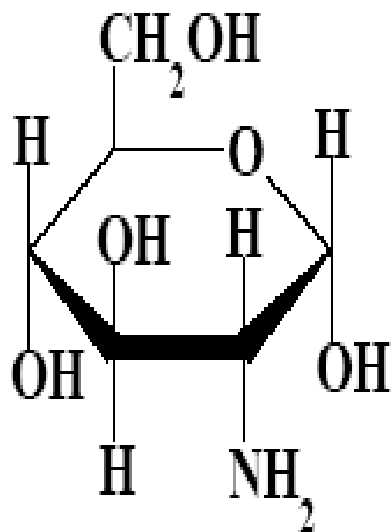

GLUKOSAMIN

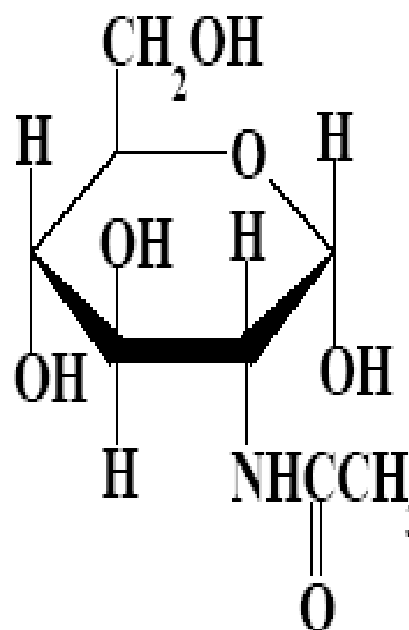

N-ACETYLGLUKOSAMIN

Sialové kyseliny - kondenzace N-acetylmanosaminu + pyruvátu

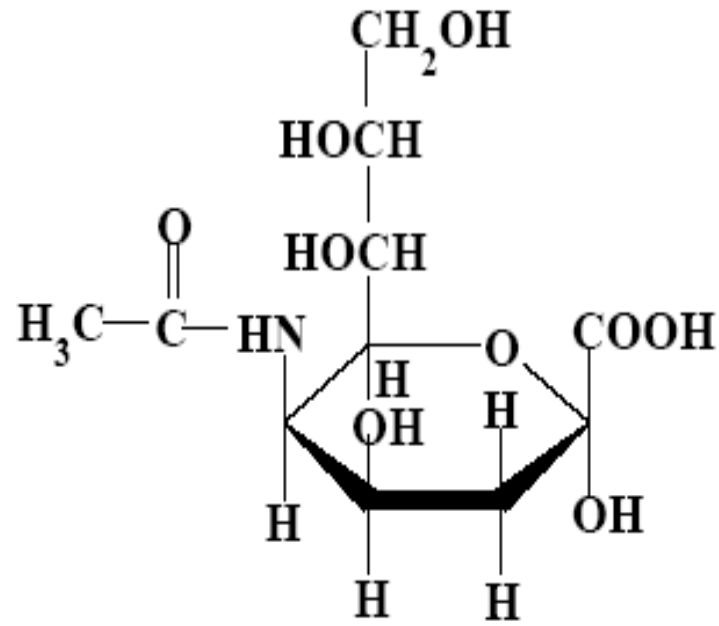

K. SIALOVÁ

Glykosidy :

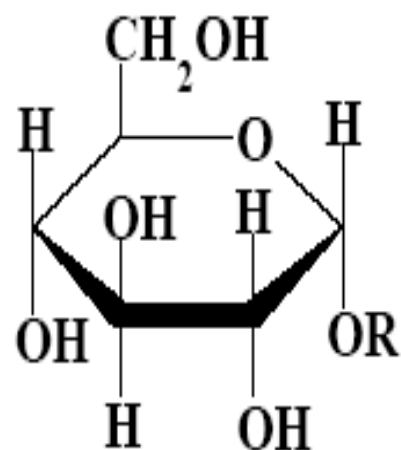

O-glukosid

glykosidická vazba - OR, SR, NR - specificky štěpí glykosidasy

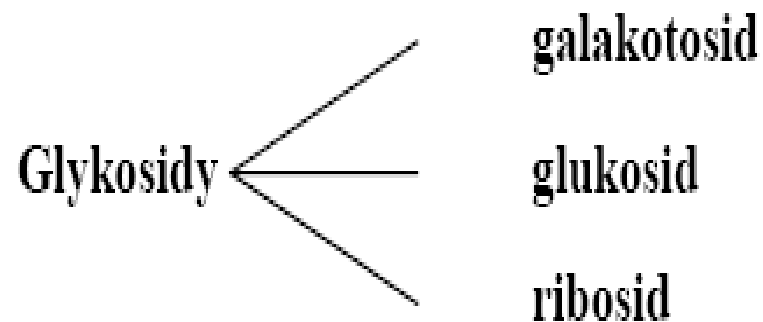
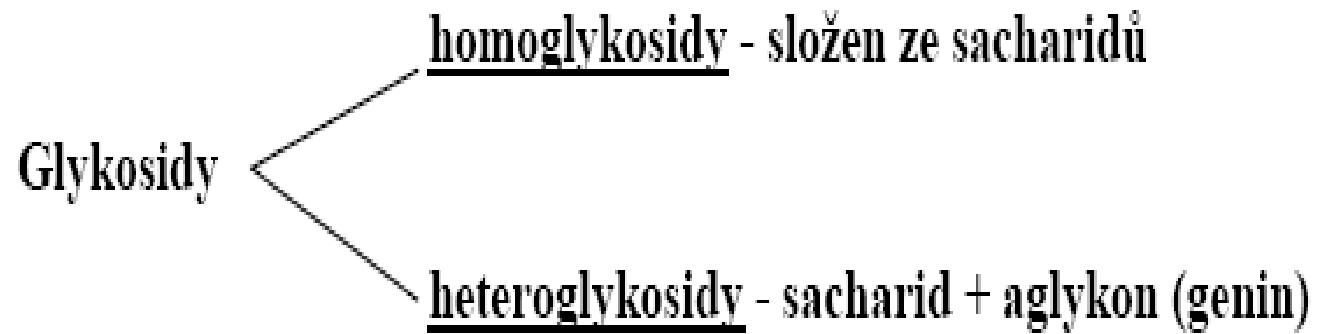

## Disacharidy :

A. Neredukující - trehalosový typ - yl - id

O -  $\alpha$  - D - glukopyranosyl (1 $\rightarrow$ 1) -  $\alpha$  - D - glukopyranosid

B. Redukující - maltosový typ - yl - osa

O -  $\alpha$  - D - glukopyranosyl (1 $\rightarrow$ 4) -  $\alpha$  - D - glukopyranosa

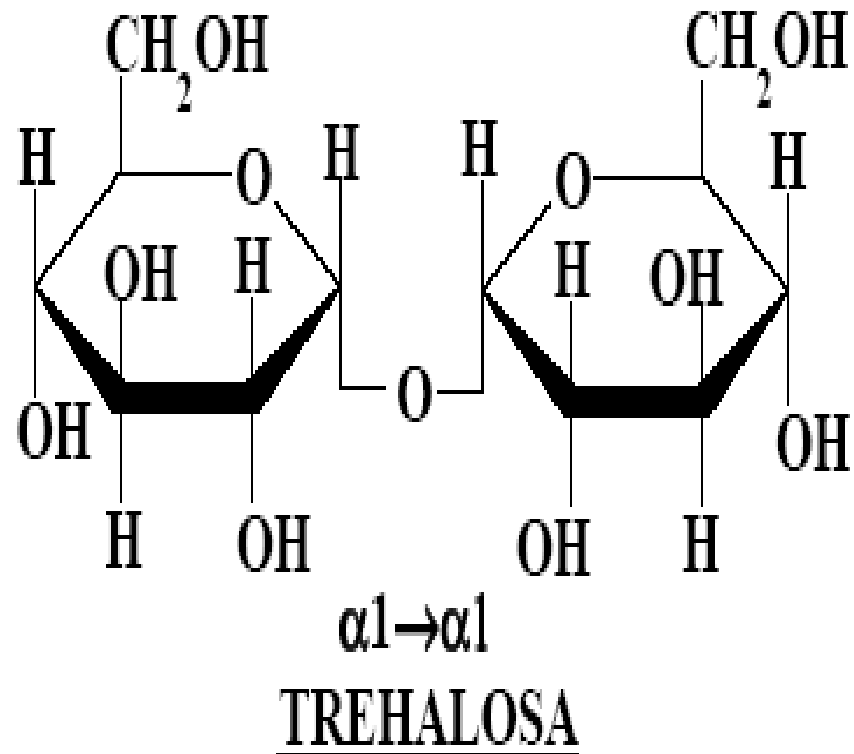

O -  $\alpha$  - D - glukopyranosyl (1 $\rightarrow$ 1) -  $\alpha$  - D - glukopyranosid

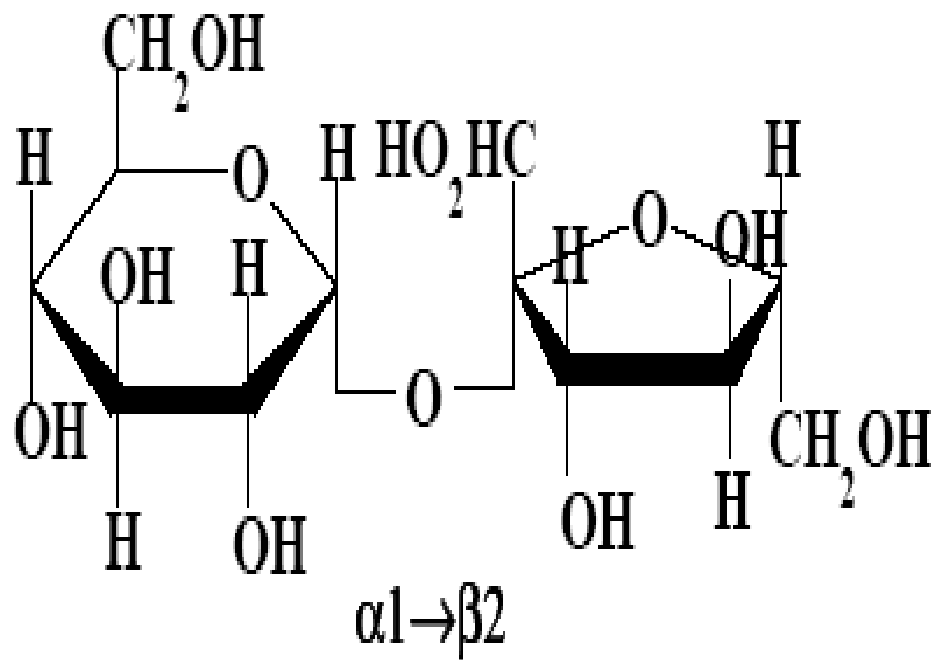

SACHAROSA

O - α - D - glukopyranosyl (1→2) - β - D - fruktofuranosid

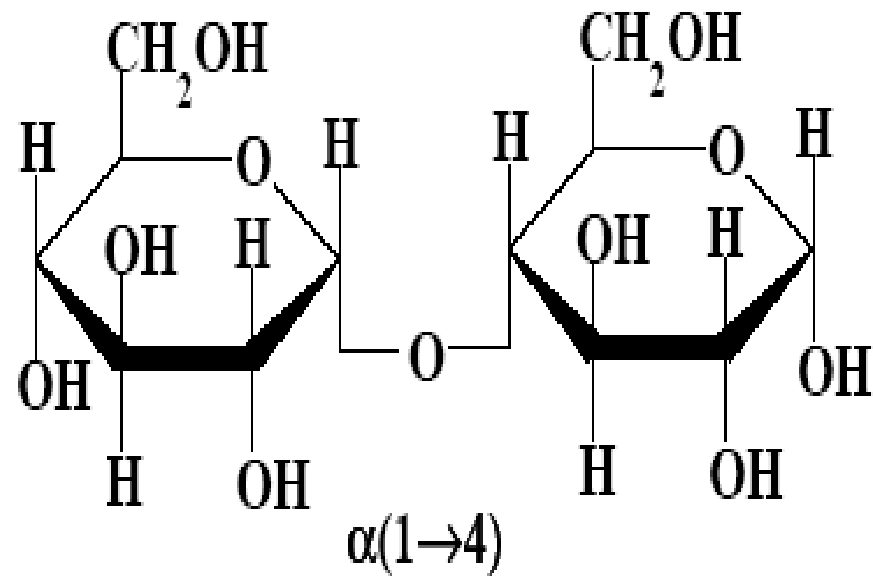

MALTOSA

O -  $\alpha$  - D - glukopyranosyl (1 $\rightarrow$ 4) -  $\alpha$  - D - glukopyranosa



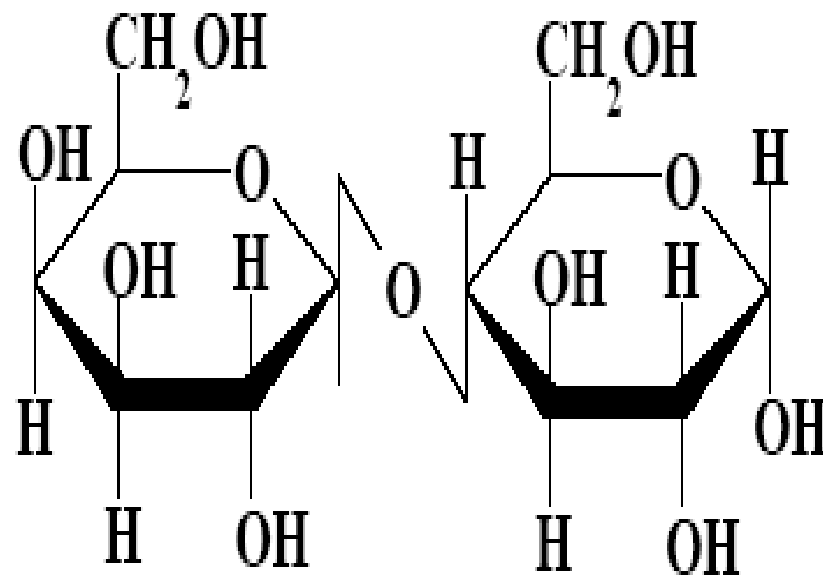

$\beta(1\rightarrow4)$

LAKTOSA

O -  $\beta$  - D - galaktopyranosyl (1 $\rightarrow$ 4) -  $\beta$  - D - glukopyranosa

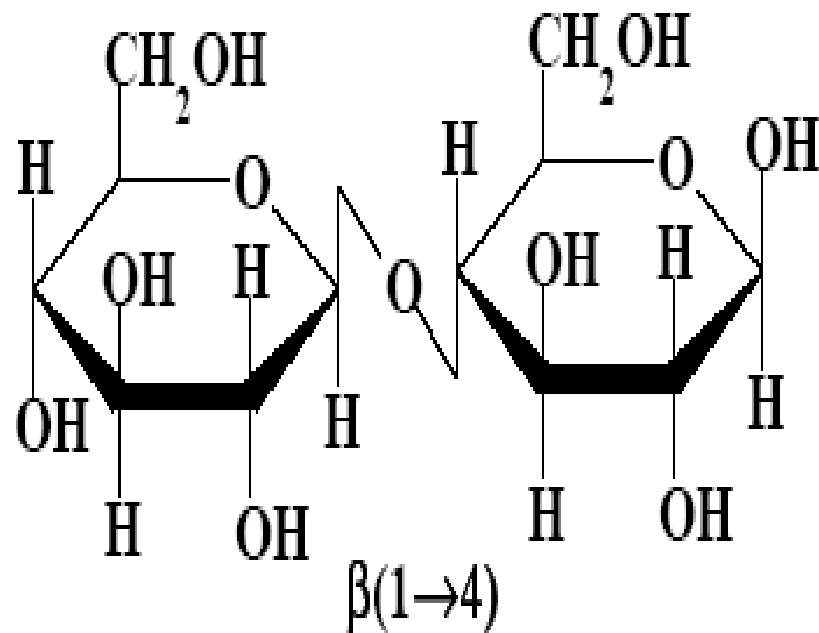

CELLOBIOSA

O -  $\beta$  -D - glukopyranosyl (1 $\rightarrow$ 4) -  $\beta$  -D - glukopyranosa

## Polysacharidy :

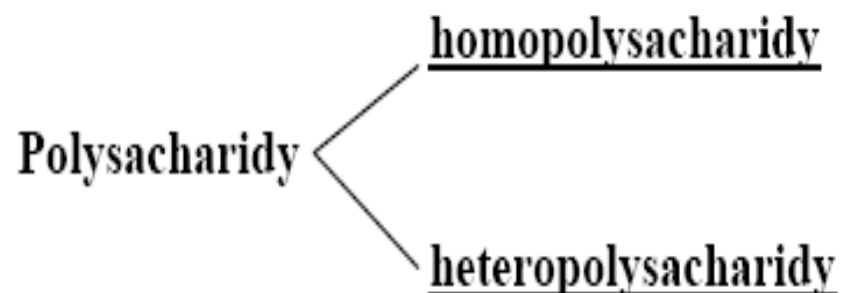

- Funkce - stavební  
- zásobní

## HOMOPOLYSACHARIDY

*Stavební homopolysacharidy :*

CELULOZA - glukosa (celobiosa)

CHITIN - N-acetylglukosamin

AGAROSA - galaktosa + 3, 6 - anhydrogalaktosa

PEKTINY - galakturonová kyselina

# Celulosa

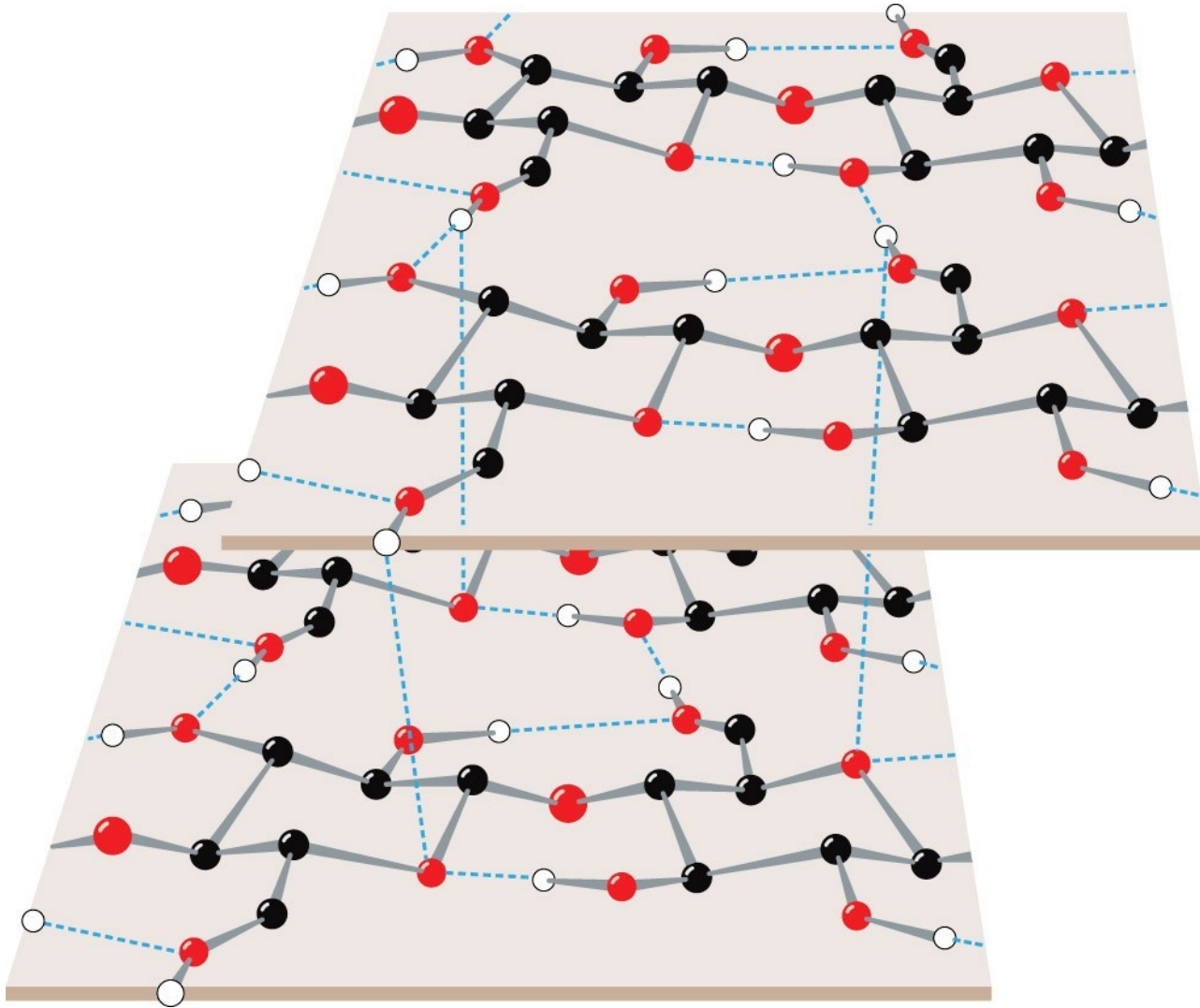



*Zásobní homopolysacharidy :*

ŠKROB - amylosa - glukosa -  $\alpha$  (1→4) - 20 %

(40 - 150 000 MW)

amylopektin - glukosa -  $\alpha$  (1→4) +  $\alpha$  (1→6) - 80 %

(50 000 MW)

GLYKOGEN - glukosa -  $\alpha$  (1→4) +  $\alpha$  (1→6)

DEXTRAN - glukosa -  $\alpha$  (1→6) +  $\alpha$  (1→4) +  $\alpha$  (1→3)

INULIN - fruktosa  $\beta$ (1→)

# Amylose

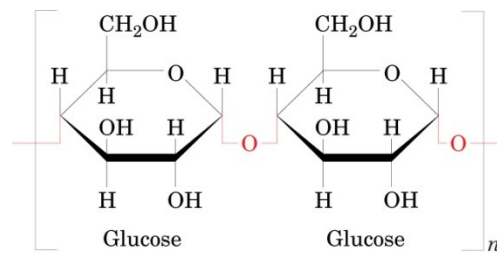

$\alpha$ -Amylose

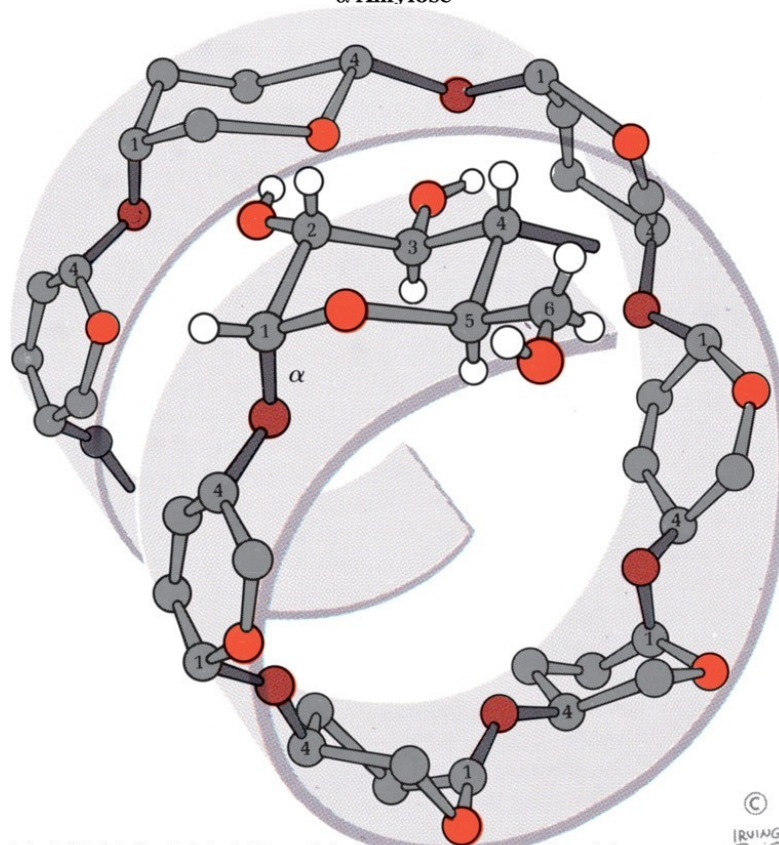



# Amylopektin

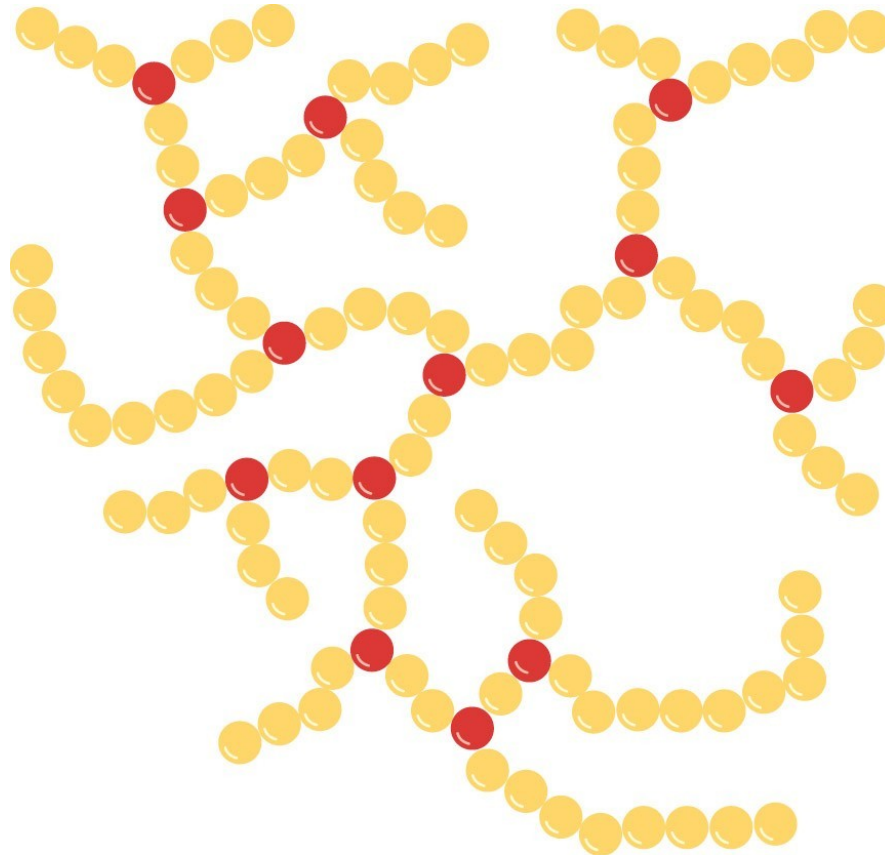
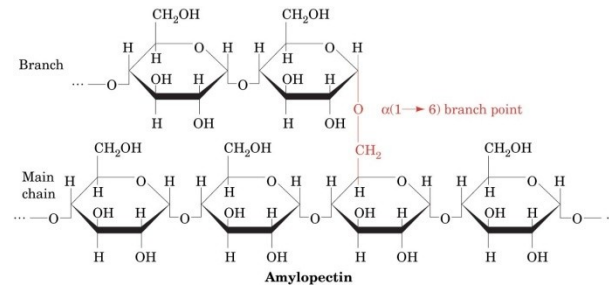

# Škrob (a) a glykogen (b)

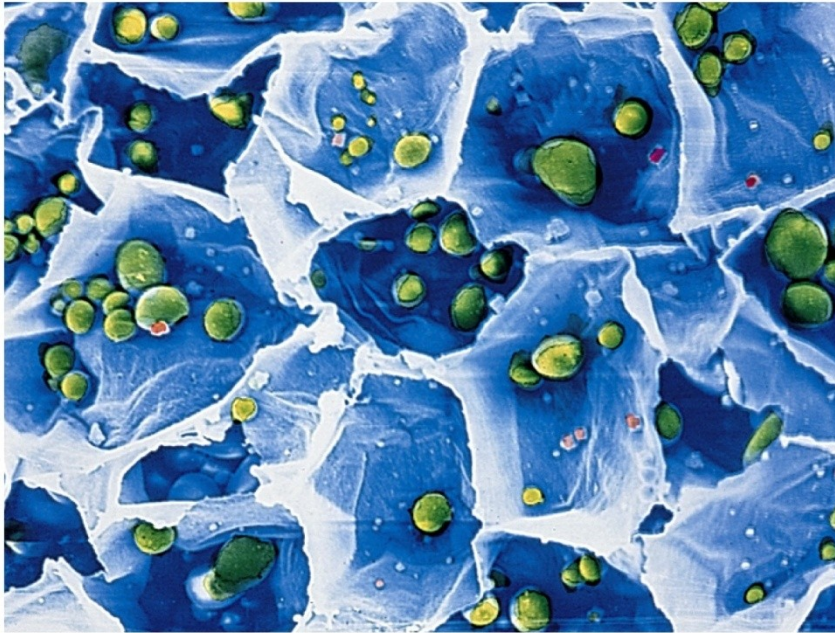

Figure 7-19a Concepts in Biochemistry, 3/e

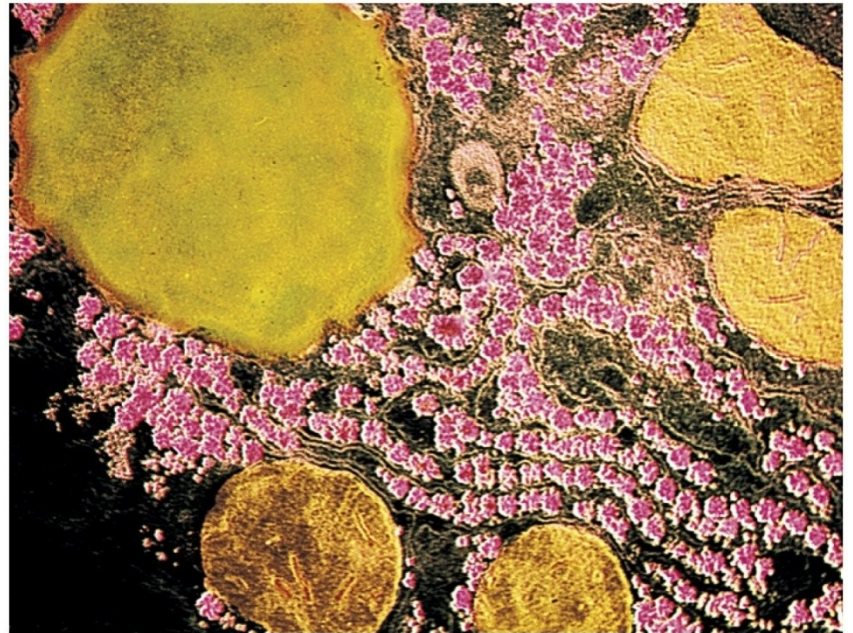
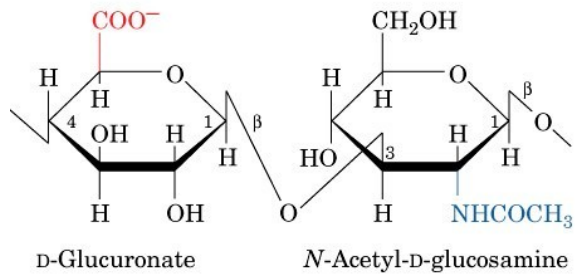
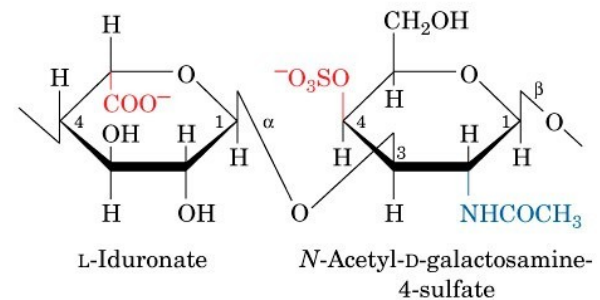

Figure 7-19b Concepts in Biochemistry, 3/e

# Heteropolysacharidy



**Hyaluronate**



**Dermatan sulfate**

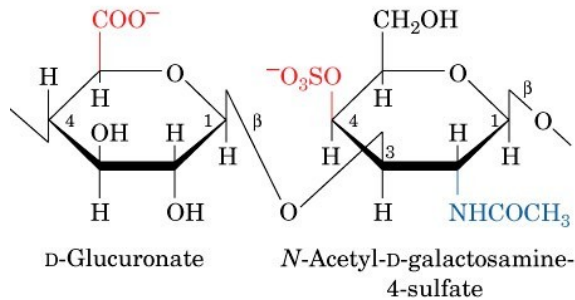

**Chondroitin-4-sulfate**

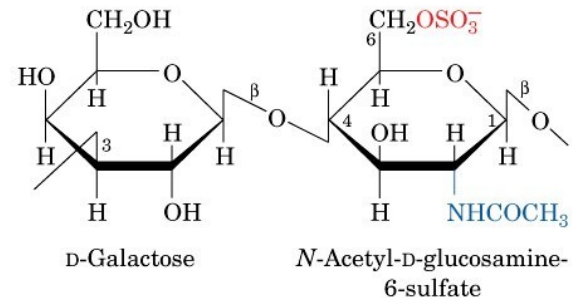

**Keratan sulfate**

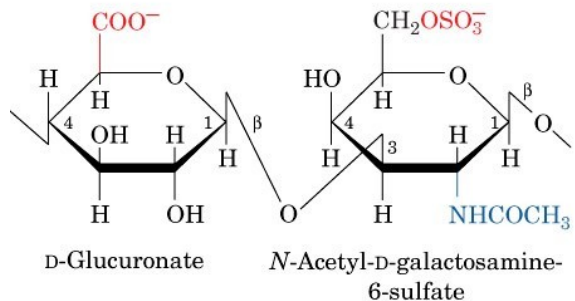

**Chondroitin-6-sulfate**

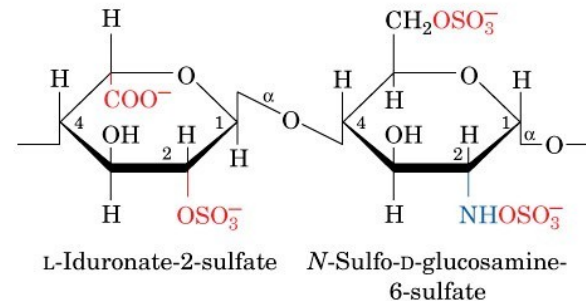

**Heparin**

# Glykoproteiny – N-linked

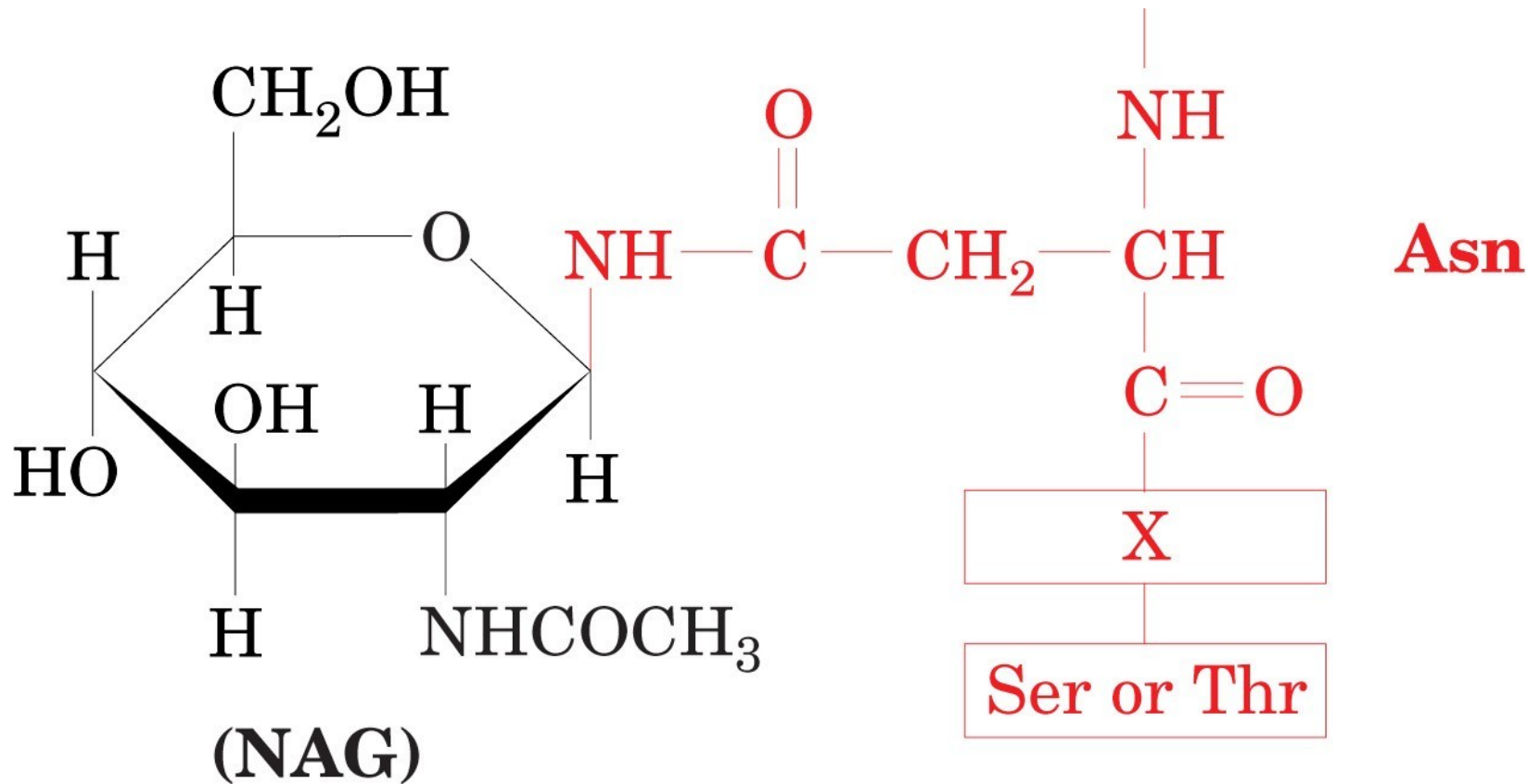

# Glykoproteiny – O-linked

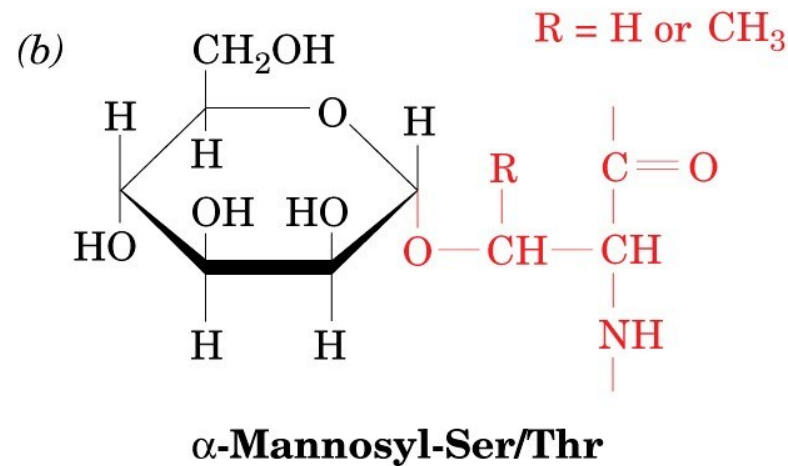
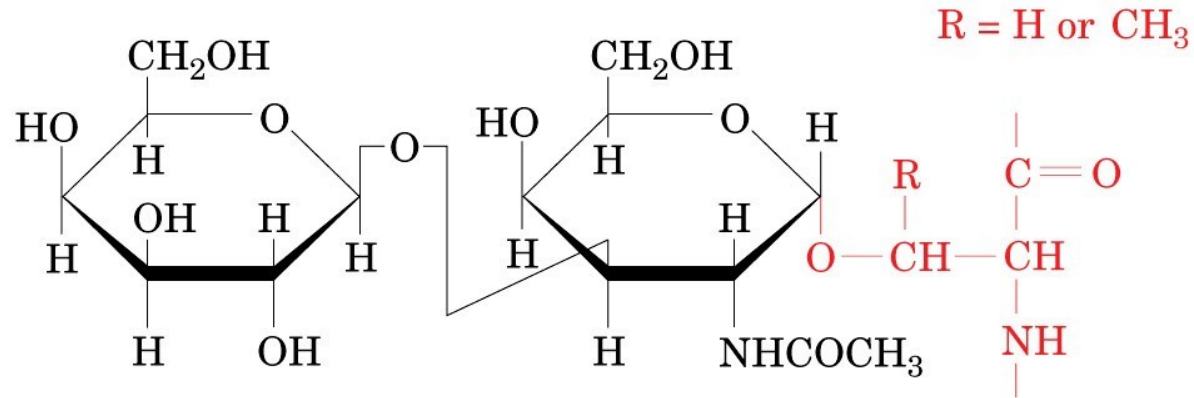

# Glykoproteiny

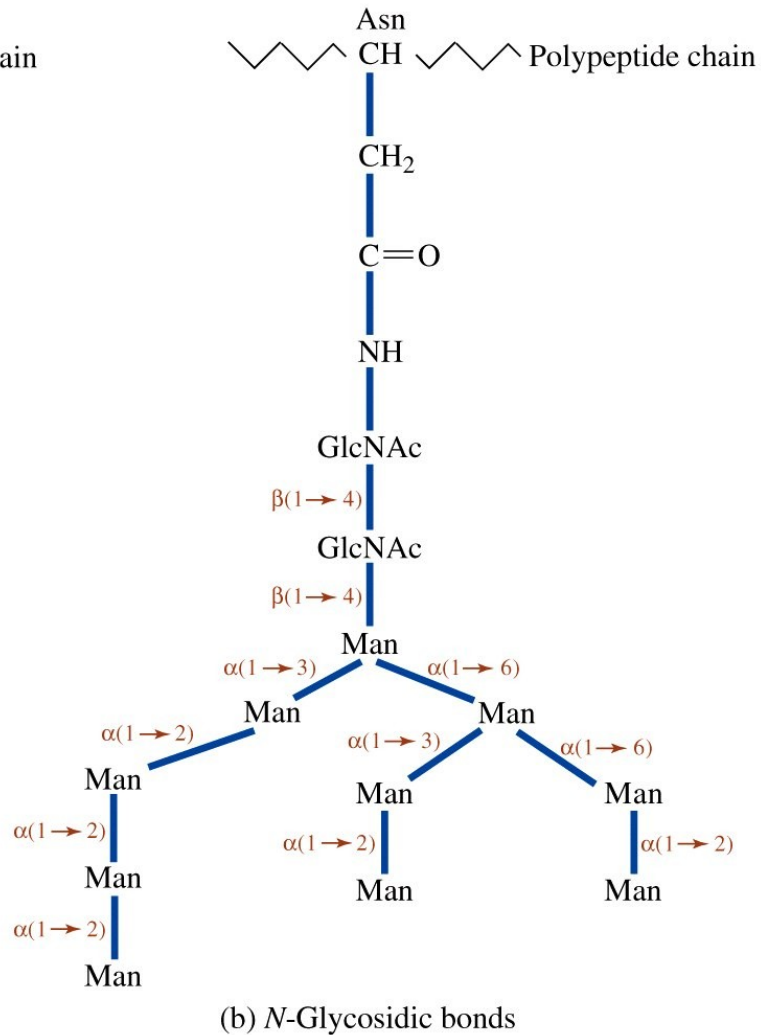
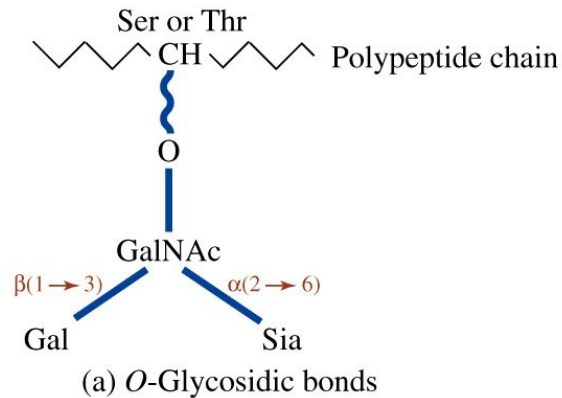

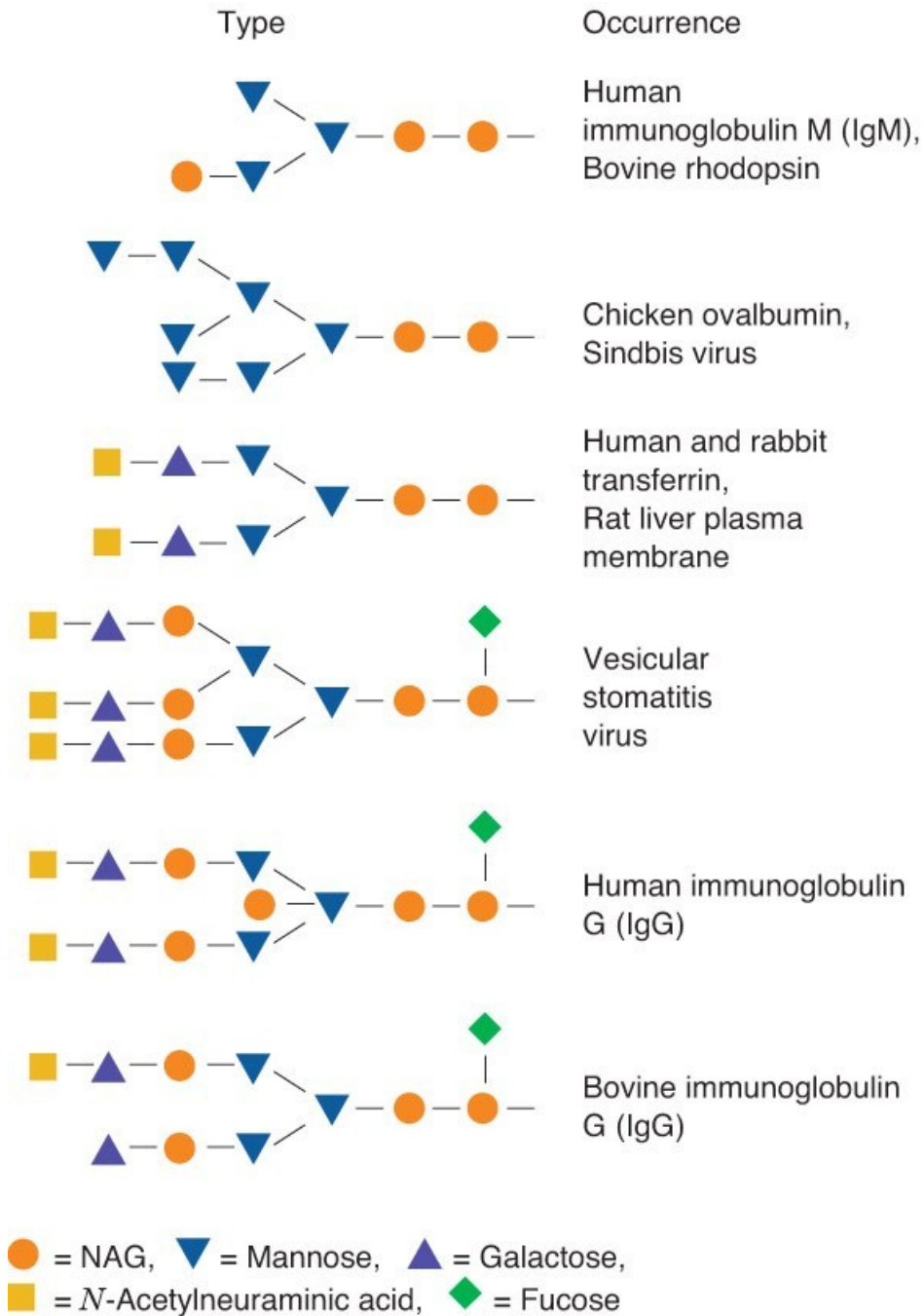

# Glykoproteiny

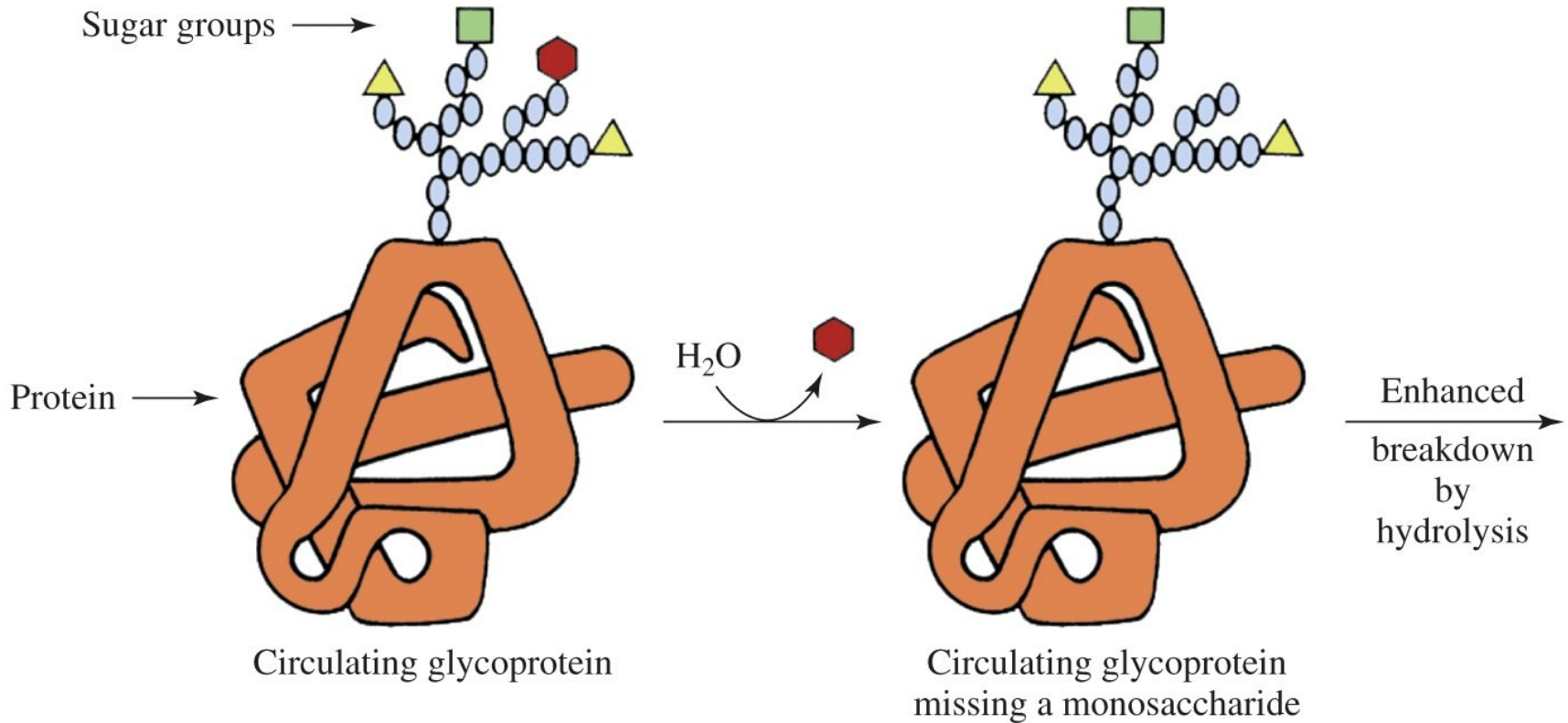
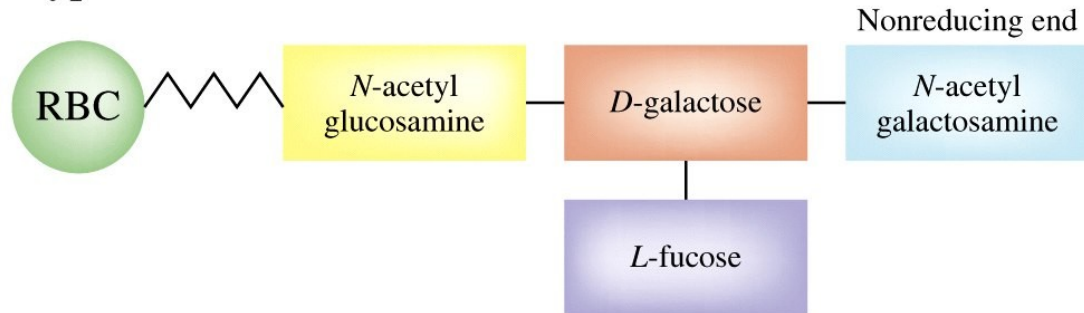

Figure 7-32 Concepts in Biochemistry, 3/e  
© 2006 John Wiley & Sons



# Krevní skupiny

## Type A



## Type B

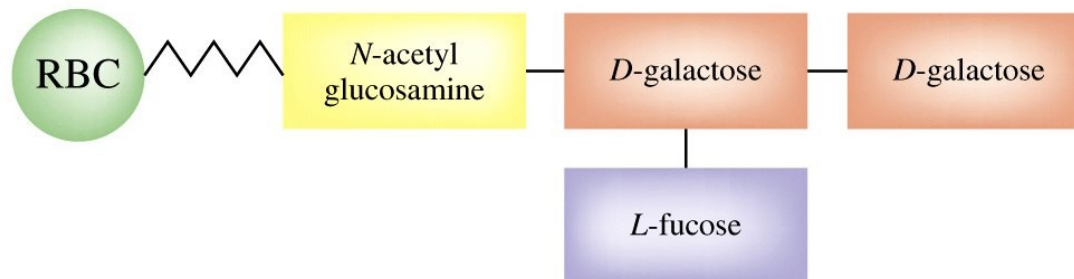

## Type O

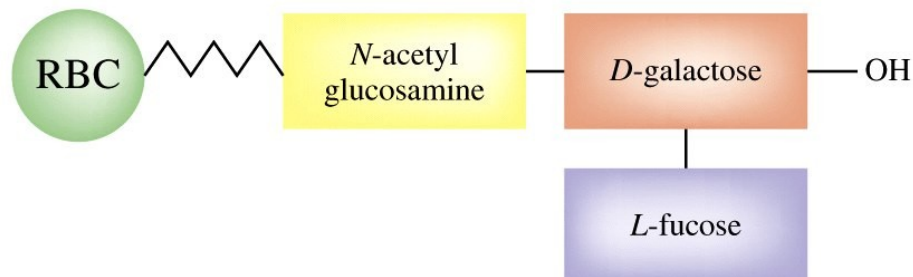

# Proteoglykany

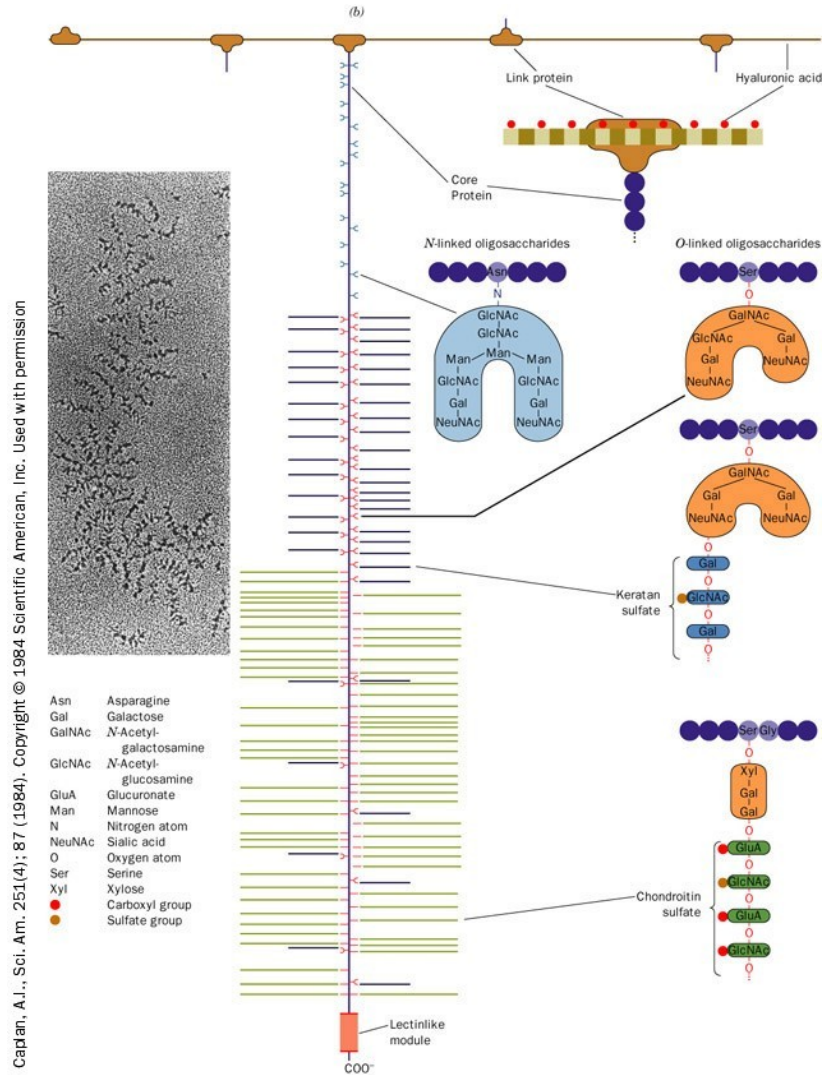

Caplan, A.L., Sci. Am. 251(4): 87 (1984). Copyright © 1984 Scientific American, Inc. Used with permission

# Buněčná stěna bakterií

grampozitivní(a) a gramnegativní(b)

(a) Gram-positive bacteria

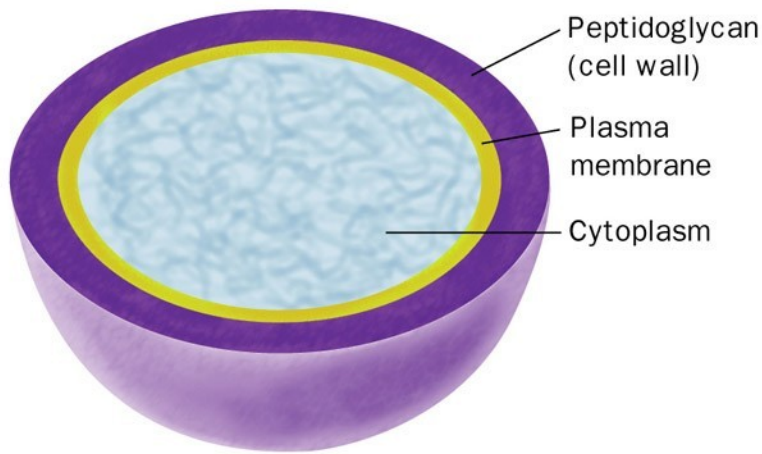

(b) Gram-negative bacteria

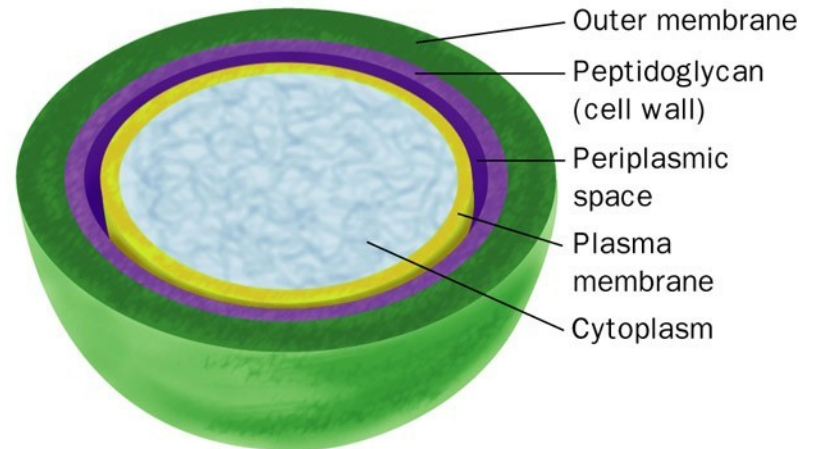

# LIPIDY

*Lipos* - tuk

**Funkce : zdroj a reserva energie**

**strukturní funkce**

**ochranná a izolační funkce**

**různé biologické funkce**

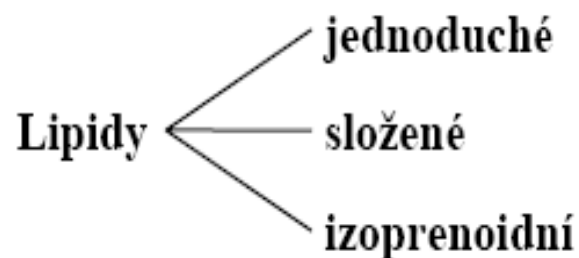

### Triacylglycerols

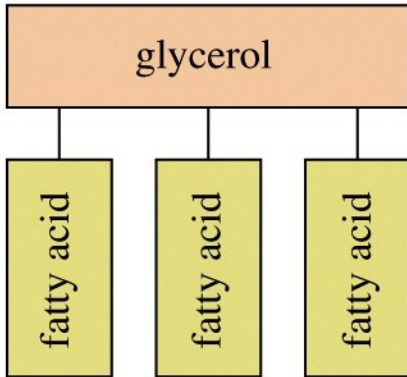

Storage lipids (nonpolar)  
(a)

### Glycerophospholipids

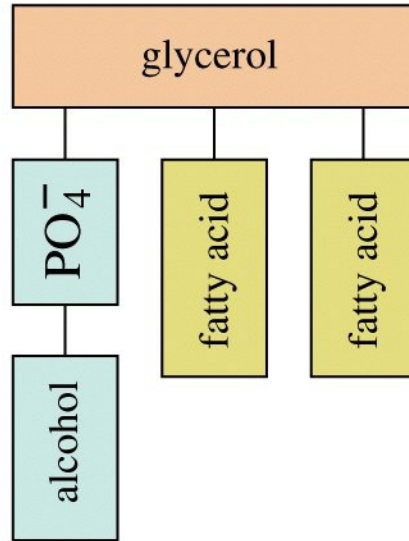

Membrane lipids (polar)  
(b)

### Sphingolipids

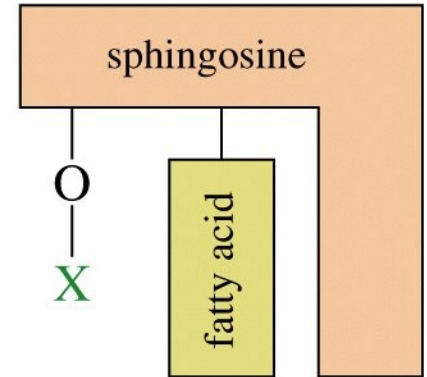

Jednoduché lipidy :

chemicky - estery mastných kyselin a alkoholů

ACYLGLYCEROLY - triglyceridy - estery mastných kyselin a glycerolu

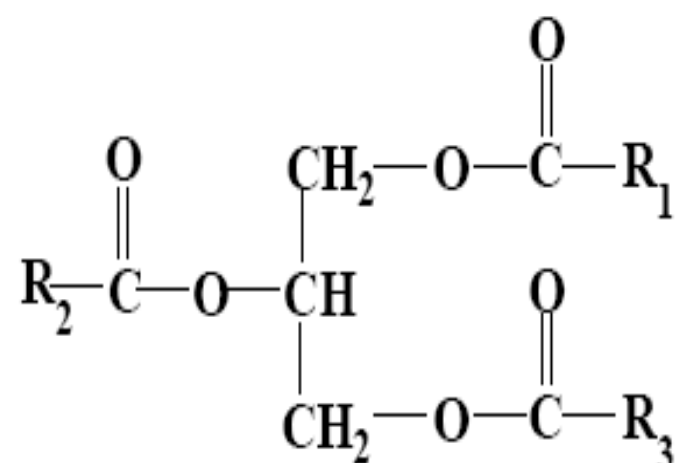

# Adipocyty

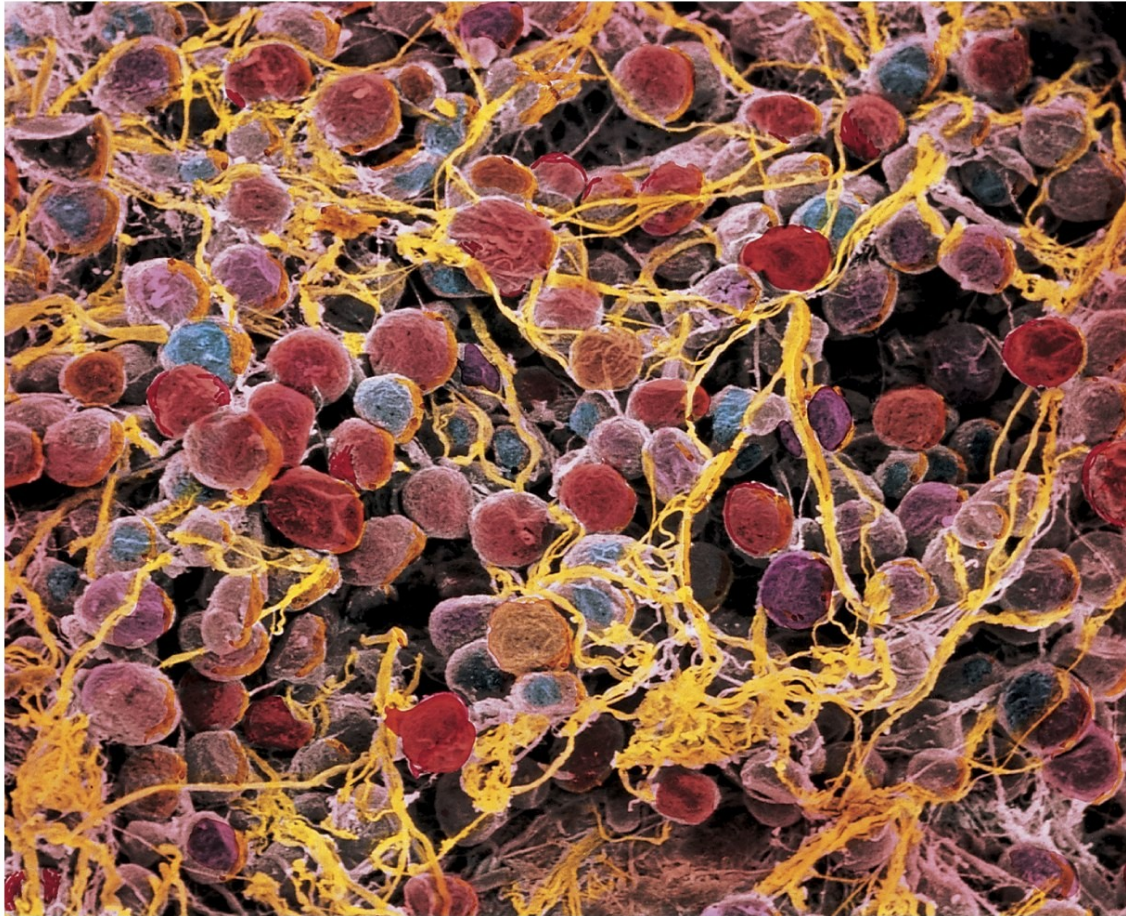
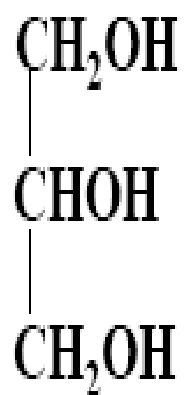
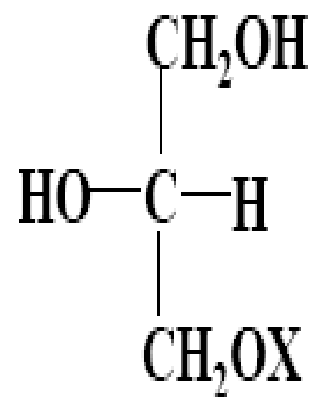

Figure 8-4 Concepts in Biochemistry, 3/e

## Alkohol



glycerol



derivát sn-glycerol  
(L-glycerol)



Mastné kyseliny - nasycené

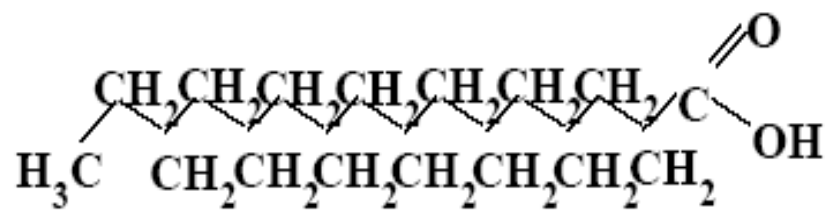

K. PALMITOVÁ

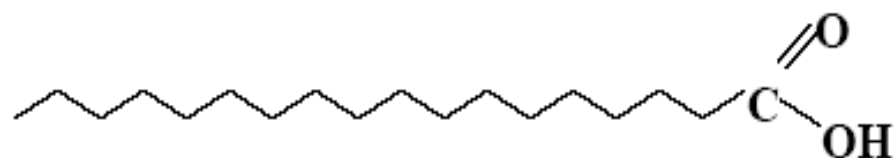
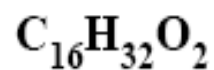

K. STEAROVÁ

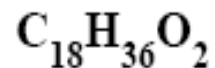

## Mastné kyseliny - nenasycené

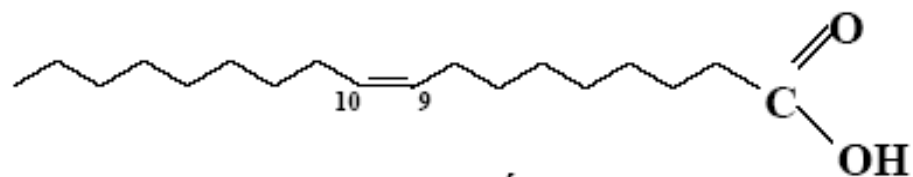

**K. OLEJOVÁ**

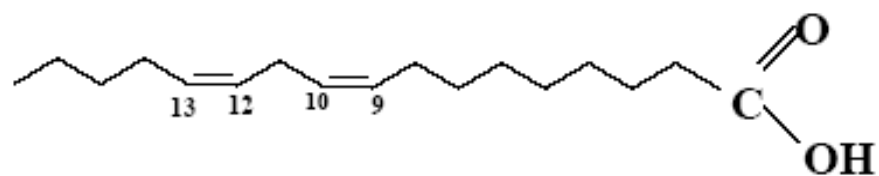
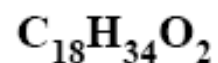

**K. LINOLOVÁ**

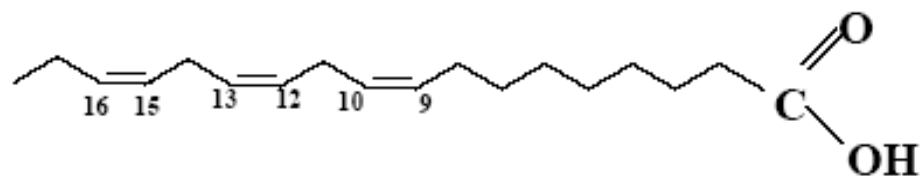
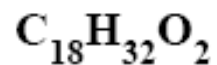

**K. LINOLENOVÁ**

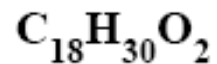



**Saturated  
chain**



***trans*  
Double bond**



***cis*  
Double bond**



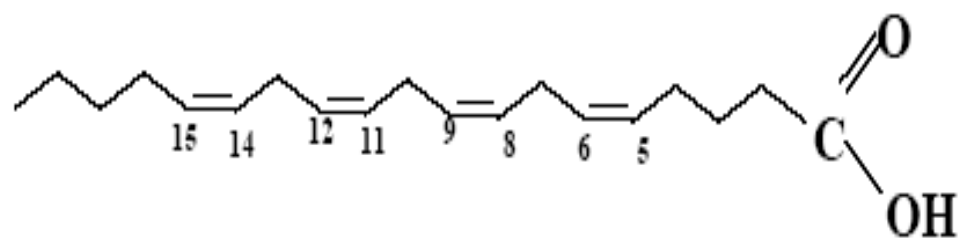

**K.ARACHIDONOVÁ**

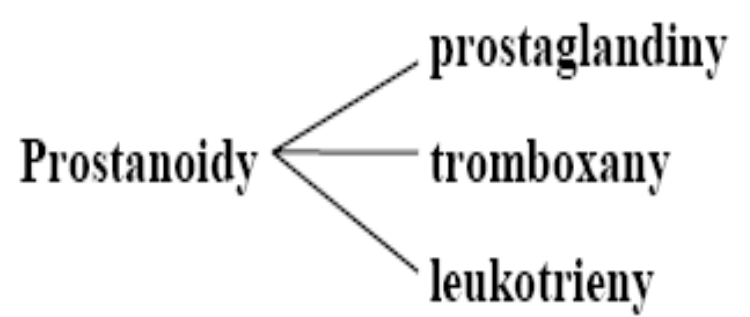
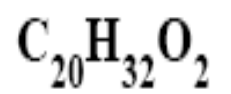

Arachidonic acid residue

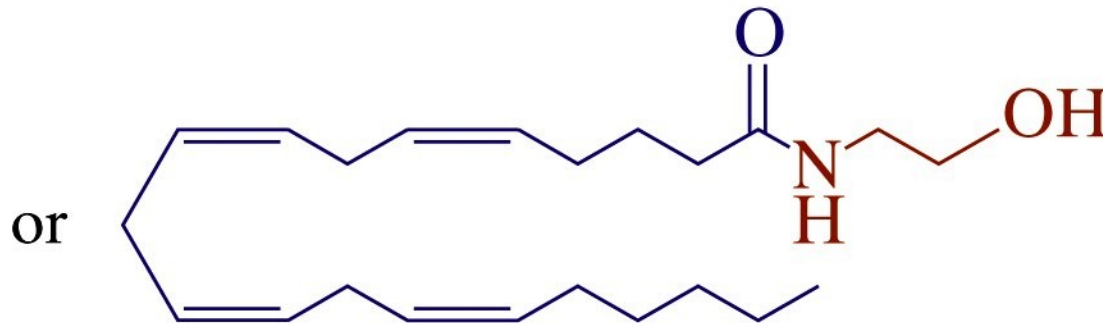
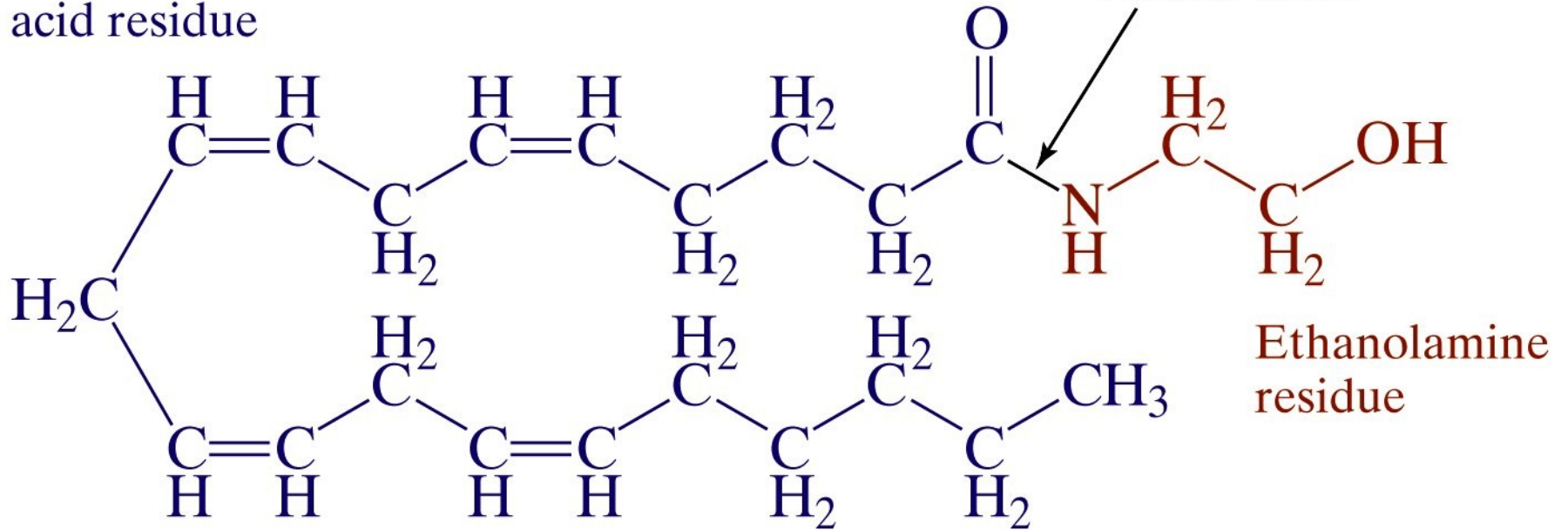

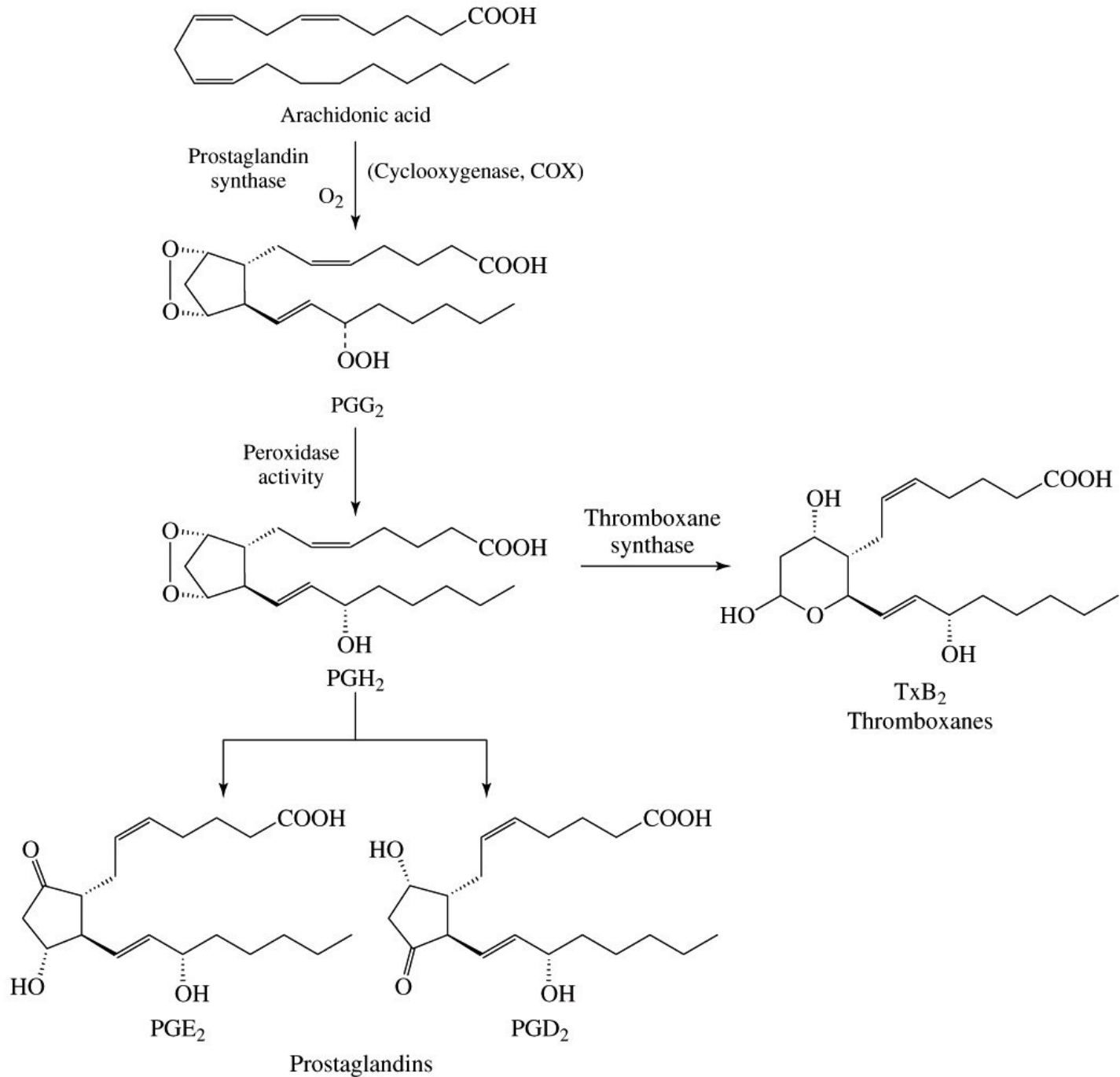
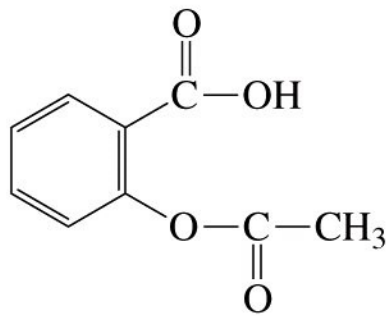
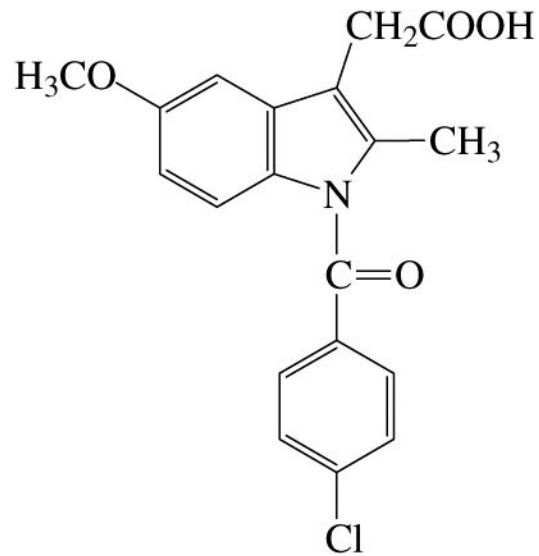

Figure 8-14 Concepts in Biochemistry, 3/e



Aspirin  
(acetylsalicylic acid)



Indomethacin

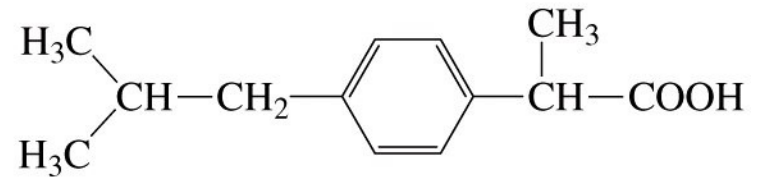

Ibuprofen

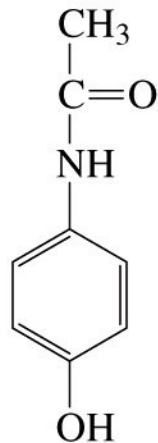

Acetaminophen

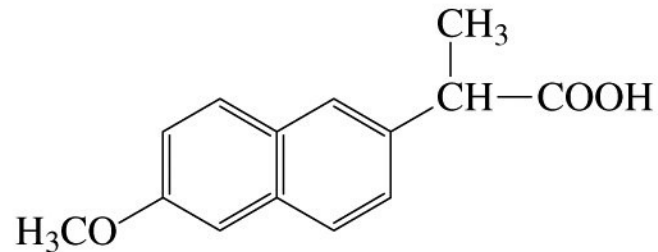

Naproxen (Aleve)



# Důležité reakce tuků - zmydlování - NaOH

- ztužování - H<sub>2</sub>

- žluknutí - O<sub>2</sub>

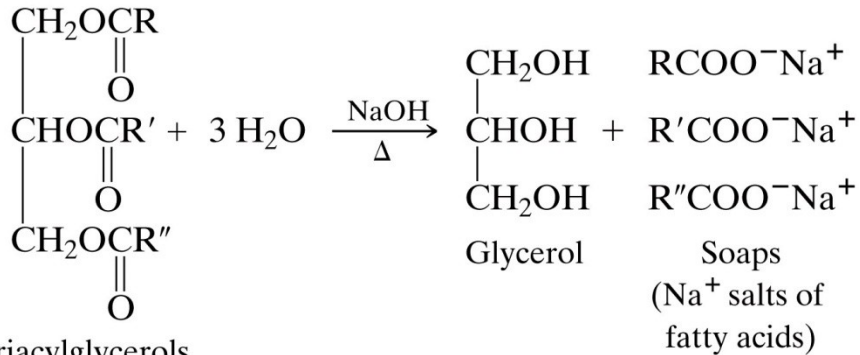

Triacylglycerols

Unnumbered figure pg238b Concepts in Biochemistry, 3/e  
© 2006 John Wiley & Sons

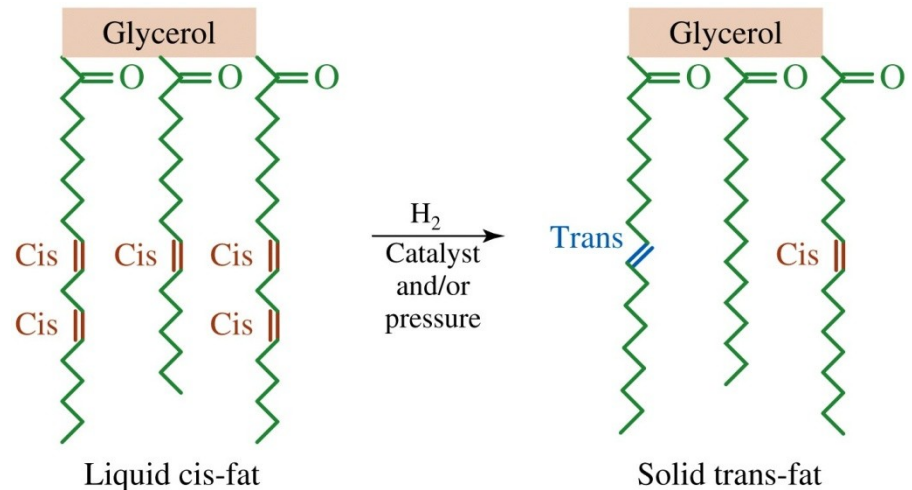

Figure 8-3 Concepts in Biochemistry, 3/e  
© 2006 John Wiley & Sons

**VOSKY - estery mastných kyselin a alifatických alkoholů**

**včelí vosk - palmitan myricylnatý ( $C_{30}H_{61}OH$ )**

**vorvaňovina - palmitan cetylnatý ( $C_{16}H_{33}OH$ )**

**lanolin**

**karnaubský vosk**

Složené lipidy :

## FOSFOLIPIDY

A. Fosfoacylglyceroly - fosfatidy

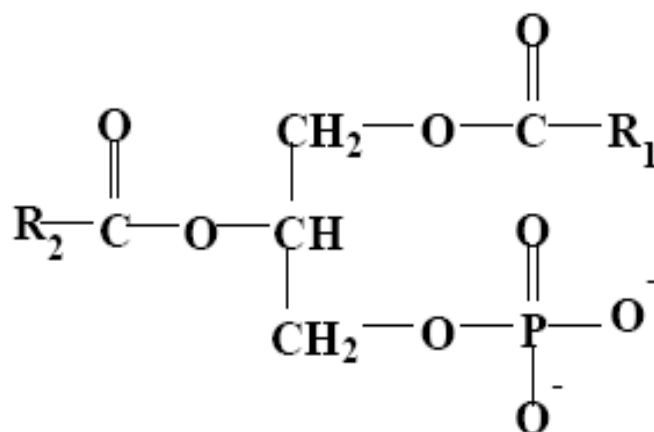

### K. FOSFATIDOVÁ

1,2-diacyl-glycerol-3-fosforečná k.

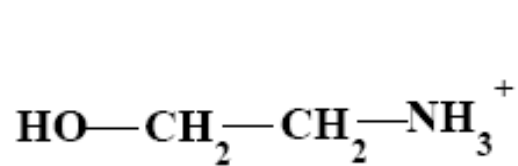

ETHANOLAMIN

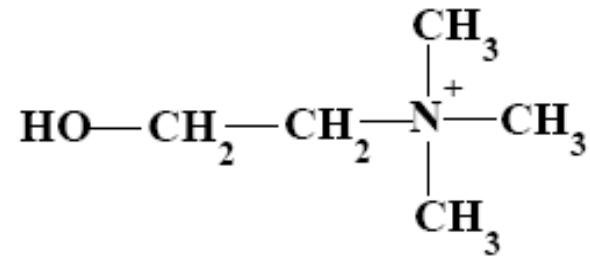

CHOLIN

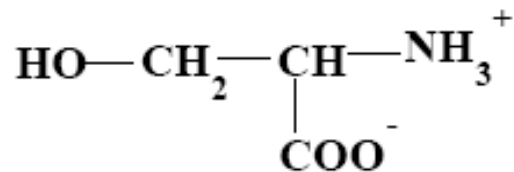

SERIN

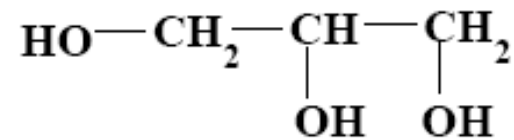

GLYCEROL

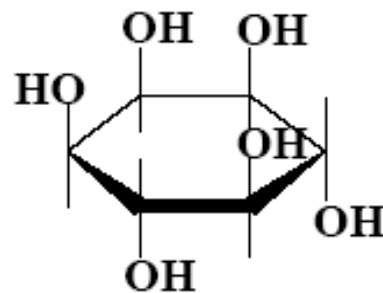

INOSITOL

Fosfatidylcholin - lecitiny

Fosfatidylethanolamin - kefaliny

Bisfosfatidylglycerol - kardiolipin

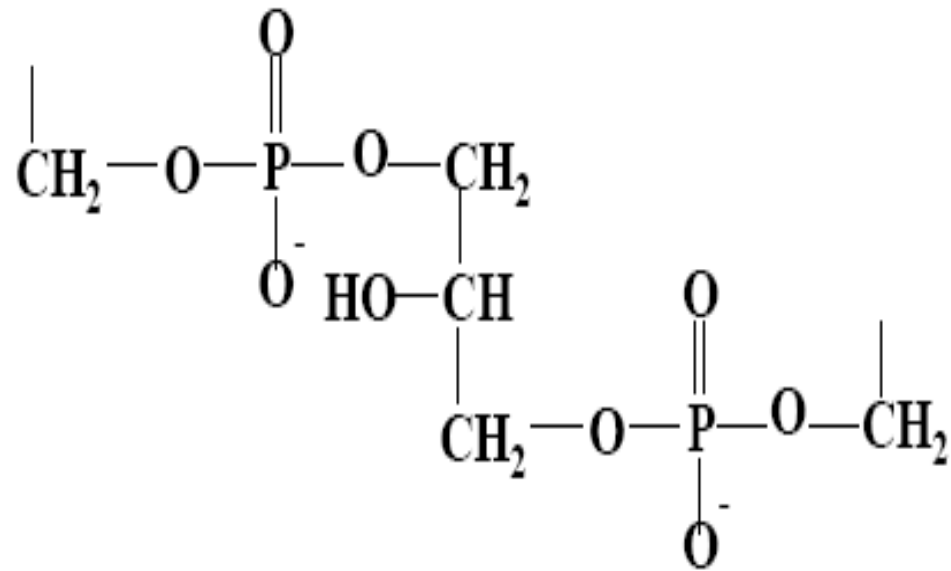

Fosfatidylinositol

# Plazmalogeny

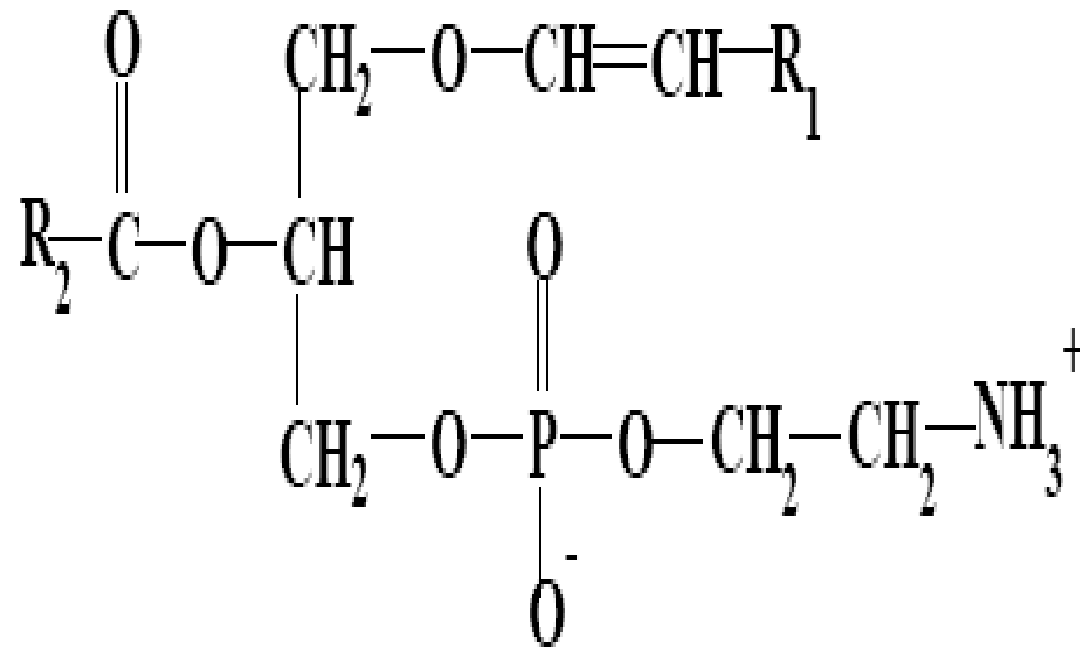

Name of <b>X</b>	Structure of <b>X</b>	Name of Glycerophospholipids
(a) Hydrogen	—H	Phosphatidic acid
(b) Ethanolamine	—CH <sub>2</sub> —CH <sub>2</sub> — $\overset{+}{\text{N}}\text{H}_3$	Phosphatidylethanolamine
(c) Choline	—CH <sub>2</sub> —CH <sub>2</sub> — $\overset{+}{\text{N}}(\text{CH}_3)_3$	Phosphatidylcholine
(d) Serine	$\begin{array}{c} \text{—CH}_2\text{—CH—}\overset{+}{\text{N}}\text{H}_3 \\   \\ \text{COO}^- \end{array}$	Phosphatidylserine
(e) Inositol		Phosphatidylinositol

Figure 8-7 part 2 Concepts in Biochemistry, 3/e  
 © 2006 John Wiley & Sons

## B. Sfingomyelin - sfingofosfolipidy



SFINGOSIN

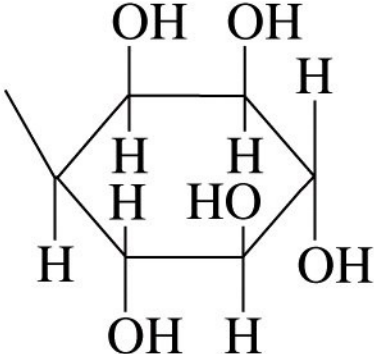
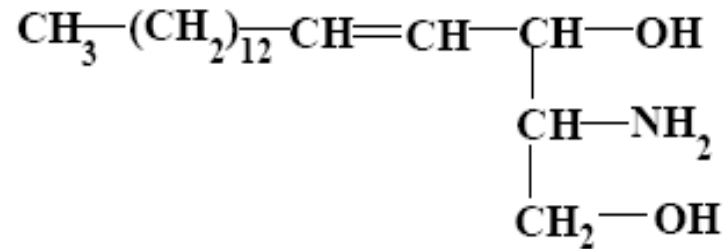
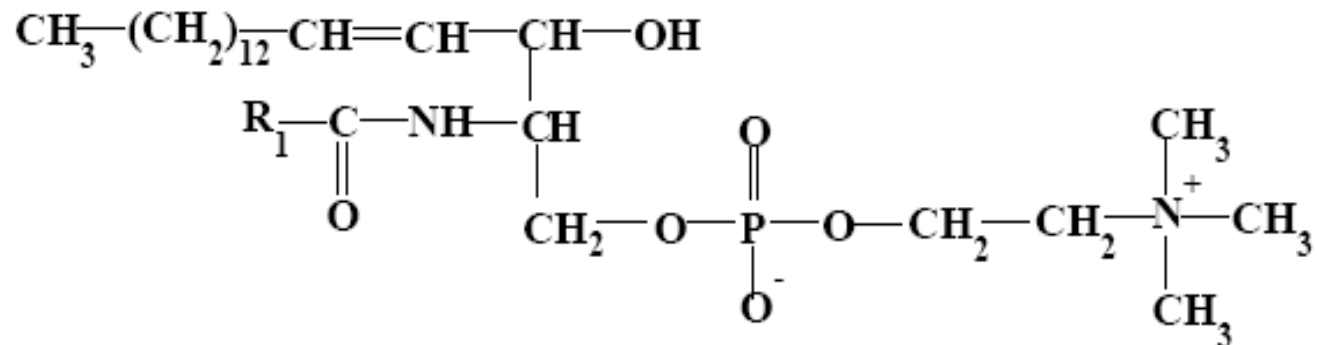

SFINGOMYELIN



Name of <b>X</b>	Structure of <b>X</b>	Name of Sphingolipid
(b) Hydrogen	—H	Ceramide
(c) Phosphocholine	$\begin{array}{c} \text{O} \\ \parallel \\ \text{—P—O—CH}_2\text{CH}_2\text{N}^+(\text{CH}_3)_3 \\   \\ \text{O}^- \end{array}$	Sphingomyelin
(d) Glucose		Glucosylcerebroside
(e) Complex oligosaccharide		Ganglioside

Figure 8-8 part 2 Concepts in Biochemistry, 3/e  
© 2006 John Wiley & Sons

# GLYKOLIPIDY

## A. Glycerolglykolipidy

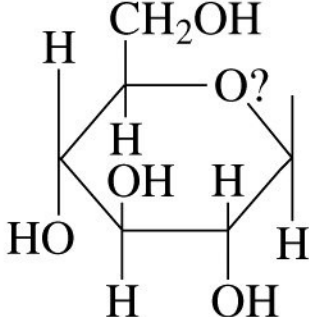
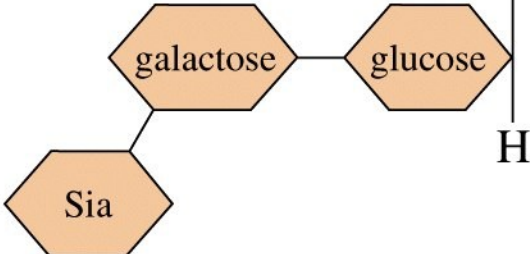
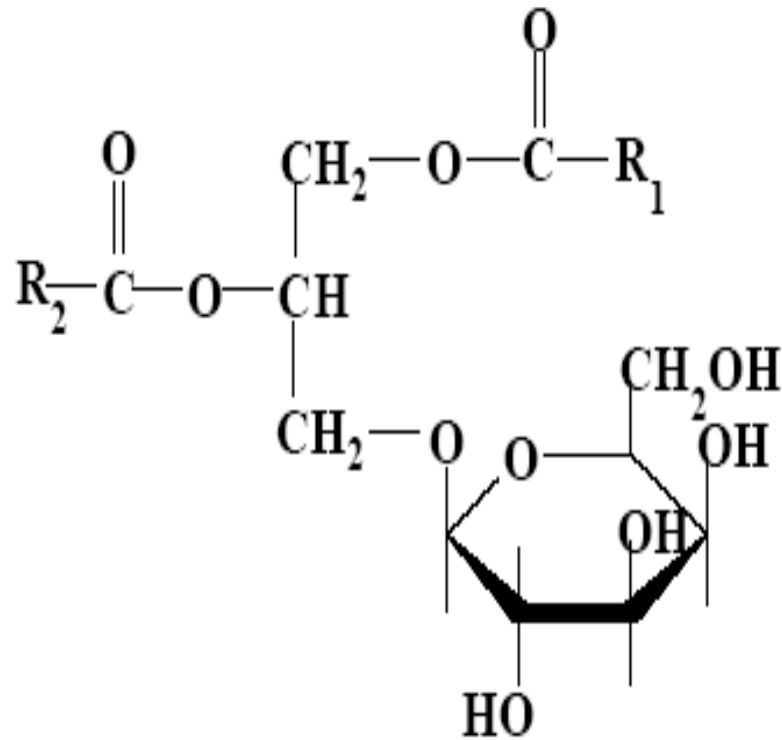

## B. Cerebrosidy

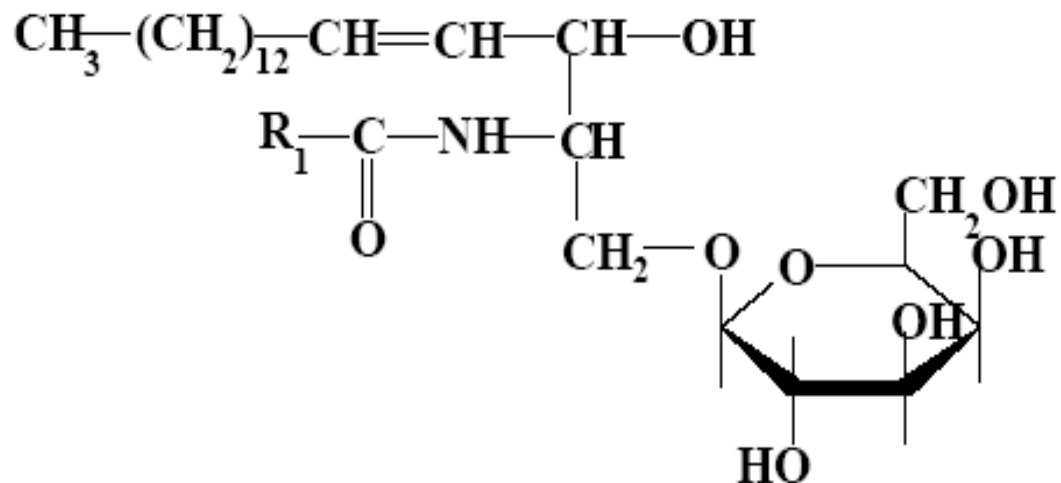

galaktocerebrosidy - mozek

sulfatidy

glukocerebrosidy - ostatní tkáně

## C. Glykosfingolipidy

gangliosidy - sialová kyselina - ganglie nervových buněk

## Izoprenoidní lipidy :

Základní strukturální jednotka - izopren 2-methyl-1,3-butadien

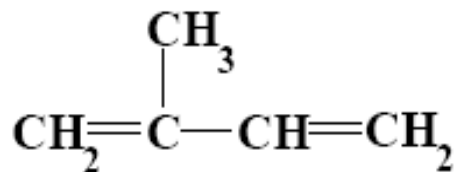

izopren

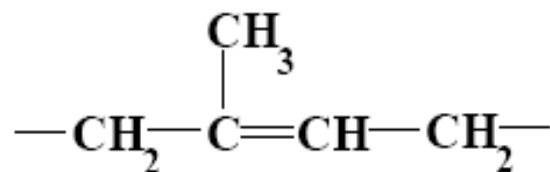

izopentenyl

## STEROIDY

STERAN - cyklopentanoperhydrofenantren

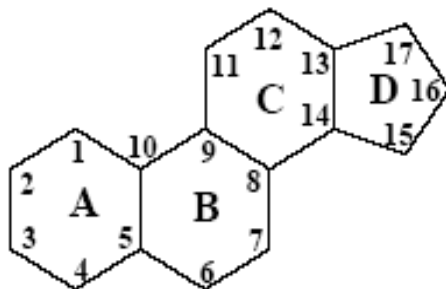

A. Steroly

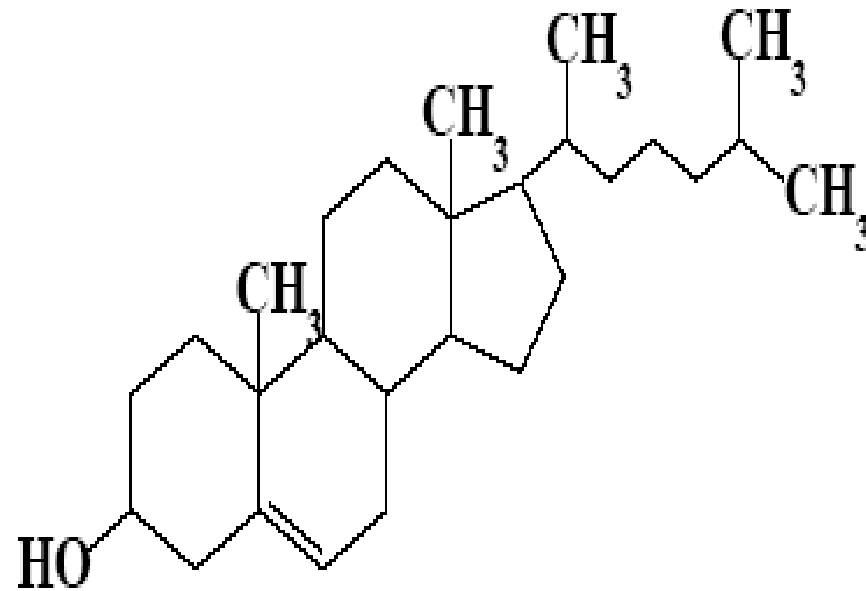

**CHOLESTEROL**

## Steroidní hormony

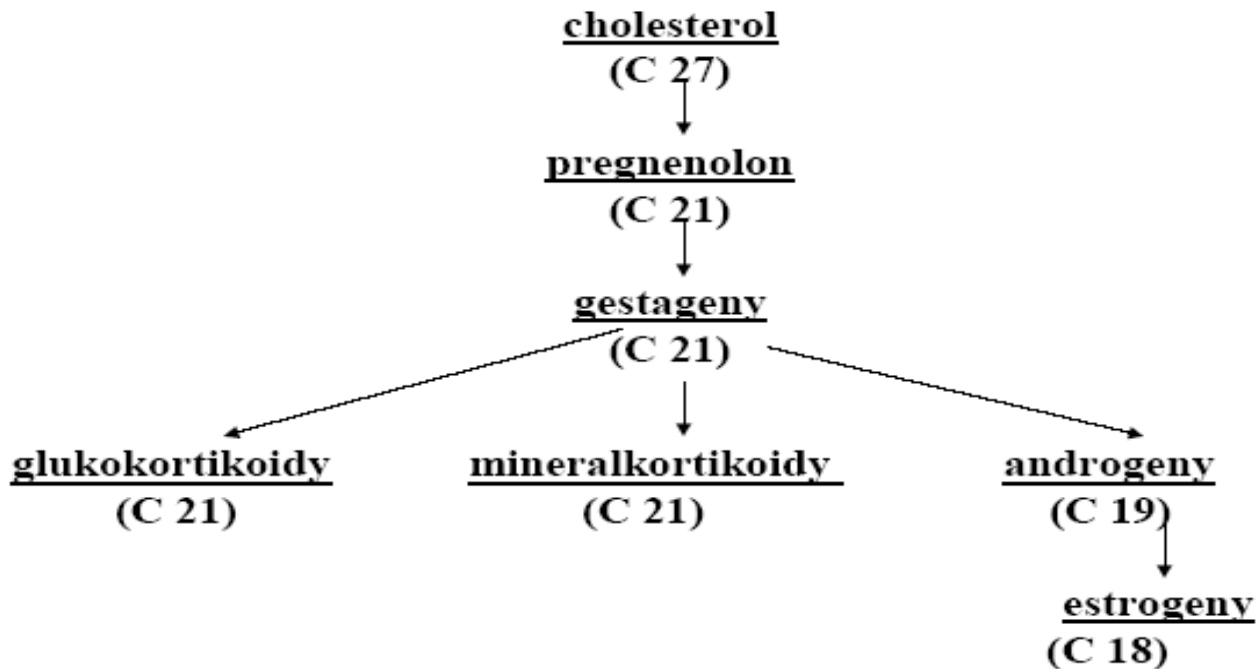

*Glukokortikoidy* - kortisol, kortikosteron - kůra nadledvinek

*Mineralkortikoidy* - aldosteron - kůra nadledvinek

*Androgeny* - testosteron - varlata

*Estrogeny* - estron, estradiol, estratriol - vaječníky

*Gestageny* - progesteron - vaječníky

cholesterol  $\rightleftharpoons$  ester cholesterolu  
(5-cholesten-3 $\beta$ -ol)

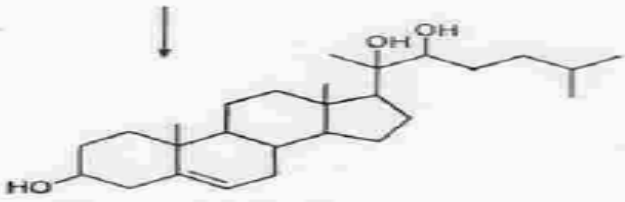

20,22-dihydroxycholesterol  
(20,22-dihydroxy-5-cholesten-3 $\beta$ -ol)

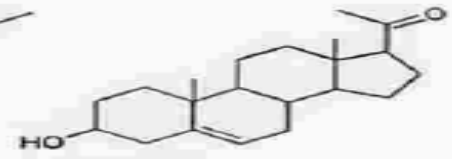

pregnenolon  
(3 $\beta$ -hydroxy-5-pregnen-20-on)

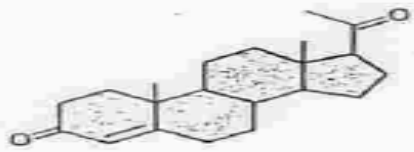

progesteron  
(4-pregnen-3,20-dion)

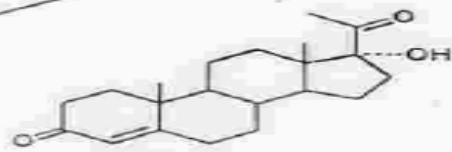

17-hydroxyprogesteron  
(17-hydroxy-4-pregnen-3,20-dion)

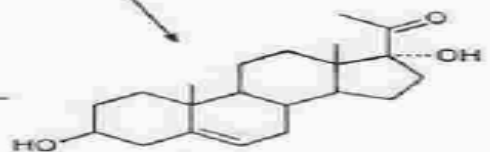

17-hydroxypregnenolon  
(3 $\beta$ ,17-dihydroxy-5-pregnen-20-on)

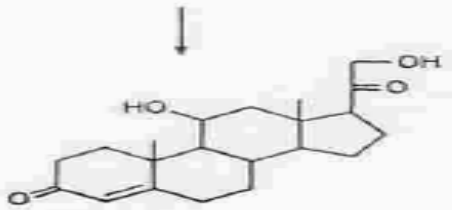

kortikosteron  
(11 $\beta$ ,21-dihydroxy-4-pregnen-3,20-dion)

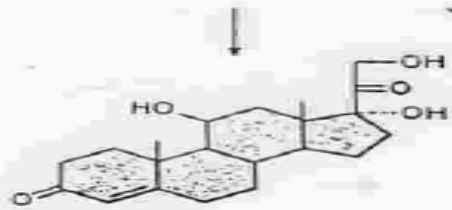

kortisol  
(11 $\beta$ ,17,21-trihydroxy-4-pregnen-3,20-dion)

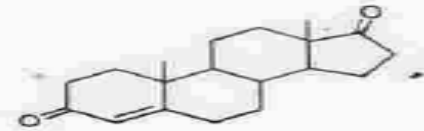

androstendion  
(4-androsten-3,17-dion)

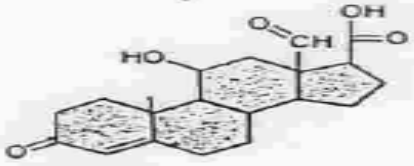

aldosteron  
(11 $\beta$ ,21-dihydroxy-3,20-dioxo-4-pregnen-18-al)



17 $\beta$ -estradiol  
(1,3,5(10)-estratrien-3,17 $\beta$ -diol)

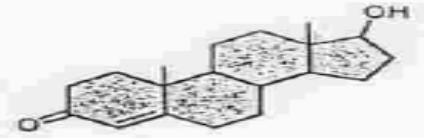

testosteron  
(17 $\beta$ -hydroxy-4-androsten-3-on)

B. Žlučové kyseliny - k.cholová, k. glykocholová, k. taurocholová

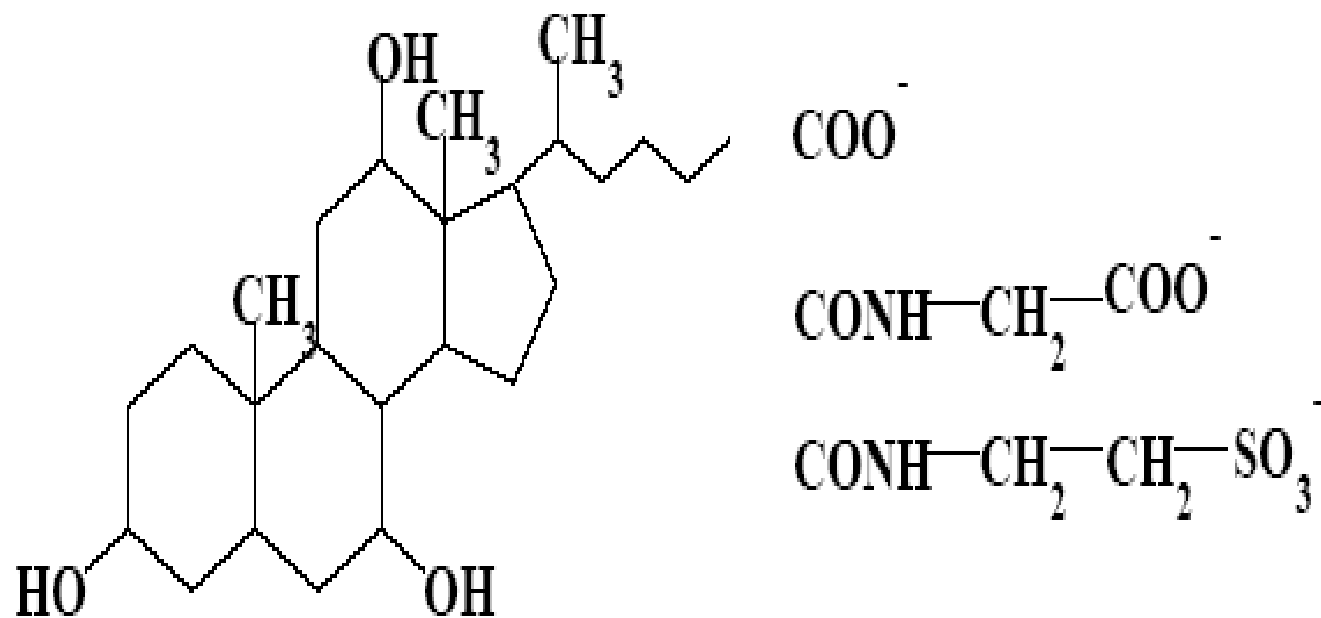



C. Kalciferoly - vitaminy - D<sub>3</sub> - cholekalciferol, D<sub>2</sub> - ergokalciferol

provitamin D

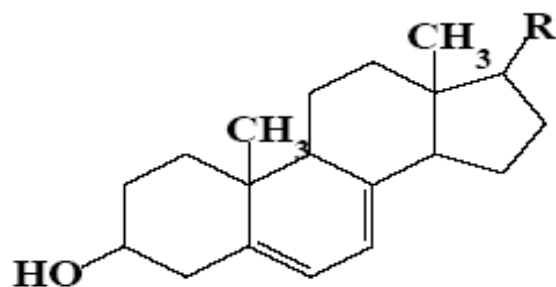

prekalciferol

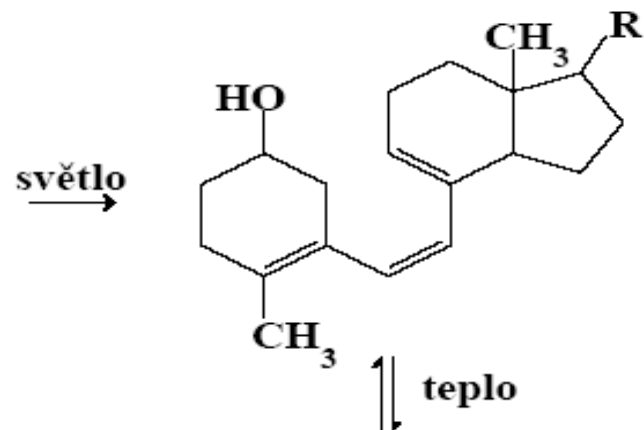

světlo  
→

↕ teplo

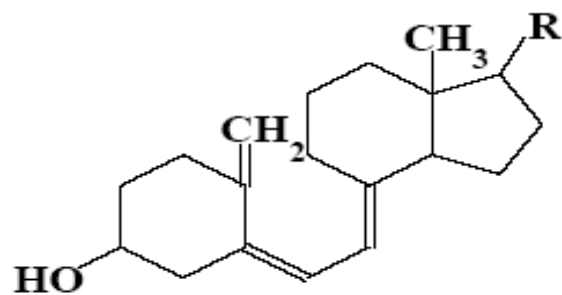

↔

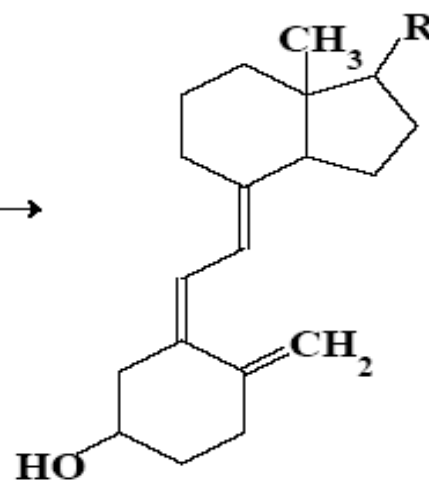

kalciferol

# Plazmatické lipoproteiny

Charakteristiky hlavních tříd lipoproteinů v lidské plasmě

Třída lipoproteinů	Hlavní lipidy <sup>a</sup>	Apoproteiny	Hustota g / mL	Průměr částice nm
Chylomikrony a zbytky	triacylglyceroly v dietě	A-I,A-II,B-48, C-I,C-II,C-III, E	<0,95	80–500
VLDL	endogenní triacylglyceroly, estery cholesterolu, cholesterol	B-100,C-I,C-II	0,95–1,006	30–80
IDL	estery cholesterolu, triacylglyceroly, cholesterol	B-100,C-III,E	1,006–1,019	25–35
LDL	estery cholesterolu, cholesterol, triacylglyceroly,	B-100	1,019–1,063	18–28
HDL	estery cholesterolu, cholesterol	A-I,A-II,C-I,	1,063–1,210	5–12

# Plazmatické lipoproteiny

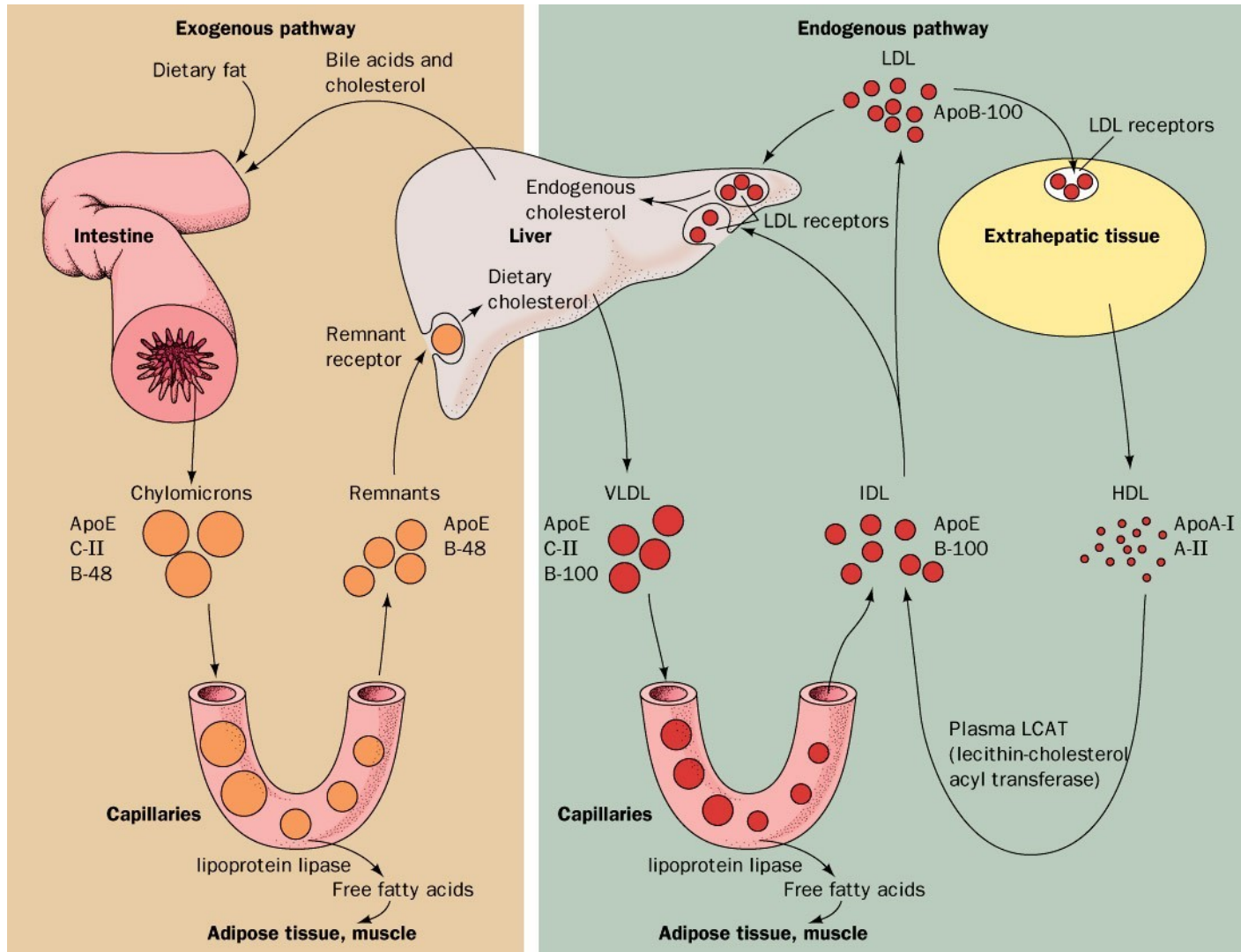

# Membrány

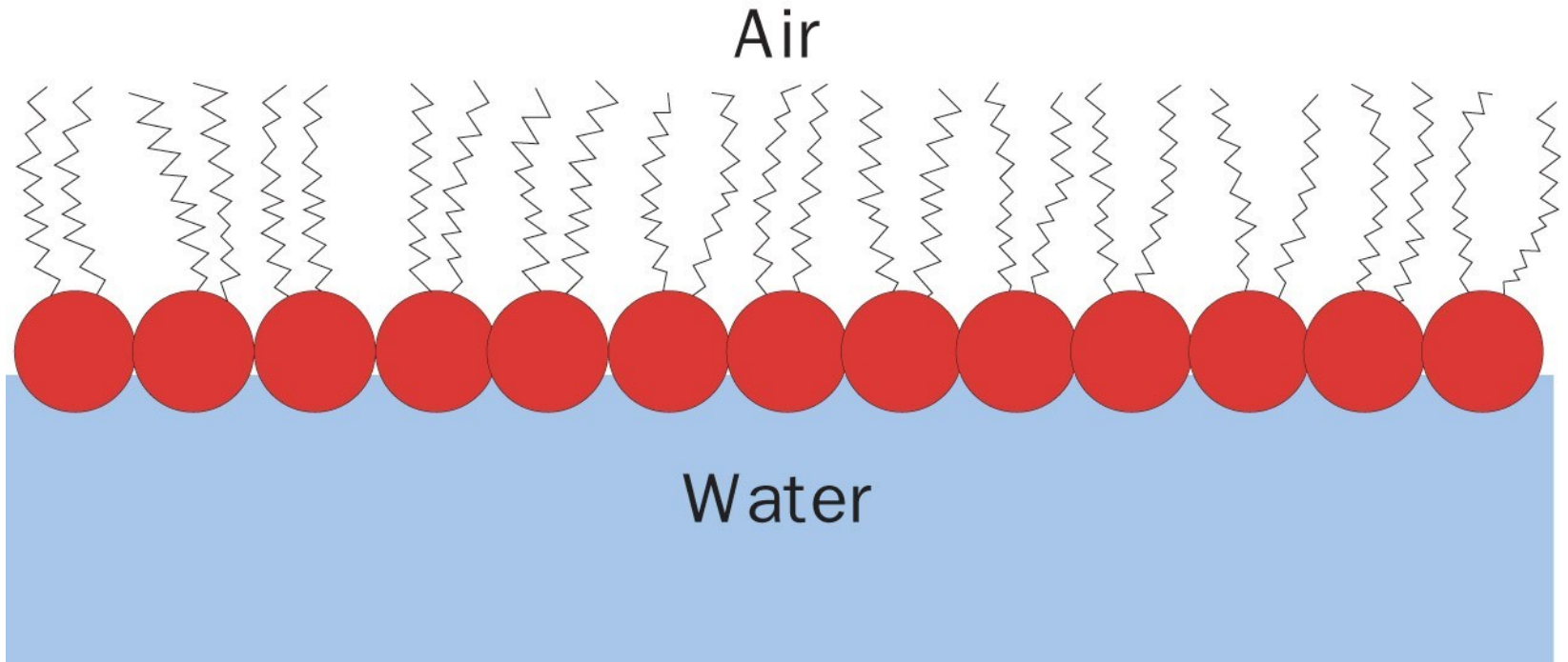

# Membrány

(a)



van der Waals  
envelope

(b)

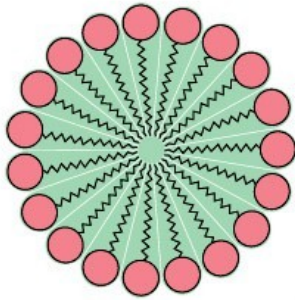

(c)

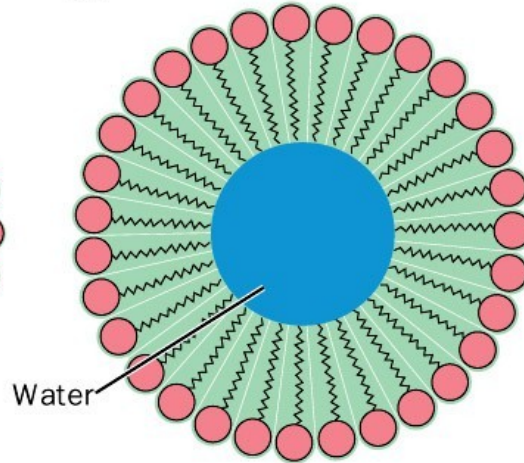

(d)

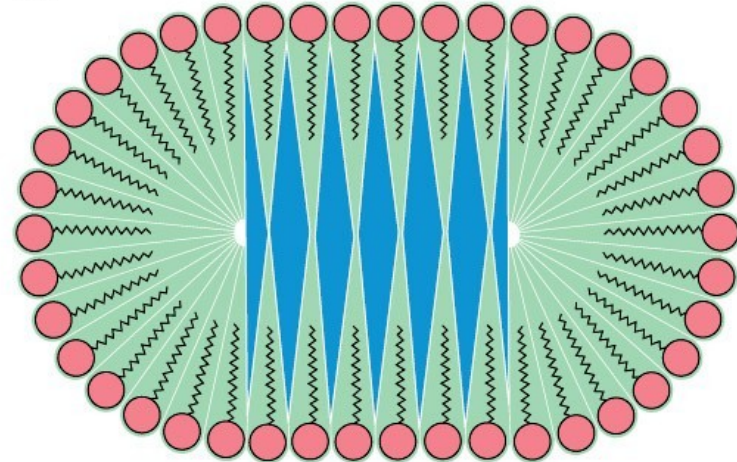

# Membrány

(a)

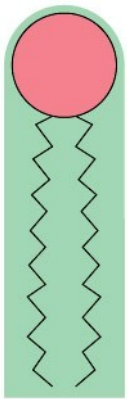

(b)

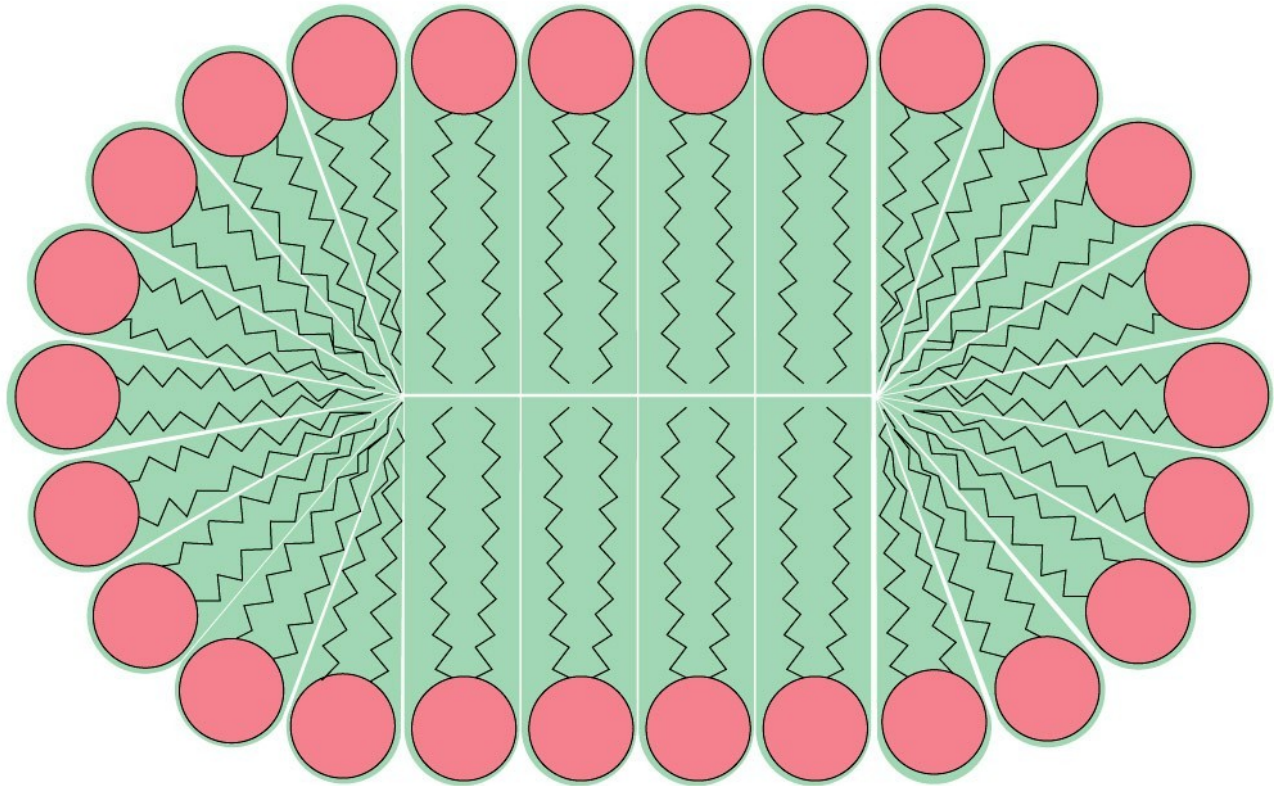

# Membrány

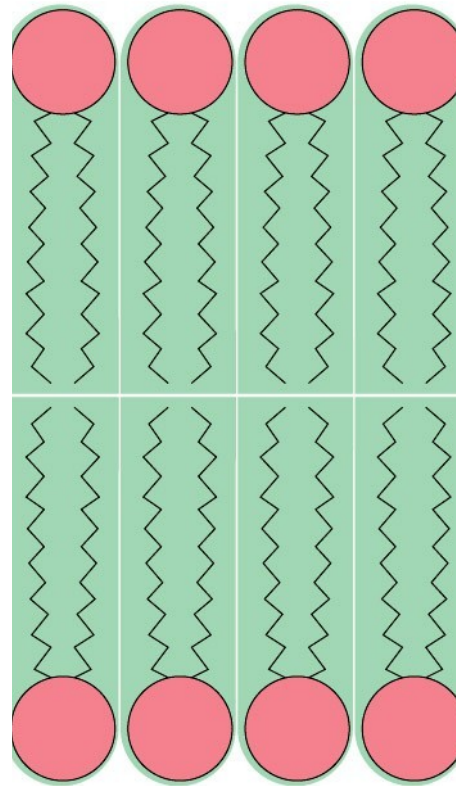

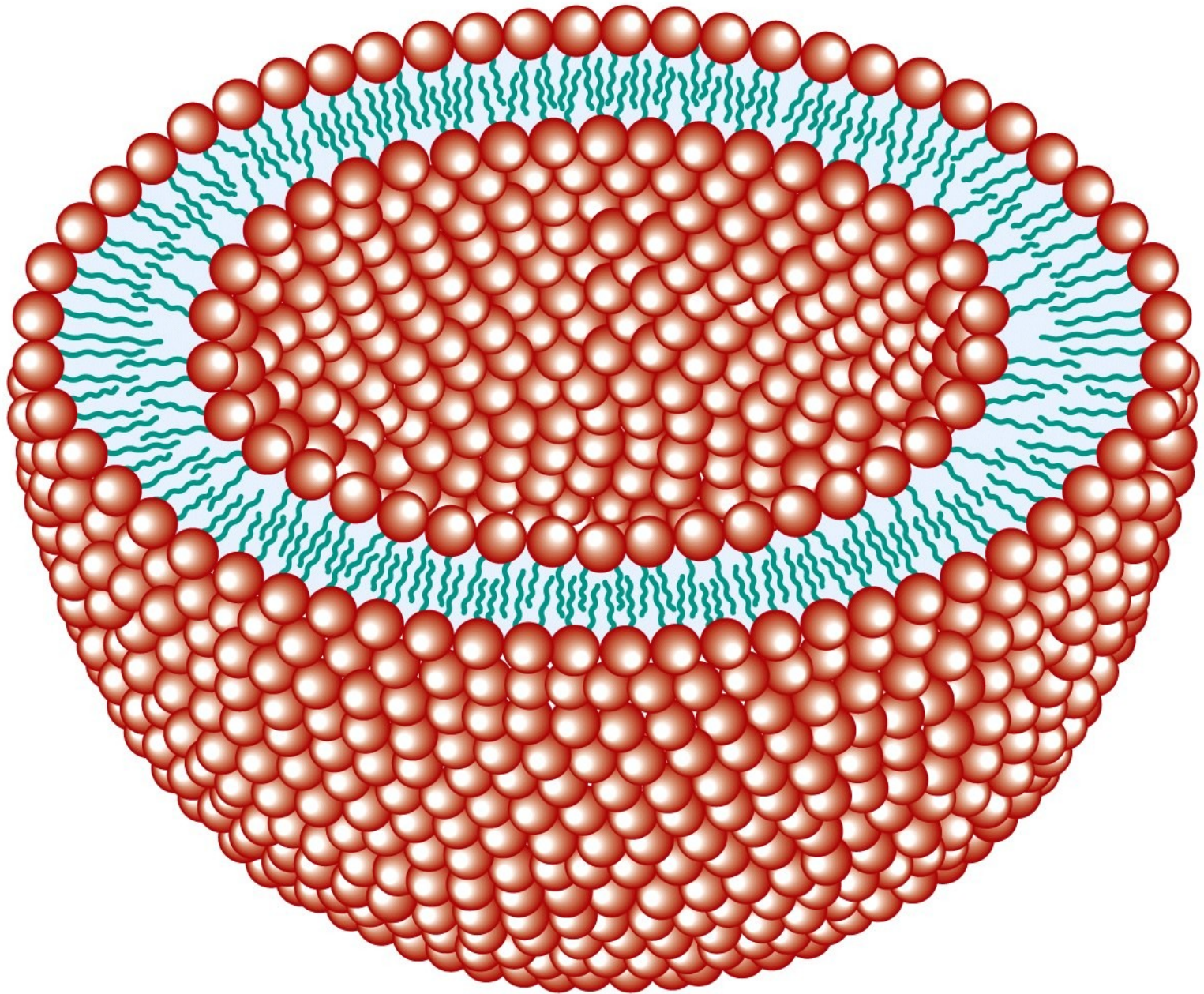

**Figure 9-1b** Concepts in Biochemistry, 3/e  
© 2006 John Wiley & Sons



## **Biomembrány : agregované formy biolipidů**

### **Význam biomembrán - transport**

- kompartmentace

- komunikace

### **Molekulové složení membrán**

<b>Membrána</b>	<b>proteiny</b> %	<b>lipidy</b> %	<b>sacharidy</b> %
<b>cytoplazmatická</b>	<b>49</b>	<b>43</b>	<b>8</b>
<b>jaderná</b>	<b>59</b>	<b>35</b>	<b>2</b>
<b>mitochondriální vnější</b>	<b>52</b>	<b>46</b>	<b>2</b>
<b>mitochondriální vnitřní</b>	<b>76</b>	<b>23</b>	<b>1</b>
<b>myelinová</b>	<b>18</b>	<b>79</b>	<b>3</b>

- *Lipidy* - fosfolipidy, cholesterol

funkce - strukturní

Lipid (%)	erythrocyt	myelin	mitochondrie	E.coli
fosfatidylcholin	19	10	39	0
fosfatidylethanolamin	18	20	27	65
fosfatidylglycerol	0	0	0	18
kardiolipin	0	0	23	12
sfingomyelin	18	9	0	0
glykolipidy	10	26	0	0
cholesterol	25	26	3	0

# Fosfolipid, sfingomyelin, gangliosid, kolesterol

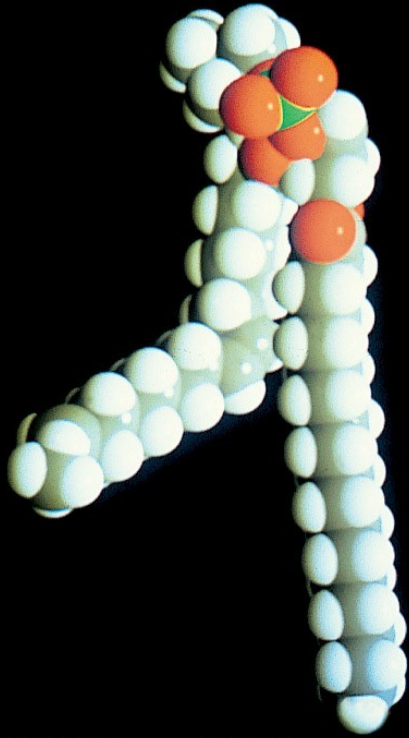

Courtesy of Richard Pastor, FDA, Bethesda, Maryland

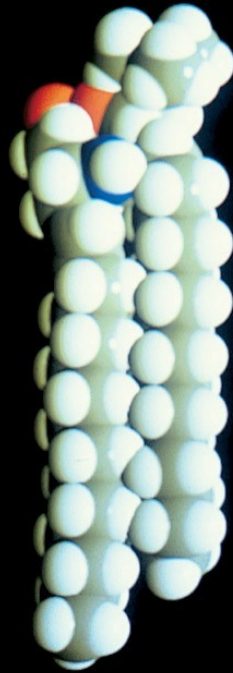

Courtesy of Richard Pastor, FDA, Bethesda, Maryland



Courtesy of Richard Venable, FDA, Bethesda, Maryland

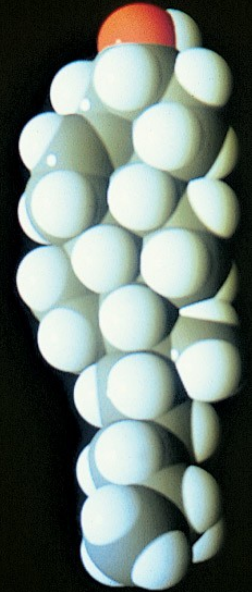

Courtesy of Richard Pastor, FDA, Bethesda, Maryland

- *Bílkoviny* - integrální, periferní

funkce - enzymy

přenašeče

receptory

strukturní

- *Sacharidy* - glykolipidy, glykoproteiny

funkce - kotvení glykolipidů a glykoproteinů

v membránách

- rozpoznávací

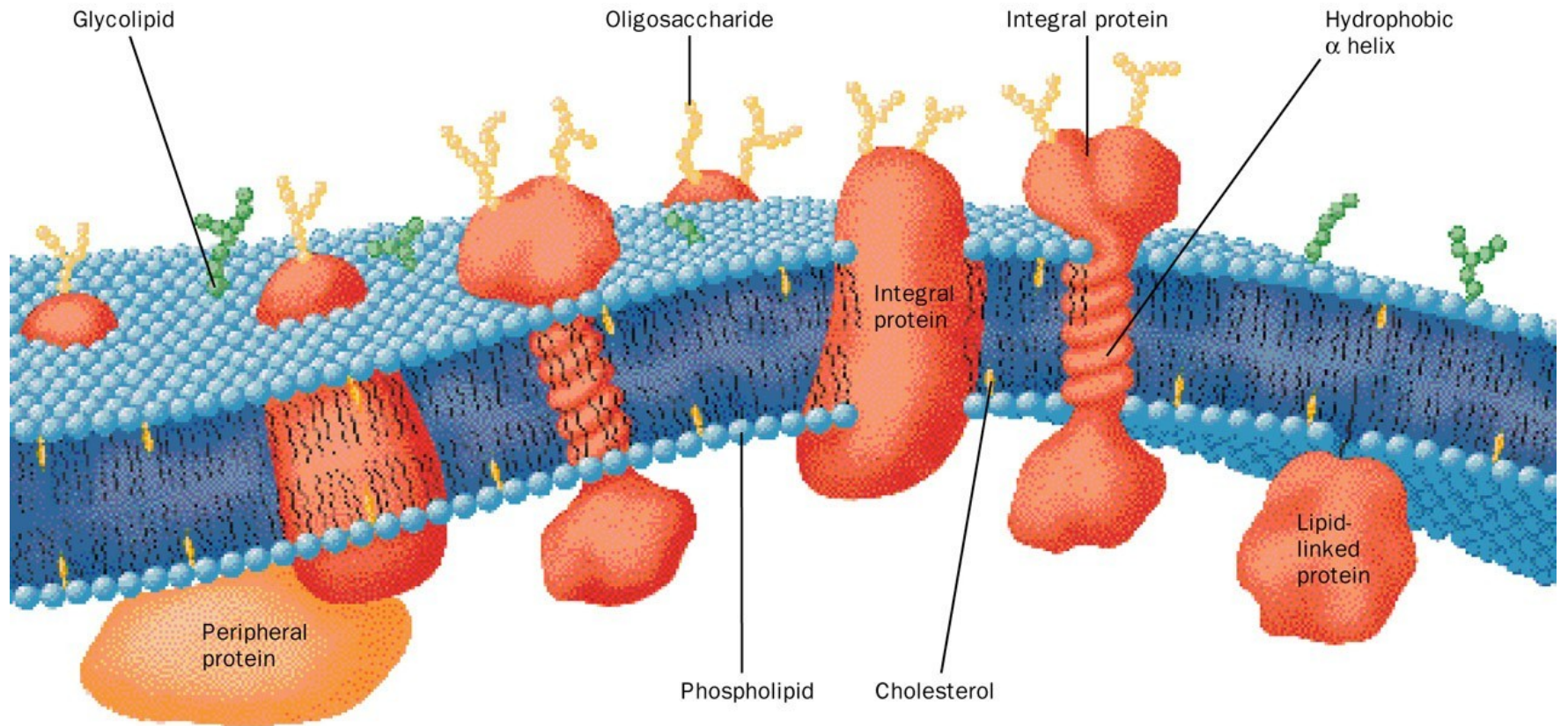

# Bakteriorhodopsin

(a)



(b)

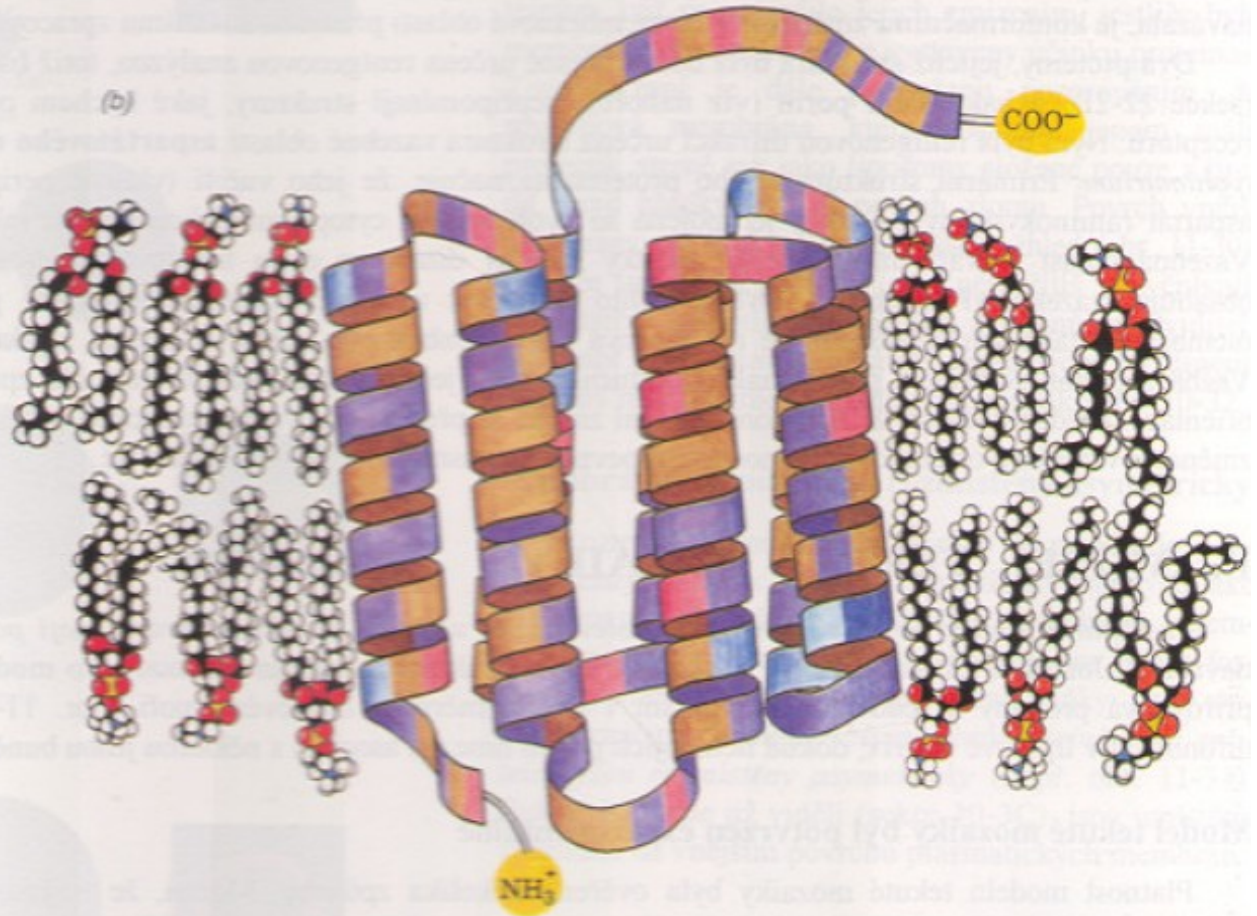

## Modely membrán :

GORTER a GRENDL (1925) - Lipidová dvojvrstva

SINGER a NICHOLSON (1972) - Model tekuté mozaiky

# Lipidická dvojvrstva

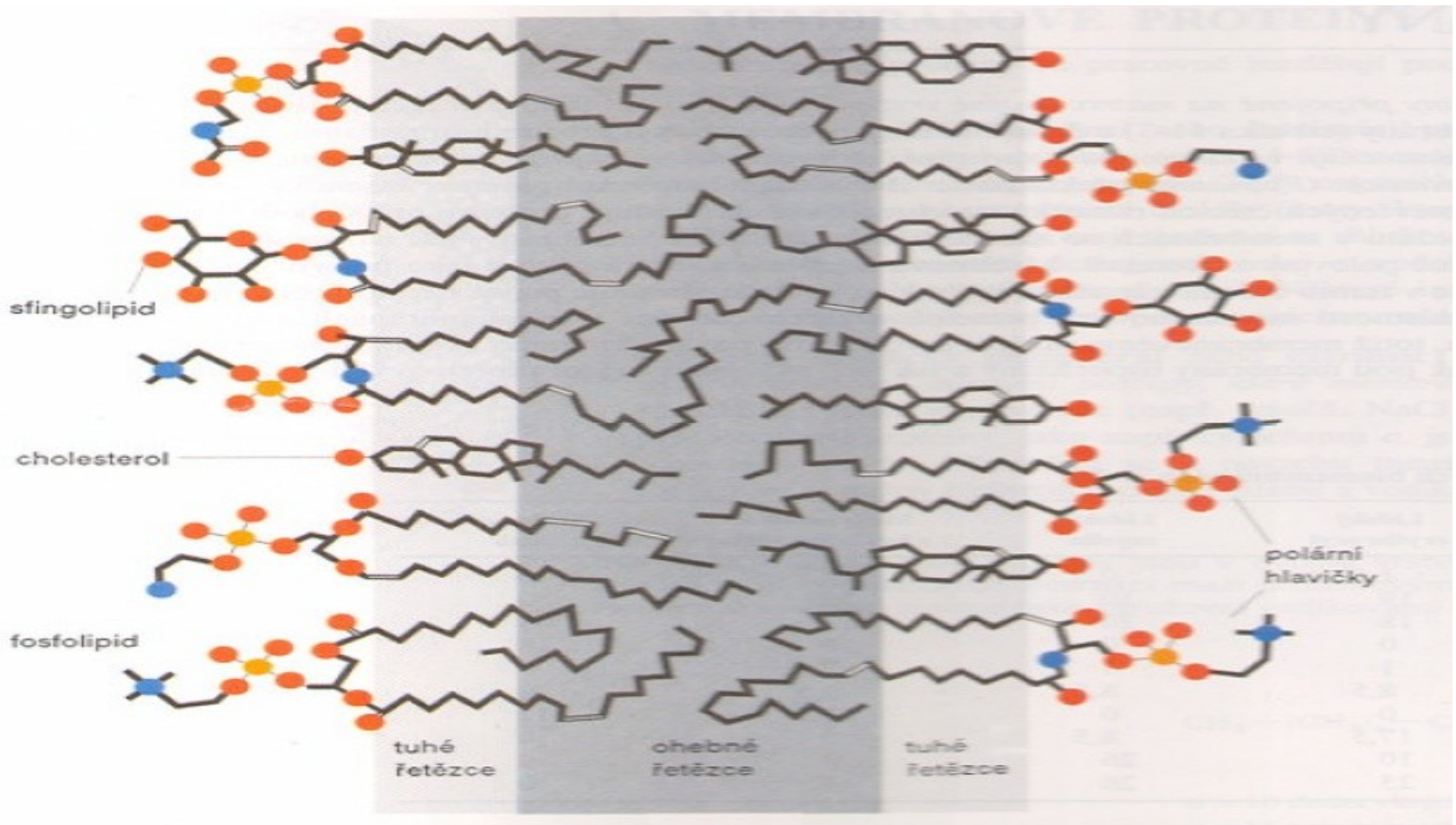



# Model tekuté mozaiky

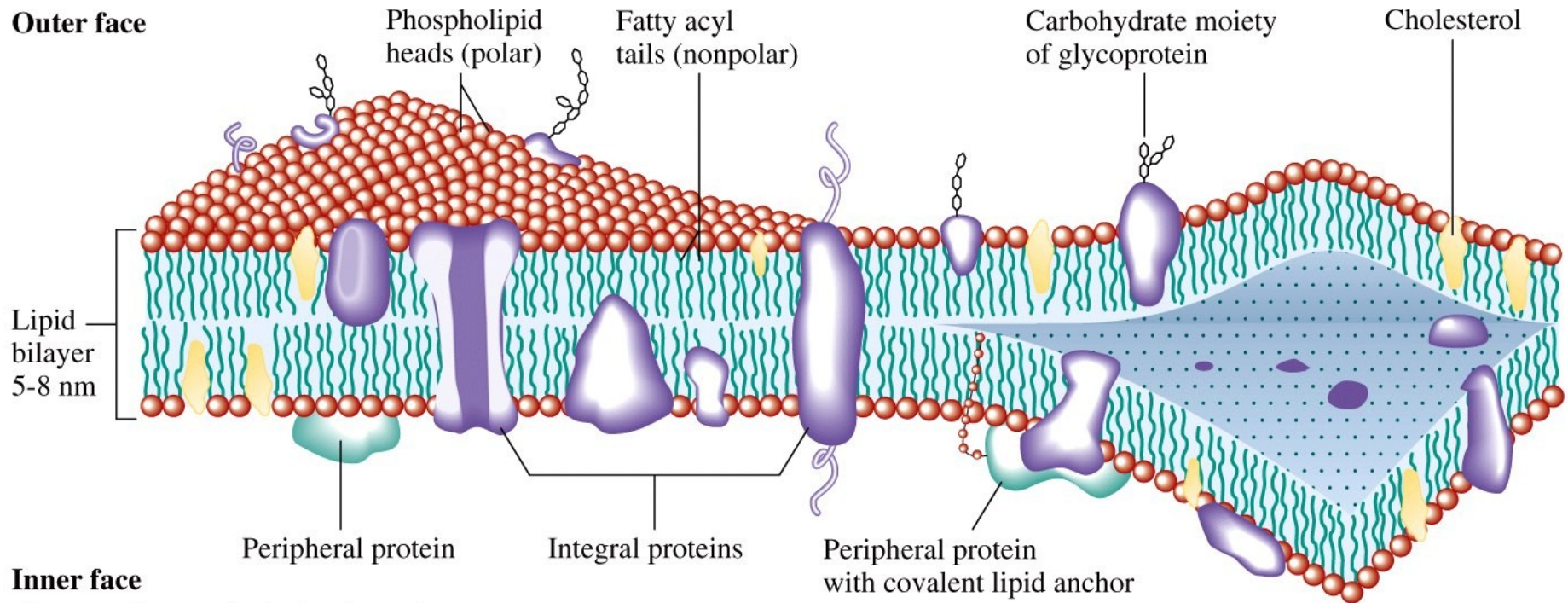
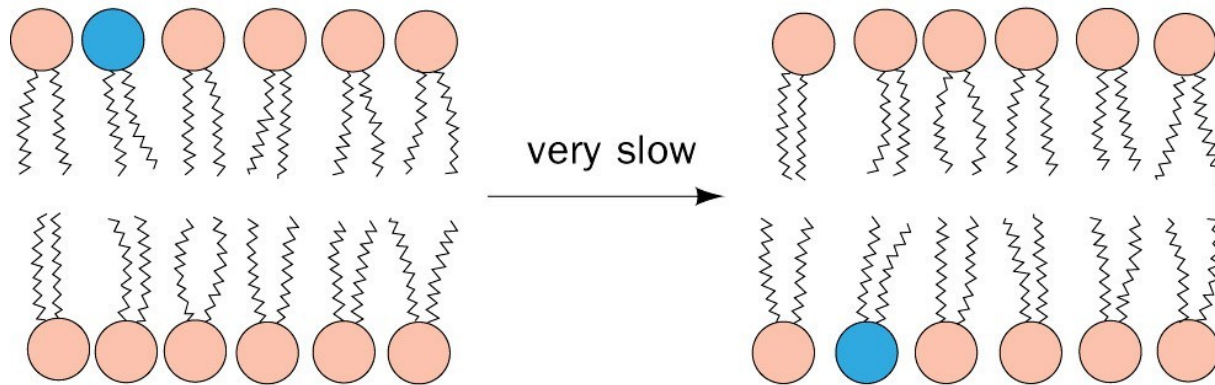

Figure 9-6 Concepts in Biochemistry, 3/e  
© 2006 John Wiley & Sons

# Difuze lipidů v membráně

(a) Transverse diffusion (flip-flop)



(b) Lateral diffusion

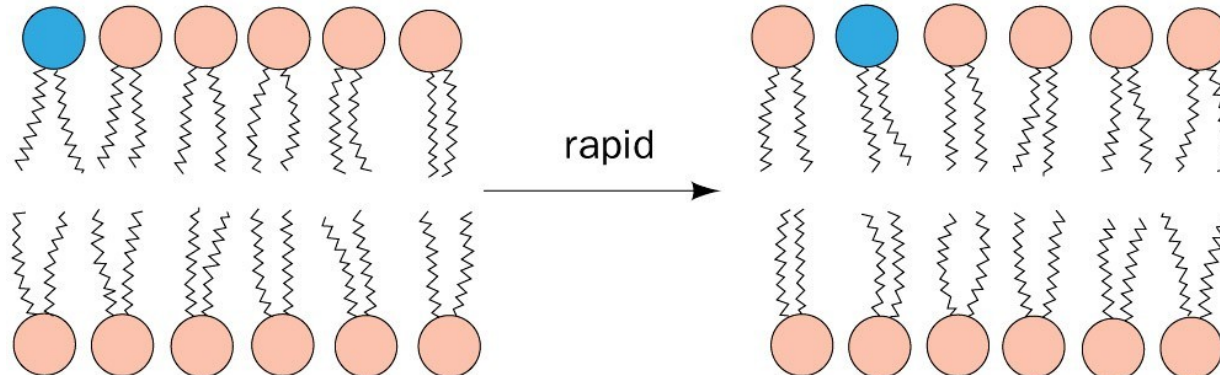

# Difuze lipidů v membráně

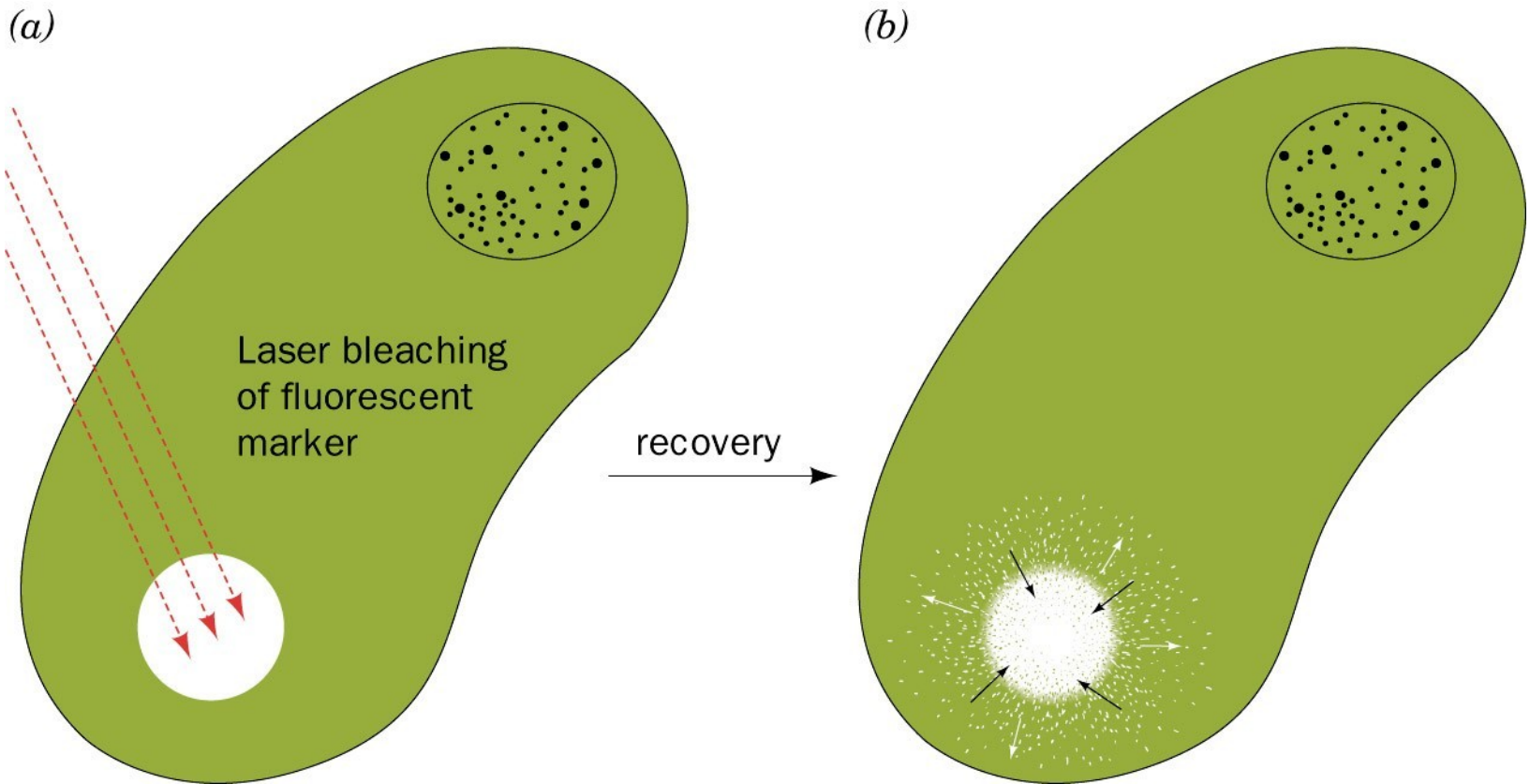

# Liposomy

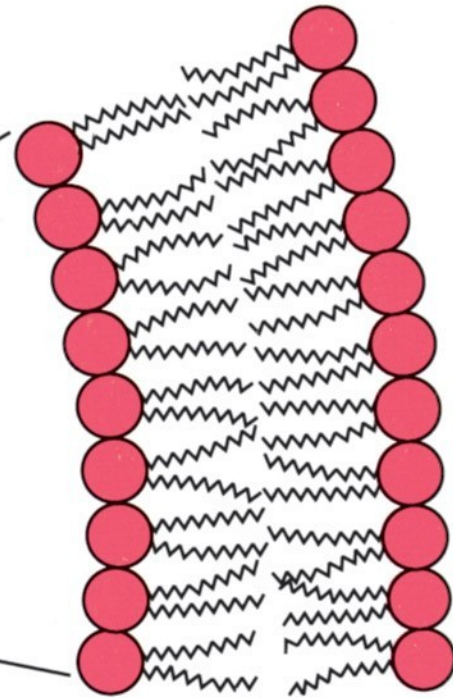
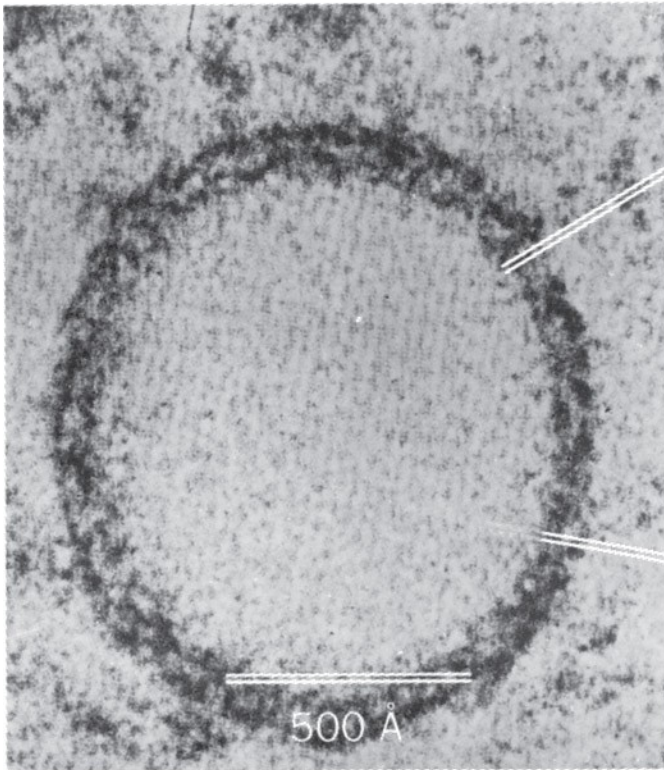

Courtesy of Walter Stoeckenius, University of California at San Francisco

# Liposomy

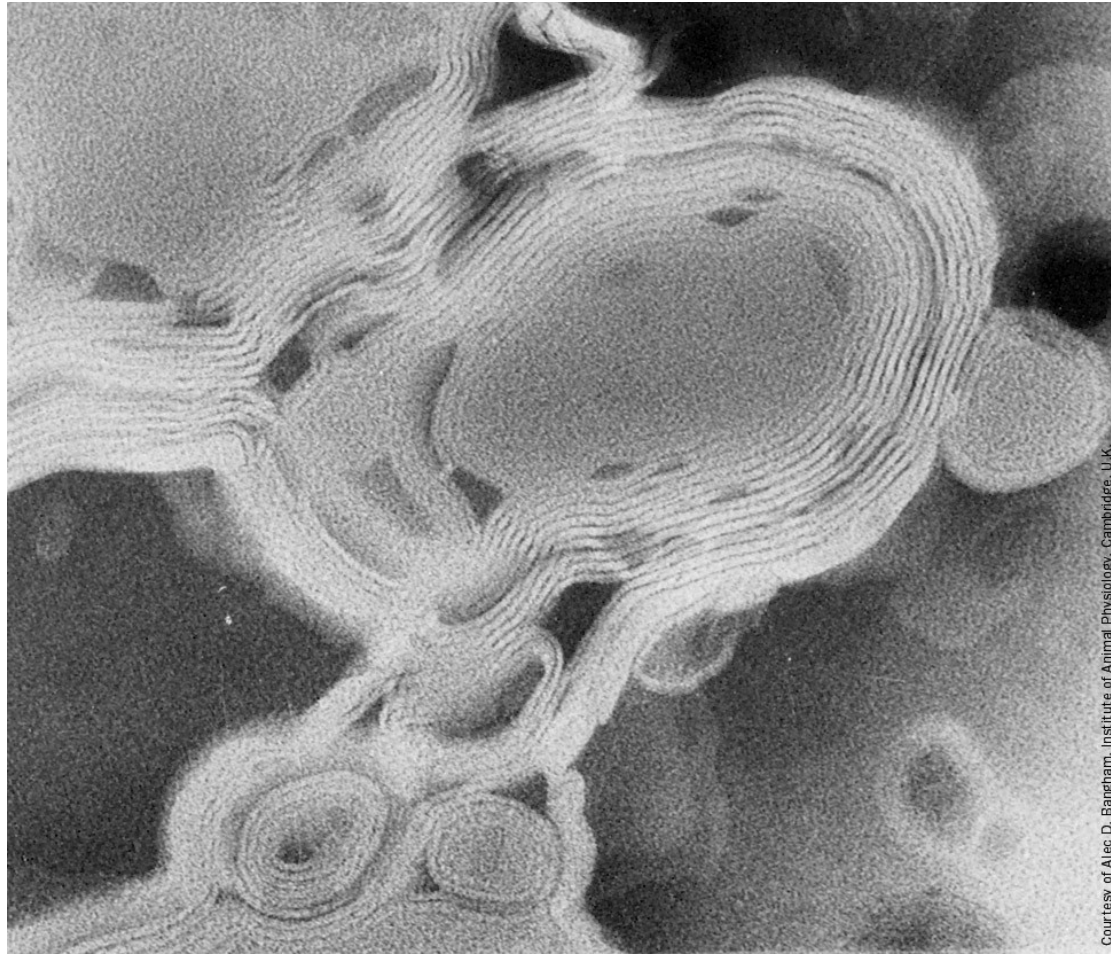

## Transport látek membránami :

- Nespecifická permeace
- Specifický přenašečový systém - pasivní transport - usnadněná  
a výměnná  
difuze  
- aktivní transport
- Pinocytóza

# Typy transportu

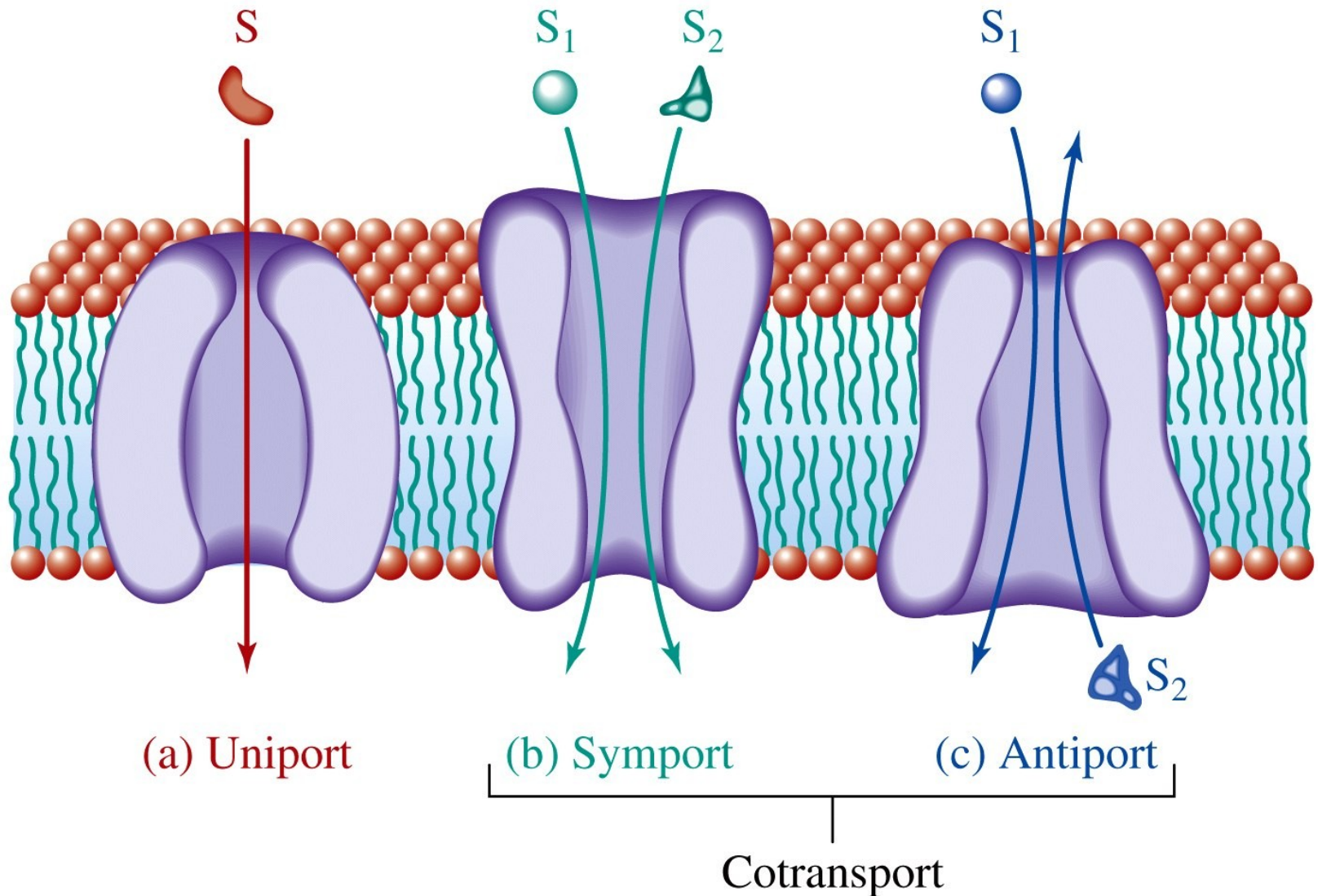

# Prostá difuze

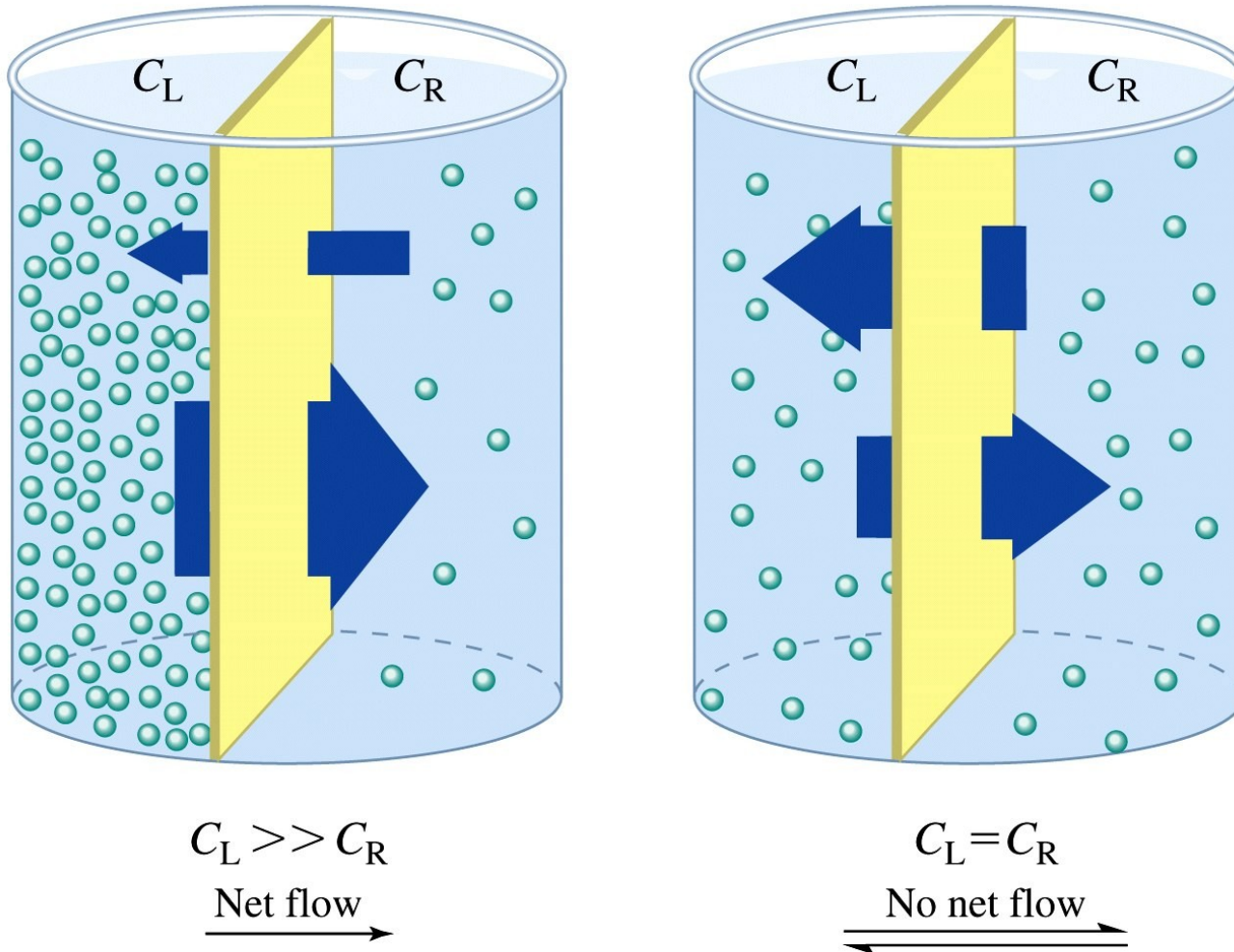



# Prostá difuze

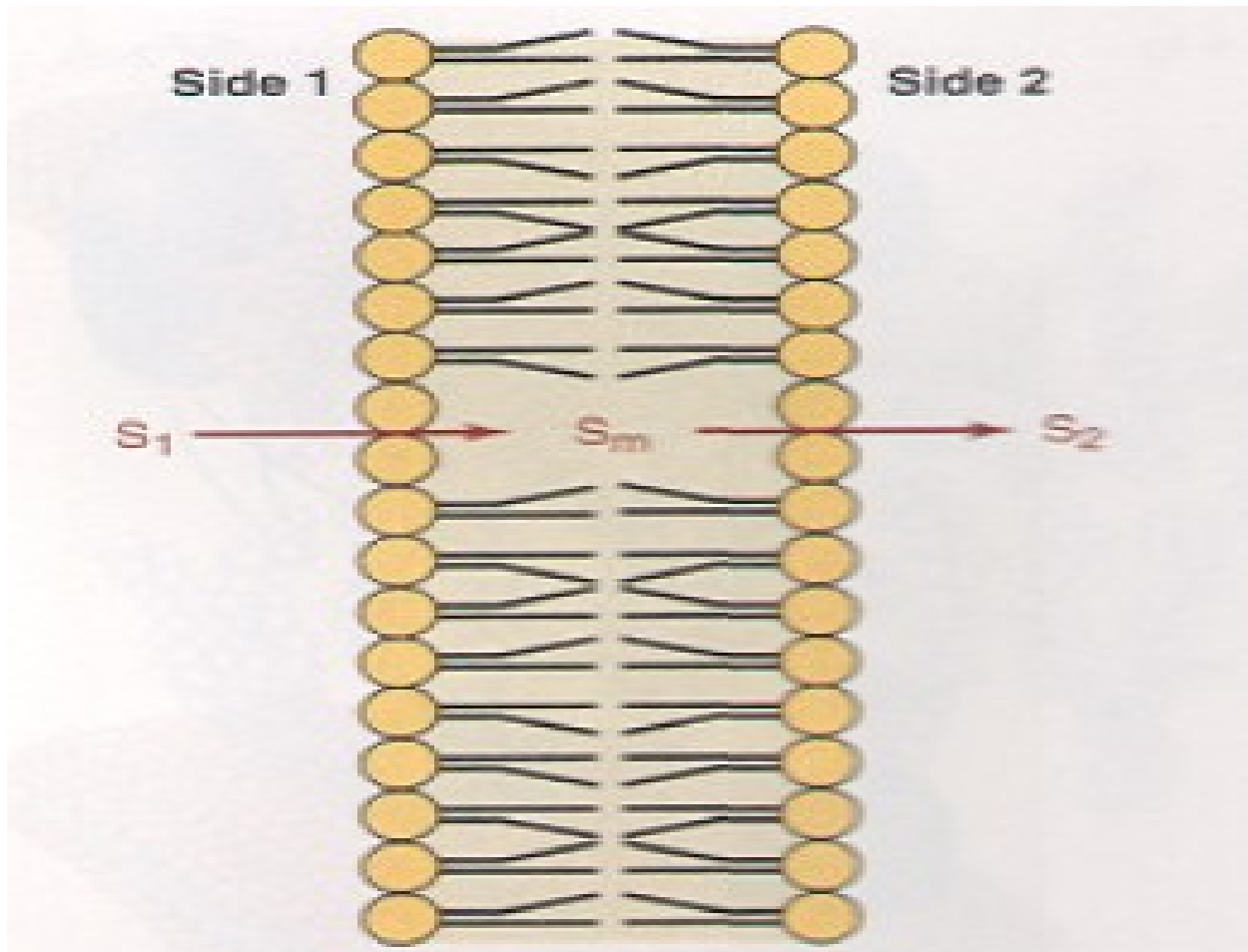

# Mezerový spoj

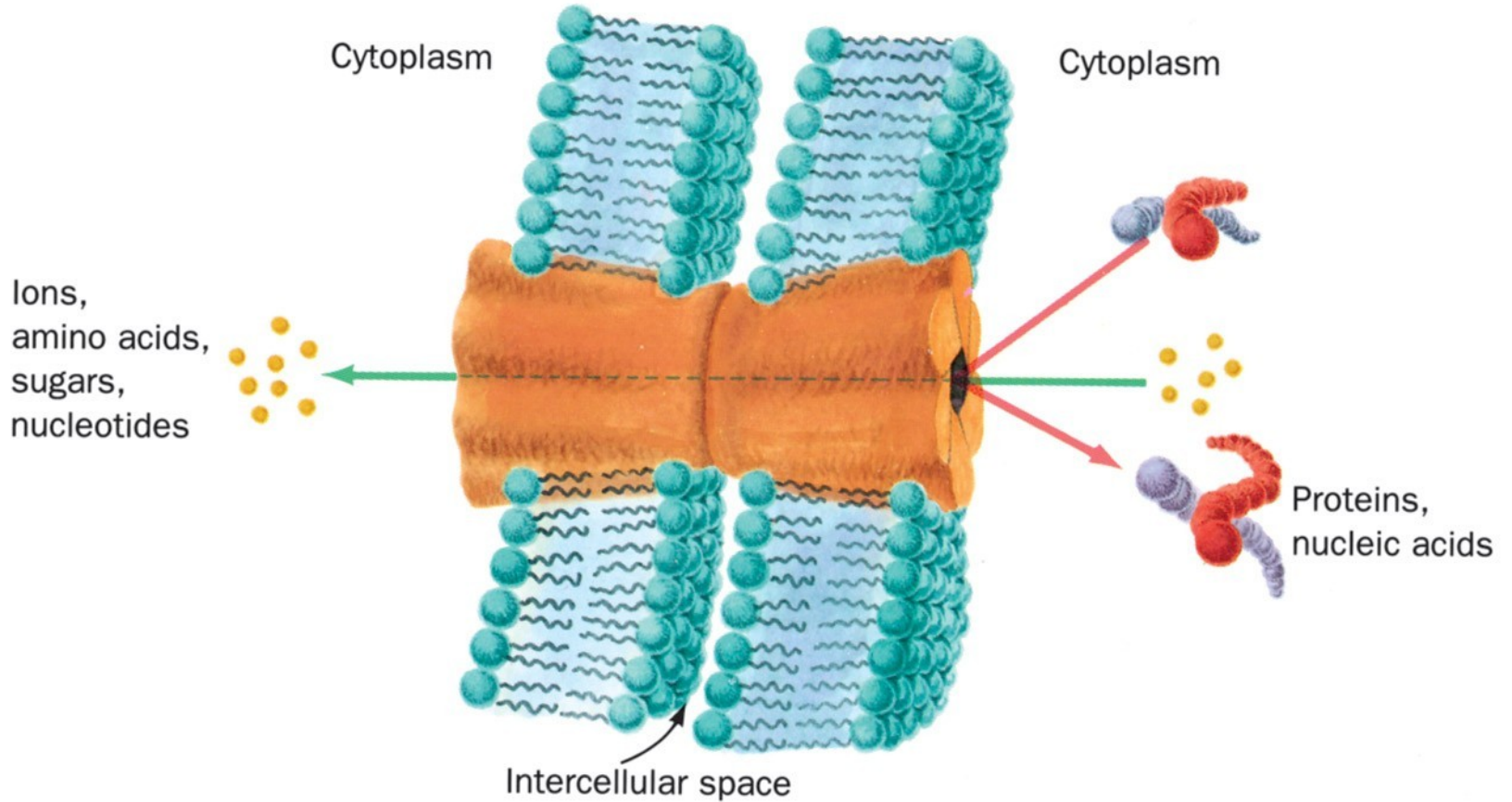

# Difuze prostá versus usnadněná

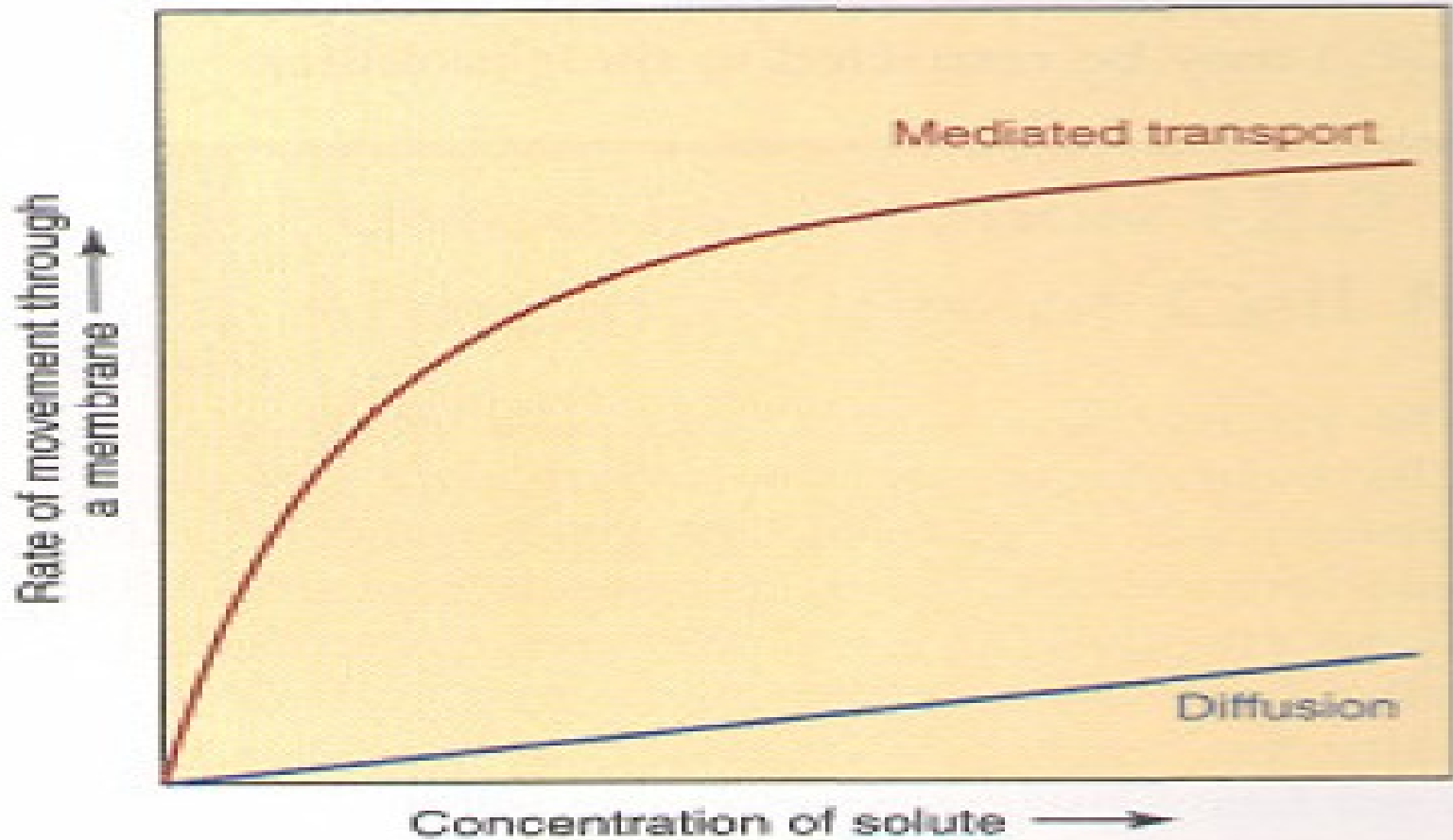

# Usnadněná difuze

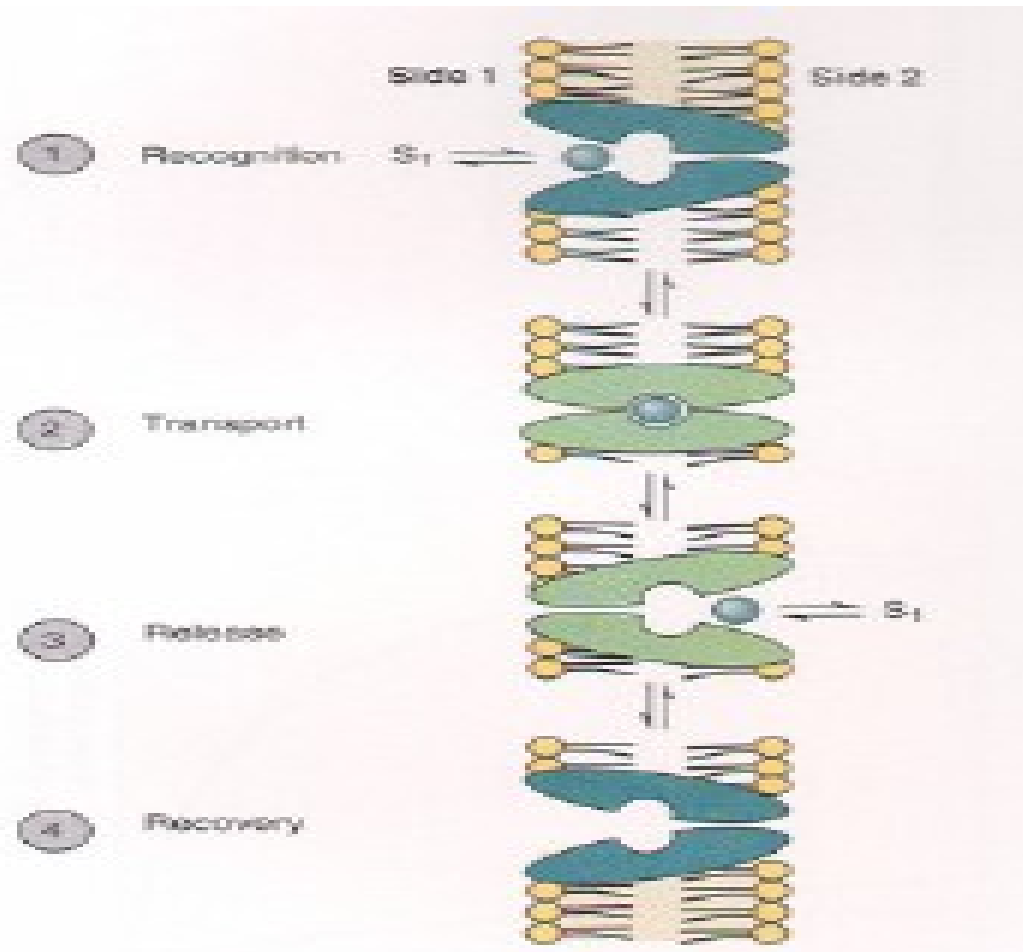

# Usnadněná difuze

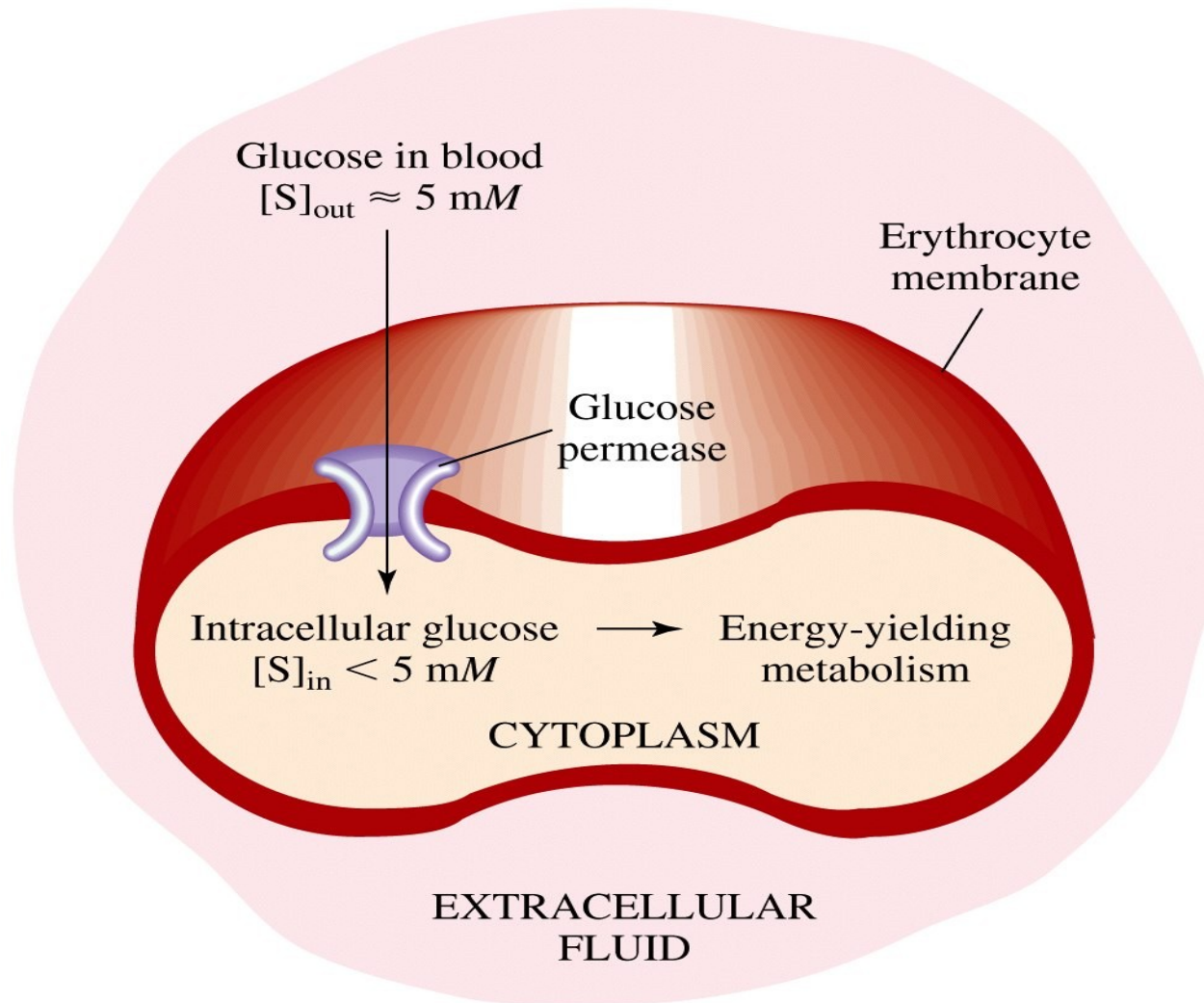

# Aktivní transport

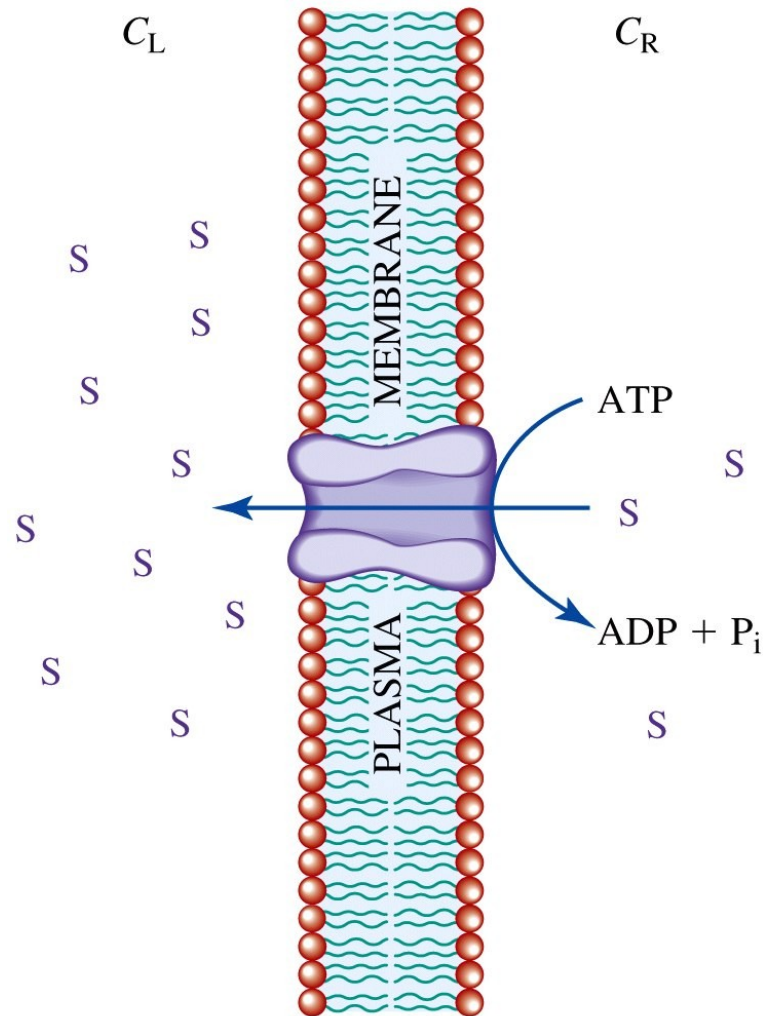
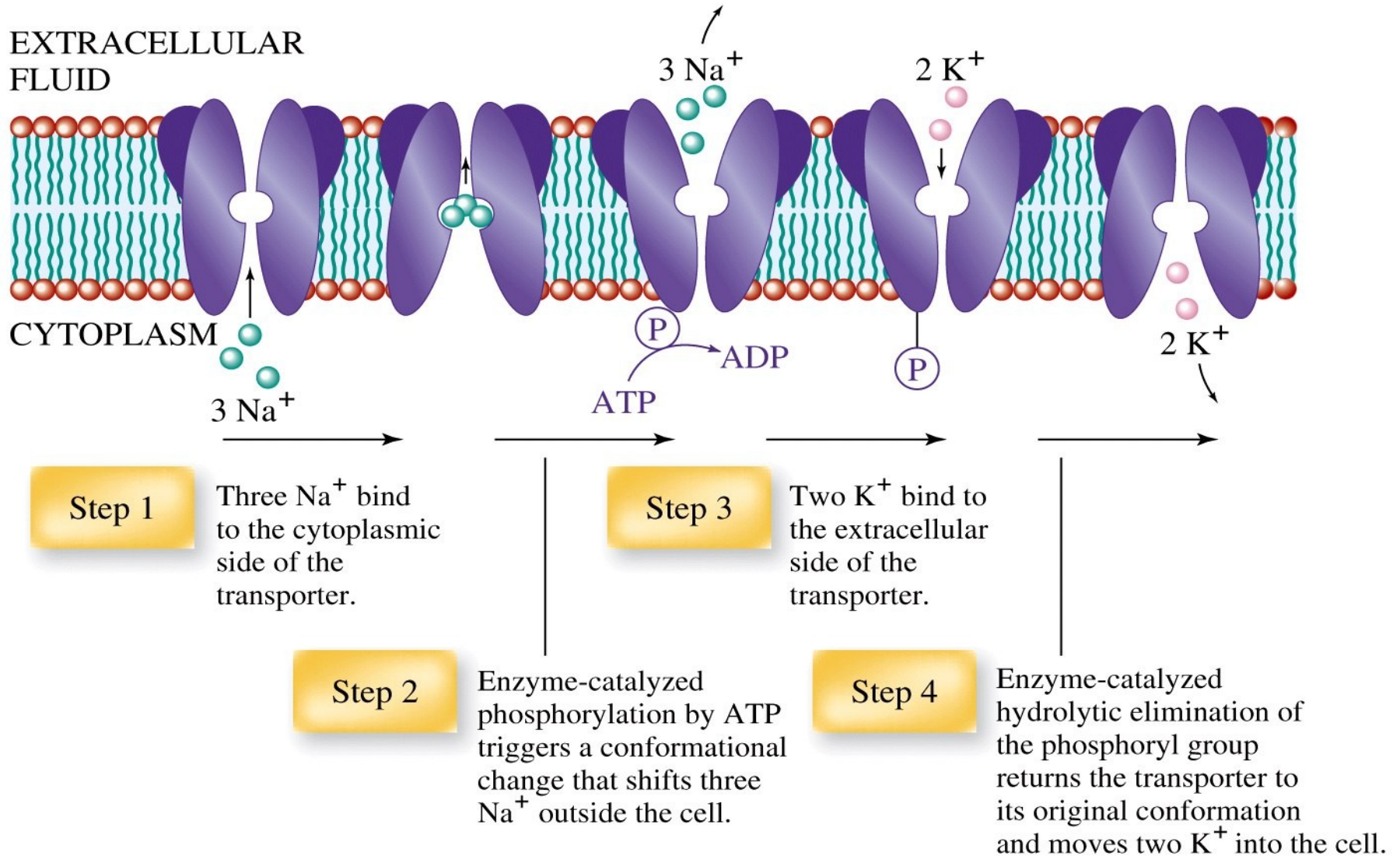

Figure 9-9 Concepts in Biochemistry, 3/e  
© 2006 John Wiley & Sons

# Na<sup>+</sup> ATPase



# Pinocytosis

