

Regulation of cell function by FGFR3 receptor tyrosine kinase

Pavel Krejci

Medical Genetics Institute, Cedars-Sinai Medical Center, Los Angeles, CA
Institute of Experimental Biology, Masaryk University, Brno, Czech Republic

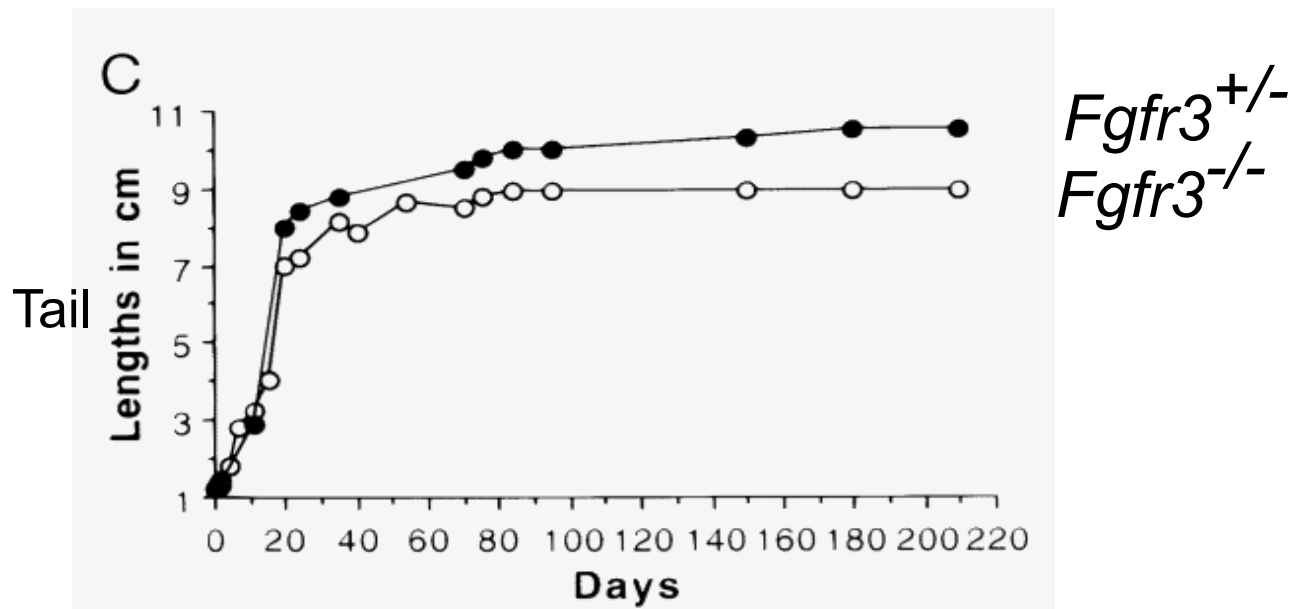
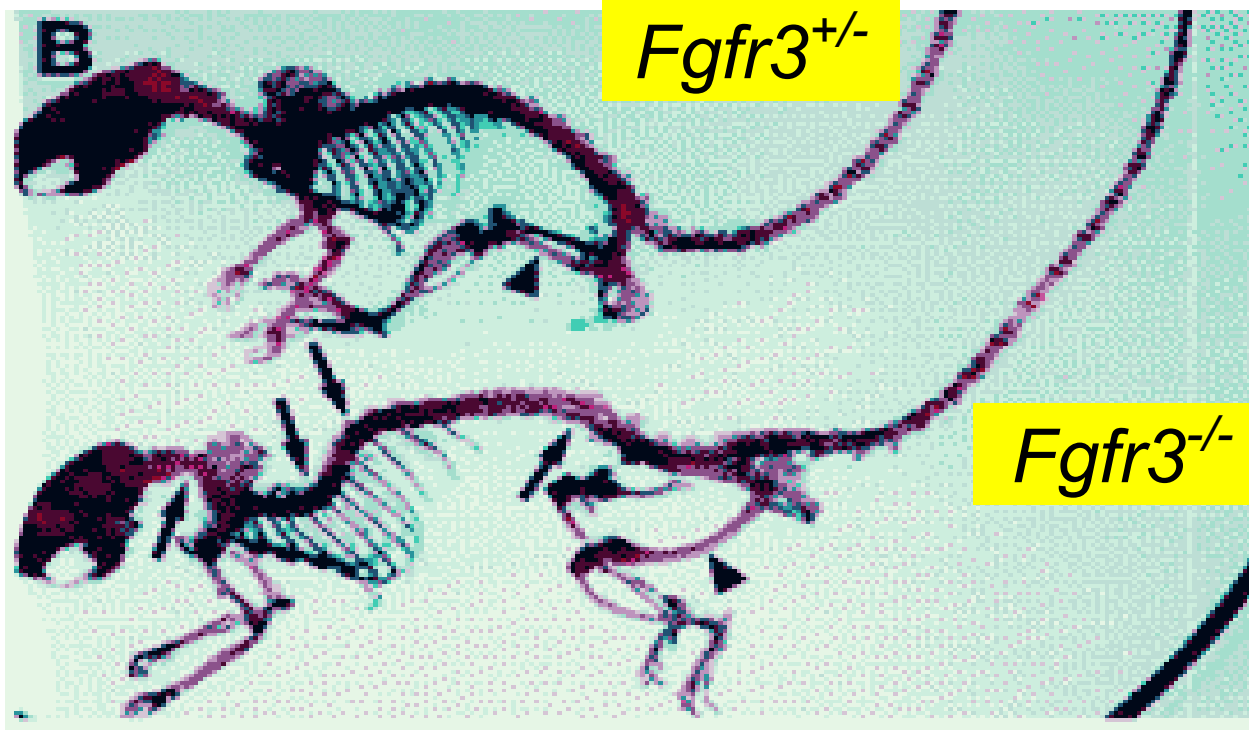

FGFR3-related skeletal dysplasias

Thanatophoric Dysplasia

Achondroplasia

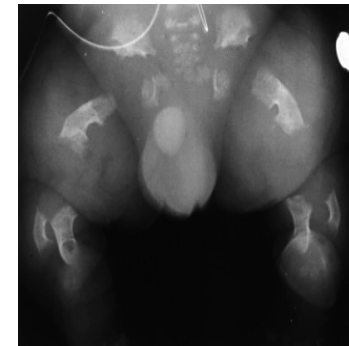
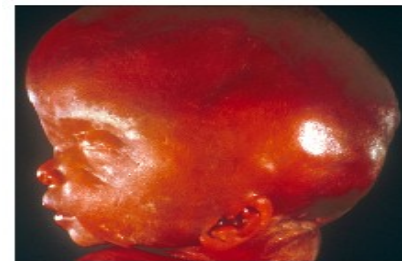

- short long bones
- brachydactyly
- macrocephaly
- low nasal bridge
- spinal stenosis
- temporal lobe malformations

FGFR3-related skeletal dysplasia

Hypochondroplasia
Achondroplasia
SADDAN
Thanatophoric Dysplasia

STATURE

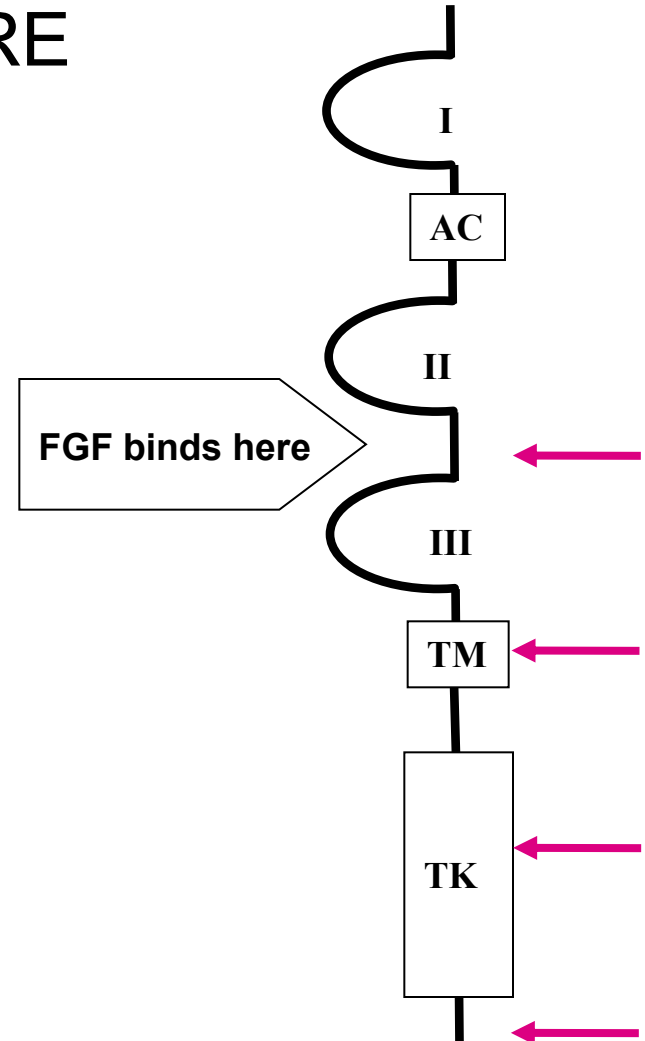

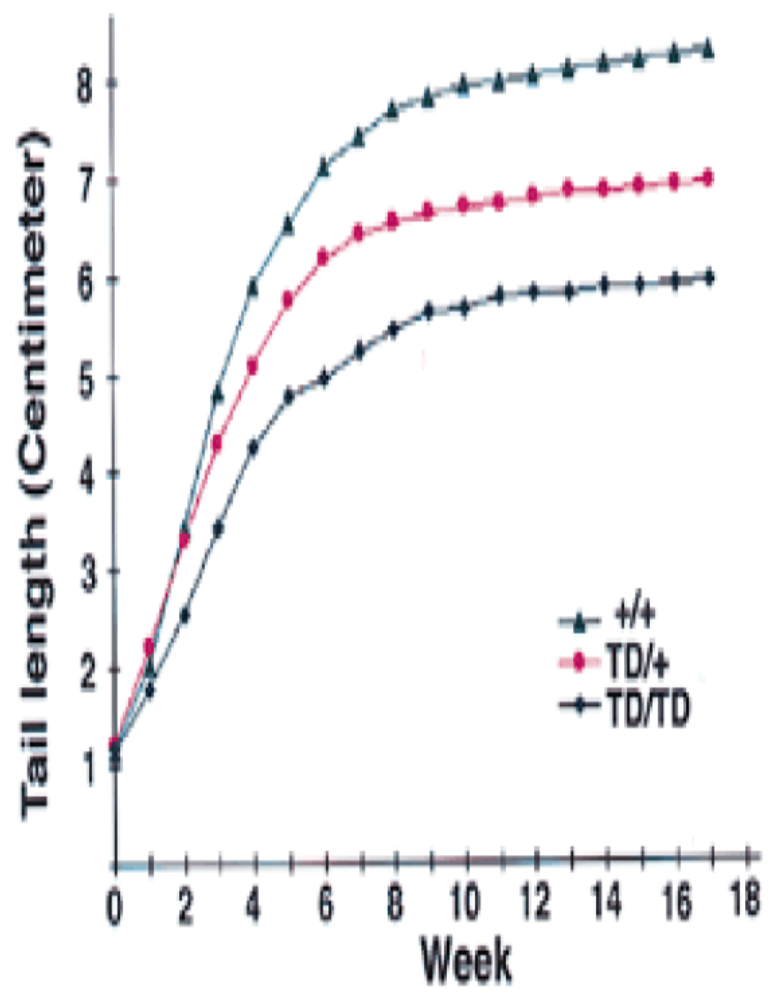
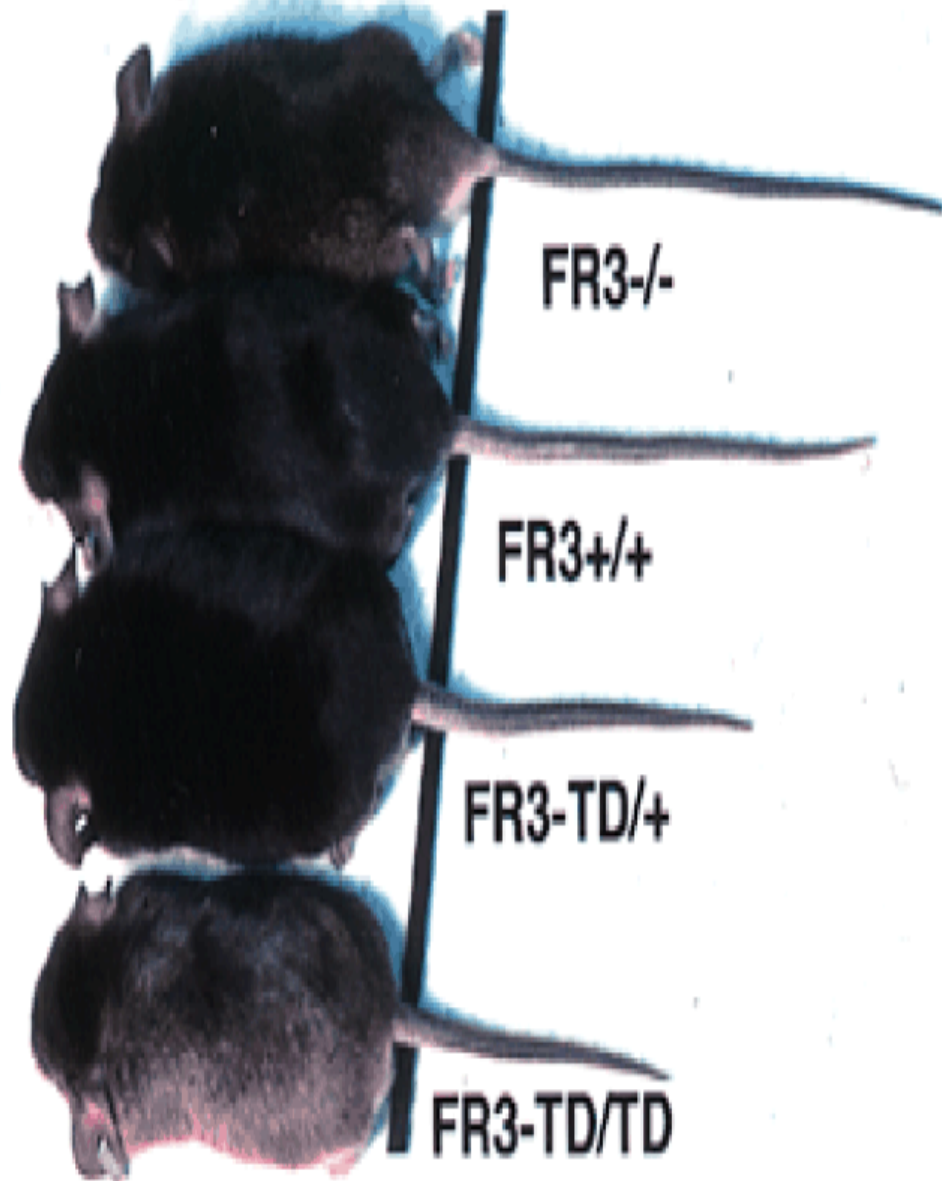

Frequent activating mutations of *FGFR3* in human bladder and cervix carcinomas

epithelia (data not shown), we examined the expression and mutational status of *FGFR3* in a series of bladder and cervix carcinomas to determine whether *FGFR3* is involved in epithelial tumorigenesis.

We assessed transcript levels of the two *FGFR3* variants¹⁴, *FGFR3b* and *FGFR3c*,

Frequent translocation t(4;14)(p16.3;q32.3) in multiple myeloma is associated with increased expression and activating mutations of fibroblast growth factor receptor 3

Marta Chesi¹, Elena Nardini², Leslie A. Brents¹, Evelin Schröck³, Thomas Ried³, W. Michael Kuehl¹ & P. Leif Bergsagel²

Activating mutations in *FGFR3* and *HRAS* reveal a shared genetic origin for congenital disorders and testicular tumors

Anne Goriely¹, Ruth M S Hansen¹, Indira B Taylor¹, Inge A Olesen², Grete Krag Jacobsen³, Simon J McGowan⁴, Susanne P Pfeifer⁵, Gilean A T McVean⁵, Ewa Rajpert-De Meyts² & Andrew O M Wilkie¹

Skeleton: hypochondroplasia, achondroplasia, thanatophoric dysplasia, SADDAN, Muenke syndrome

Skin: epidermal nevi, seborrhaeic keratosis, acanthosis nigricans

Cancer: multiple myeloma, bladder cancer, seminoma

Investors

[Overview](#)
[Financial Information](#)
[SEC Filings](#)
[Corporate Governance](#)
[Investors' Kit](#)
[Calendar of Events](#)



[Home](#) [Investors](#) [RSS Content](#)

RSS Content

BioMarin Announces Program for BMN-111 for the Treatment of Achondroplasia

NOVATO, Calif., Oct 19, 2010 /PRNewswire via COMTEX/ --

BioMarin Pharmaceutical Inc. (Nasdaq: BMRN) today announced its program for BMN-111, a peptide therapeutic for the treatment of achondroplasia. BioMarin plans to file an IND in the fourth quarter of 2011 and to initiate a Phase 1 clinical trial by the first quarter of 2012.

BMN-111, for the treatment of achondroplasia, is an analog of C-type Natriuretic Peptide (CNP), a small cyclic peptide that is a positive regulator of bone growth. It is produced and has a receptor in the growth plate, and along with the fibroblast growth factor receptor 3 (FGFR3), regulates normal bone growth. In addition to short stature, there are complications in achondroplasia that are related to bone compression (e.g. foramen magnum narrowing, spinal stenosis, upper respiratory narrowing) of nervous tissues or other tissues.

Exp Cell Res. 2004;297:152-64.

J Cell Sci. 2005; 118: 5089-100.

J Biol Chem. 2007 ;282:2929-36.

Pediatr Res. 2007; 61(3):267-72.

Invest New Drugs 2007; 25:391-95.

PLoS One 2008; 3:e3961.

J Cell Sci 2008; 121:272-81.

Cell Signal 2009; 21:151-60.

Hum Mol Genet. 2009; 18:227-40.

J Biol Chem 2010; 285:20644-53.

Bone 2010; 47:102-10.

Leukemia 2011; 25:538-50.

Human Mutation 2012; 33:29-41

healthy

TD

resting

proliferating

hypertrophic

bone

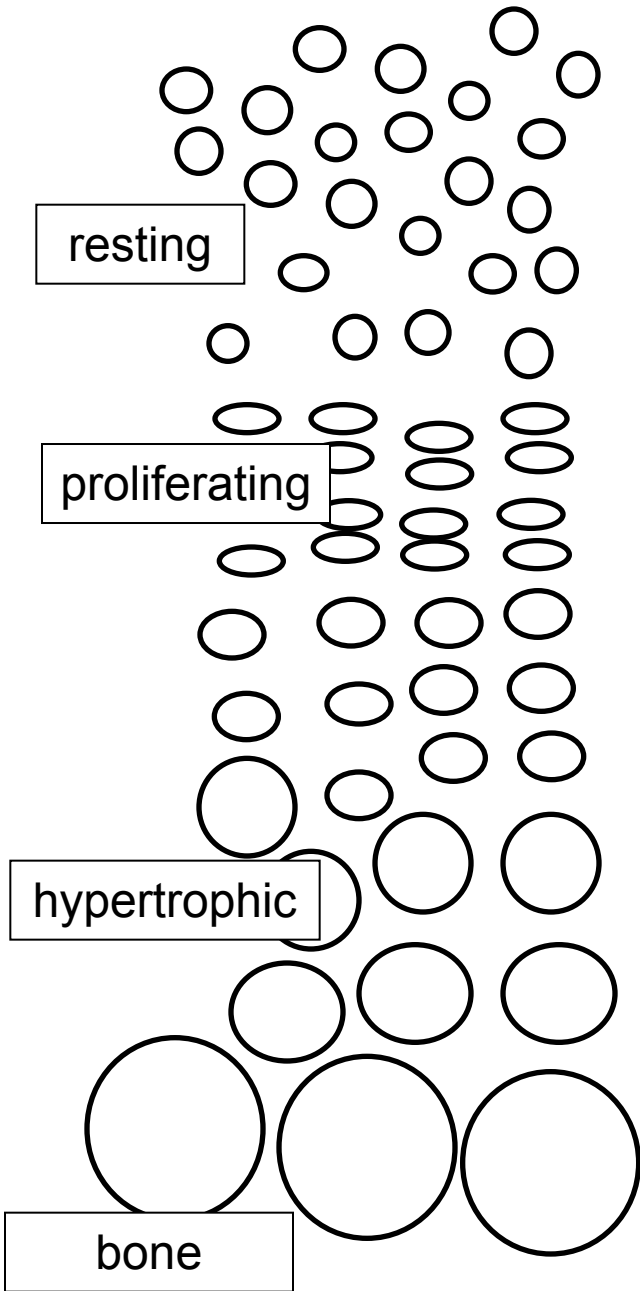
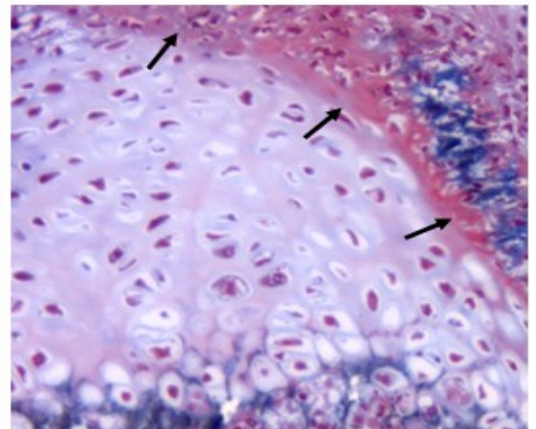
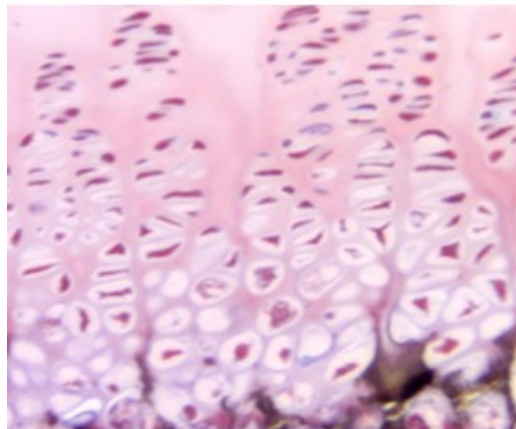
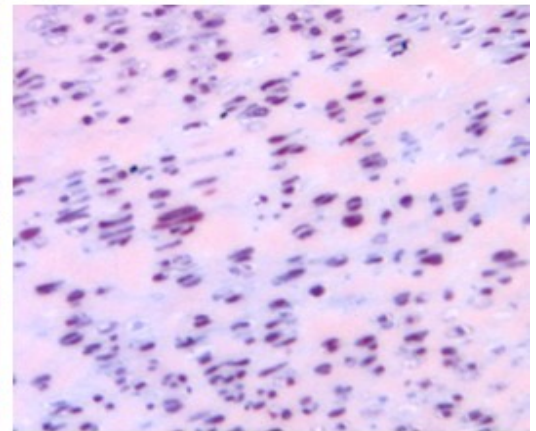
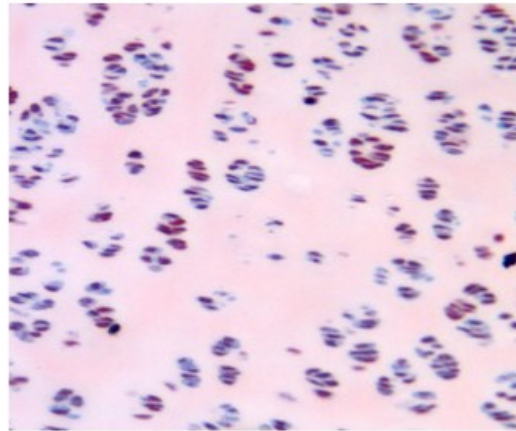
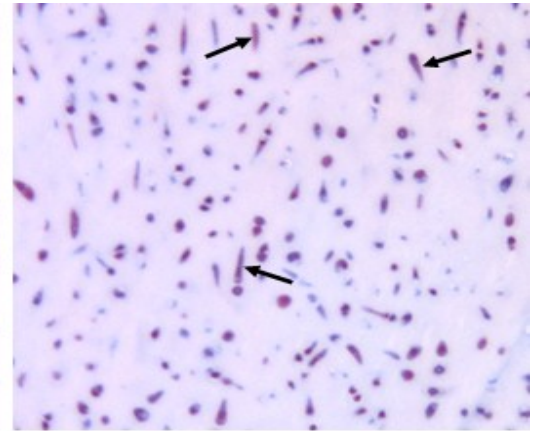
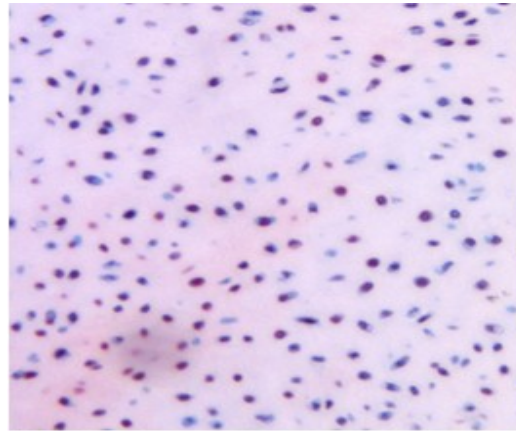

FGFR3 inhibits chondrocyte proliferation by arresting their cell cycle in G1 phase

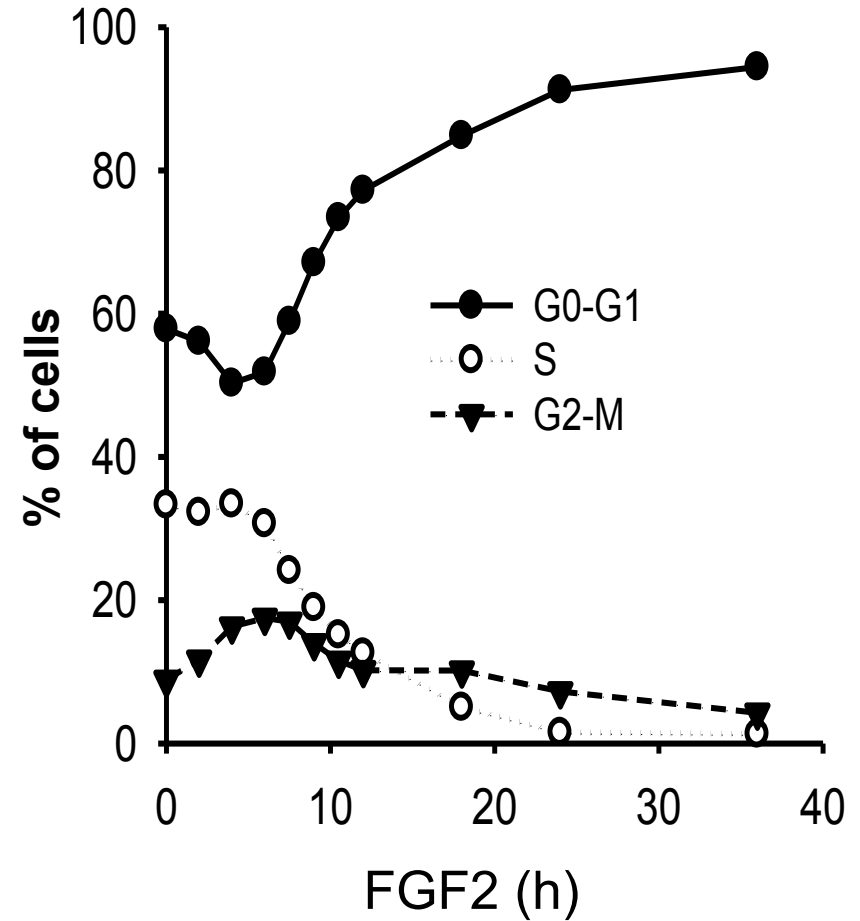
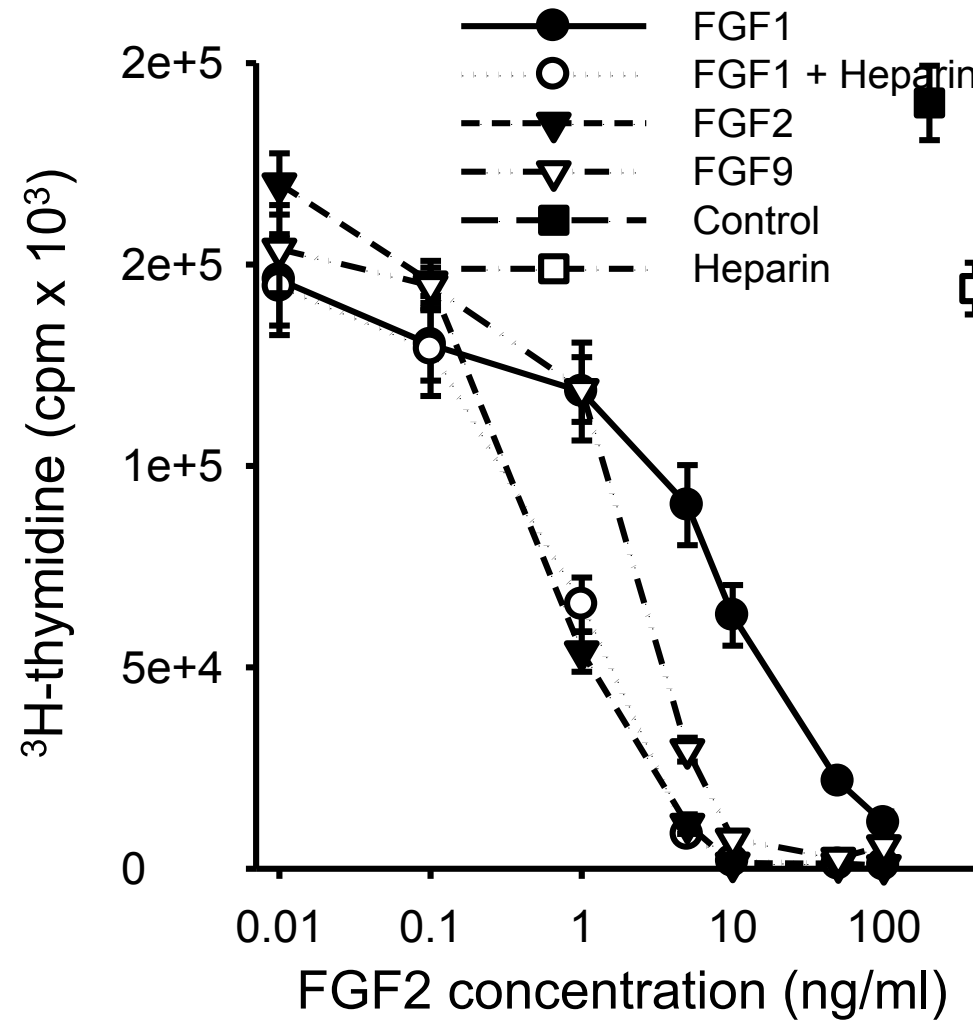

FGFR3 alters the cartilage-like phenotype of chondrocytes

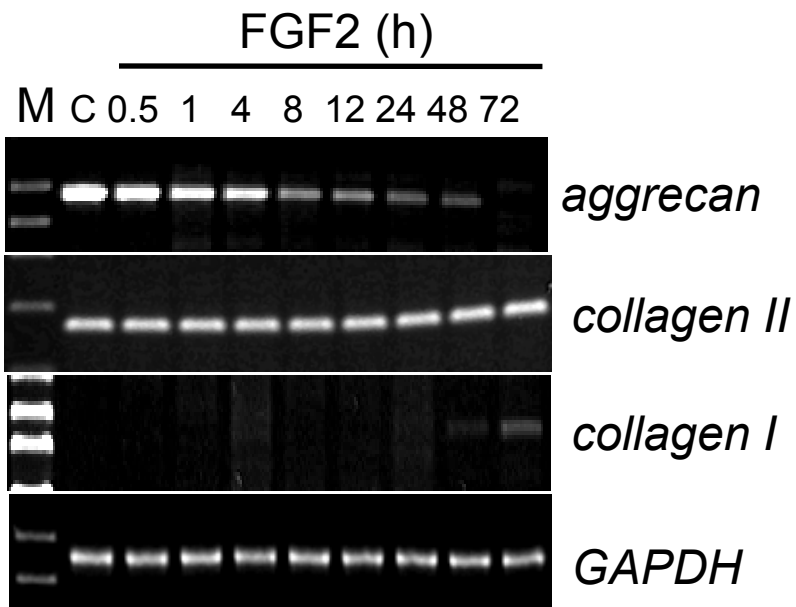
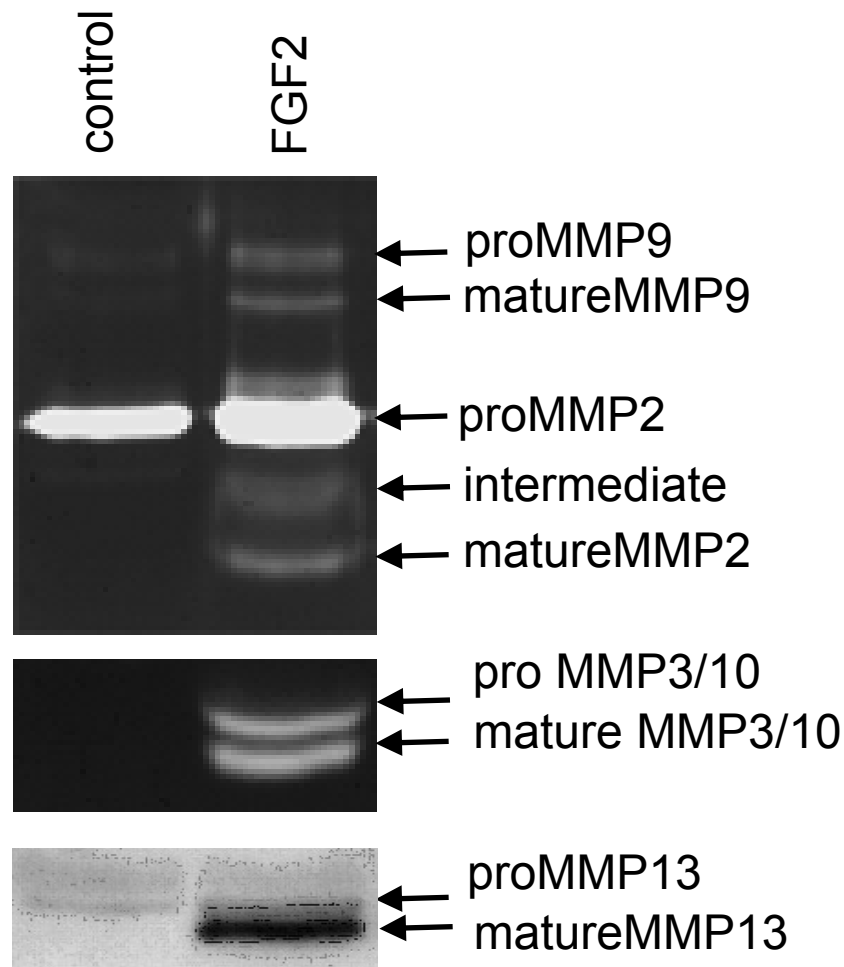
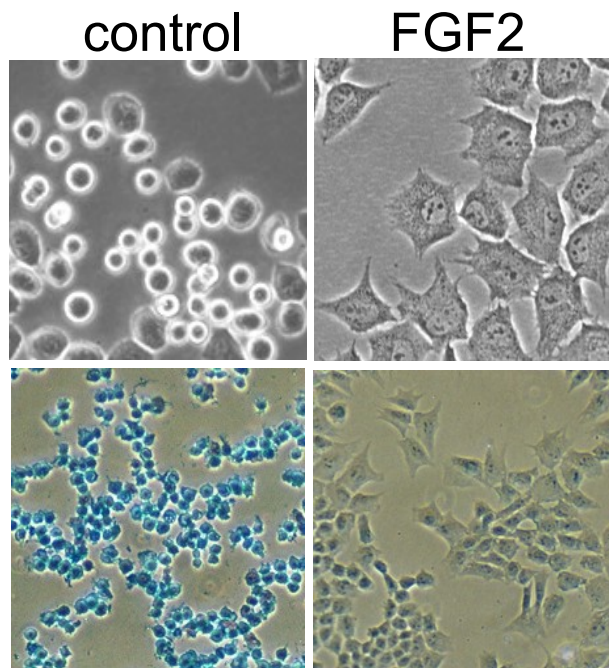

Vinculin

Phalloidin

DAPI

merge

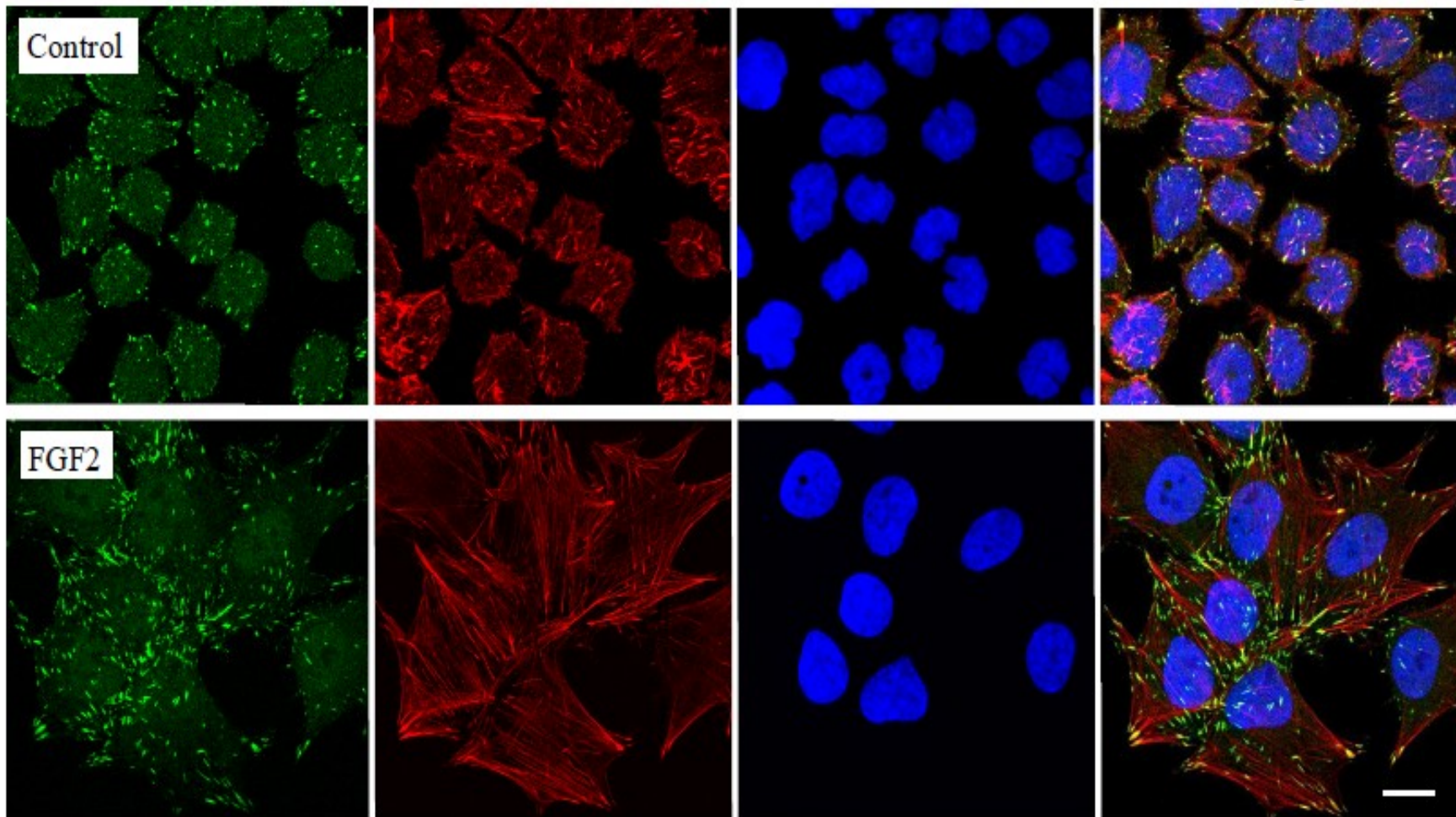

FGFR3 causes premature senescence in chondrocytes

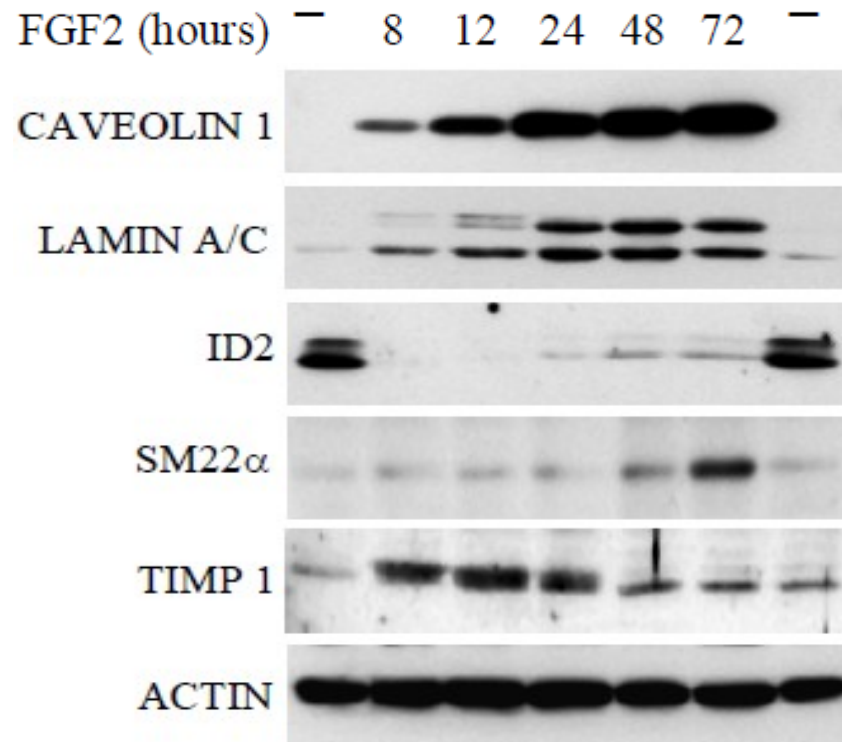
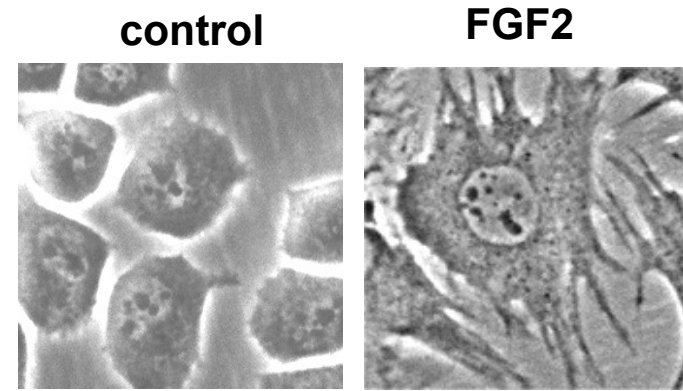
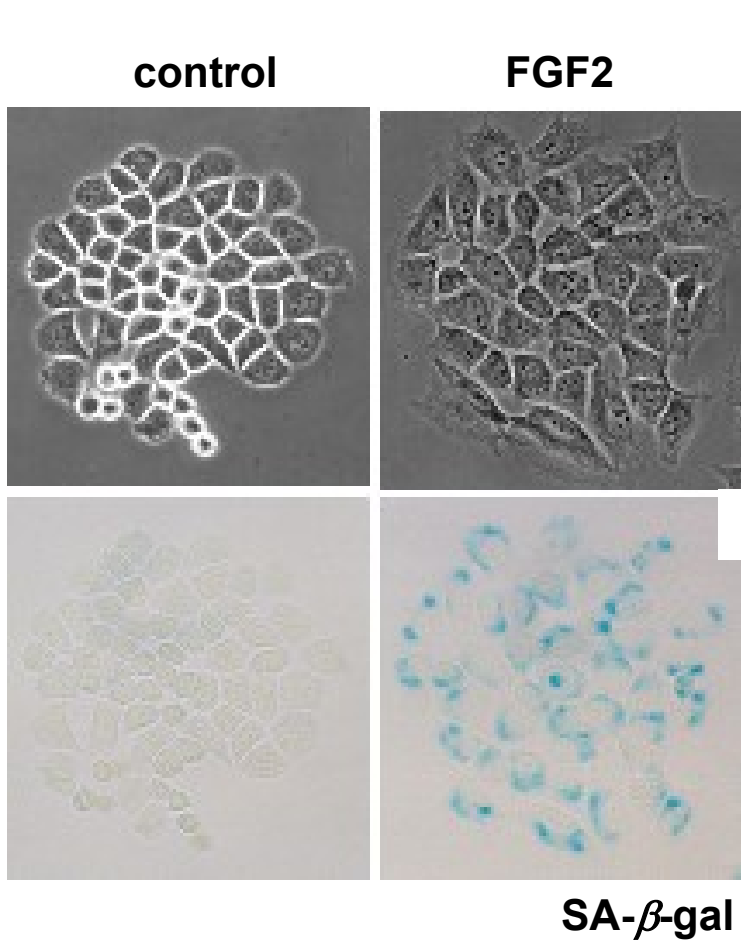

FGFR3 arrests chondrocyte growth via RAS-ERK MAP kinase pathway

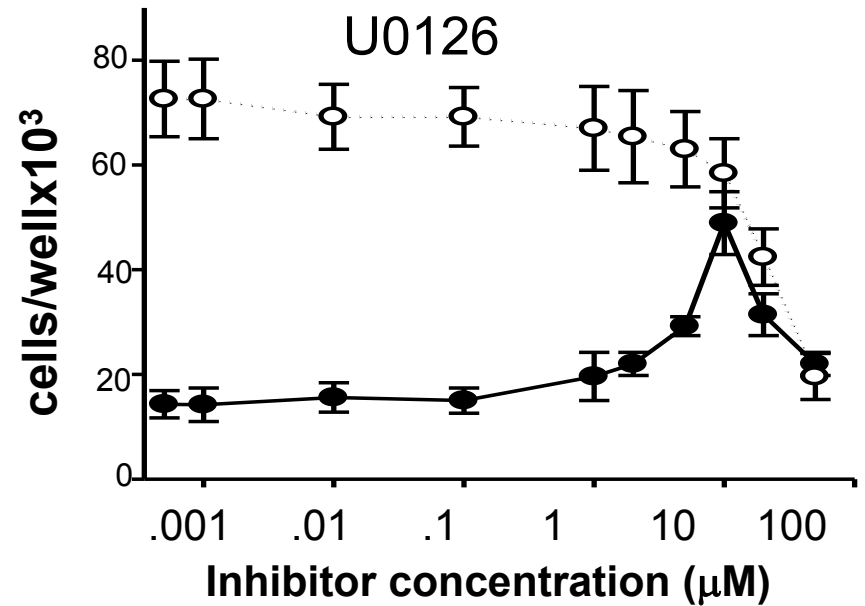
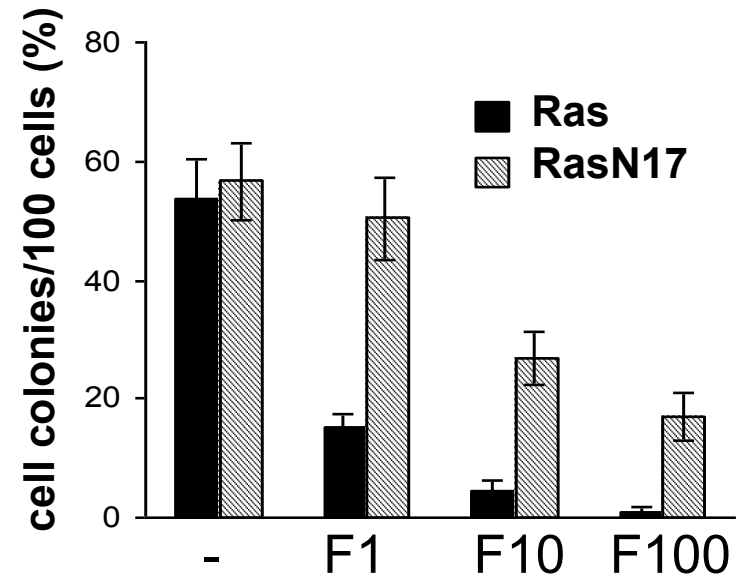
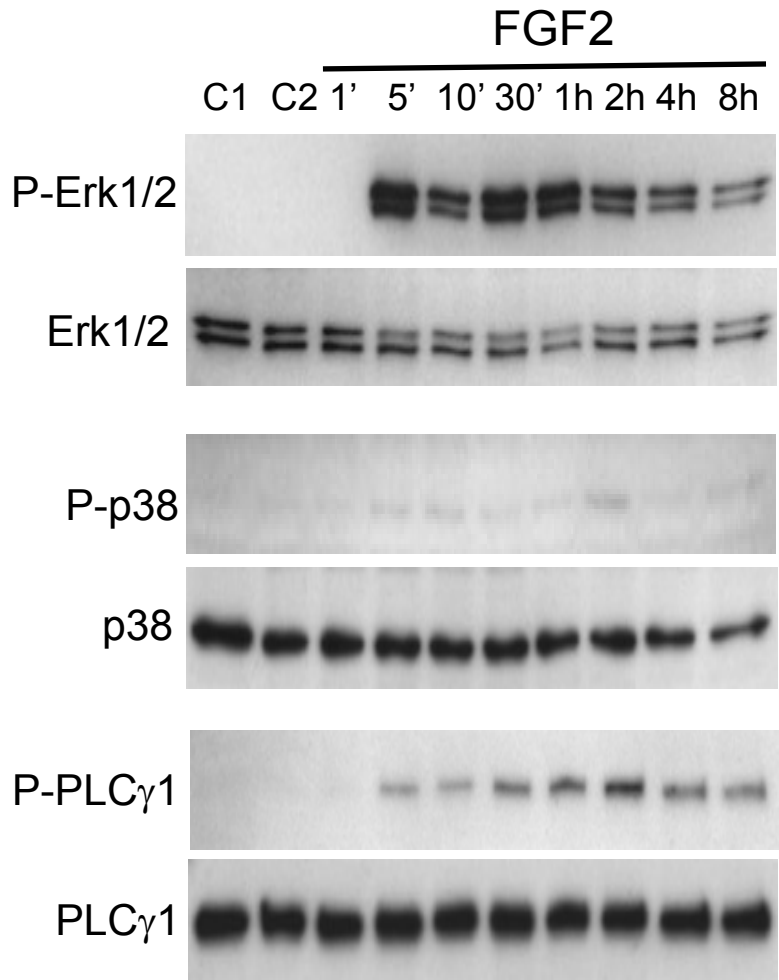

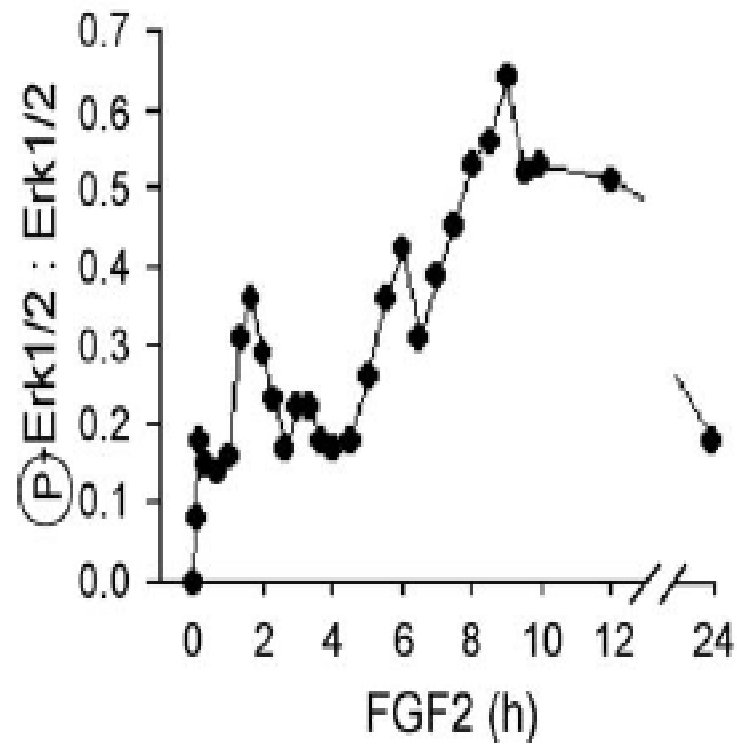

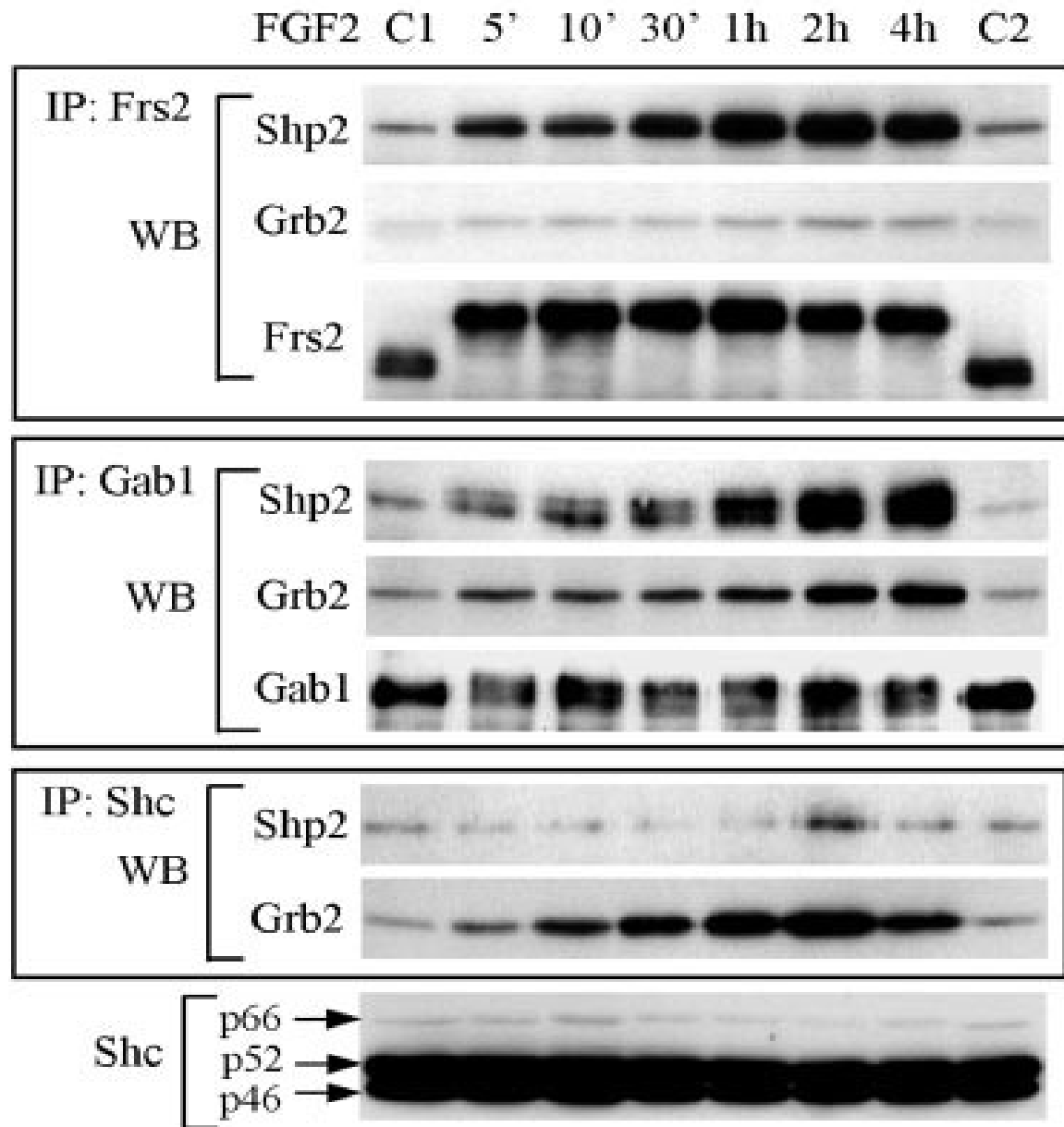
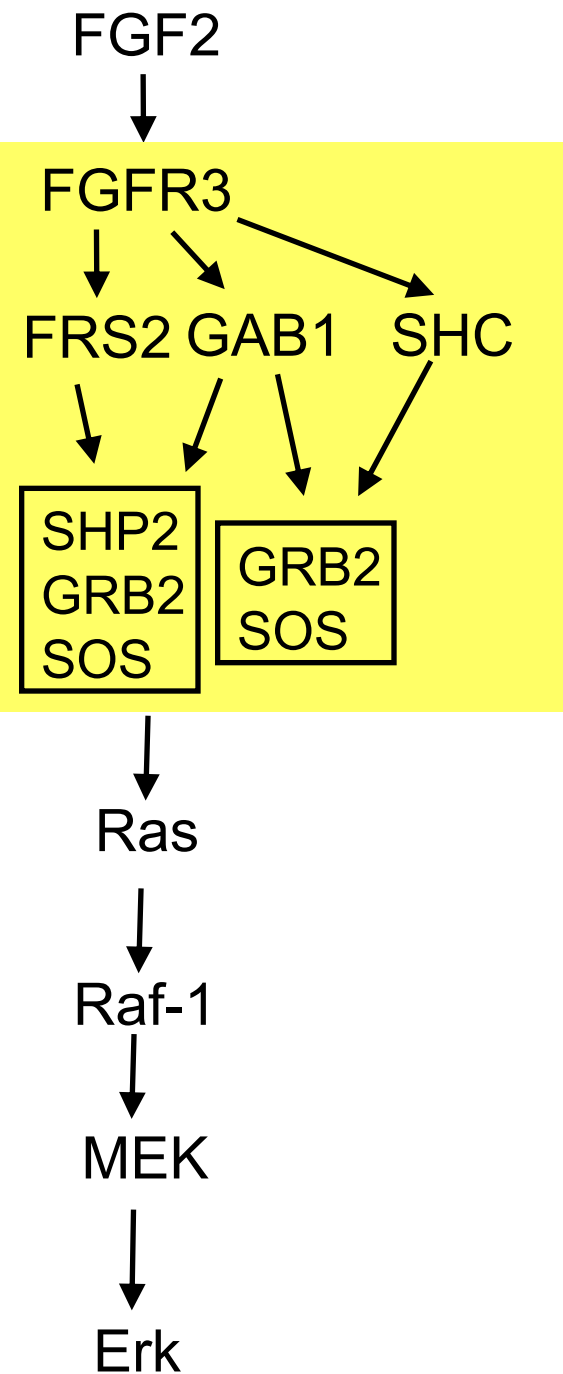

Activation of Stat1 by mutant fibroblast growth-factor receptor in thanatophoric dysplasia type II dwarfism

Wu-Chou S. Su^{*}, Motoo Kitagawa^{*}, Ninrong Xue, Bing Xie, Silvio Garofalo[†], Jay Cho[†], Chuxia Deng[‡], William A. Horton[†] & Xin-Yuan Fu

NATURE | VOL 386 | 20 MARCH 1997

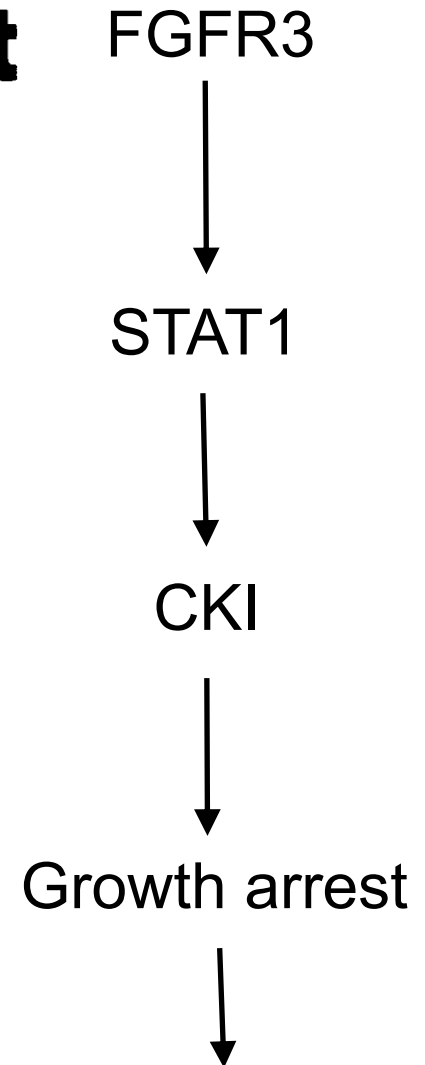

Skeletal dysplasia

FGFR3 associates with STAT1 and acts as STAT1-kinase in chondrocytes

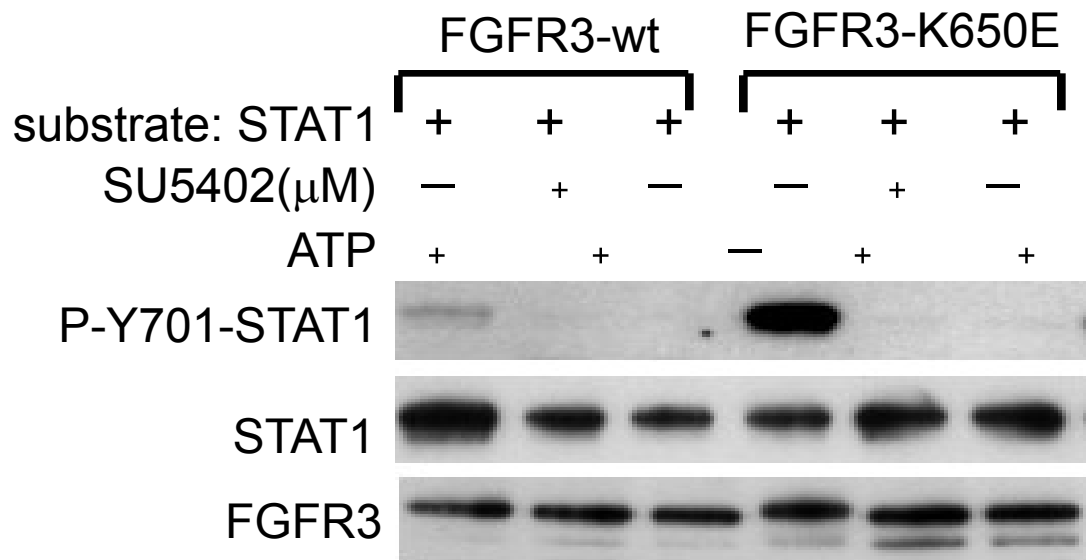
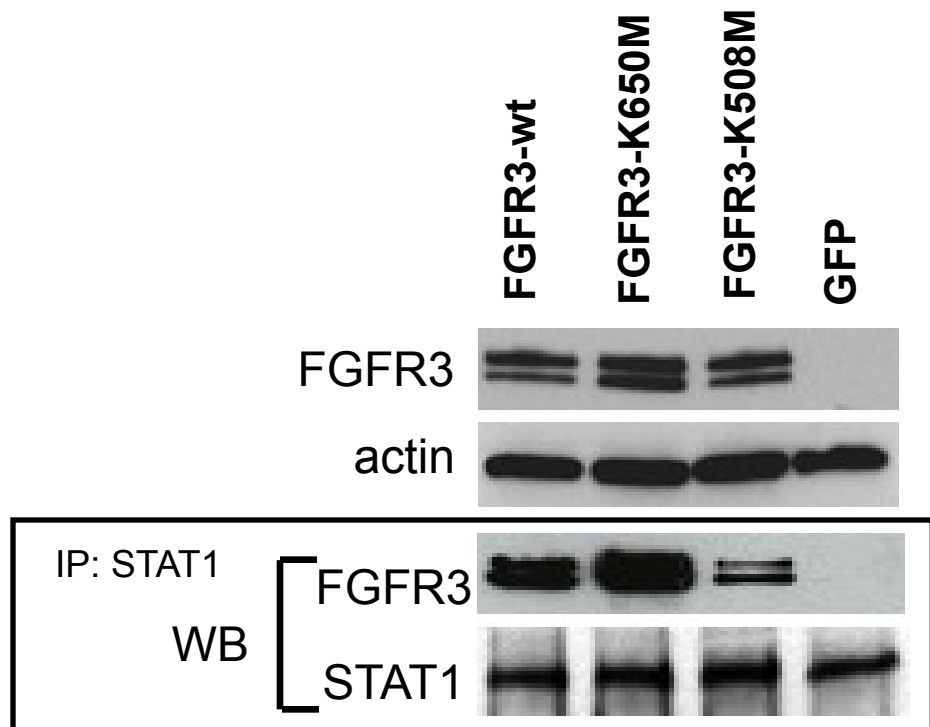
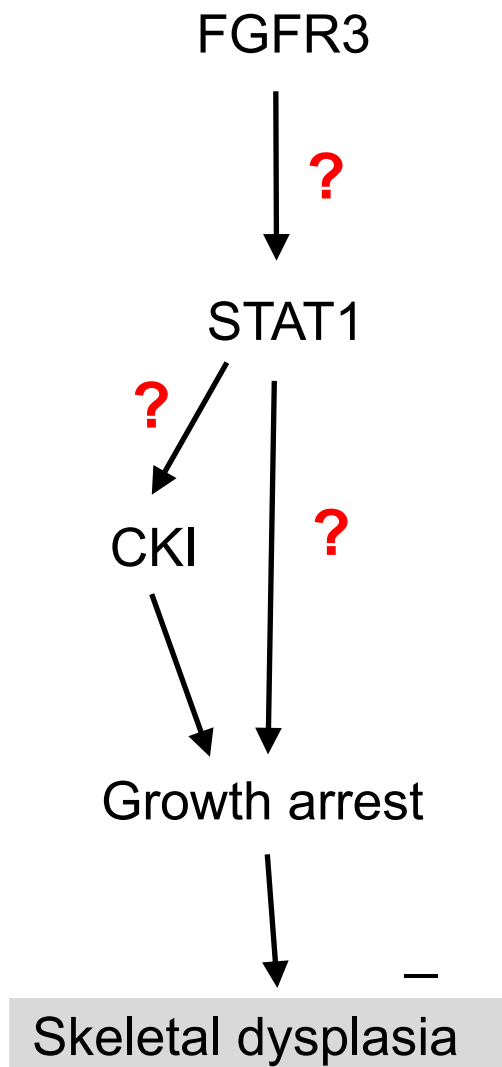

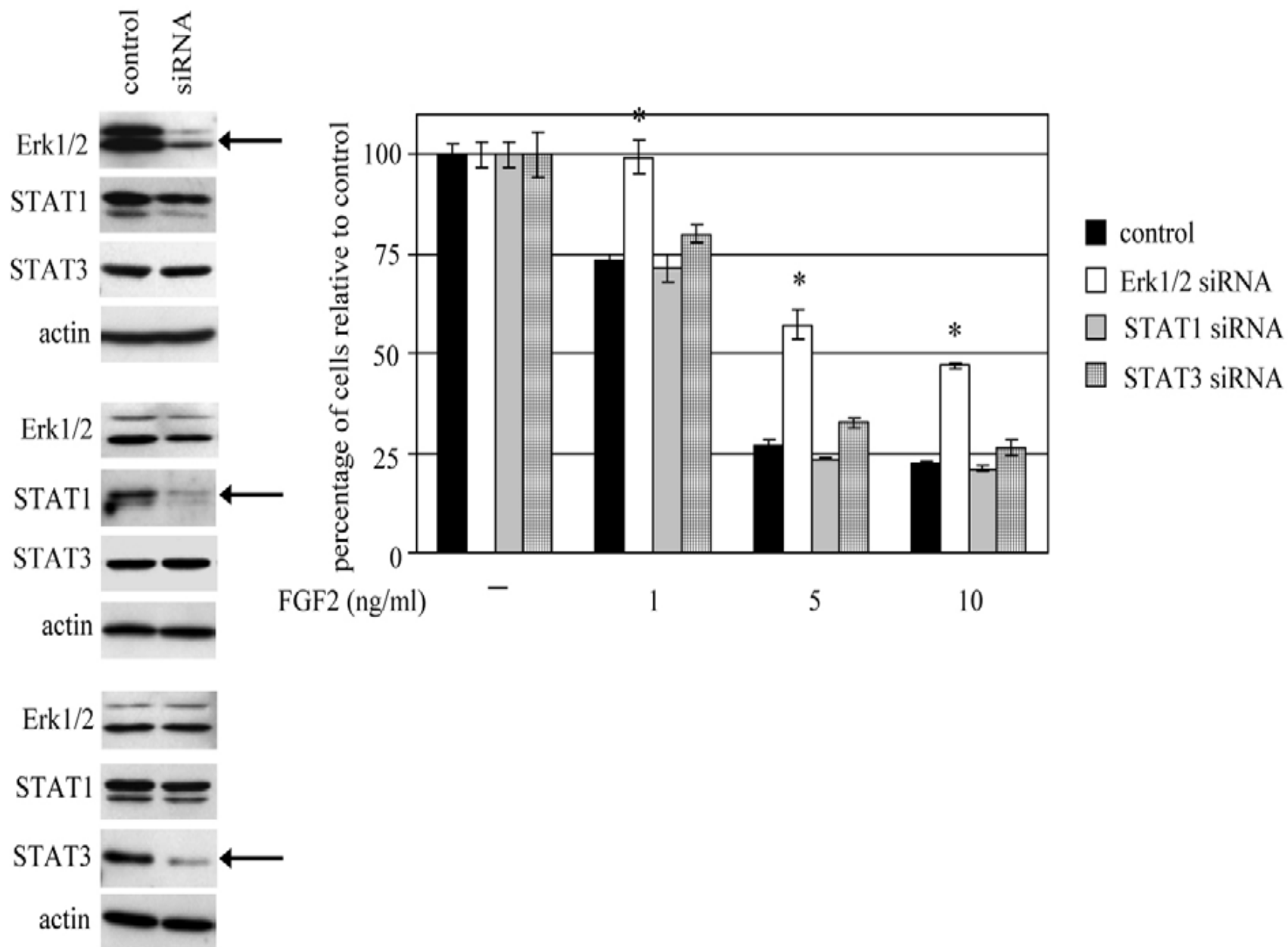

Chronic FGF stimulus inhibits cytokine/STAT signaling in chondrocytes

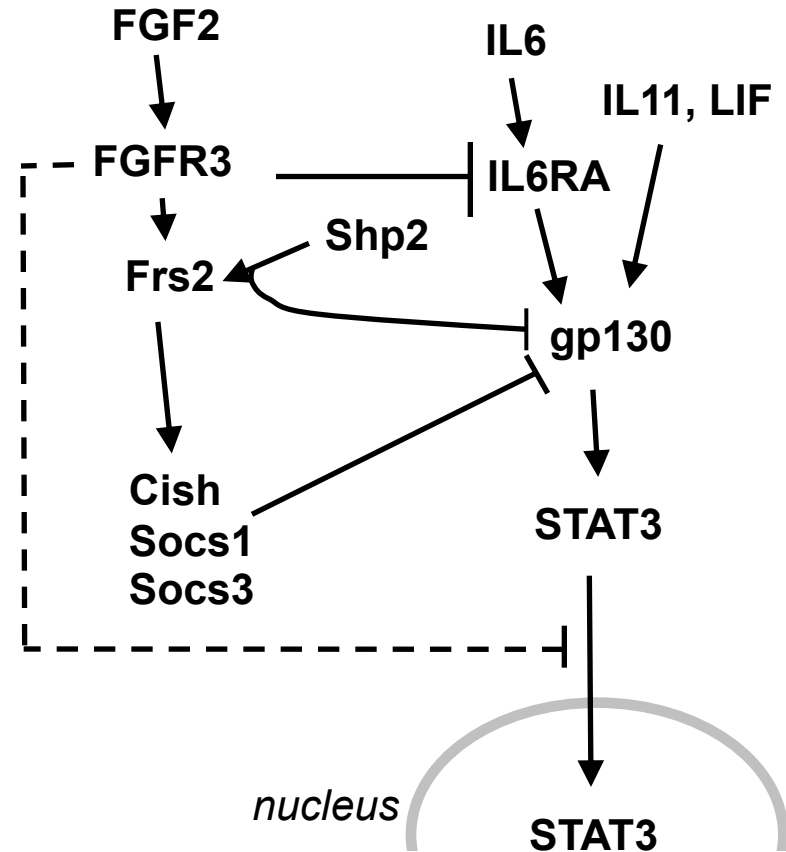
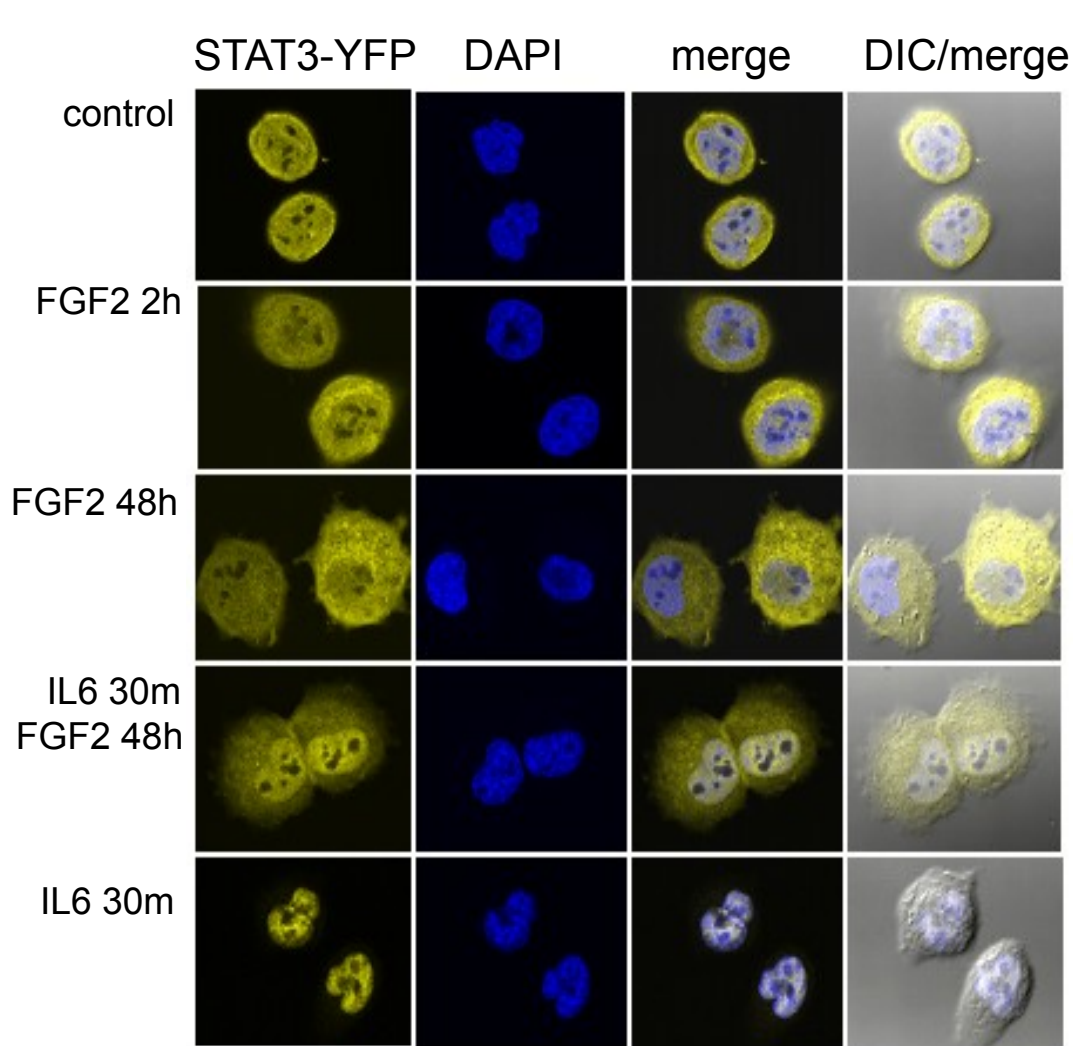

2001

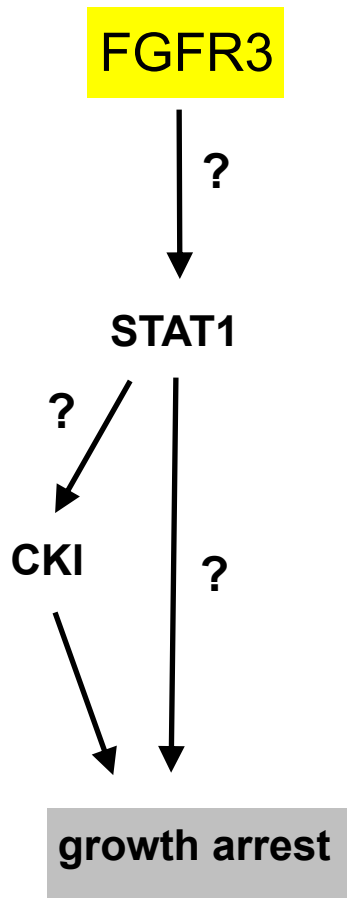

2012

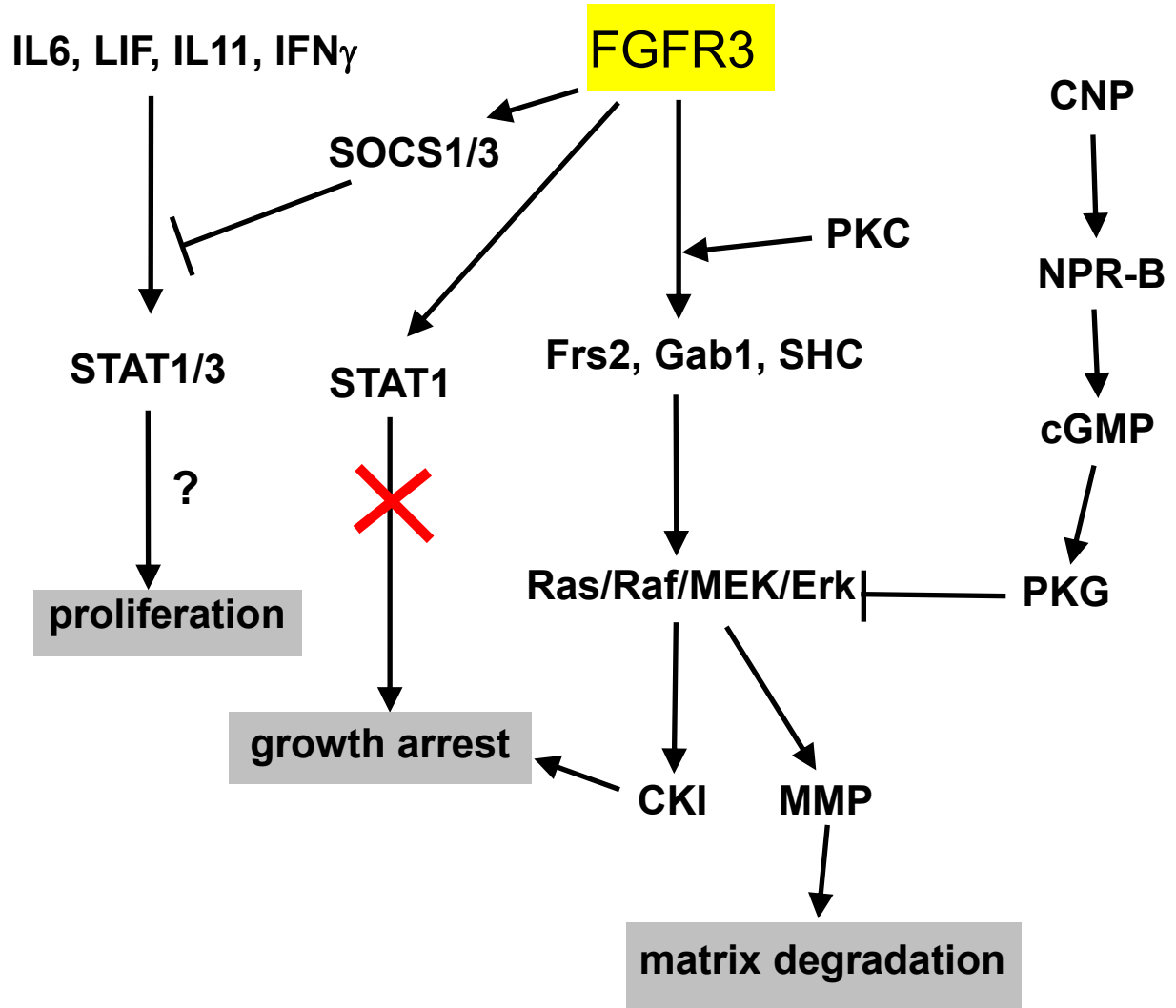

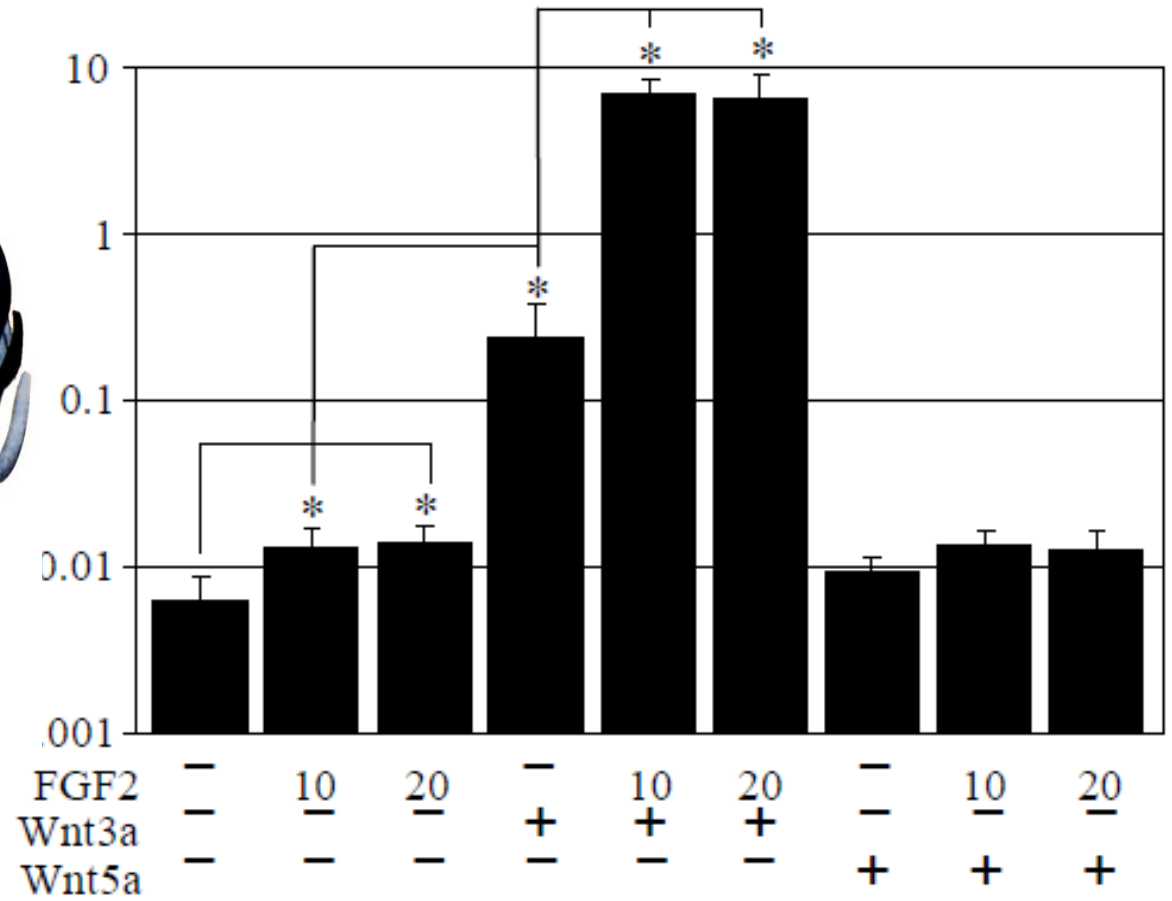
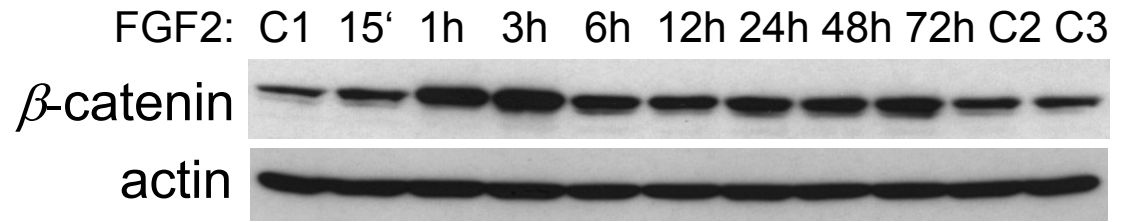

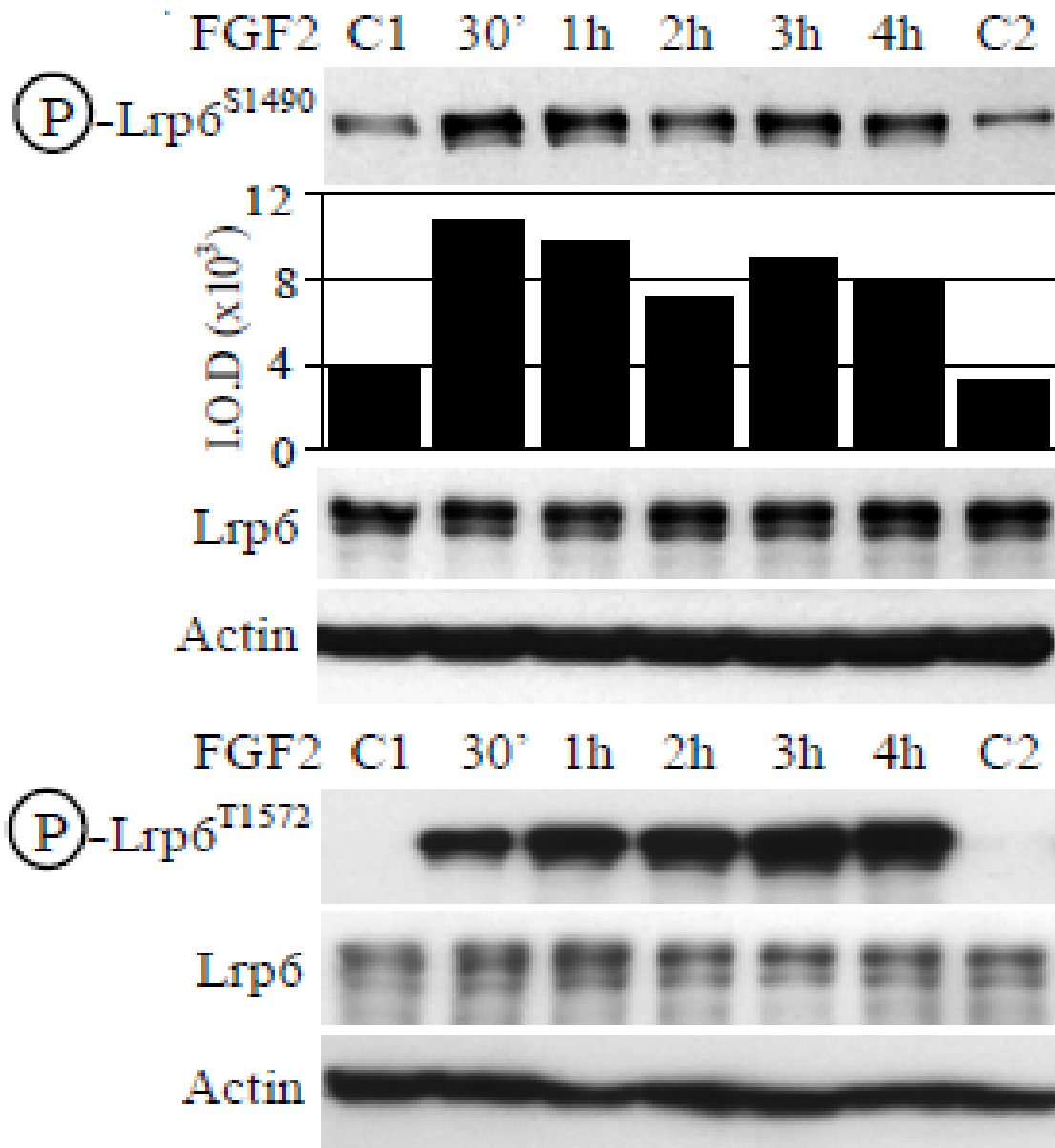
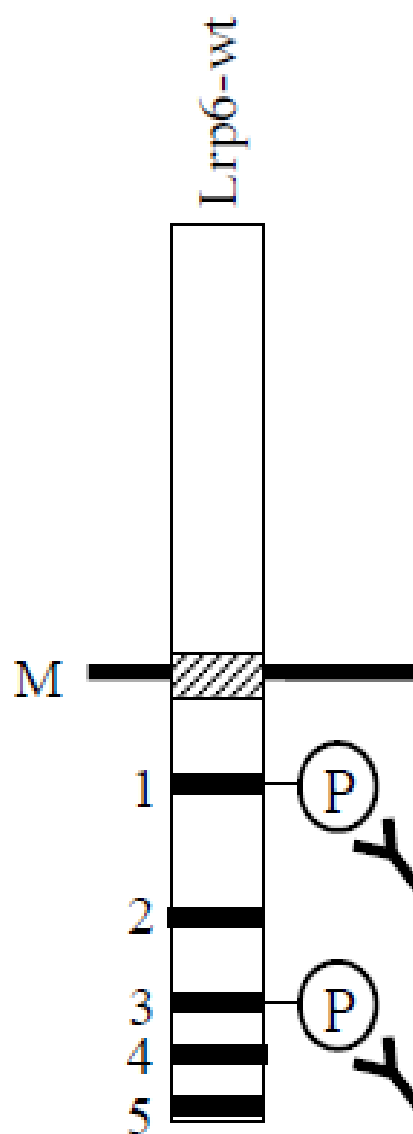

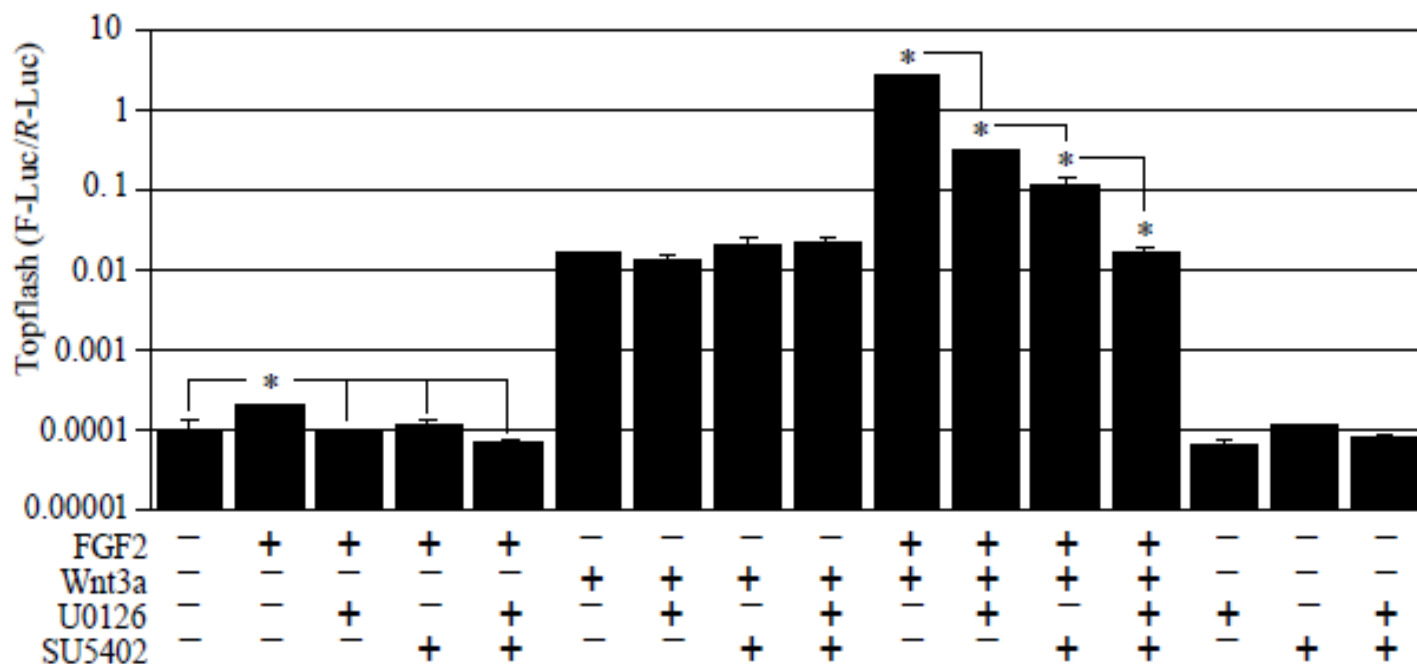
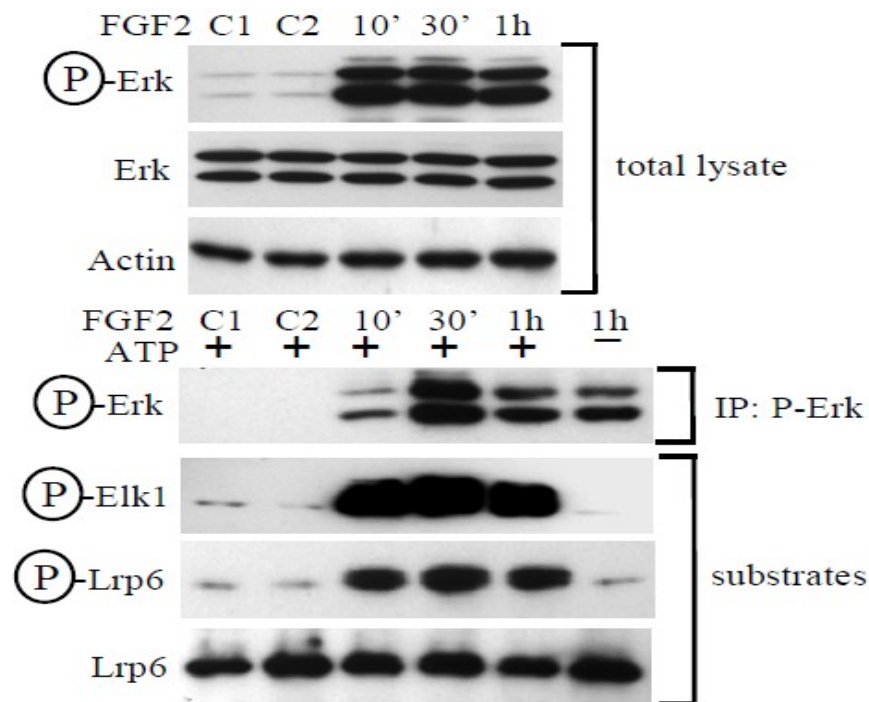
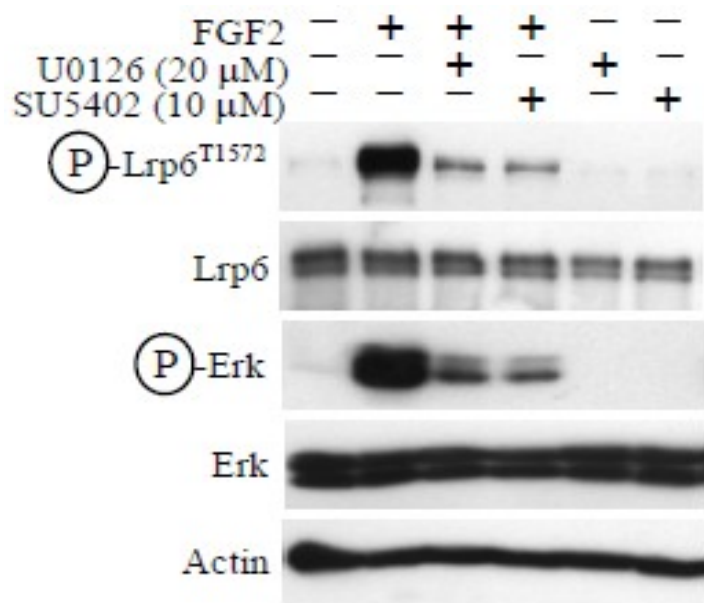

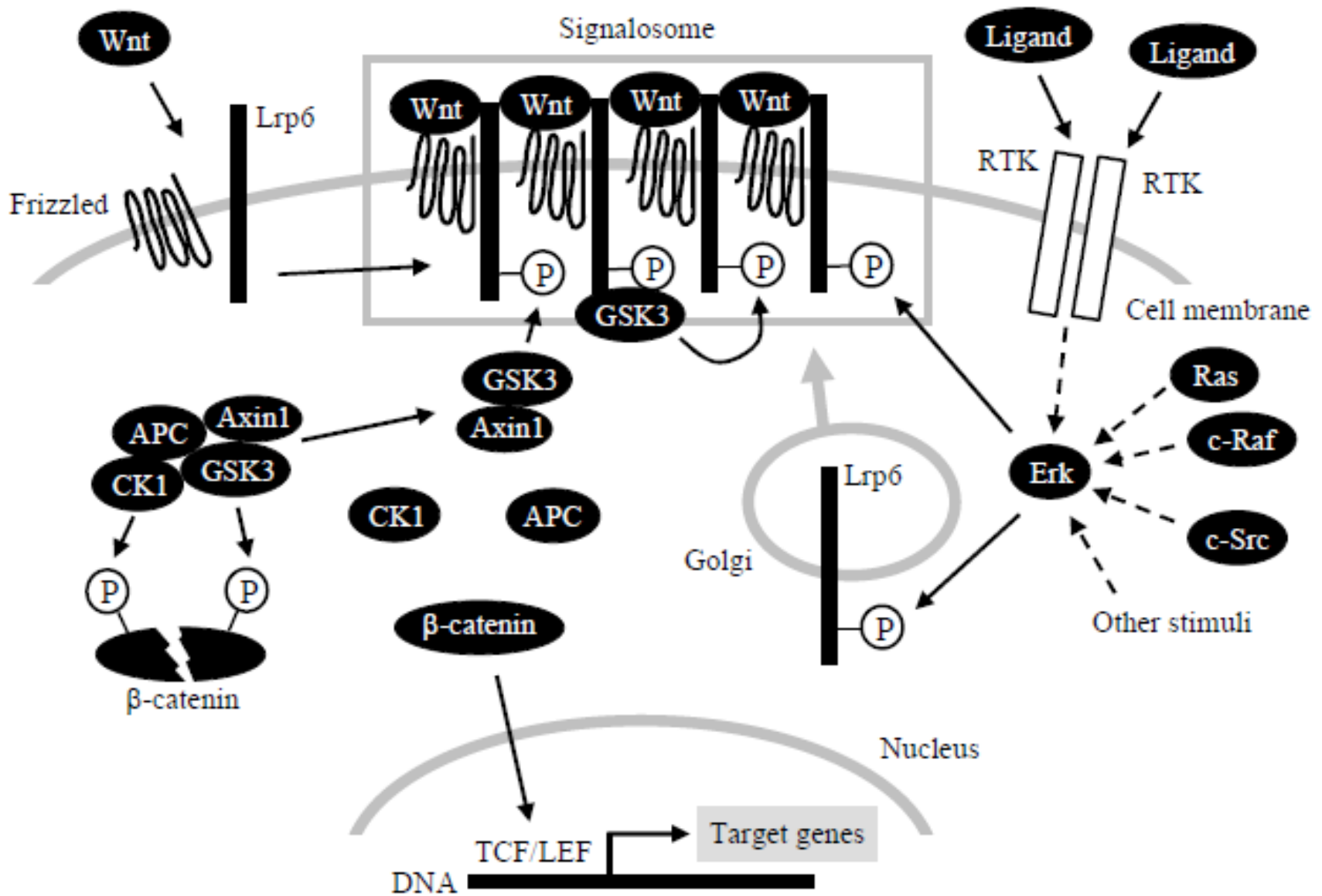

C-natriuretic peptide (CNP)

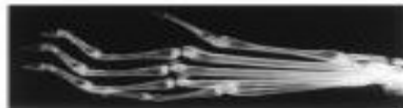
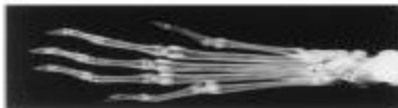
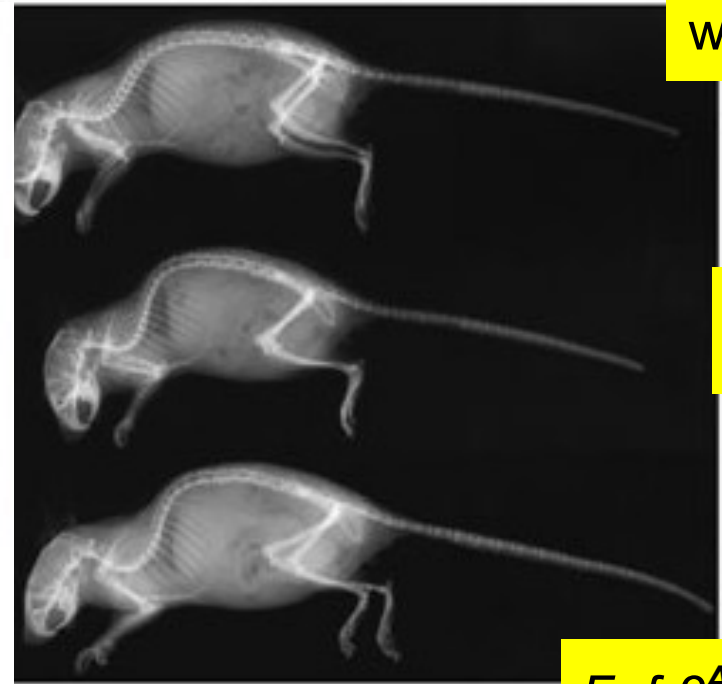

$Fgfr3^{Ach/CNP}$ ↑

Kazuwa Nakao



wild-type

CNP ↑

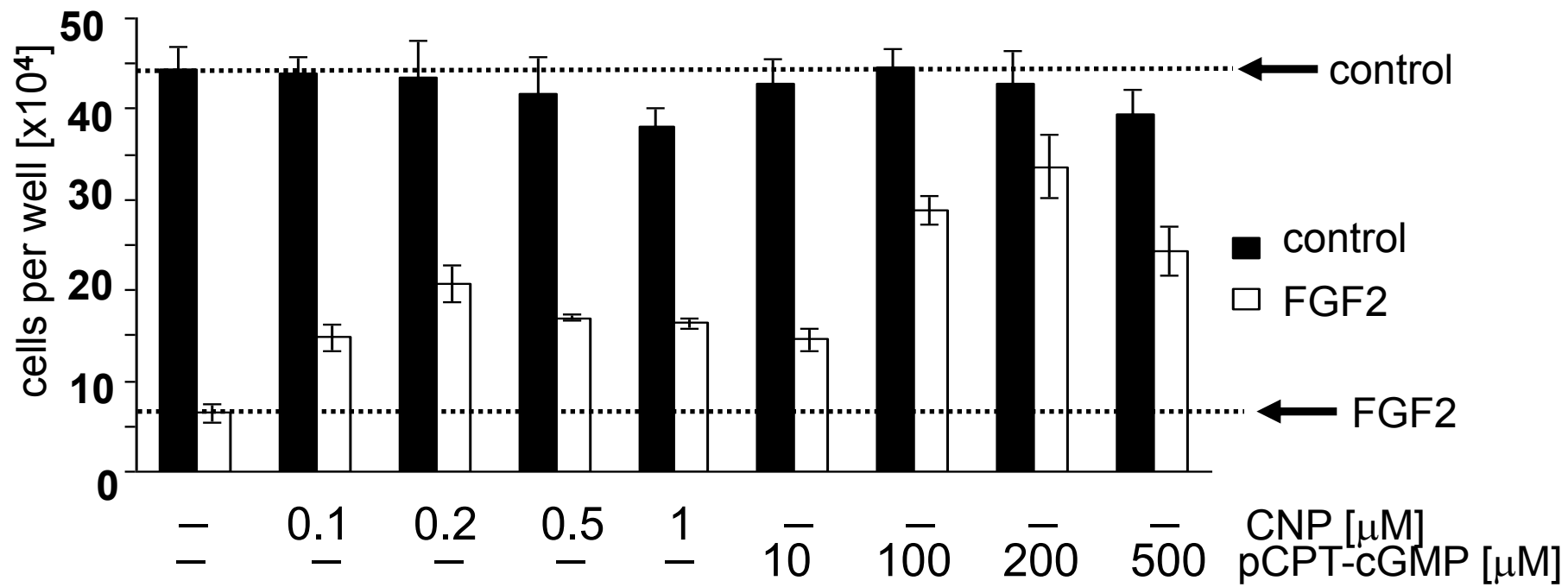

control

FGF2

control

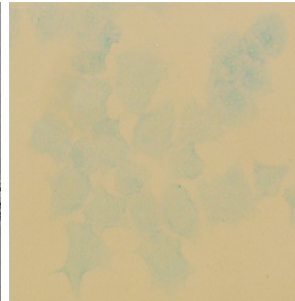
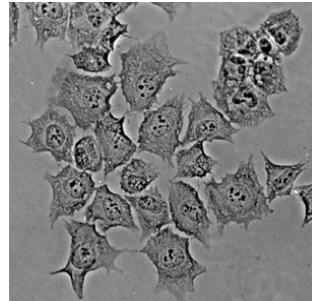
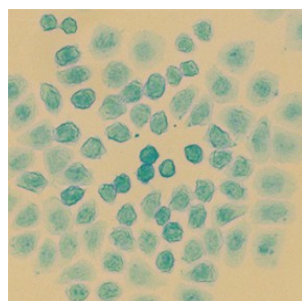
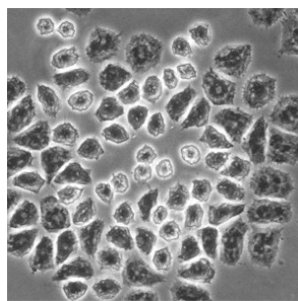

CNP

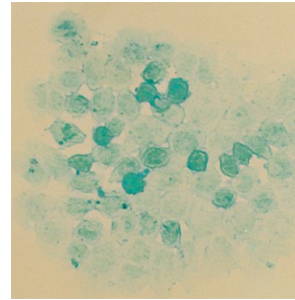
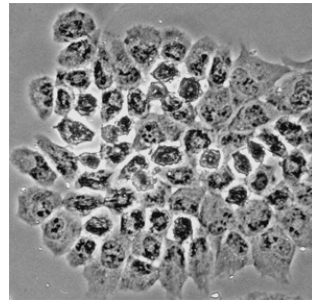
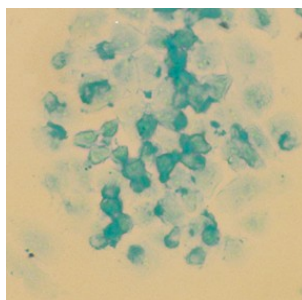
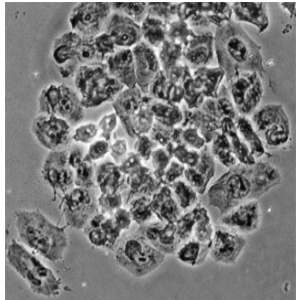

Simple, mammalian cell-based assay for identification of inhibitors of the Erk MAP kinase pathway

Pavel Krejci · Katerina Pejchalova · William R. Wilcox

Received: 26 December 2006 / Accepted: 4 April 2007 / Published online: 26 April 2007
© Springer Science + Business Media, LLC 2007

Summary The Erk MAP kinase pathway contributes to tumor development and thus represents an important therapeutic target. Several inhibitors of the Erk pathway are presently being evaluated in clinical trials for cancer, but show limited efficiency thus warranting discovery of more

toxic compounds as false-positive hits, given the nature of the RCS response to inhibition of the Erk pathway, i.e. growth.

Keywords Erk · Inhibitor · FGFR3 · Growth arrest ·



Tocriscreen™ *Mini Library*

A collection of 1120 biologically active compounds supplied as DMSO solutions.

NF449

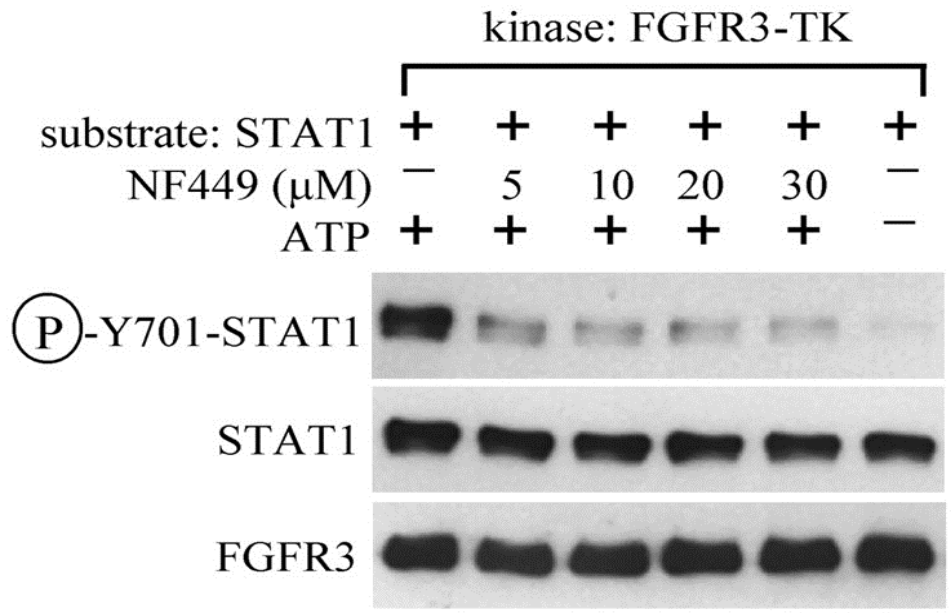
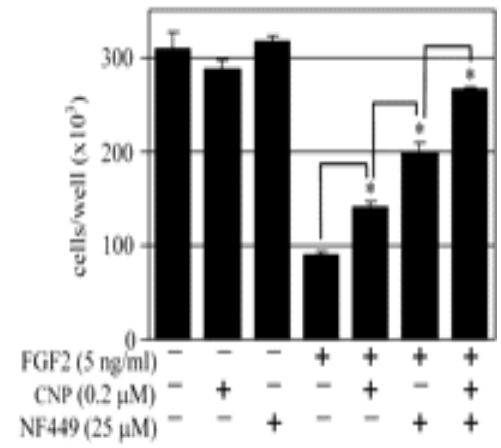
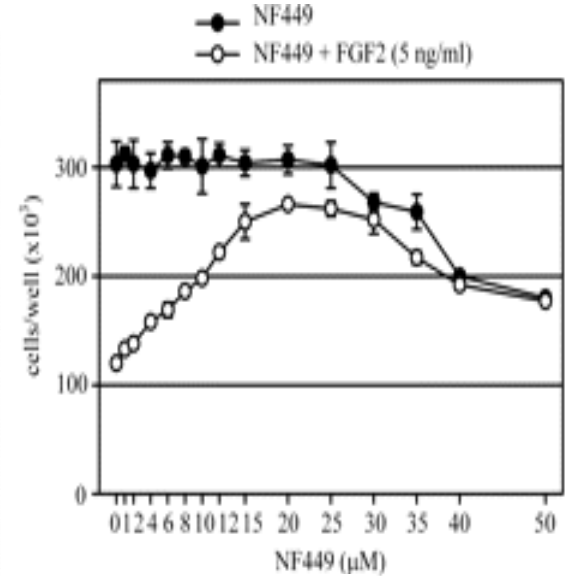
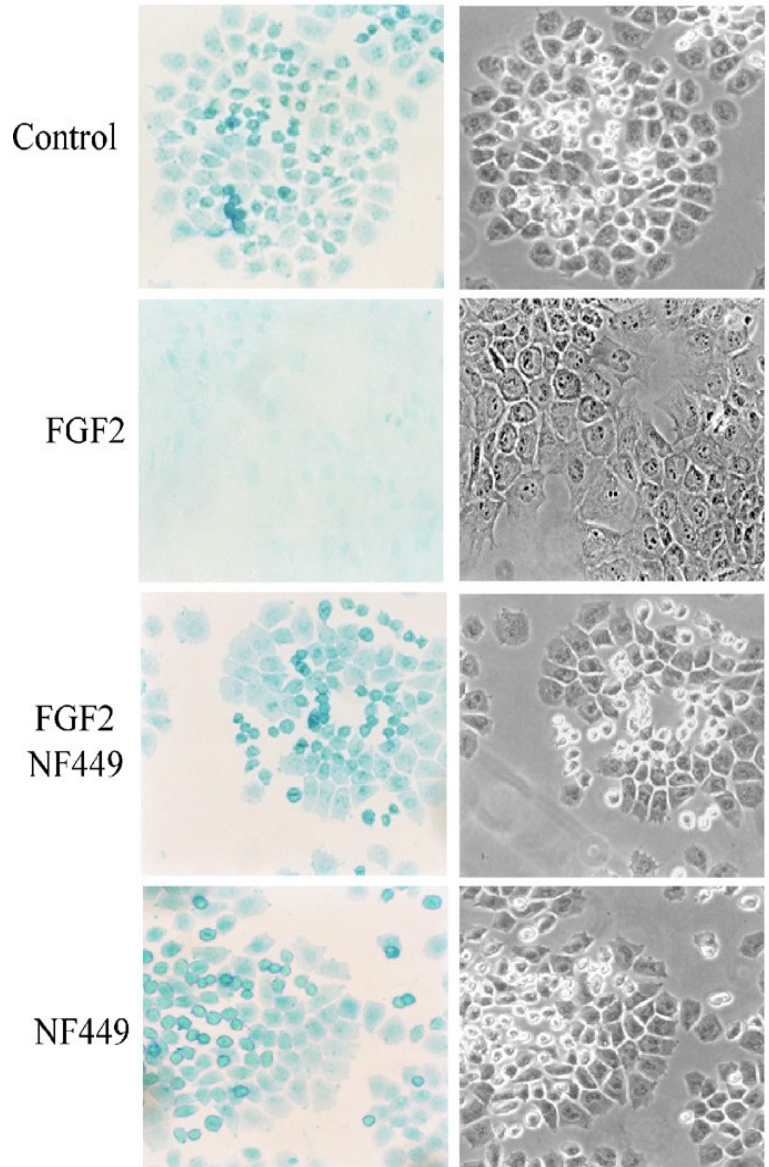

Kinase: FGFR3

Substrate: STAT1	+	+	+	+	+	+	+	+	+	+	+	+
AZD1480 (μ M)	-	0.1	0.25	0.5	1	5	10	-	-	-	-	-
NF007 (μ M)	-	-	-	-	-	-	-	-	20	-	-	-
NF449 (μ M)	-	-	-	-	-	-	-	20	-	-	-	-
FGFR inhibitor (μ M)	-	-	-	-	-	-	10	-	-	-	-	-
ATP	+	+	+	+	+	+	+	+	+	+	+	-
Vehicle (DMSO)	-	+	+	+	+	+	+	+	-	-	+	-

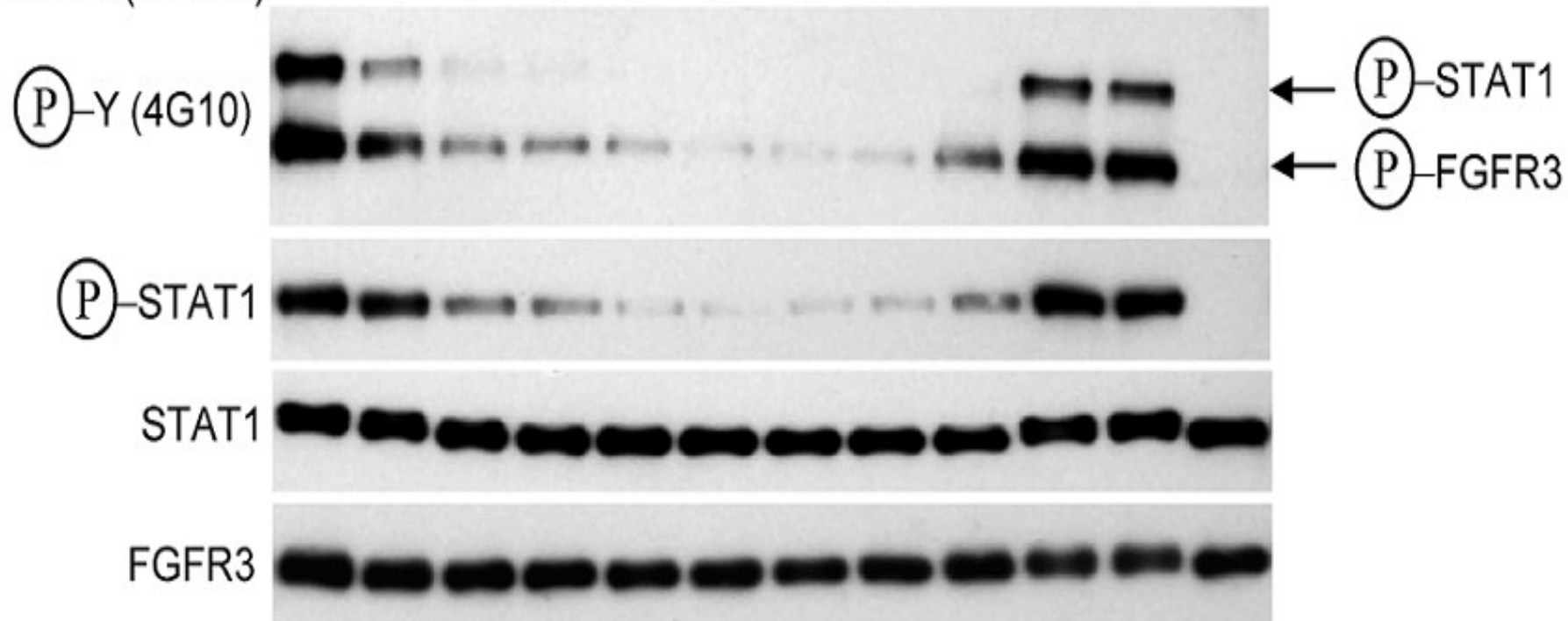

Cedars-Sinai Medical Center

Los Angeles, California

Betty Mekikian

Anie Aklian

UCI, Irvine, California

Leslie Thompson

Tamara Kashiwada

Lisa Salazar

UCLA, Los Angeles, California

Matthew Schibler

Masaryk University, Brno, Czech Republic

Jirina Prochazkova

Vita Bryja

Lukas Balek

Tereza Spoustova

Tereza Pospisilova

INSERM U589, Toulouse, France

Bernard Masri

Vincent Fontaine