

# C3181

# Biochemie I

06-Sacharidy, struktura a metabolismus

FRVŠ **1647/2012**

# Obsah

- Struktura a základní vlastnosti
- Monosacharidy, reaktivita, di- a oligosacharidy
- Zásobní polysacharidy, stručný metabolismus
- Interkonverze monosacharidů
- Přímá oxidace glukosy, význam
- Pentosový cyklus

# Struktura a základní vlastnosti

- Polyhydroxyaldehydy – aldosity – na C1
- Polyhydroxyketony – ketosity – na C2
- Různý počet C
  - Od C3 – aldotriosy a C4 – ketotetrosy alespoň 1 C\*
- Chiralita
  - D-enantiomery, L-výjimečně

# Monosacharidy

- Aldosy
  - Od trios výše (1 a více asymetrických C)
- Ketosy
  - Ketotriosa nemá C\*

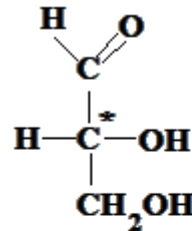

**D - glyceraldehyd**

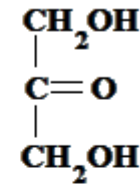

**dihydroxyaceton**

**počet stereoizomerů =  $2^x$  (x = počet C<sup>\*</sup>)**

**aldosy - x = n - 2**

**ketosy - x = n - 3**

**n = počet C atomů**

# Aldosy a ketosy

## ALDOSY

## KETOSY

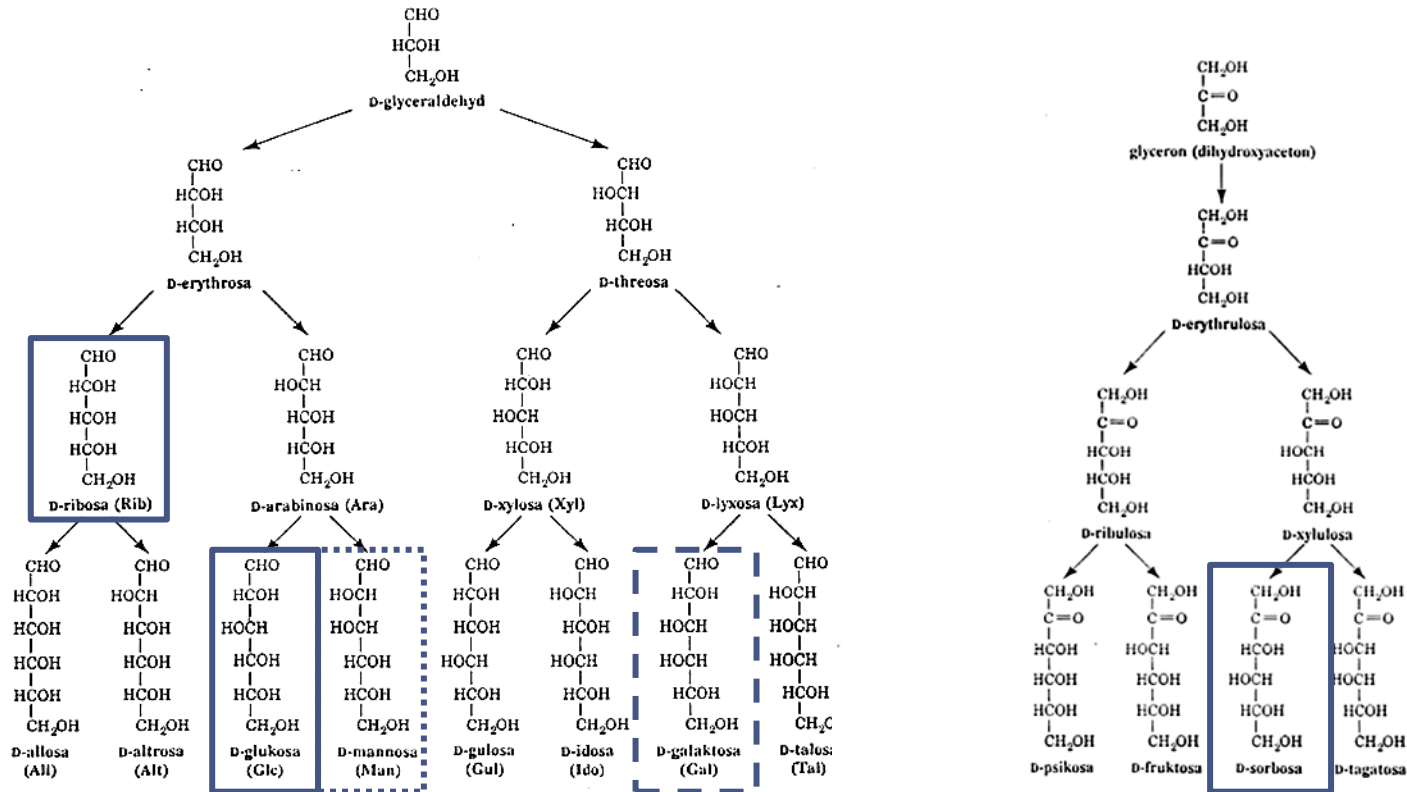

# Struktura monosacharidů

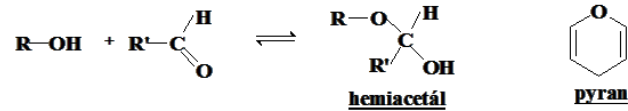

*Fischerovy vzorce*

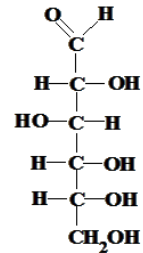

*Haworthovy vzorce*

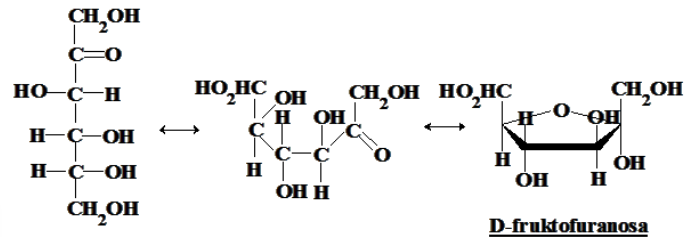
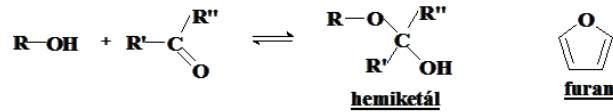
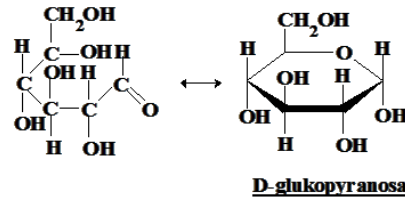

# Struktura monosacharidů

- Reaktivní polocetalový (poloketalový) hydroxyl
  - Tvorba acetalů (ketalů)
- Nové asymetrické centrum - anomery

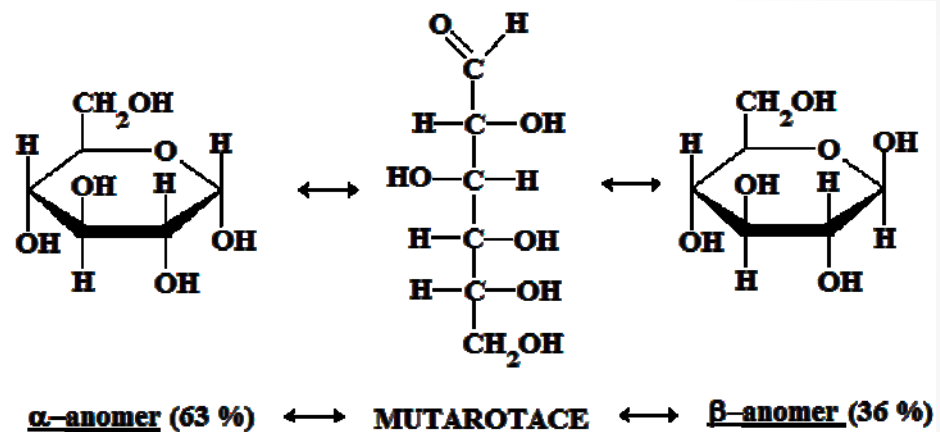

vaničková

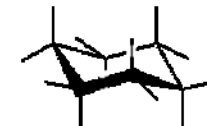

židlíčková

KONFORMACE

# Struktura monosacharidů

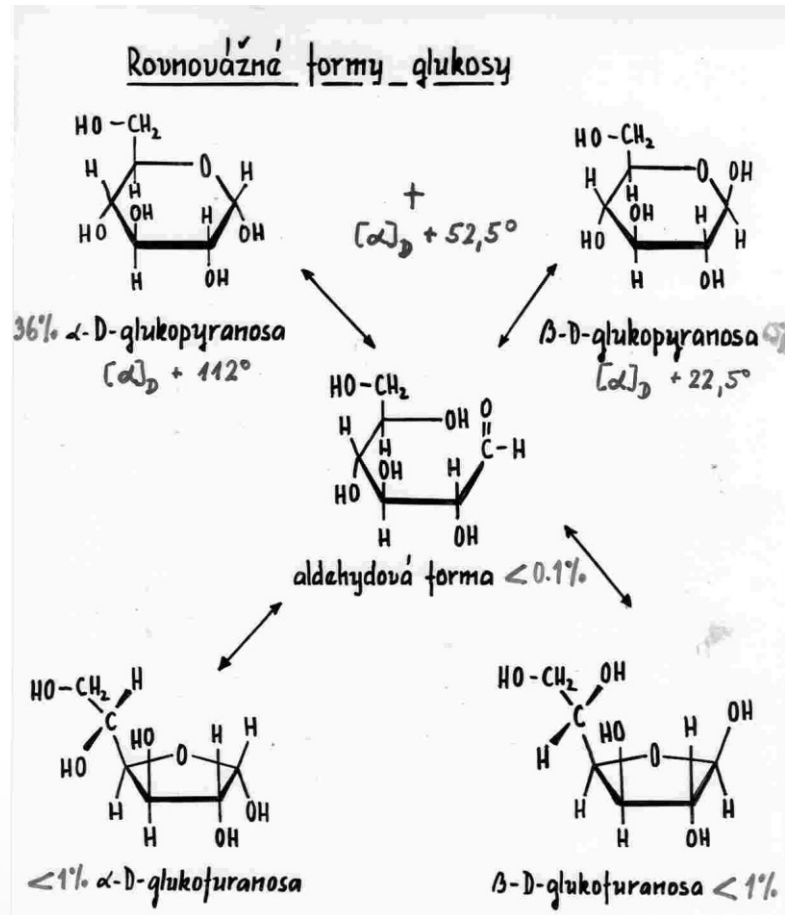



# Deriváty monosacharidů

## Oxidace :

A. Mírná ⇒ aldehydická skupina → karboxylovou skupinu

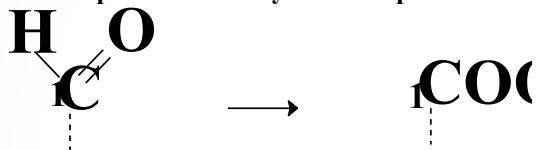

ALDONOVÉ KYSELINY - glukosa → k. glukonová

B. Specifická ⇒ primární OH skupina → karboxylovou skupinu

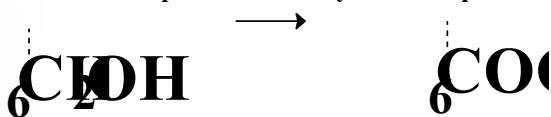

URONOVÉ KYSELINY - glukosa → k. glukuronová

C. Silná ⇒ aldehydická skupina + primární OH skupina

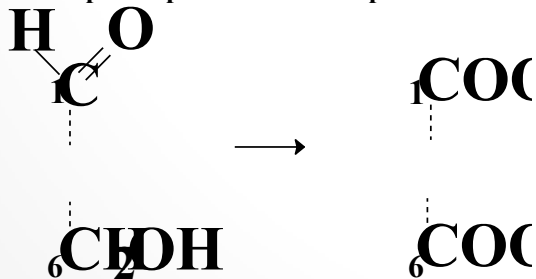

ALDAROVÉ KYSELINY - glukosa → k. glukarová

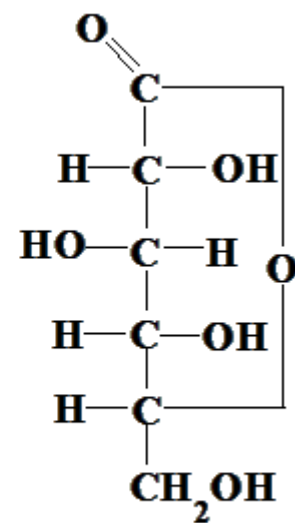
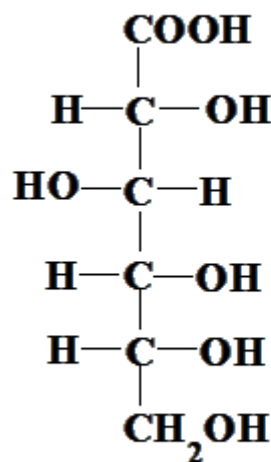

# Deriváty monosacharidů

- Cukerné alkoholy – mírná redukce karbonylu
- Deoxycukry
- Aminocukry

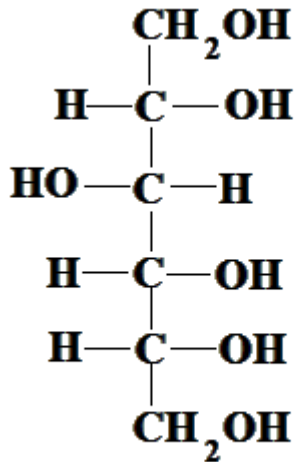

GLUCITOL - SORBITOL

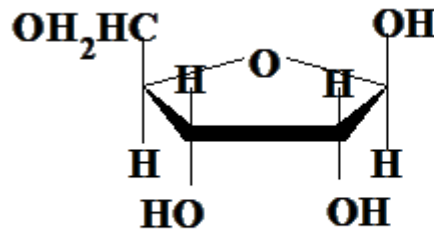

RIBOSA

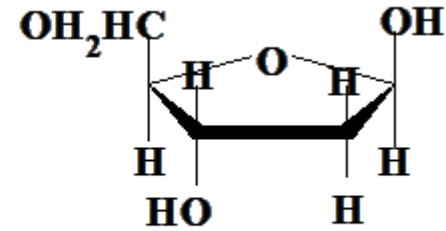

DEOXYRIBOSA

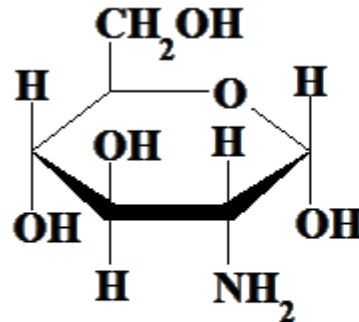

GLUKOSAMIN

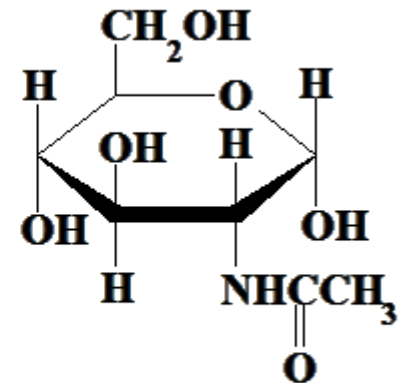

N-ACETYLGLUKOSAMIN

# Glykosidy

- Glykosidická vazba – acetaly a ketaly
  - OR, SR, NR
  - specificky štěpí glykosidasy
- Homoglykosidy – sacharid + sacharid
  - - di-, tri-,..., oligo-, polysacharidy
- Heteroglykosidy – sacharid + aglykon

# Disacharidy

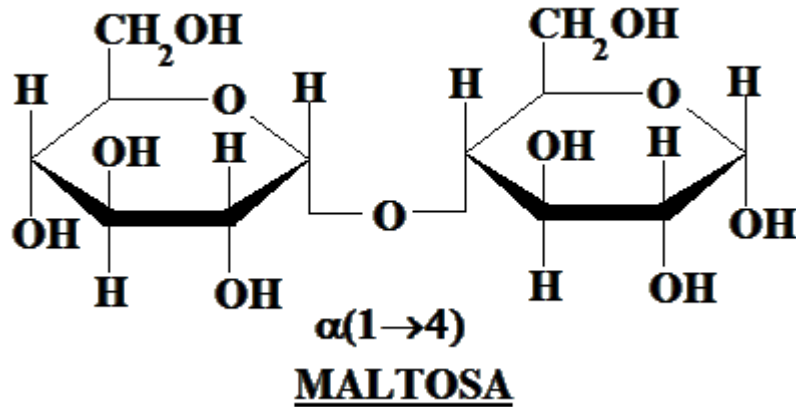

- -  $\alpha$  -D - glukopyranosyl
- (1 $\rightarrow$ 4) -  $\alpha$  -D - glukopyranosa
- Redukující

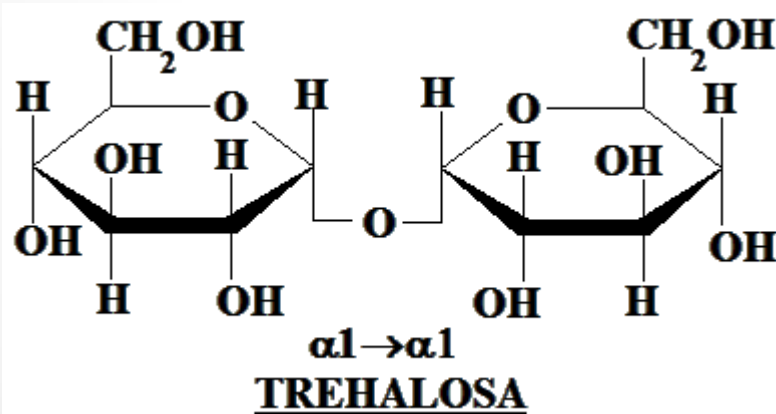

- -  $\alpha$  -D - glukopyranosyl
- (1 $\rightarrow$ 1) -  $\alpha$  -D - glukopyranosid
- Neredukující

# Disacharidy

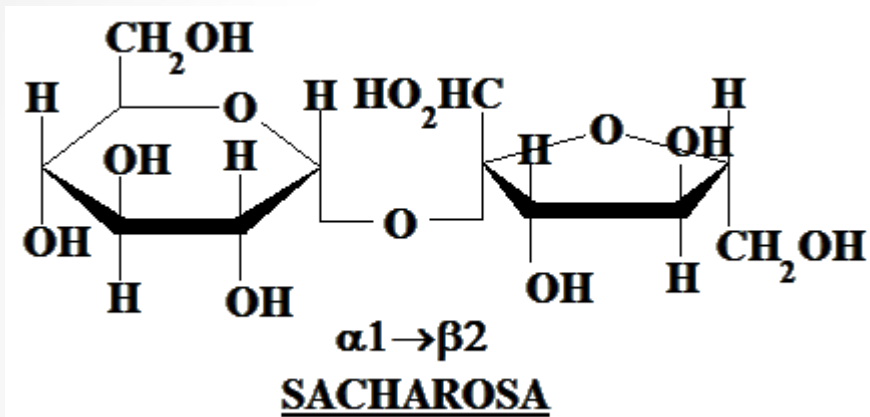

- -  $\alpha$  - D - glukopyranosyl  
(1  $\rightarrow$  2) -  $\beta$  - D - fruktofuranosid
- Neredukující

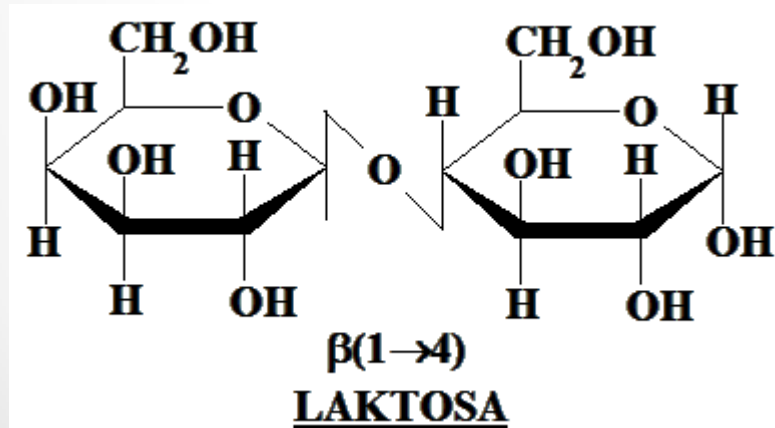

- -  $\beta$  - D - galaktopyranosyl  
(1  $\rightarrow$  4) -  $\beta$  - D - glukopyranosa
- Redukující

# Zásobní polysacharidy

- Škrob
  - Rostliny, 250 – 300 glukos
  - Amylosa – rozpustná, 20-30%
  - Amylopektin – větve 20-30 glukos

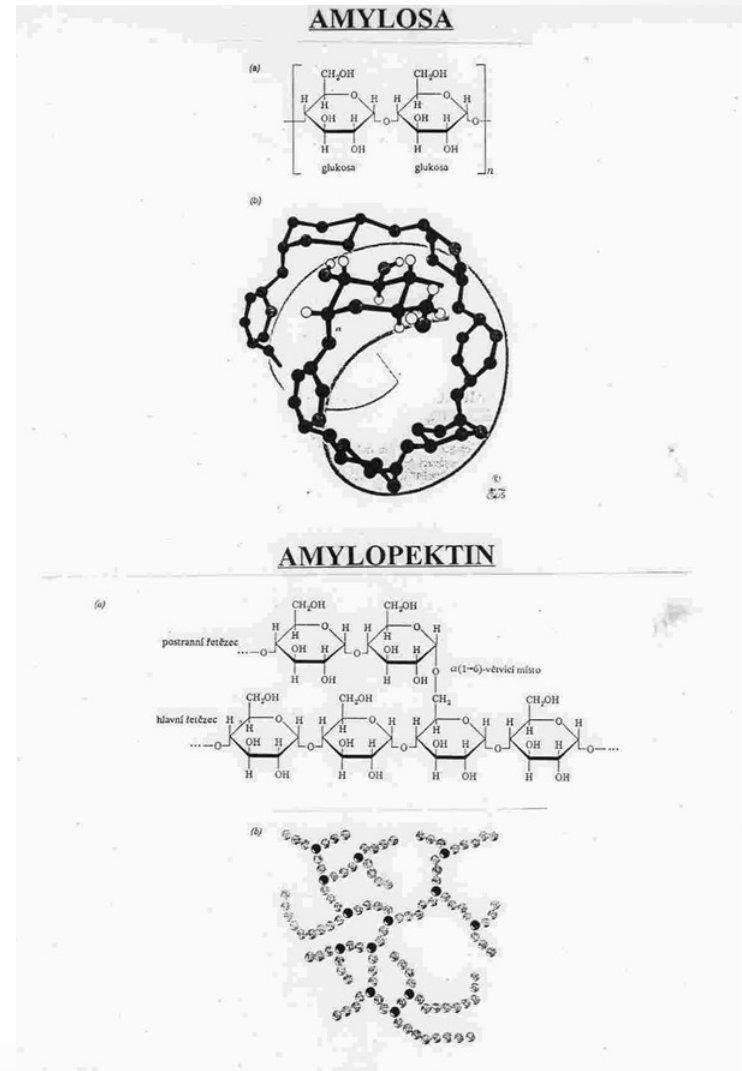
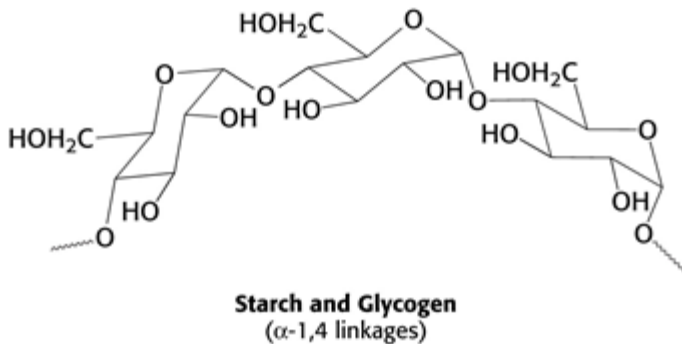
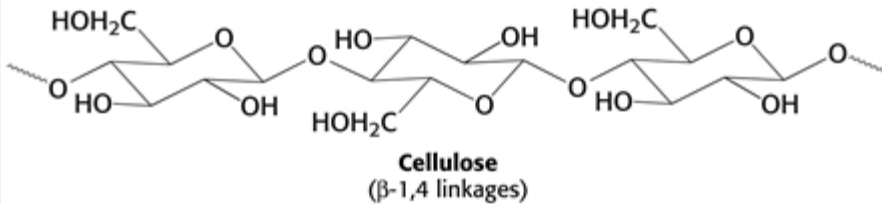

# Zásobní polysacharidy

- Glykogen
  - Živočichové, mikroorganismy
  - Větve 10 - 12 glukos
  - 1 – 5 MDa (sval, játra)

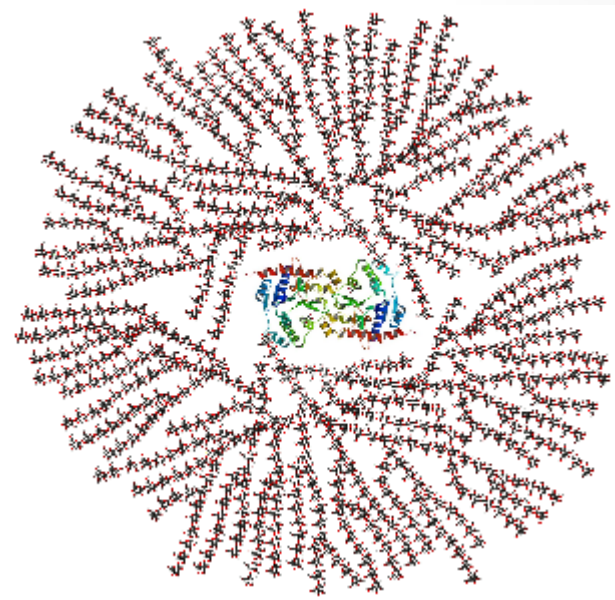
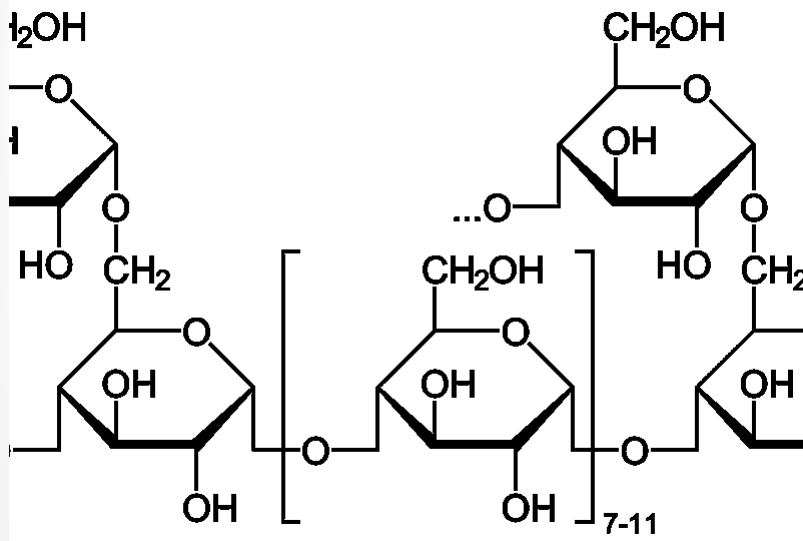

# Katabolismus polysacharidů

- Hydrolýza škrobu
  - Amylázy, glykosidázy (hydrolýzy glykosidické vazby)
  - Podle produktu
  - $\alpha$ -amylázy  $\rightarrow$  oligosacharidy dextriny, ztekucení
  - $\beta$ -amylázy  $\rightarrow$  maltosa, zcukřování – dále maltáza  $\rightarrow$  glukosa
  - Glukoamylázy  $\rightarrow$  glukosa
- Fosforolýza glykogenu
  - Produktem je glukosa-1-fosfát
  - Rekuperace energie
  - Alosterická regulace

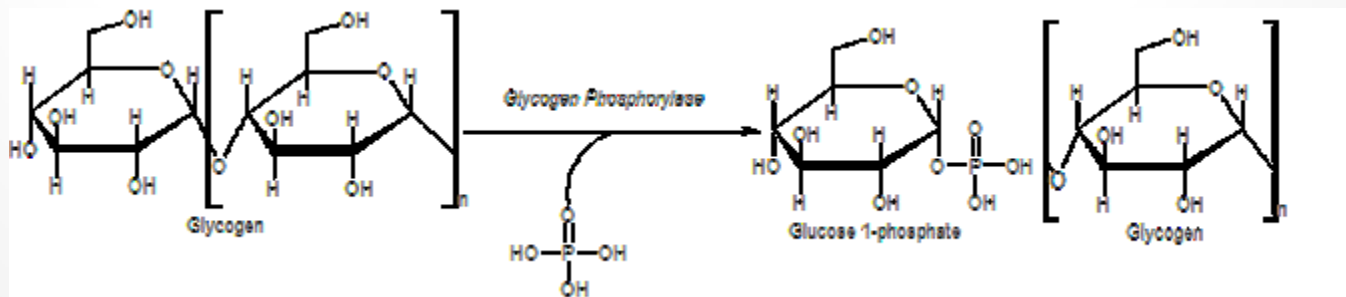



# Metabolismus monosacharidů

- Centrální role glukosy
- Přeměny beze změny počtu C
  - Izomerizace – izomerázy, Glu  $\longleftrightarrow$  Fru
  - Epimerace – Glu  $\longleftrightarrow$  Gal
- Změna počtu C
  - Oxidační odbourání hexosy  $\longleftrightarrow$  pentosy
  - Změna o 2 a 3 – kombinace – změna o 1 – pentosy  $\longleftrightarrow$  hexosy
    - Přenos štěpů – donor ketosa, akceptor aldosa
    - Transketolace – přenos 2C
    - Transaldolace – přenos 3C

# Přímá oxidace glukosy

- Glukosa + ATP  
➔ Glu-6-P + ADP

- Probíhá s Glu-6-P
- U mikroorganismů a plísní s volnou glukosou

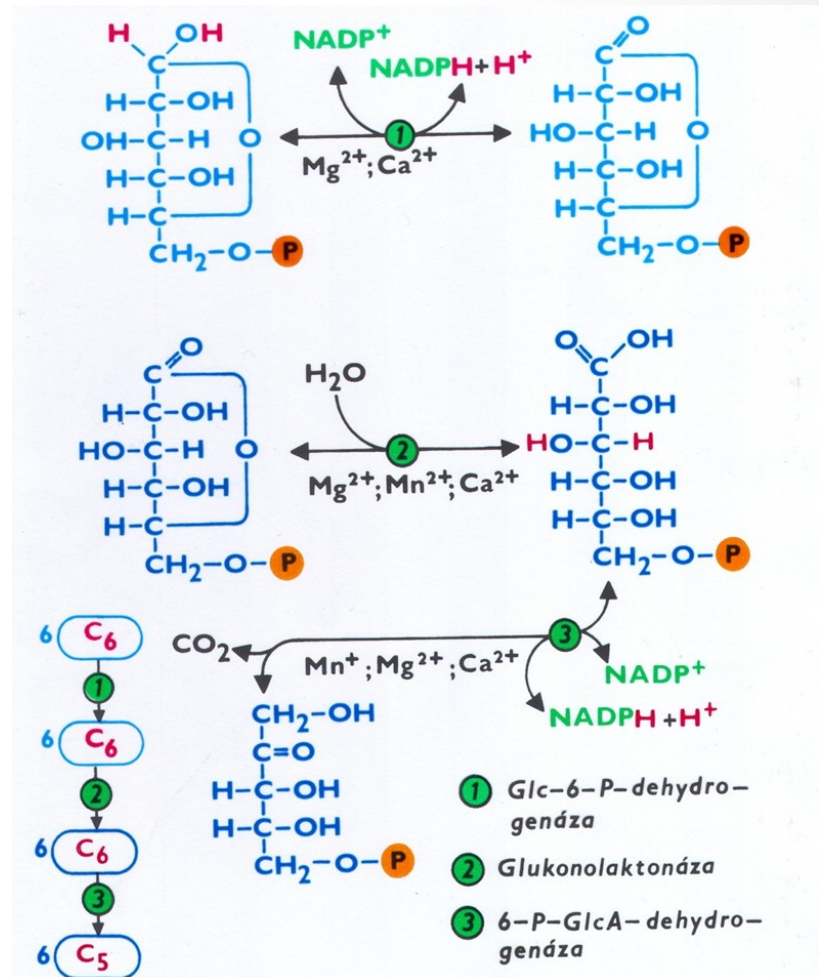

# Pentosový cyklus

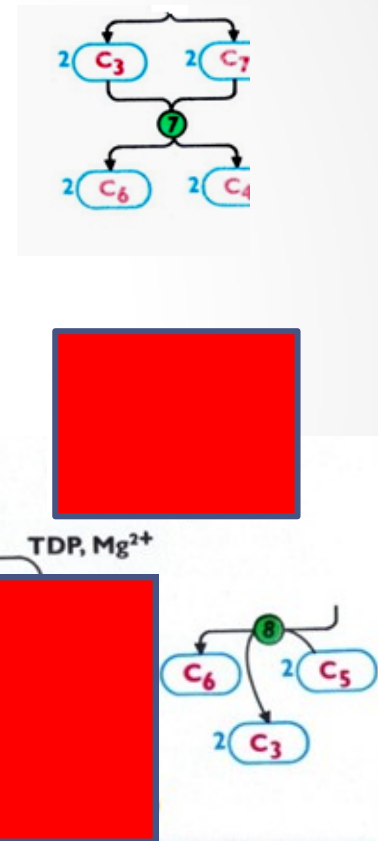
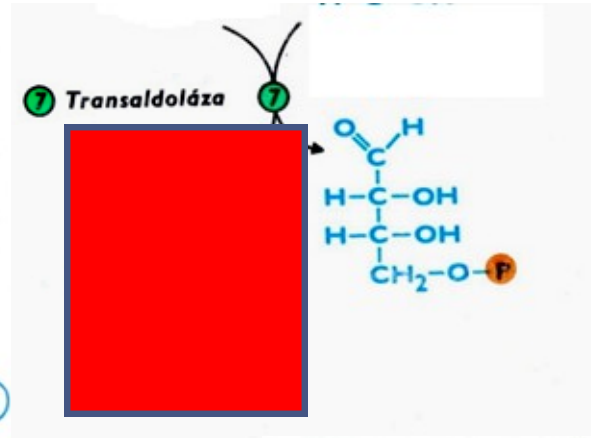
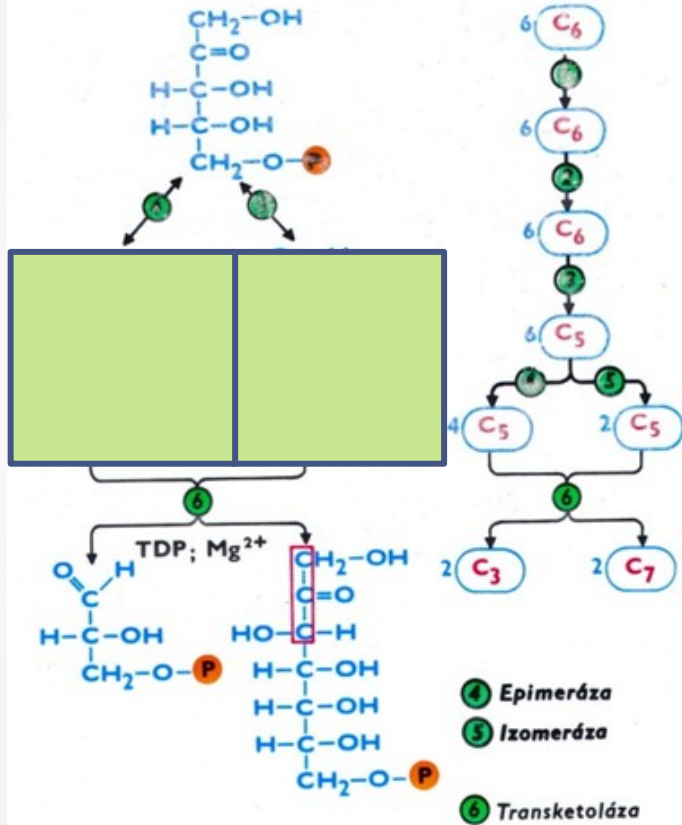

- $3 \times C_5 = 2 \frac{1}{2} C_6$

# Pentosový cyklus

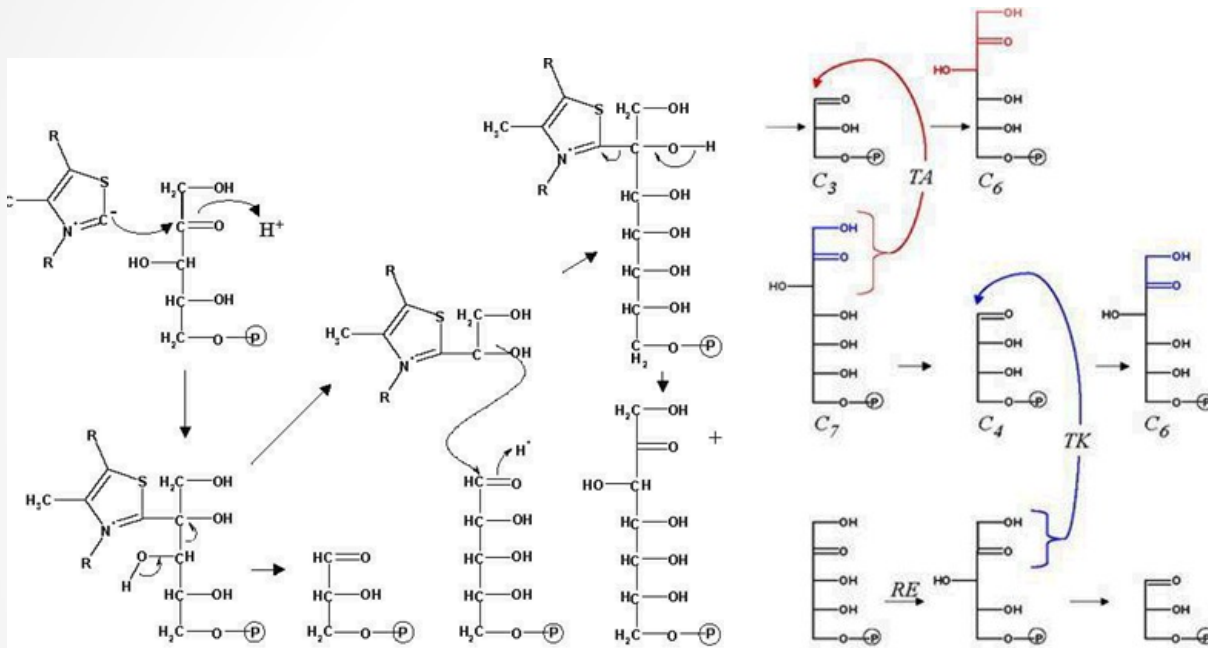

- $3 \times C5 = 2 \frac{1}{2} C6$
- TPP jako kofaktor transketolázy

# Pentosový cyklus

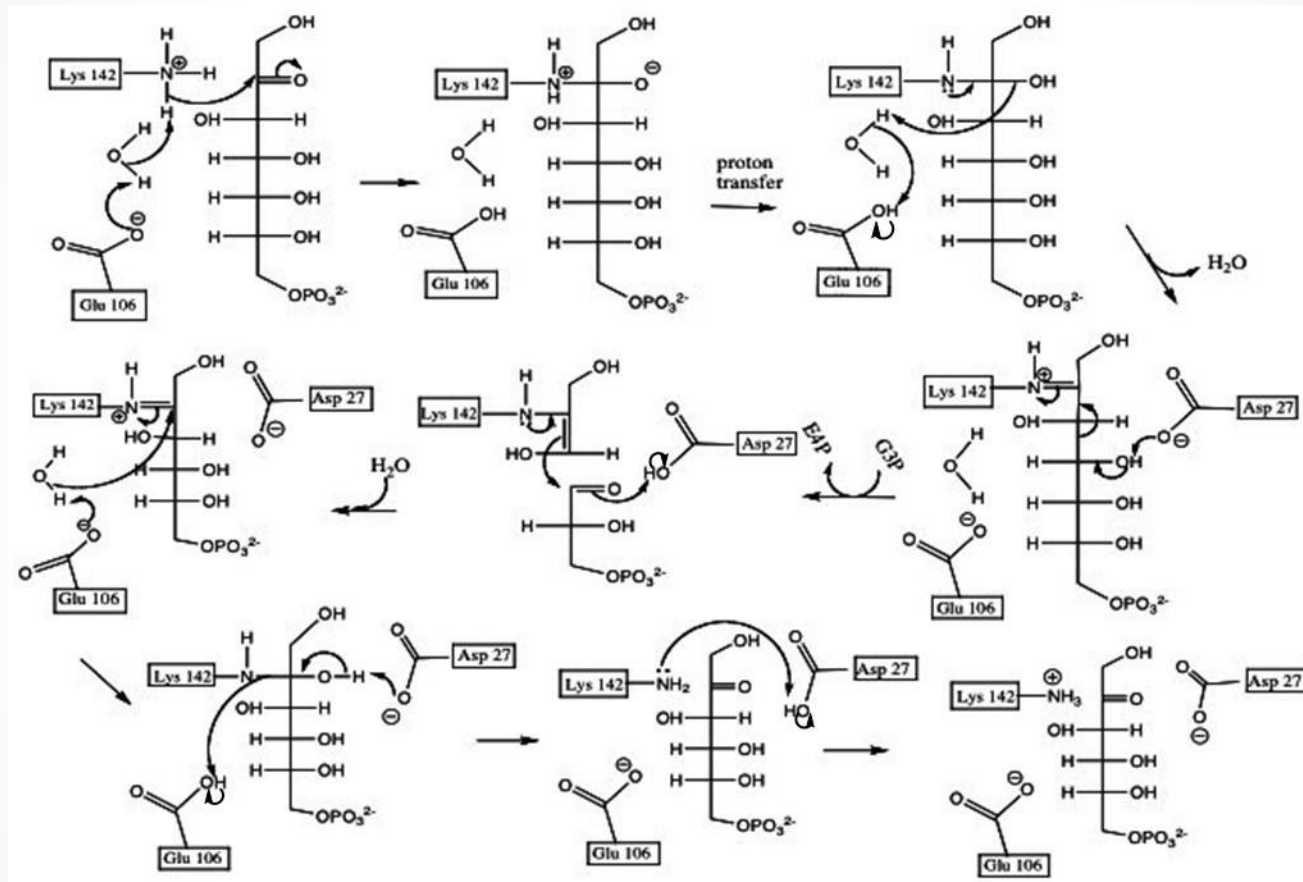

- Účast transaldolasy

# Mechanismus transketolase

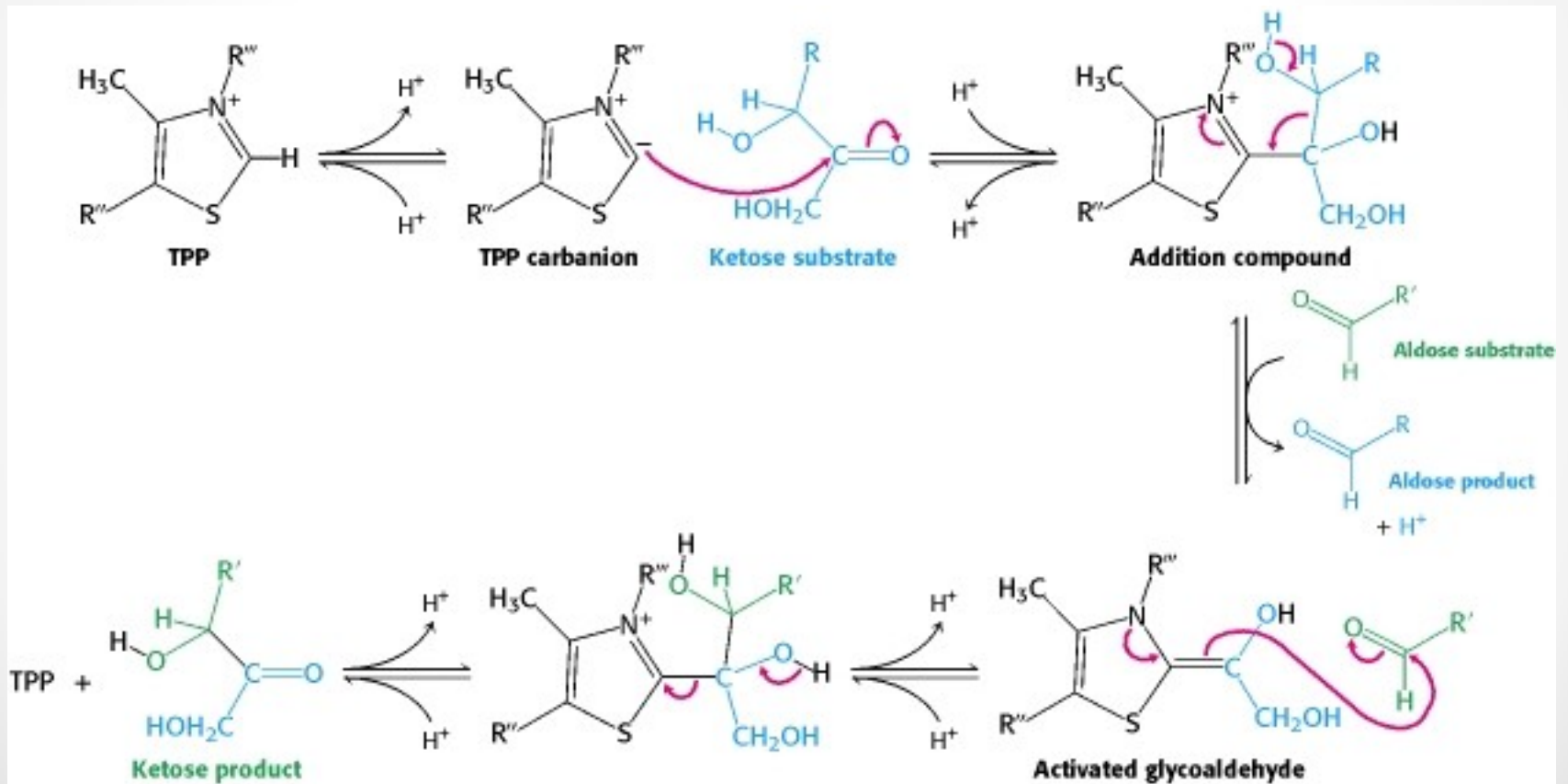

# Mechanismus transaldolace

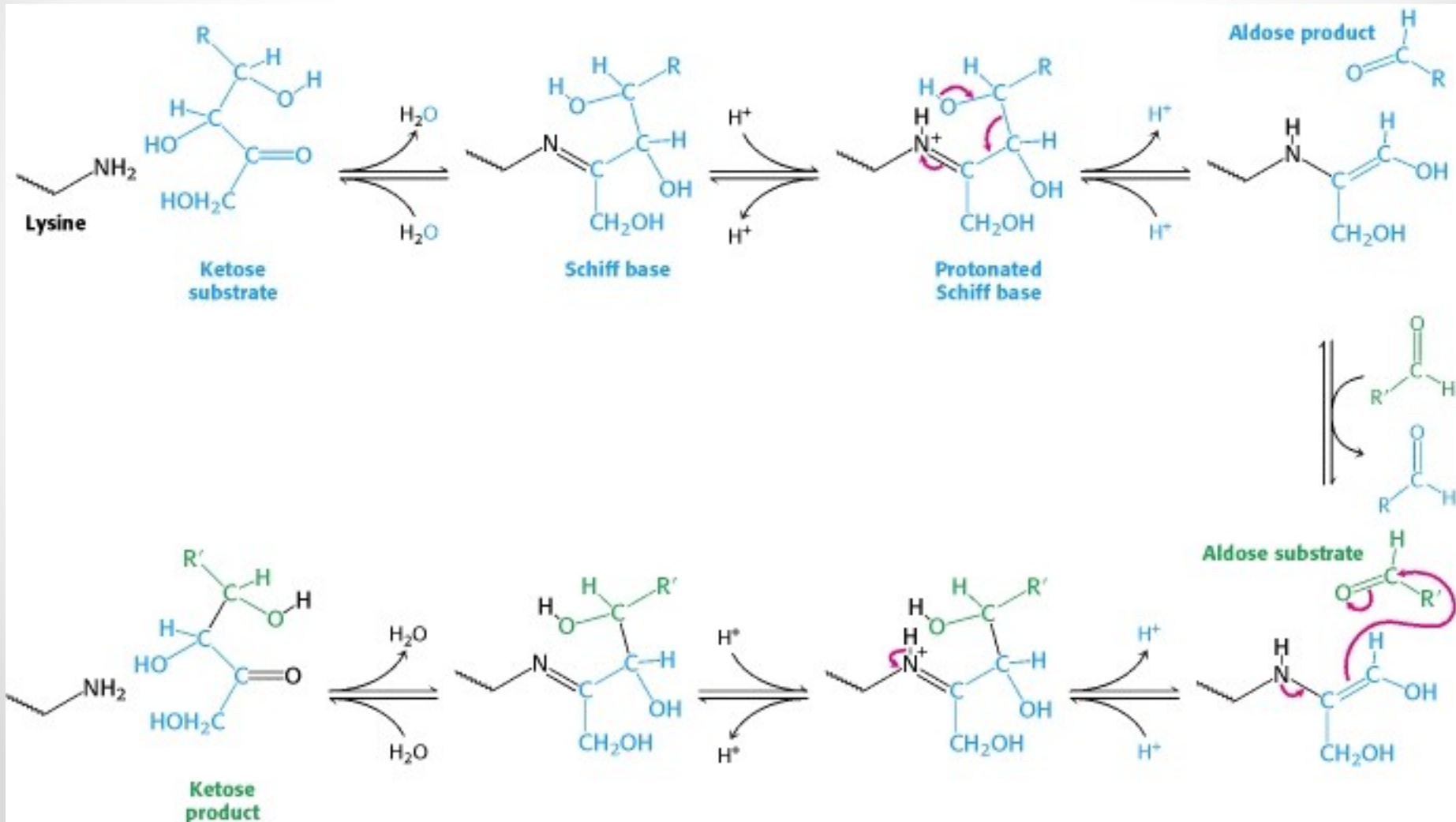



# Aktivní centrum transaldolasy

