

ELEMENTARY BAND THEORY

PHYSICIST

Solid state band
Valence band, VB
Conduction band, CB
Fermi energy, E_F
Bloch orbital, delocalized
n-doping
p-doping
Band gap, E_g
Direct band gap
Indirect band gap
Phonon or lattice vibration
Peierls distortion

CHEMIST

Molecular orbital
HOMO
LUMO
Chemical potential
Molecular orbital, localized
Reduction, pH scale base
Oxidation, pH scale acid
HOMO-LUMO gap
Dipole allowed
Dipole forbidden
Vibrational mode
Jahn-Teller effect

Electronic Structure of Solids

Valence electrons from the atoms spread throughout the entire structure

Molecular orbitals are extended over all the constituent atoms

A large number of overlapping atomic orbitals lead to molecular orbitals with very similar energies = continuous **band**.

The bands are separated by **band gaps** (energy values where there are no available levels)

Band Theory

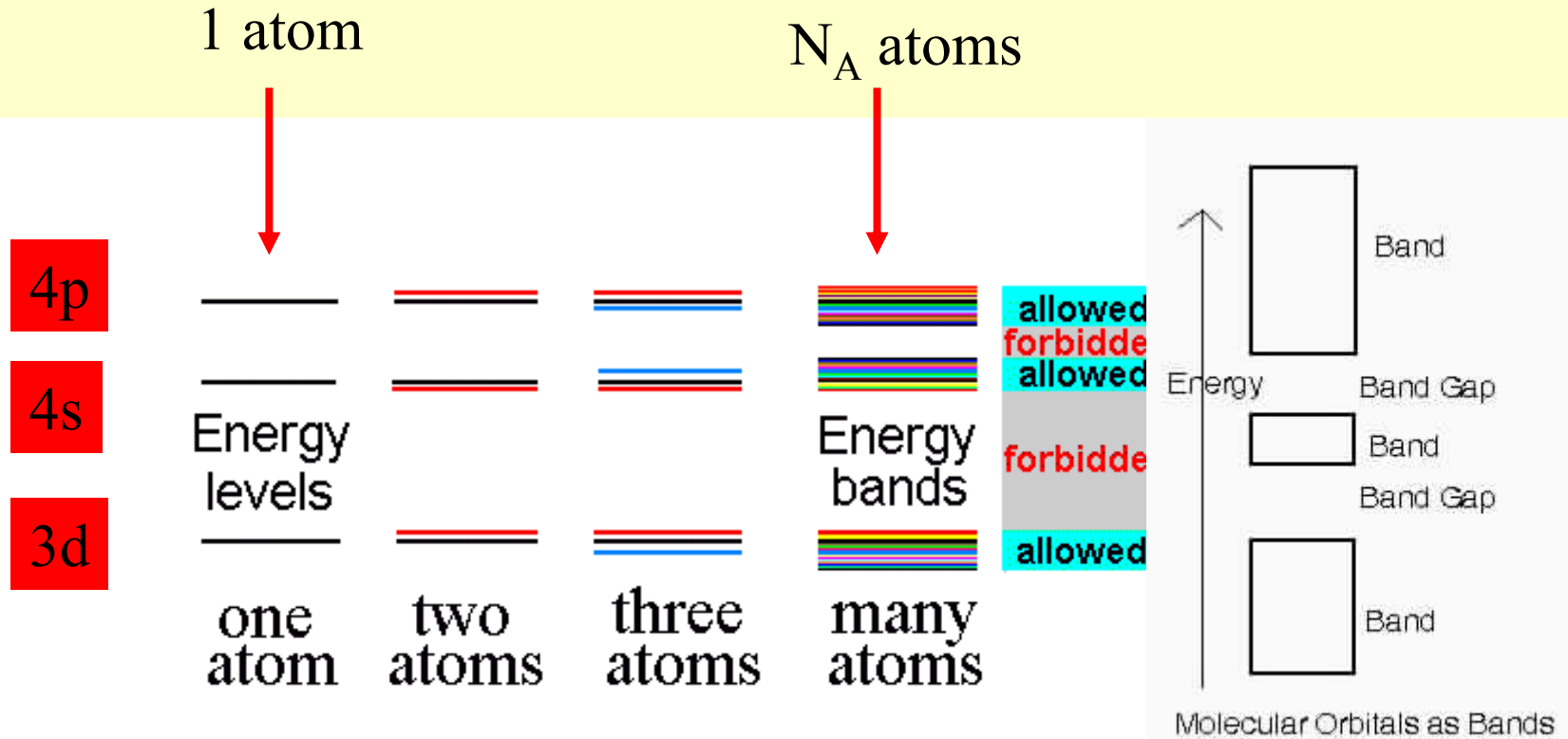

Energies of electrons are quantized = can possess only allowed energies, can occupy only allowed levels, cannot enter forbidden band gaps.

Molecular orbital $\rightarrow\rightarrow\rightarrow\rightarrow\rightarrow\rightarrow\rightarrow\rightarrow\rightarrow$ Electronic band

N atomic orbitals combine to form bonding and antibonding molecular orbitals, **N** energy levels.

Large rings - cyclic boundary condition

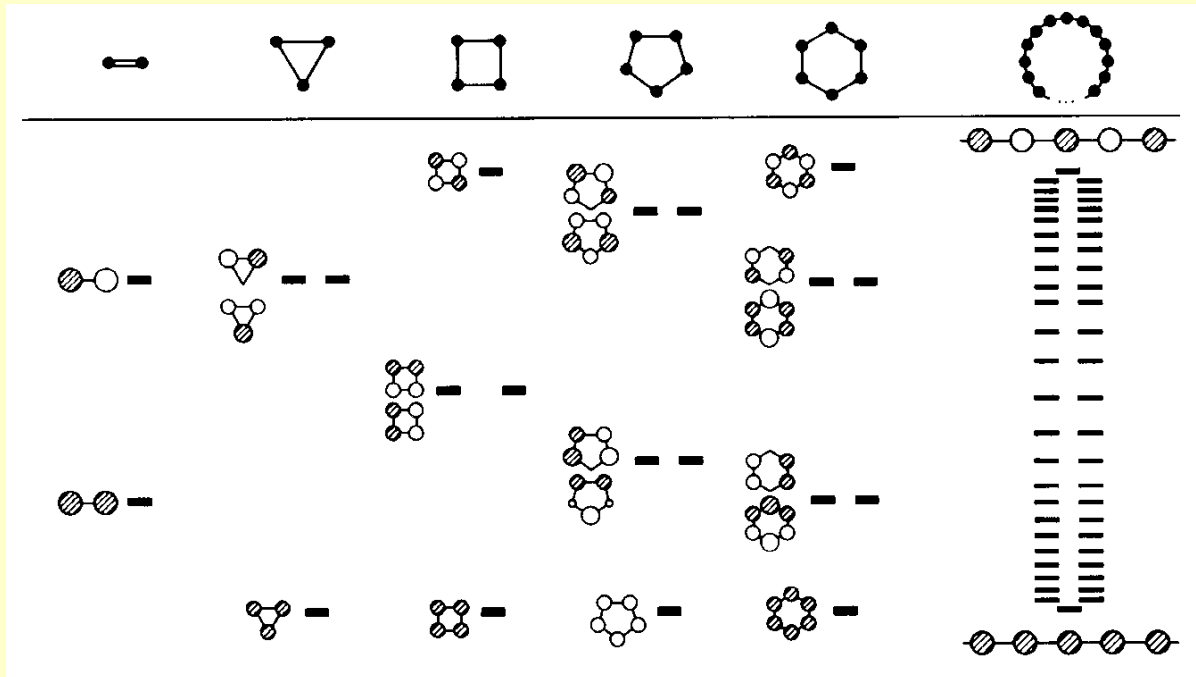

A rough rule of thumb: the separation of the energy levels in the dimer corresponds to about half width of the energy band.

Electronic Structure of Solids

Bands arise from many MO's of slightly different energies - different degree of bonding

The bottom of the band – the lowest energy MO, all bonding character

The top – the highest energy MO with all anti-bonding character

The rest of the band is formed from all the MO's with intermediate bonding character between the two extremes

Band Theory

Bloch functions, crystal orbitals
 simple example:
 infinite one-dimensional array
 of s-orbitals

k = wavevector,
 a = lattice constant,
 n = orbital counter

Large number of discrete levels
 = band

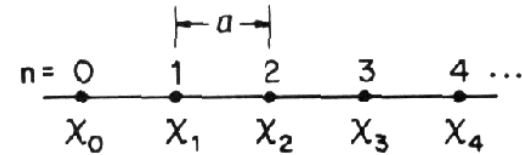

$$\psi_k = \sum_n e^{ikna} \chi_n$$

$$k = \frac{\pi}{a} \quad \psi_{\frac{\pi}{a}} = \sum_n e^{i\pi n} \chi_n = \sum_n (-1)^n \chi_n$$

$$= \chi_0 - \chi_1 + \chi_2 - \chi_3 + \dots$$

Antibonding

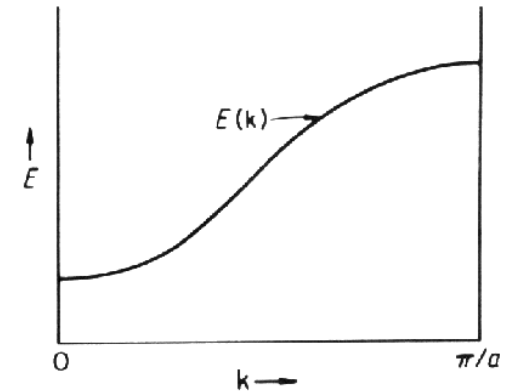
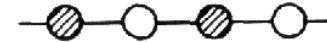

$$k = 0 \quad \psi_0 = \sum_n e^0 \chi_n = \sum_n \chi_n$$

$$= \chi_0 + \chi_1 + \chi_2 + \chi_3 + \dots$$

Bonding



Band Theory

Antibonding orbitals

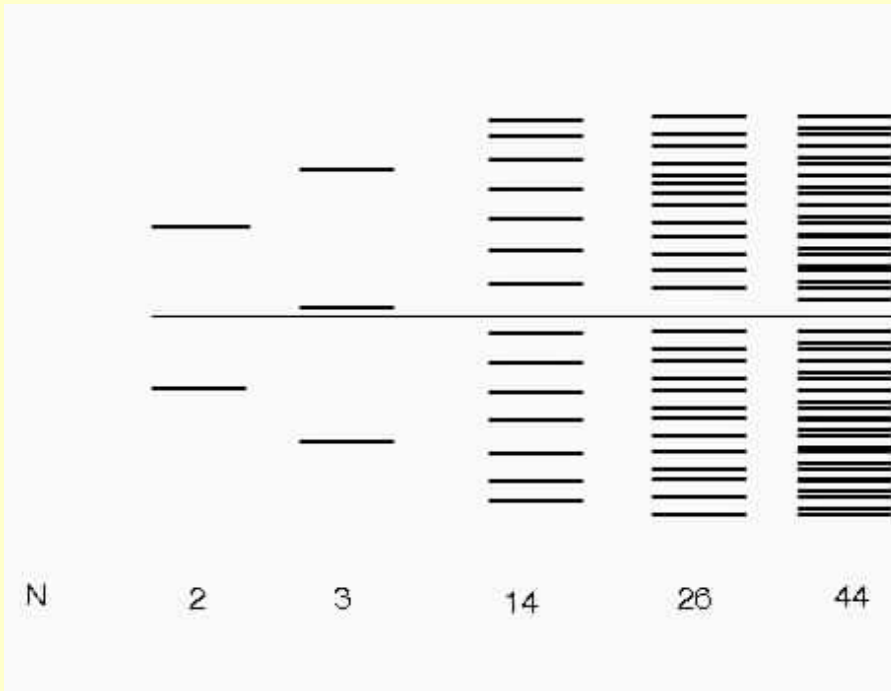

$$k = \frac{\pi}{a} \quad \psi_{\frac{\pi}{a}} = \sum_n e^{i\pi n} \chi_n = \sum_n (-1)^n \chi_n$$

$$= \chi_0 - \chi_1 + \chi_2 - \chi_3 + \dots$$

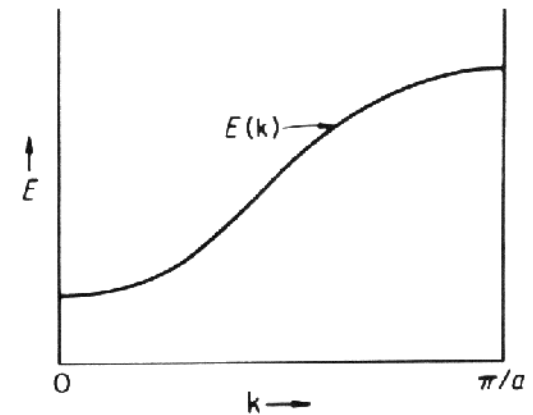
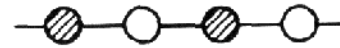

$$k = 0 \quad \psi_0 = \sum_n e^{i0} \chi_n = \sum_n \chi_n$$

$$= \chi_0 + \chi_1 + \chi_2 + \chi_3 + \dots$$



Bonding orbitals

Crystal Orbitals in 1D

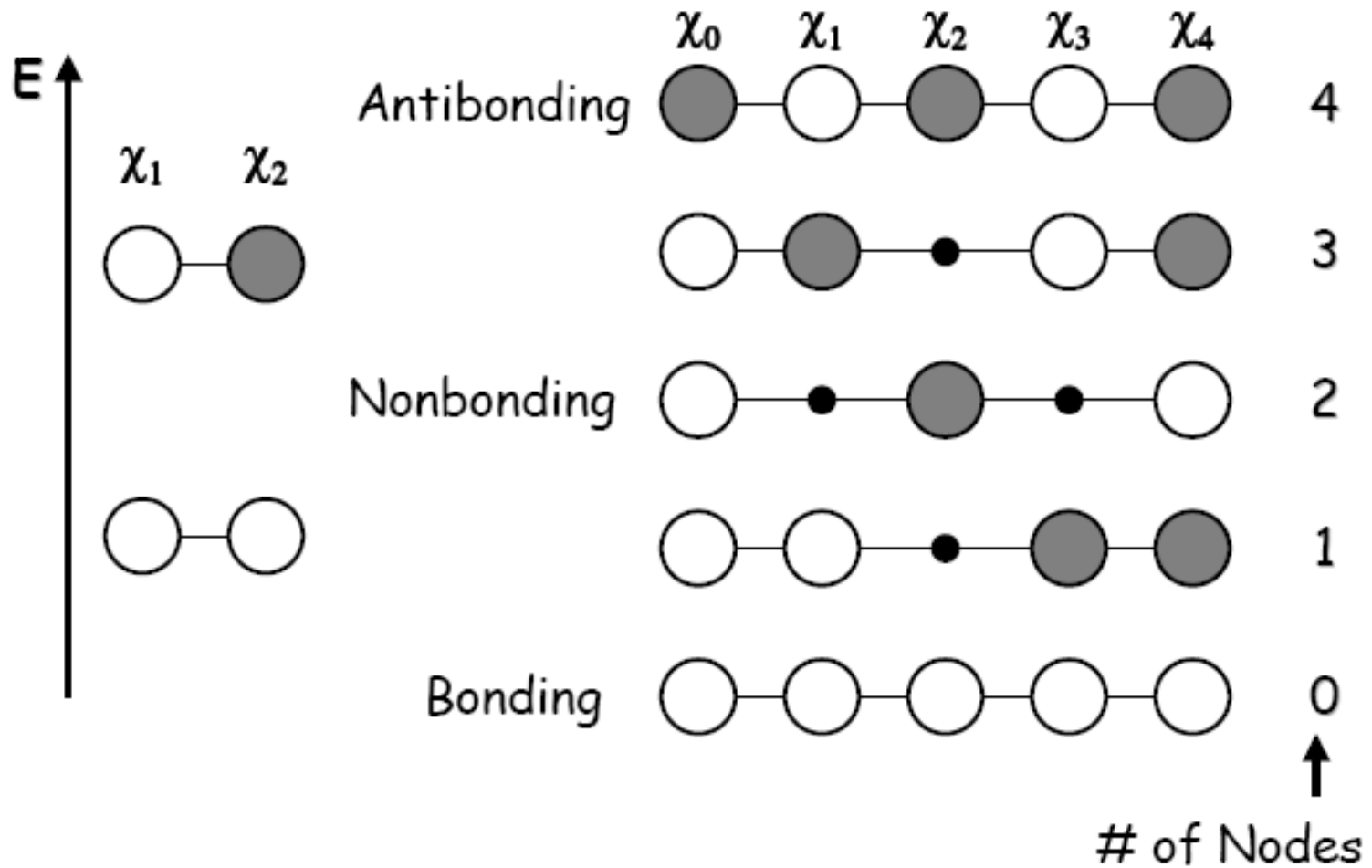

Crystal Orbitals in 1D

N atoms in the chain = N energy levels and N electronic states (MO)

The wavefunction for each electronic state:

$$\Psi_{\mathbf{k}} = \sum e^{i\mathbf{k}n\mathbf{a}} \chi_n$$

Where:

\mathbf{a} is the lattice constant (spacing between atoms)

\mathbf{n} identifies the individual atoms within the chain

χ_n represents the atomic orbitals

\mathbf{k} is a quantum number that identifies the wavefunction and the phase of the orbitals

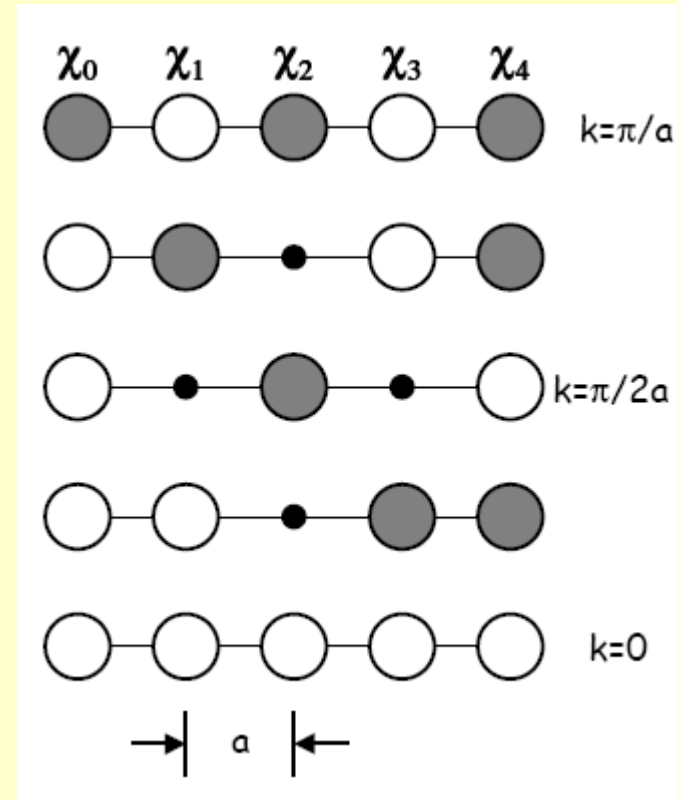

Crystal Orbitals in 1D

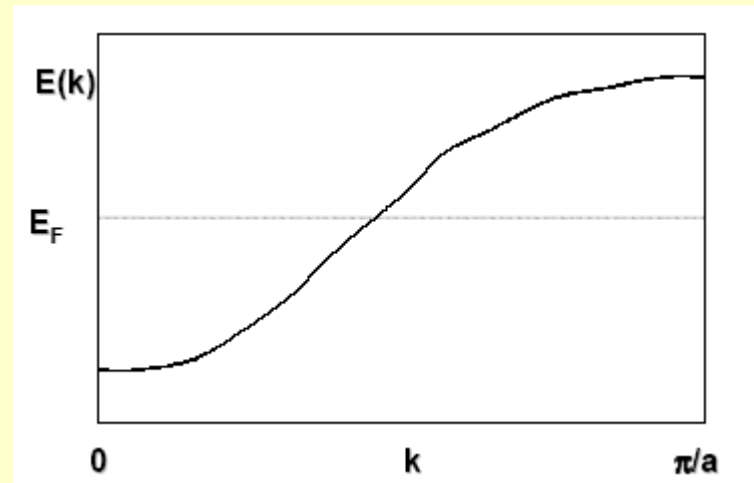
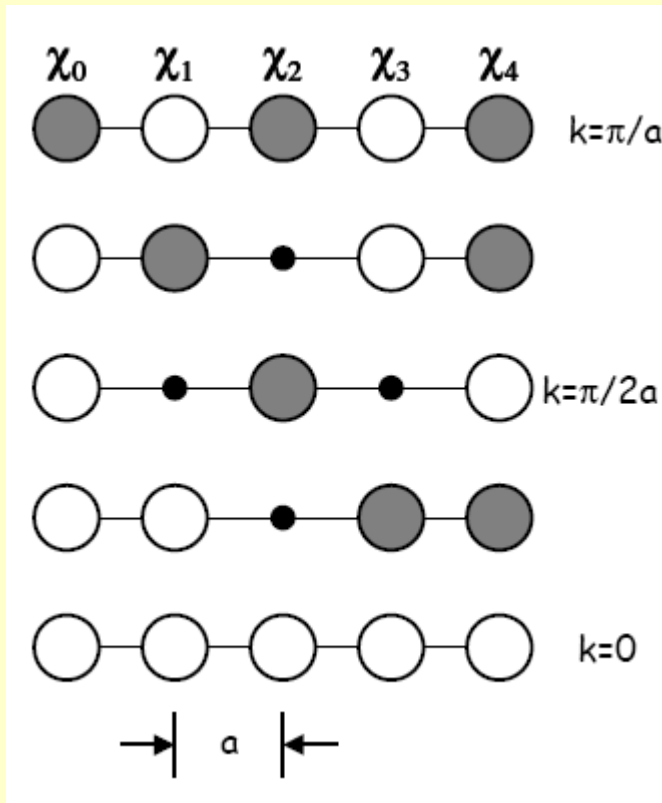

Filling Bands by Electrons

N atoms, 1 electron on each

N levels in a band

Occupied by pairs of electrons

$N/2$ levels filled

$N/2$ levels empty

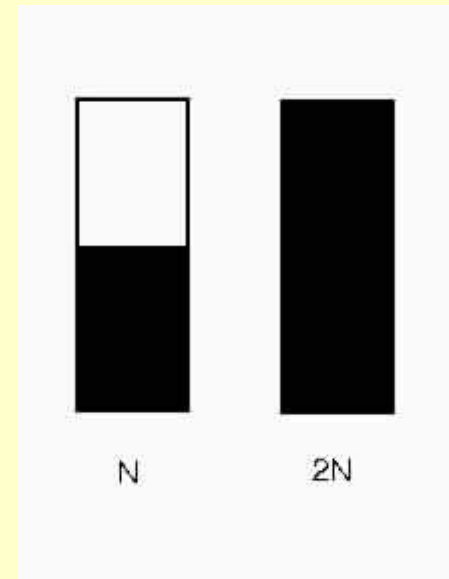

Bands in Metals

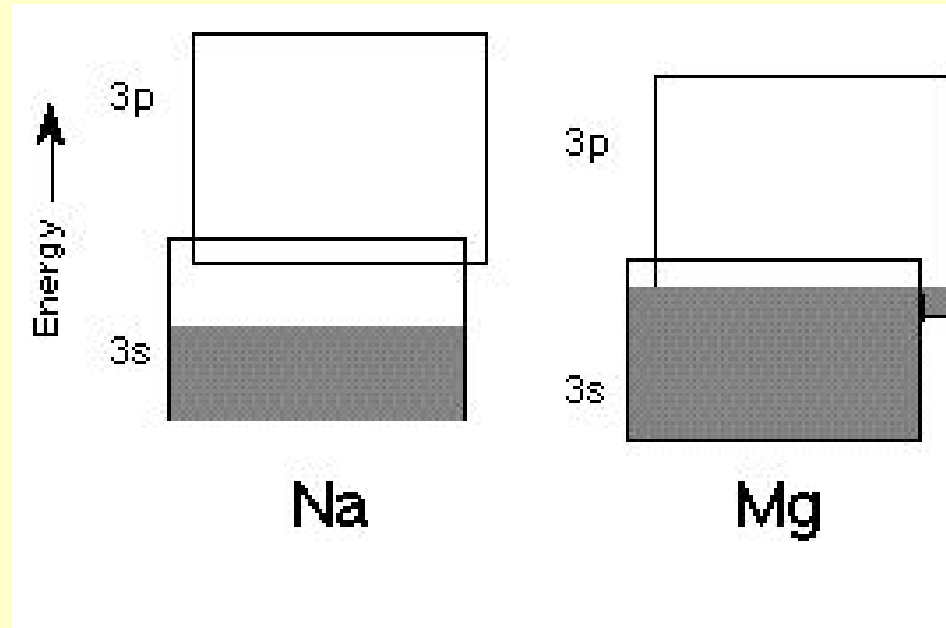
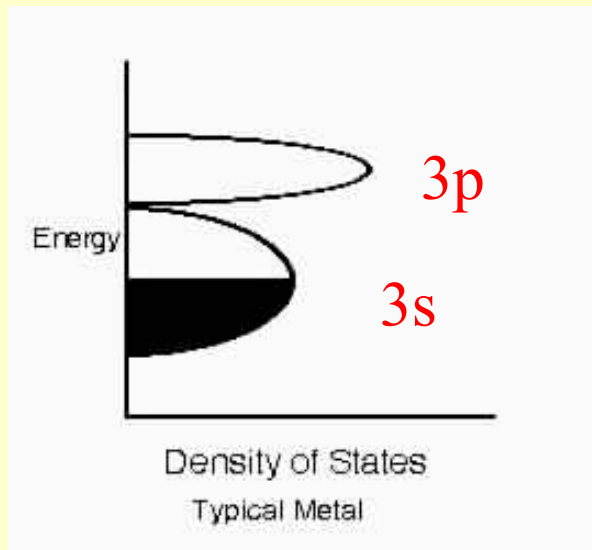

Bandwidth

Bandwidth or band dispersion:

energy difference between the highest and lowest level

Bandwidth increases with better orbital overlap

- shorter interatomic distance
- closer energy match
- topology
- density, oxides more diffuse than halides, wider bands
- localization of electrons – narrow bands

Bandwidth arising from $\sigma > \pi > \delta$ overlap

Core orbitals – narrow bands (0.1 eV), 4f in lanthanides

Valence orbitals, s, p – wide bands (10 eV)

Bandwidth

degree of orbital overlap between building units

Wide bands = Large intermolecular overlap = delocalized e-

Narrow bands = Weak intermolecular overlap = localized e-

Bandwidth or band dispersion

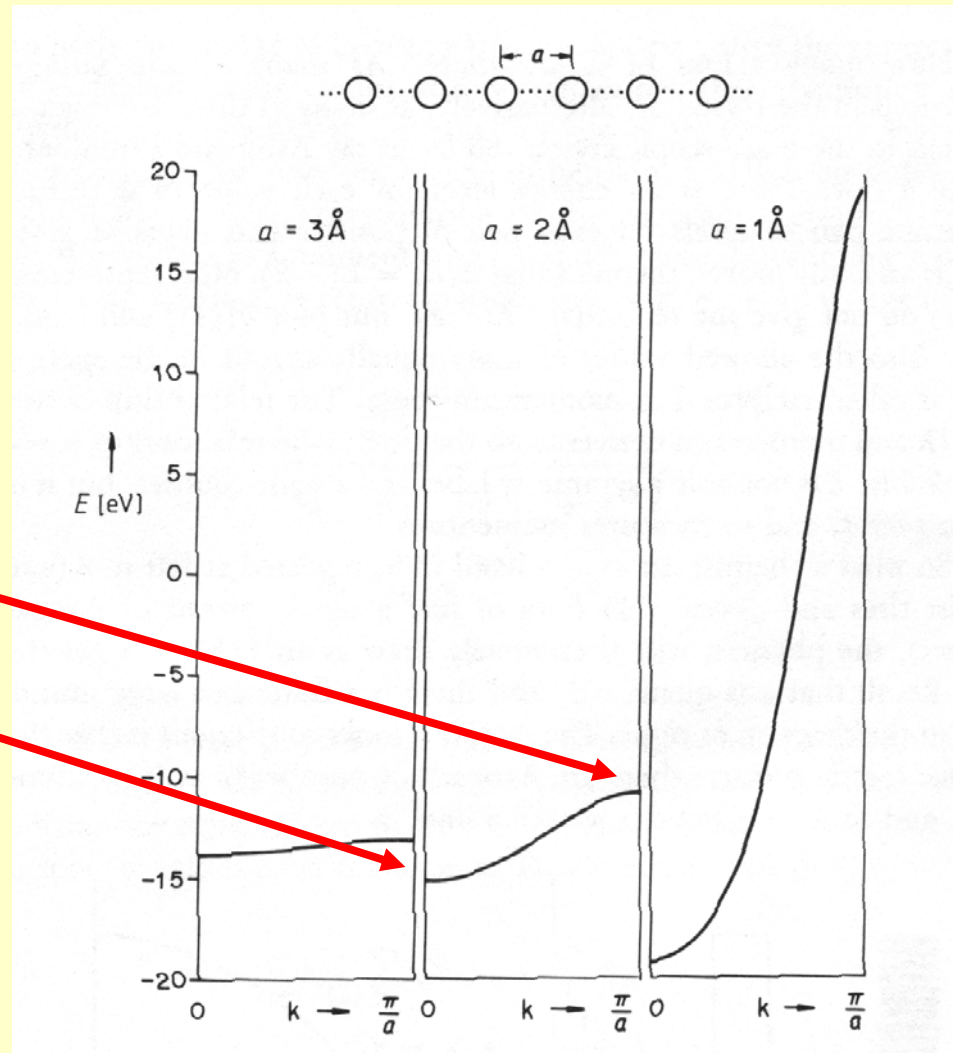

energy difference
between the highest
and lowest level

Different types of orbitals
(symmetry) form separate bands
s, p, d bands

distinct bands with a band gap
overlapping bands

depends on the separation of the
orbitals and strength of the
interaction between the atoms

Strong interaction = wide bands and
a greater overlap.

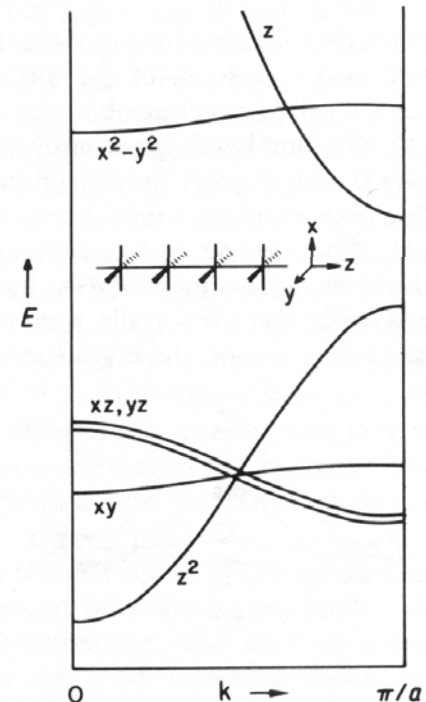
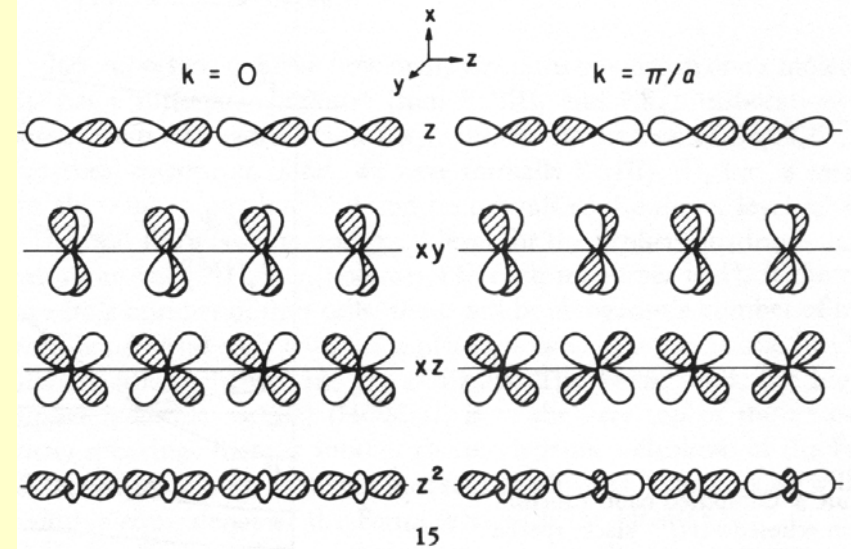

Two dimensional lattice

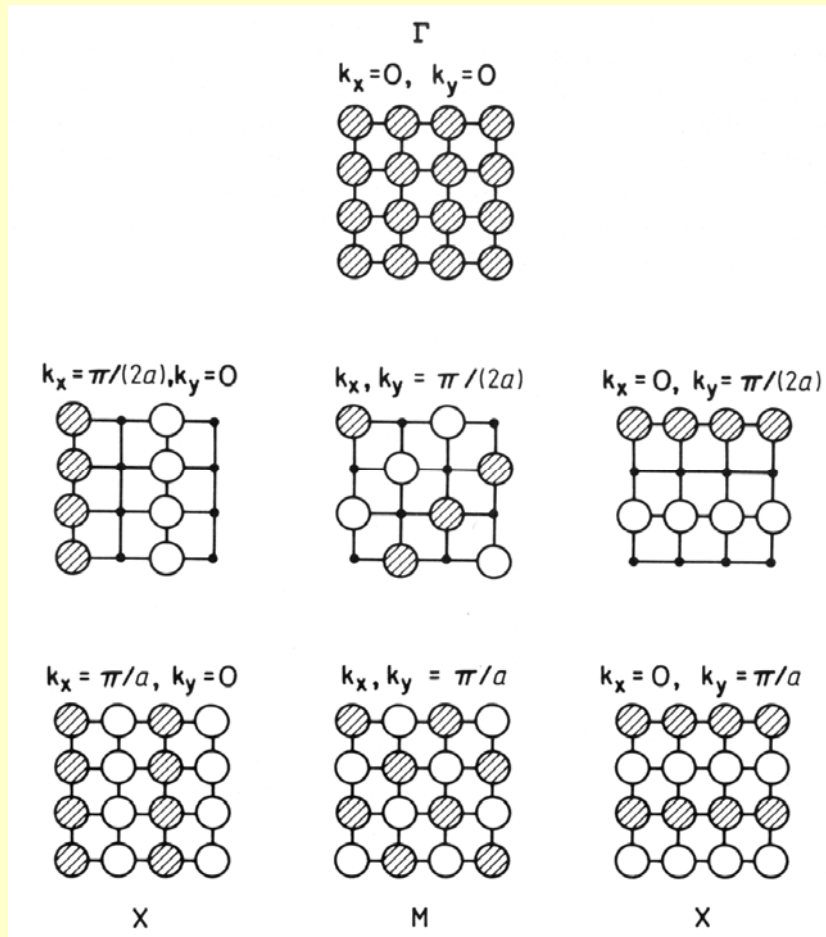

Two dimensional lattice

**Band structure
of a square lattice of H atoms
($d_{\text{HH}} = 2.0 \text{ \AA}$)**

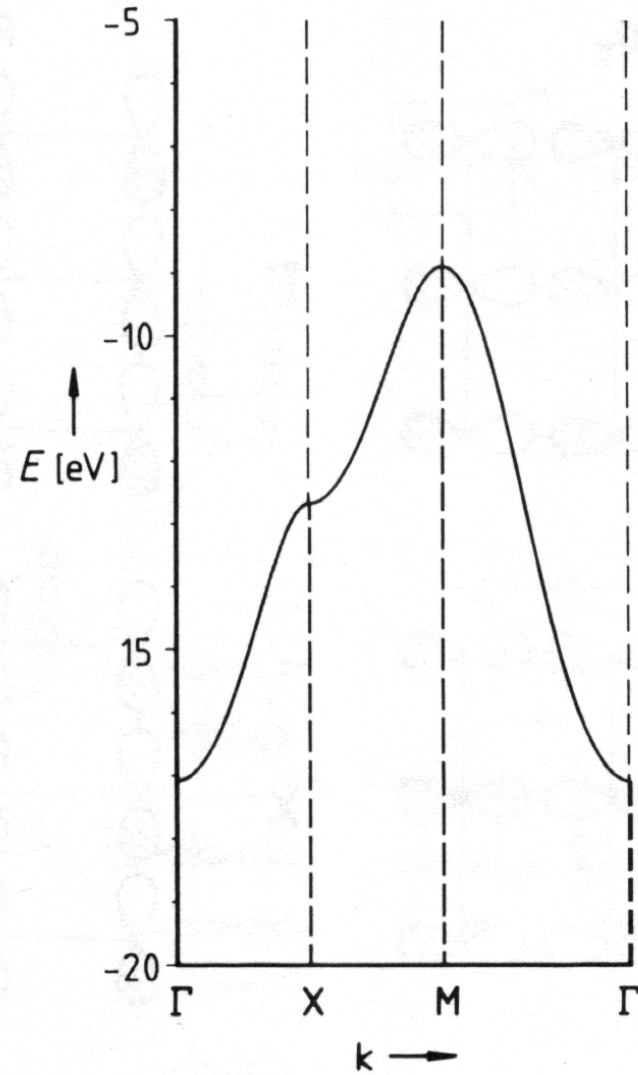

Density of states

Density of states (DOS, $N(E) dE$)

Number of levels available for electrons at different energies per unit volume of the solid.

DOS is zero in the band gap

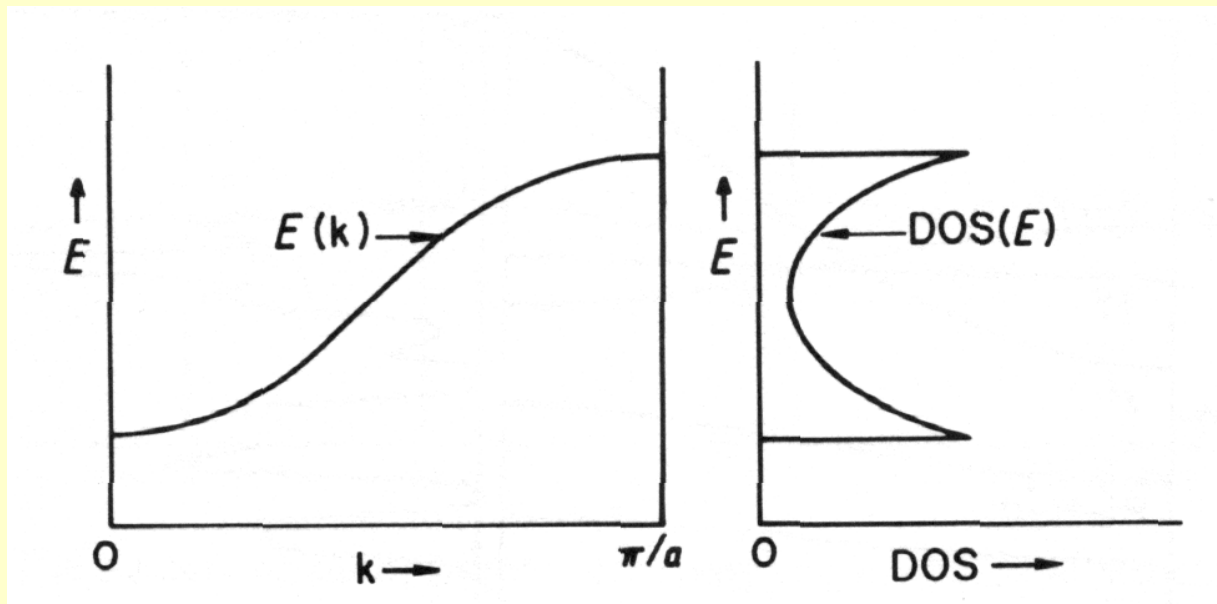

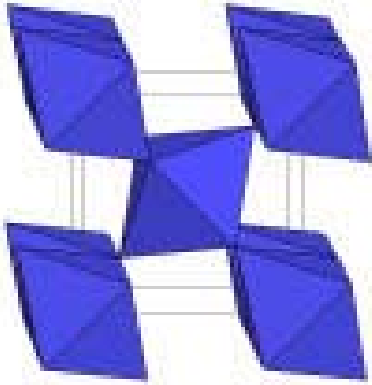

Rutile TiO₂ Band Structure

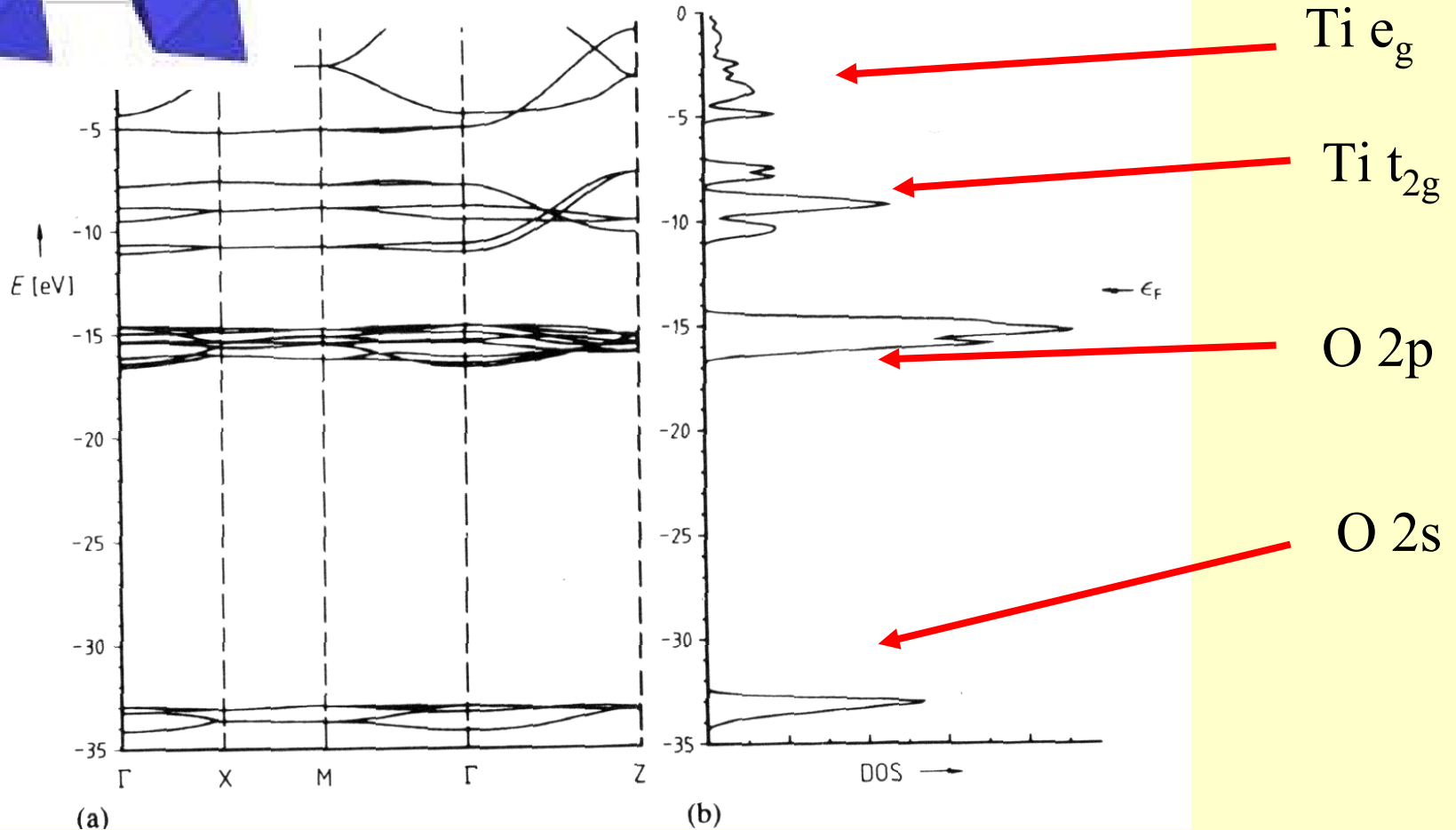

band structure (a) and DOS (b)

Contributions to the total DOS of rutile

(a) Ti and O

(b) Ti d-orbitals, t_{2g} and e_g

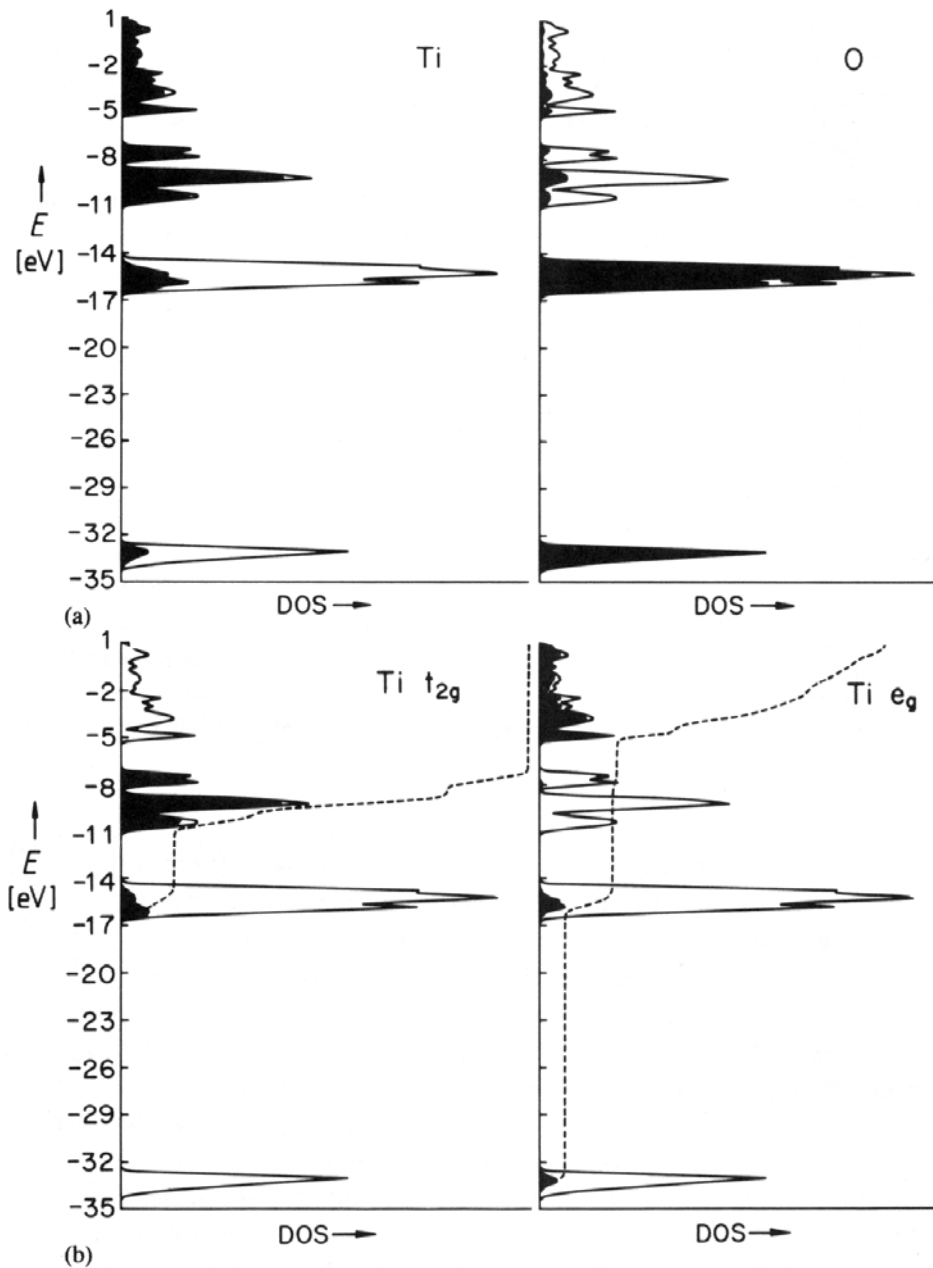

Classification of solids

Molecular solids – N₂, C₆H₆, I₂, ...

Van der Waals forces, little change from the gas phase, electronic bands correspond to empty and filled MOs of the individual molecules.

Ionic solids – NaCl, CaF₂, NiO, ...

Charge transfer from cations to anions, energy bands made up from the atomic orbitals of cations and anions.

NaCl: 3p of Cl is the top filled band, 3s of Na is the lowest empty band.

Covalent solids – diamond, Si,

Overlap of orbitals and electron sharing between adjacent atoms. Filled bands are made up from bonding MOs, empty bands are made up from antibonding MOs.

Metallic solids – Cu, Mg, W, TiO,

Simple metals – Na

Very strong overlap of atomic orbitals on adjacent atoms, arising bands are very broad, 3s, 3p, and 3d merge into a single wide band, electrons move freely, little attraction to the atomic cores.

Ionic solids

Example NaCl, $E_g = 9 \text{ eV}$

i = ions in the gas phase

ii = ions in the lattice,
Madelung potential,
filled levels stabilized by positive
potential of cations,
empty levels destabilized

iii = polarization energy

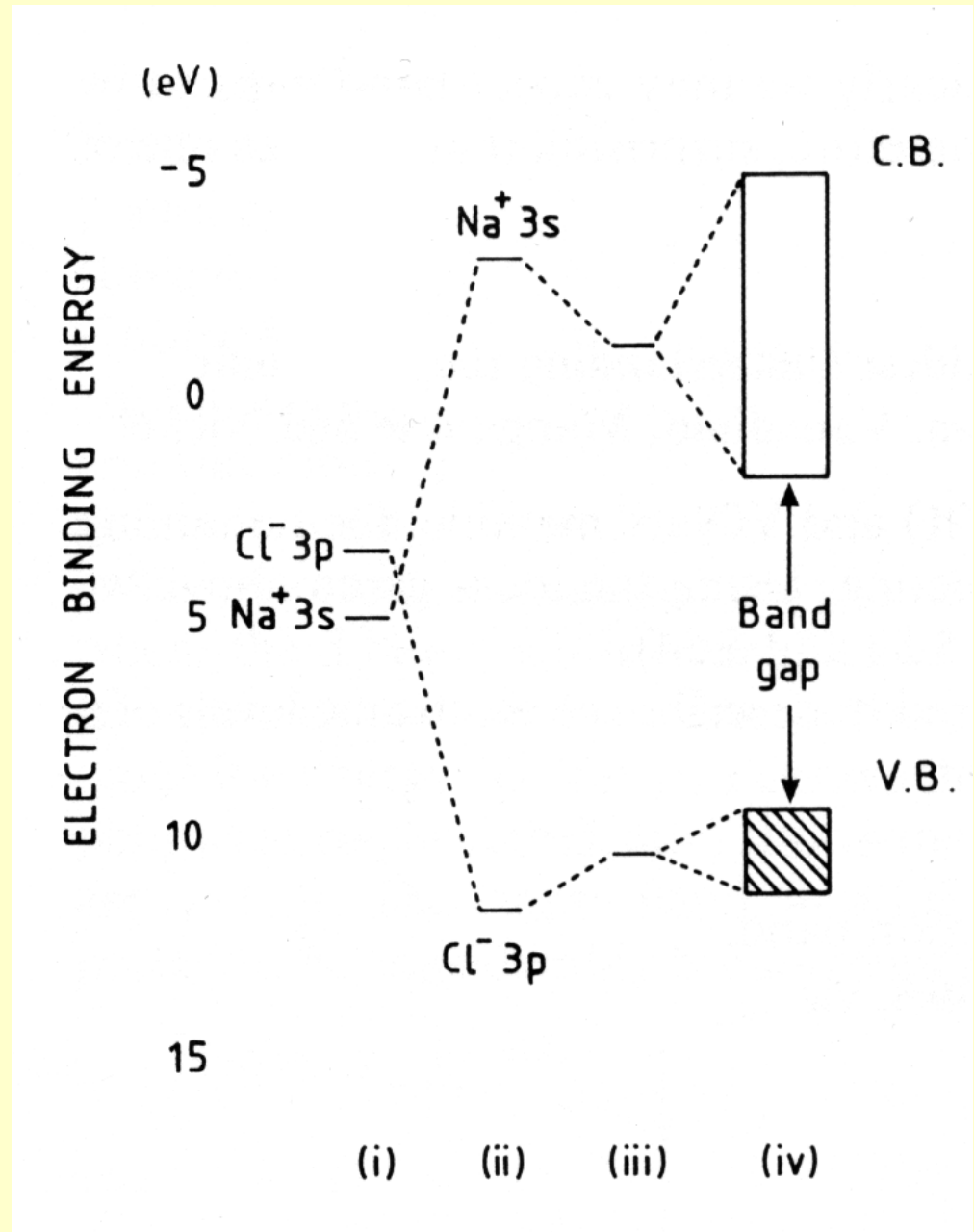

Metallic and Non-metallic Solids

The distinction between metallic and non-metallic solids
the orbitals filling

Metallic behavior – a partially filled band, no gap between
the top filled level (Fermi level) and the lowest empty one

Non-metallic behavior – a completely filled level (the
valence band) and an empty one (the conduction band)
separated by a band gap

Fermi level

E_F = the thermodynamic chemical potential for electrons in the solid

Metals – boundary between filled and unfilled levels

The Fermi-Dirac distribution function:

$$f(E) = 1/[1 + \exp\{(E - E_F)/kT\}]$$

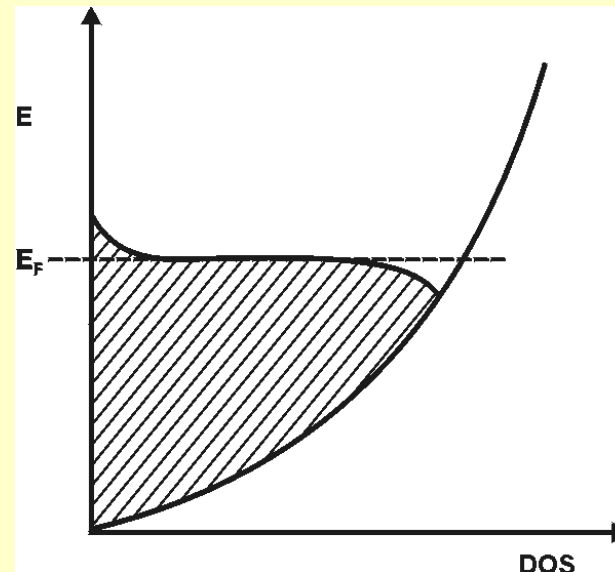
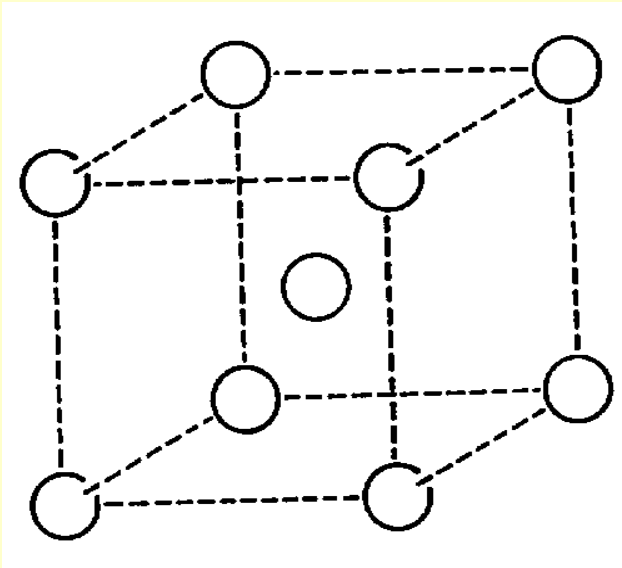

The Fermi level cuts a band in a metal

Fermi Level

E_f occupation probability $\frac{1}{2}$

Levels

$E < E_f$ occupied

$E > E_f$ empty

$$P = \frac{1}{e^{(E-E_f)/kT} + 1}$$

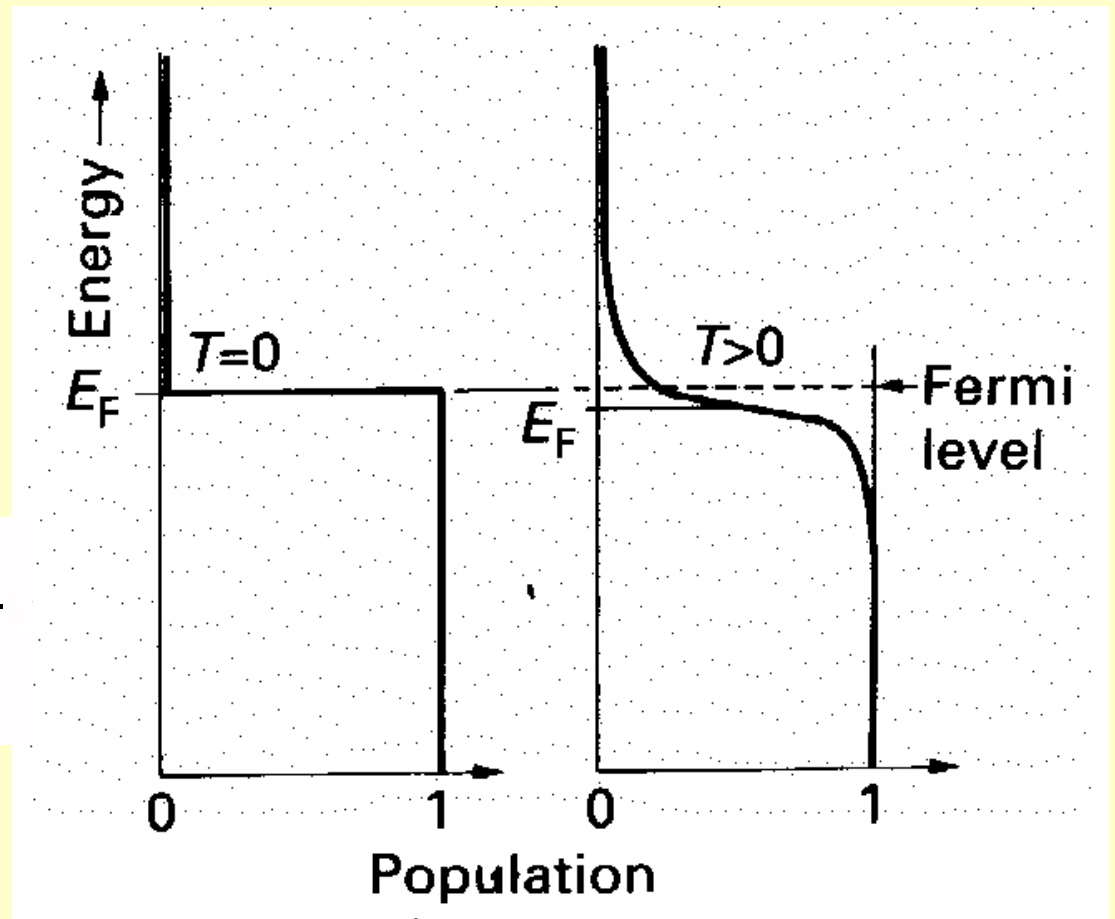

Metallic and Non-metallic Solids

In the filled band every electron is matched by another - no overall net motion of electric charge

For conduction to occur electrons have to be excited up to the conduction band by overcoming an activation energy and hence, the conduction of these compounds increases with temperature

Metallic and Non-metallic Solids

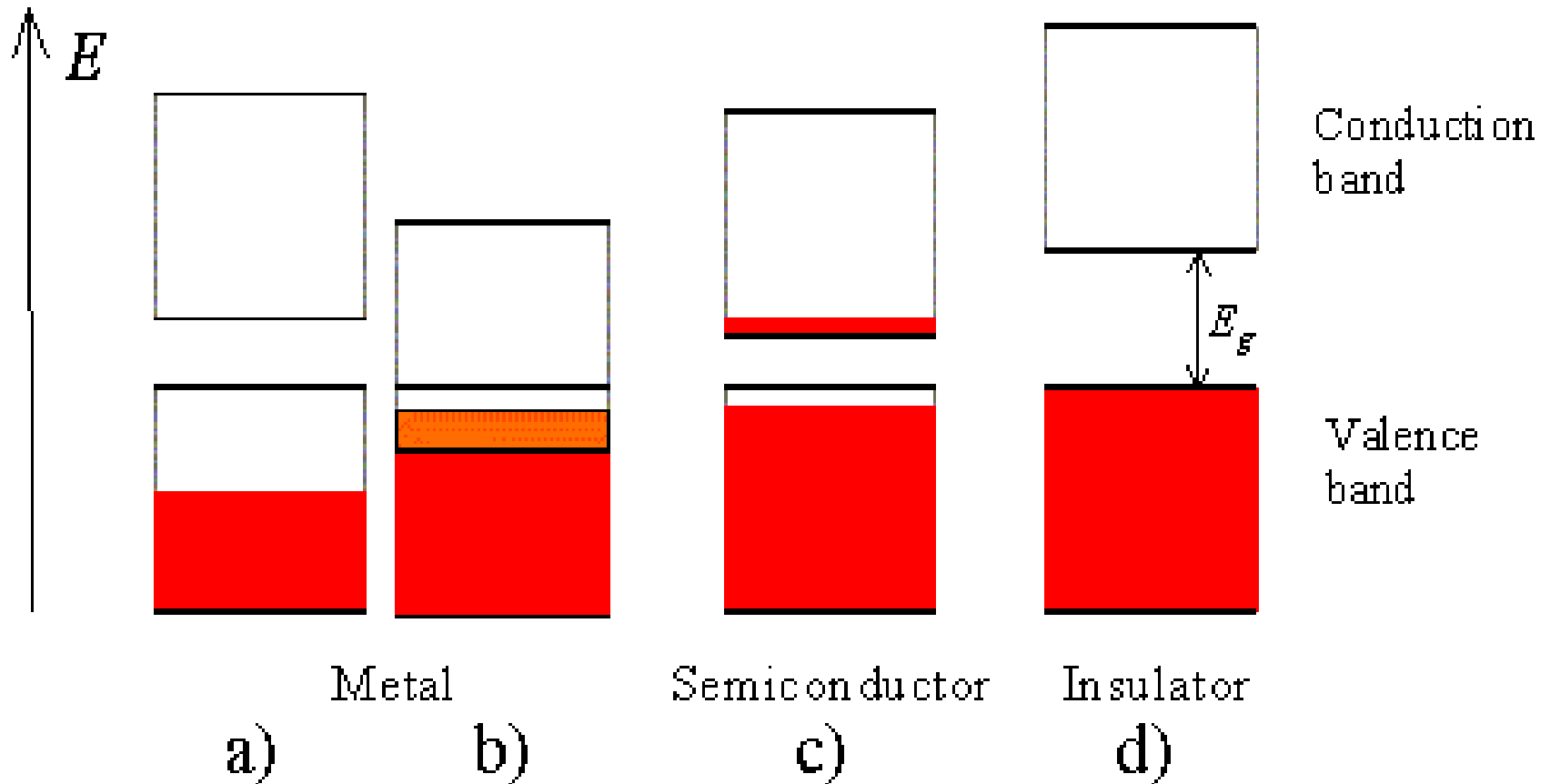

The band gap size determines a semiconductor or an insulator

Band gap = the minimum photon energy required to excite an electron up to the conduction band from the valence band

Insulators - a completely filled valence band separated from the next energy band, which is empty, by a large, forbidden gap

Diamond = insulator, a very large band gap of 6 eV
very few electrons have sufficient energy to be promoted and the conductivity is negligibly small

When conductivity of insulators is measured it is found to increase with temperature

Electrical Conductivity

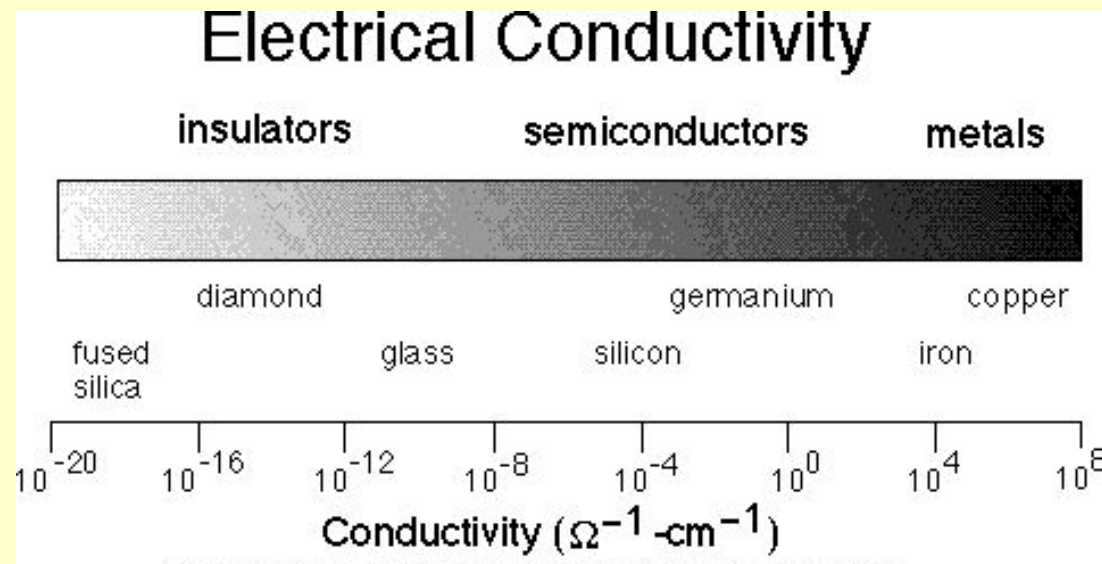
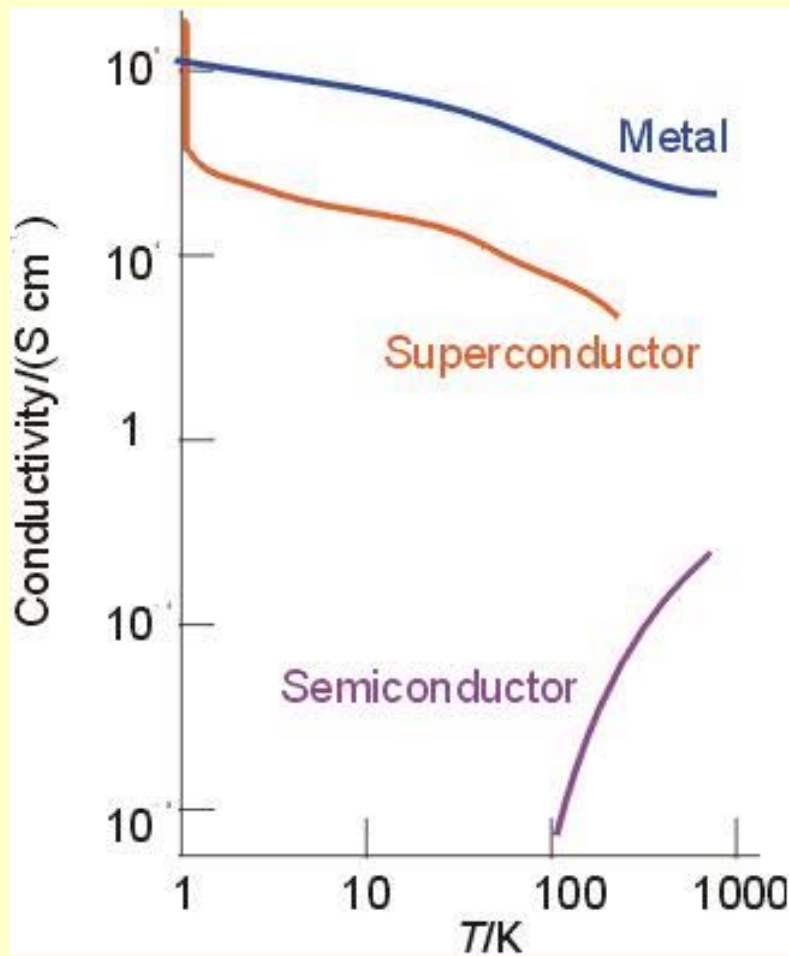

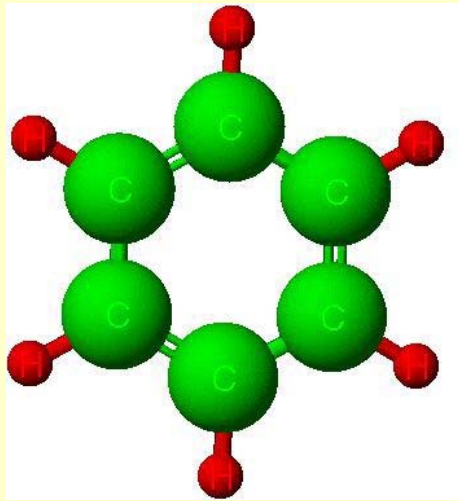

Bands in Graphite

Graphite is a conductor

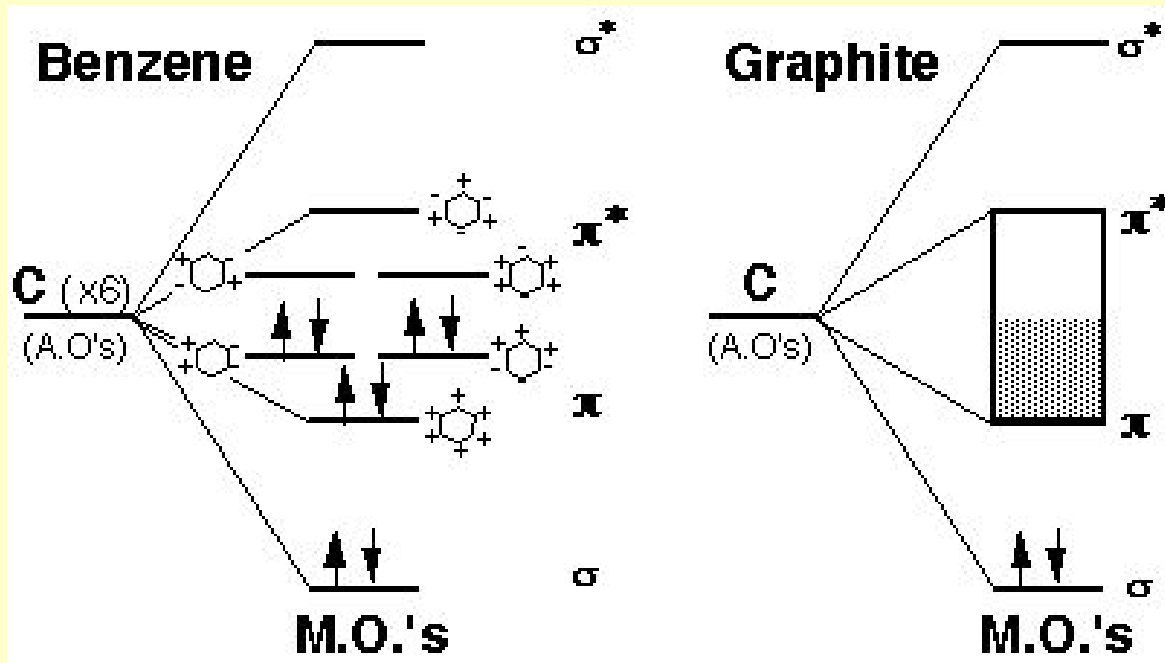
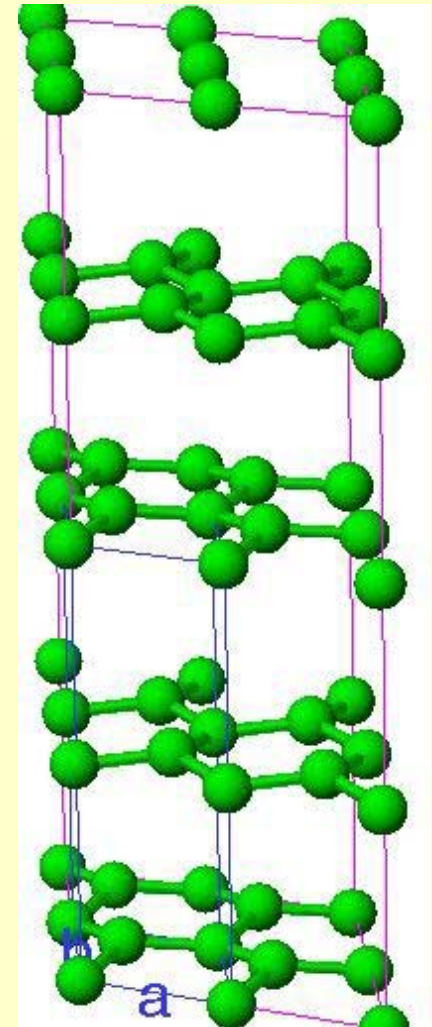

Bands in Diamond

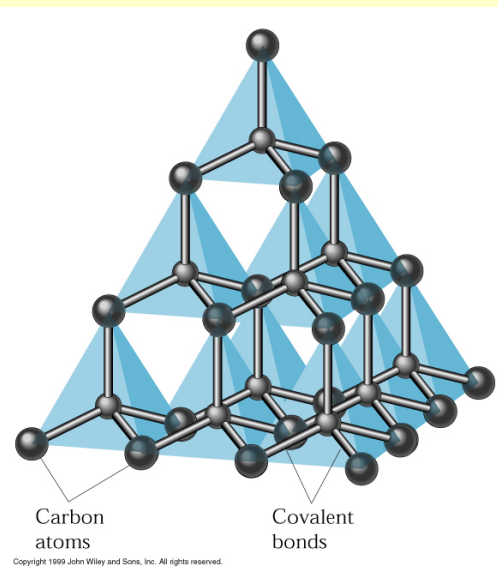
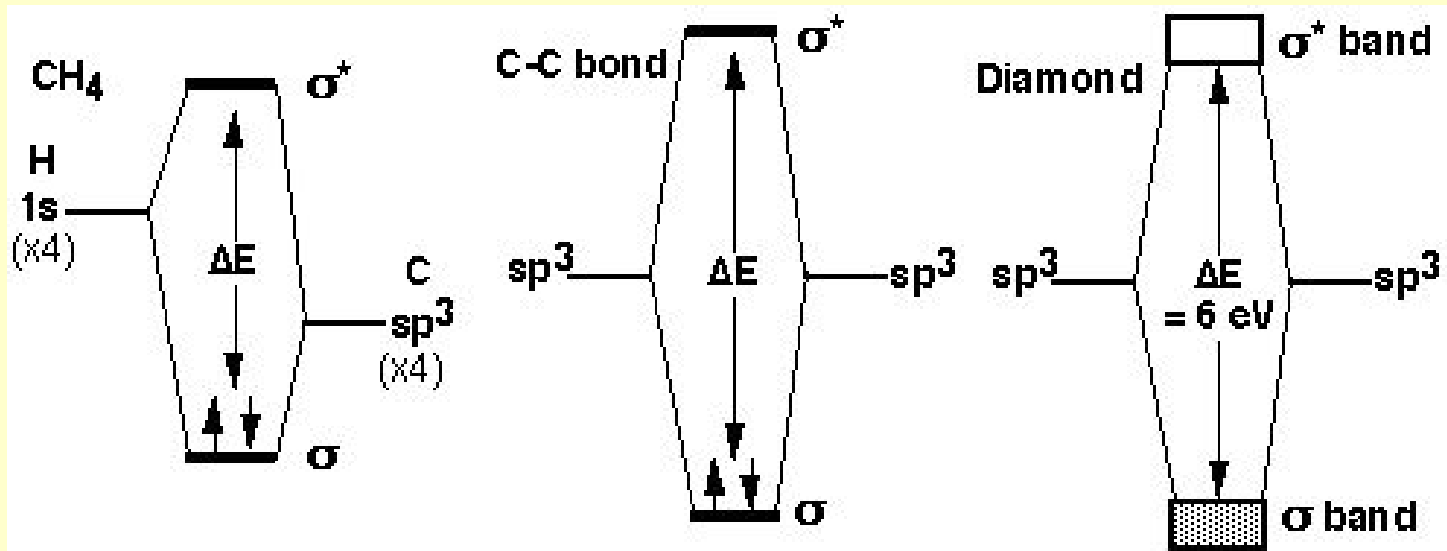

Semiconductors

Semiconductors - a similar band structure to insulators but the band gap is not very large and some electrons have sufficient thermal energy to be promoted up to the empty conduction band.

Two types of conduction mechanism in semiconductors:

- Electrons promoted into the conduction band = **negative charge carriers**, move towards a positive electrode under an applied potential.
- The holes these electrons leave behind = **positive holes**. Holes move when an electron enters them - new positive hole. The positive holes move in an opposite direction to the electrons.

Semiconductors

Fermi level

a gap between the filled and empty states in a semiconductor/insulator

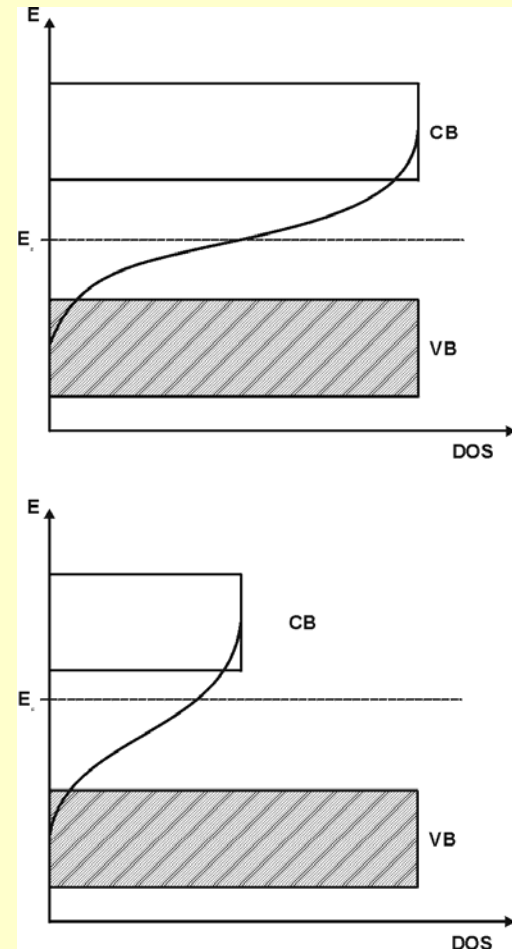

Semiconductors

INTRINSIC

Intrinsic semiconductors are pure materials with the bandstructure. The number of electrons in the conduction band is determined only by the size of the band gap and the temperature (more electrons with small band gap and high temperature).

EXTRINSIC

Extrinsic semiconductors are materials where the conductivity is controlled by adding dopants with different numbers of valence electrons to that of the original material.

Two fundamental differences between extrinsic and intrinsic semiconductors:

1) At standard temperatures extrinsic semiconductors tend to have significantly greater conductivities than comparable intrinsic ones.

2) The conductivity of an extrinsic semiconductor can easily and accurately be controlled by controlling the amount of dopant.

Materials can be manufactured to exact specifications of conductivity.

Metals

$T > 0$

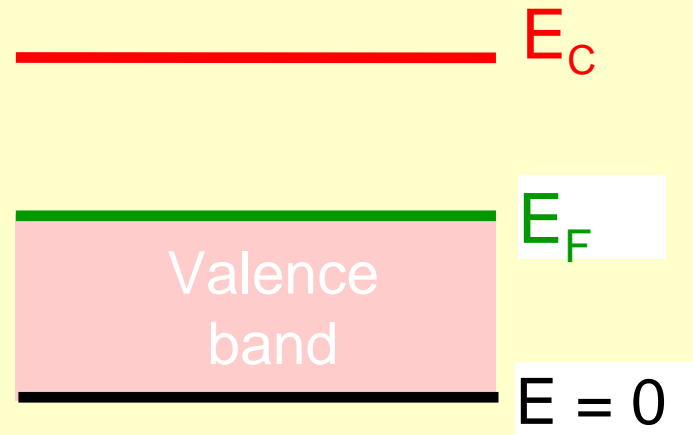
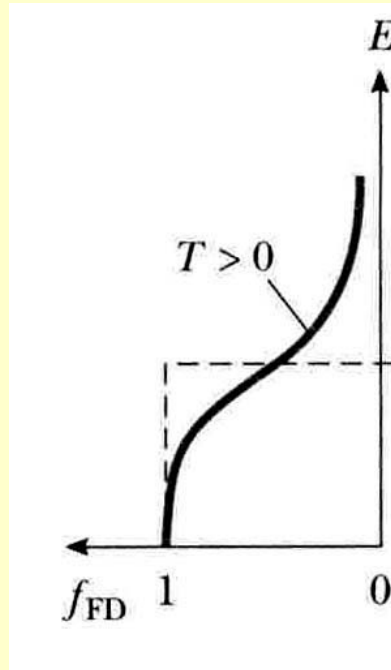

Insulators

$T > 0$

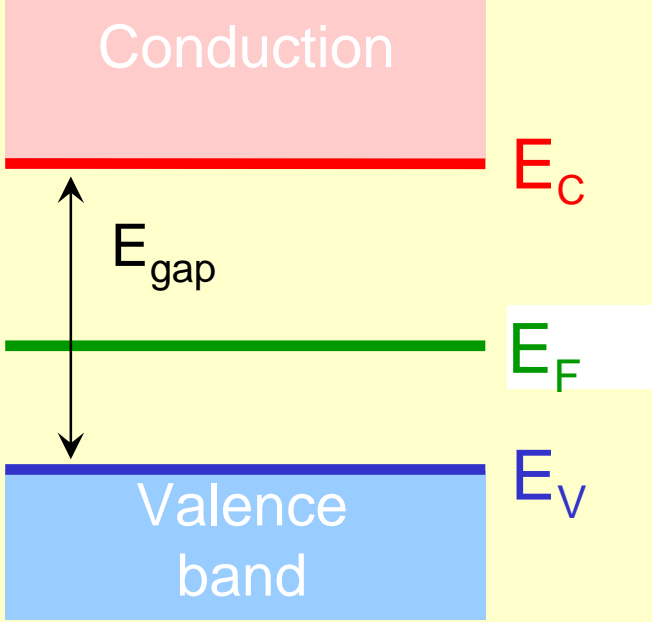
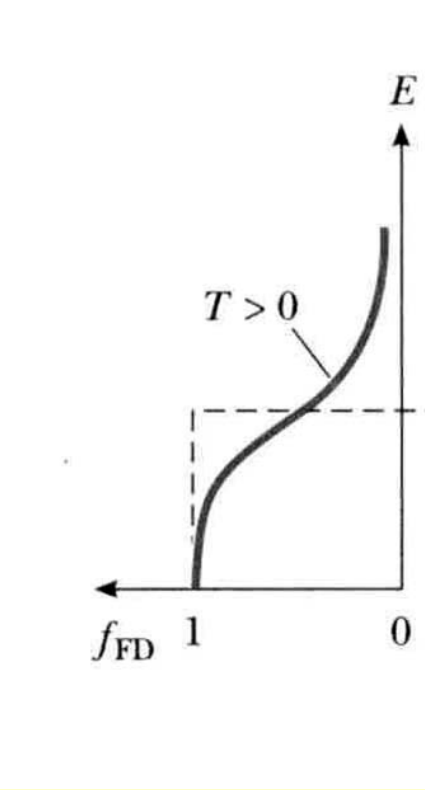

Intrinsic Semiconductors

$T > 0$

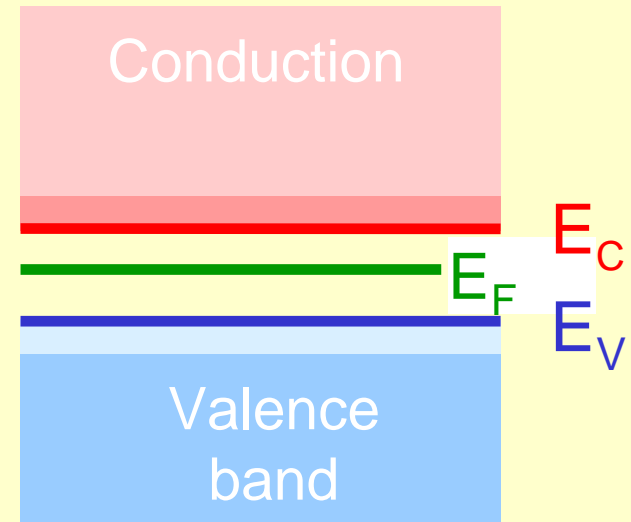
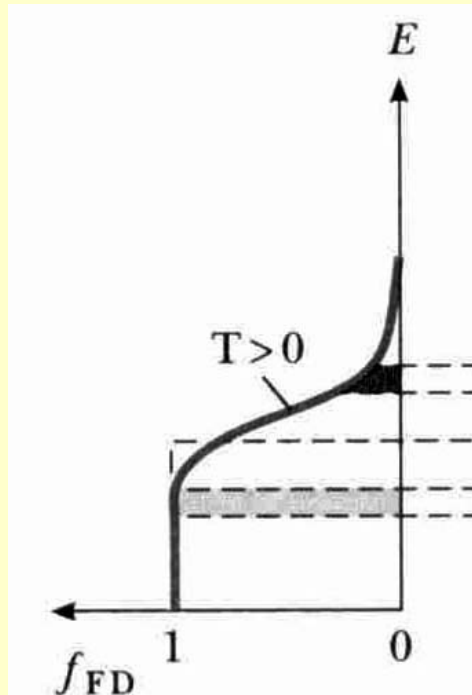

Extrinsic Semiconductors

Semiconductors: n- and p-Type

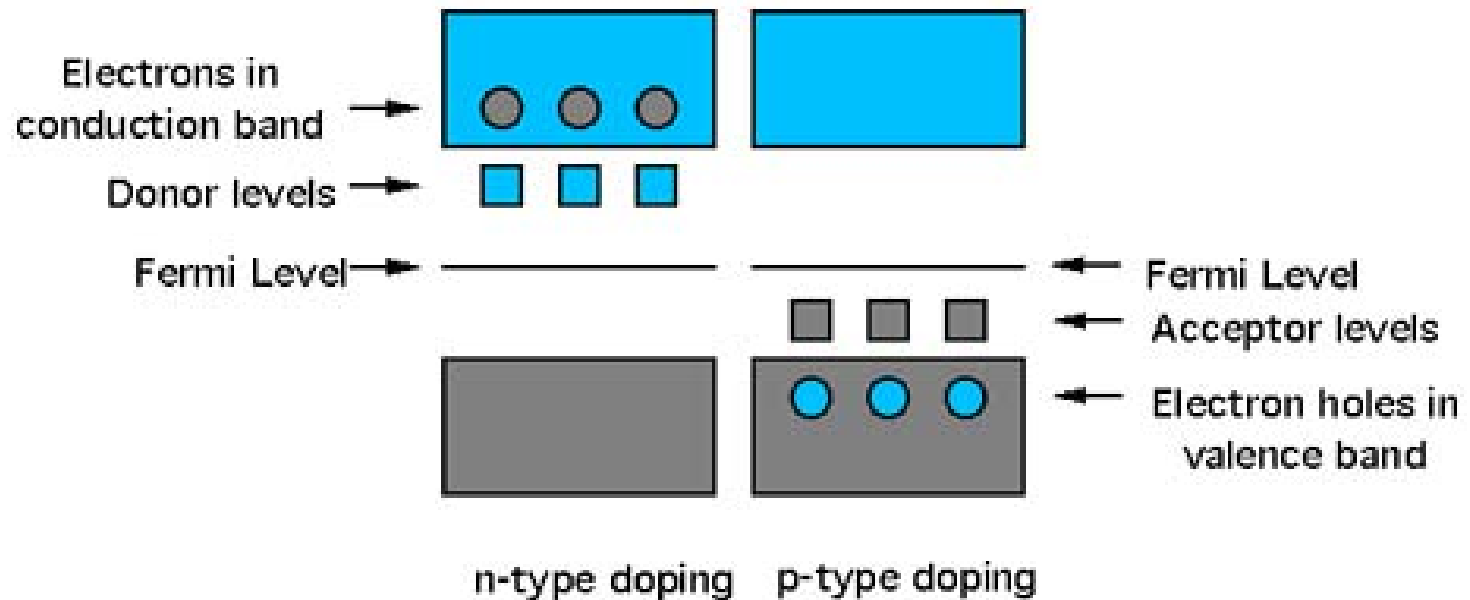

Extrinsic Semiconductors

Doping of semiconductors - introducing atoms with more or less electrons than the parent element.

Doping is substitutional, the dopant atoms directly replace the original atoms.

Very low levels of dopant are required, only 1 atom in 10^9 of the parent atoms.

Extrinsic Semiconductors n-type

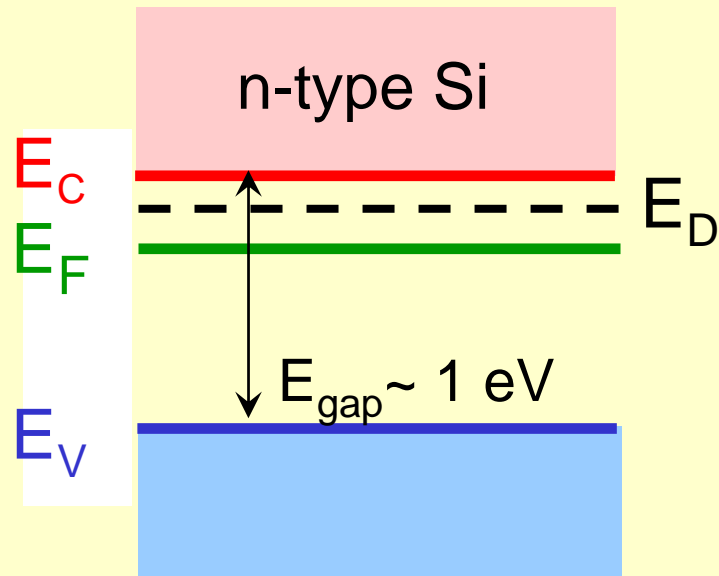

Extrinsic Semiconductors n-type

Silicon - phosphorous atoms introduce extra electrons (one extra valence electron for each dopant atom introduced as P)

The dopant atoms form a set of energy levels that lie in the band gap between the valence and conduction bands, but close to the conduction band.

The electrons in the dopant levels cannot move directly - there is not enough of them to form a continuous band.

The levels act as **donor levels** because the electrons have enough thermal energy to get up into the conduction band where they can move freely.

n-type semiconductors, the negative charge carriers or electrons.

Extrinsic Semiconductors p-type

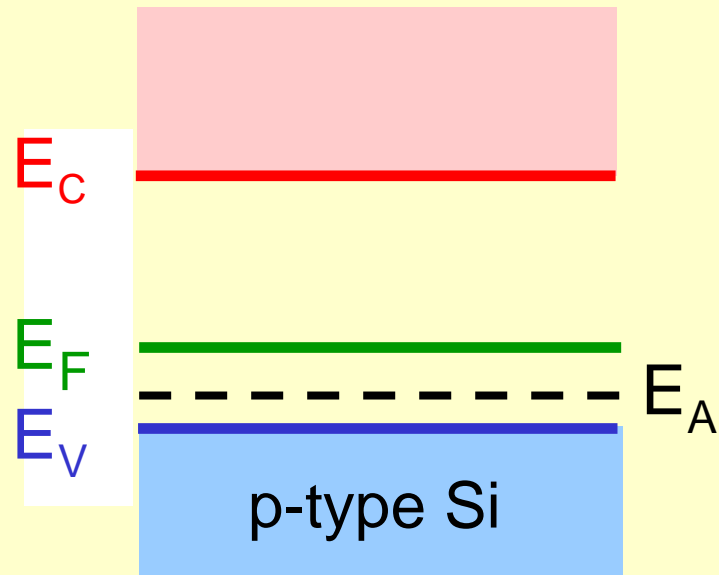

Extrinsic Semiconductors p-type

Doping with an element with one less valence electron such as Ga

For every dopant atom - an electron missing,

form a narrow, empty band consisting of **acceptor levels** which lie just above the valence band, discrete levels if the concentration of gallium atoms is small.

Electrons from the valence band have enough thermal energy to be promoted into the acceptor levels, electrons in the acceptor levels cannot contribute to the conductivity of the material.

The positive holes in the valence band left behind by the promoted electrons are able to move - **p-type semiconductors**, the positive holes.

Controlled Valency Semiconductors

Some transition metal compounds can be conductors due to the presence of an element in more than one oxidation state.

NiO

On oxidation - turns black and becomes a relatively good conductor

Some of the Ni^{2+} ions oxidized to Ni^{3+} and some Ni^{2+} ions diffuse out to maintain charge balance leaving cation holes.

The reason for the conduction is the ability of electrons to transfer from Ni^{2+} to Ni^{3+} ions. This basically allows the Ni^{3+} ions to move and black NiO is therefore a p-type semiconductor.

Hopping Semiconductor

the transfer process is thermally controlled and therefore highly dependent on temperature, makes controlling the conductivity difficult.

Controlled valency semiconductors rely on control of the concentration of Ni^{3+} ions by controlled addition of a dopant (such as lithium).

NiO

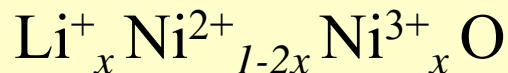

the concentration of Li^+ ions controls the conductivity

Delocalized Bands – Localized Bonds

Molecules: Mulliken overlap population

$$\Sigma 2 c_1 c_2 S_{12}$$

c_1, c_2 same sign = bonding

c_1, c_2 opposite sign = antibonding

S_{12} overlap integral

Solids: Overlap population-weighted density of states = crystal orbital overlap population (COOP) – for a specific bond

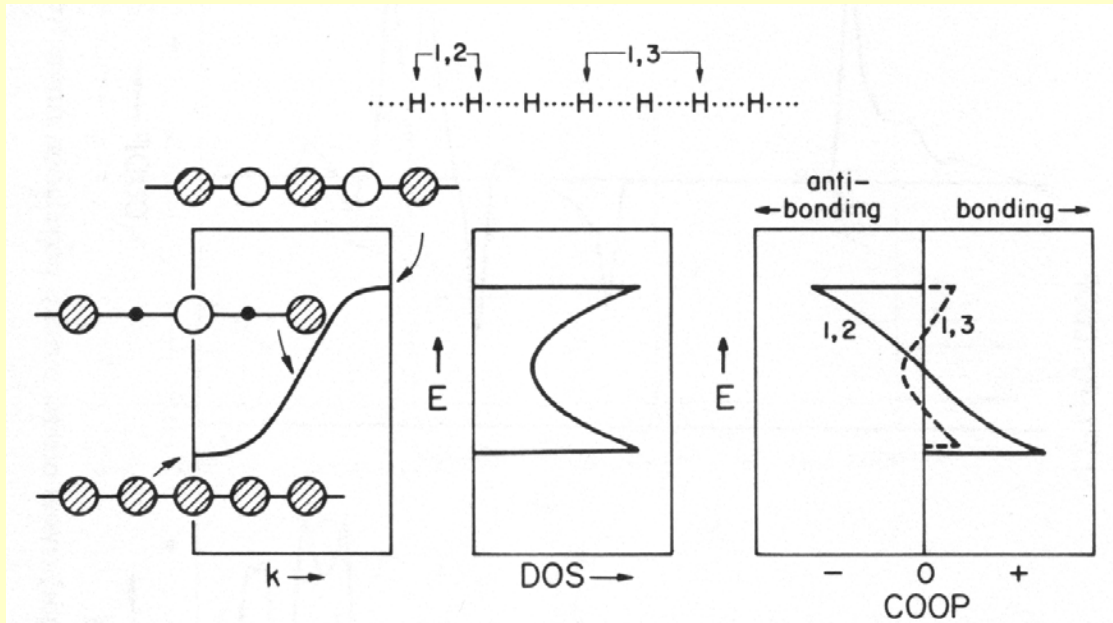

COOP curves

Sign – positive = bonding, negative = antibonding

Amplitude – depends on DOS, orbital overlap, MO coefficients

DOS and COOP for the Ti-O bonds in rutile

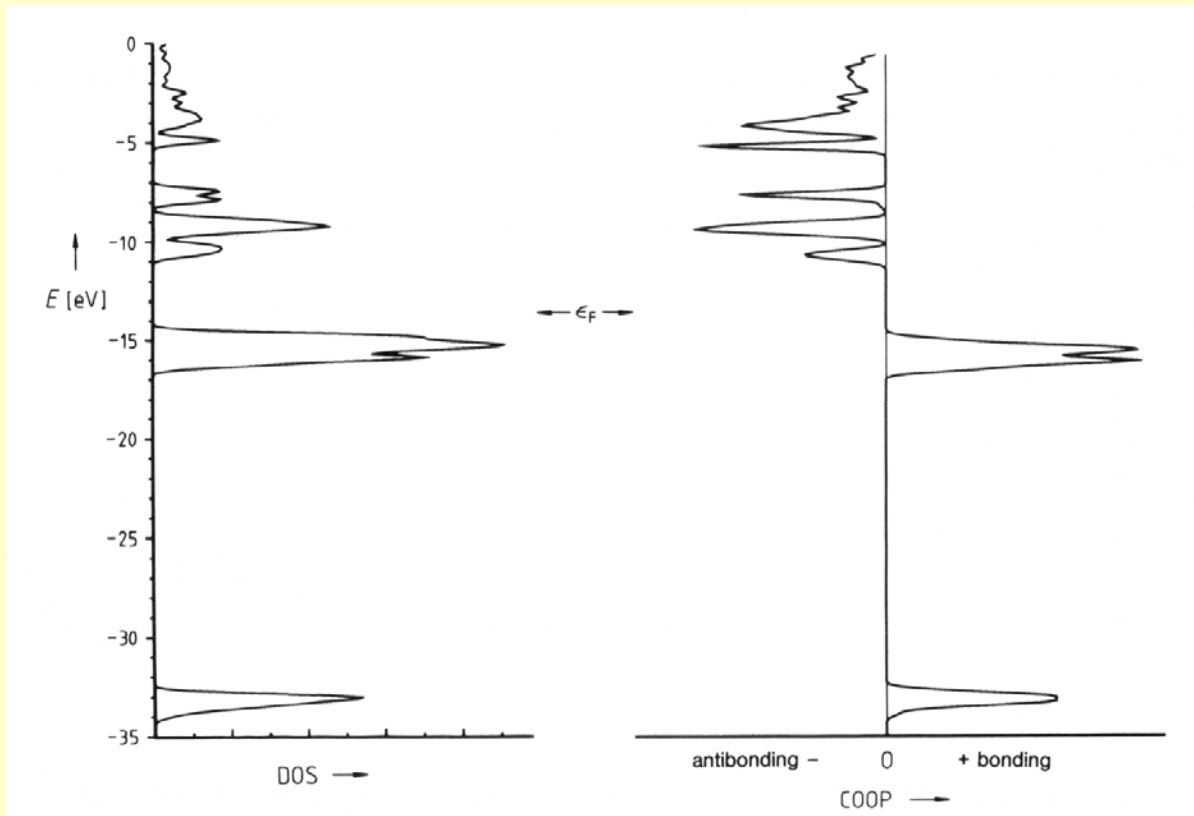

DOS and COOP for the Ni-Ni bonds in Ni metal

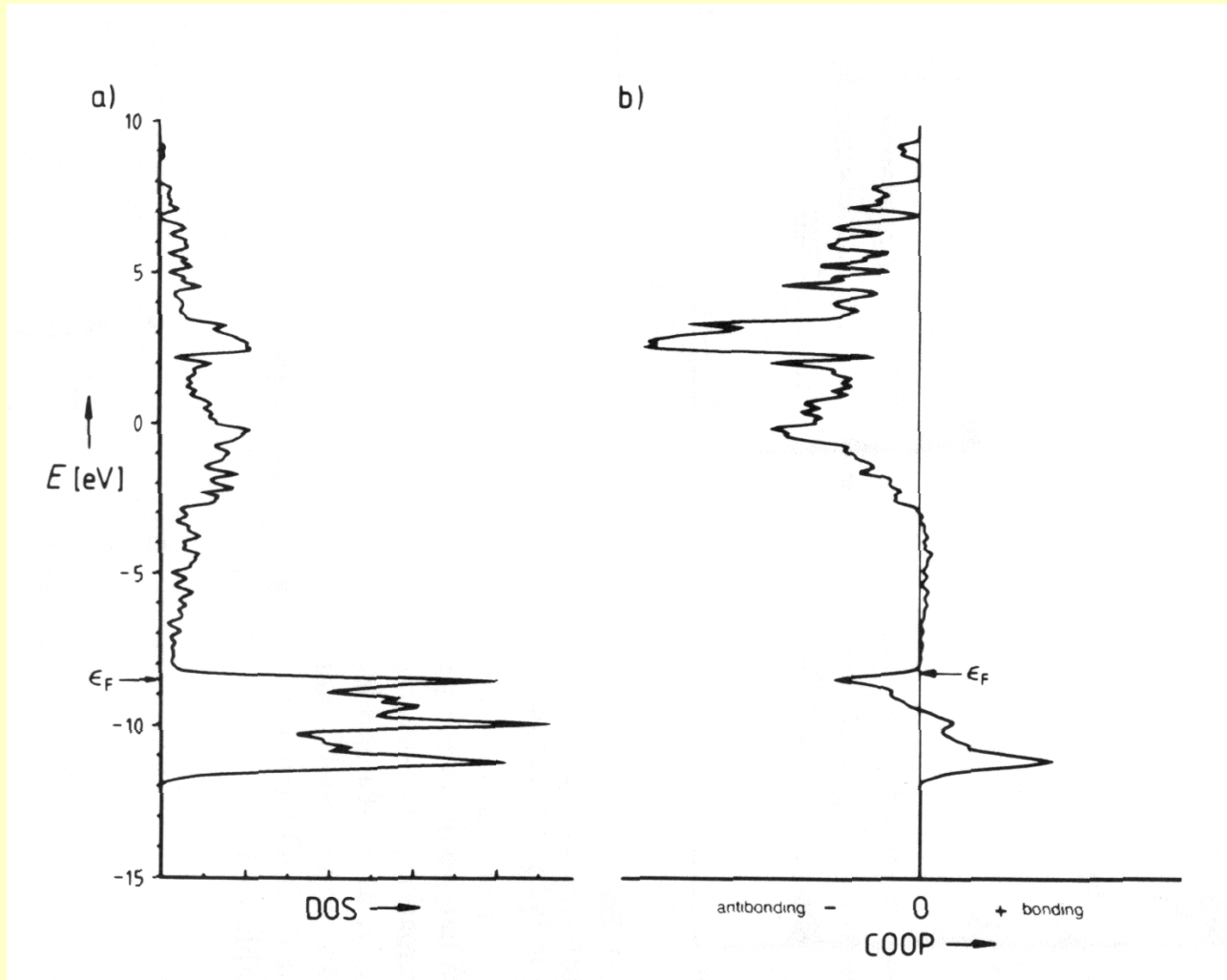

Peierls distortion

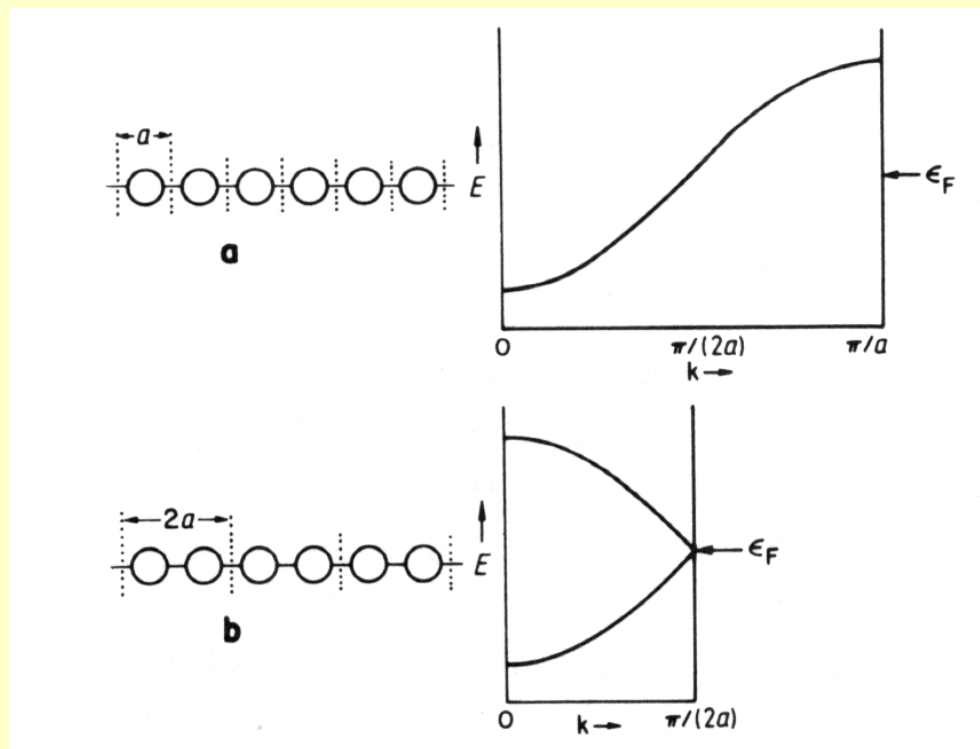

Peierls distortion – maximizing bonding, lowering the DOS at the Fermi level, bonding states down in energy, antibonding states up, a band gap opens at the Fermi level

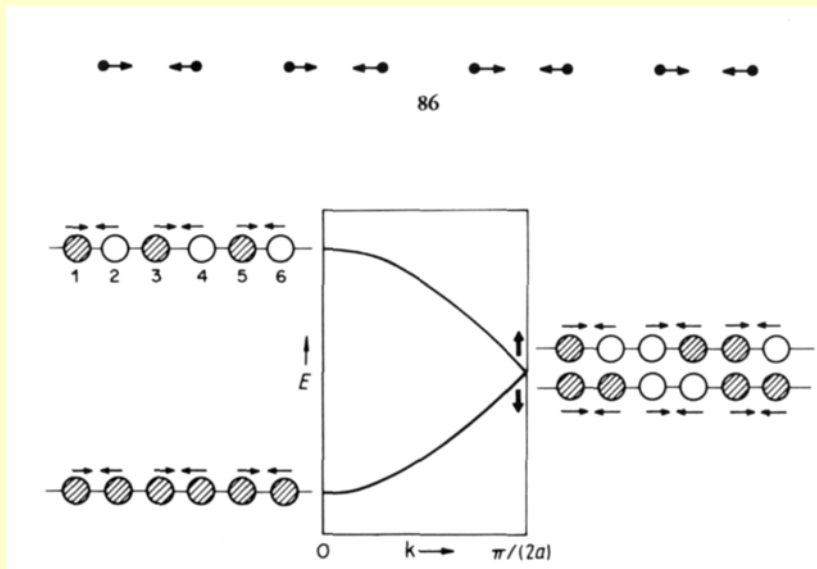

Destabilization

Stabilization

Peierls distortion

