

FUNDAMENTALS OF METAL ALLOYS, EQUILIBRIUM DIAGRAMS

Chapter 4

4.2 What is a Phase?

- **Phase** is a form of material having characteristic structure and properties.
- More precisely: form of material with **identifiable composition (chemistry)**, **definable structure**, and **distinctive boundaries (interfaces)** which separate it from other phases.

4.2 Phases

- Phase can be continuous (air in the room) or discontinuous (salt grains in the shaker).
- Gas, liquid or solid.
- Pure substance or solution (uniform structure throughout).



4.3 Equilibrium Phase Diagrams

- Graphic mapping of the natural tendencies of a material or a material system (equilibrium for all possible conditions).
- Primary variables: temperature, pressure and composition.
- P-T diagram (the simplest).

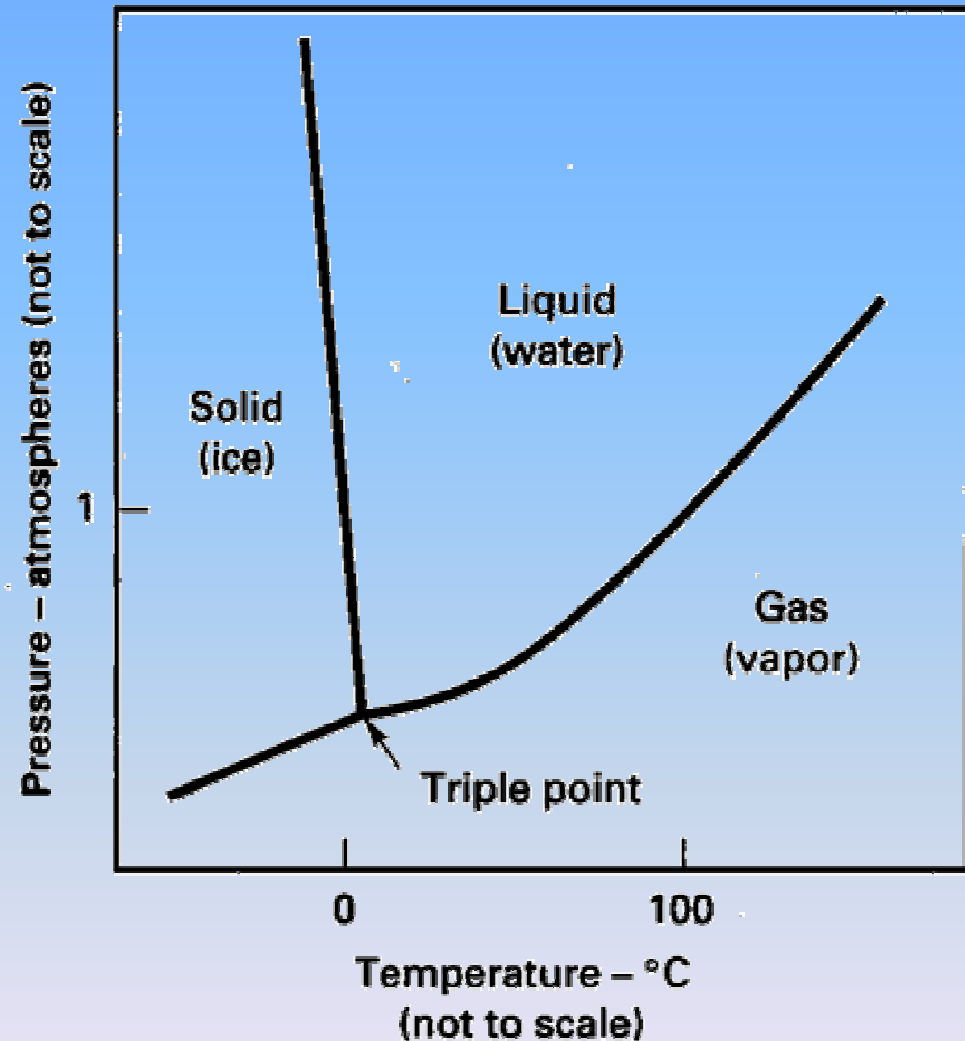

4.3 Temperature-Composition Diagrams

- Engineering processes conducted at atmospheric pressure (P/T variations).
- The most common: temperature-composition phase diagrams.

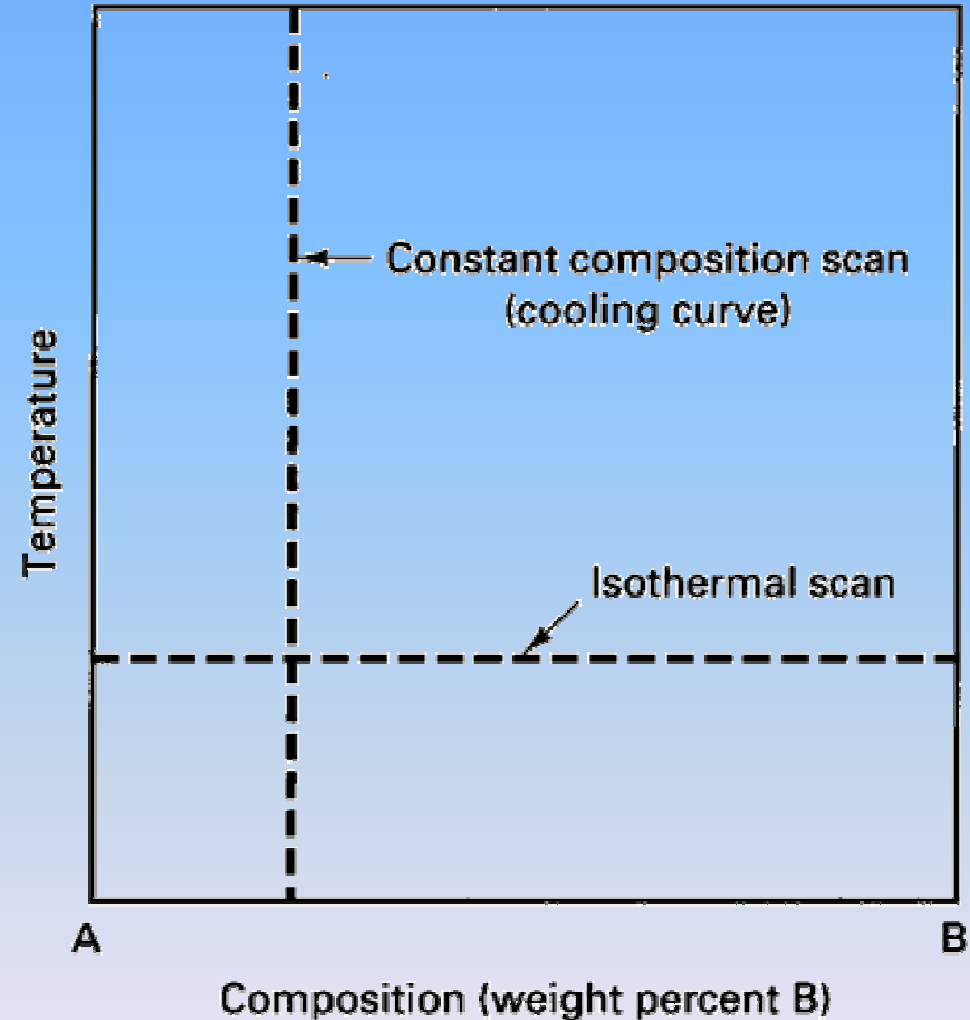

4.3 Cooling Curves

- Cooling curves for NaCl-H₂O combinations:

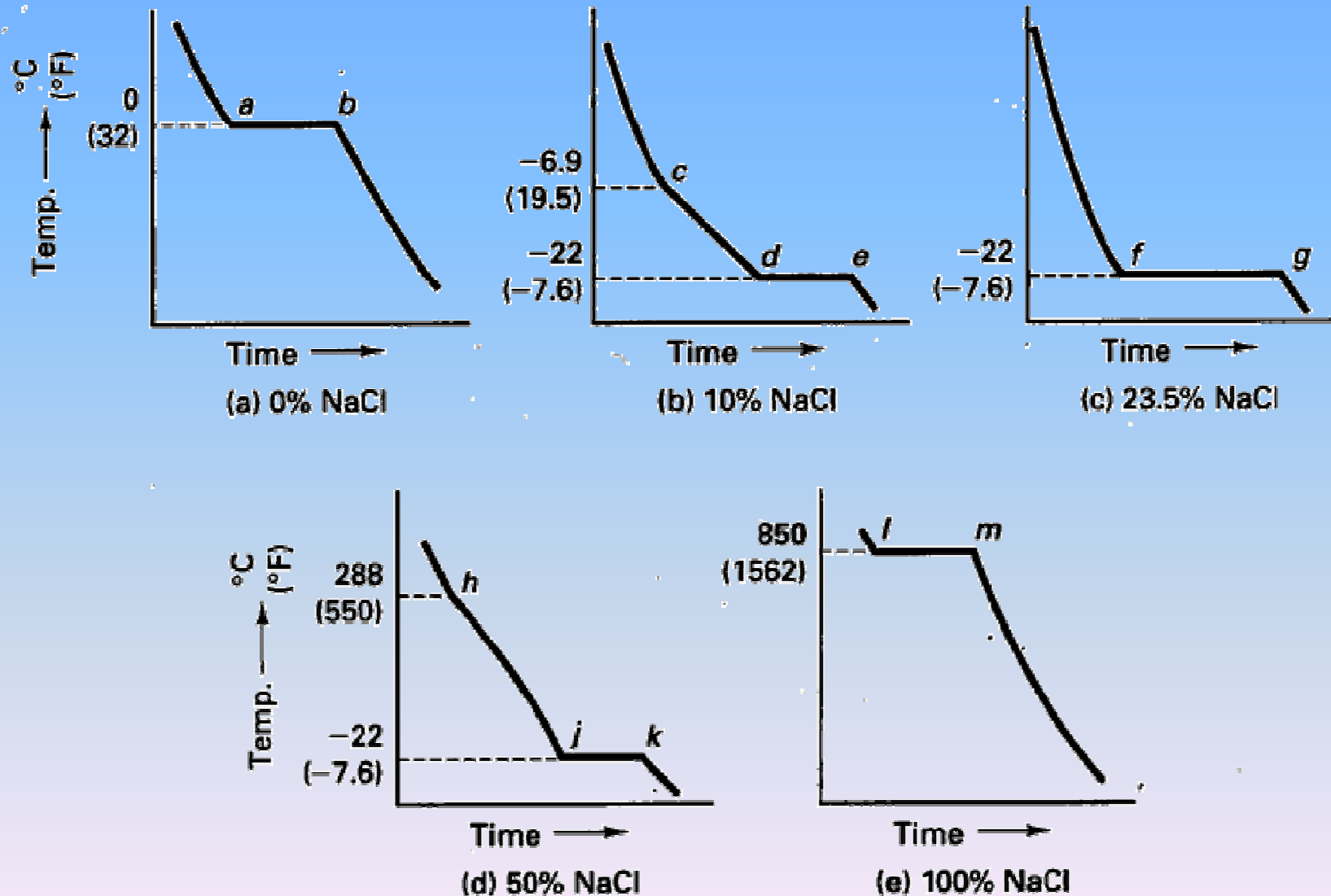

4.3 Cooling Curves

- Partial equilibrium diagram of NaCl-H₂O system

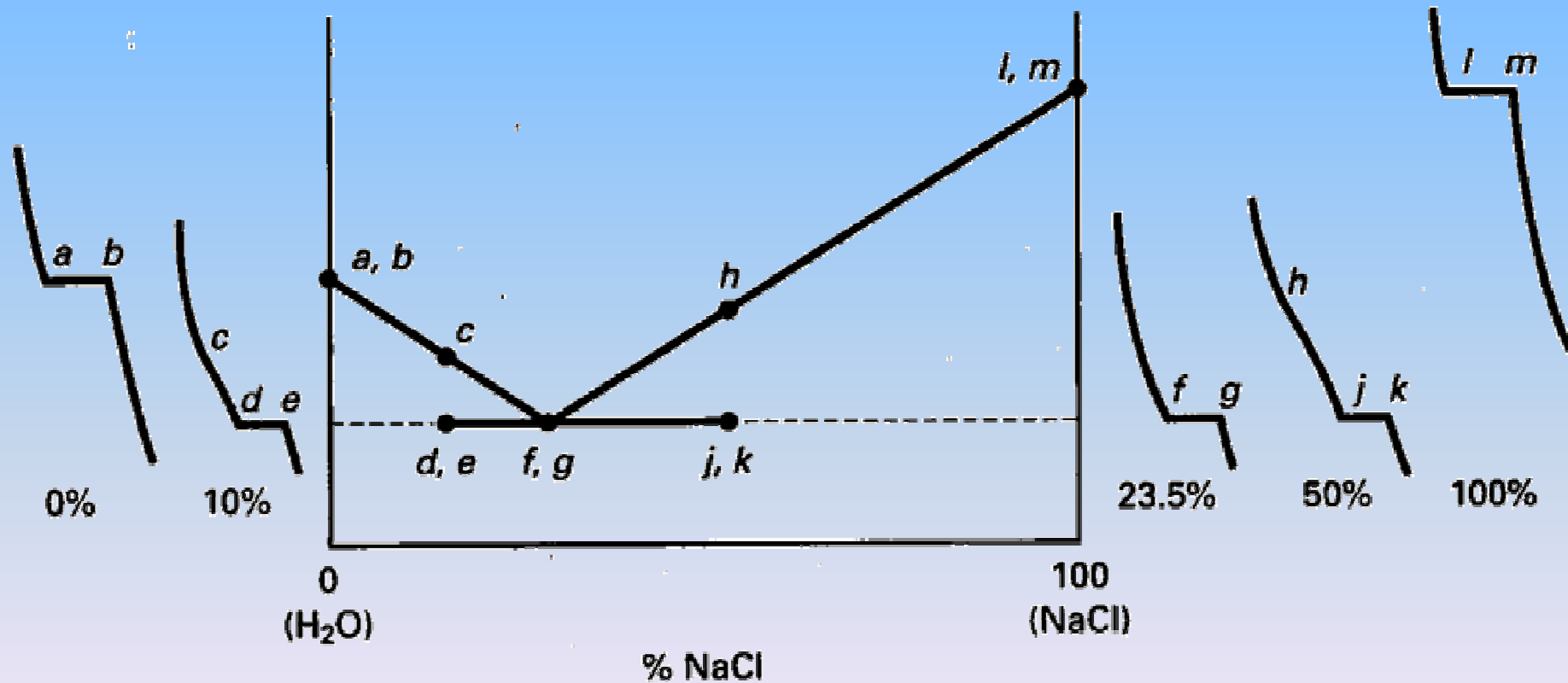

4.3 Solubility

- Solubility limits.
- Degree of solubility determines properties.
- I- Two metals completely soluble in each other.
- II- Two metals soluble in liquid state and insoluble in solid state.
- III- Two metals soluble in liquid state and partially soluble in solid state.

4.3 Complete Solubility

- Copper-Nickel equilibrium diagram

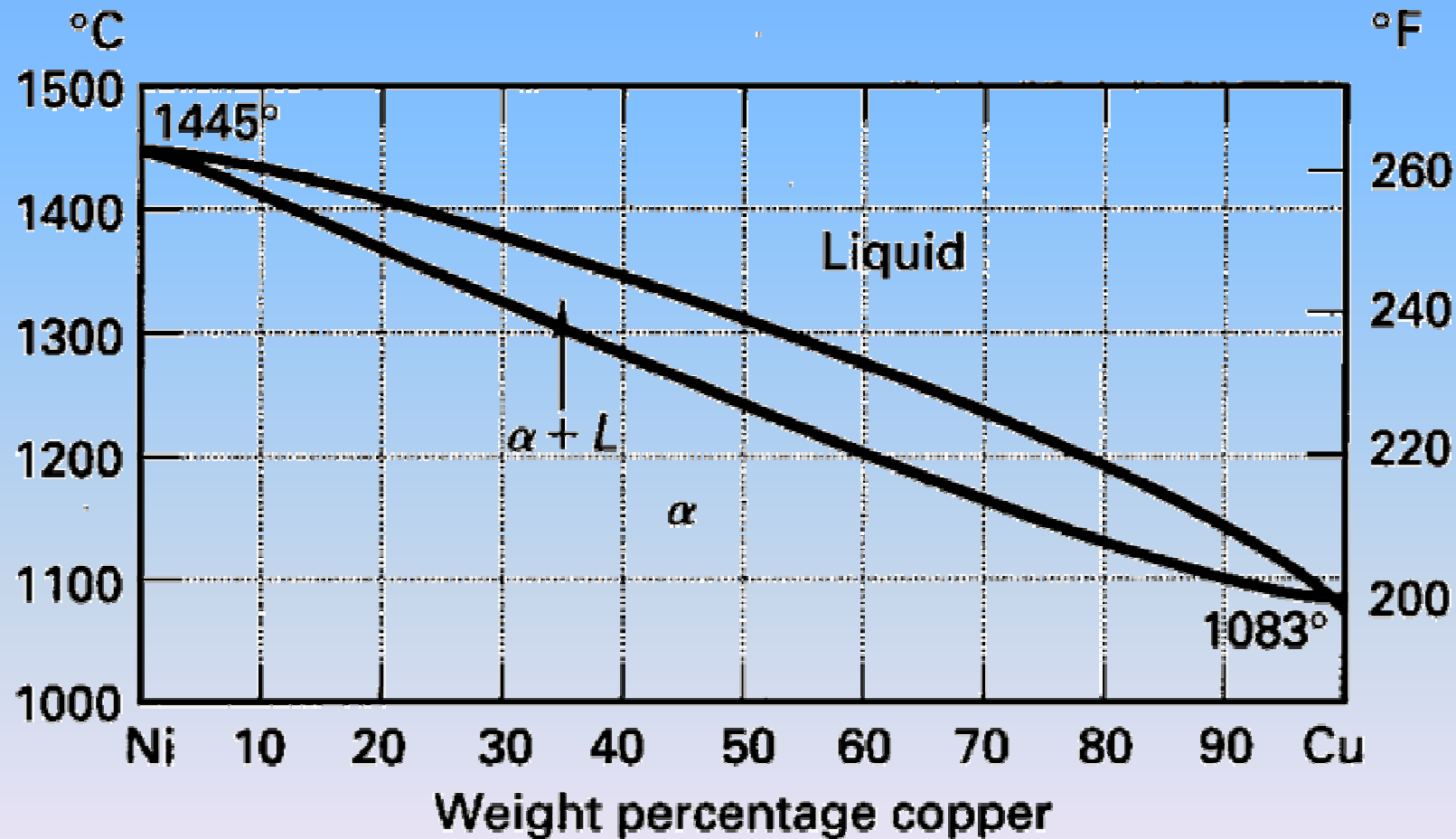

4.3 Partial Solid Solubility

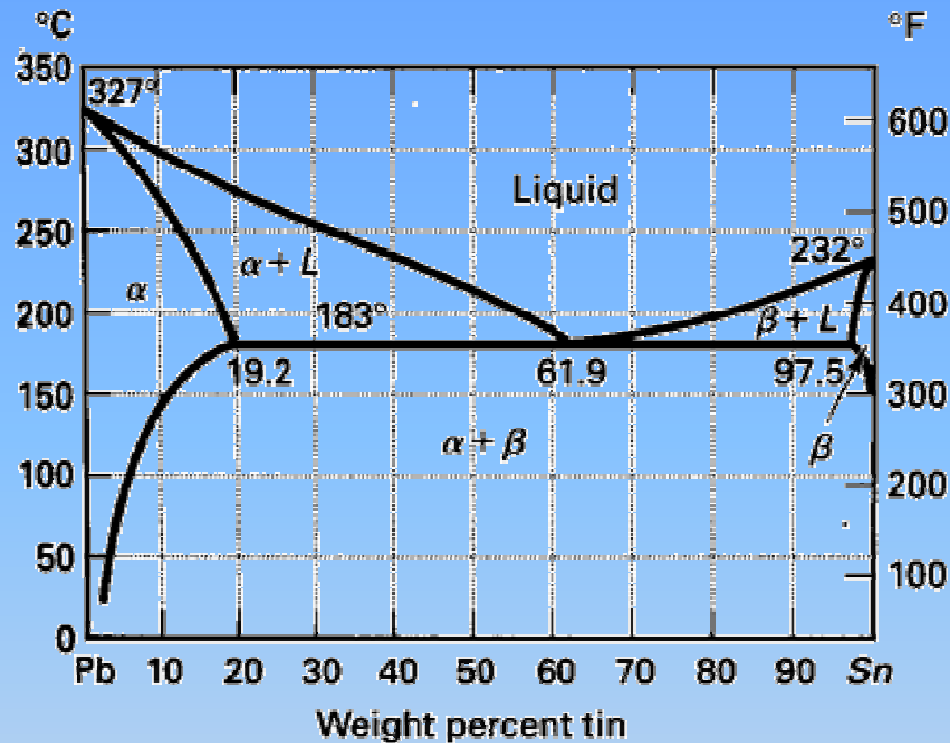

- Degree of solubility depends on temperature
- At max. solubility, 183°C: lead holds up to 19.2 wt% tin in a single phase solution, and tin holds up to 2.5wt% lead and still be a single phase.

4.3 Utilization of Diagrams

$$\text{Liquid phase amount} = \frac{a - S_2}{L_2 - S_2} \times 100\% = \% \text{ by mas}$$

$$\text{Solid phase amount} = \frac{L_2 - a}{L_2 - S_2} \times 100\% = \% \text{ by mass}$$

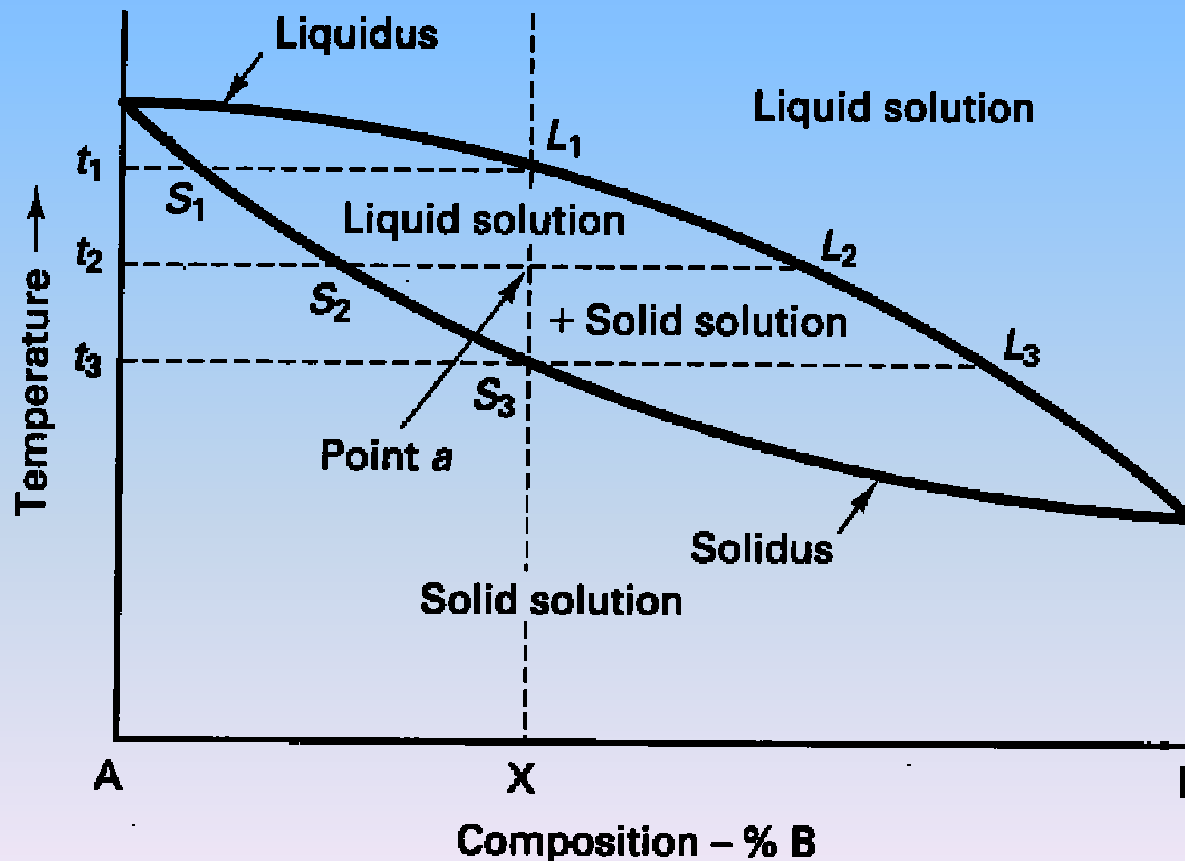

4.3 Example problem

Given data :

$X = 36\%$ of B

$a = 36\%$ of B

$L_2 = 72\%$ of B

$S_2 = 18\%$ of B

Compute liquid phase and solid phase
% amounts by mass.

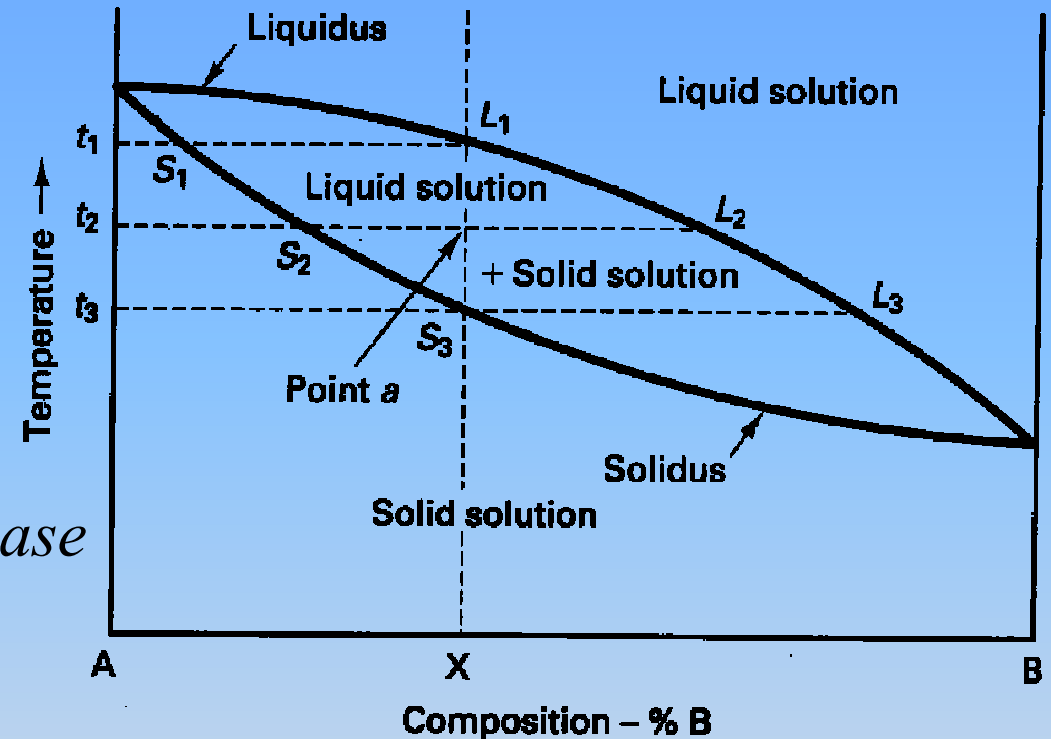

$$\text{Liquid phase amount} = \frac{36 - 18}{72 - 18} \times 100\% = 33.33\% \text{ by mass}$$

$$\text{Solid phase amount} = \frac{72 - 36}{72 - 18} \times 100\% = 66.67\% \text{ by mass}$$

4.3 Utilization of Diagrams

- The phases present.
- Composition of each phase (single phase region or two phase region).
- In two phase region a **tie-line** should be constructed.
- The amount of each phase present: **lever-law** calculation using a tie-line.

4.3 Three Phase Reactions

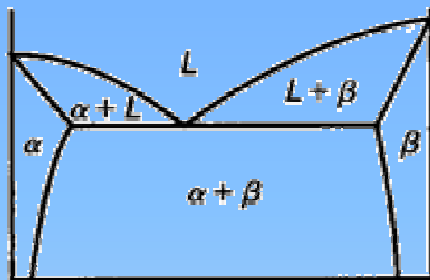

Eutectic
($L \rightarrow S_1 + S_2$)

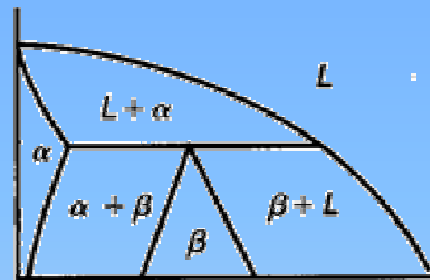

Peritectic
($L + S_1 \rightarrow S_2$)

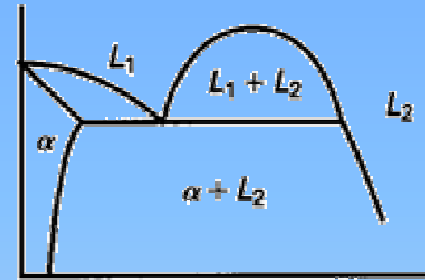

Monotectic
($L_1 \rightarrow S_1 + L_2$)

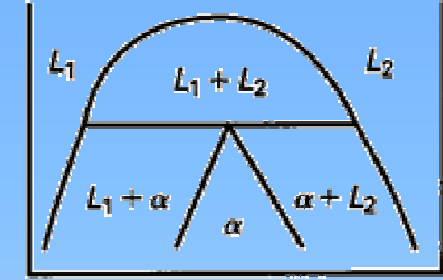

Syntectic
($L_1 + L_2 \rightarrow S_1$)

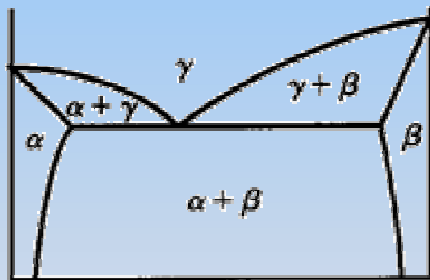

Eutectoid
($S_1 \rightarrow S_2 + S_3$)

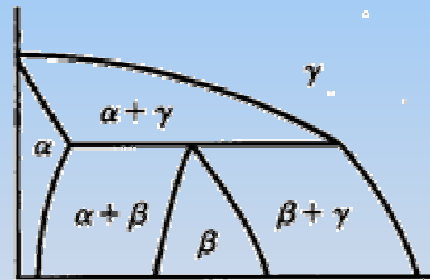

Peritectoid
($S_1 + S_2 \rightarrow S_3$)

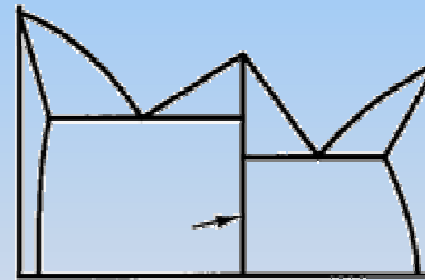

Stoichiometric
intermetallic compound

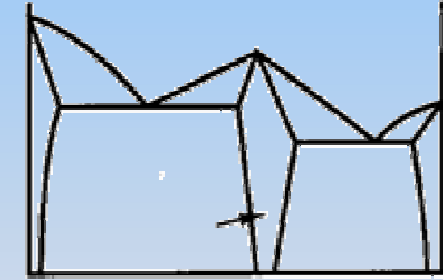

Non-stoichiometric
intermetallic compound

4.4 Iron-Carbon Equilibrium Diagram

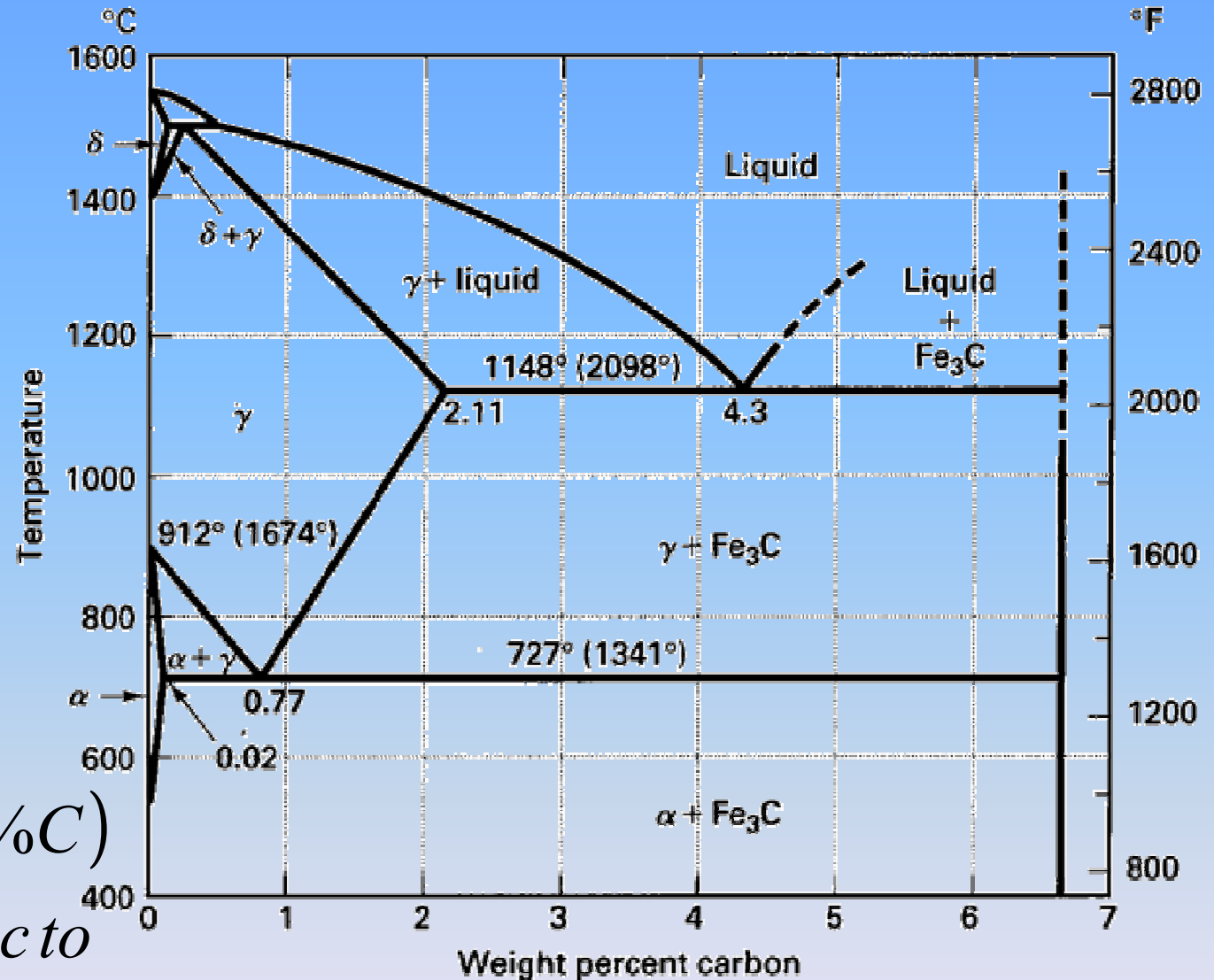

α , ferrite (BCC)

γ , austenite (FCC)

δ , δ - ferrite (BCC)

Fe_3C , cementite (6.67%C)

Curie po. nonmagnetic to
magnetic transition

4.4 Iron-Carbon Equilibrium Diagram

- δ – *ferrite*, (present only at extreme temperatures)
- **Austenite**, (FCC, high formability, high solubility of C, over 2% C can be dissolved in it, most of heat treatments begin with this single phase).
- **Ferrite**, BCC, stable form of iron below 912 deg.C, only up to 0.02 wt% C in solid solution and leads to two phase mixture in most of steels.
- **Cementite** (iron-carbide), stoichiometric intermetallic compound, hard, brittle, exact melting point unknown.
- **Currie point** (770 deg. C), atomic level nonmagnetic-to-magnetic transition.

4.4 Three Phase Reactions

- **Peritectic**, at 1495 deg.C, with low wt% C alloys (almost no engineering importance).
- **Eutectic**, at 1148 deg.C, with 4.3wt% C, happens to all alloys of more than 2.11wt% C and they are called **cast irons**.
- Eutectoid, at 727 deg.C with eutectoid composition of 0.77wt% C, alloys below 2.11%C miss the eutectic reaction to create two-phase mixture. They are **steels**.

4.5 Steels

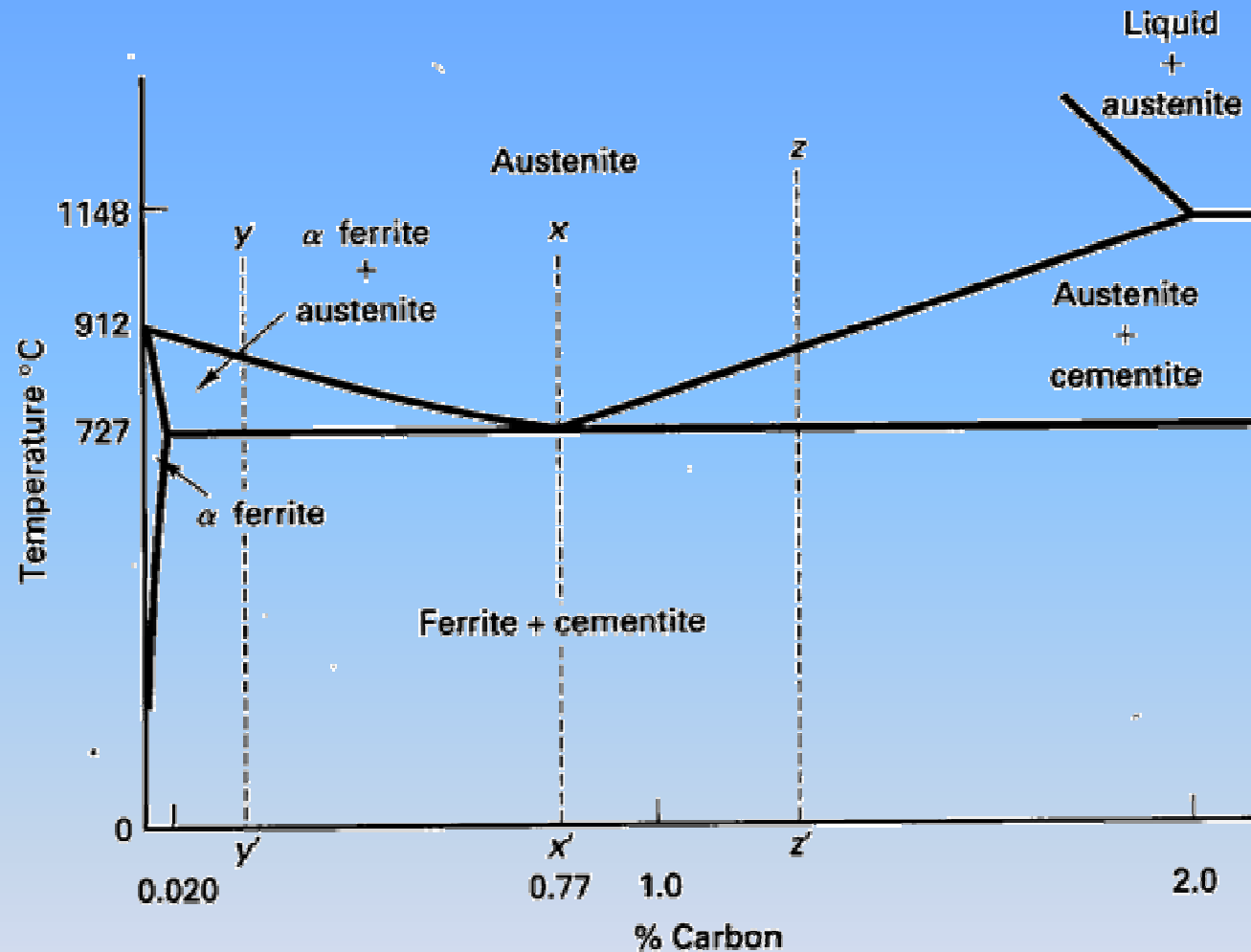

4.5 Eutectoid Steel

- At 0.77% C by cooling from austenite (FCC) changes to BCC-ferrite (max 0.02% C) and excess C forms intermetallic cementite.
- Chemical crystalline solid separation gives fine mixture of ferrite and cementite. Pearlite (right), 1000X.

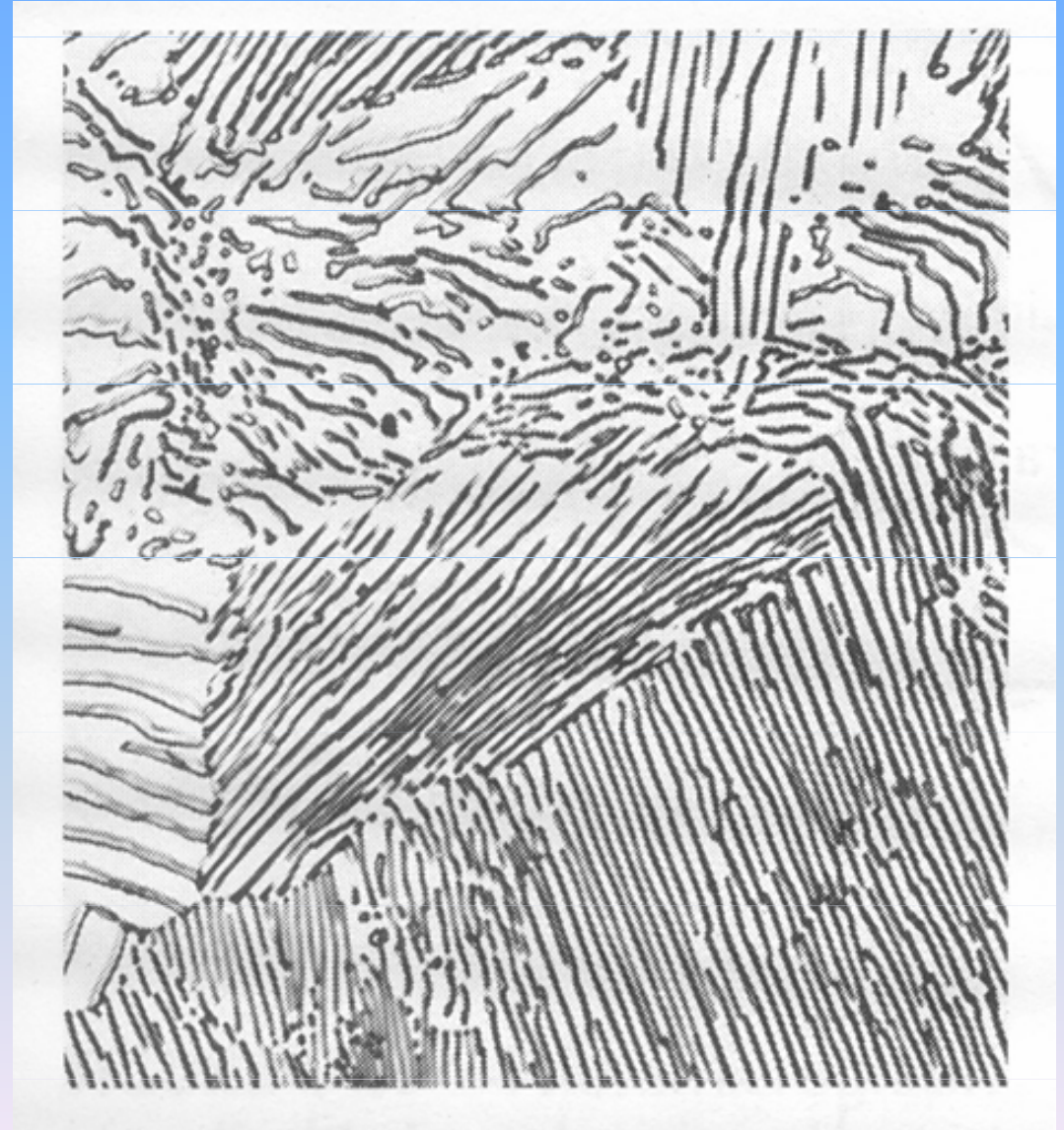

4.5 Hypoeutectoid Steel

- With less than 0.77%C from austenite by cooling transformation leads to growth of low-C ferrite growth. At 727deg.C austenite transforms in to pearlite.
- Mixture of **proeutectoid ferrite** (white) and regions of **pearlite** forms.
- Magnification 500X.

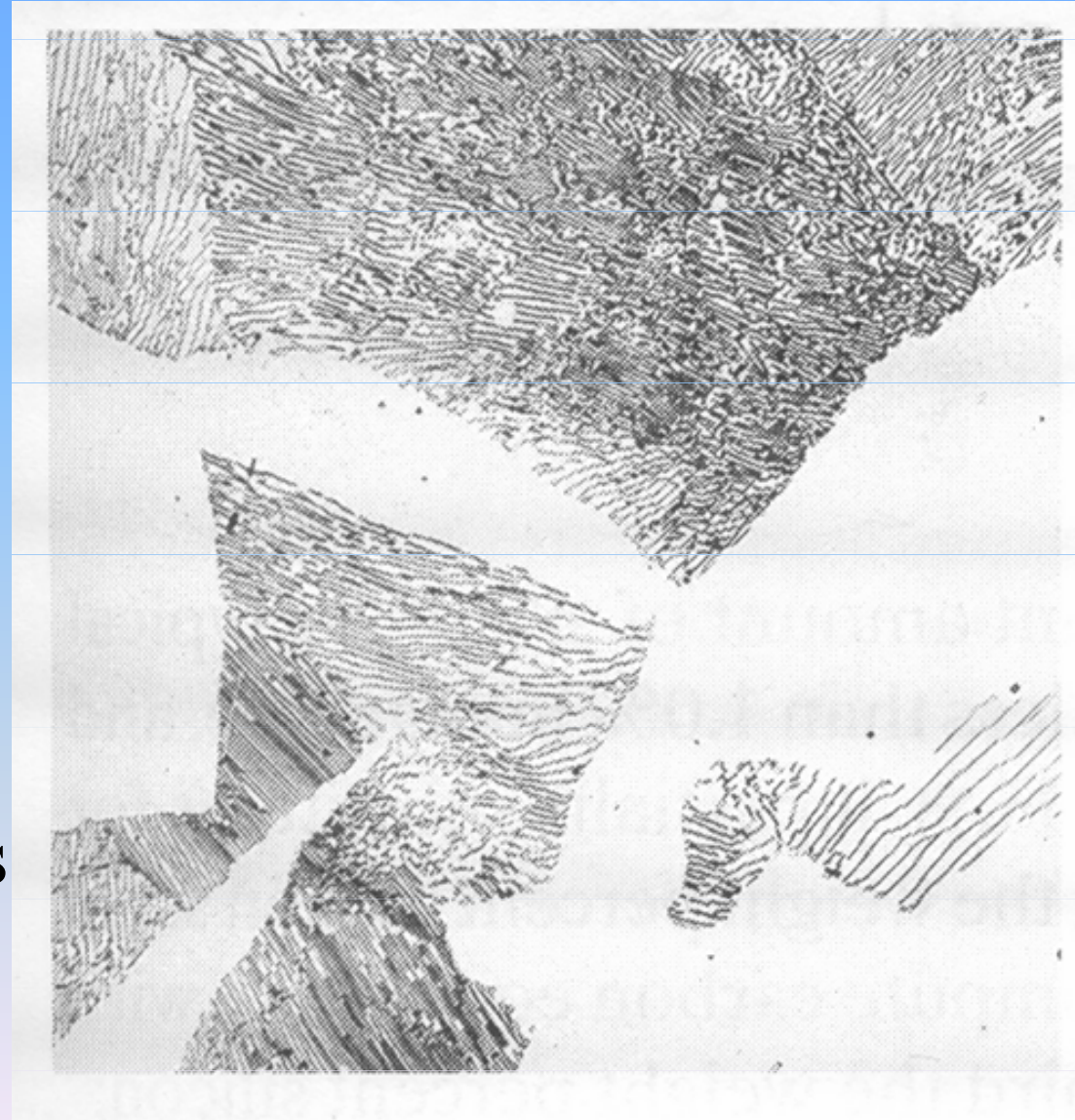

4.5 Hypereutectoid Steel

- With more than 0.77%C, from austenite transformation leads to proeutectoid primary cementite and secondary ferrite. At 727 deg.C austenite changes to pearlite
- Structure of primary **cementite** and **pearlite** forms.
- Magnification 500X.

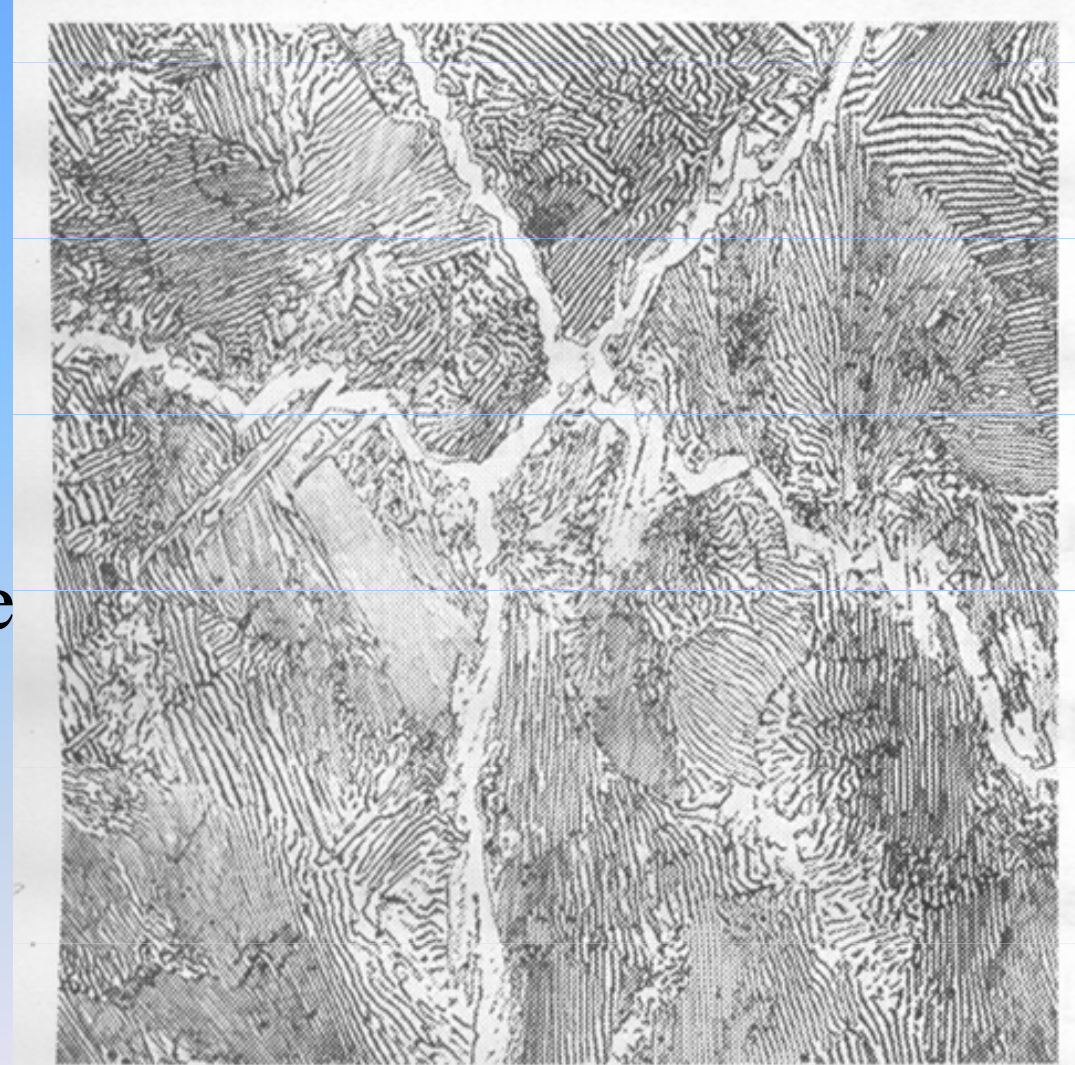

4.6 Cast Irons

- Iron-Carbon alloys of 2.11% C or more are cast irons.
- Typical composition: 2.0-4.0% C, 0.5-3.0% Si, less than 1.0% Mn and less than 0.2% S.
- Si-substitutes partially for C and promotes formation of graphite as the carbon rich component instead Fe₃C.

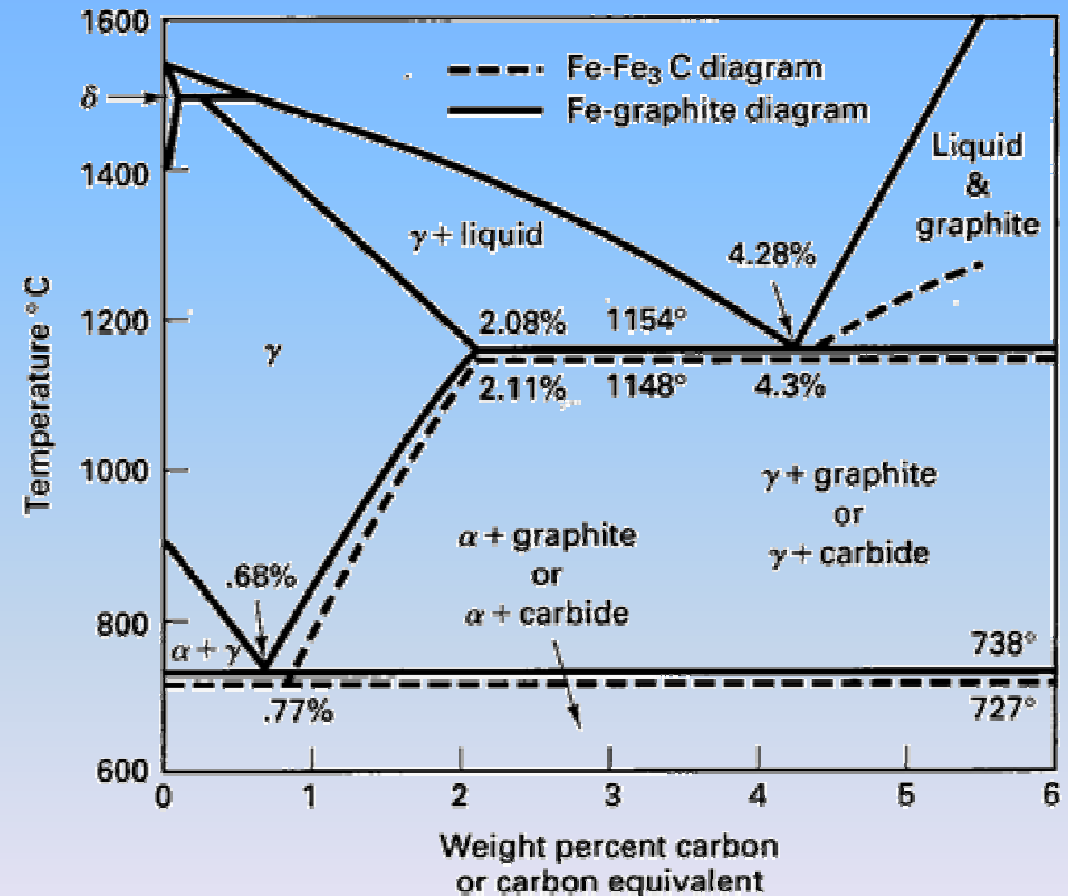

4.6 Gray Cast Iron

- Composes of: 2.5-4.0%C, 1.0-3.0%Si and 0.4-1.0% Mn.
- Microstructure: 3-D graphite flakes formed during eutectic reaction. They have pointed edges to act as voids and crack initiation sites.
- Sold by class (class 20 has min. tensile strength of 20,000 psi is a high C-equivalent metal in ferrite matrix). Class 40 would have pearlite matrix.

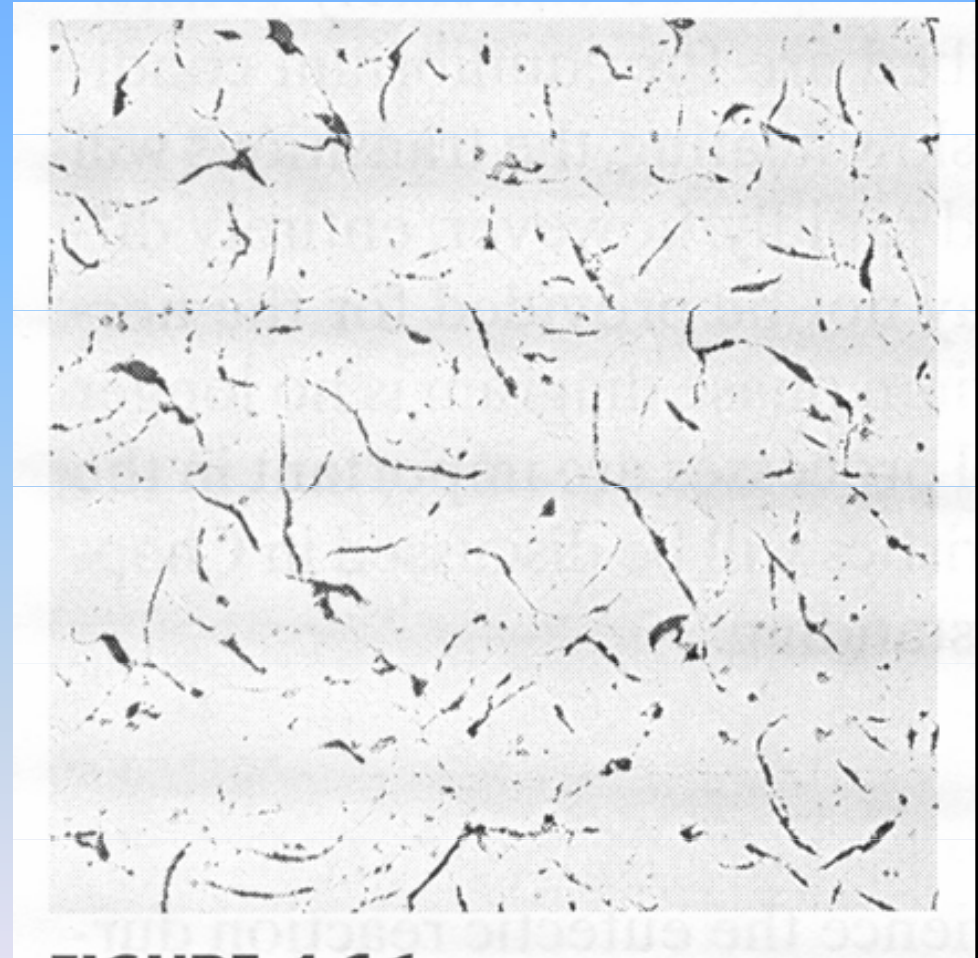

4.6 Gray Cast Iron

- Properties: excellent compressive strength, excellent machinability, good resistance to adhesive wear (self lubrication due to graphite flakes), outstanding damping capacity (graphite flakes absorb transmitted energy), good corrosion resistance and it has good fluidity needed for casting operations.
- It is widely used, especially for large equipment parts subjected to compressive loads and vibrations.

4.6 White Cast Iron

- Composes of: 1.8-3.6%C, 0.5-1.9%Si and 0.25-0.8%Mn.
- All of its carbon is in the form of iron-carbide (Fe_3C). It is called white because of distinctive white fracture surface.
- It is very hard and brittle (a lot of Fe_3C).
- It is used where a high wear resistance is dominant requirement (coupled hard martensite matrix and iron-carbide). Thin coatings over steel (mill rolls).

4.6 Malleable Cast Iron

- Formed by extensive heat treatment around 900 degC, Fe₃C will dissociate and form irregular shaped graphite nodules. Rapid cooling restricts production amount to up to 5 kg. Less voids and notches.
- Ferritic MCI: 10% EL, 35 ksi yield strength, 50 ksi tensile strength. Excellent impact strength, good corrosion resistance and good machinability.

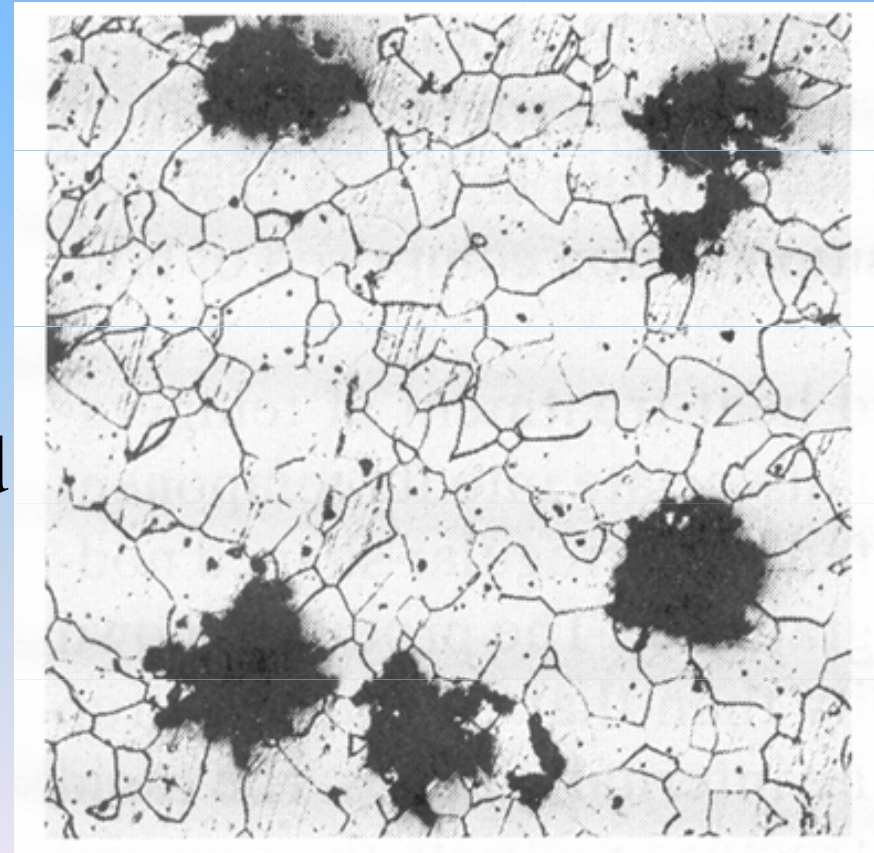

4.6 Pearlitic Malleable Cast Iron

- Pearlitic MCI: by rapid cooling through eutectic transformation of austenite to pearlite or martensite matrix.
- Composition: 1-4% EL, 45-85 ksi yield strength, 65-105 ksi tensile strength. Not as machinable as ferritic malleable cast iron.

Ductile Cast Iron

- Without a heat treatment by addition of ferrosilicon (MgFeSi) formation of smooth spheres (nodules) of graphite is promoted.
- Properties: 2-18% EL, 40-90 ksi yield strength, 60-120 ksi tensile strength.
- Attractive engineering material due to: good ductility, high strength, toughness, wear resistance, machinability and low melting point castability.

4.6 Malleable Cast Iron

- Ductile iron with ferrite matrix (top) and pearlite matrix (bottom) at 500X.
- Spheroidal shape of the graphite nodule is achieved in each case.

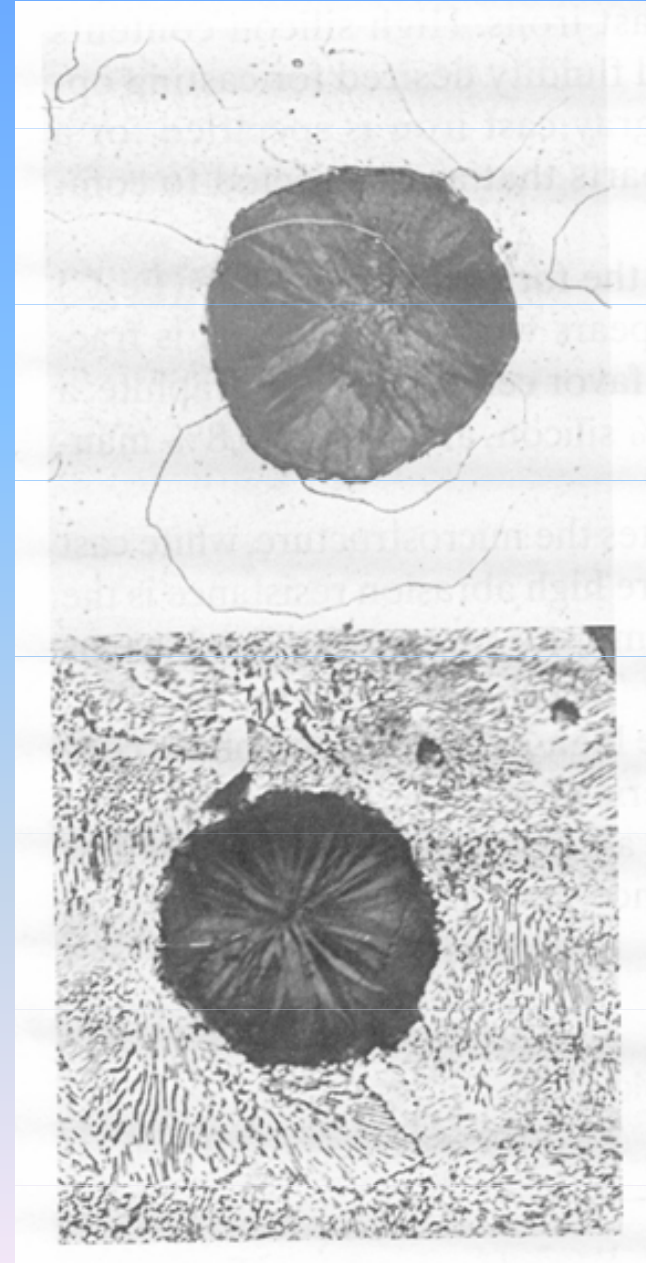

Microstructure

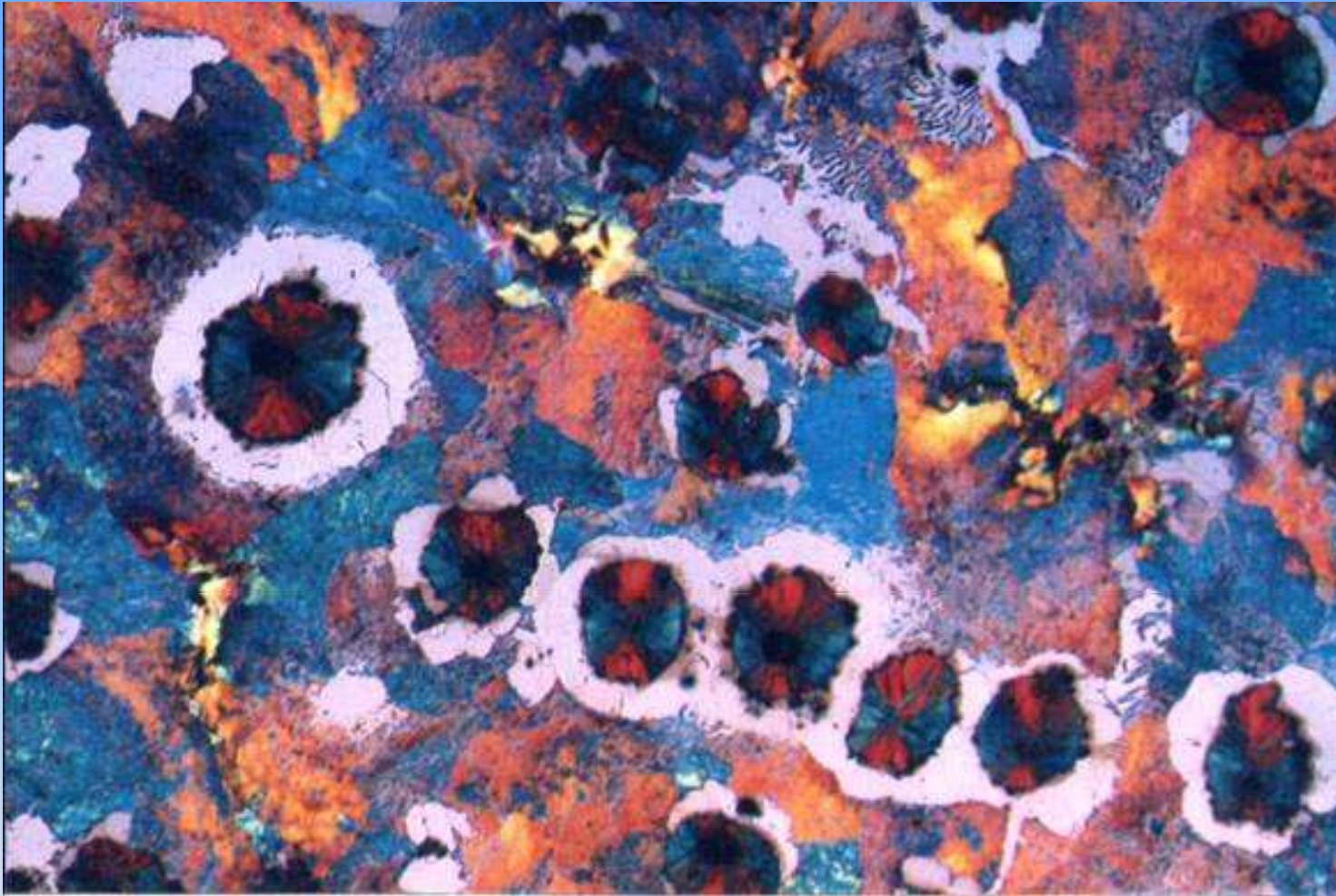

- Globular cast iron

BCC Unit Cell

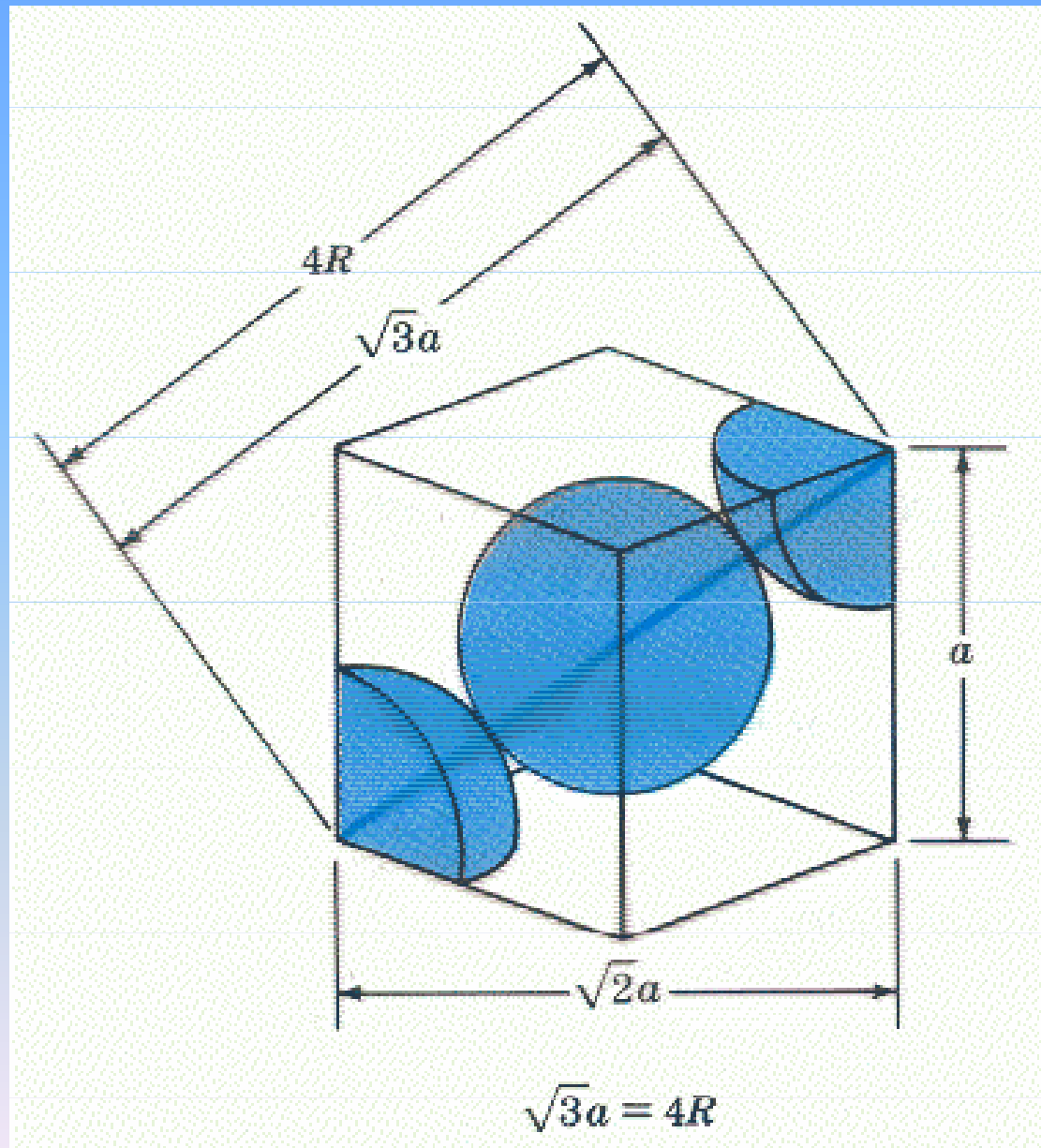

FCC Unit Cell

