

# Chromosome

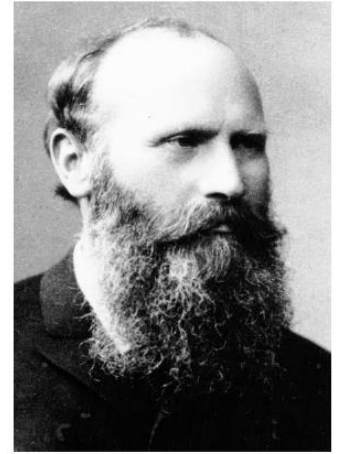

Wilhelm Gottfried Waldeyer  
(1836 – 1921)

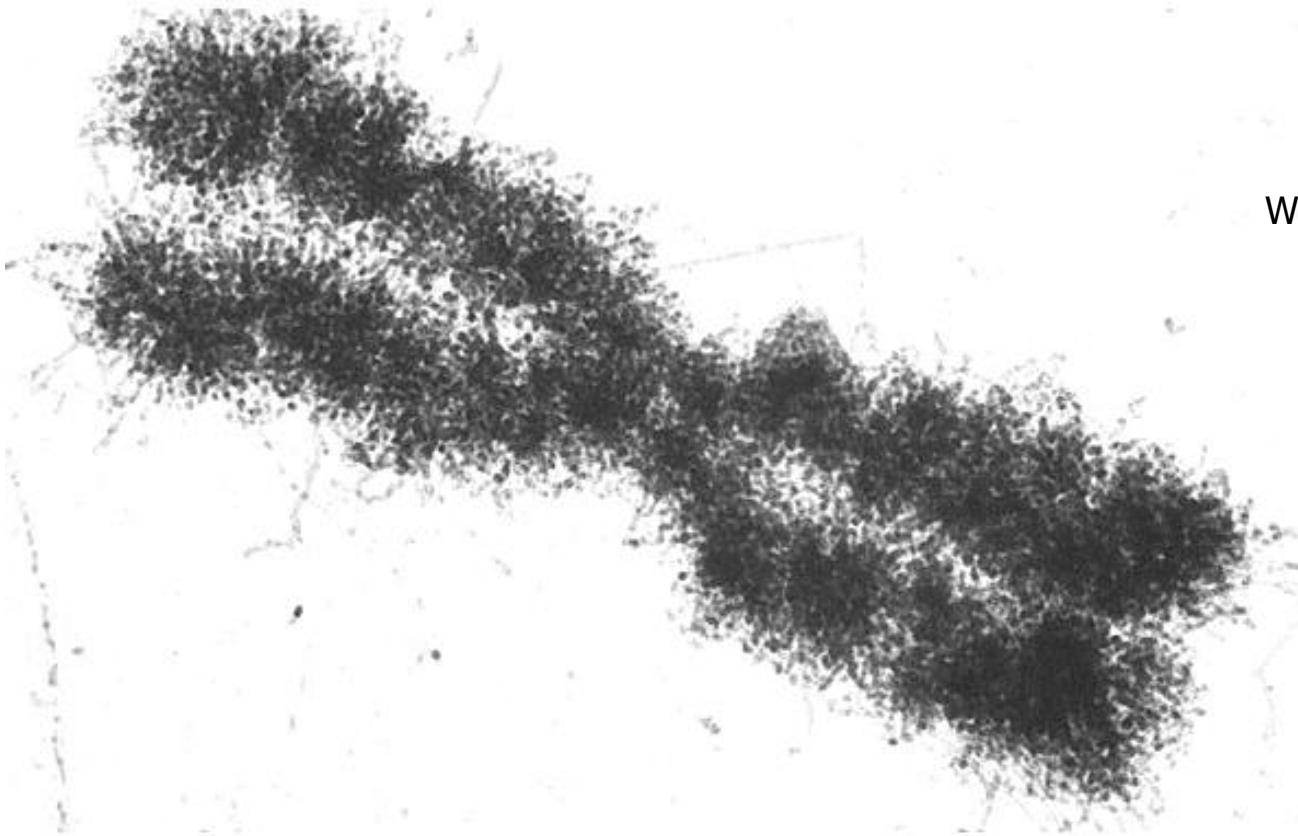

# Eukaryotic chromosomes

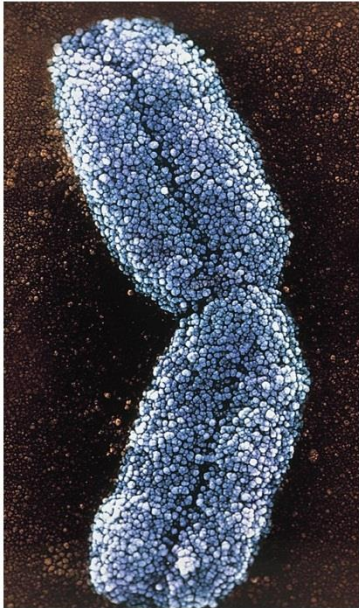

- Usually linear
- Variable in number
- DNA interacts with proteins to form **chromatin**
- Centromeres ensure segregation
- Telomeres cap ends
- Must be compacted to fit in nucleus

**chromatin**

(DNA & proteins)

- highly coiled DNA
- histones
- non-histone chromosomal proteins (DNA & RNA polymerase, transcription factors, topoisomerases, histone modifying proteins)

# Basics of chromosome structure

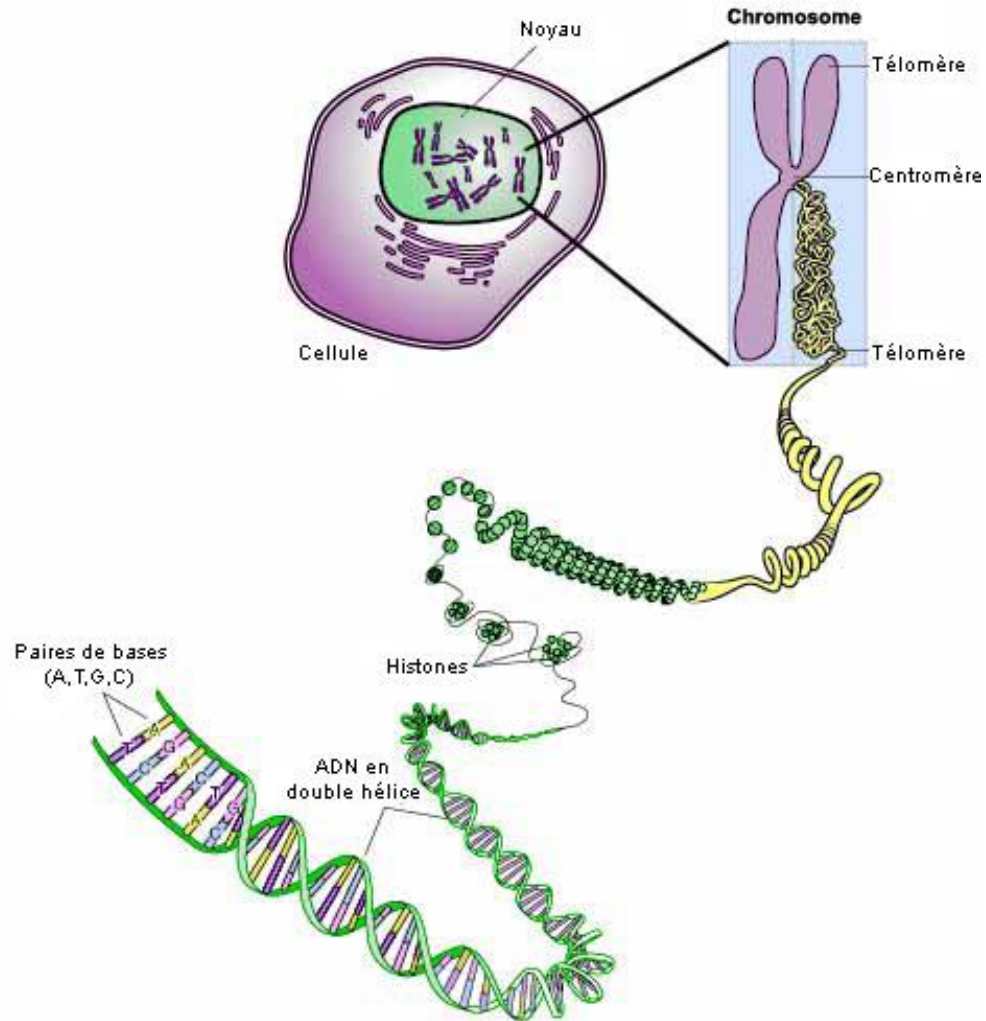

# Histones and nucleosomes

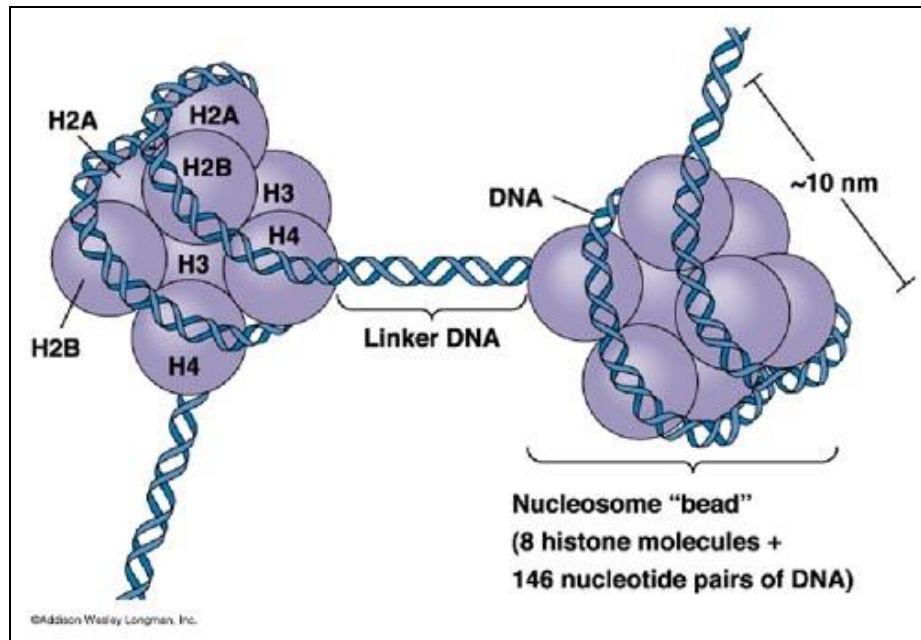
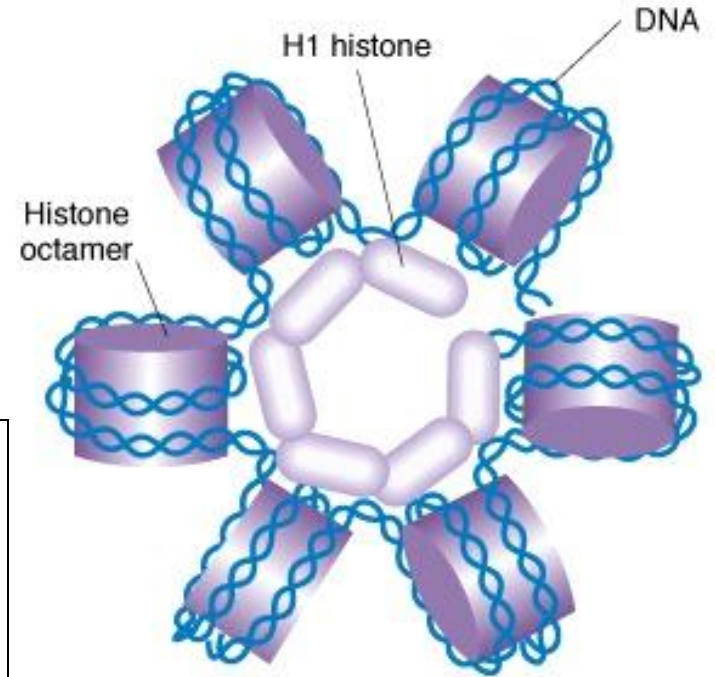
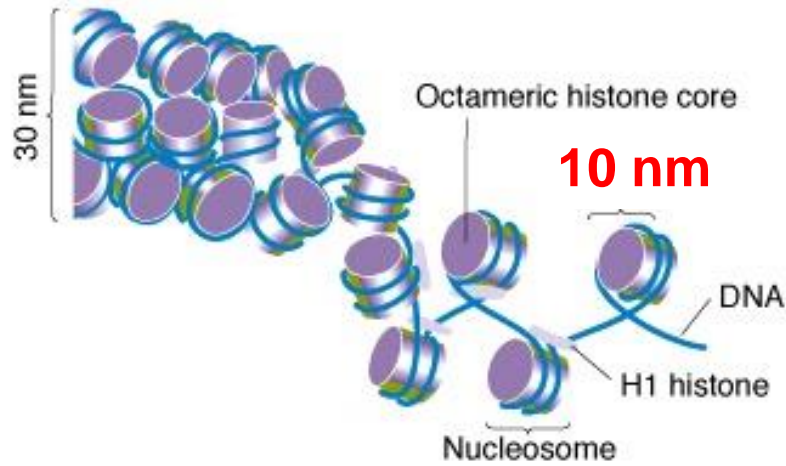

# The mystery of 30-nm fibre

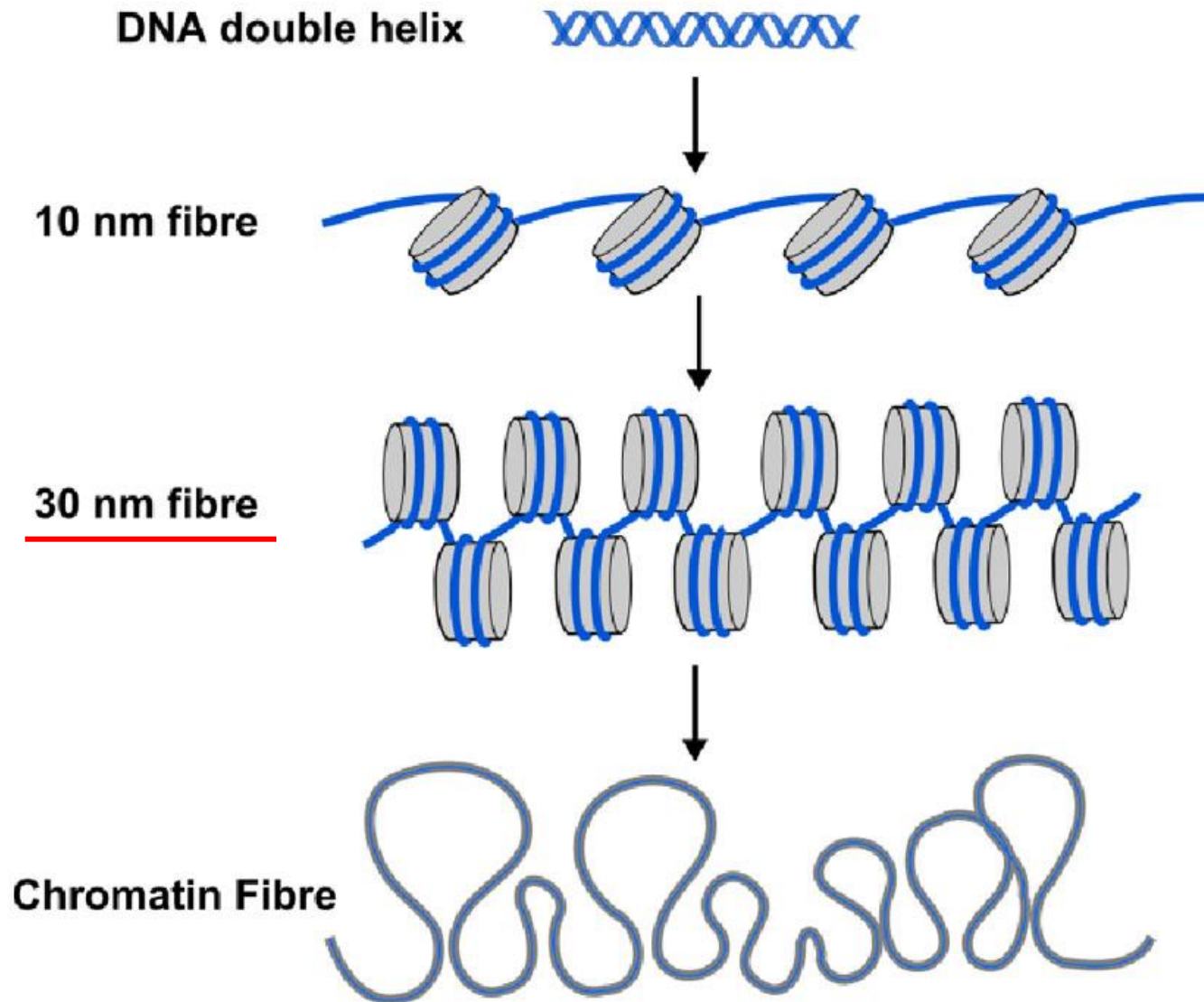

# Chromosome packing

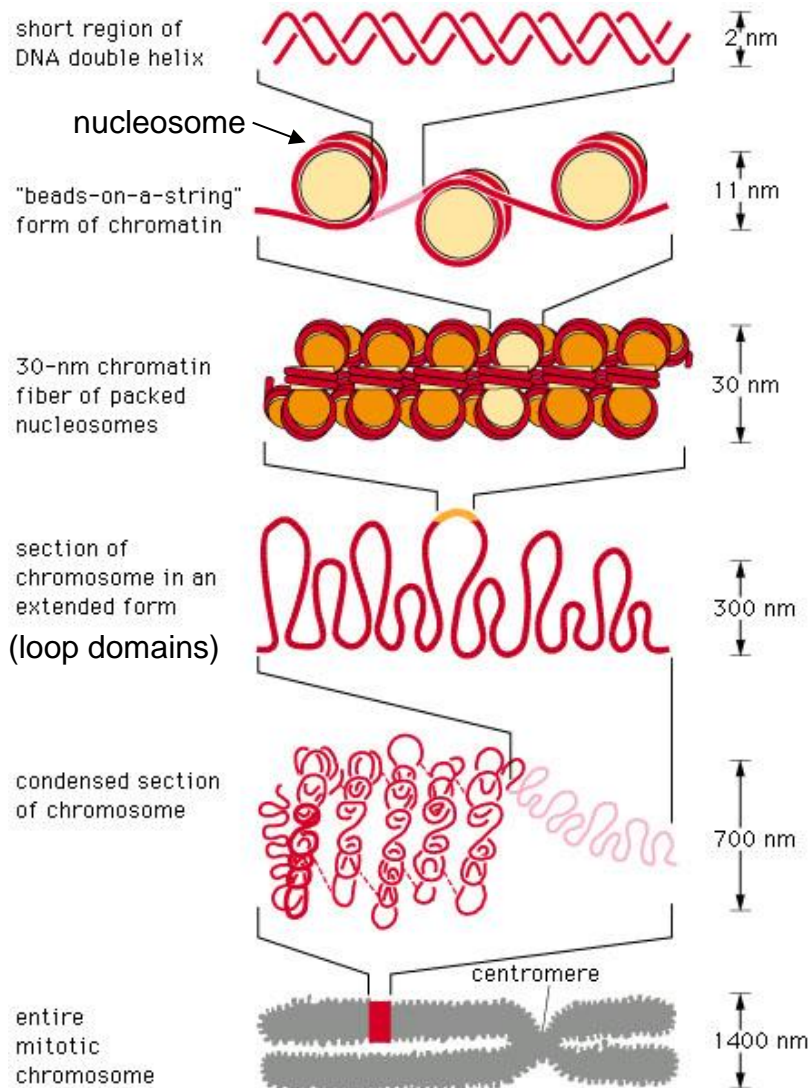

← not a regular structure

NET RESULT: EACH DNA MOLECULE HAS BEEN PACKAGED INTO A MITOTIC CHROMOSOME THAT IS 50,000x SHORTER THAN ITS EXTENDED LENGTH

# 10-nm fibers

condensation of several 10-nm fibers into compact structures  
(chromatin fibres)

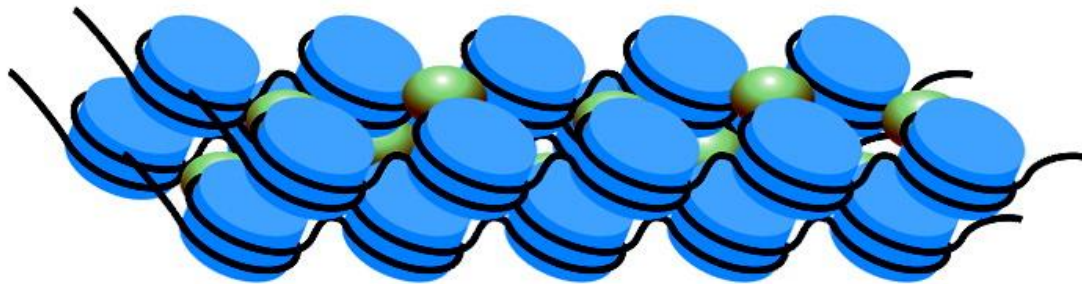

-  Nucleosome
-  Architectural protein

# 10-nm fibers: mechanisms of signal spreading in chromatin

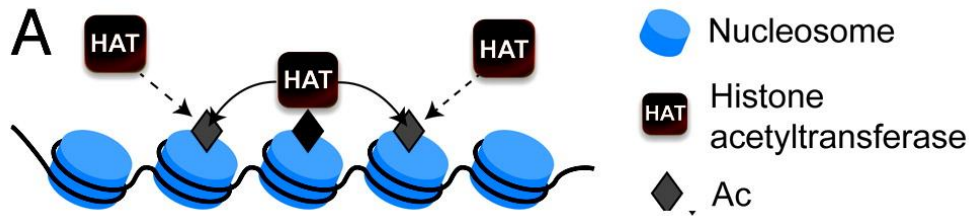

A classical view of the linear spreading of a signal in two directions along the chromatin fiber

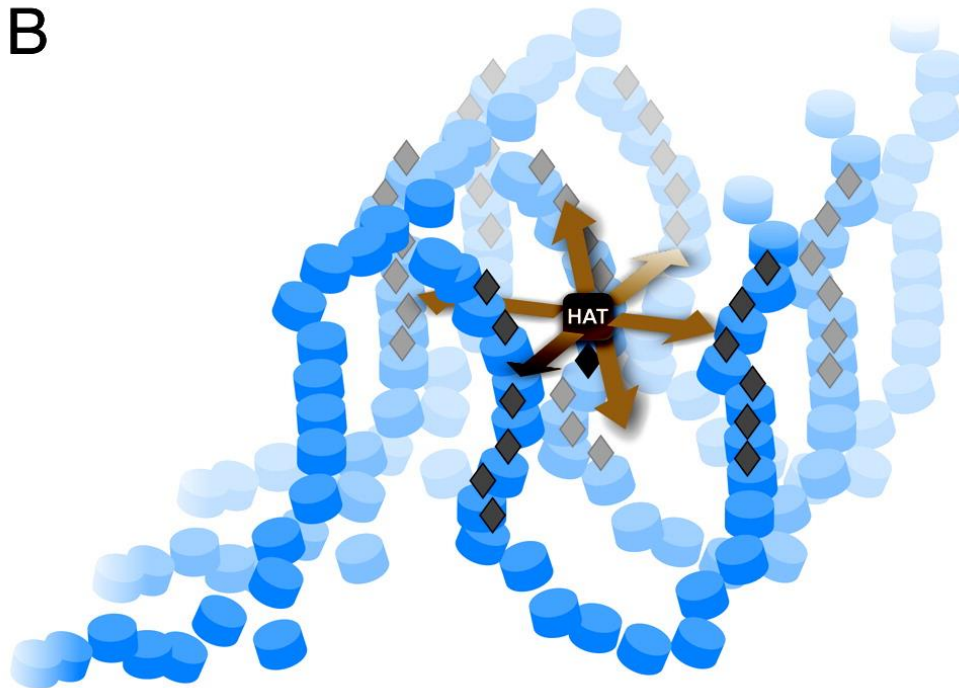

3D spreading of a signal in all directions from a nucleation center resulting in modification of multiple chromatin regions both in cis and in trans



# Chromosome organisation: Strings & Binders Switch (SBS) model

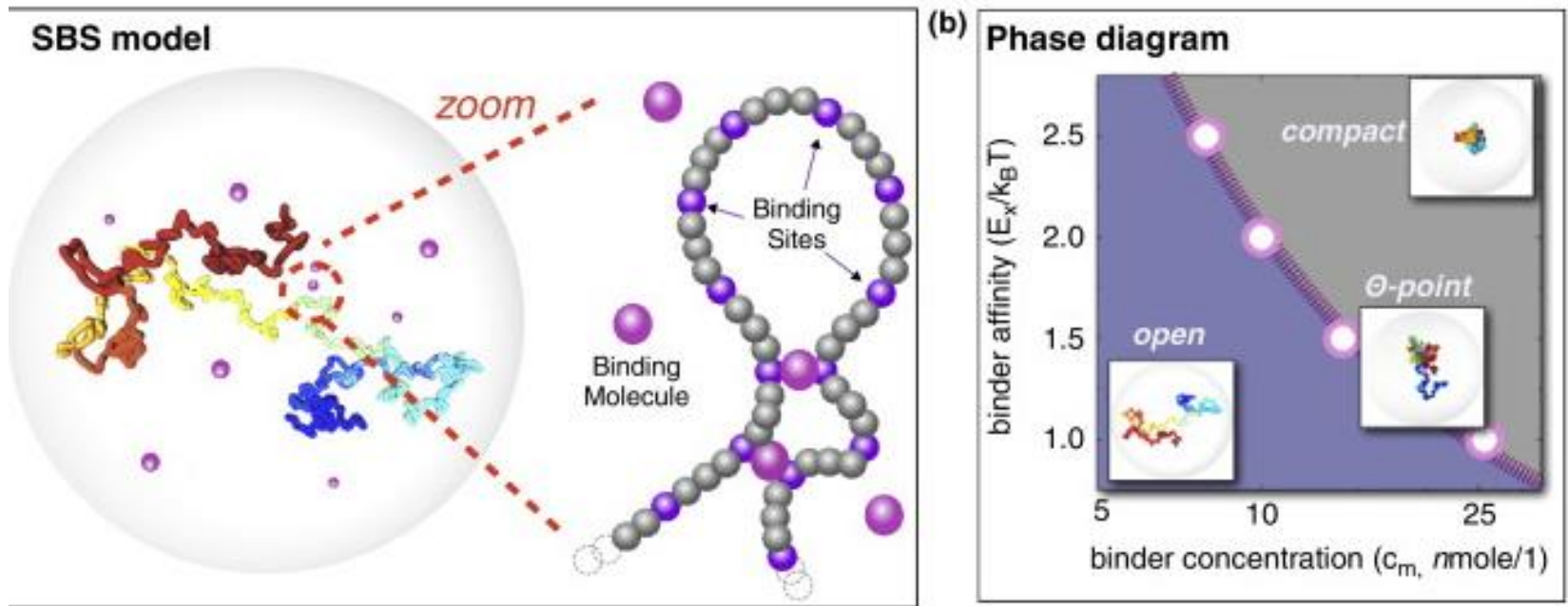

Barbieri M et al. (2012) Complexity of chromatin folding is captured by the strings and binders switch model. PNAS 109:16173-16178.

# Interphase chromosomes - chromosome territories

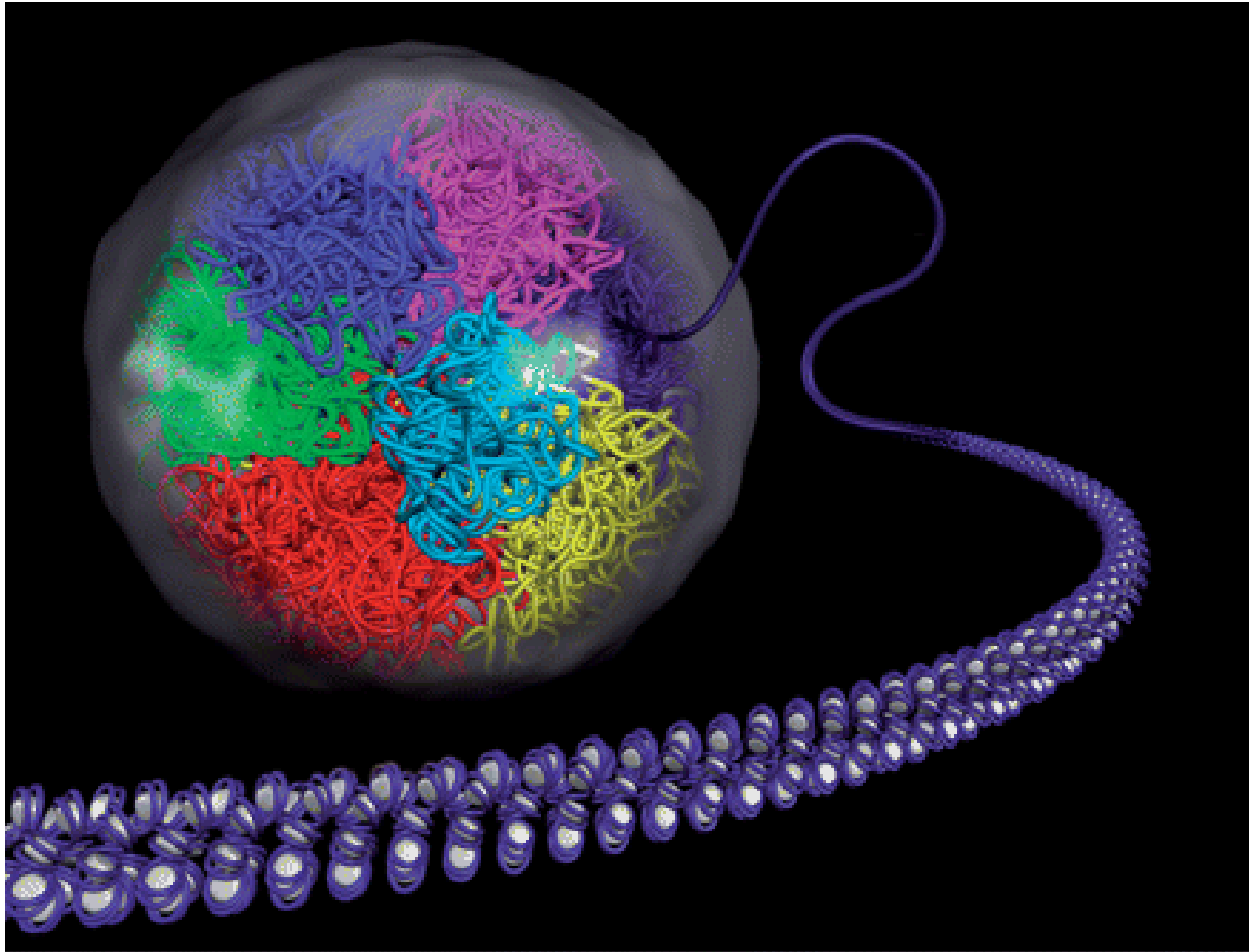

# Chromosome territories

The distribution of chromosomes and genes is nonrandom with some chromosomes preferentially occupying internal positions and others occupying peripheral positions.

The nonrandom radial positioning also gives rise to nonrandom genome neighborhoods.

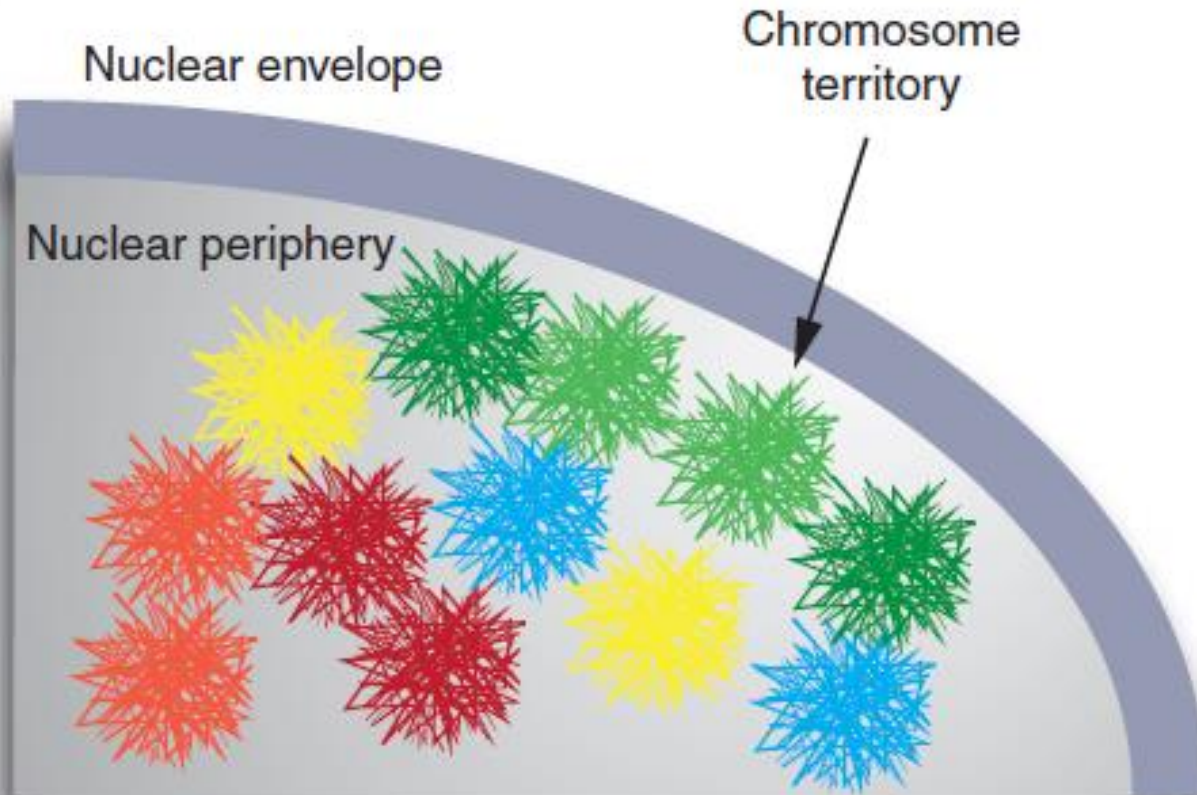

# Interphase chromosomes - chromosome territories

Chromosome territories - separate, yet interacting nuclear domains; important long-range chromatin interactions

Territories partitioned in (i) megabasepair-long domains with frequent internal contacts = topological associated domains (TADs), and (ii) the lamina-associated domains (LADs) interacting with the nuclear lamina, and with other functional compartments

Specialized transcription factories = genes come together; proximity between different transcription units

Splicing factors (splicing nascent transcripts into messenger RNA) accumulated in splicing speckles - often associated with active genes

Repressed chromatin associates with heterochromatic regions

# Chromosome territories

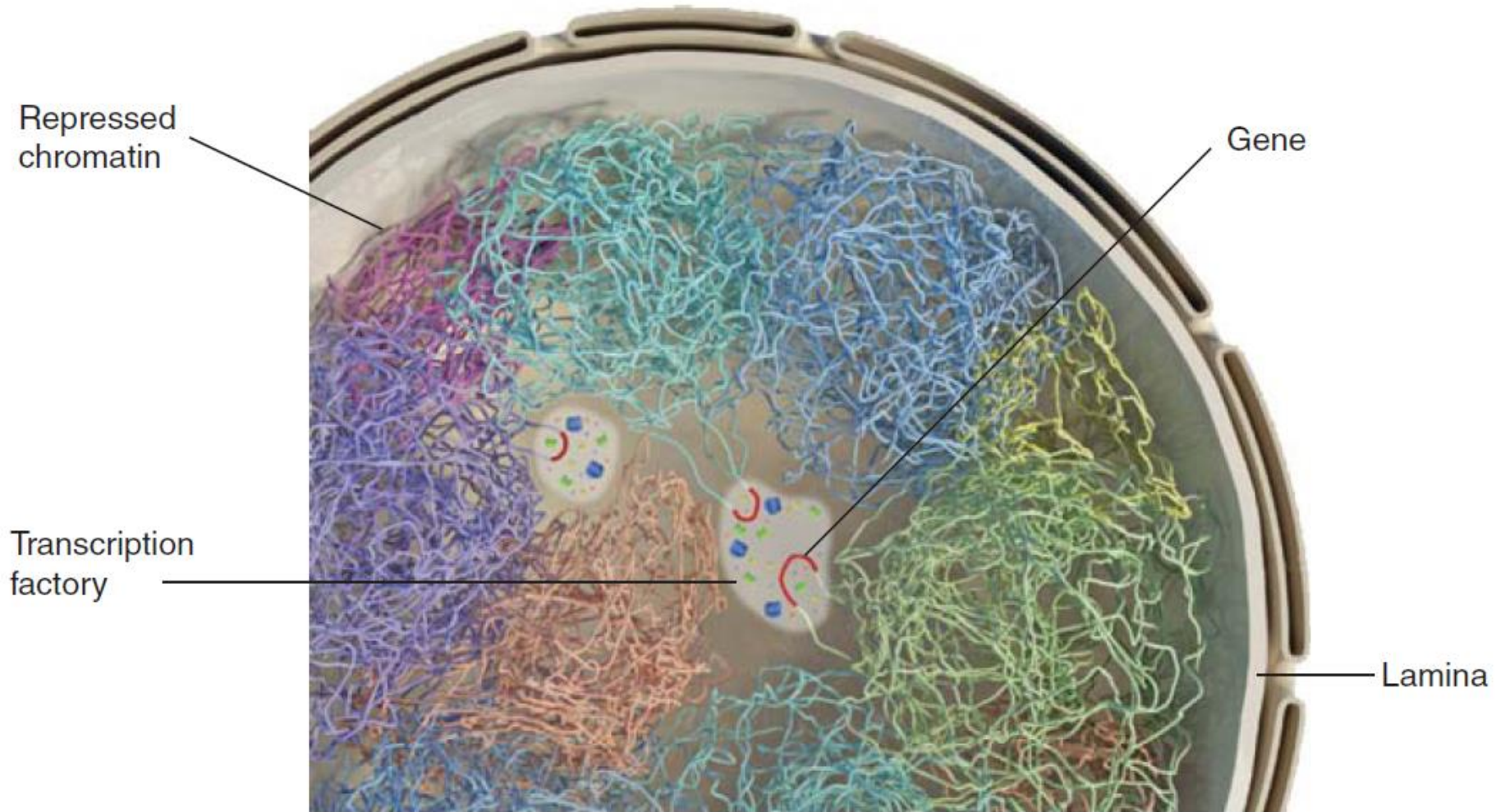

# Interphase chromosomes - chromosome territories

## Structural modelling of X chromosomes

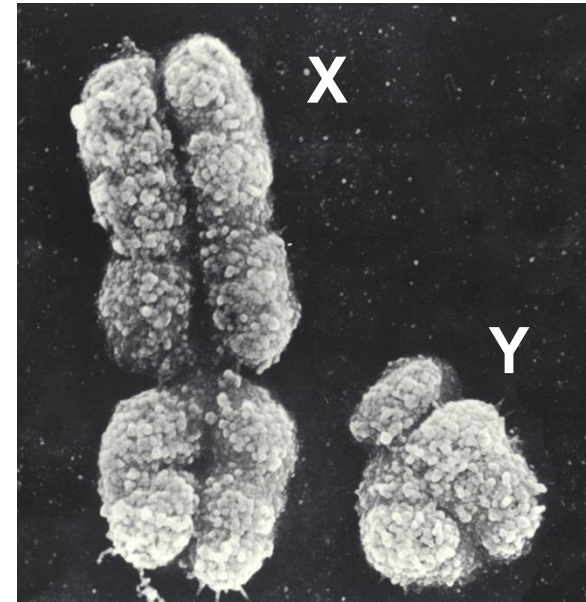
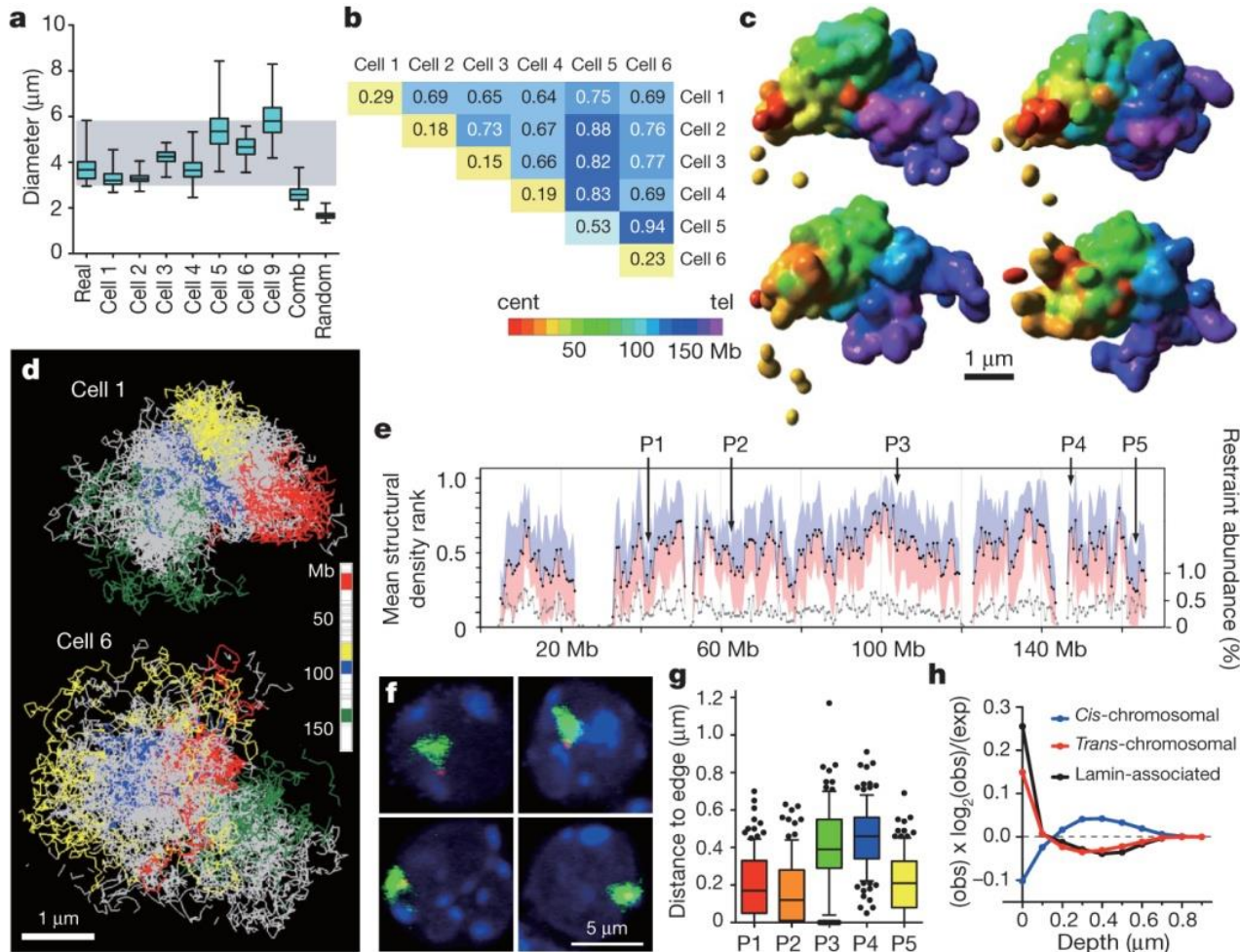

# Proximity of chromosome territories and chromosome translocations

The nonrandom organization of genes and chromosomes contributes to the formation of translocations.

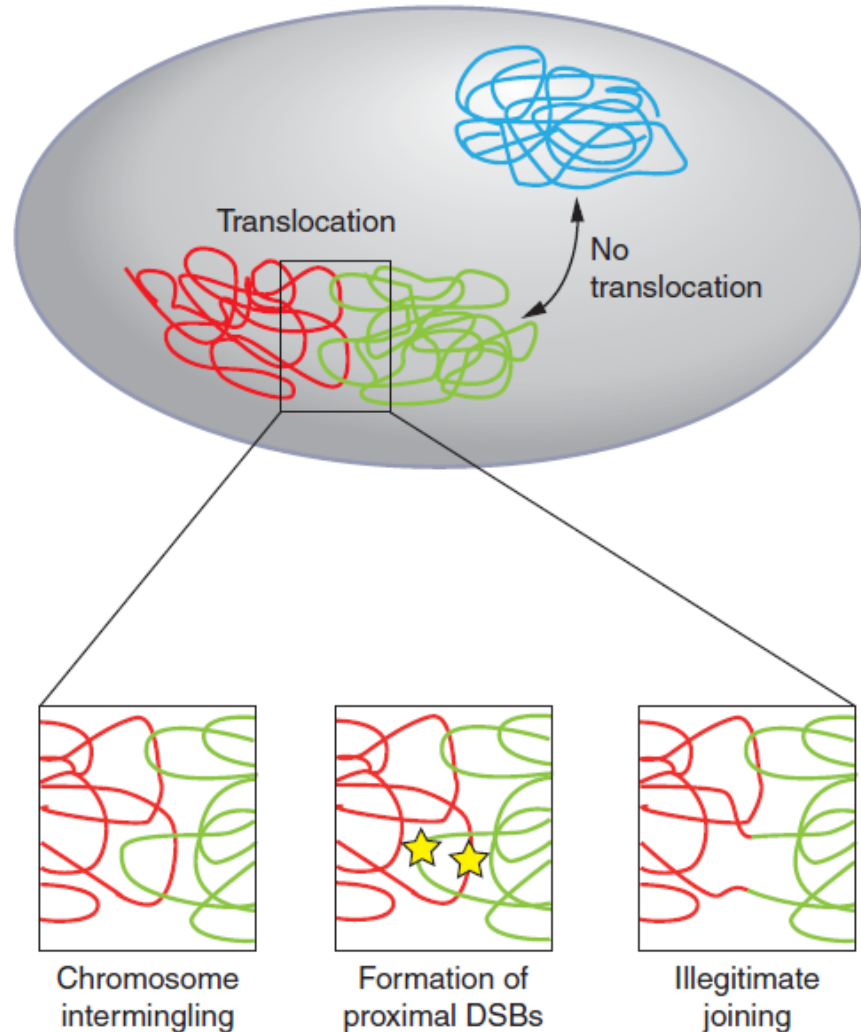

# Foster et al. (2013): Relative proximity of chromosome territories influences chromosome exchange partners in radiation-induced chromosome rearrangements in primary human bronchial epithelial cells

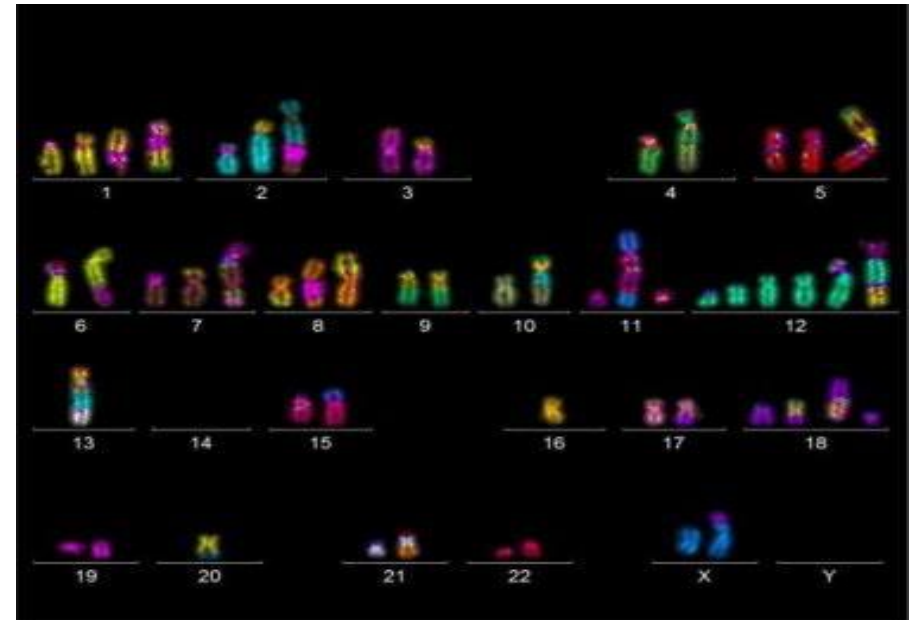
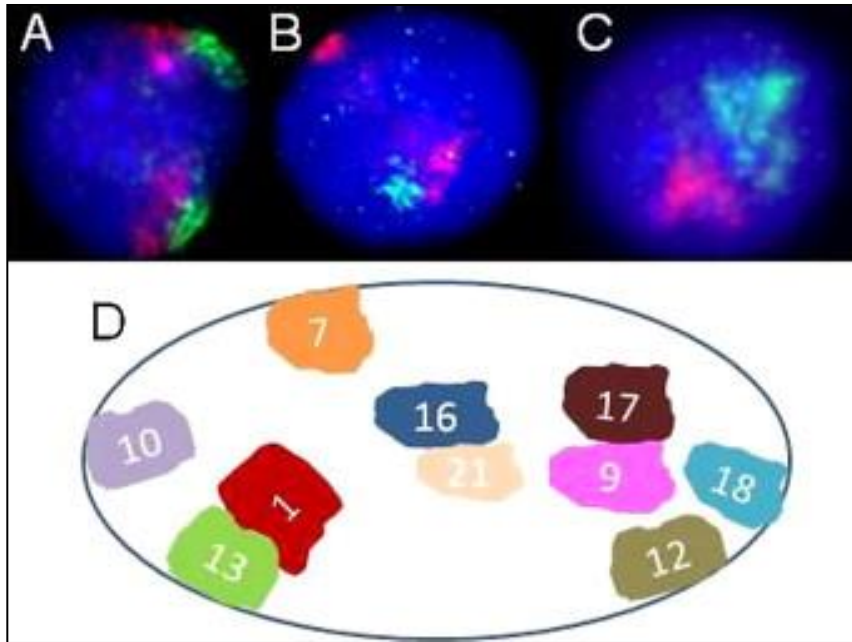

Relative interphase positions of chromosomes in NHBE cells. Panel A shows chromosomes 1 (red) and 13 (green), Panel B shows chromosomes 9 (green) and 17 (red) while Panel C shows chromosomes 16 (red) and 21 (green). Panel D outlines a 'map' of the relative positioning of chromosome territories in NHBE cells.



# Chromosome organization at interphase (in plants)

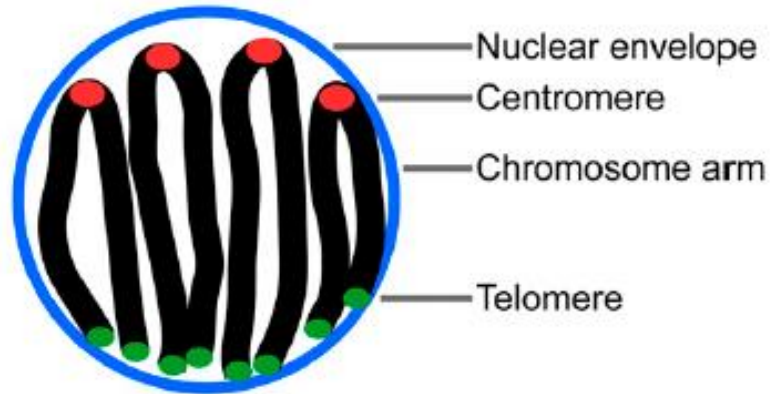

Rabl configuration

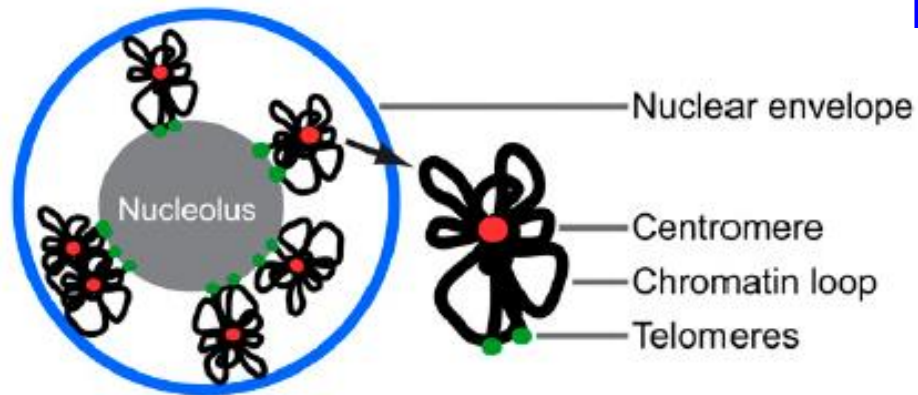

Radial loop model

# Rabl configuration

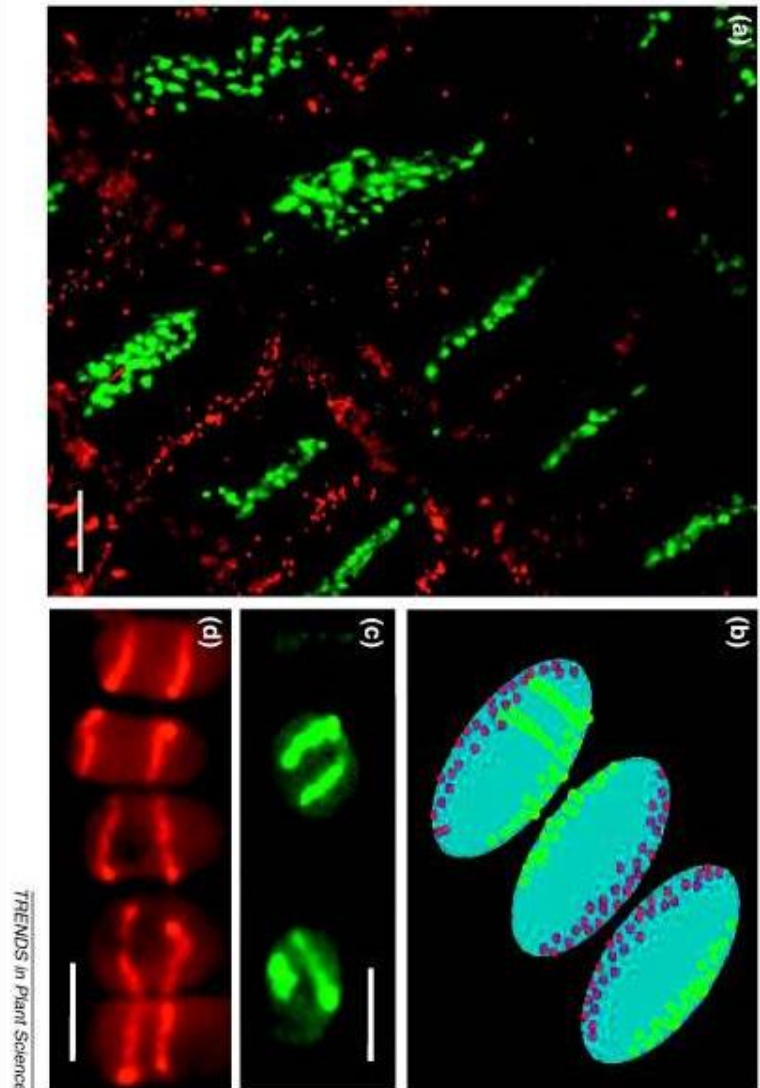
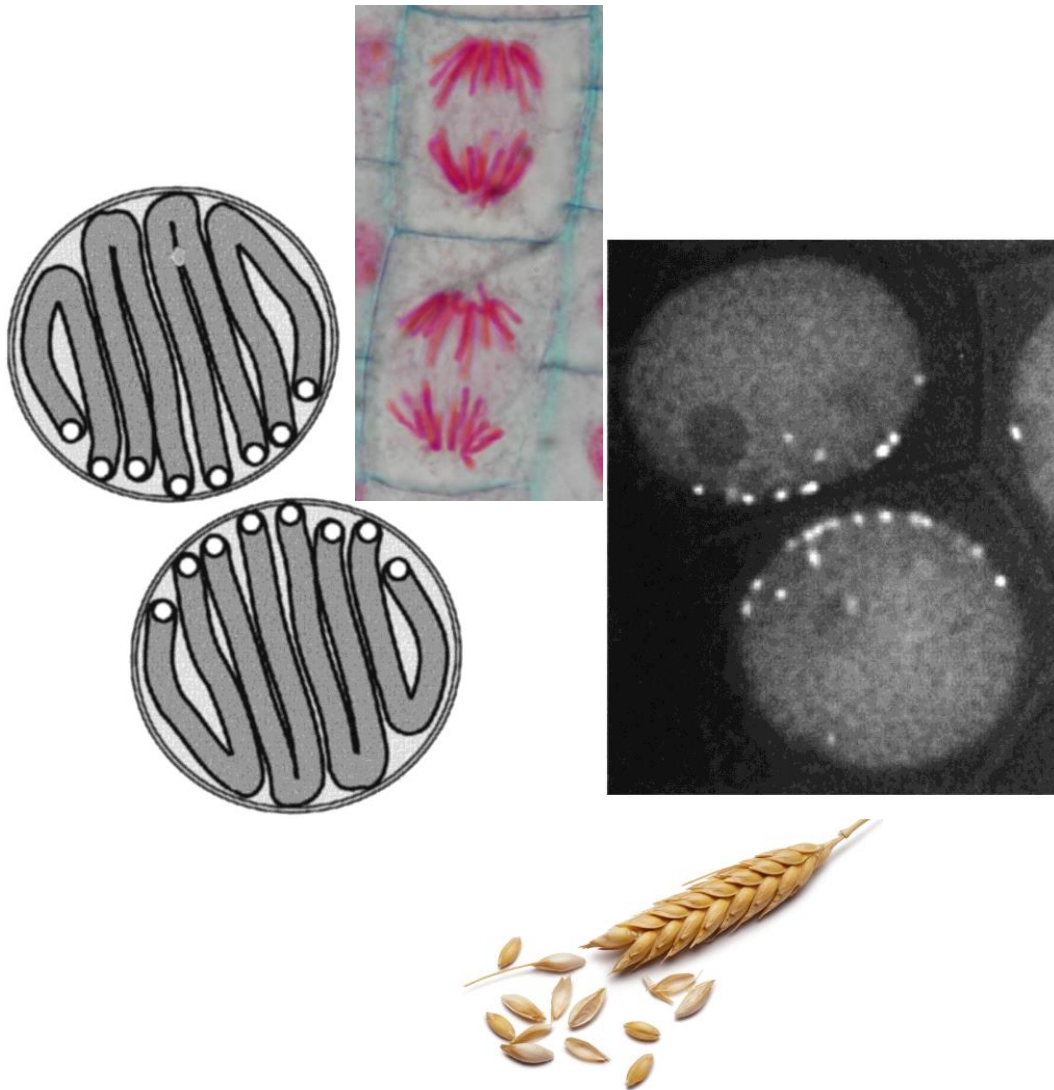

# Chromosome territories - Arabidopsis

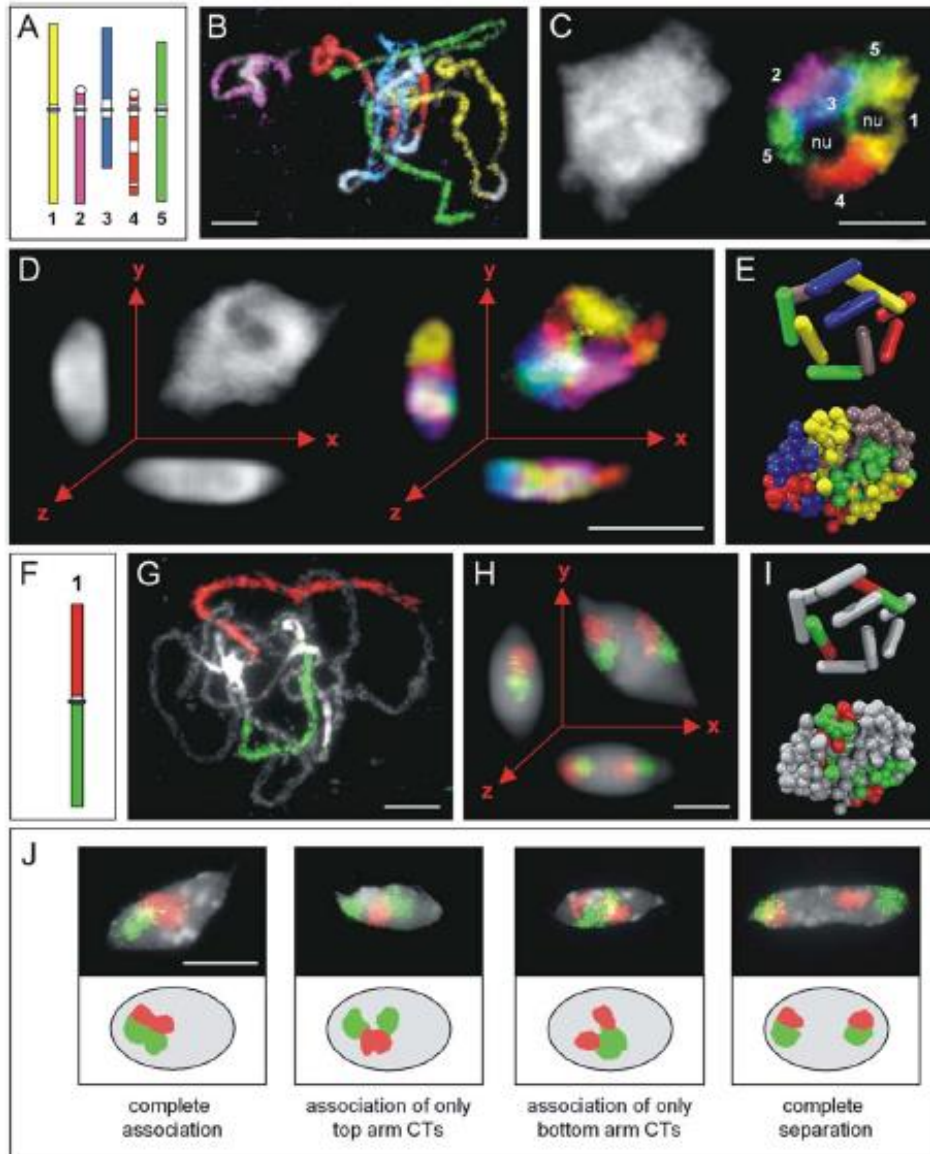

# Interphase chromosomes in *Arabidopsis* are organized as well defined chromocenters from which euchromatin loops emanate

Paul Fransz<sup>\*†</sup>, J. Hans de Jong<sup>‡</sup>, Martin Lysak<sup>\*</sup>, Monica Ruffini Castiglione<sup>§</sup>, and Ingo Schubert<sup>\*</sup>



chromosome 4

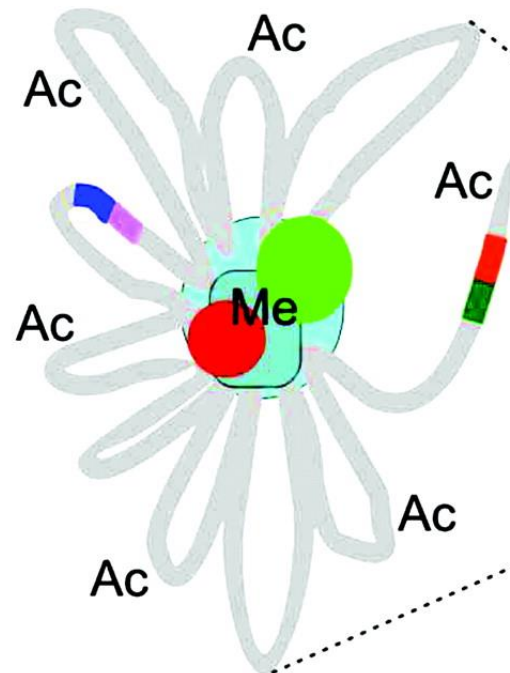

chromosome 4 territory

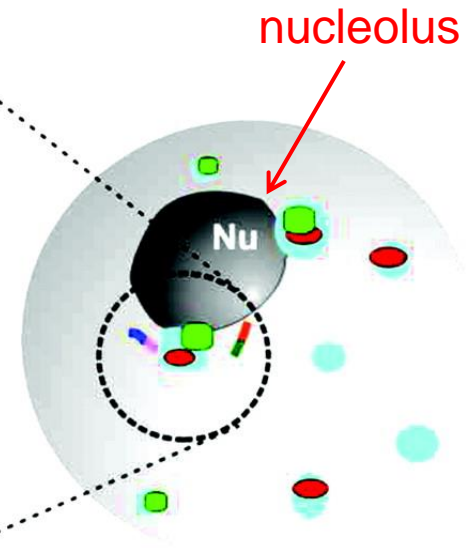

interphase nucleus

# Chromatin structure: eu- and heterochromatin

- Traditional view: chromatin compaction limits or enhances access to transcription factors
- Accessible chromatin is referred to as **euchromatin** and is active (Emil Heitz, 1928)  
(transcription facilitated)
- Inaccessible chromatin is called **heterochromatin** and is generally inactive (thought that regulatory proteins, e.g. transcription factors, cannot access DNA templates)
- Today - restriction of DNA accessibility is a local property of chromatin and not necessarily a consequence of microscopically visible compaction.

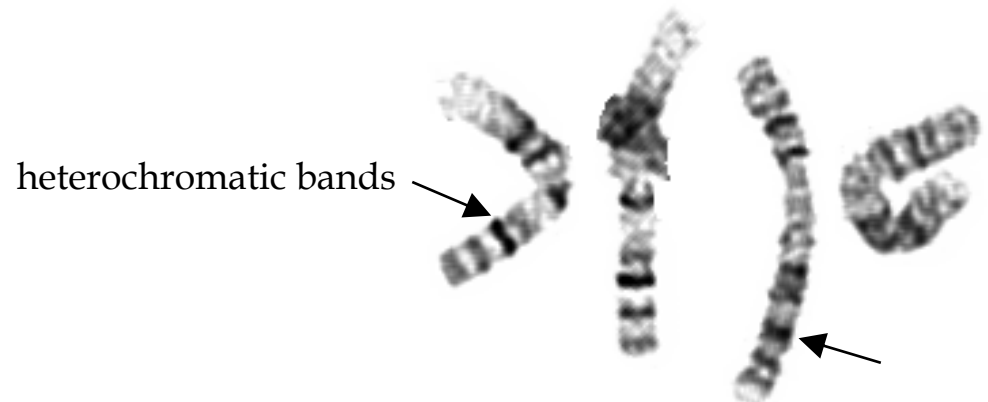

# Heterochromatin in plant species

barley

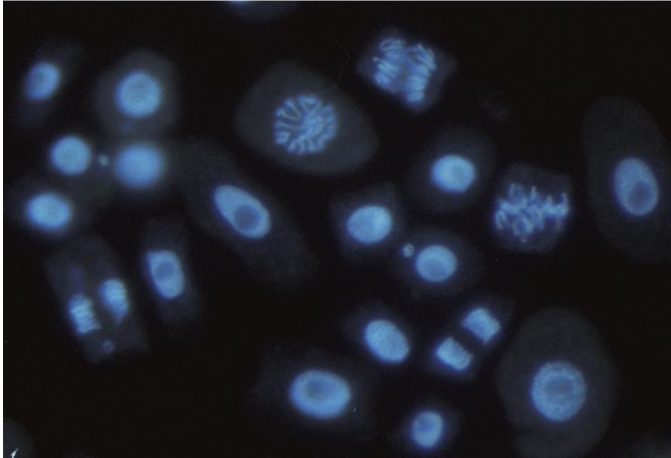

Arabidopsis

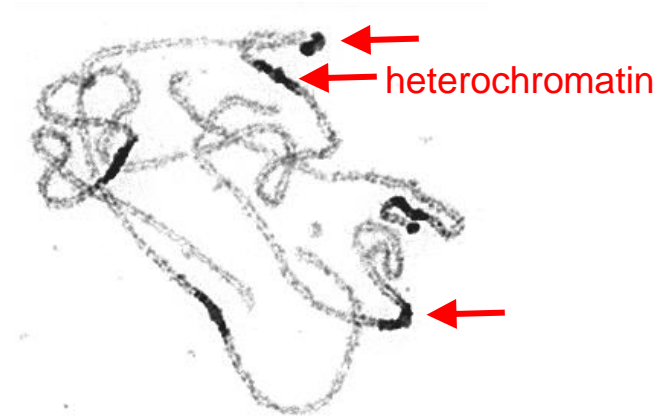
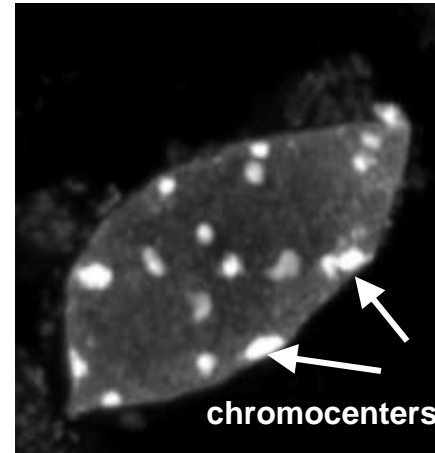

# Heterochromatin in plant species: Arabidopsis

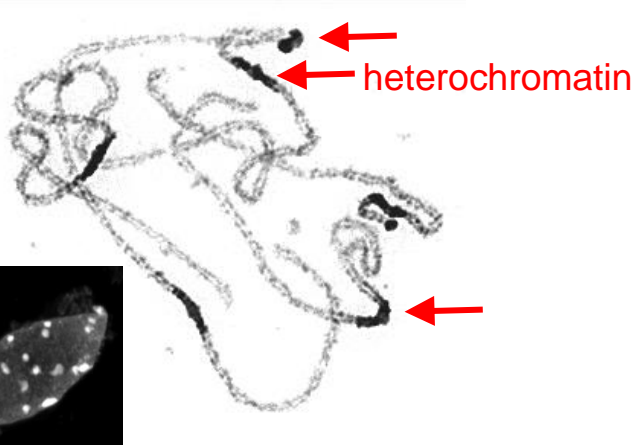

Genomic features in inaccessible and hyper-accessible regions

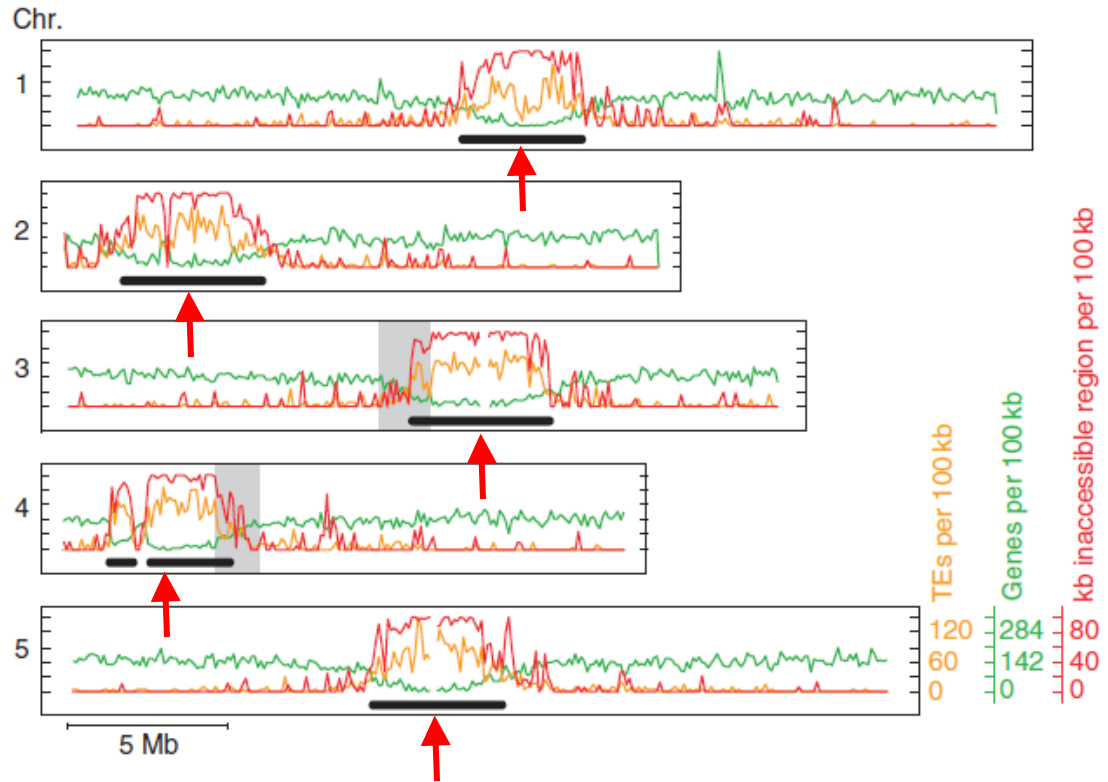
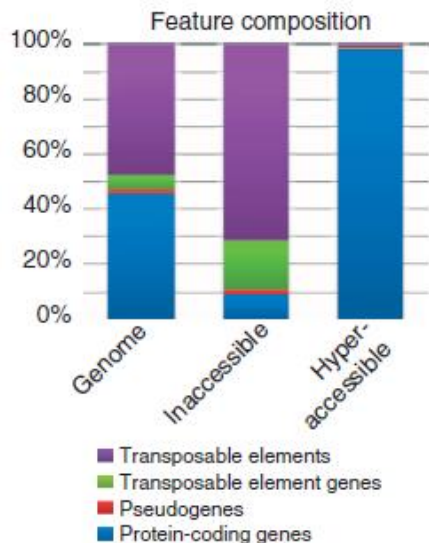

density of inaccessible region

protein-coding genes

TEs along chromosomes

heterochromatin:  
5-cytosine methylation,  
dimethylation of H3 (H3K9me2)

euchromatin:  
trimethylation of H3 (H3K9me3)

# Chromosomes and nuclei stained by fluorescent dyes

## 4',6-Diamidino-2-phenylindole (DAPI)

AT-specific fluorescent dye

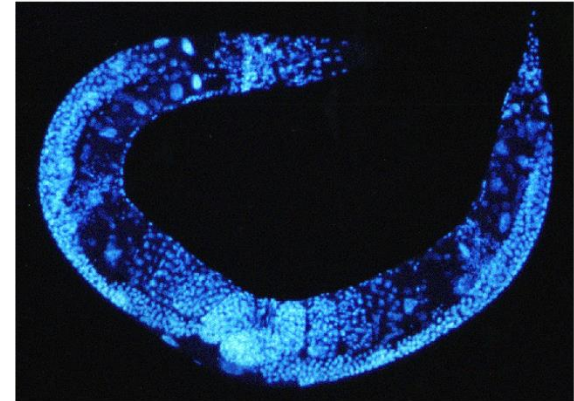
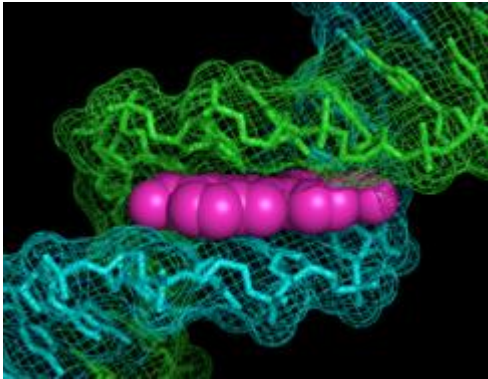
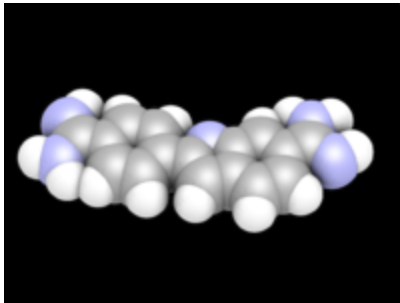

*Caenorhabditis elegans*

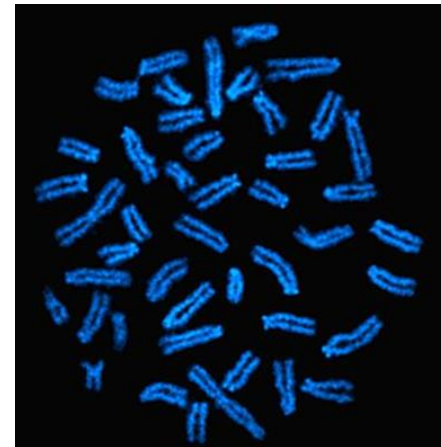



# Heterochromatin and euchromatin



DAPI-stained chromosomes of *Fritillaria* spp. (B/W, inverted)

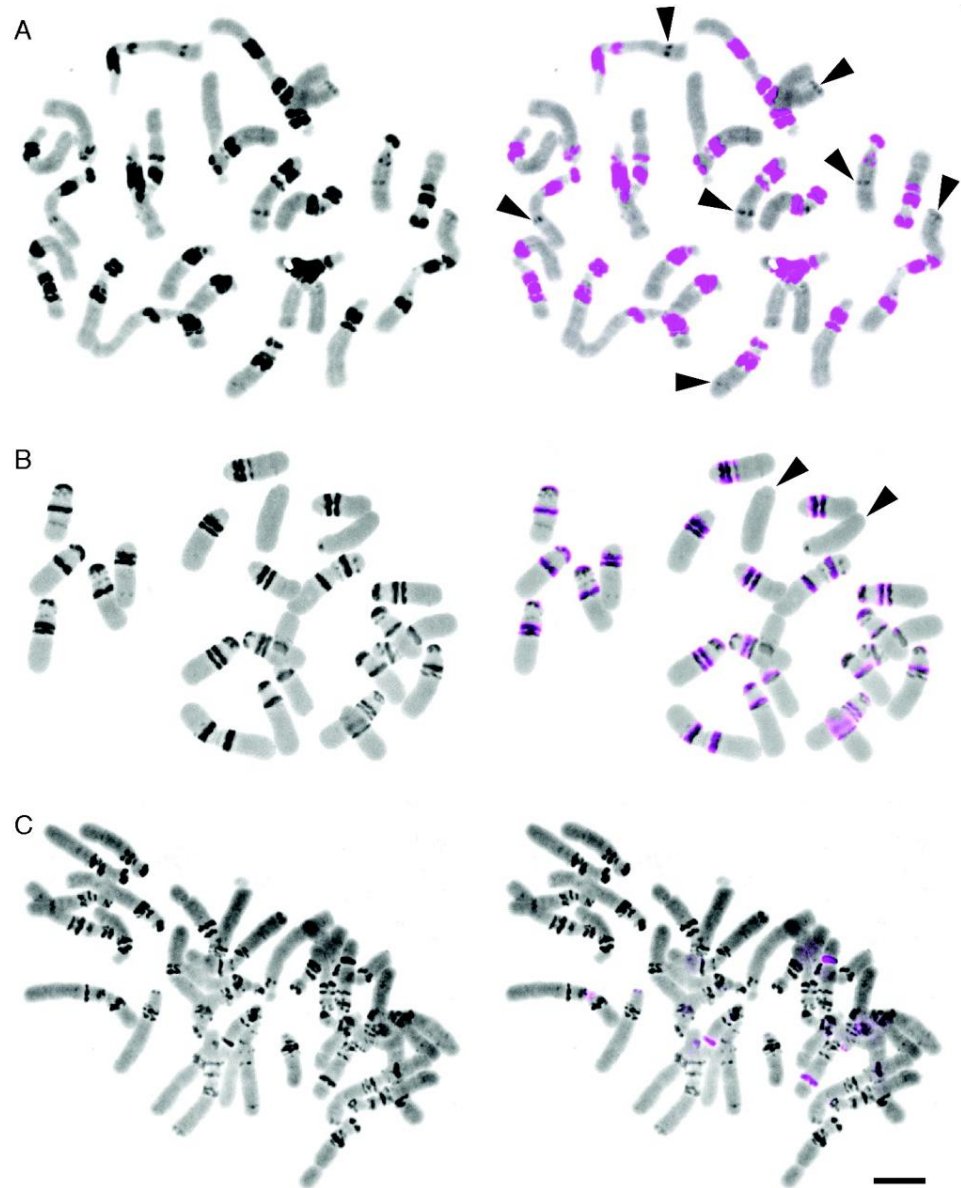

# Scheme of plant chromosome (after Haslop-Harrison)

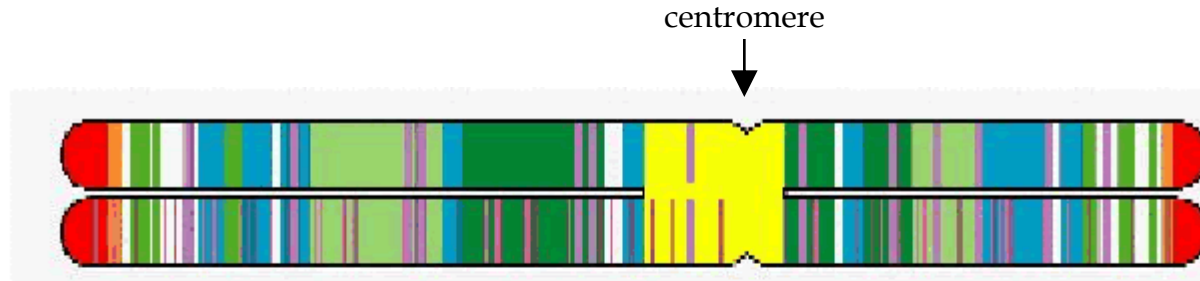

**Intercalary tandem repeats**



**Centromere associated tandem repeat**



**Telomeric and sub-telomeric repeats**



**Dispersed tandem repeats**



**Dispersed Ty-1-copia-like retroelements  
LTR and microsatellites**



**Single and low-copy sequences  
Including genes**

# Arabidopsis chromosomes

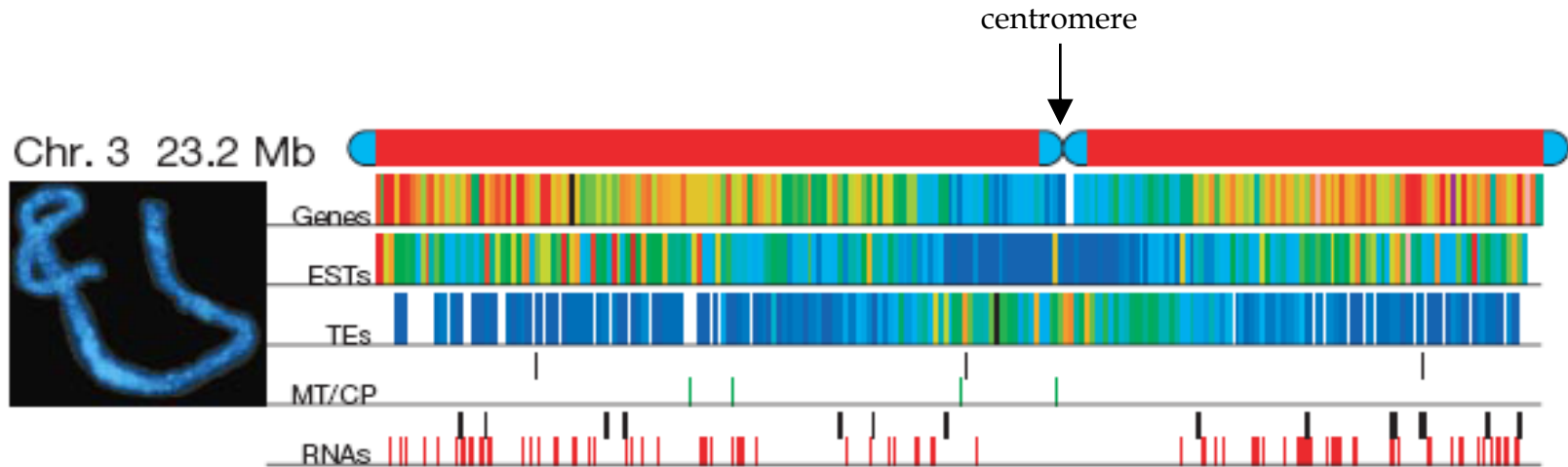

The frequency of features was given pseudo-colour assignments, from **red (high density)** to **deep blue (low density)**.

Gene density (‘Genes’) ranged from 38 per 100 kb to 1 gene per 100 kb; Transposable element densities (‘TEs’) ranged from 33 per 100 kb to 1 per 100 kb.

# Mitotic and meiotic chromosomes



mitotic chromosomes of *Pinus*

1 chromosome = 2 chromatids



meiotic (pachytene) chromosomes of *Antirrhinum*

1 bivalent = 2 chromosomes = 4 chromatids

# Cell cycle, chromosomes and chromatids

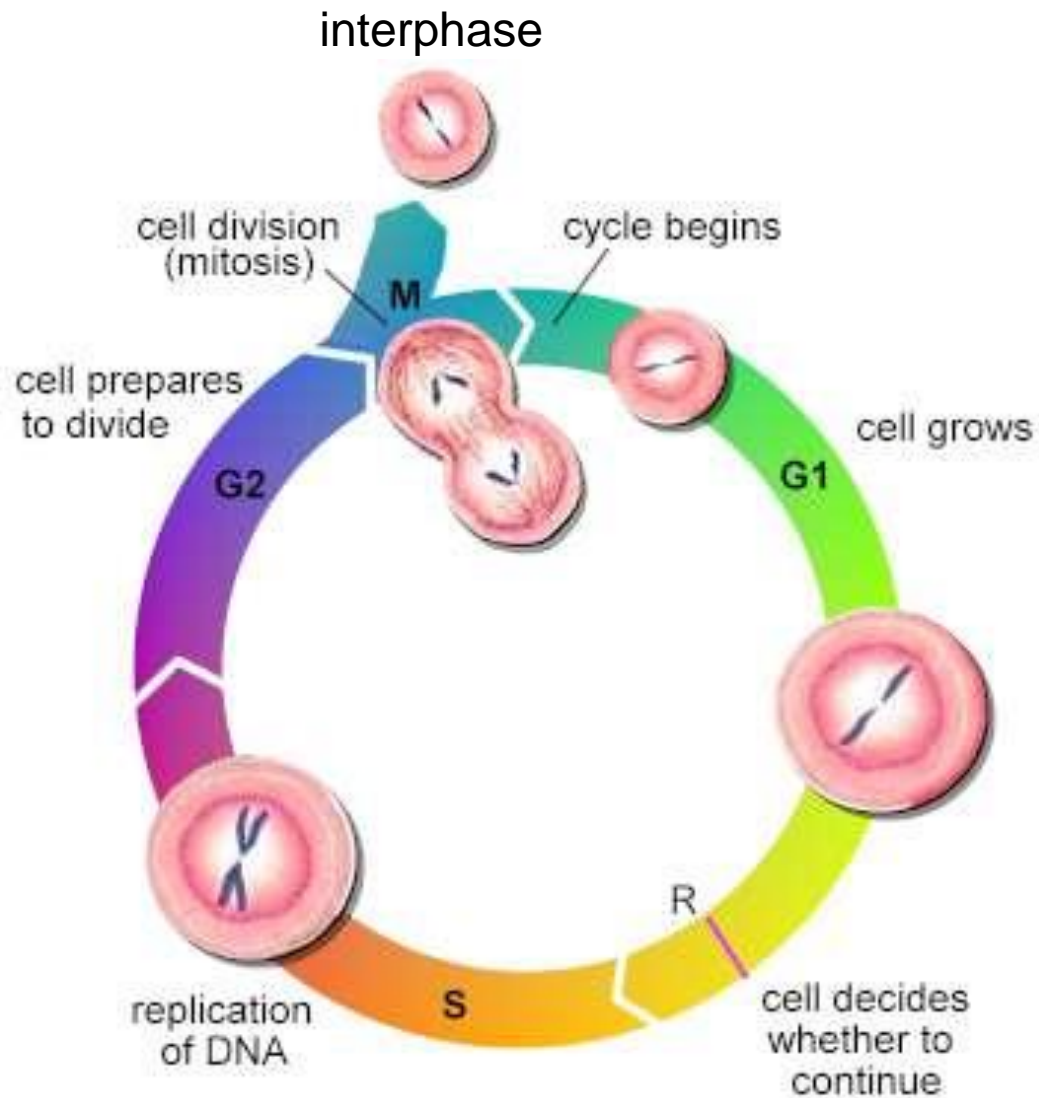

# Mitosis

(a) Interphase ( $G_2$ )

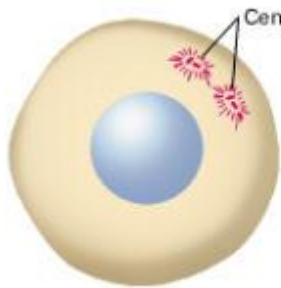

(b) Early prophase

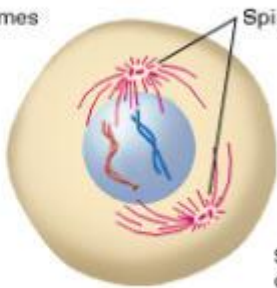

(c) Late prophase

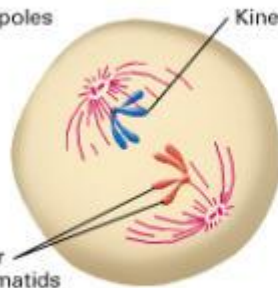

(d) Metaphase

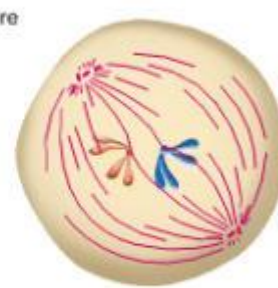

(e) Anaphase

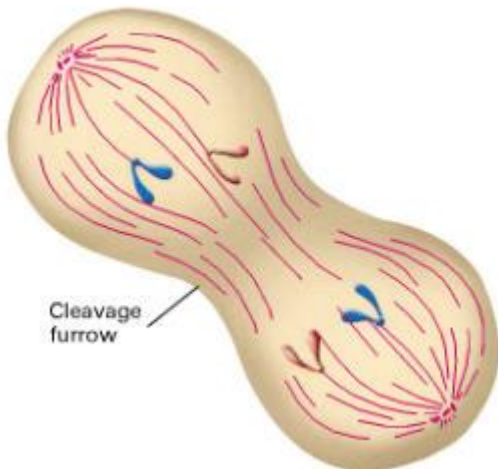

(f) Telophase

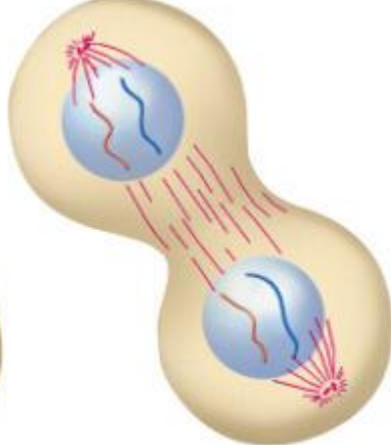

(g) Interphase ( $G_1$ )

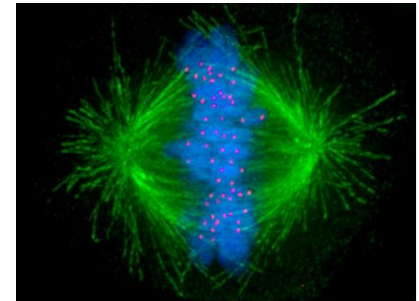
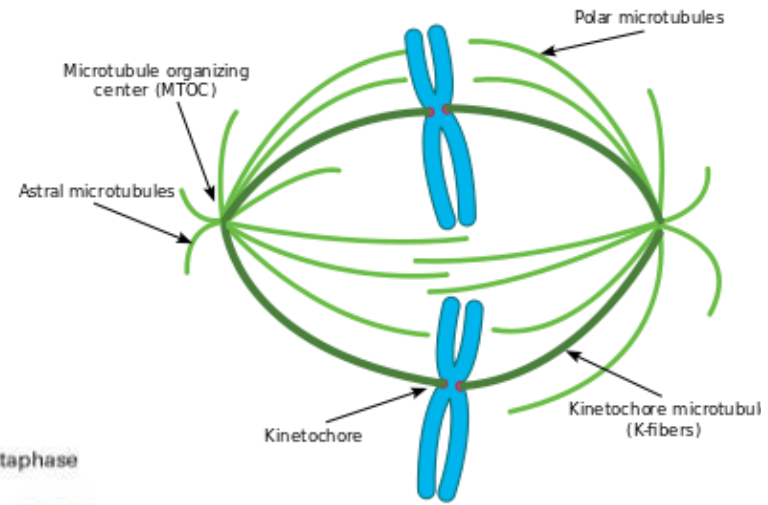
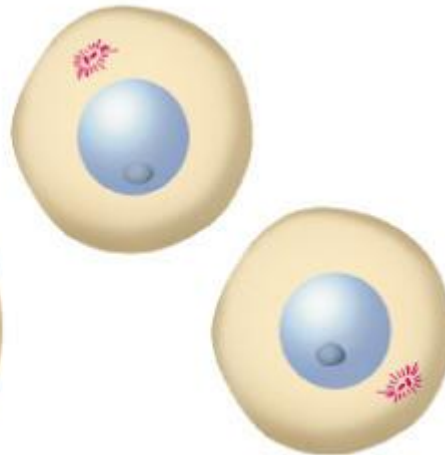

# Meiosis

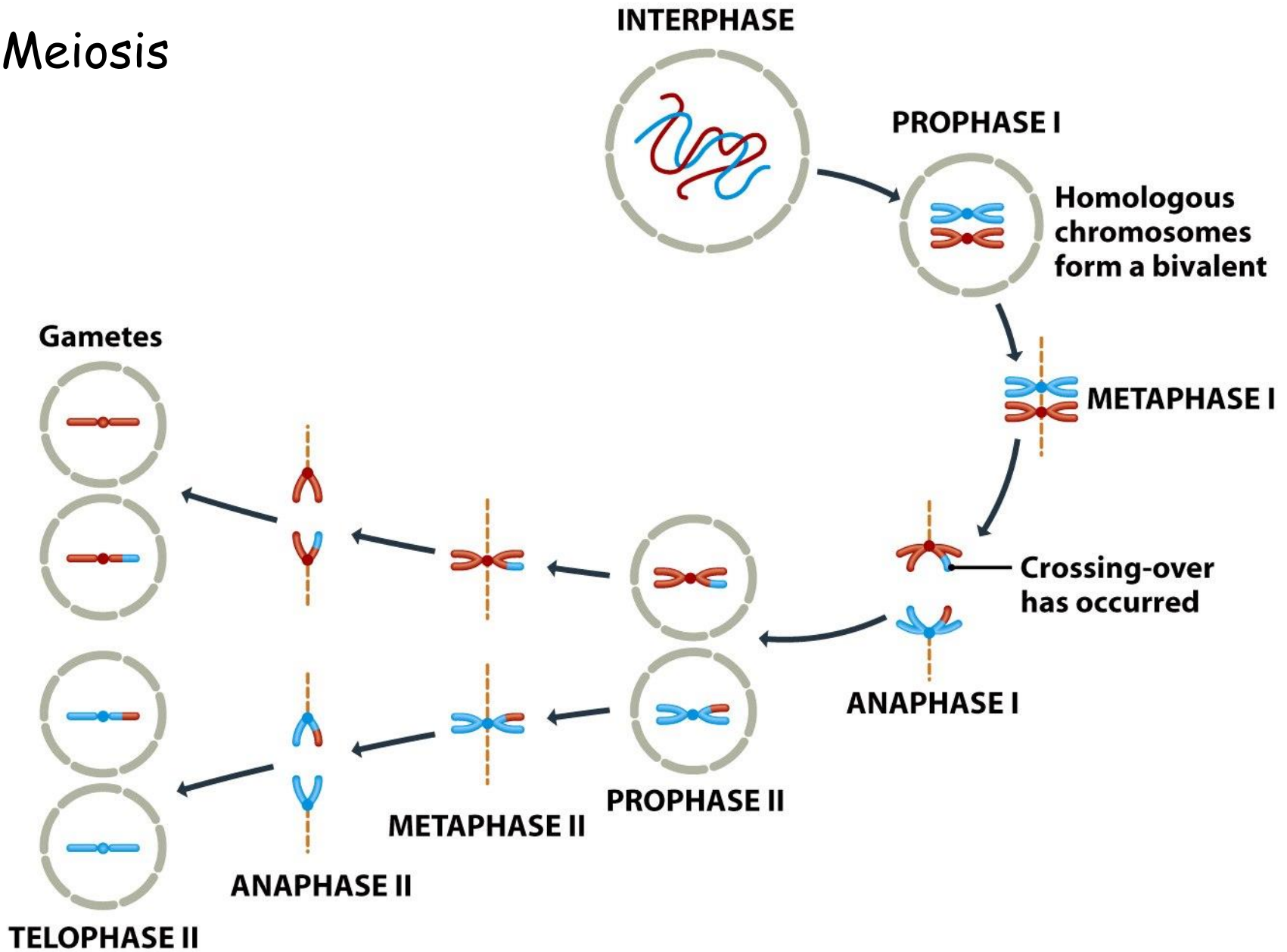
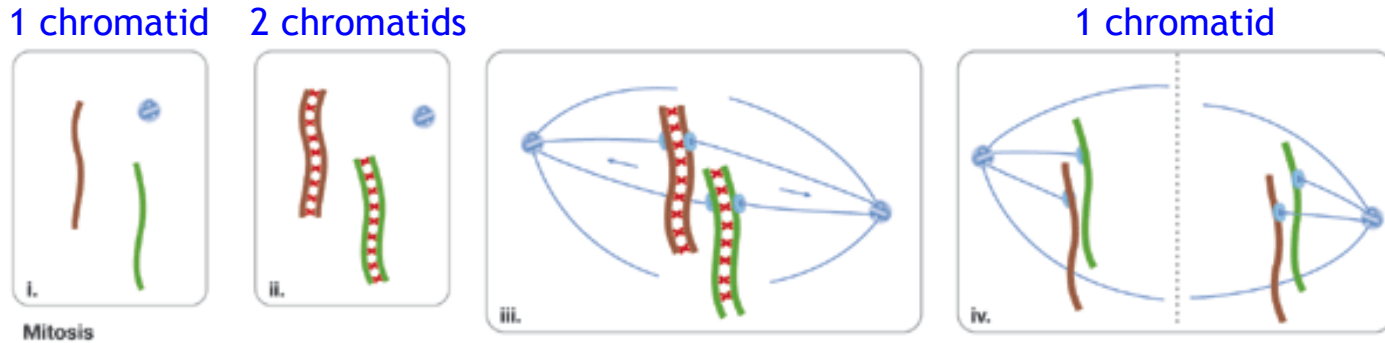

Figure 3.16 *Genomes 3* (© Garland Science 2007)

# Chromosomes and chromatids during mitosis and meiosis

## Mitosis



## 1 chromatid

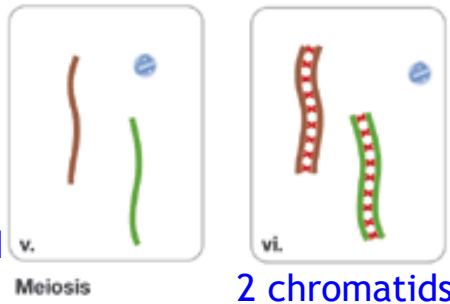

## 2 chromatids

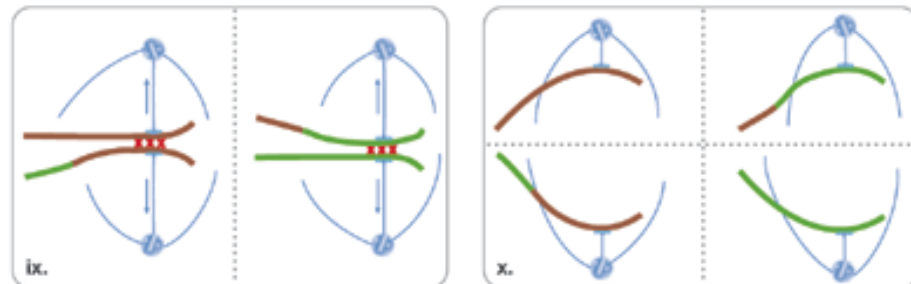
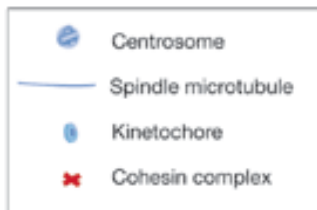
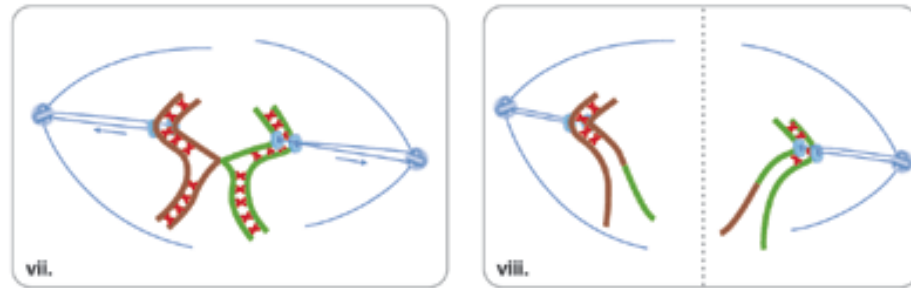

## 2 chromatids

## 1 chromatid

## Meiosis



# Chromosome morphology

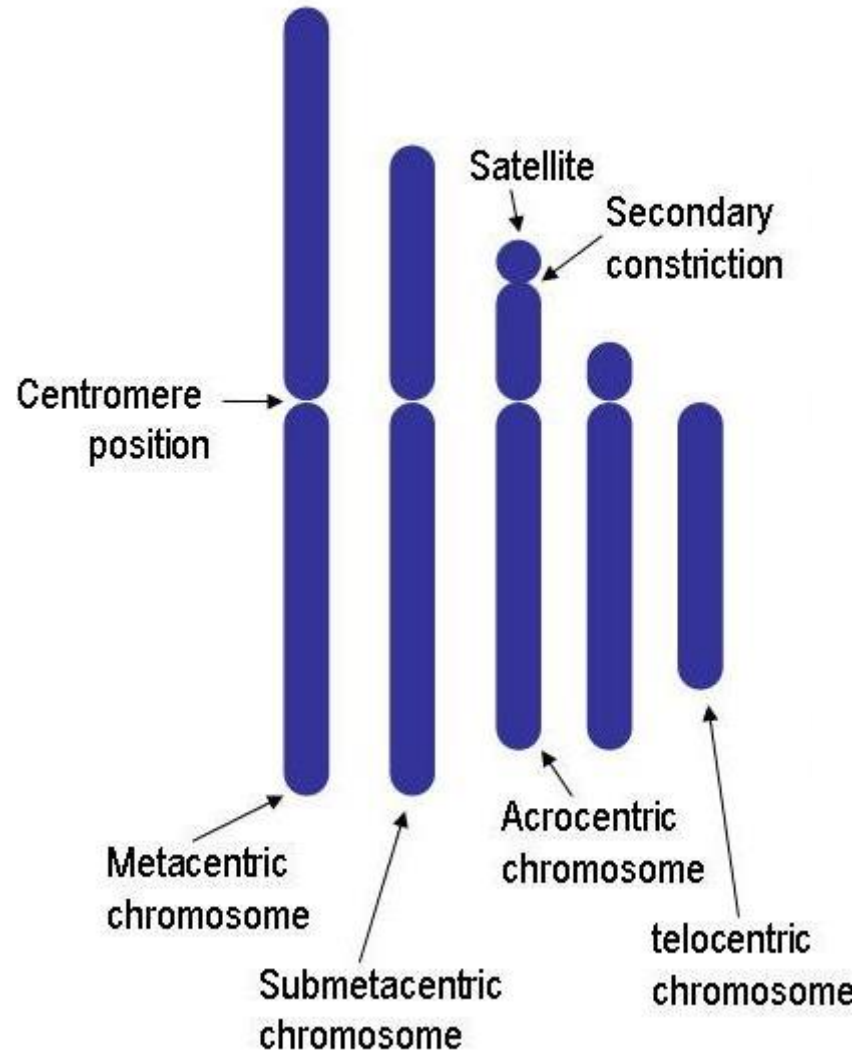
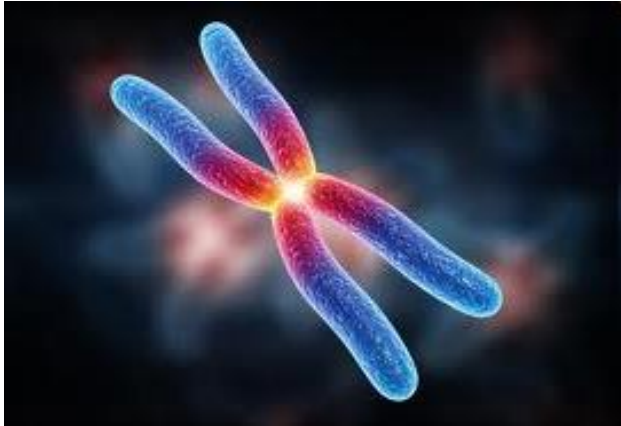

# Centromere structure, function & evolution

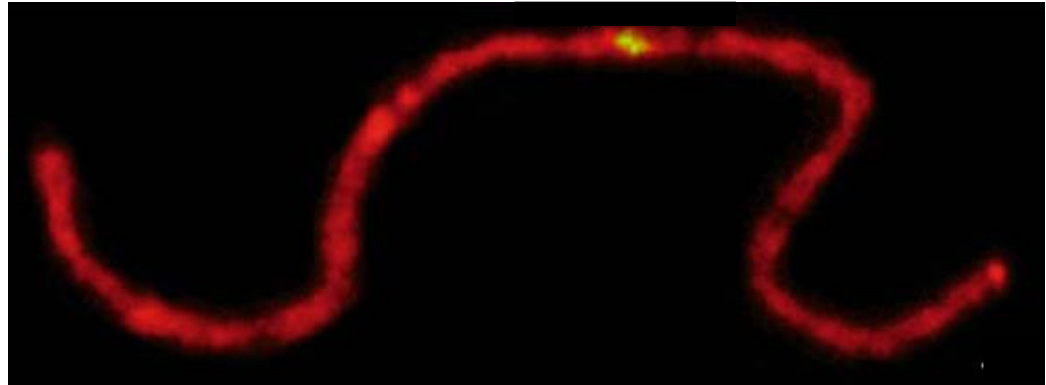
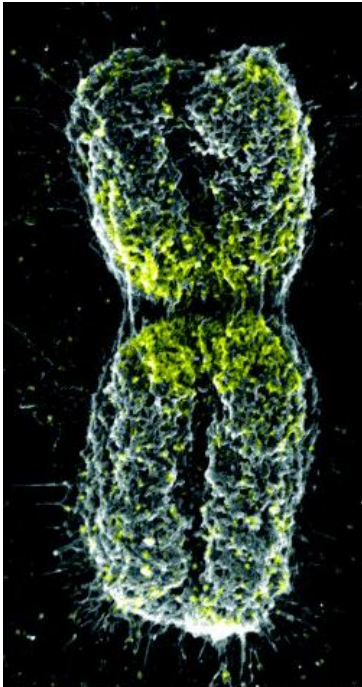

# Centromere function

- chromosomes can be monocentric or holocentric (*Luzula*, *Eleocharis*, some insects)
- dicentric chromosomes usually unstable (anaphase bridges >> breakage), one centromere has to be inactivated epigenetically (cf. dicentric Robertsonian fusions)
- acentric chromosome fragments are unstable at mitosis/meiosis and lost
- sister chromatid cohesion throughout cell cycle until sister chromatid segregation at mitosis/meiosis II (centromeres enriched with cohesin)
- sites of kinetochore formation ensuring correct chromosome position on mitotic/meiotic spindle: chromosome congression (kinetochore: spindle microtubules attached)

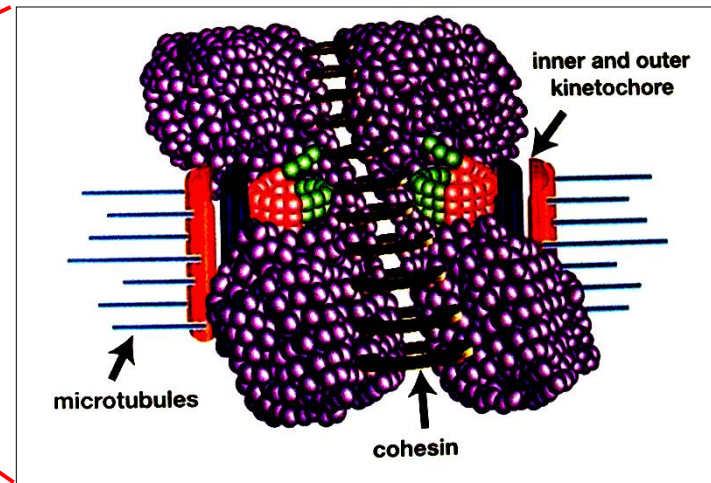

# Centromere function: mitotic chromatid segregation

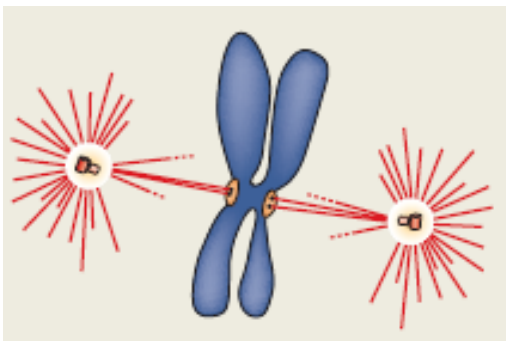
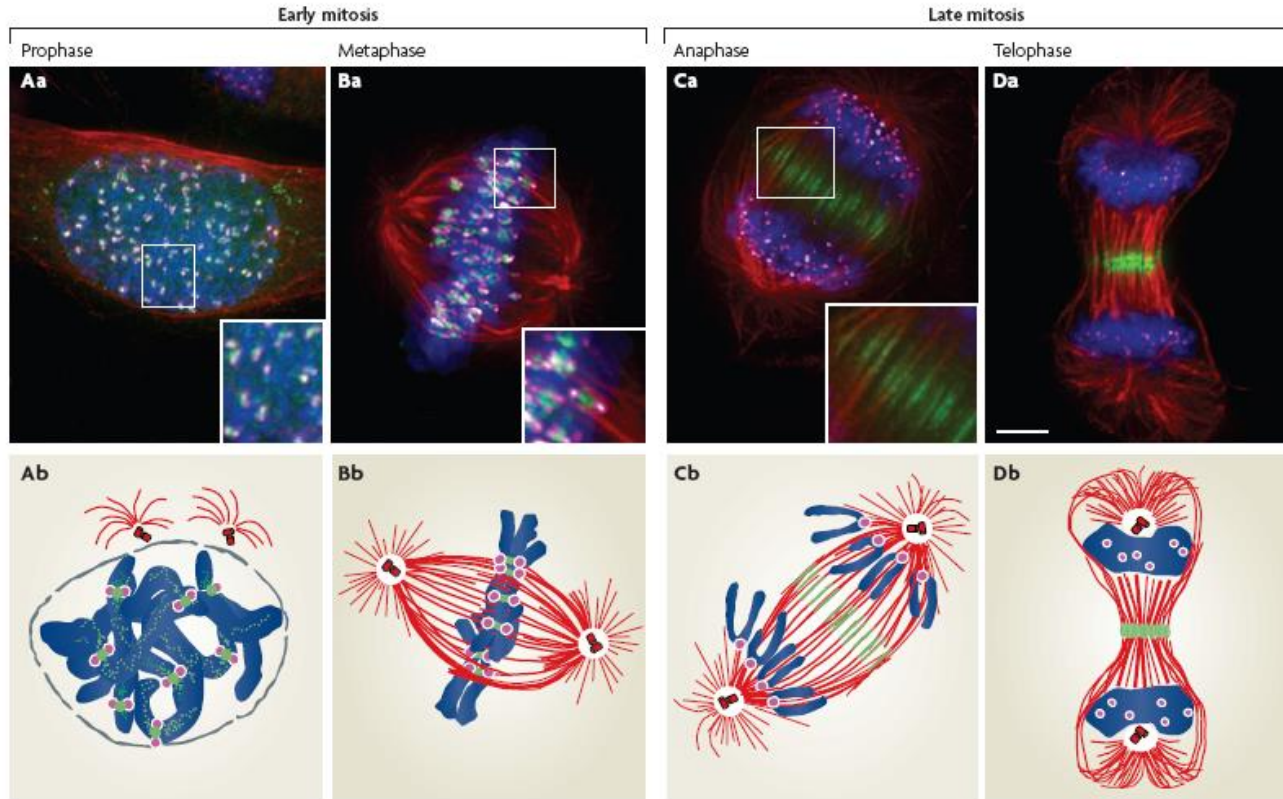

## Chromosomal bi-orientation on a bipolar mitotic spindle

Accurate chromosome segregation requires that kinetochores from each sister chromatid bind microtubules that emanate from opposing spindle poles (amphitelic attachment). This is achieved by a process called chromosome bi-orientation. Incorrect attachments can lead to improper chromosome segregation and aneuploidy.

# Centromeres and microtubules (monocentric chromosomes)

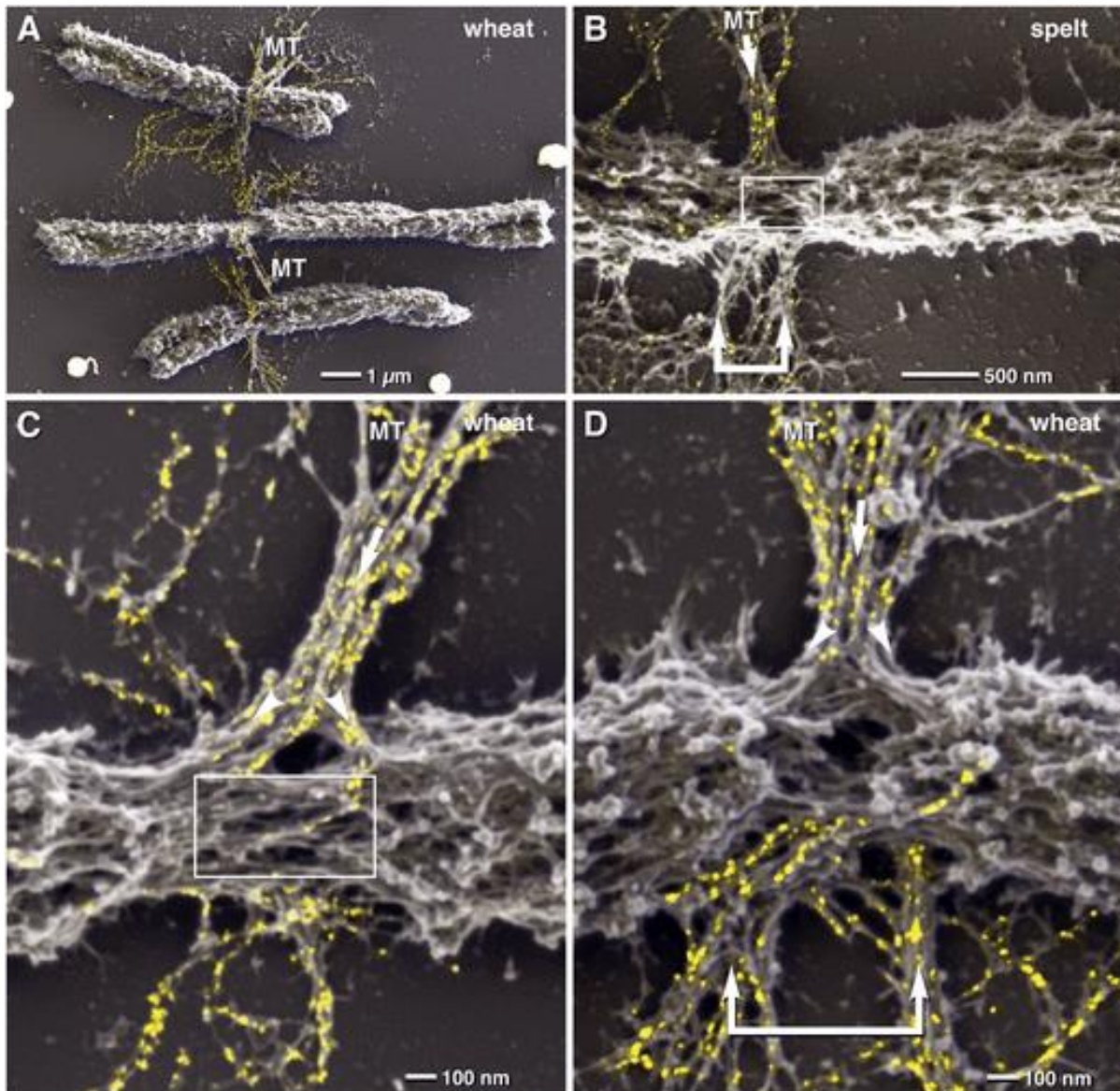

# Kinetochores

**inner kinetochore** - associated with the centromere DNA; specialized form of chromatin persistent throughout the cell cycle

**outer kinetochore** - interacting with microtubules; functional only during cell division.

Even the simplest kinetochores consist of more than 45 different proteins!

Many conserved between eukaryotic species, including a specialized histone H3 variant (called **CENP-A** or **CenH3**) which helps the kinetochore associate with DNA.

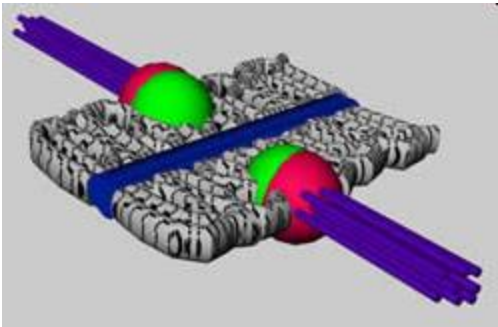
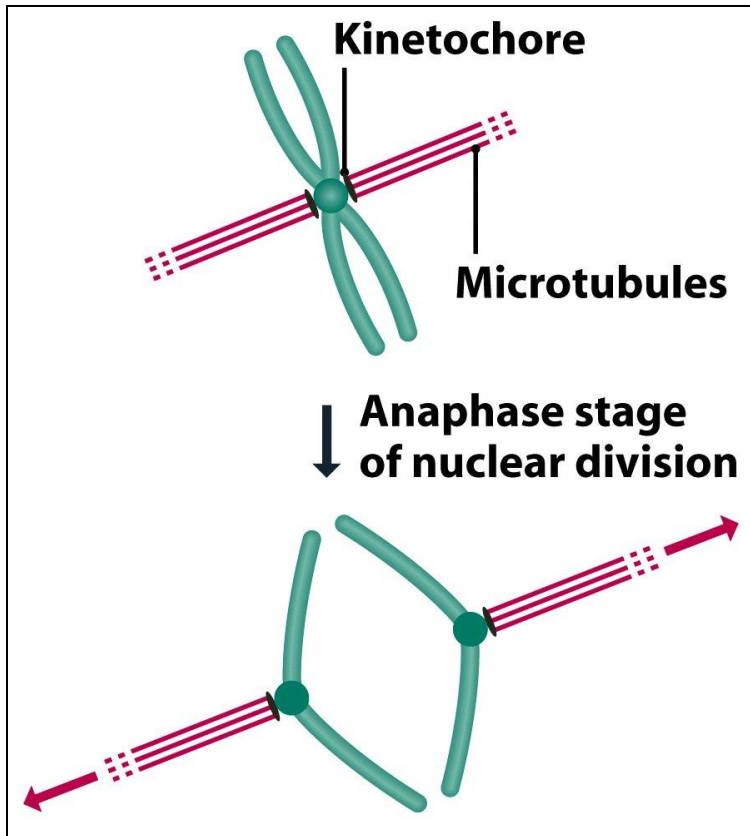

# Kinetochores

Mitosis in barley (immunofluorescence)

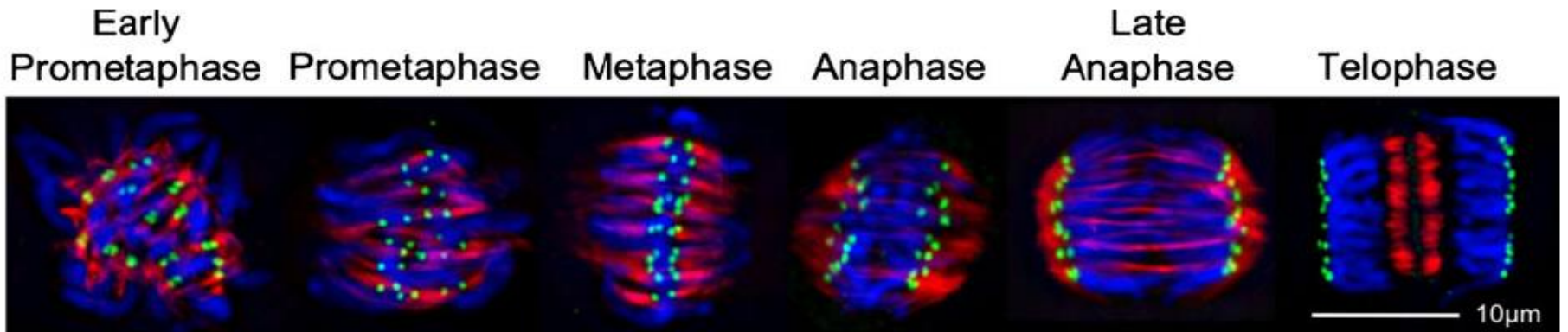

Microtubules (tubulin)

CENH3 (an inner kinetochore protein)

Chromosomes

Microtubules interact with kinetochores even in the earliest stages of prometaphase (immediately following nuclear envelope breakdown).

# The overall chromatin structure of the centromere is conserved among different species

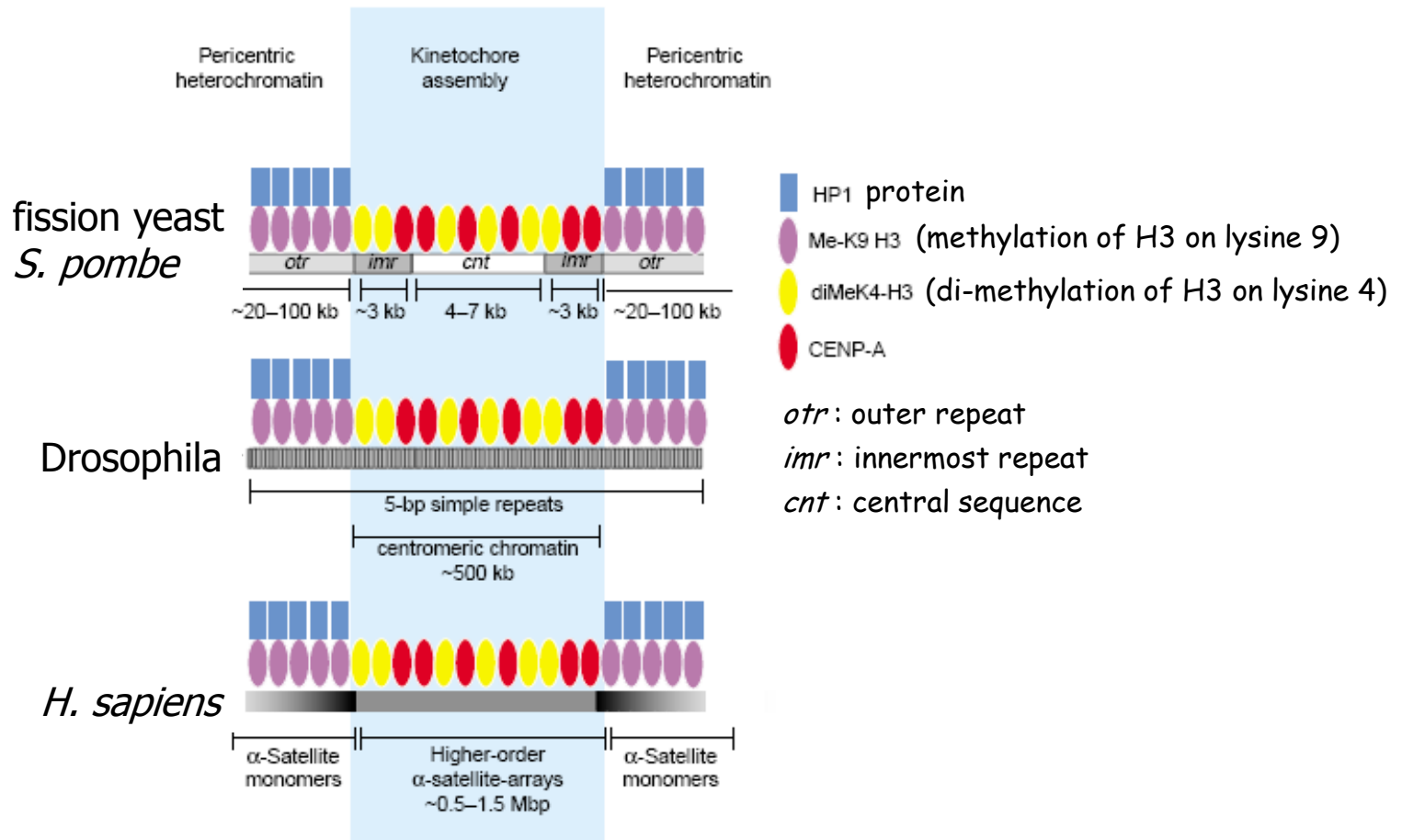



# Structure of plant centromeres

In monocentric chromosomes, the centromere is characterized by a single CenH3-containing region within a morphologically distinct primary constriction. This region usually spans up to a few Mbp composed mainly of centromere-specific satellite DNA.

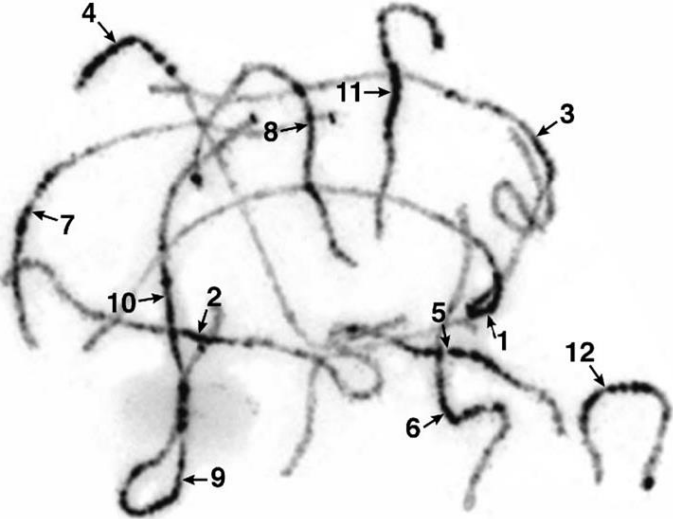

centromere of rice chromosome 3

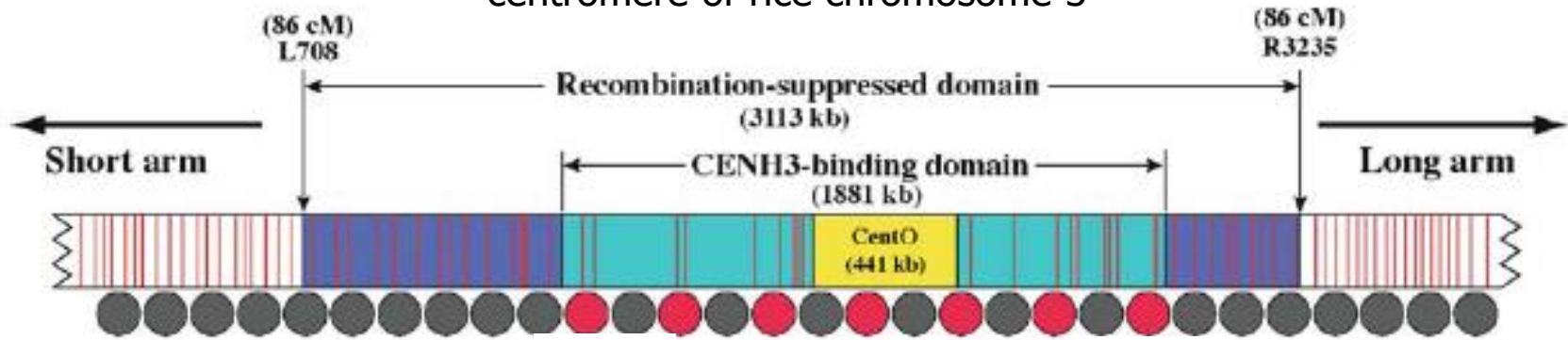

The CENH3-binding domain contains active genes (**red bars**), but with a lower density than the flanking domains.

CENH3 (CENP-A)-associated and H3-associated nucleosomes

Rice centromeres contain a **satellite repeat CentO** and **centromere-specific retrotransposon CRR**.

# Pea: monocentric chromosomes with multiple centromere domains

- long primary constrictions that contain 3-5 explicit CenH3-containing regions
- the size of the chromosome segment delimited by two outermost domains varies between 69 Mbp and 107 Mbp (several factors larger than any known centromere length)
- 13 distinct families of satellite DNA and one family of centromeric retrotransposons (unevenly distributed among pea chromosomes)

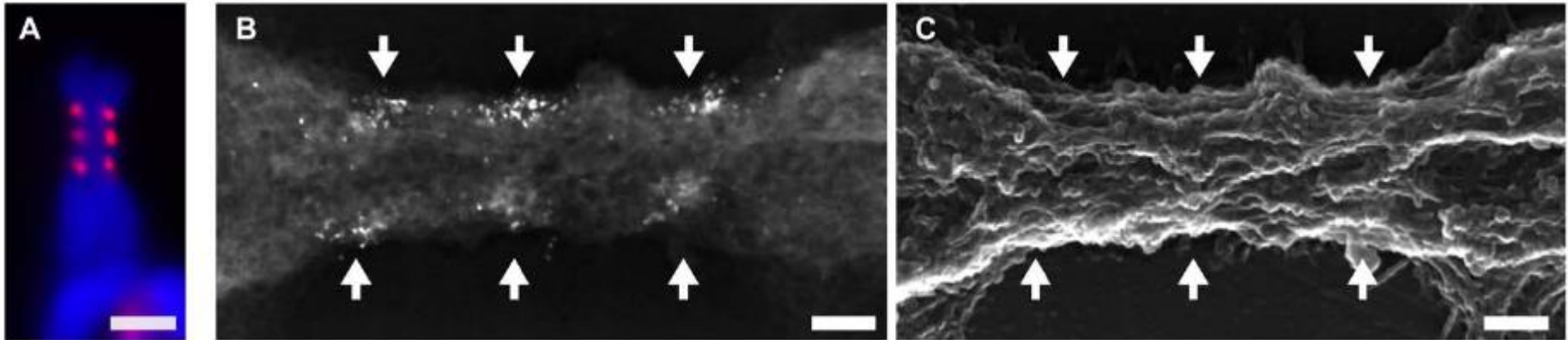
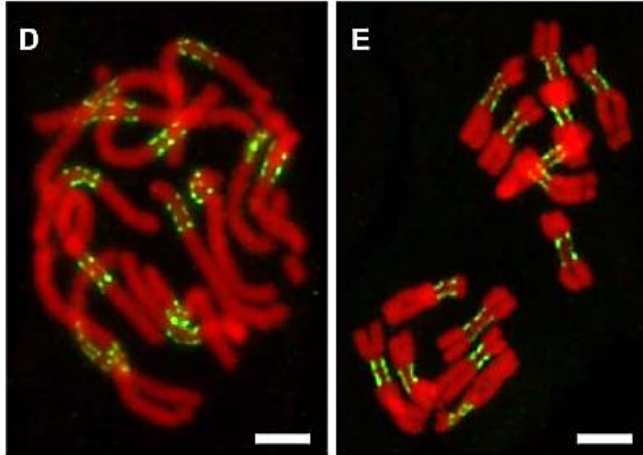

# Holokinetic Chromosomes Do Not Possess a Localized Centromere

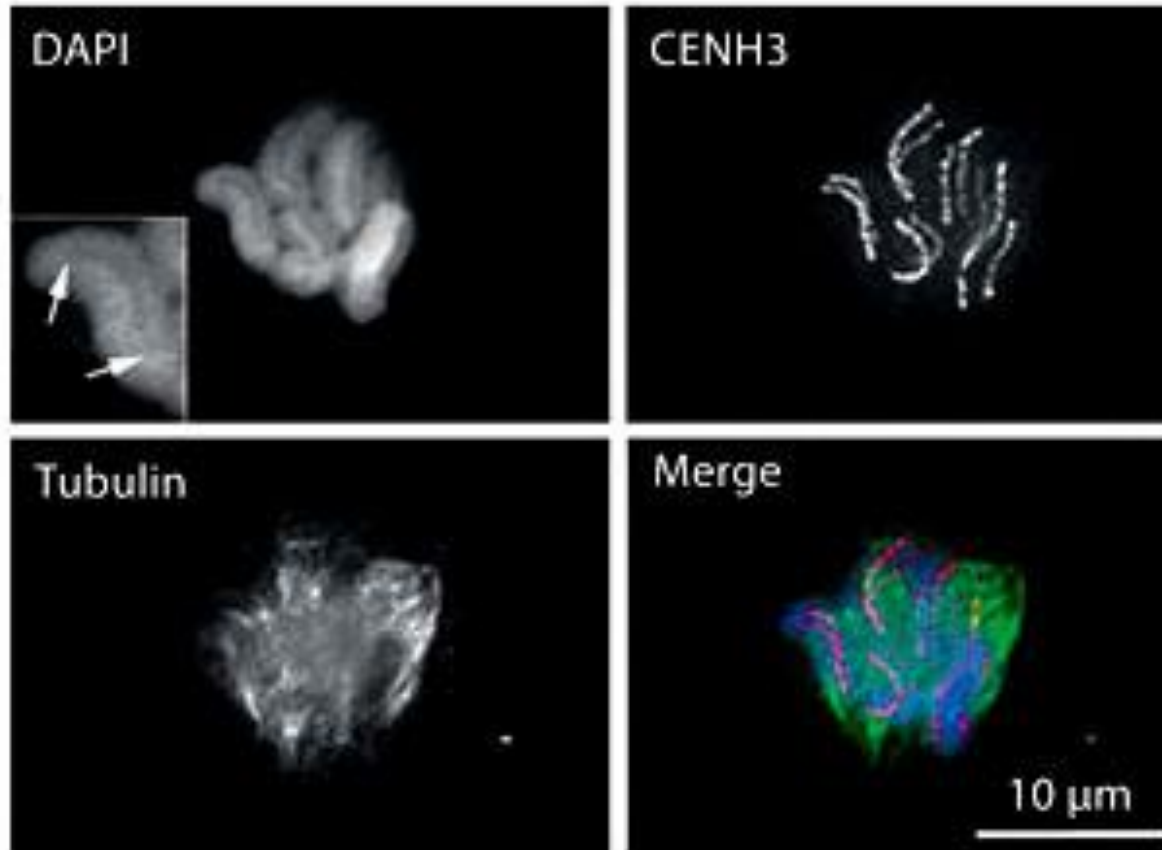

# Chromosomes with more than one centromere: consequences and solution

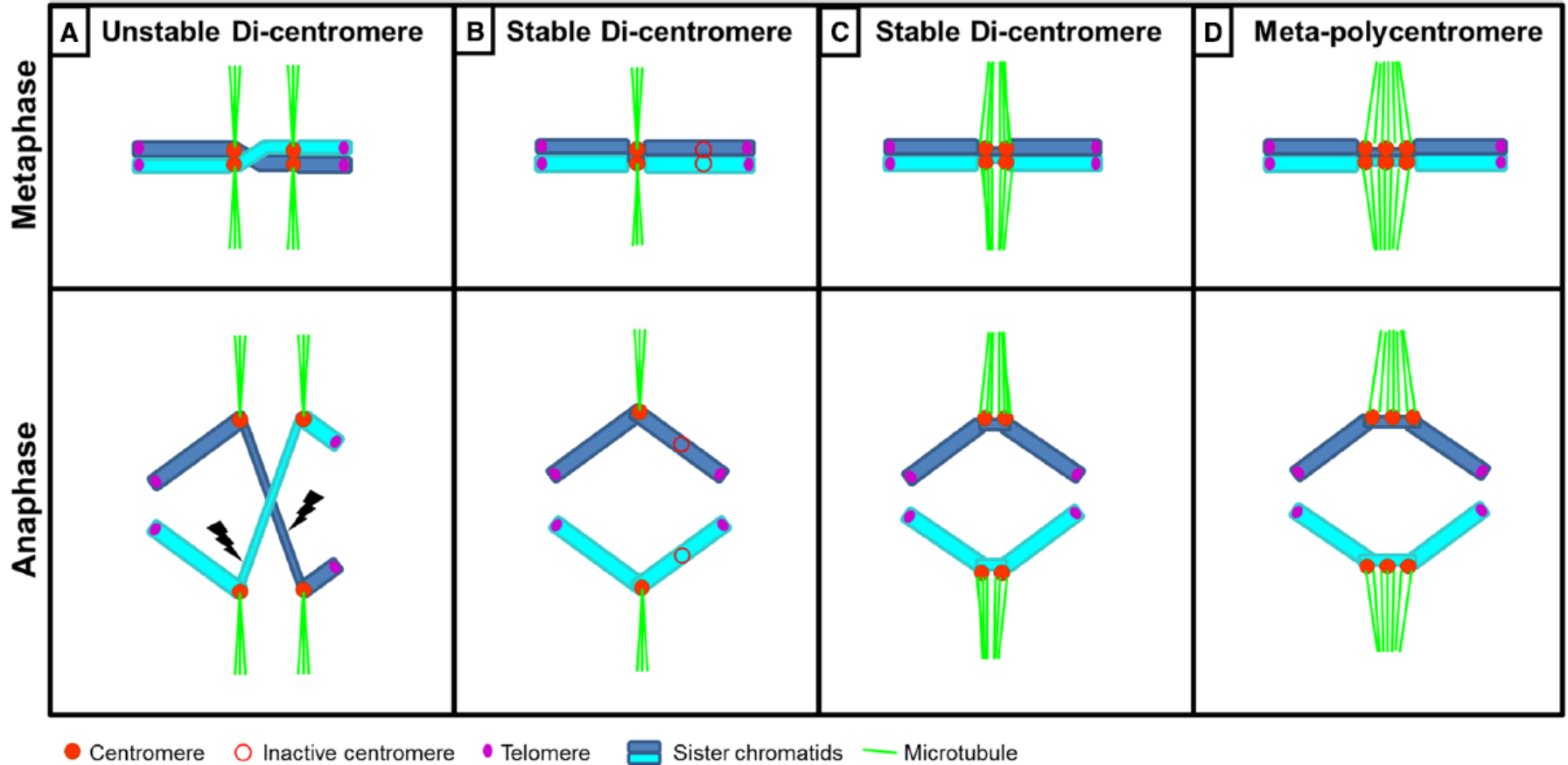

# Neocentromeres

Two meanings in literature:

- a de novo centromere formation occurring after chromosome breakage or endogenous centromere inactivation
- kinetic motility of terminal or subterminal heterochromatin, which is pulled to the cell poles during meiosis in plants (heterochromatic knobs)

# Formation and behavior of de novo centromeres

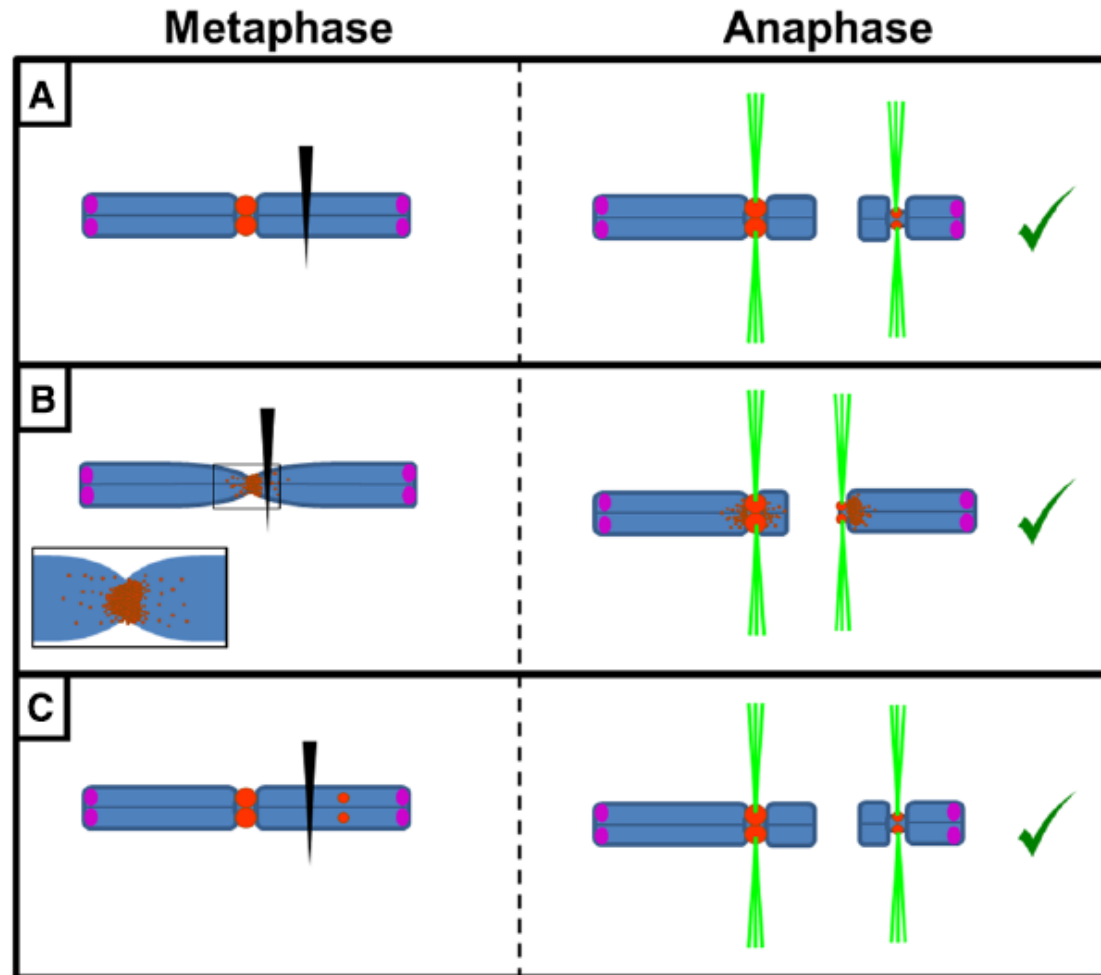

● Centromere ● Telomere ■ Chromatid — Microtubule  
● Neocentromere ■ Centromere mark, e.g. cenH3

# De novo centromere formation on a chromosome fragment in maize

Shulan Fu<sup>a,1</sup>, Zhenling Lv<sup>a,1</sup>, Zhi Gao<sup>b,1</sup>, Huajun Wu<sup>c</sup>, Junling Pang<sup>c</sup>, Bing Zhang<sup>a</sup>, Qianhua Dong<sup>a</sup>, Xiang Guo<sup>a</sup>, Xiu-Jie Wang<sup>c</sup>, James A. Birchler<sup>b,2</sup>, and Fangpu Han<sup>a,2</sup>

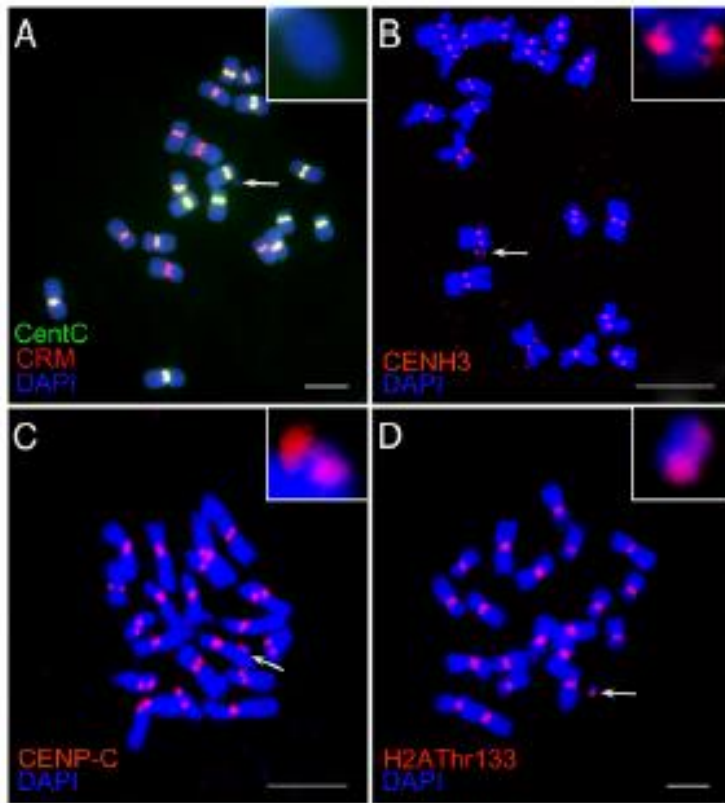

The small chromosome has no detectable canonical centromeric sequences, but contains a site with protein features of functional centromeres such as CENH3, the centromere specific H3 histone variant, and CENP-C, a foundational kinetochore protein, suggesting the de novo formation of a centromere on the chromatin fragment.



# A Model of Centromere Evolution



The satellite repeat may be derived from other centromeres, such as rice *Cen8*, or a new repeat, such as potato *Cen9*.

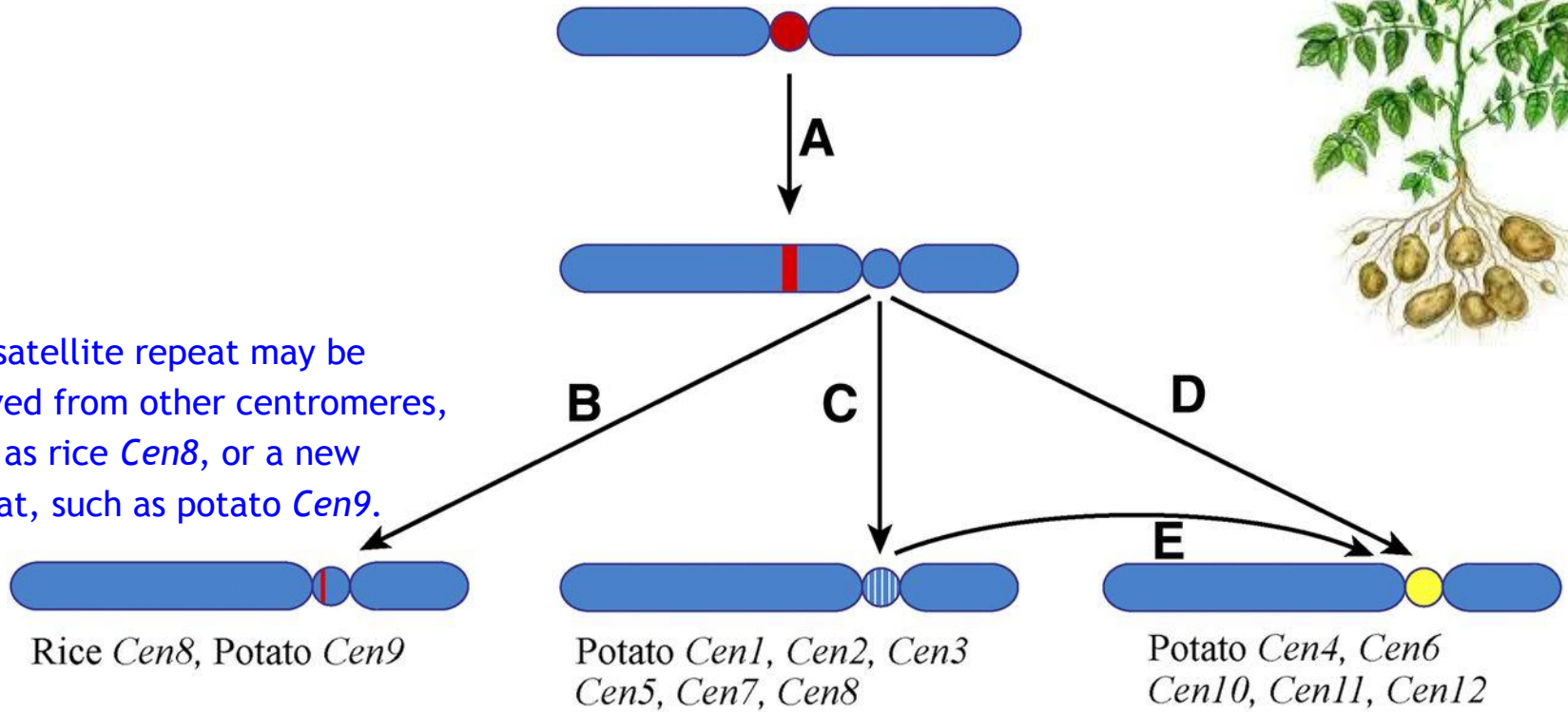

Centromeres may survive for several million years without satellite repeat invasion (slow evolution through DNA mutations and accumulation of transposable elements).

A de novo DNA amplification of a satellite repeat, possibly based on an eccDNA-mediated mechanism, and insertion of the repeat (yellow) in the CENH3 domain can turn an evolutionarily new centromere into a repeat-based centromere.



# A model of neocentromere-mediated centromere evolution in plants (rice)

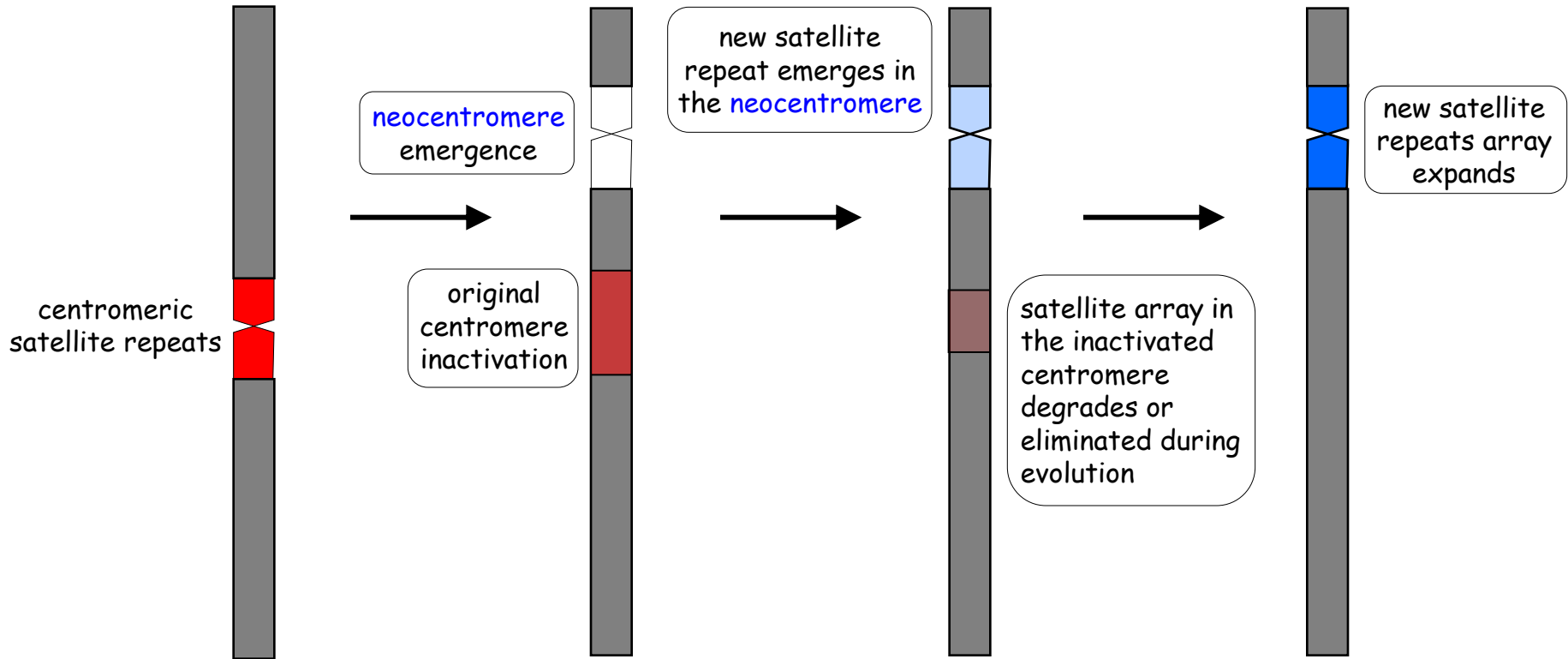

# Centromere repositioning in curbit species

- centromere repositioning (CR) extensively documented in mammalian species (e.g. 5 CRs in the donkey after its divergence from zebra)
- scarce reports on CR in other eukaryots including plants
- centromeres of cucumber and melon chromosomes are associated with distinct pericentromeric heterochromatin
- centromere activation or inactivation were associated with a gain or loss of a large amount of pericentromeric heterochromatin



*Cucumis melo*  
 $2n = 24$



*Cucumis sativus*  
 $2n = 14$



# Centromere repositioning in curbit species

Cross-species **fosmid** FISH in cucumber and melon (*Cucurbitaceae*)

**Fosmids** (40 kb) are based on the bacterial F-plasmid. The cloning vector is limited, as a host (usually *E. coli*) can only contain one fosmid molecule. Low copy number offers higher stability than comparable high copy number cosmids.

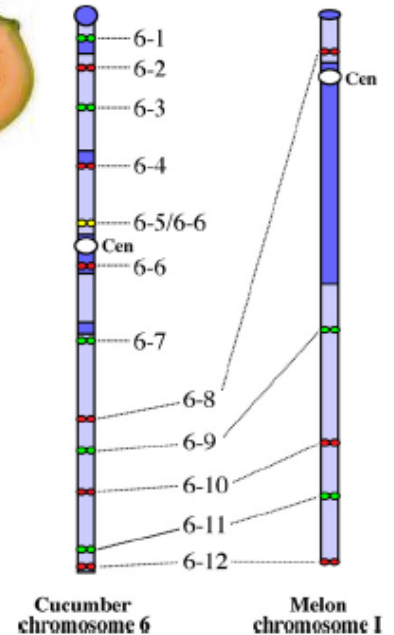
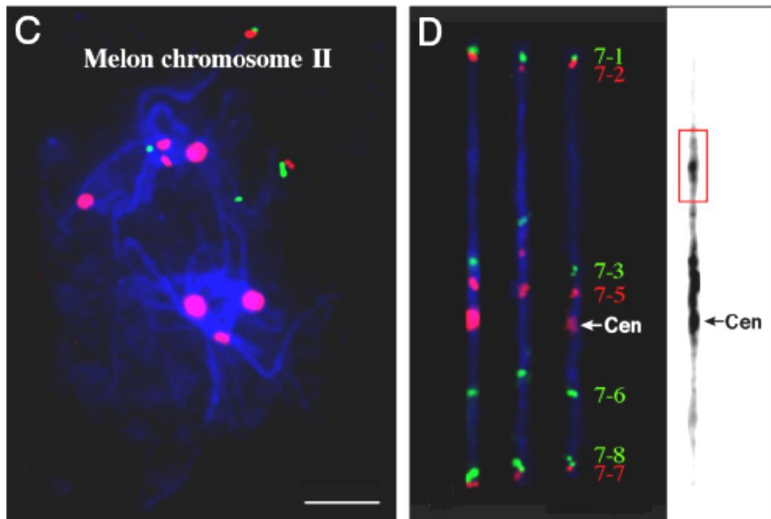
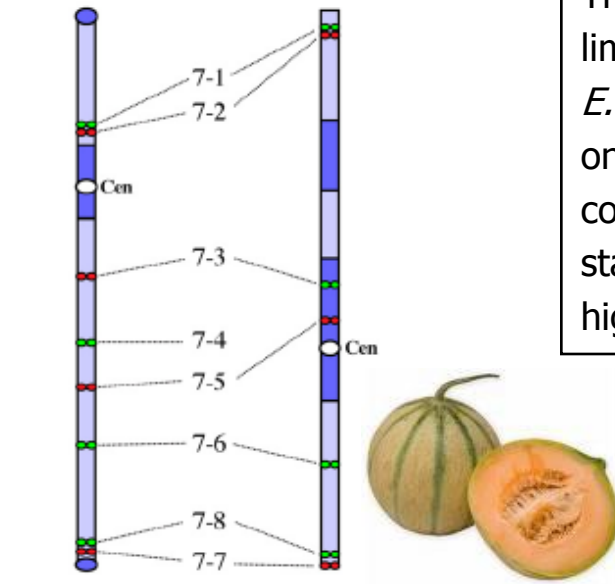
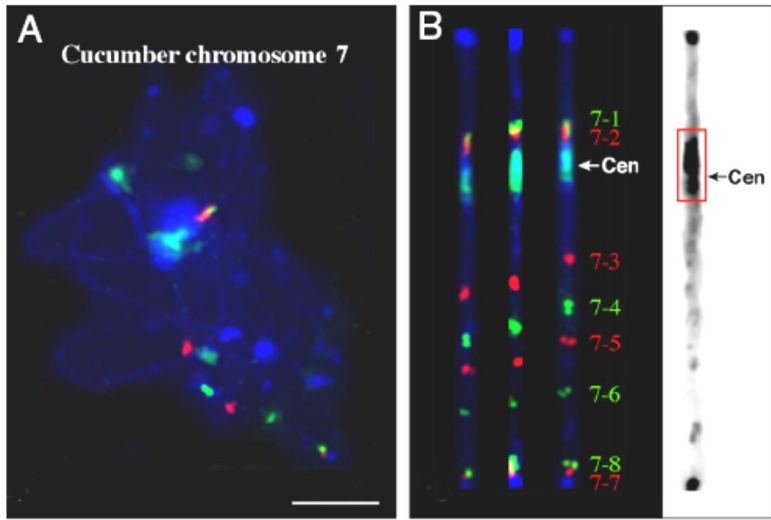



# *Arabis alpina* - centromere repositioning

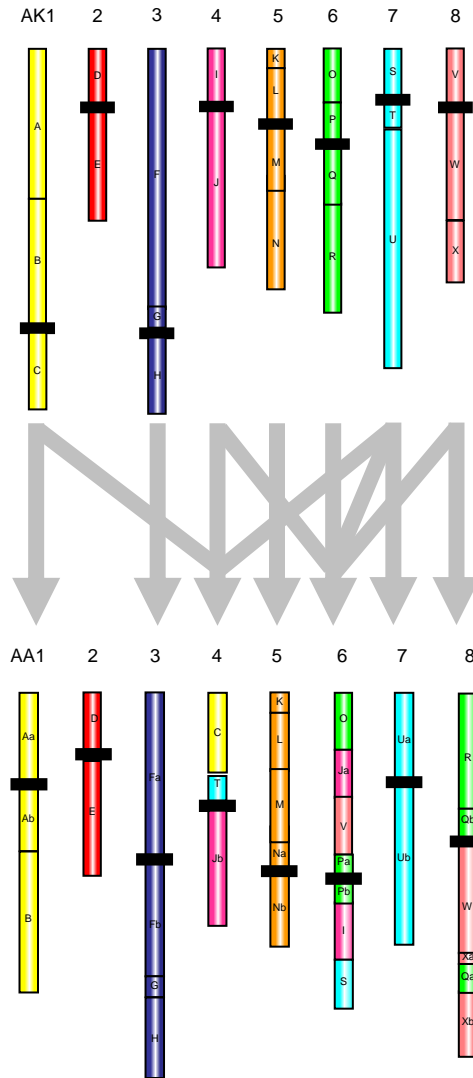

5 reciprocal translocations

4 pericentric inversions

**3 centromere repositions**

1 centromere loss

1 new centromere emergence (?)

# CHROMOSOME CAPS

Telomeres form protective caps at the ends of chromosomes, and are built from a repeating DNA sequence constructed by the enzyme telomerase.

## Telomeres

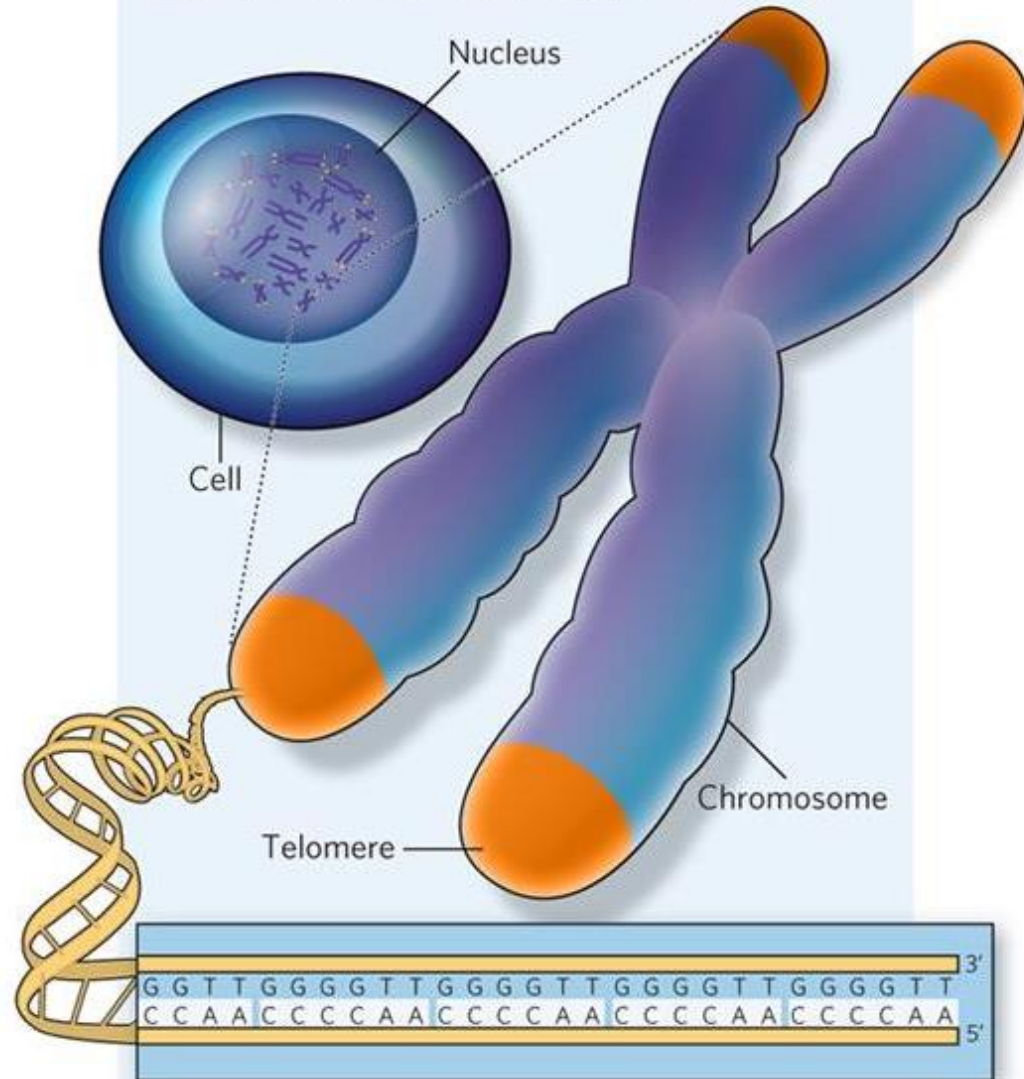

The DNA sequence shown is from the *Tetrahymena* telomere.

# Telomeres



Elizabeth H. Blackburn



Carol W. Greider



Jack W. Szostak

**The Nobel Prize in Physiology or Medicine 2009** was awarded jointly to Elizabeth H. Blackburn, Carol W. Greider and Jack W. Szostak *"for the discovery of how chromosomes are protected by telomeres and the enzyme telomerase"*.

# Telomeres

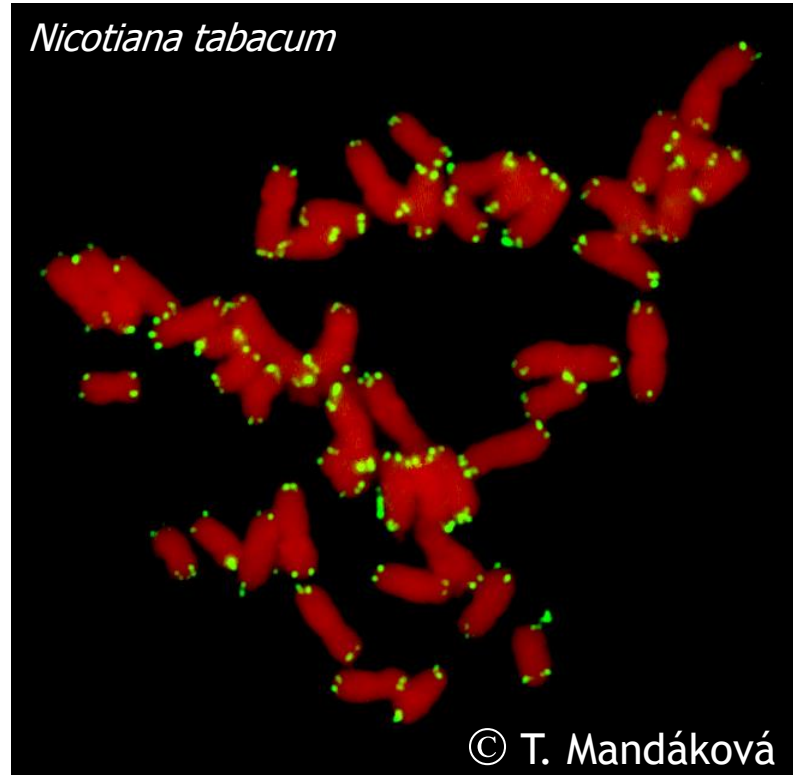

# Keywords on telomeres

- solving chromosome shortening (loss of DNA sequences)
- protects against DNA repair (repair of double-strands)
- evolutionary conserved telomeric repeats
- telomere-binding proteins (shelterin complex)
- synthesis by the telomerase enzyme

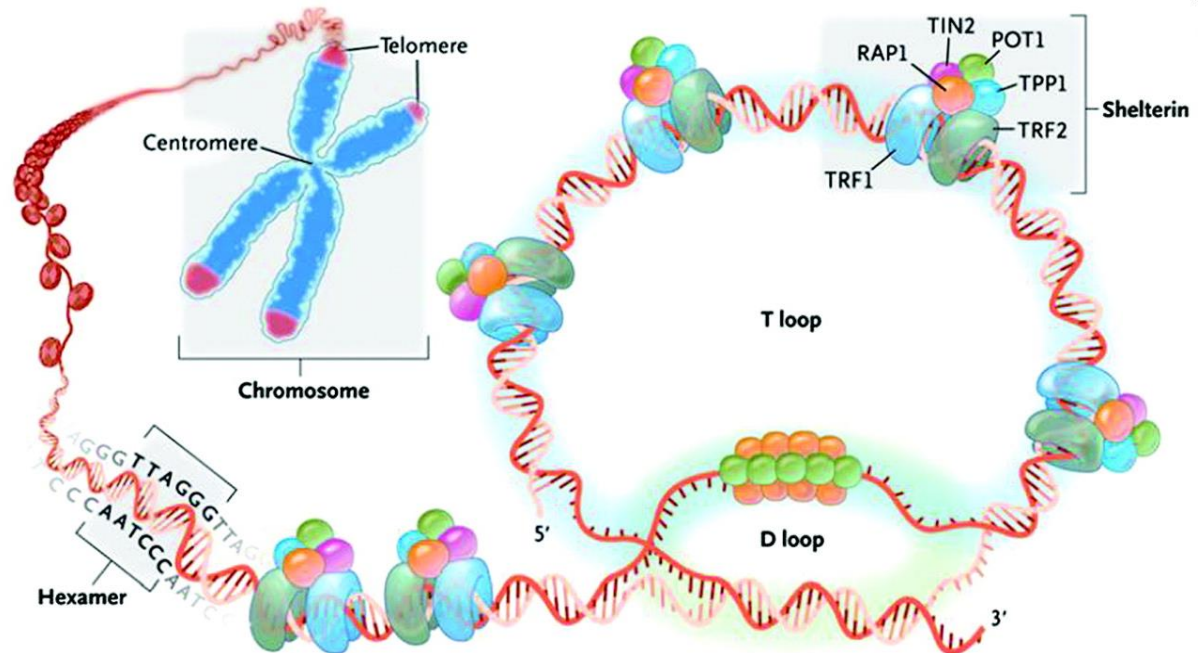
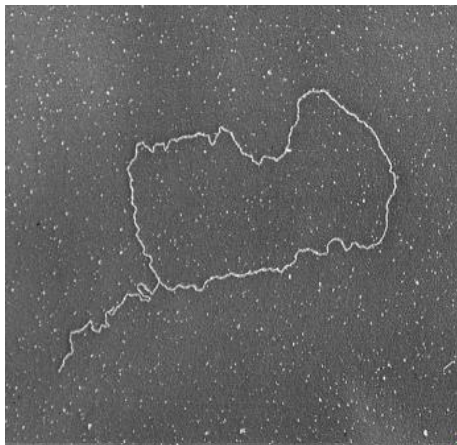
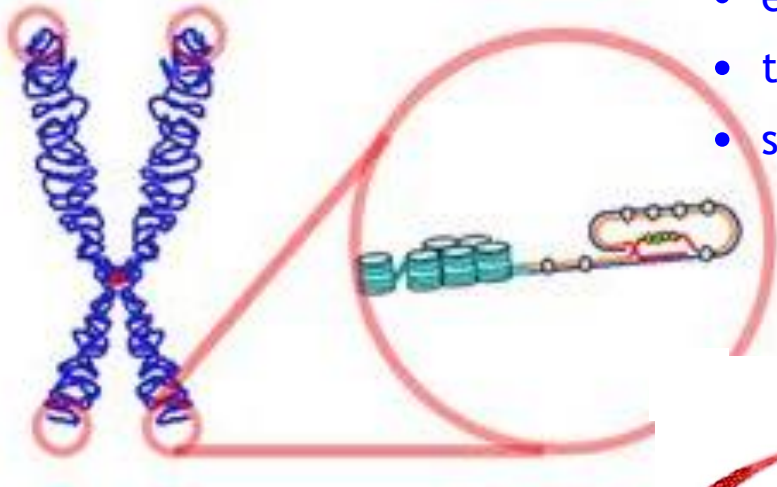





# Telomeres of plants

Sequences of telomere repeats

human TTAGGG

*Tetrahymena* TTGGGG

*Arabidopsis* TTTAGGG

mutation altering the RNA template subunit of telomerase, c. 80 million years ago

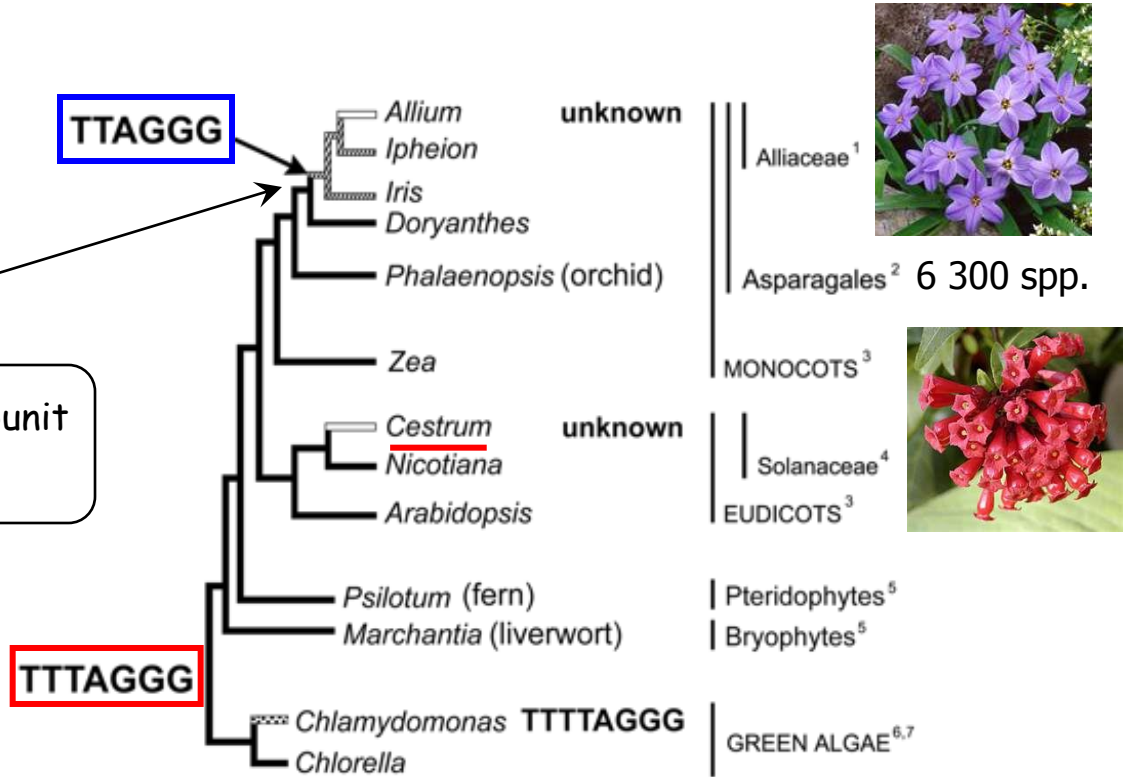

# Telomeres - when something goes wrong

telomere dysfunction → ring chromosomes

*Wikipedia:*

**Human genetic disorders** can be caused by spontaneous ring chromosome formation; although ring chromosomes are very rare, they have been found in nearly all human chromosomes.

Disorders arising from the formation of a ring chromosome include **ring chromosome 20 syndrome** where a ring formed by one copy of chromosome 20 is associated with **epilepsy**; ring chromosome 14 and ring chromosome 13 syndrome are associated with **mental retardation** and **dysmorphic facial features**; ring chromosome 15 is associated with mental retardation, **dwarfism** and **microcephaly**. Ring formation of an X-chromosome causes **Turner syndrome**.

Symptoms seen in patients carrying ring chromosomes are more likely to be caused by the deletion of genes in the telomeric regions of affected chromosomes, rather than by the formation of a ring structure itself.

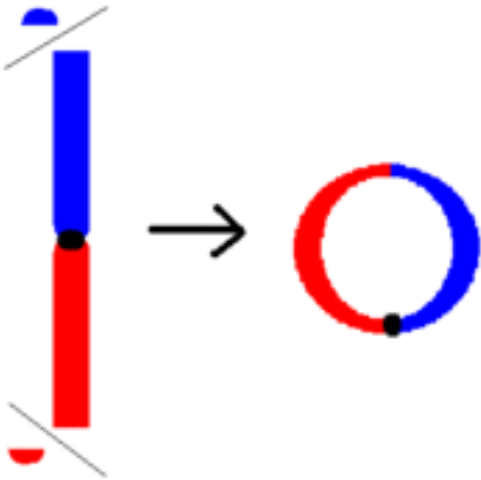

# Telomeres - when something goes wrong

In the absence of a protein protecting telomeres, chromosomes fuse abnormally

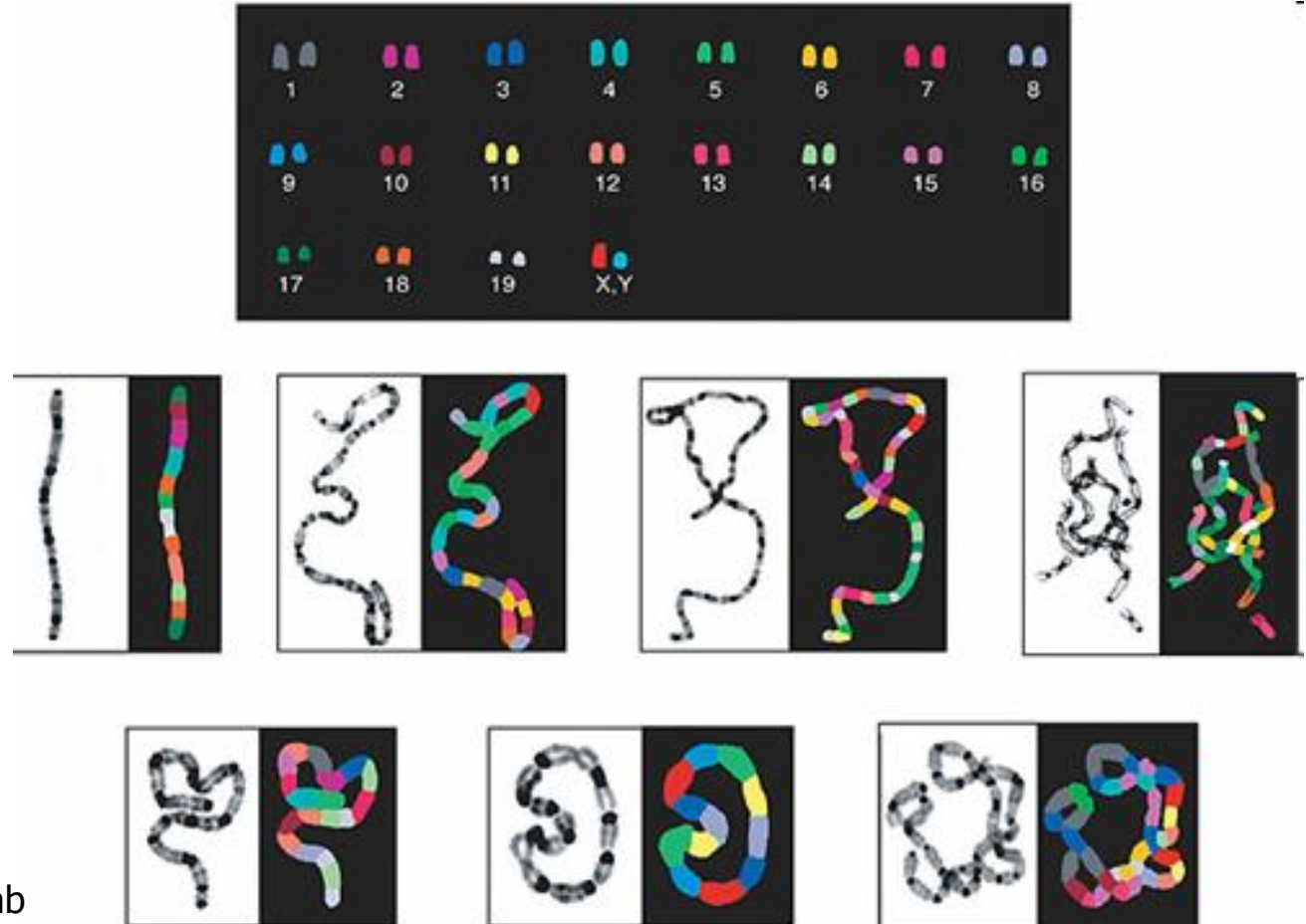

data from the T. De Lange lab

# Telomeres - when something goes wrong

## Breakage-fusion-bridge cycle

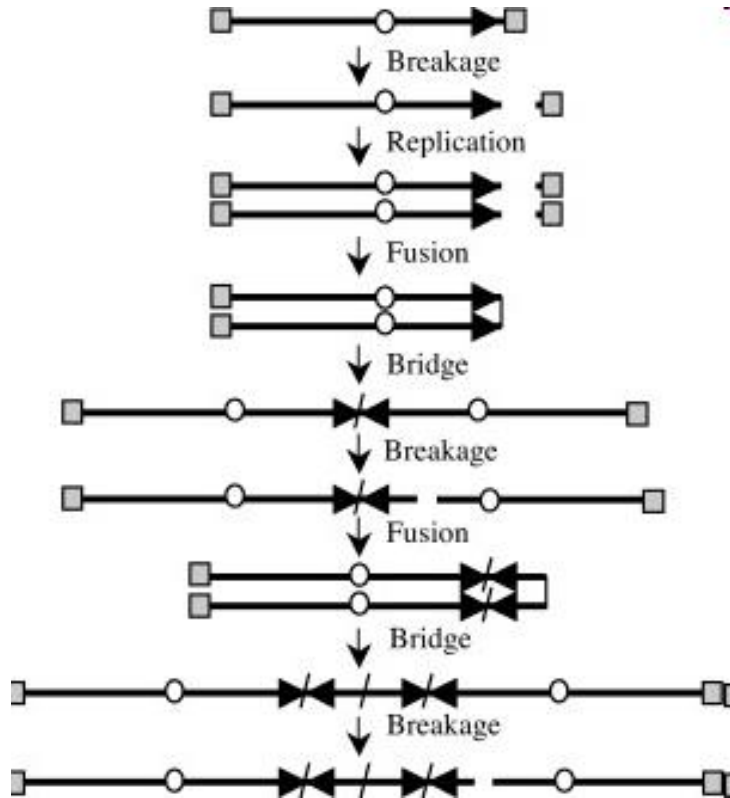

1. telomere dysfunction
2. sister chromatid fusion (2 centromeres)
3. bridge during anaphase
4. breakage

(breakage occurs at locations other than the site of fusion, resulting in large inverted repeats on the end of the chromosome in one daughter cell and a terminal deletion on the end of the chromosome in the other daughter cell)

5. fusion, bridge, breakage,...

... the B/F/B cycles will continue until the chromosome acquires a new telomere, most often by translocation

The telomeres (gray squares), centromeres (circles), subteleromic sequences (horizontal arrows)

# rDNA loci on chromosomes

rDNA = ribosomal DNA = genes coding ribosomal RNAs

- routinely detected by FISH
- diagnostic value, position and the number usually species-specific
- 45S rDNA usually in different position on chromosome(s) than 5S rDNA
- 45S formed at nucleolar organizing regions (NORs) associated with nucleolus

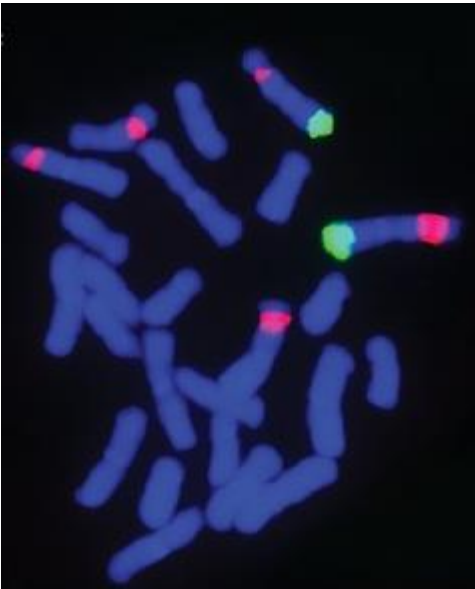

Physical mapping of 45S rDNA (red) and 5S rDNA (green) to metaphase chromosomes of *Larix leptolepis*. Chromosomes counterstained with DAPI (blue) (Zhang *et al.* 2010)

# Satellite (SAT) chromosomes, secondary constrictions

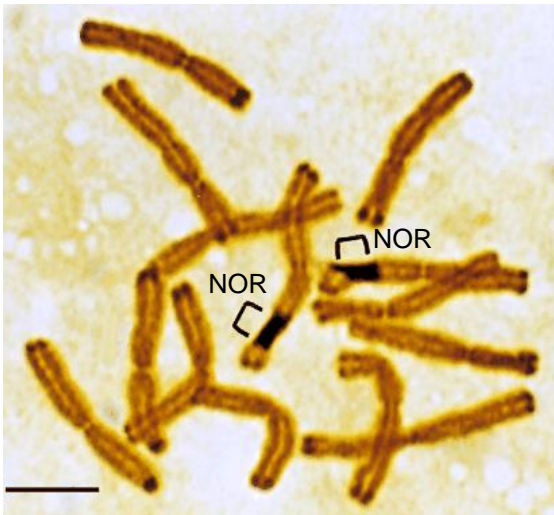
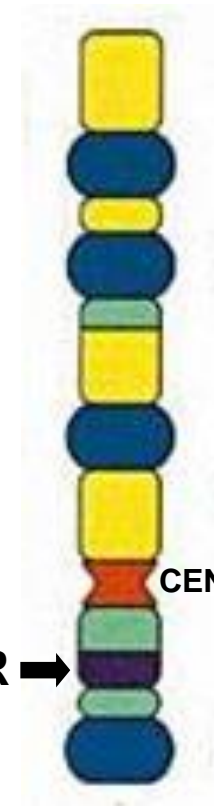
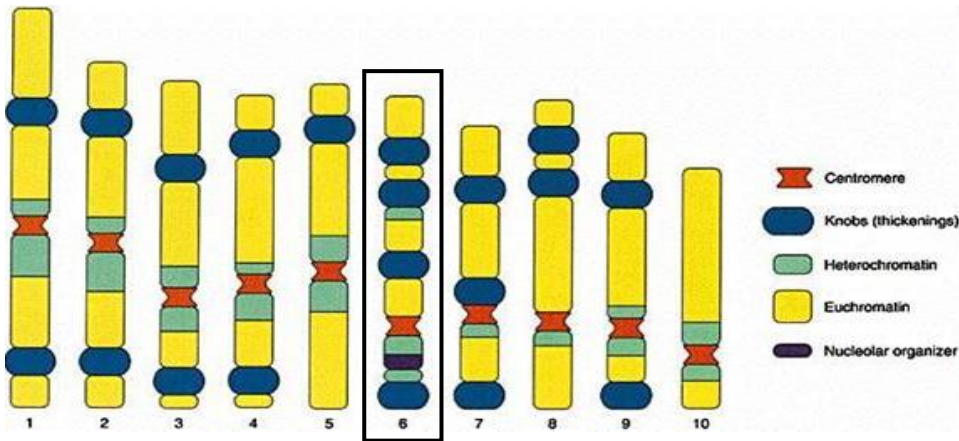

**Satellites** (different from satellite repeats), **satellite chromosomes**: chromosomes with nucleolar organizing region (NOR) = secondary constriction. Short chromosome part beyond the NOR is called a satellite (trabant).

**SAT chromosome**: *Sine Acid thymonucleinico* (without thymonucleic acid or DNA). Because of relative deficiency of DNA in the nucleolar organizing region, NORs show less intense staining.

# Nucleolus

- ribosomal DNA (rDNA = rRNA genes) is transcribed and ribosomes are assembled within the nucleolus

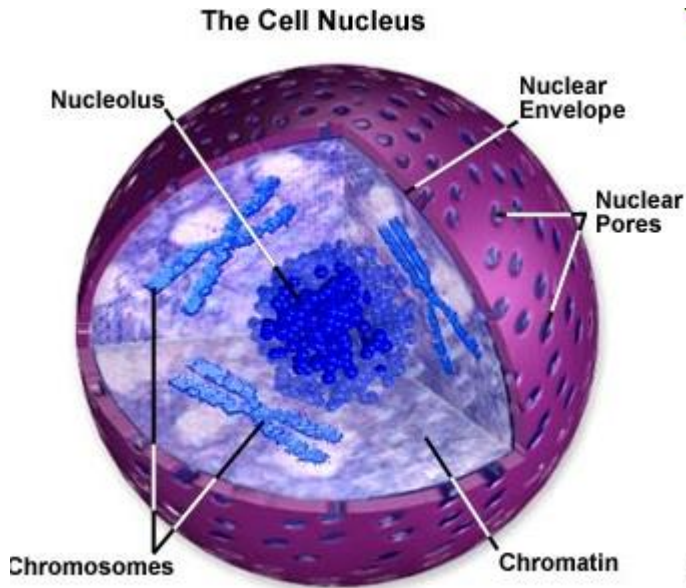

- ribosomes are exported to the cytoplasm. They remain free or associate with the endoplasmic reticulum (rough endoplasmic reticulum).

- one or several nucleoli in a nucleus

- after a cell division, a nucleolus is formed around nucleolar organizing region (NOR) on some chromosomes (chromosomes are brought together by nucleolar organizing regions)

- cell division: nucleolus disappears



# Chromosome territories in Arabidopsis: NOR-bearing chromosomes associated more frequently than all other chromosomes

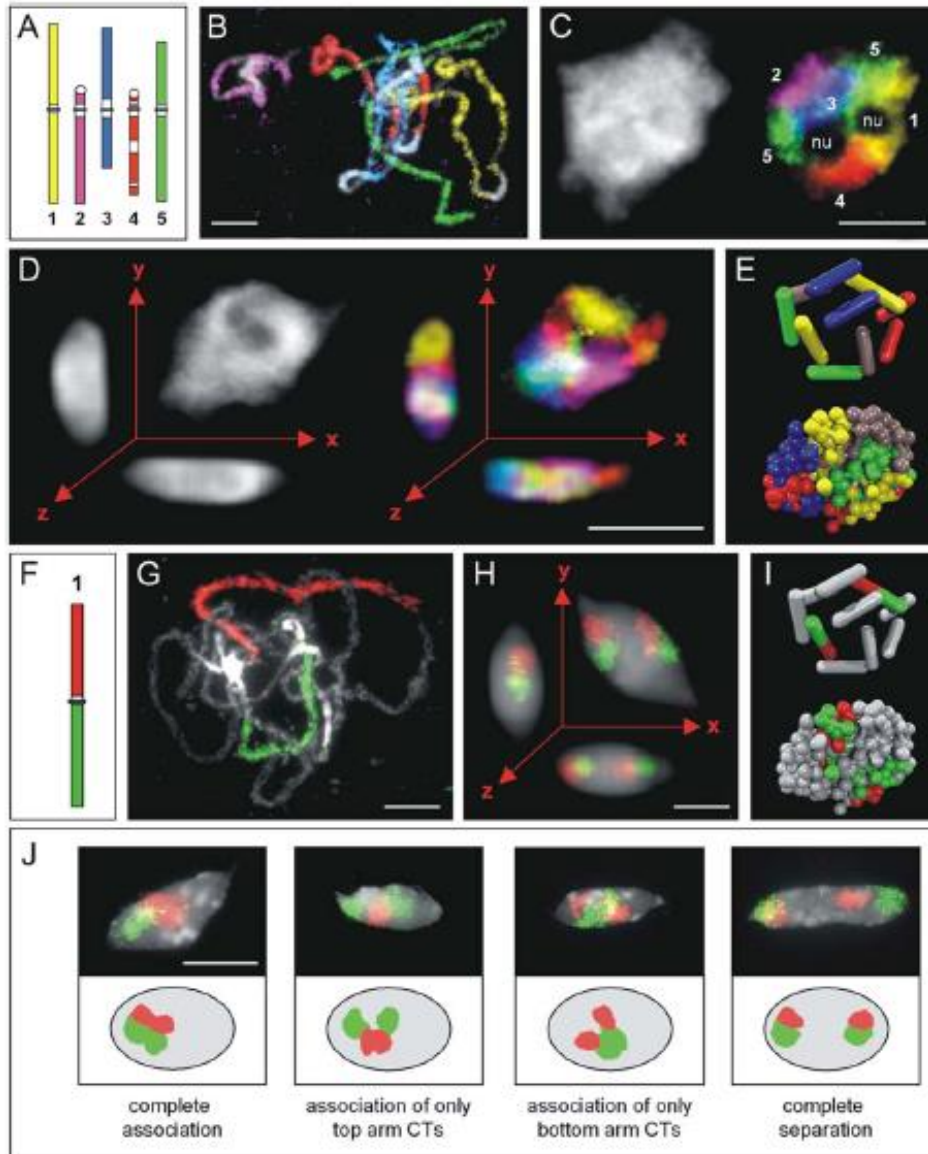

# 45S and 5S ribosomal DNA (rDNA)

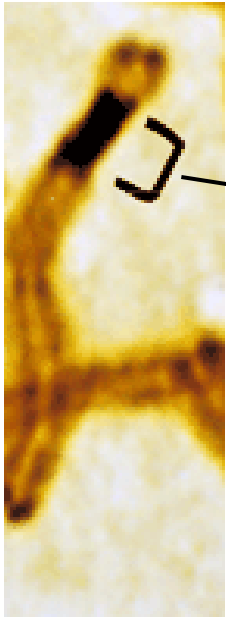

Structure of the 45S rDNA tandem repeat

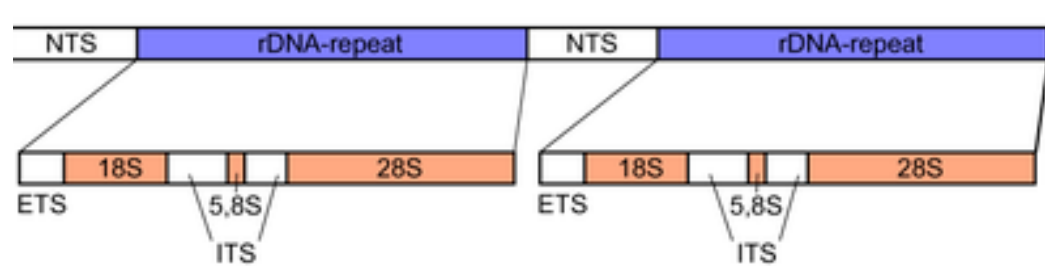

18S, 5.8S, and 28S - genes coding 18S, 5.8S, and 28S RNA molecules

NTS - nontranscribed spacer

ETS - external transcribed spacer

ITS - internal transcribed spacers 1 and 2

transcription of rDNA → 45S pre-rRNA → processing → 18S RNA, 5.8S and 28S RNA molecules

**Ribosomes** - proteins and RNA molecules. In eukaryotes, small (40S) and large (60S) subunit. The 18S rRNA in the small subunit, large subunit contains 3 rRNA types (5S, 5.8S, and 28S rRNA).

In eukaryotes, the 5S rRNA gene is separated from the 45S rRNA genes. But together in *Artemisia*, gymnosperms, and some other plants.

# Heterochromatin and heterochromatic knobs

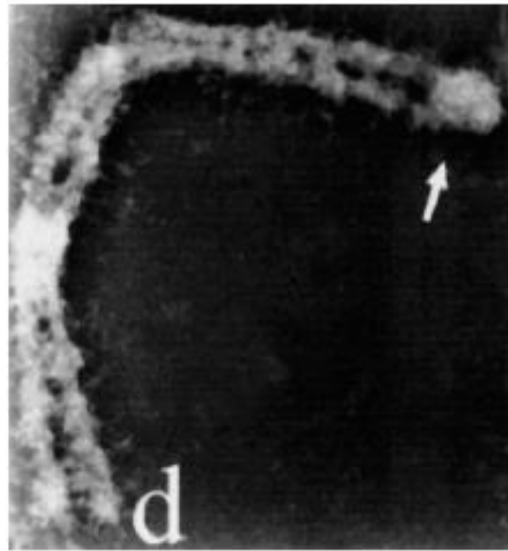

## Het knobs are located on chromosomes:

- a) terminally
- b) interstitially
- c) at pericentromeres



meiotic (pachytene) chromosomes of *Antirrhinum*

# Het knobs in *Brassicaceae* species

*Myagrum perfoliatum*

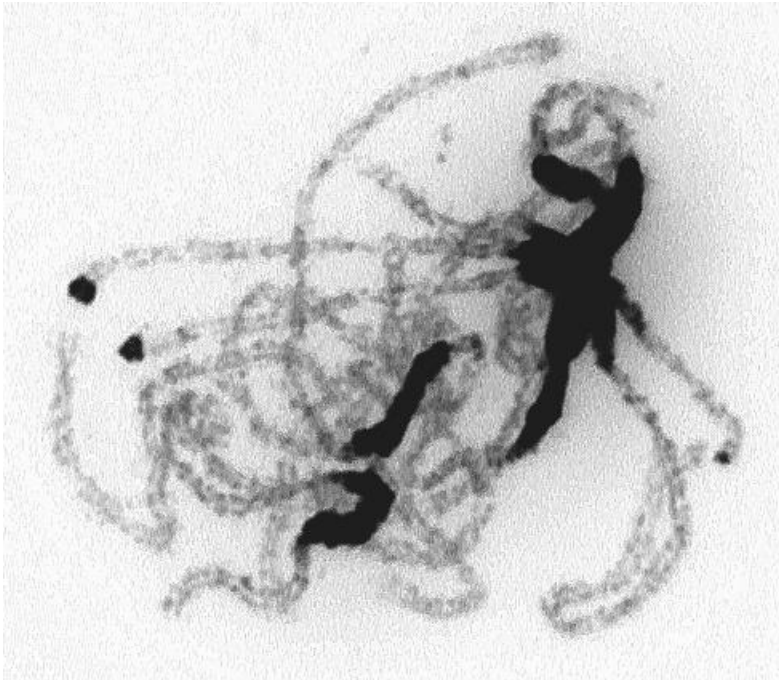

*Thellungiella halophila*

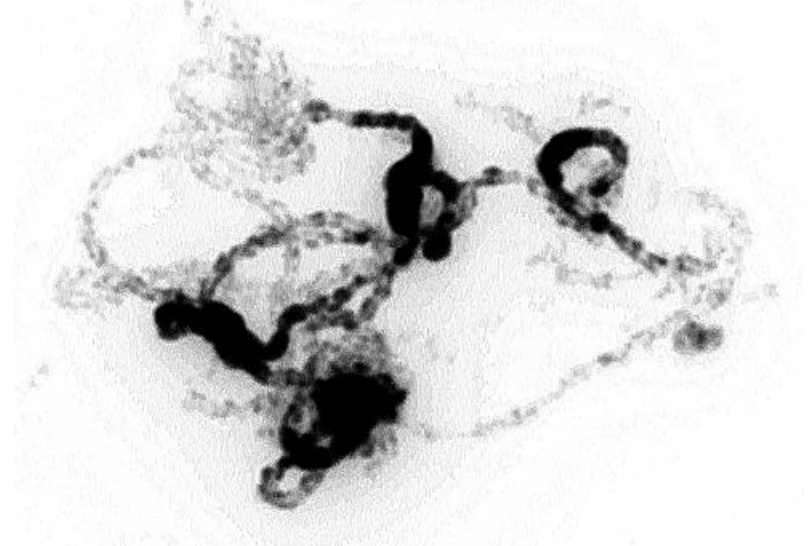

# Het knobs in rice

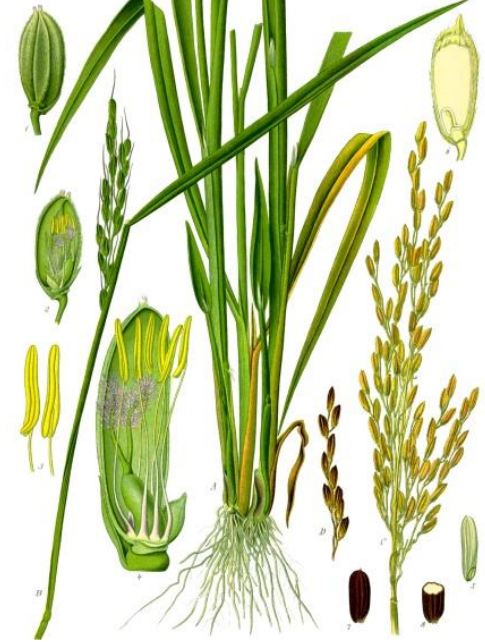
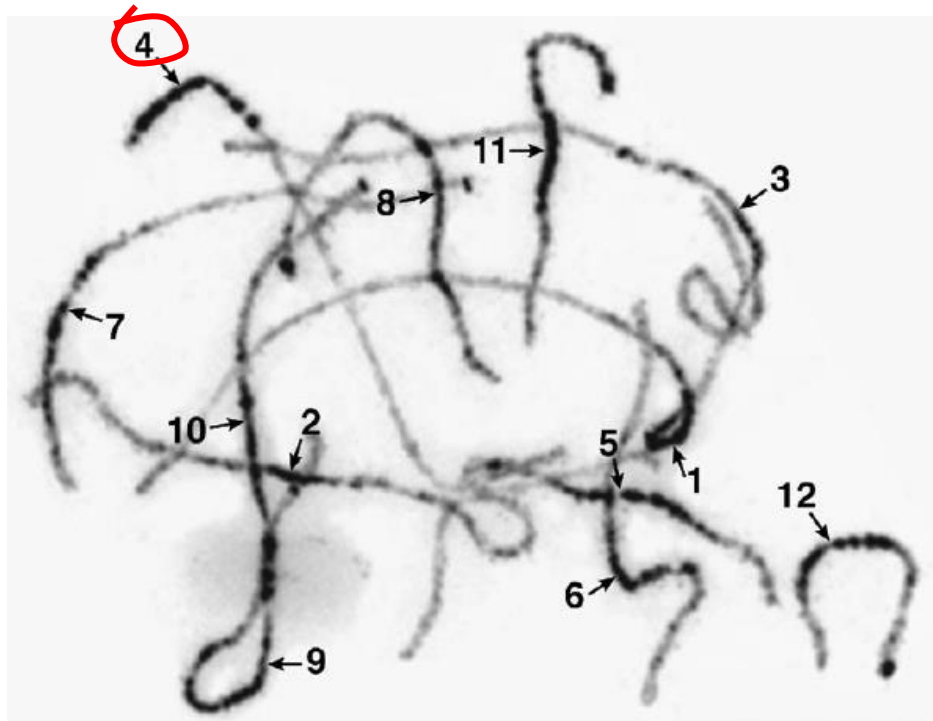

rice chromosome 4

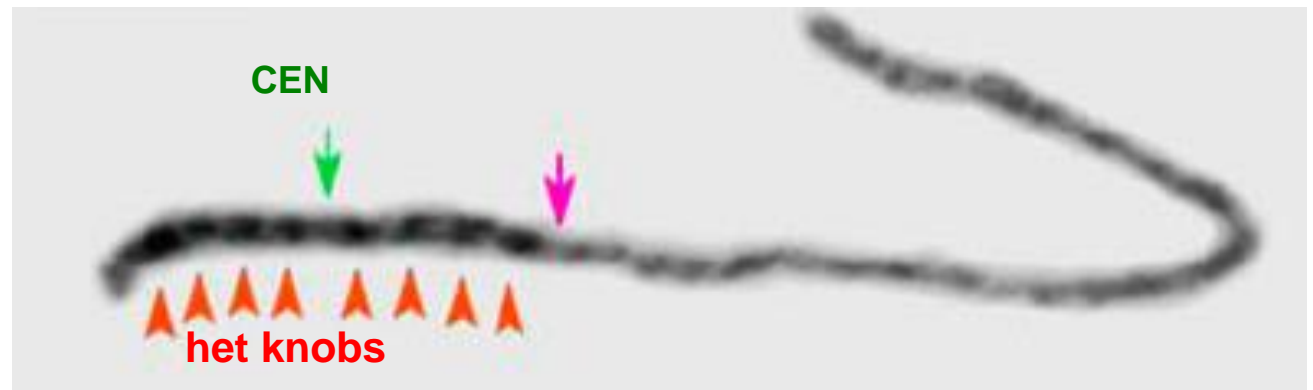

Jiao et al. 2005, *Plant Cell* 17

# Heterochromatic segment 1 found in *Brachycome dichromosomatica* (Asteraceae)

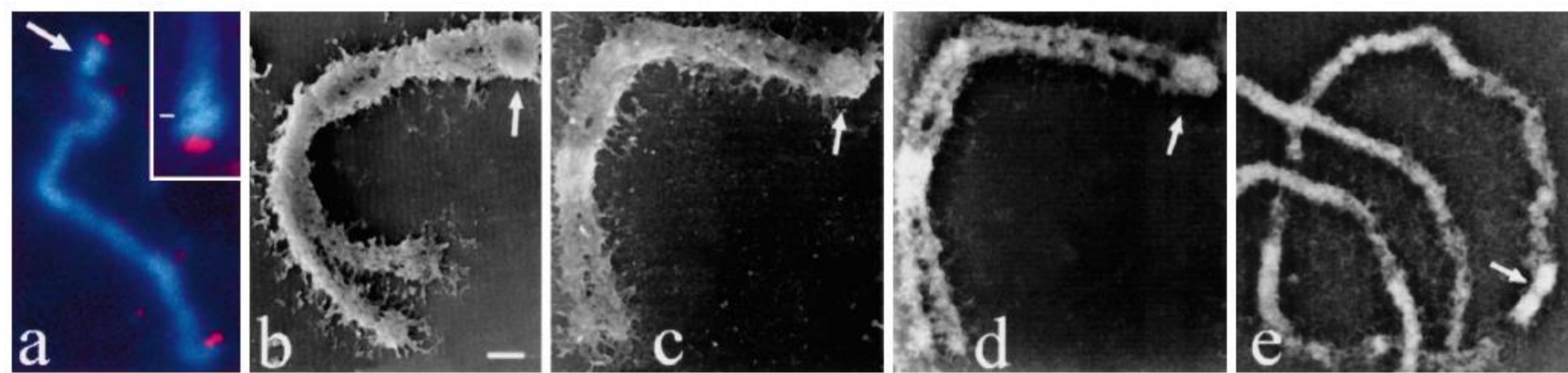

The terminal knob contains the Bds1 tandem repeat.

# Large Heterochromatin Knobs (Segments) in *Ballantinia antipoda*

174-bp satellite repeat

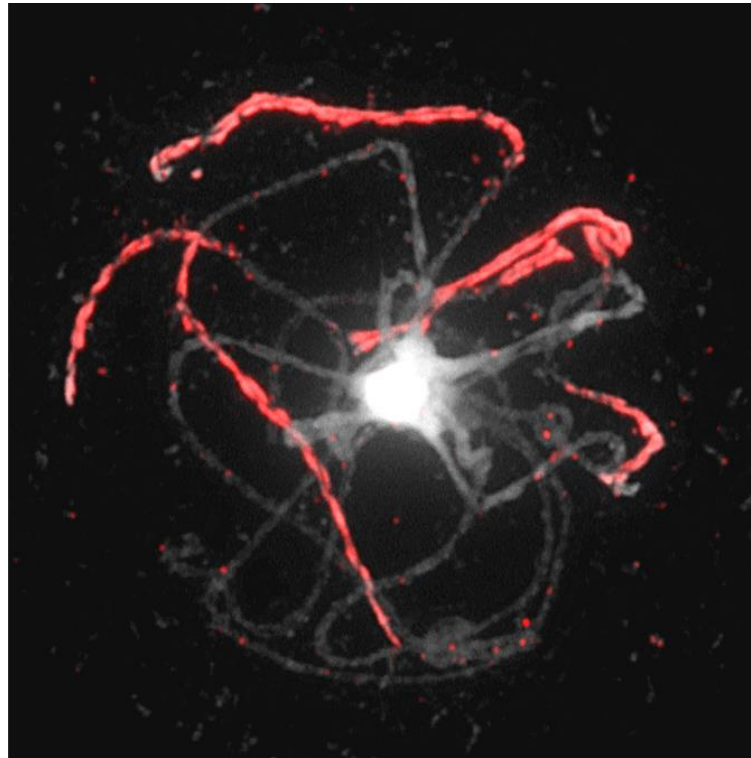



# Het knobs

? origin

? composition

? function (if any)

# Het knob hk4S in Arabidopsis

The hk4S originated by an inversion event that relocated pericentromeric sequence to an interstitial position.

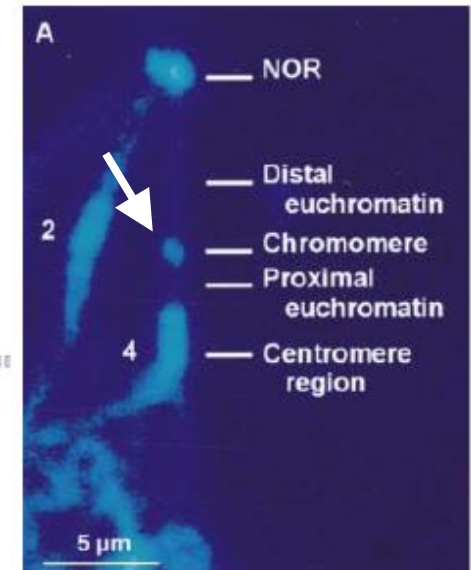
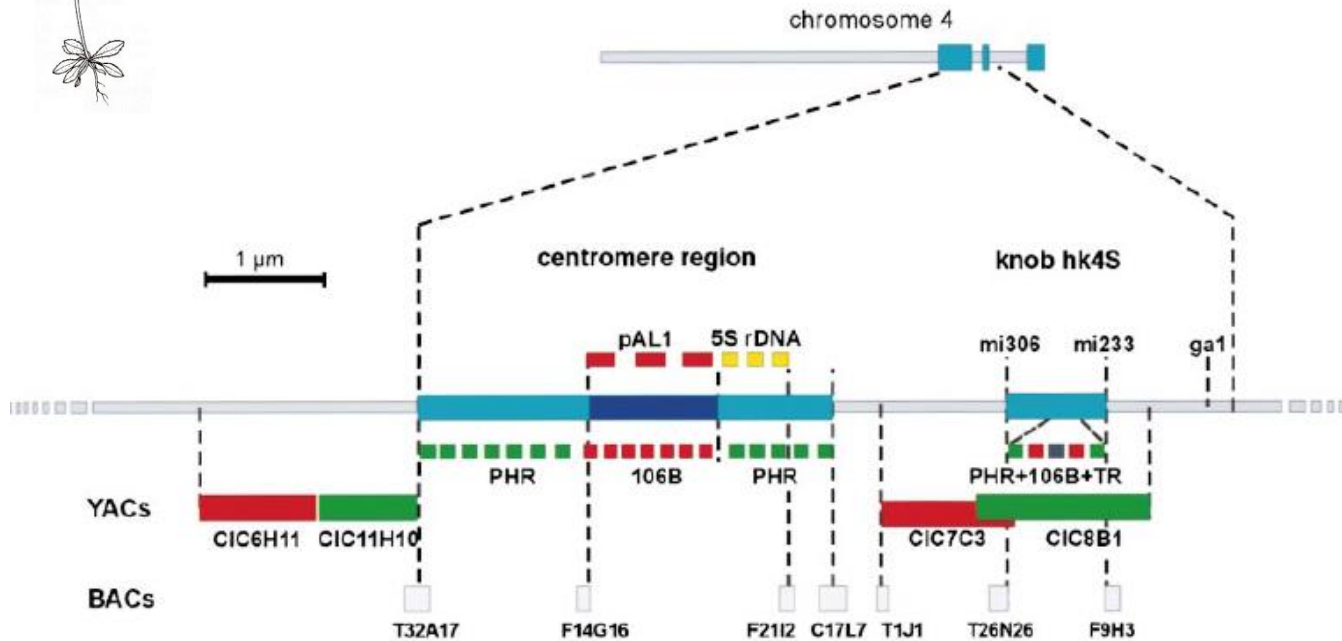

# Het knobs were discovered by McClintock in maize

## Barbara McClintock

(1902-1992)

America's most distinguished cytogeneticist, was initially denied acceptance to Cornell University's Dept. of Plant Breeding because she was a woman. Eventually allowed to study plant genetics, McClintock received her Ph.D. from Cornell in 1927, and later formulated one of the most important genetic theories of the 20th century.



McClintock B (1929) Chromosome morphology in *Zea mays*. *Science* 69

# Het knobs in maize

- knobless and knob-bearing accessions
- the number, size and position of knobs are variable and they are found in 23 locations on the ten maize chromosomes

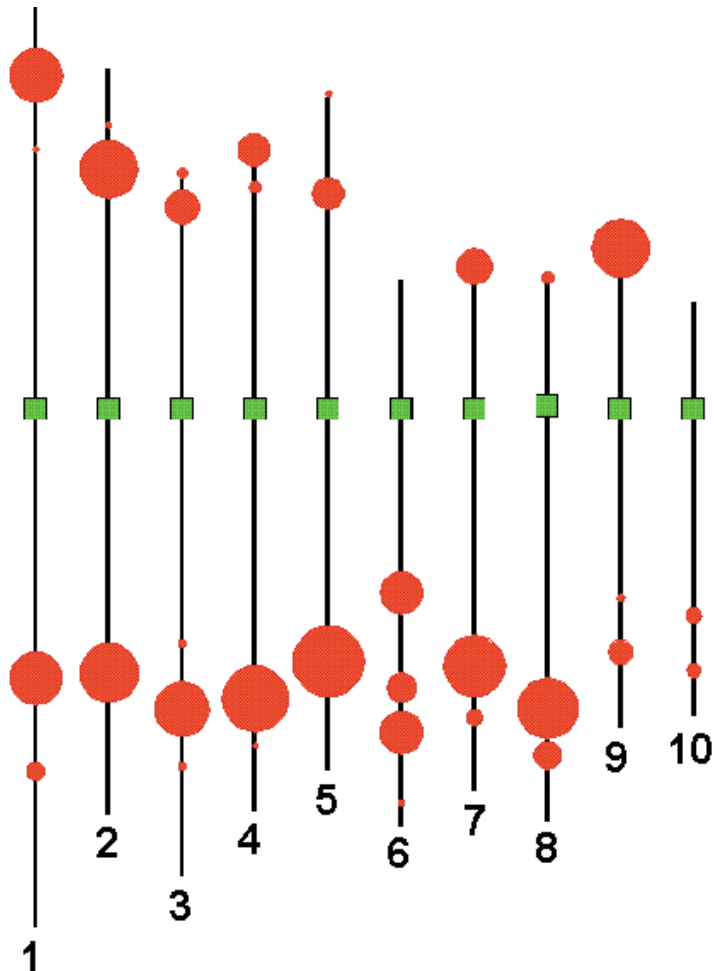

## abnormal chromosome 10

(discovered by Albert Longley; 1937, 1938)

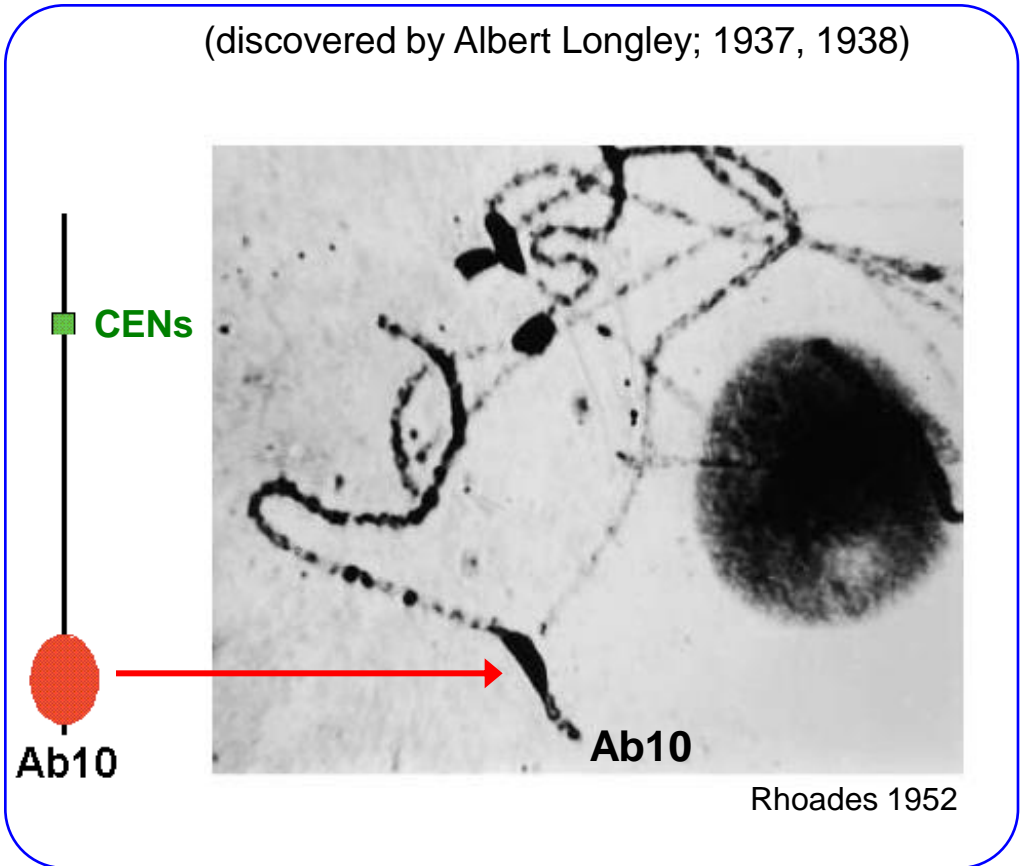

# Het knobs in maize

the 180-bp and TR-1 (350-bp) tandem repeats are the major components of knob heterochromatin (Peacock et al. 1981, Ananiev et al. 1998) + different retrotransposons

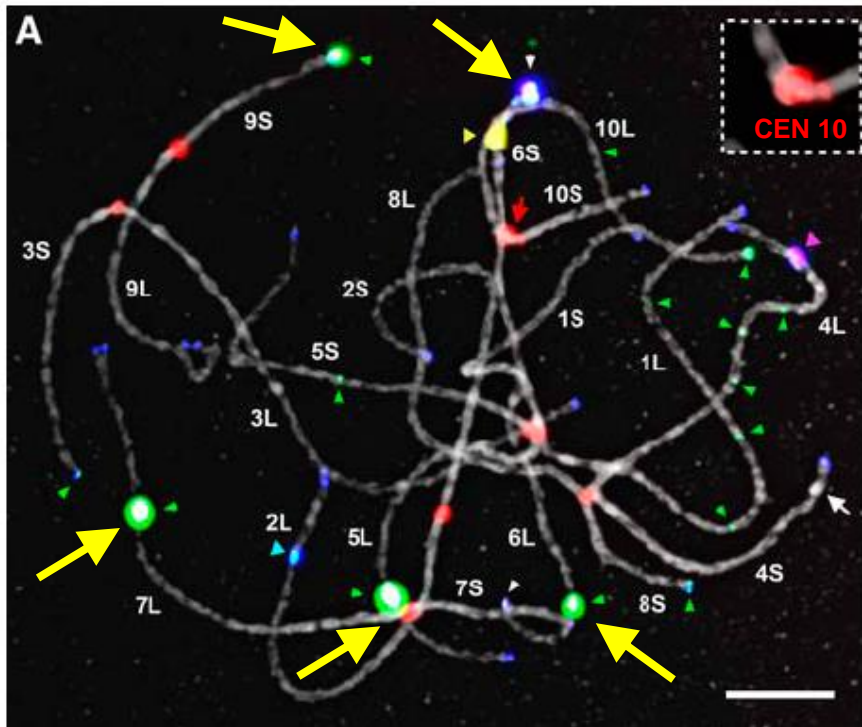

180-bp repeat (green)

TR-1 element (pink)

Wang et al. 2006, *Plant Cell* 18

mFISHed pachytene chromosomes of the Kansas Yellow Saline (KYS) inbred line

# Structural variants of maize chromosome 10 (Ab10)



wiseGEEK

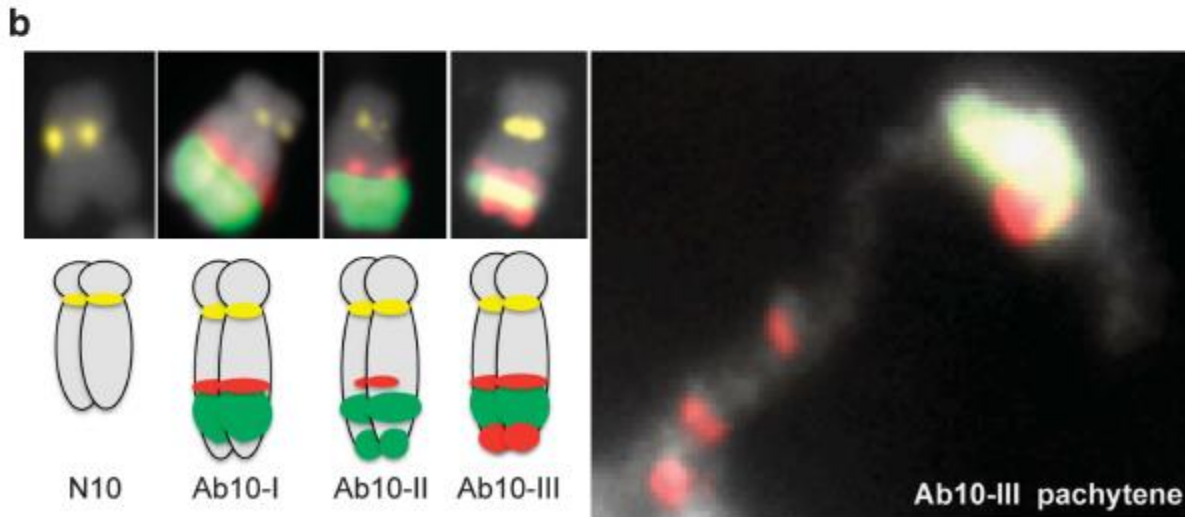
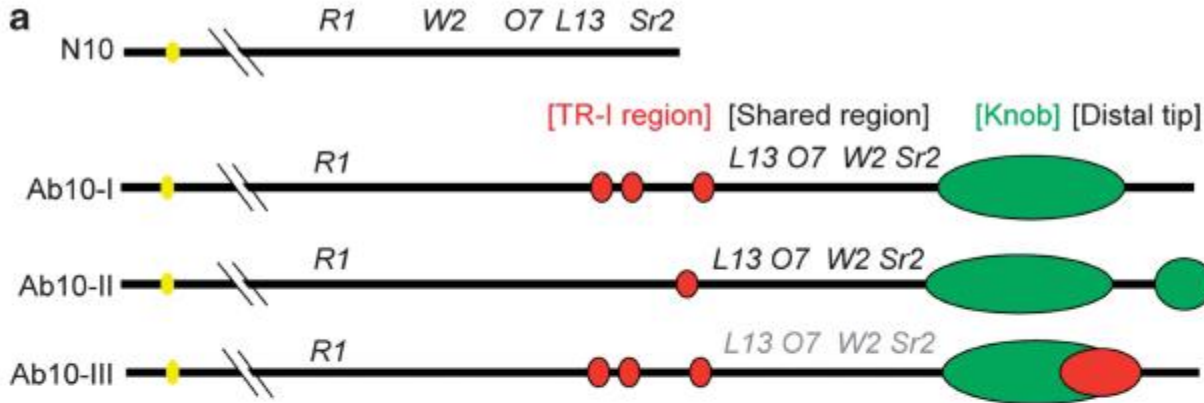

# Meiotic drive (transmission distortion)

described by **Marcus Morton Rhoades**

Rhoades MM (1942) Preferential segregation in maize. *Genetics* 27: 395-407.



Birchler et al. 2003, *Genetics* 164

# Meiotic drive

The ability of one homolog to enhance its probability of transmission at the expense of its partner (e.g. in  $Aa$  heterozygote,  $A$ -bearing gametes are produced more frequently than  $a$ -bearing gametes).

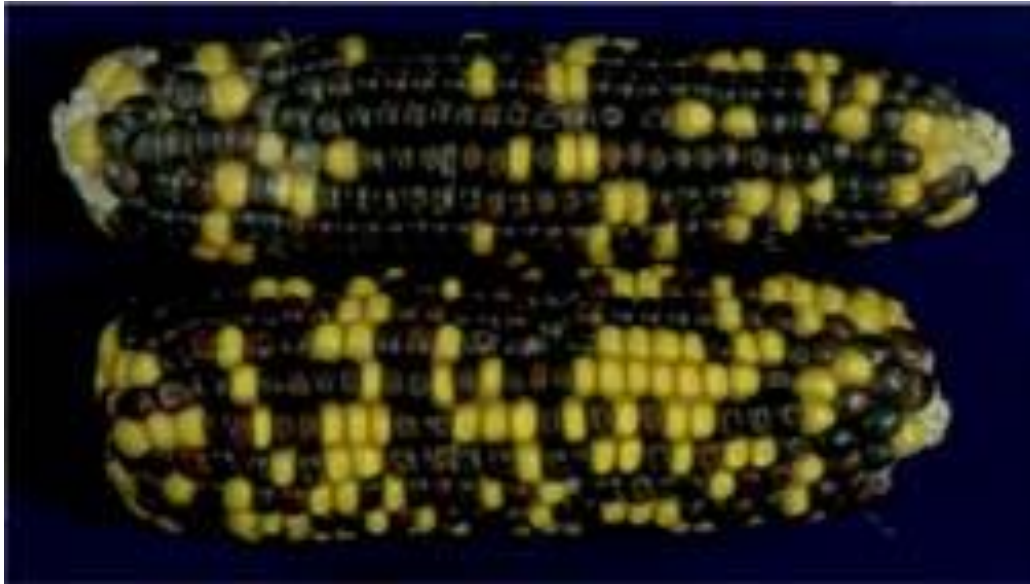

preferential transmission  
of the  $Ab$  10 chromosome

the 1:1 segregation  
(normal chromosome 10)



# Meiotic drive in maize

Preferential transmission of the knob-bearing chromosomes during female meiosis. But only if the Ab 10 chromosome is present.

heterozygote for Ab 10



crossing-over located between  
the knob and centromere



cross-over products that carry the knob  
on only one of its two chromatids  
(heteromorphic dyad)



pseudokinetochore activity of the knob direct the  
knob-bearing chromatide to one of the four products  
of meiosis II, which is one of the two "outside" nuclei,  
and the only one that is available for fertilization

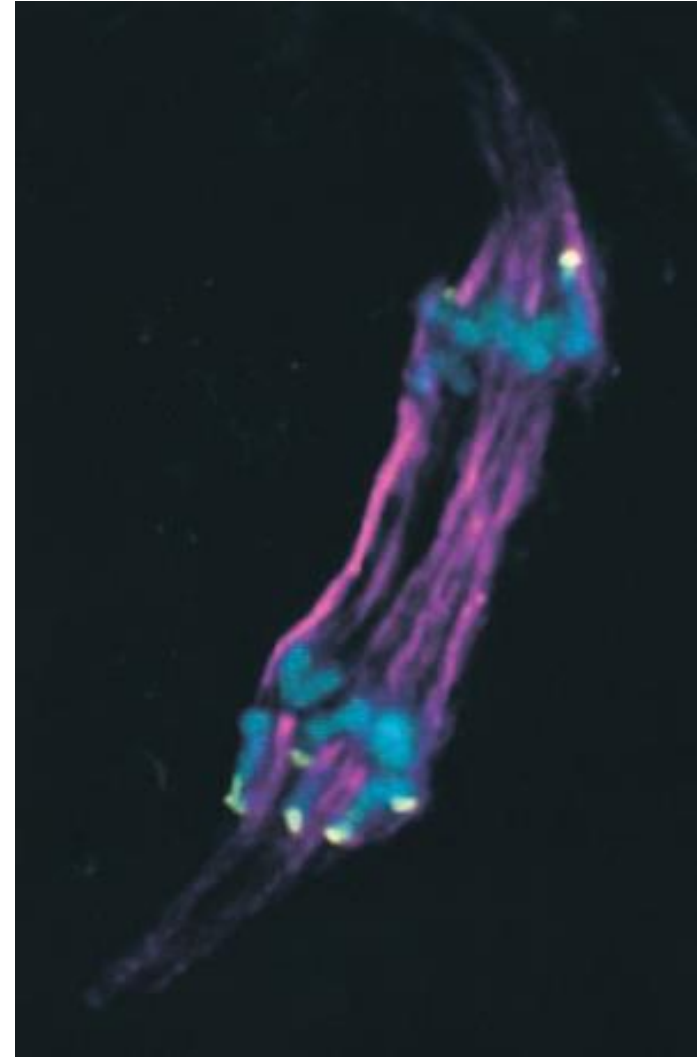

Birchler et al. 2003, *Genetics* 164

# Megasporogenesis and meiotic drive in maize

Female meiosis (megasporogenesis) is asymmetric:

- out of 4 haploid products only one will become the egg; other three degenerate

- **the outermost (basal) megaspore** differentiates into the megagametophyte via a few mitoses to produce the egg, polar nuclei, and associated cells

Knob-bearing chromatids are pulled towards the **outermost megaspores** during meiosis II ahead of the centromeres.

Consequently, instead of a 50% expected ratio of transmission in a heterozygote, knob transmission in female meiosis varies from 59 to 82%.

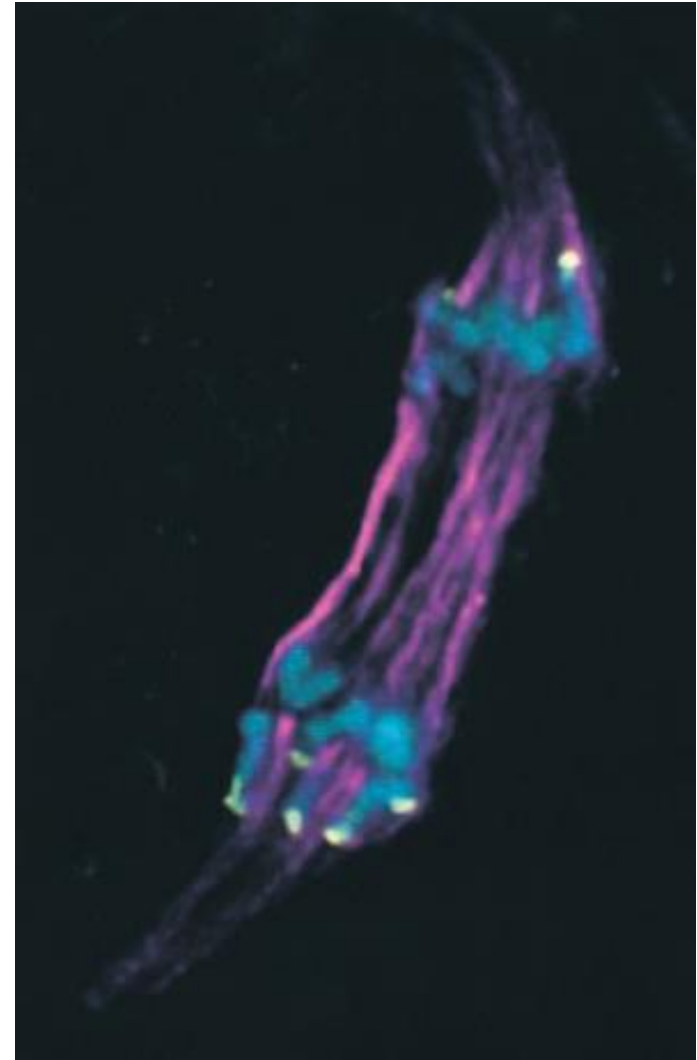

Birchler et al. 2003, *Genetics* 164

# Female gametogenesis

