

Double-strand breaks (DSBs), their repair and misrepair

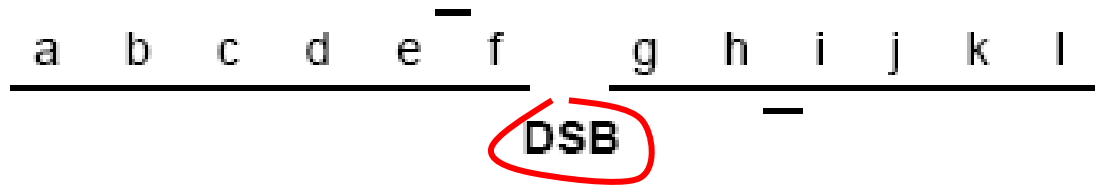

How double-strand breaks are generated

DSBs are caused by several factors:

- arrest of replication and restart of DNA synthesis (replication forks tend to stall in regions of repeat elements - e.g. tRNA genes, retroposons, and telomeres); major source of DSBs!

- transposon excision

- during meiotic recombination (needed for recombination)

- mechanical pulling (e.g. in dicentric chromosomes)

- experimentally (radiation by X-rays, DSBs inducing chemicals, rare cutting restriction endonucleases, DNA transposons)

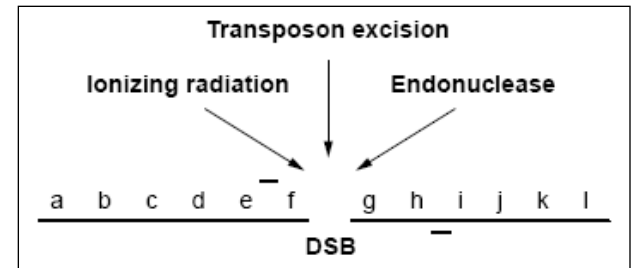

.....

- ❖ in vegetative (mitosis) and generative cells (meiosis)

- ❖ DSBs have to be repaired before genomes are replicated (S phase)

- ❖ in plants, errors in DSB repair (DSBs misrepair) can have the evolutionary significance because changes in meristematic cells can be transferred to the offspring >>> **chromosome rearrangements**

DSBs in meiosis

- ❖ necessary for homologous recombination (cross-overs)
- ❖ induced by the Spo11 topoisomerase

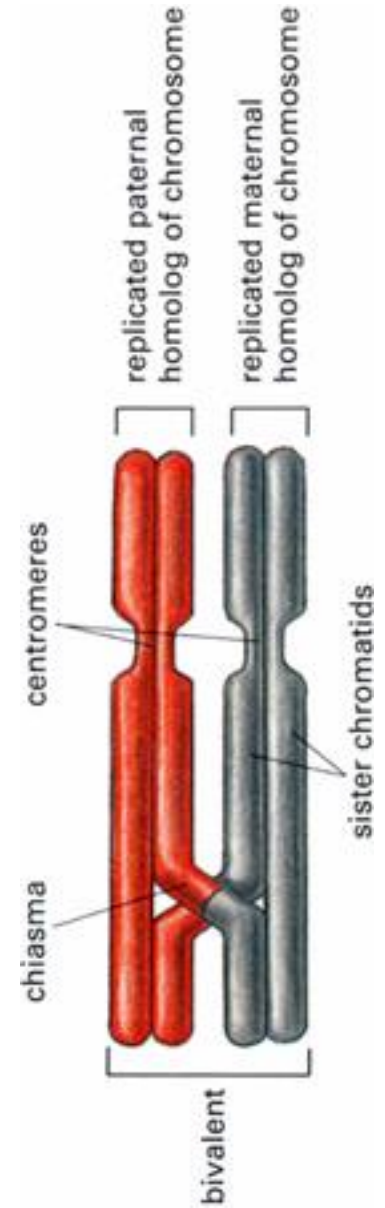

DSBs in somatic plant cells and their repair

DSBs repair



non-homologous end joining (NHEJ)

- also known as homology-independent recombination or “illegitimate recombination”
- main mode of DSB repair in higher eukaryotes (somatic plant cells)
- the broken ends are re-ligated directly
- often an error-prone process
- throughout the cell cycle (mainly G₁ phase)

homologous recombination (HR)

- uses sister chromatids as a template to rejoin DSBs (most frequently)
- minor pathway
- error-free repair
- in late S-G₂ phase

The two main pathways of non-homologous end joining (NHEJ) in plant cells

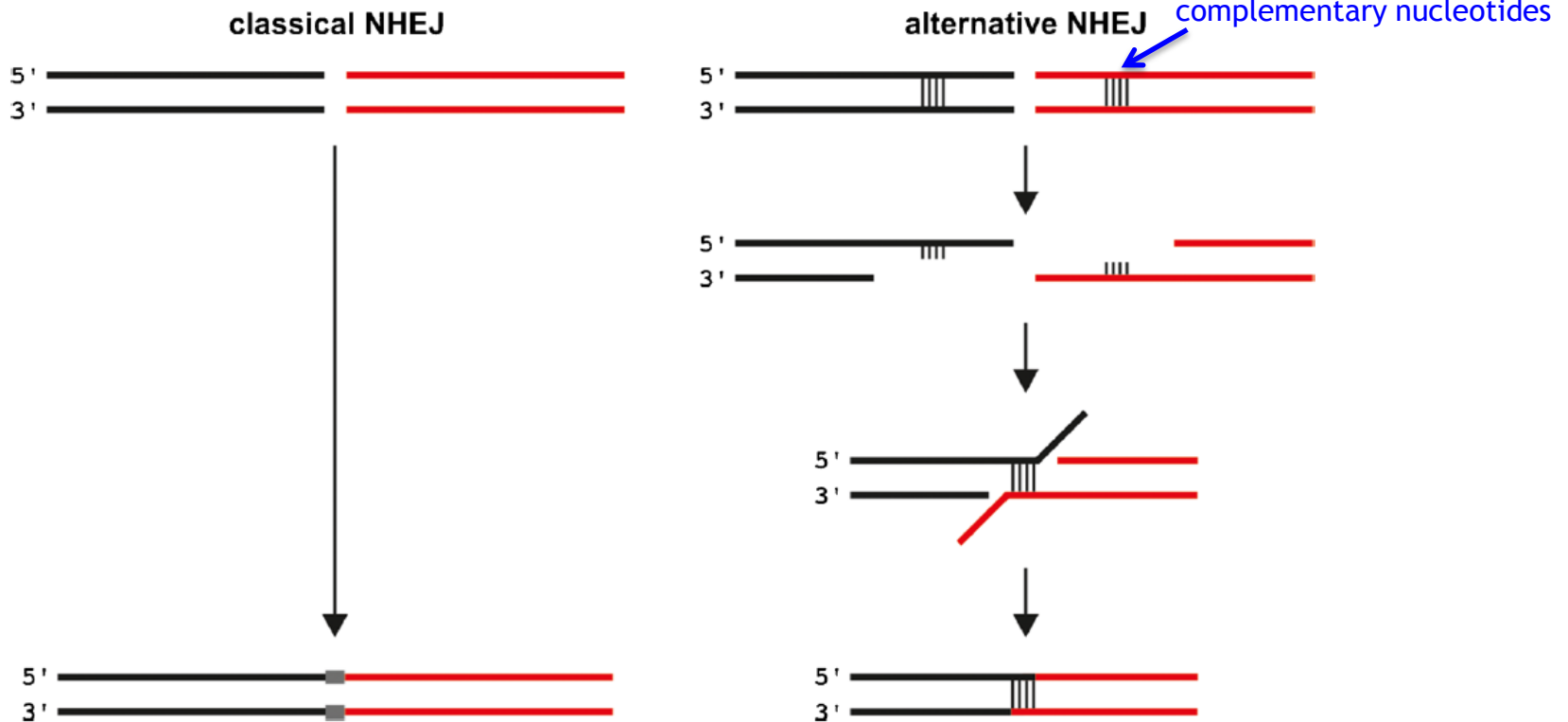

DNA lost but some DNA can be inserted (filler DNA)

NHEJ in plant somatic cells

- NHEJ seems to be the main mode of DSB repair in higher eukaryotes
- NHEJ might lead, in some cases, to genomic changes (deletions, insertions or various kinds of genomic rearrangements)
- genomic alterations in meristematic cells can be transferred to the offspring
- **alternative NHEJ can mediate genome size loss**



Arabidopsis vs. tobacco (genome size larger in tobacco)

1C = 157 Mb



1C = 4.5 Gb



- tobacco: almost every second deletion event is accompanied by the insertion of filler sequence
- Arabidopsis: no insertions
- overall length of the deletions is about one-third shorter in tobacco than in Arabidopsis

>>> inverse correlation between genome size and the medium length of deletions

>>> ??? species-specific differences in DSB repair pathways can contribute to the evolution of eukaryotic genome size ???

- *A. thaliana* (157 Mb) has lost 6x more introns than *Arabidopsis lyrata* (210 Mb) since the divergence of the two species but gained very few introns

NHEJ-mediated rearrangements

deletion

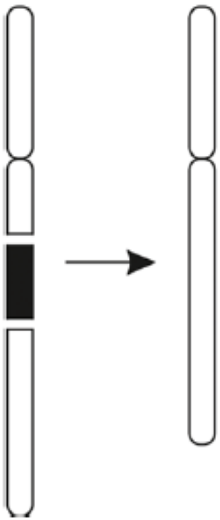

inversion

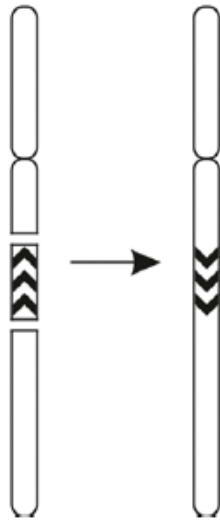

reciprocal translocation

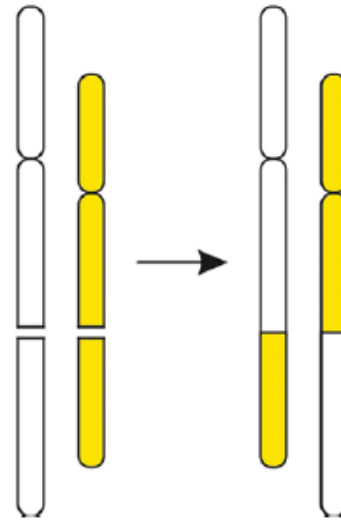

multiple translocations

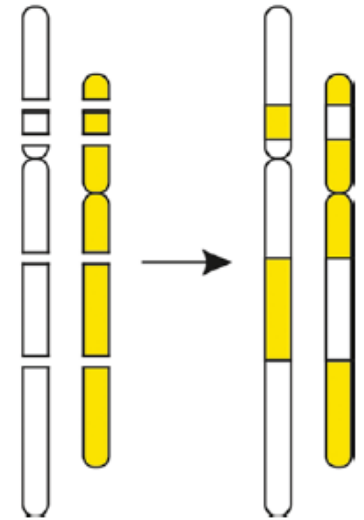

Homologous recombination

The two main pathways of **homologous recombination** in somatic plant cells

single-strand annealing

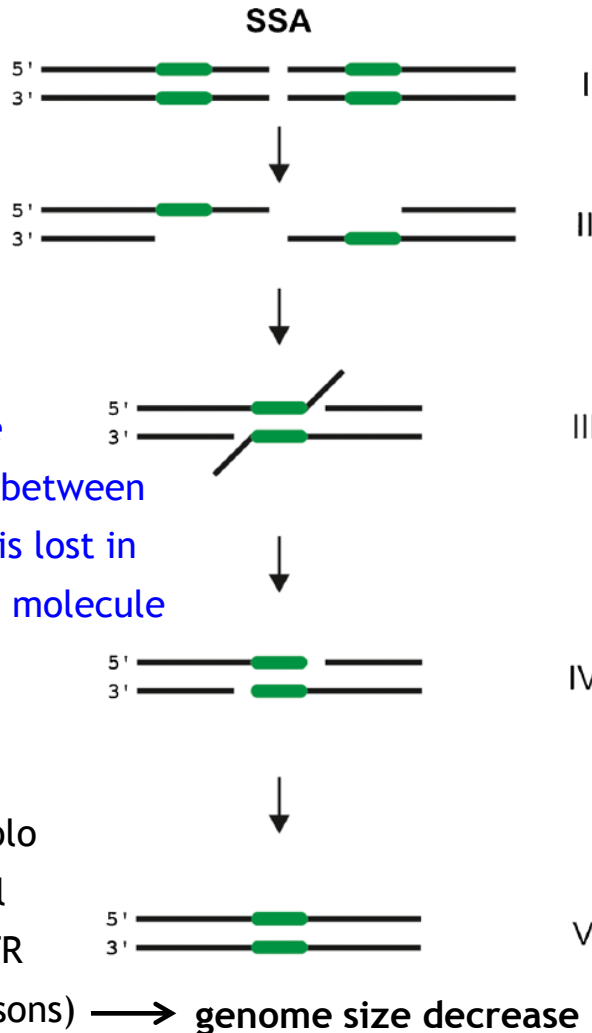

synthesis-dependent strand annealing (template needed)

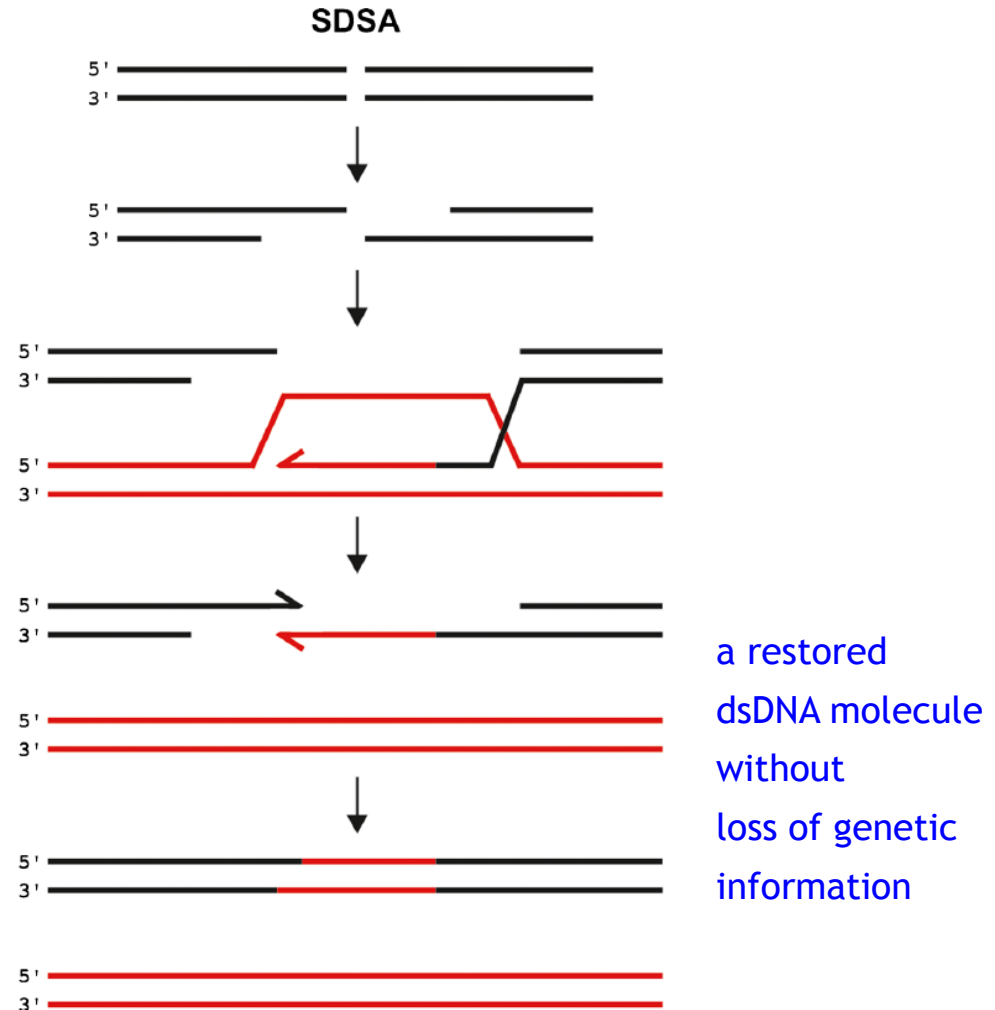

Templates for homologous recombination (HR) via SDSA (needs a template)

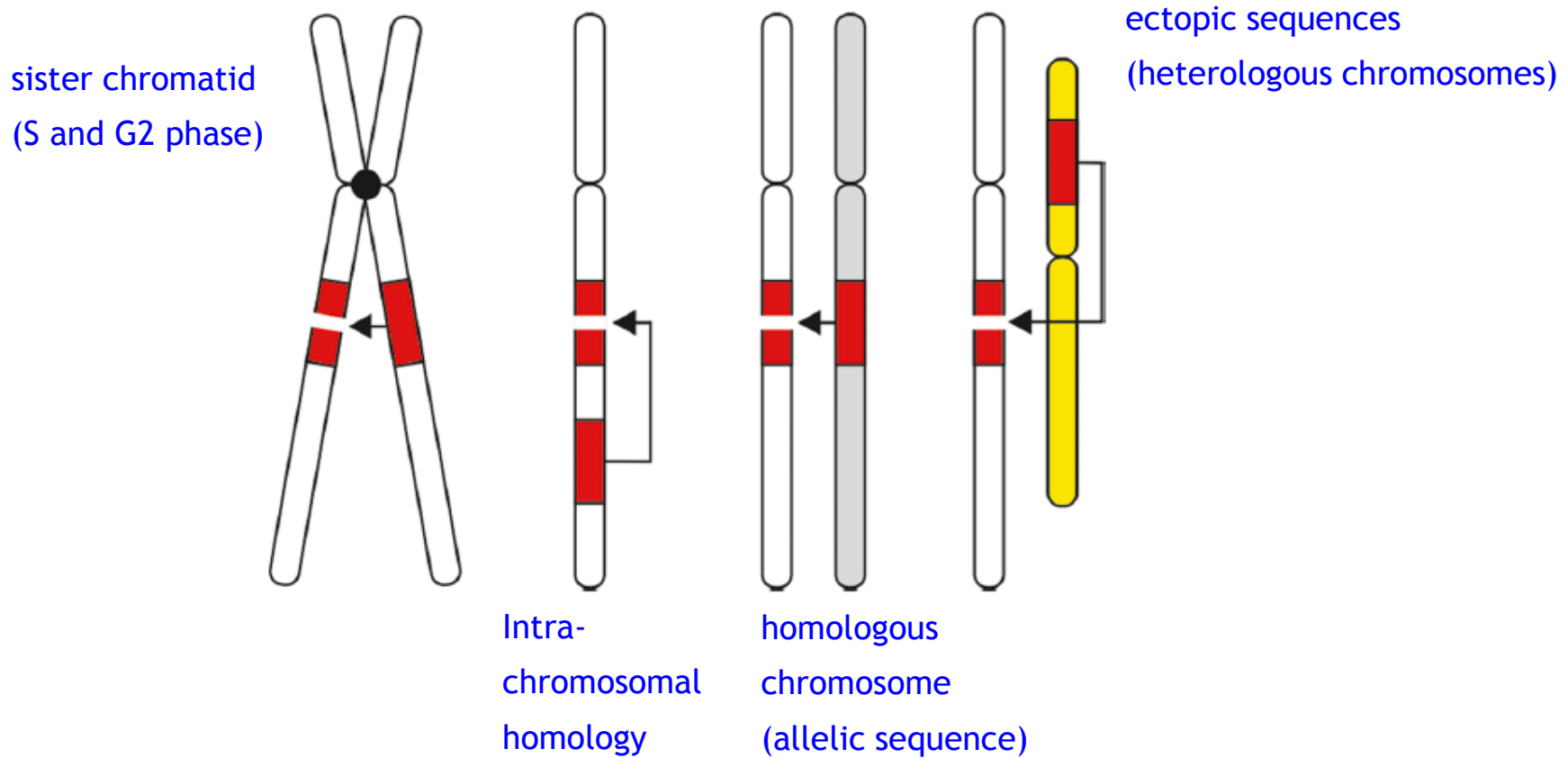

DSB repair and misrepair can lead to chromosome rearrangements

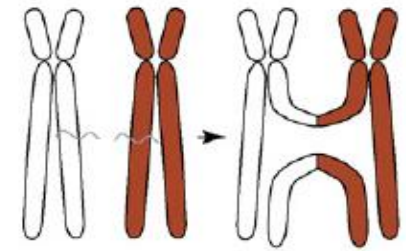

A DSB at single copy DNA

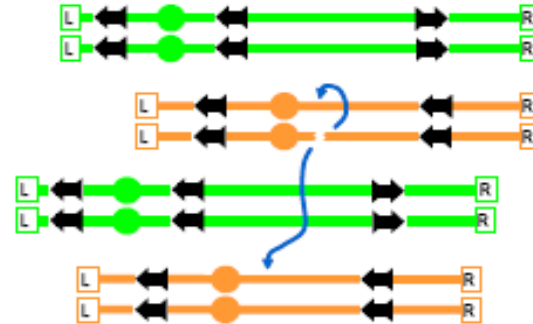

repair using a sister chromatid or homologue

B DSB at repetitive DNA

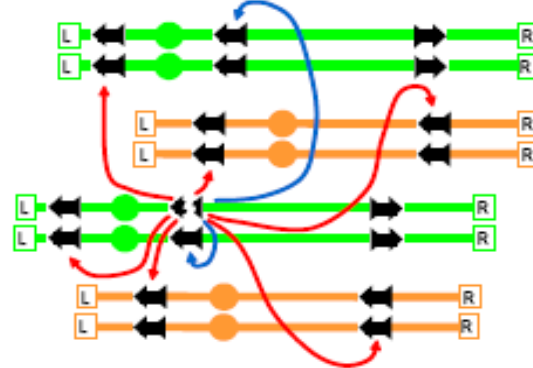

repair using a sister chromatid or homologue
AND
ectopic recombination (generating chromosome aberrations)

ectopic DSB repair competes with repair using the sister chromatid or homologue

NHEJ vs. HR (short summary)

- in somatic plant cells, DSBs are mainly repaired by **NHEJ**
 - the NHEJ repair can be associated with deletions, but also insertions due to copying genomic sequences from elsewhere into the break; chr. rearrangements can be generated
 - inverse correlation of deletion size to genome size (Arabidopsis vs. tobacco) >>> NHEJ might contribute significantly to evolution of genome size
-

- DSB repair by **HR** might also influence genome organization
- intra-chromosomal HR is frequent (sequences in close proximity to the break), inter-chromosomal HR (allelic and ectopic) is hardly used for repair

- a ‘single-strand annealing’ (SSA) mechanism of HR that leads to sequence deletions between direct repeats is particularly efficient >> might explain the accumulation of single LTRs of retroelements in some plant genomes (?evolution of genome size?)

