

Vakuový systém urychlovače LHC

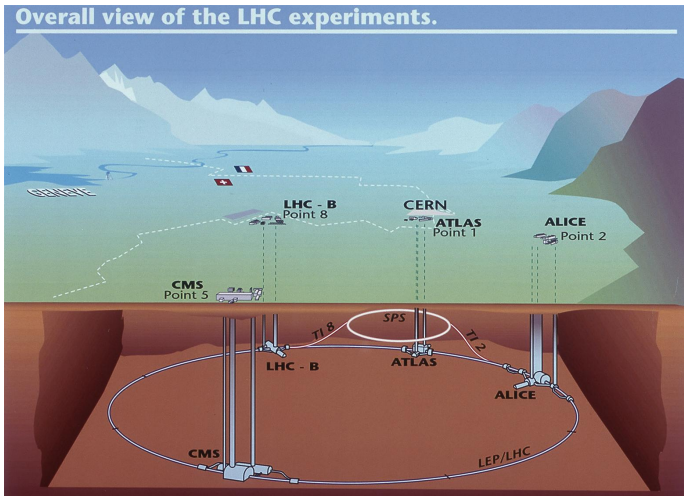

50 - 150 m pod zemí, délka 27 km¹

¹home.web.cern.ch/topics/large-hadron-collider

LHC

- 8 - oblouků a 8 rovných částí
- sektor je část urychlovače mezi středy rovných úseků
- 7 TeV - energie protonů, spotřeba LHC celková 120 MW
- magnetické pole max. 8.33 T
- 11245 oběhů za 1 s
- supravodivé magnety z NbTi
- kryo-systém - 120 t He
- 700MB/s dat ze všech experimentů
- náklady asi 3 miliardy EUR \sim 80 miliard Kč \sim 4.5 miliardy USD
- 1500 PC z ČR počítalo simulace pro uložení magnetu

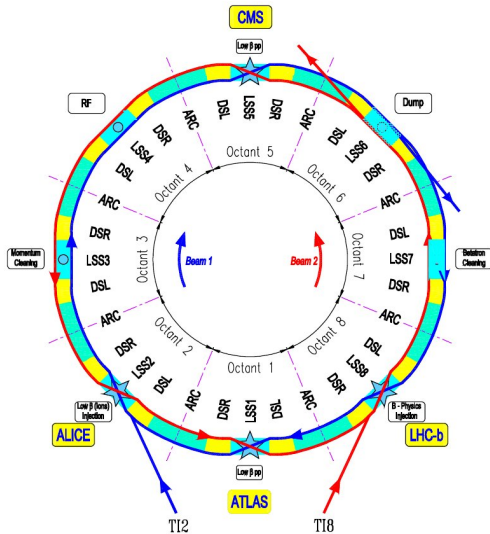

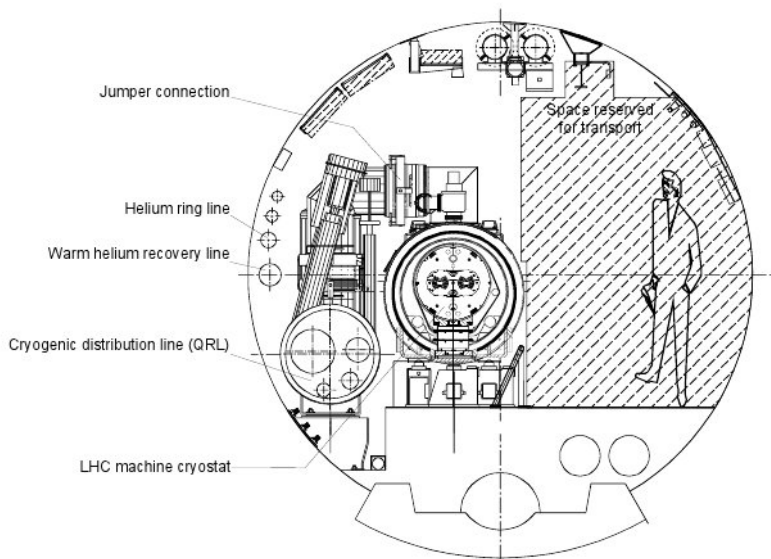
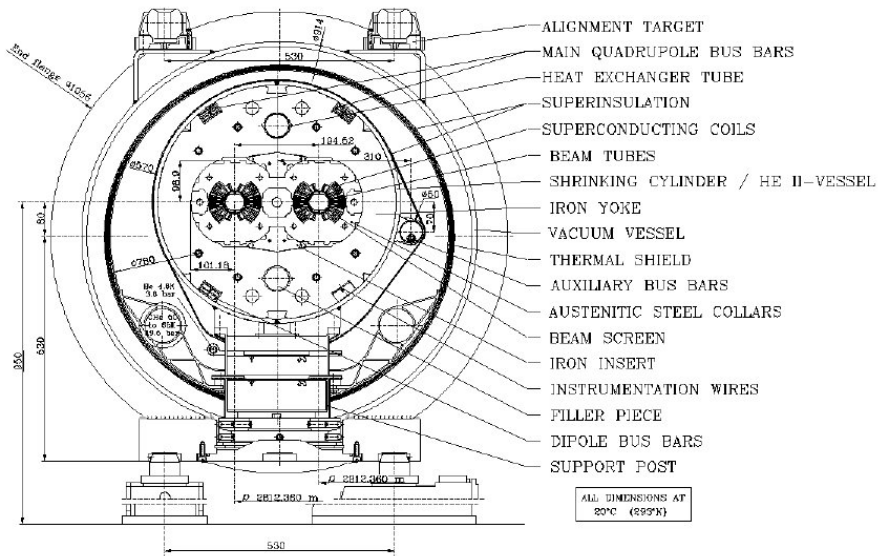

Figure 11.1: Transverse cross-section of the LHC tunnel



Vakuové systémy:

- kryomagnety - sektory s délkou 214 m, teplota 1.9 K
- He-rozvody - sektory s délkou 428 m
- urychlovač - různé délky sektorů, délka přibližně 2900 m,
 $10^{-8} - 10^{-9}$ Pa

GAS	Nuclear scattering cross section(cm^2)	Gas density (m^{-3}) for a 100 hour lifetime	Pressure (Pa) at 5 K, for a 100 hour lifetime
H_2	$9.5 \cdot 10^{-26}$	9.810^{14}	6.710^{-8}
He	$1.26 \cdot 10^{-25}$	7.410^{14}	5.110^{-8}
CH_4	$5.66 \cdot 10^{-25}$	1.610^{14}	1.110^{-8}
H_2O	$5.65 \cdot 10^{-25}$	1.610^{14}	1.110^{-8}
CO	$8.54 \cdot 10^{-25}$	1.110^{14}	7.510^{-9}
CO_2	$1.32 \cdot 10^{-24}$	$7 \cdot 10^{13}$	4.910^{-9}

5

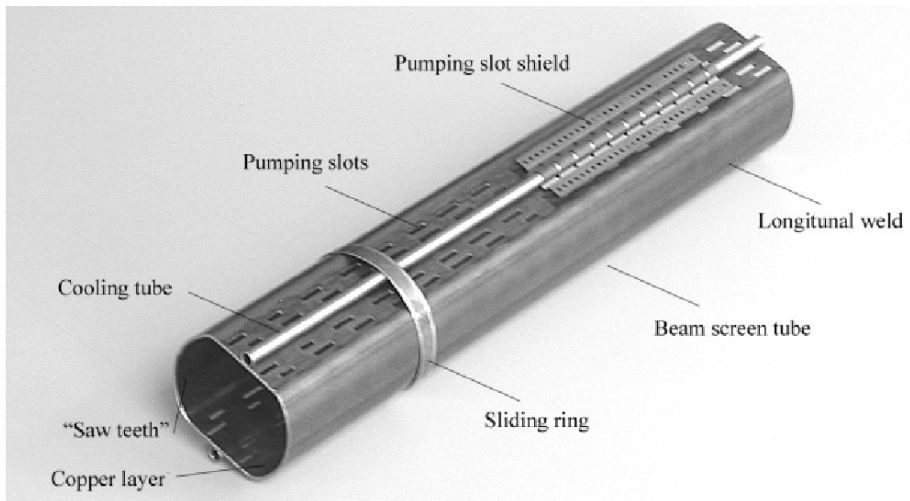

průměr asi 45 mm, 1 mm nerez ocel + $75\mu\text{m}$ Cu, 5-20 K ⁶

⁶home.web.cern.ch/topics/large-hadron-collider

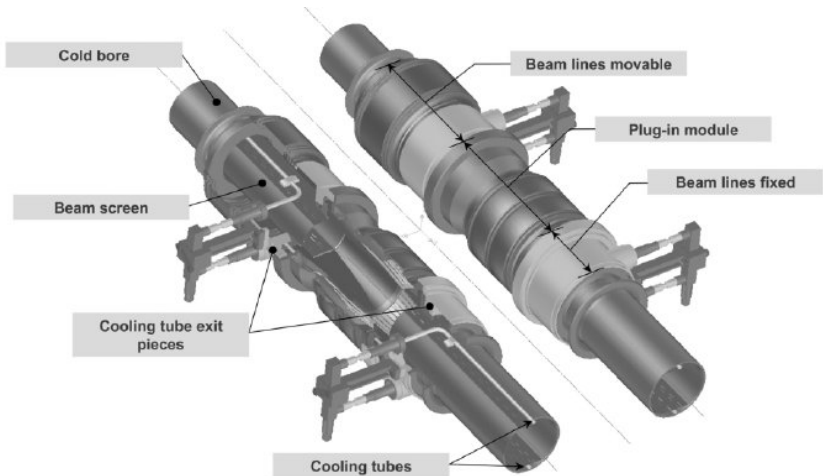

elektrický odpor $0.1 \text{ m}\Omega$ ⁷

⁷home.web.cern.ch/topics/large-hadron-collider

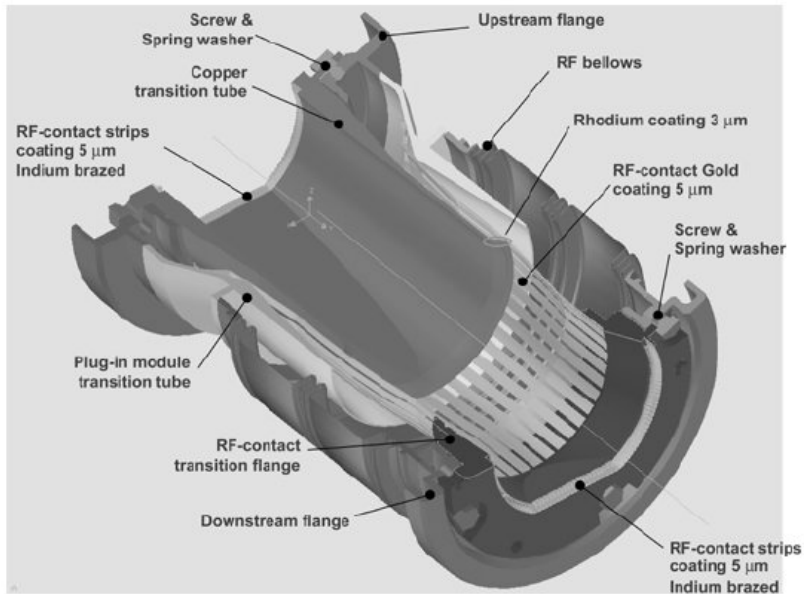

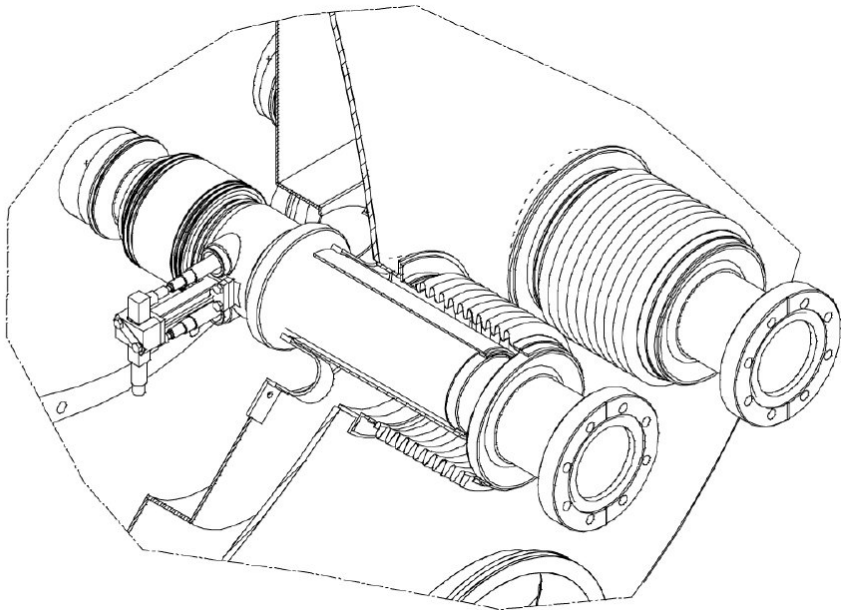

Figure 12.7: Details of a cold-to-warm transition

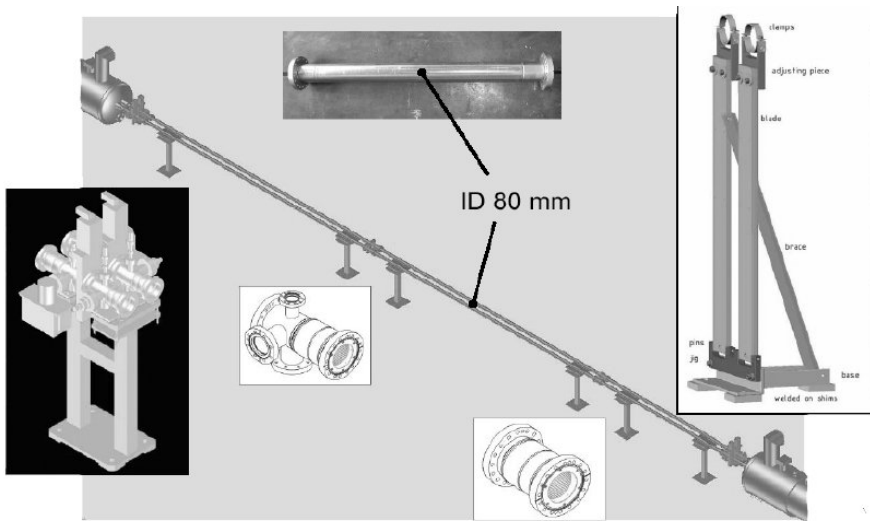

Figure 12.8: Standard layout of the RT beam vacuum system between two cryostats.

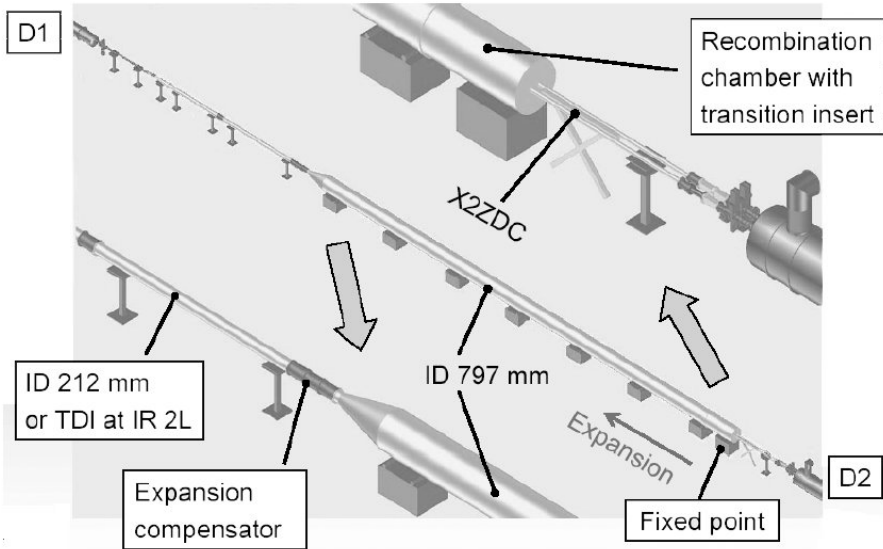

Figure 12.10: Layout of the RT beam vacuum system at right of IR point 2

- mobilní čerpací stanice
- trubice urychlovače - kryogenní vývěva
- části na pokojové teplotě - NEG getr - TiZrV, iontové vývěvy asi po 28 m
- manometry v každém sektoru - 1x Pirani, 2x ionizační se studenou katodou, 1x ionizační se žhavenou katodou
- analyzátor plynu (hmotový spektrometr) na mobilní čerpací jednotce + další manometry

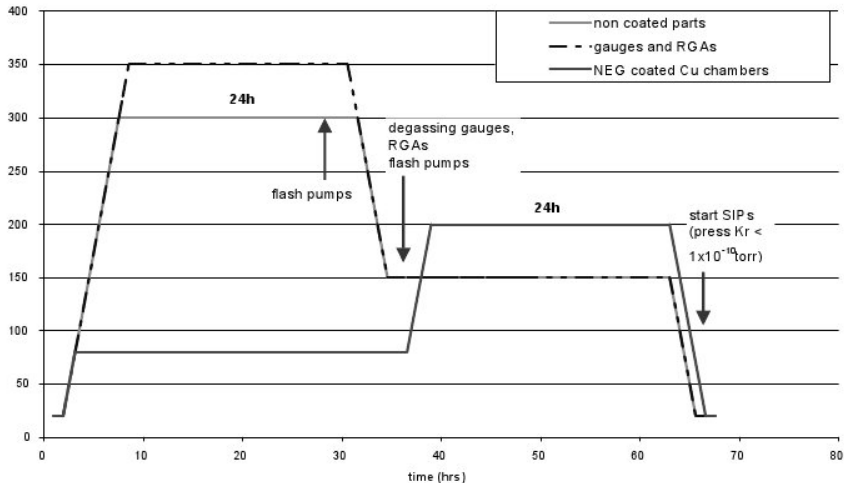

Figure 12.13: Proposed bake-out cycle with NEG activation

¹²Aktivace NEG getrů

¹²home.web.cern.ch/topics/large-hadron-collider

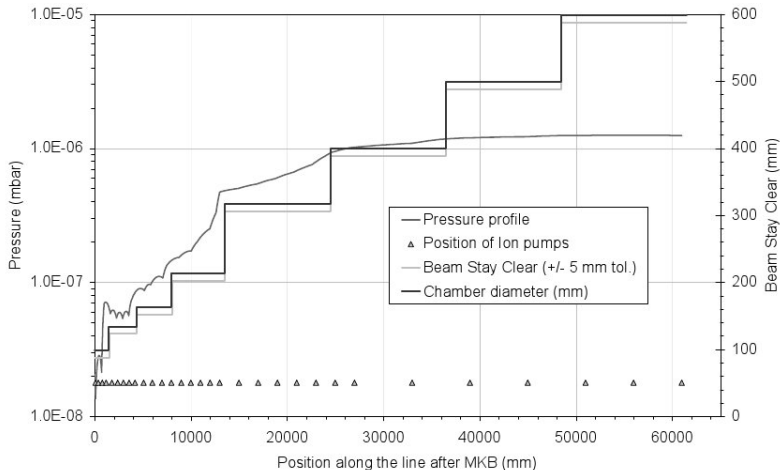

Figure 12.15: Pressure profile, distribution of ion pumps, vacuum chamber diameters and beam stay clear along the beam dump line starting downstream of the diluters (MKB) down to the dump (TDE).

¹³Výstupní část urychlovače

¹³home.web.cern.ch/topics/large-hadron-collider

Table 12.3: Main characteristics of the insulation vacuum sectors

	Cryomagnet	QRL
Volume (m ³)	80	85
Length (m)	214	428
MLI (m ² /m)	200	140
Sectors per arc	14	7

¹⁴Vakuum pro kryomagnetny a He rozvody.

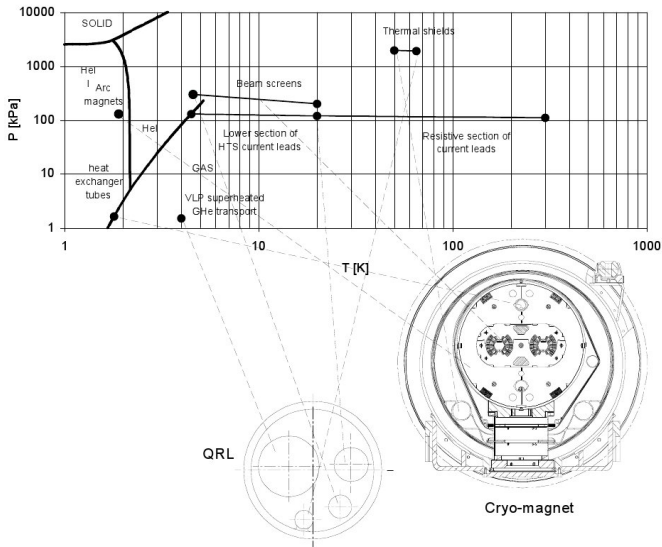

Figure 11.4 Thermodynamic states of helium in the LHC cryogenic system

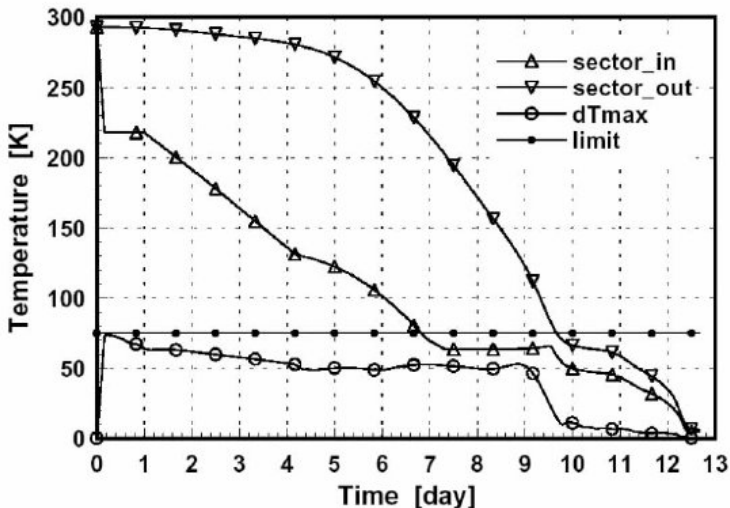

Figure 11.12: Normal cool-down from 300 K to 4.5 K of LHC sectors

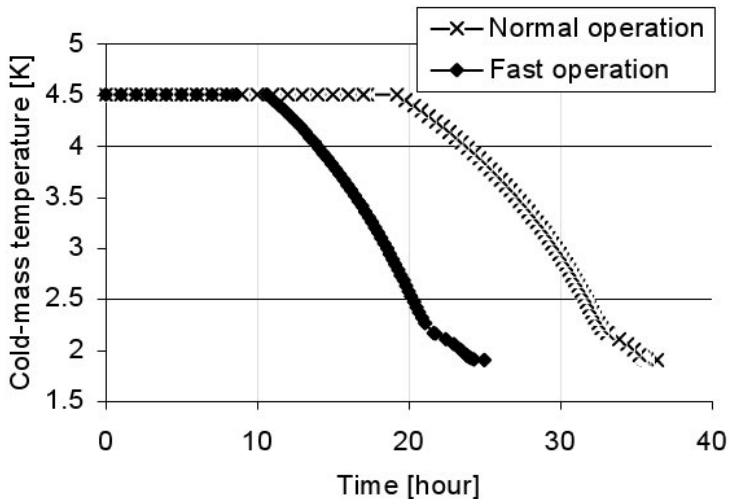

Figure 11.13: Magnet filling and cool-down down from 4.5 K to 1.9 K

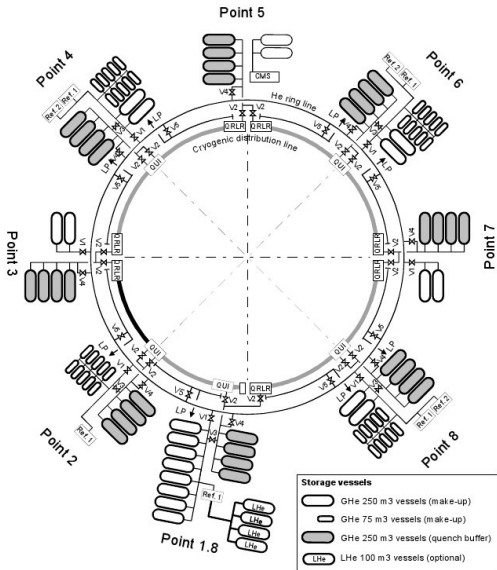
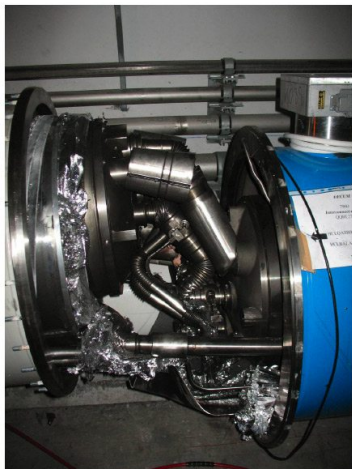

Figure 11.17: Helium storage management

Nehoda na LHC

- 19.9.2008
- vadné propojení mezi dvěma magnety, sektor 3-4
- při zvyšování proudu magnetem na hodnotu 8.7 kA, provozní proud 9.3 kA
- rekonstrukce asi 700 m urychlovače
- ztráta asi 6 t He



19

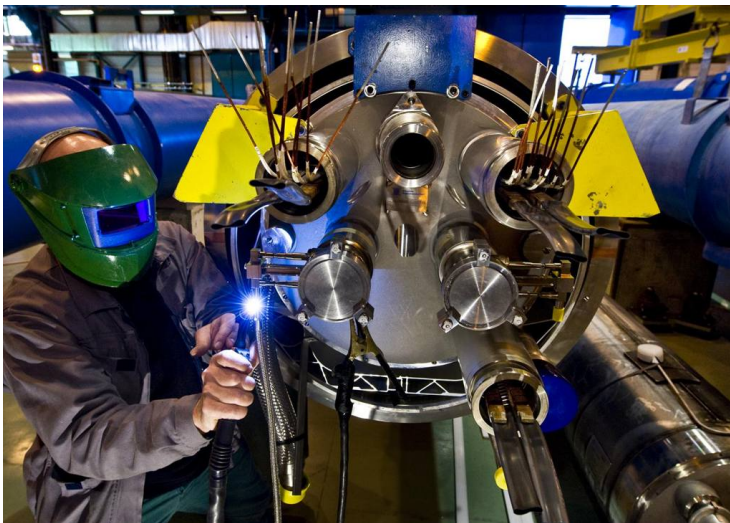

20

²⁰ www.osel.cz/index.php?clanek=4144

Odkazy na www

- <http://lhc.web.cern.ch/lhc/>
- <http://www.osel.cz/index.php?clanek=4144>
- <http://www.czechnationalteam.cz>