

Analytická cytometrie



Karel Souček, Ph.D.

Biofyzikální ústav AVČR
Královopolská 135
612 65 Brno

e-mail: ksoucek@ibp.cz
tel.: 541 517 166

Cytometry Publications/Year

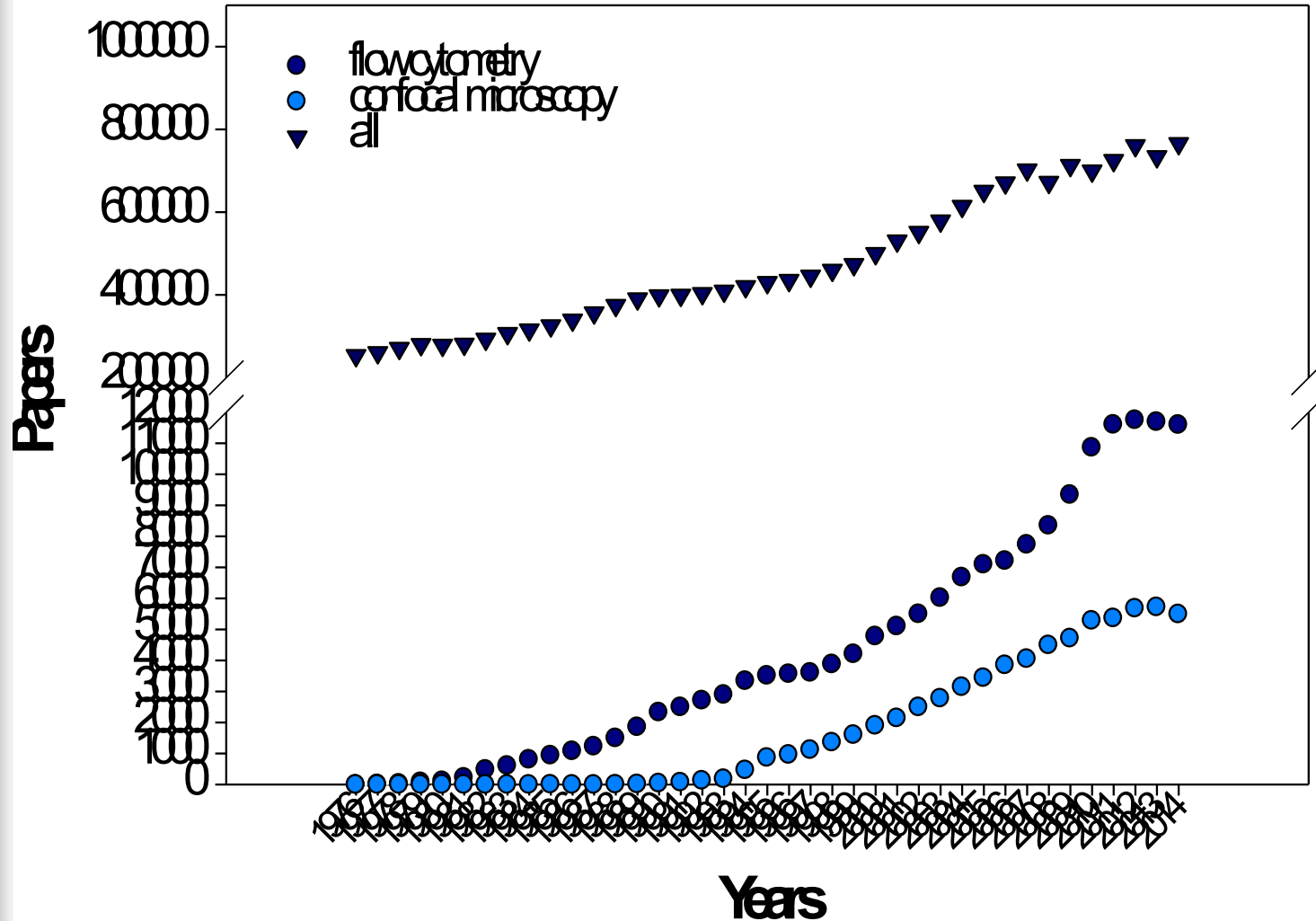



Obecný úvod do průtokové cytometrie

- Základní principy, možnosti průtokové cytometrie a její aplikace
- Historie
- Aplikace
 - Proliferace
 - Buněčná smrt

Tyto částice mají něco společného ...

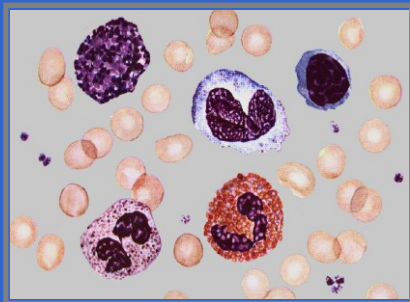

Blood cells



Chromosomes



Algae



Protozoa

... určité parametry těchto částic mohou být měřeny pomocí průtokové cytometrie.

Komerční zařízení a vývoj

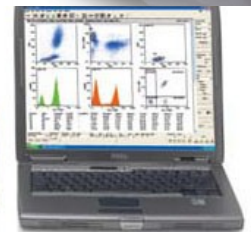
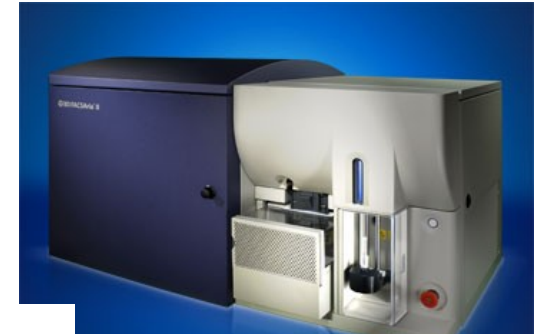

Co je průtokový cytometr?

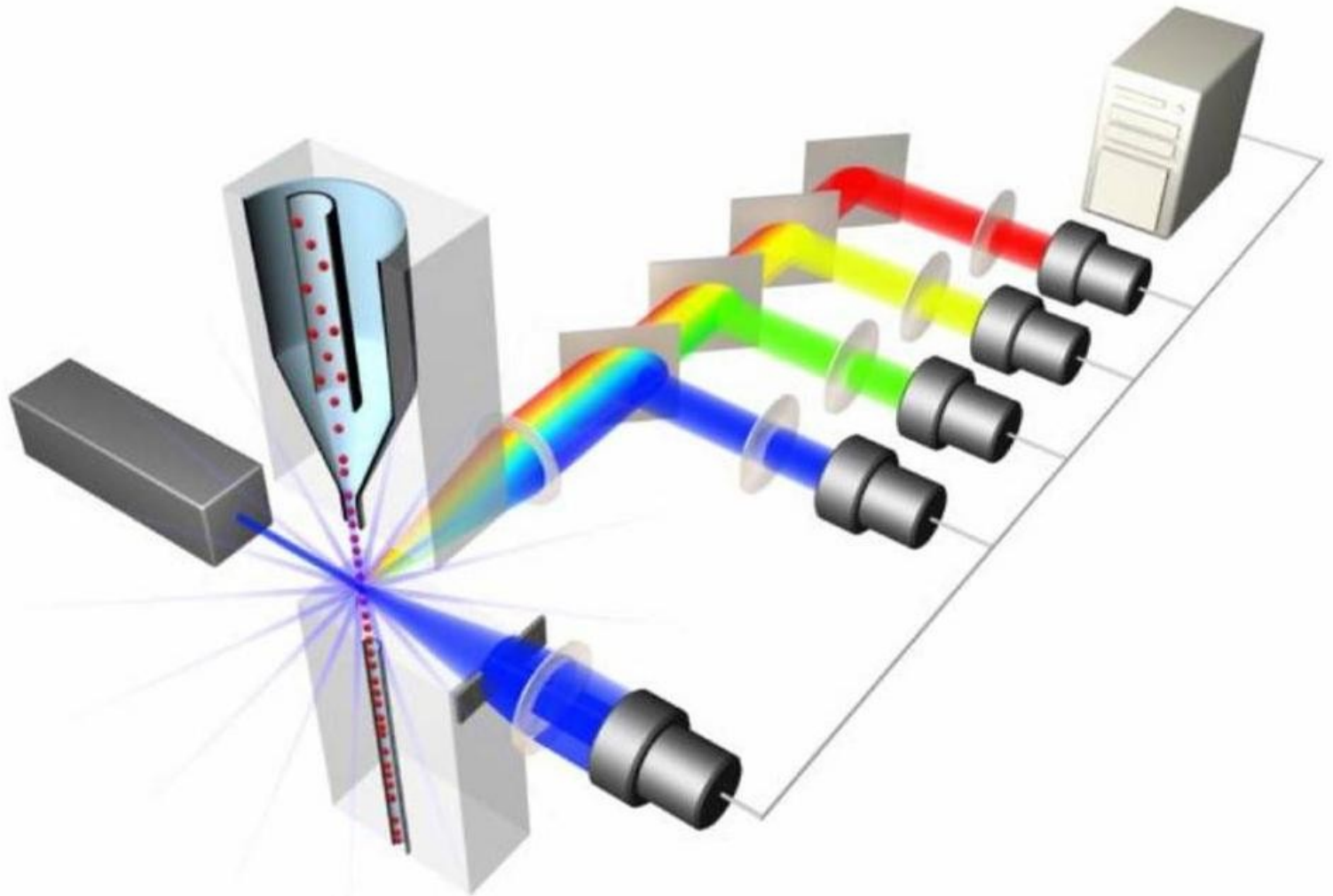



Co můžeme analyzovat pomocí průtokové cytometrie?

- Počítat částice v suspenzi
- Oddělit živé částice od neživých
- Hodnotit 10^5 až 10^6 částic za méně než 1 minutu
- Kvantifikovat rozptyl světla, ale i intenzitu fluorescence
- Fyzicky separovat jednotlivé částice (populace) pro další analýzu

new automatic cell cloning assay (ACCA) for determination of clonogenic capacity of CSCs

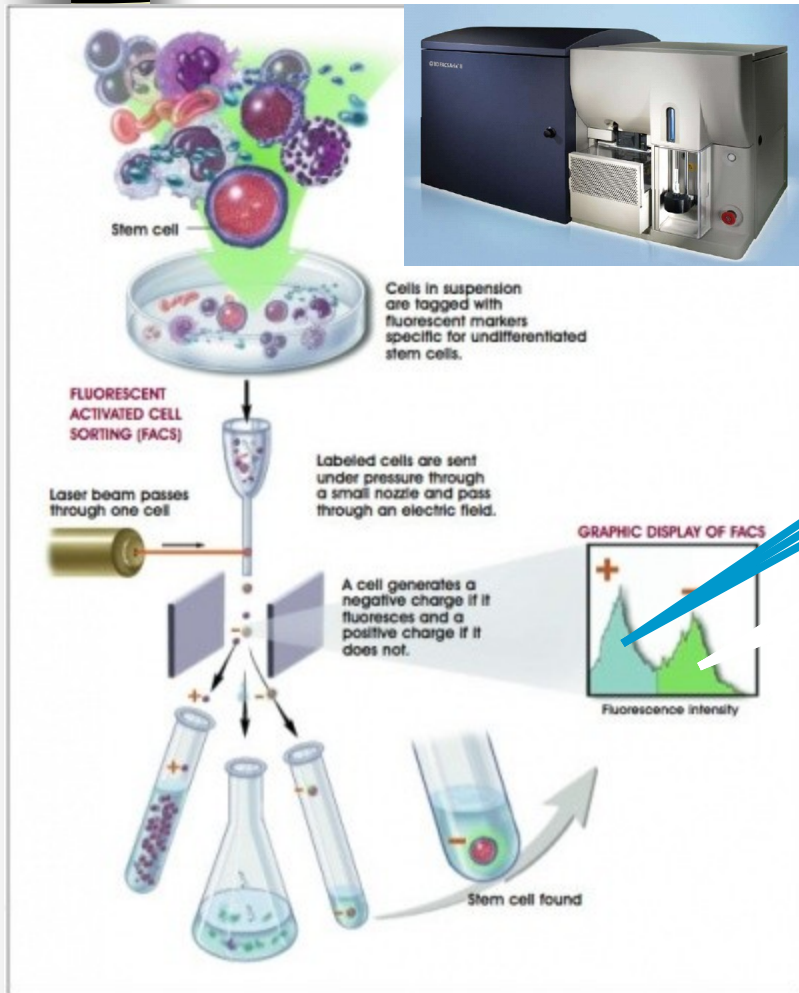

single cell/well
up to 384 well plate



re-culture after sorting (2D, 3D)

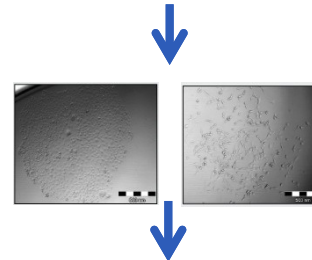

analysis: CyQuant, ATP, xCelligence, microscopy





Jaké jsou principy?

- **Rozptyl světla (Light scatter)** pomocí laseru nebo UV lampy
- Detekce specifické fluorescence
- **Hydrodynamicky** zaostřený proud částic
- **Elektrostatická** separace částic
- Možnost **multivariační** analýzy dat



Definice

- **Průtoková cytometrie (flow cytometry)**

- Meření vlastností proudících částic (buněk)
- také známo jako **Fluorescence-Activated Cell Sorting (FACS)**

- **Průtoková separace (flow sorting)**

- fyzická separace částic (buněk) na základě parametrů měřených průtokovou cytometrií



Technické součásti

- Zdroje světla
- Detekční systémy
- Fluidní systém
- Separace
- Sběr dat
- Analýza dat



Technické součásti

■ Detekční systémy

Fotonásobiče (Photomultiplier Tubes (PMTs))

dříve 1-2

nyní 3-8

Diody

detekce rozptylu světla (light scatters)

■ Zdroje světla

Lasery (350-363, 420, 457, 488, 514, 532, 600, 633 nm)

Argon ion, Krypton ion, HeNe, HeCd, Yag

UV (Arc) Lampy

Mercury, Mercury-Xenon



Stain Your Own Cell

life
technologies™

Historie barvení biologických materiálů

Až do poloviny 19. století – *byly používány pouze přírodní barviva*

Anton van Leeuwenhoek použil v roce 1719 šafrán na obarvení svalových buněk

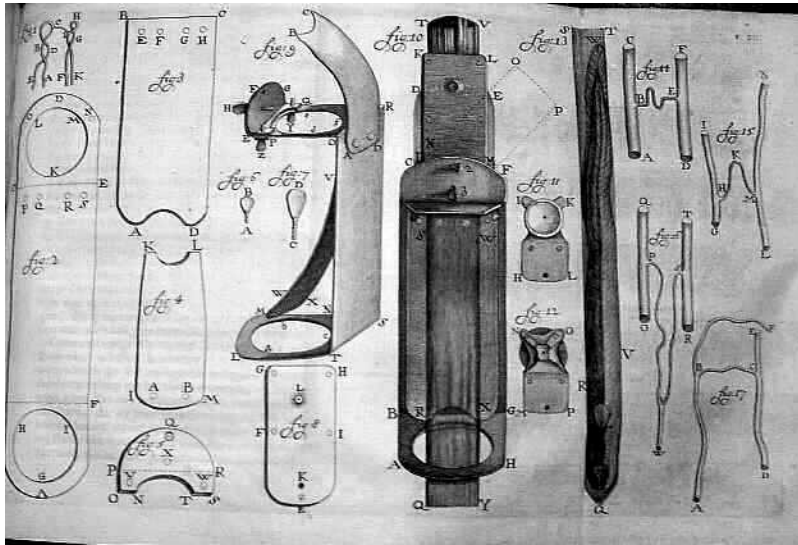

Leeuwenhoek
Microscope
(circa late 1600s)



Historie barvení biologických materiálů

Paul Ehrlich - 1879 použil kyselá a zásaditá barviva pro odlišení acidofilních, eosinofilních a neutrofilních leukocytů

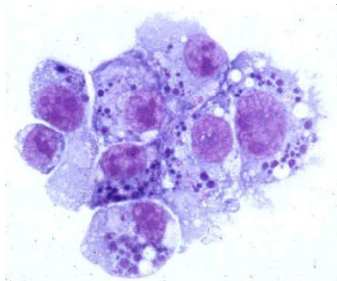

Clin Lab Med. 1993 Dec;13(4):759-71.

The Ehrlich-Chenzinsky-Plehn-Malachowski-Romanowsky-Nocht-Jenner-May-Grunwald-Leishman-Reuter-Wright-Giemsa-Lillie-Roe-Wilcox stain. The mystery unfolds.

Woronzoff-Dashkoff KP.

Historie barvení biologických materiálů

Princip fluorescenčního Mikroskopu - August Köhler - 1904



August Köhler
(1866-1948)

Köhler's Original Woodcut

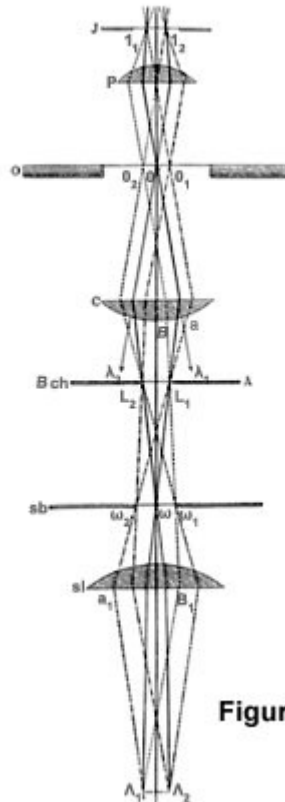
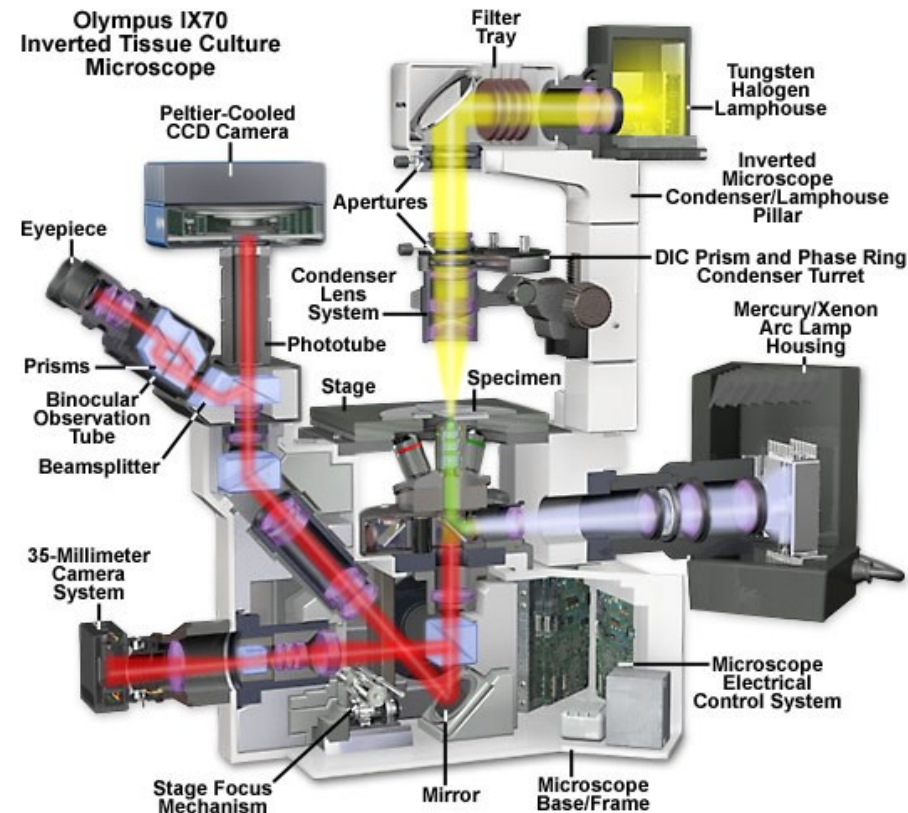
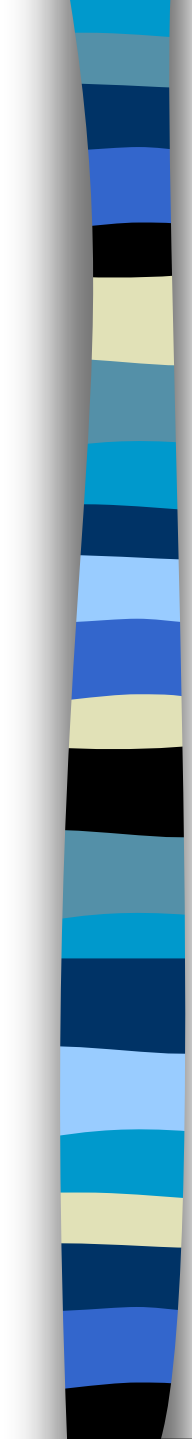

Figure 1





Coons et al 1941 – vyvinuli techniku fluorescenčního značení protilátek - označili anti-pneumokokové protilátky pomocí antracénu. To jim umožnilo detekovat protilátky i patogeny v tkáni pomocí UV fluorescence.

“Moreover, when Type II and III organisms were dried on different parts of the same slide, exposed to the conjugate for 30 minutes, washed in saline and distilled water, and mounted in glycerol, individual Type III organisms could be seen with the fluorescence microscope.....”

Immunological Properties of an Antibody Containing a Fluorescent Group

Albert H. Coons, Hugh J. Creech and R. Norman Jones

Department of Bacteriology and Immunology, Harvard Medical School, and the Chemical Laboratory, Harvard University
Proc. Soc. Exp.Biol.Med. 47:200-202, 1941

Coons a Kaplan (1950) - konjugovali fluorescein s isokyanátem (FITC) – získali lepší signál – dále od autofluorescence.

Friedman

Friedman (1950) – kombinoval kyselý fuchsin, akridinovou žlutá a berberin pro detekci buněk nádorů dělohy pomocí fluorescenčního mikroskopu

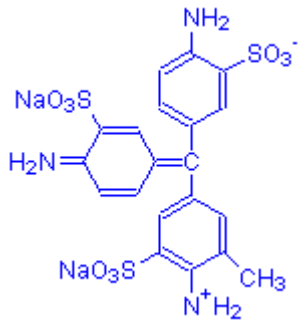

Acid Fuchsin

Acid magenta

Acid rubin

Acid roseine

Absorption Max 540-545

P.J. Crossland-Taylor

„Sheath Flow“ princip

“Provided there is no turbulence, the wide column of particles will then be accelerated to form a narrow column surrounded by fluid of the same refractive index which in turn is enclosed in a tube which will not interfere with observation of its axial content.”

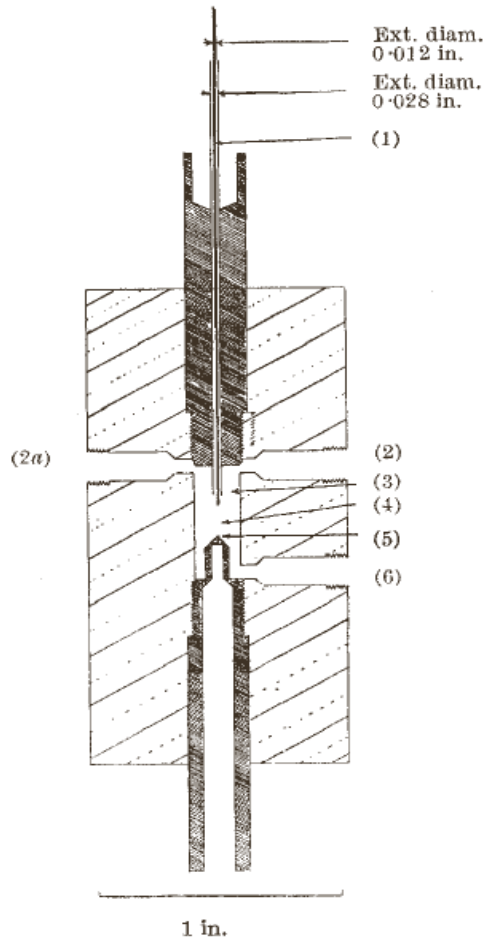

(1) Needle in holder; (2) and (2a) inflow tubes; (3) wide-bore tube; (4) observation area for (3); (5) vortex; (6) flushing tube

A Device for Counting Small Particles suspended in a Fluid through a Tube

ATTEMPTS to count small particles suspended in fluid flowing through a tube have not hitherto been very successful. With particles such as red blood cells the experimenter must choose between a wide tube which allows particles to pass two or more abreast across a particular section, or a narrow tube

P. J. CROSLAND-TAYLOR*

Bland-Sutton Institute of Pathology,
Middlesex Hospital,
London, W.1.
June 17.

No. 4340 January 3, 1953

NATURE

Wallace Coulter



- Wallace Coulter - Coulter orifice - 1956 -
- (patent 1953) – měření změny vodivosti během průchodu buněk v suspenzi malým otvorem

Originální
patentová
aplikace
W.Coultera 1953

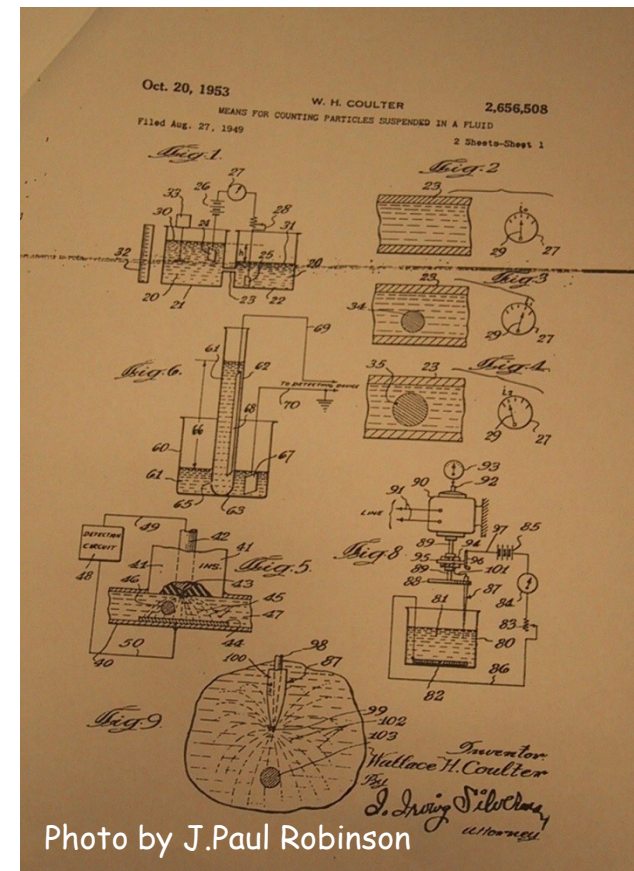
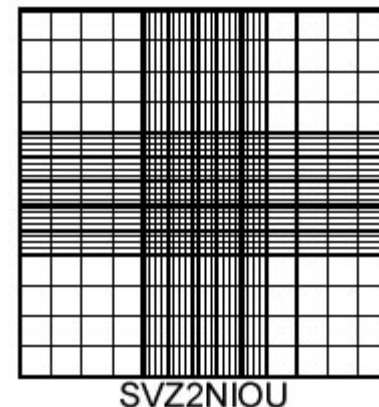
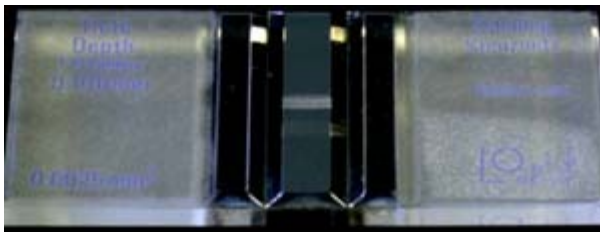

Photo by J.Paul Robinson

Jak počítat buňky?

- Hemocytometer (Bürkerova komůrka) byla standardem pro počítání buněk do ~ 1950
- Rozměry jsou 3x3x0.1 mm. Obvykle jsou červené krvinky ($1 \times 10^6/\text{mm}^3$) počítány po naředění 1:200
- Leukocyty ($5 \times 10^3/\text{mm}^3$) jsou ředěny 1:10 v roztoku lyzujícím červené krvinky
- Statistická chyba:
 - koeficient variance (CV) je při 500 spočítaných buňkách 4.4%
 - chyba pipetování a ředění je ~ 10%



Roche Innovatis Cedex

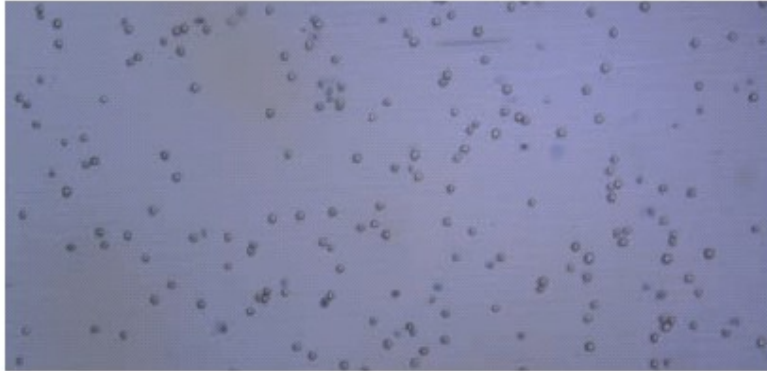

High Resolution Color Image

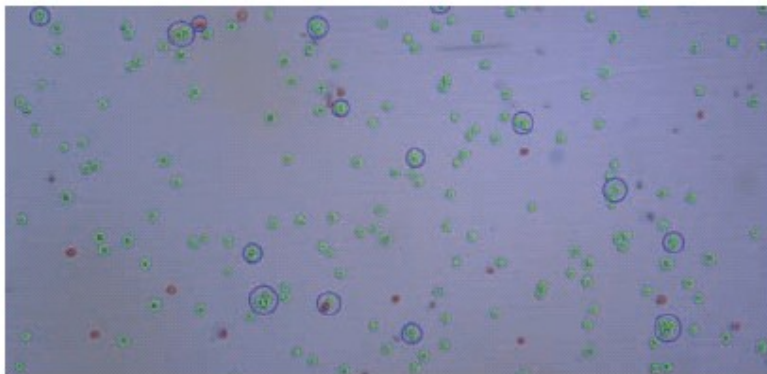

Visual Labeling



Coulter Counter



První komerční verze CC

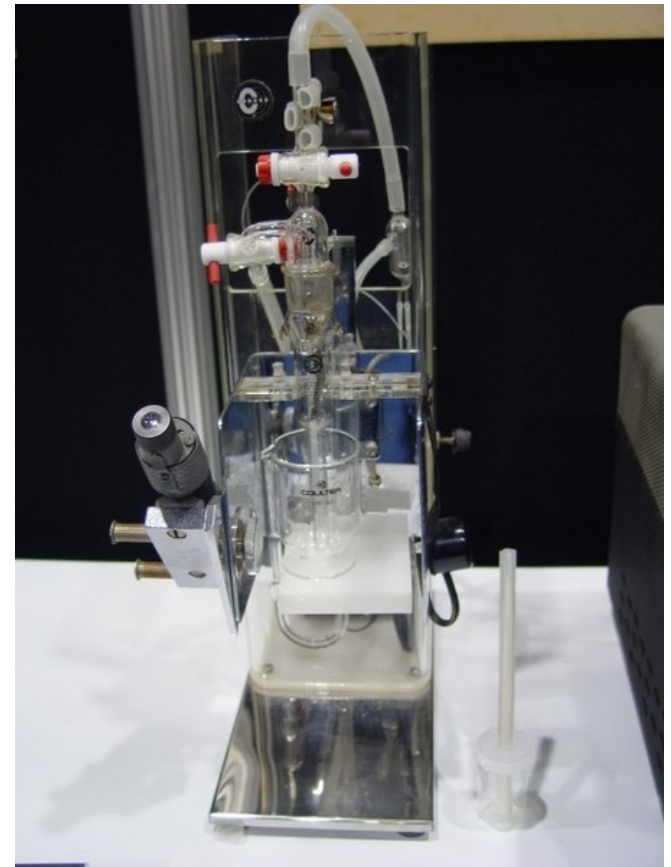

Coulter Counter

1-2

FIG. 1-1 FUNCTIONAL BLOCK DIAGRAM FOR MODEL ZF COUNTER

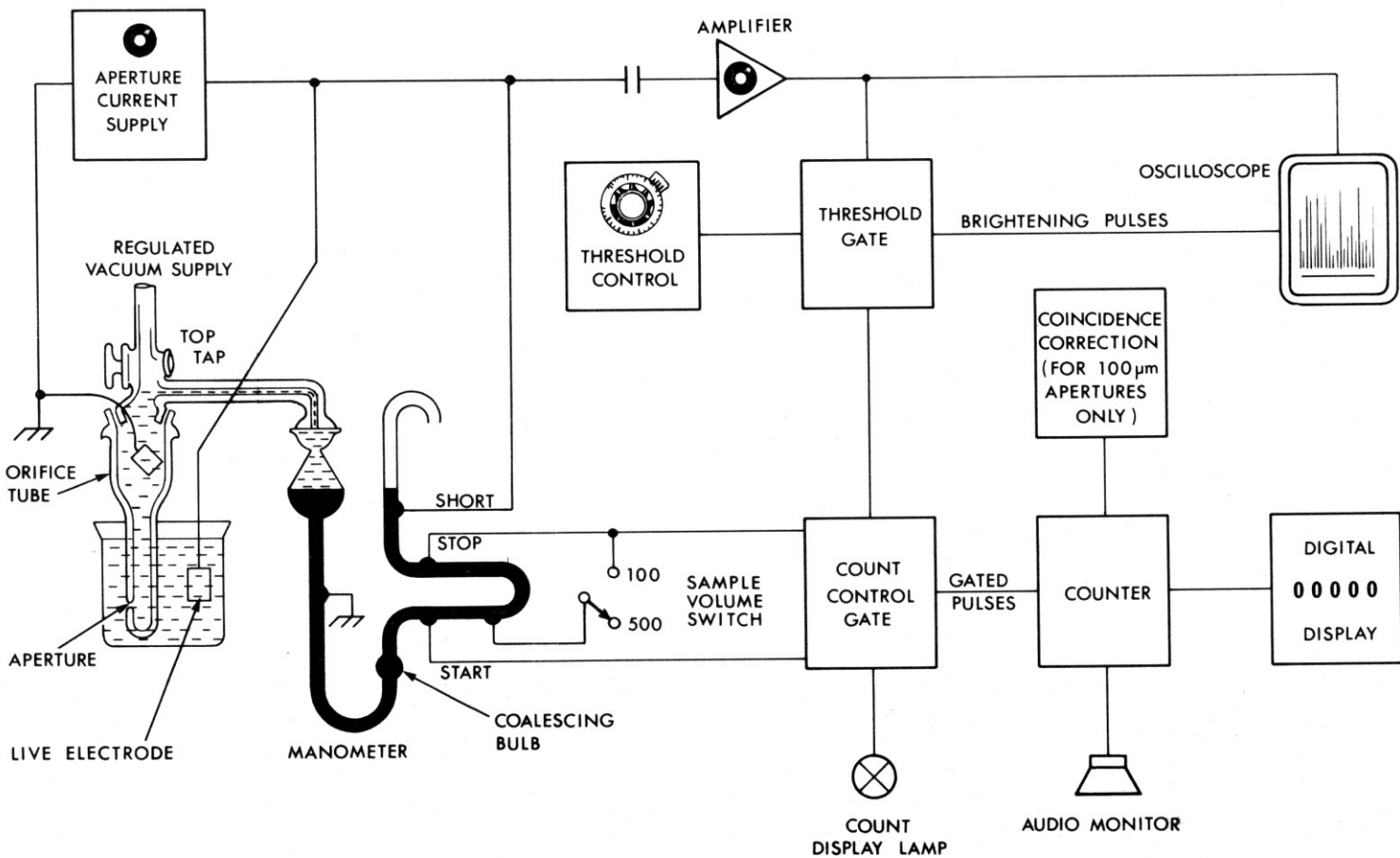

July '80

Beckman Coulter

■ Multisizer™ 3&4 COULTER COUNTER®

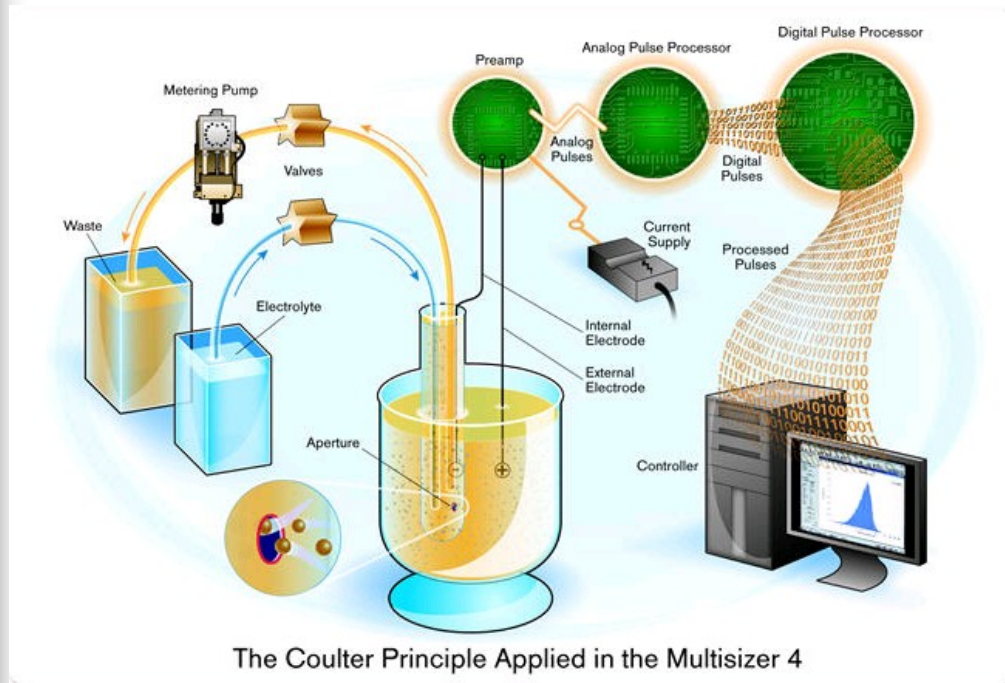

Roche Innovatis

CASY TT

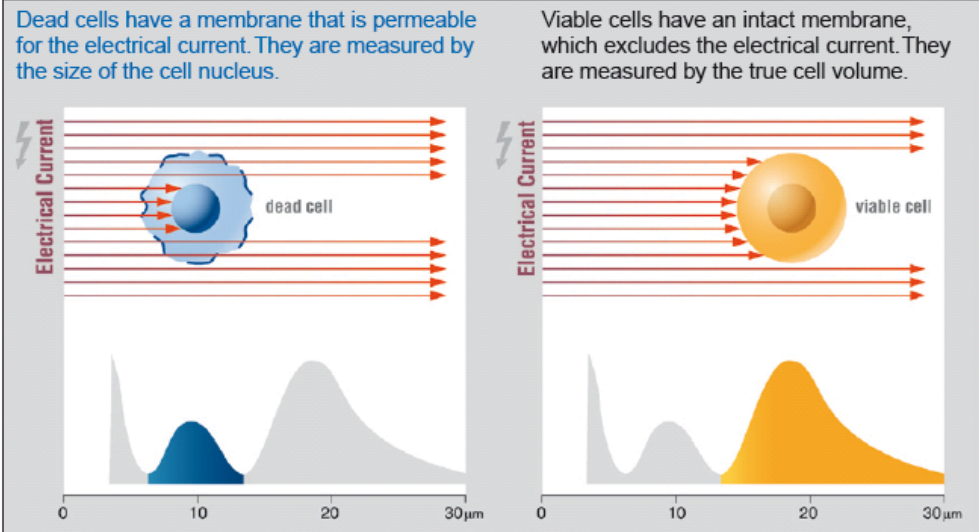

Figure 1: Viability Measurement by Electrical Current Exclusion. The status of the cell membrane distinctly affects the electrical signal generated when a cell is passing the measuring pore.



Cytograph. Stolní přístroj schopný měřit rozptyl světla **He-Ne laseru** (1970).

Mack Fulwyler- sorter

Mack Fulwyler - sorter 1965 - Los Alamos National Labs – jeho sorter separoval částice na základě elektronicky měřeného objemu (stejný princip jako Coulter counter) a separoval pomocí elektrostatického vychýlení.

Cílem bylo sortovat červené krvinky, protože u nich byla naměřena bimodální distribuce buněčného objemu. Princip separace byl založen na principu inkoustové tiskárny Richarda Sweeta ze Stanfordu (1965)

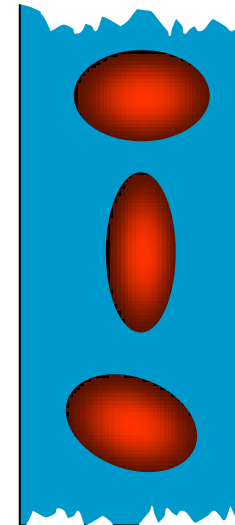
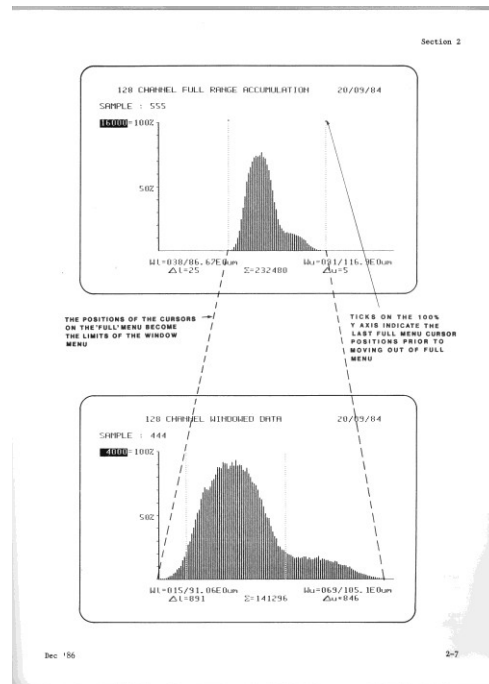

Po té co bylo objasněno, že bimodalita červených krvinek je artefakt byla tato skupina schopna separovat **neutrofilů a lymfocytů** z krve.

Richard Sweet

Richard Sweet vyvinul elektrostatickou inkoustovou tiskárnu jejíž princip využil Mack Fulwyler pro svůj buněčný sorter.

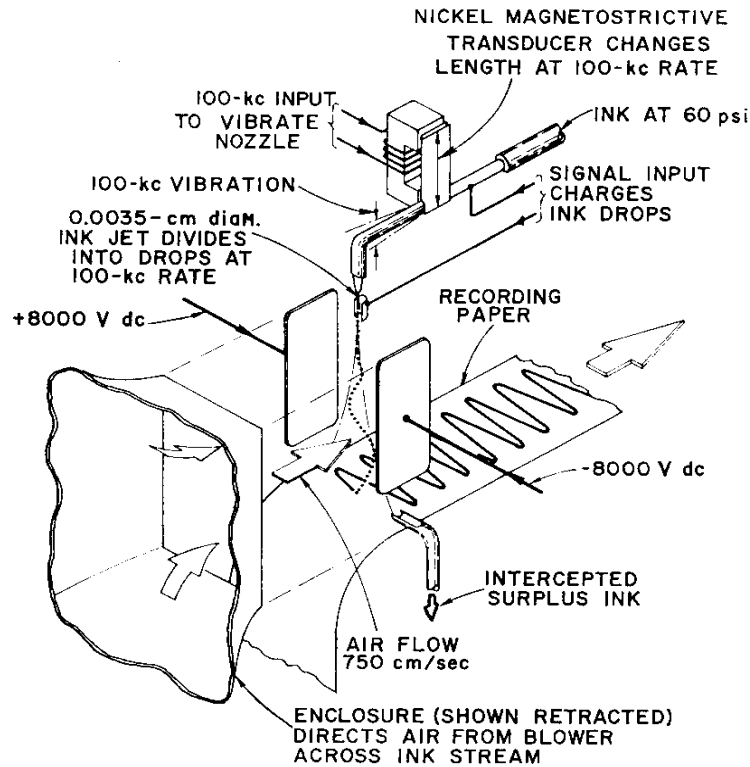

FIG. 1. Ink-jet oscillograph.

THE REVIEW OF SCIENTIFIC INSTRUMENTS

VOLUME 36, NUMBER 2

FEBRUARY 1965

High Frequency Recording with Electrostatically Deflected Ink Jets*

RICHARD G. SWEET
Systems Techniques Laboratory, Stanford Electronics Laboratories, Stanford University, Stanford, California
(Received 28 September 1964)

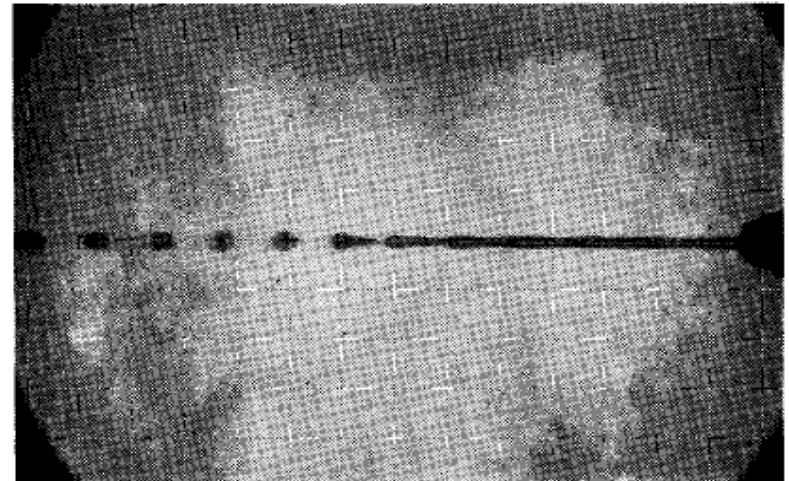
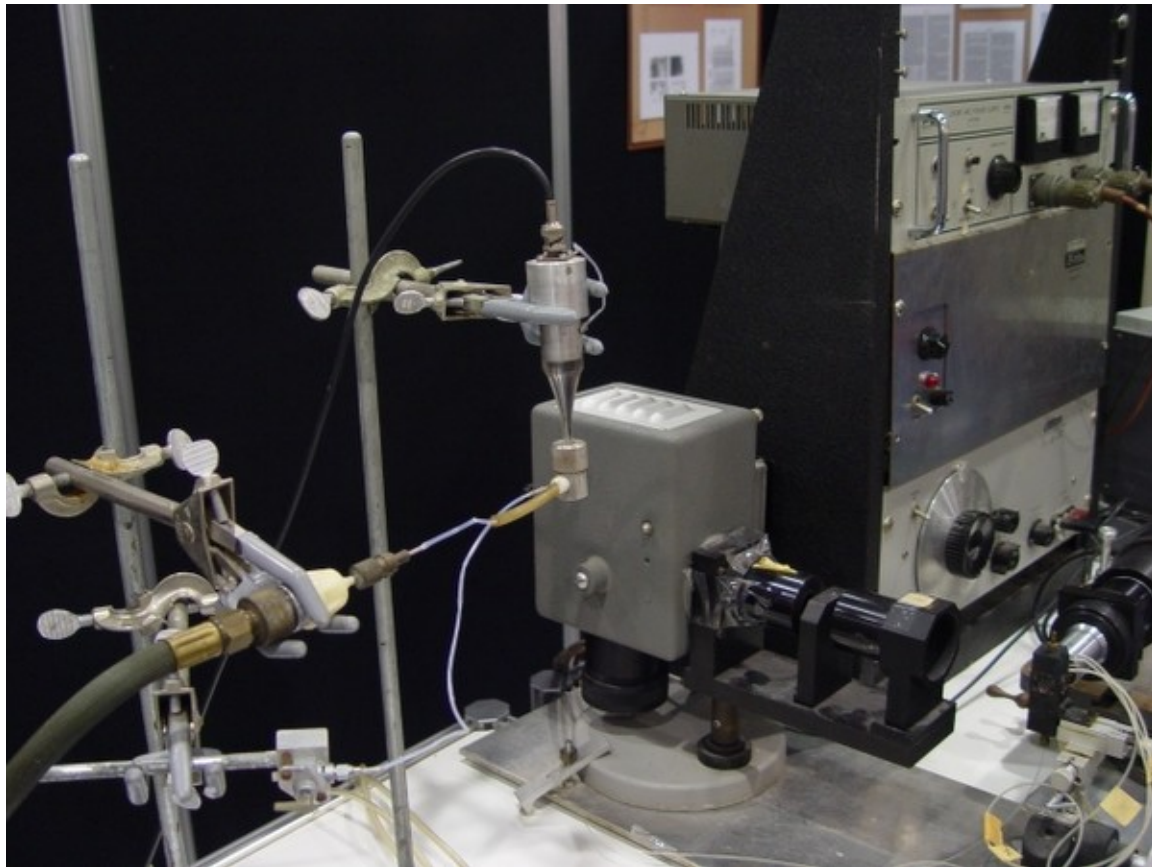
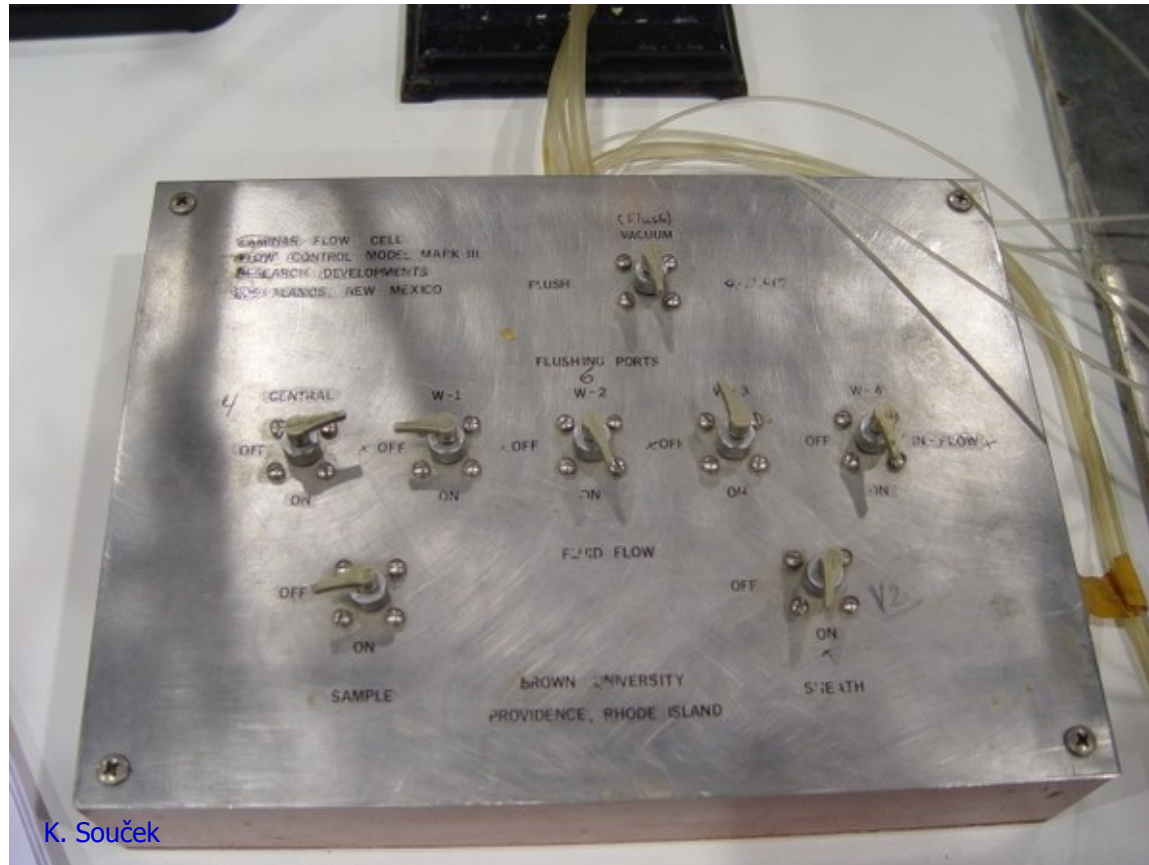

FIG. 3. Ink-drop formation.

Mack Fulwyler- sorter



Mack Fulwyler- sorter



K. Souček

Mack Fulwyler in His Own Words

J. Paul Robinson

Purdue University Cytometry Laboratories, Bindley Biosciences Center, Purdue University, West Lafayette, Indiana

Received 12 July 2005; Revision 15 July 2005; Accepted 15 July 2005

MACK FULWYLER IN HIS OWN WORDS

65

FIG. 1. The Fulwyler instrument as installed in Dr. Boris Rotman's Laboratory in Brown University, immediately prior to disassembly in March 2005. The instrument had not been altered or moved since installation in 1967, except for the addition of a laser instead of the UV lamp.



April 30, 1968

M. J. FULWYLER

3,380,584

PARTICLE SEPARATOR

Filed June 4, 1965

5 Sheets-Sheet 1

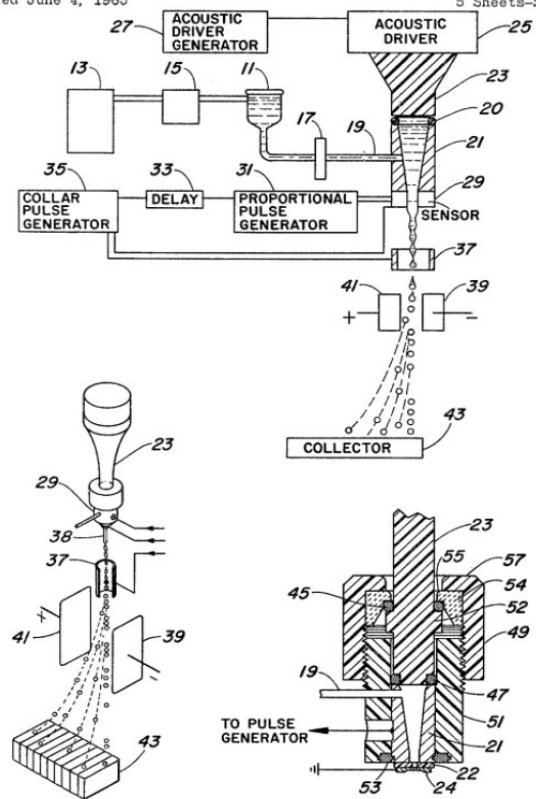

FIG. 4. A page from Fulwyler's patent on the cell separation technology patent #3,380,584 showing the fundamental components of the invention of the cell sorter.

INVENTOR.
Mack J. Fulwyler
BY
Richard A. Robinson
Attorney

Leonard Arthur "Len" Herzenberg

From Hulett, HR, Bonner, WA, Barrett, J, and Herzenberg, LA. Cell Sorting: Automated Separation of Mammalian Cells as a Function of Intracellular Fluorescence. Science 1969; 166: 747-749. Reprinted with permission from AAAS.

Cell Sorting: Automated Separation of Mammalian Cells as a Function of Intracellular Fluorescence

Abstract. A system for high-speed sorting of fluorescent cells was able to sort mouse spleen cells from Chinese hamster ovarian cells after development of fluorochromasia. Highly fluorescent fractions separated after similar treatment from mouse spleen cells immunized to sheep erythrocytes were enriched in antibody-producing cells by factors of 4 to 10.



Klíčové „cytometrické“ publikace

- 1934: Moldovan – Fotoelektrické měření buněk v kapiláře
- 1947: Gucker – fotoelektrické počítání buněk
- 1949: Coultrův počítač částic
- 1961: Rotman poprvé používá fluorescenci pro kvantifikaci enzymatické reakce
- 1964: Sweet – elektrostatická inkoustová tiskárna
- 1965: Fulwyler – květen 1965 - patent elektrostatického sorteru
- 1965: Kanetsky – spektrofotometrické měření buněk
- 1965: Fulwyler – listopad 1965 – publikace o buněčné separaci v časopise Science
- 1968: Gohde – první článek o fluorescenční průtokové cytometrii (v němčině)
- 1969: Gohde – patent
- 1969: Van Dilla – druhý článek o fluorescenční průtokové cytometrii
- 1969: Mullaney – první článek věnující se popisu rozptylu světla jako cytometrického parametru
- 1969: Heryenberg – třetí článek o fluorescenční průtokové cytometrii
- 1973: Gohde – patent dvojího značení
- 1977: Gohde – popis kompenzací signálu při dvojtém značení
- 1978: Kachel – flow imaging – kombinace průtokové cytometrie a analýzy obrazu
- 1983: izolace a detekce jader (DNA) z tkání zalitých v parafínu
- 1984: kongres o nomenklatuře cytometrie DNA
- 1987: Graz - vysokorychlostní sortování chromozómů
- 1991: Robinson – automatizace klinických systémů – průtokový cytometr a čtečka čárkových kódů

K čemu to všechno je... například...

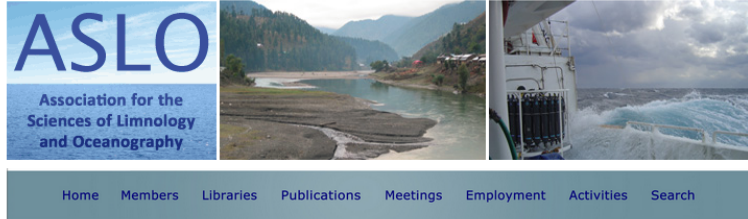

Position Announcements

Flow Cytometer Research Technician

Flow Cytometer - Research Technician

The Ocean Biogeochemistry Laboratory at Bigelow Laboratory of Ocean Sciences is seeking an energetic and motivated technician to join our research group. The primary responsibility of the successful candidate will be operation of our high-speed flow cytometer/ cell sorter in support of our oceanographic research. This technical position requires extensive knowledge of cytometric principles, an ability to troubleshoot and maintain analytical instrumentation, prior experience in method development, a willingness and capability of going to sea to operate the flow cytometer (cruises from 1 to several weeks), and a high degree of self-confidence and independence. A wide diversity of sample types are analyzed ranging from enumerating and sorting single cells from oceanic samples to quantification of cellular rate processes employing fluorogenic assays to combining isotopic methods with flow sorting.

The successful applicant must have at least a B.Sc. degree and 2+ years of demonstrated experience with flow cytometric cell sorters as a primary operator. The successful applicant must also be highly organized, have a strong ability to multi-task, be self-confident and independent. This position will initially be for one year with continuation for additional years based upon successful job performance.

Send CV, cover letter, and contact information for 3 references to jobs@bigelow.org. Please reference (RT-2012-4) in the subject line. Review of applicants will begin immediately and continue as applications are received until the position is filled. The preferred starting date is no later than 1 January 2013, but this may be negotiated. Salary will be commensurate with prior experience. Bigelow Laboratory is an Equal Opportunity Employer.

Submission Forms

[Submit Job Announcements](#)

[Submit Student Opportunities](#)

Employment and Student Opportunities

[Positions Offered](#)

[Student Opportunities](#)

[Job-Related Links](#)

Career Information

[Aquatic Science Careers](#)

[Careers in Public Policy](#)

[Early Career Scientists](#)

Programs and Opportunities

[Programs for Recent PhDs](#)

Position Available

FLOW CYTOMETRY TECHNICIAN

Oceanography, MIT

The Chisholm Laboratory at MIT (<http://web.mit.edu/chisholm/www/>) is seeking a full-time flow cytometry technician to participate in research involving oceanic cyanobacteria. The position requires a Bachelors degree in science or engineering and two years experience. Applicants must have a solid background in and experience with flow cytometry, including extensive knowledge of hardware, data analysis, and experimentation. Duties include maintenance of flow cytometry instruments, experimentation, and assisting other lab members with flow cytometry as needed. Must be able to work as a member of a multidisciplinary team. Quantitative methods. Full-time.

Please send a resume and 3 letters of recommendation to Dr. Marcia Osburne (mosburne@mit.edu), or Dr. Marcia Osburne, MIT, 15 Vassar St. rm 48-336B, Cambridge, MA 02139



[Home](#) [About Us](#) [Academics](#) [Faculty](#) [Research Affiliates](#) [Marine Operations](#) [Public](#)

ABOUT US

- [About Us](#)
- [Contact Information](#)
- [Map & Directions](#)

ANNOUNCEMENTS

- [Employment Opportunities](#)
- [Events](#)
- [News](#)
- [Seminars](#)

4/9/12 - Job Opportunity: Biological Oceanography Technician

Date: April 9, 2012 - 8:00am
Biological Oceanography - Job Opportunity

The Biological Oceanography Lab is seeking assistance (half-time or more) on Dr. Welschmeyer's ballast treatment testing project associated with the California Maritime Academy (CMA). The duties will include training/execution

many routine chemical and biological oceanographic analyses (e.g., DOC/POC, chlorophyll a, live organism microscopy, epifluorescence microscopy, flow cytometry, bacteria culturing assays, etc.). The employee will travel often between MLML and CMA.

Requirements: the employee must be available for two consecutive 48 hour periods (or more) each week; full time work is ideal. (Student schedules with M-W or T-Th classes will not work). A willingness to work long hours (odd hours) is mandatory; excellent pipeting skills, notetaking, and spreadsheet skills would be appreciated (state drivers license is helpful). Pay is \$20/h immediately; work will proceed through summer with possible sampling trips to southern California and South America.

Please contact Dr. Nick Welschmeyer by email (Welschmeyer@mml.calstate.edu) for information.



K čemu to všechno je... například...

- 43 miliónů lidí na světě je infikováno virem HIV (WHO)
- ročně zemře ~ 2 miliónu lidí na HIV/AIDS (v Africe je ~ 11 miliónu AIDS sirotků)
- kvantifikace CD4 T lymfocytů je klíčový parametr při monitorování léčby
- Průtoková cytometrie je „zlatý standard“
- Optimalizované postupy a zařízení pro levné (< 3 EUR / vzorek) a rychlé detekce (250 vzorků / den)
- [Aydogan Ozcan](#): „Kill the cost, safe live“

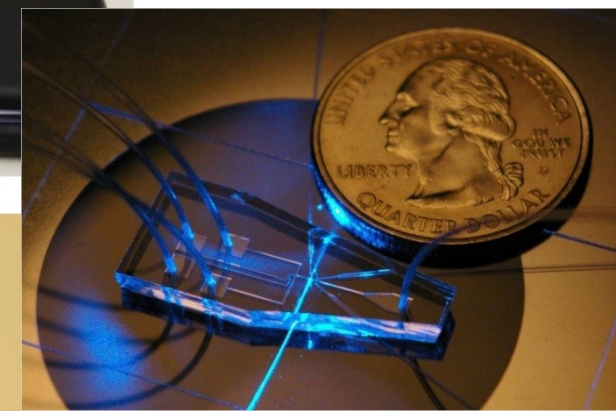
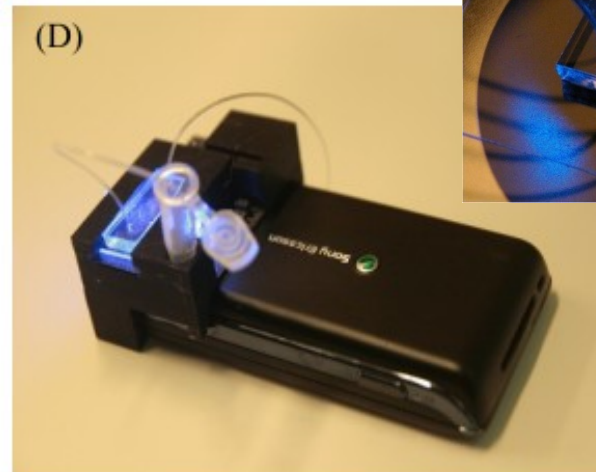
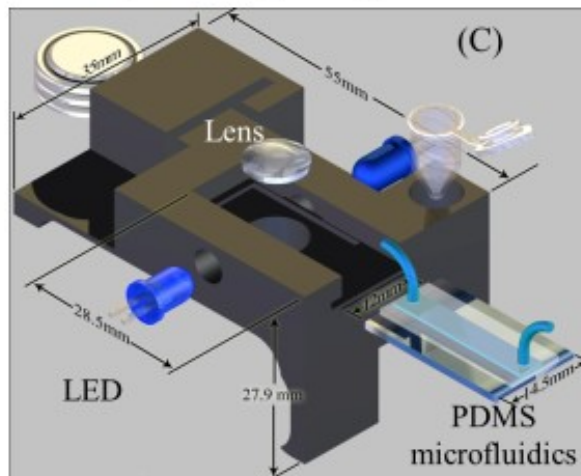
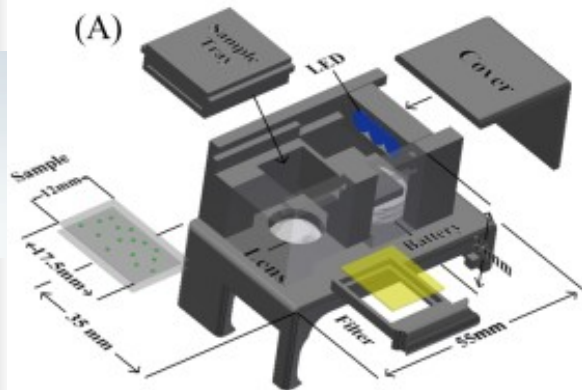



Co tomu předcházelo...

- Rozvoj techniky umožňující rychlou a reprodukovatelnou detekci cytometrických parametrů.
- Nové vědecké poznatky vedoucí k definici vhodných diagnostických markerů.

ISAC presents: Mack Fulwyler - Innovator, Inventor & Pioneer

<http://www.cyto.purdue.edu/cdroms/gh/HTML/start.htm?loc=http://www.cyto.purdue.edu/cdroms/gh/HTML/video/video.html?v=Flowtheinvention.wmv>

<http://www.cyto.purdue.edu/cdroms/cyto10a/seminalcontributions/fulwyler.html>



Informační zdroje – průtoková cytometrie

- Practical Flow Cytometry, Howard M. Shapiro, Wiley-Liss; 4th edition
- Cytometry: New Developments, Volume 75, Fourth Edition (Methods in Cell Biology), Zbigniew Darzynkiewicz, Academic Press; 4th edition
- Průtoková cytometrie v klinické praxi, T. Eckschlager a kol., Grada 1999
- Flow Cytometry with Plant Cells: Analysis of Genes, Chromosomes and Genomes; Jaroslav Dolezel (Editor), Johann Greilhuber (Editor), Jan Suda (Editor), February 2007

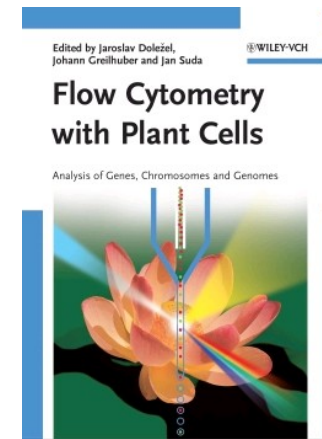
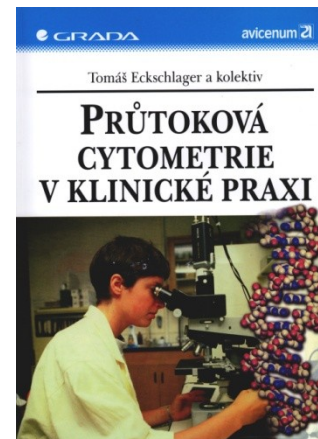
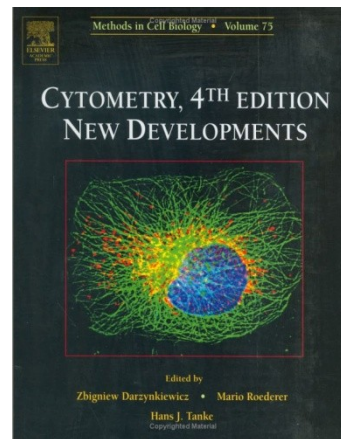
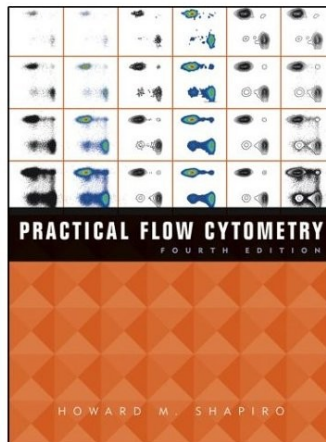

Tyto knihy je možné zapůjčit po domluvě ke studiu do knihovny BFÚ.

Více informací o knihách o průtokové cytometrii najdete na:

<http://www.cyto.purdue.edu/flowcyt/books/bookindx.htm>

Informační zdroje – průtoková cytometrie (metody a protokoly)

- The Handbook of Flow Cytometry Methods
- Current Protocols in Cytometry

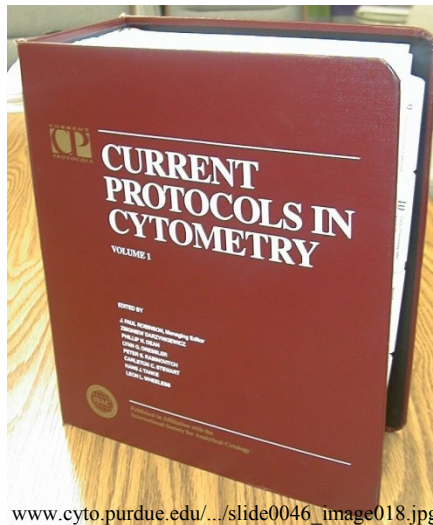

www.cyto.purdue.edu/.../slide0046_image018.jpg

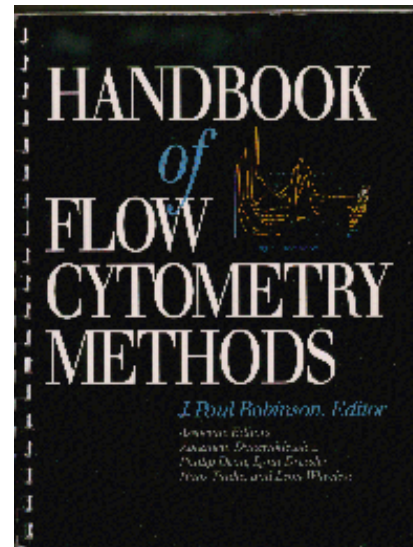

Tyto knihy je možné zapůjčit po domluvě ke studiu do knihovny BFÚ.

Více informací o knihách o průtokové cytometrii najdete na:

<http://www.cyto.purdue.edu/flowcyt/books/bookindx.htm>

Informační zdroje – cytometrie (časopisy)

■ Cytometry Part A

<http://www3.interscience.wiley.com/cgi-bin/jhome/33945>



■ Cytometry Part B: Clinical Cytometry

<http://www3.interscience.wiley.com/cgi-bin/jhome/102019902>



Jednotlivá čísla Cytometry Part A (od roku 2000 je možné zapůjčit po domluvě ke studiu do knihovny BFÚ).



Informační zdroje – (Internet)

- Purdue University, Cytometry Labs

<http://www.cyto.purdue.edu/>

- International Society for Analytical Cytology

<http://www.isac-net.org/>

- Molecular Probes (Invitrogen)

<http://probes.invitrogen.com/handbook/>

fluidics

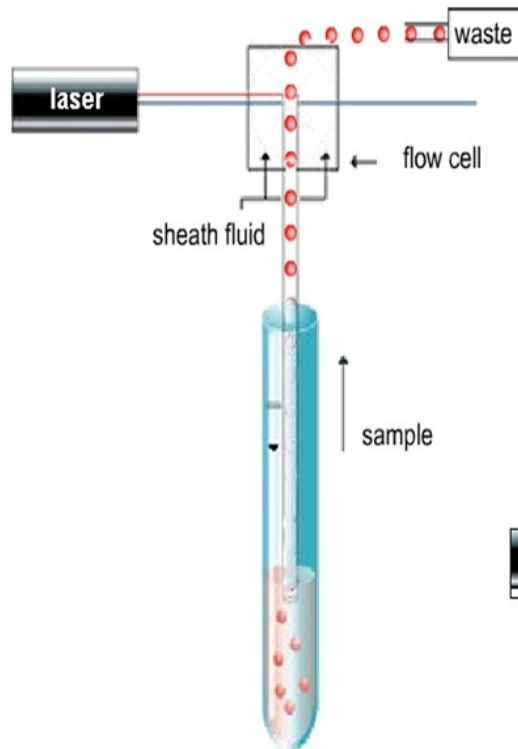

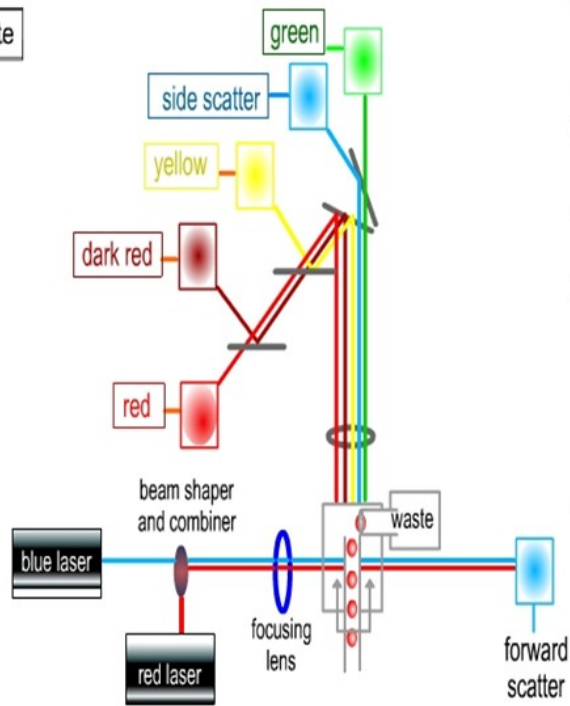

optics

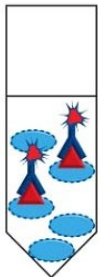
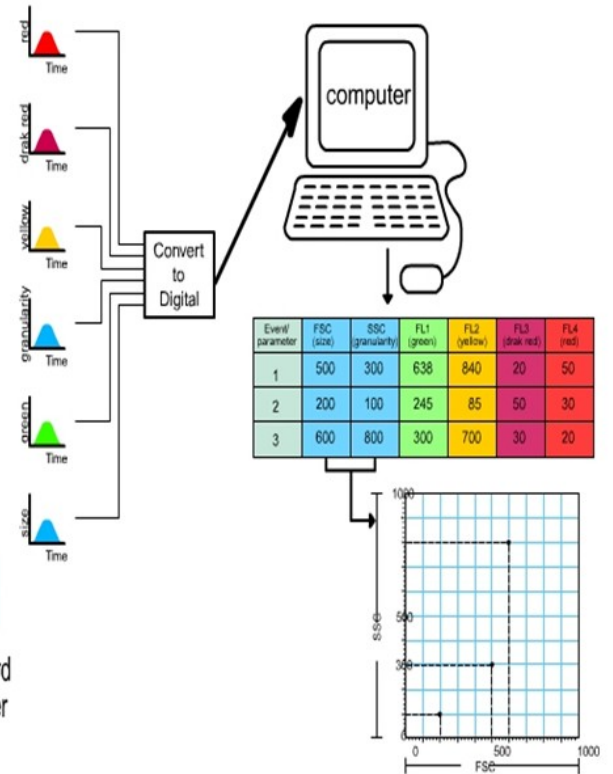

electronics



Key

-  Cell
-  Antigen
-  Fluorochrome conjugated Primary antibody

Fluidika - Laminární vs. turbulentní proudění

- **Turbulentní** proudění je charakteristické chaotickými (stochastickými) změnami
- **Laminární** proudění – kapalina proudí v paralelních vrstvách které se vzájemně nemísí



Rozptyl světla

- Hmota rozptyluje světlo vlnových délek které není schopna absorbovat
- Viditelné spektrum je 350-850 nm proto malé částice a molekuly ($< 1/10 \lambda$) spíše viditelné světlo rozptylují
- Pro malé částice byl popsán tzv. **Rayleightův rozptyl (scatter)** jehož intenzita je \sim stejná všemi směry
- Rozptyl větších částic charakterizuje tzv. **Mieův rozptyl**. Jeho množství je větší ve směru v jakém dopadá světlo na ozářenou částici \Rightarrow *na tomto principu je založeno měření velikosti částic pomocí průtokového cytometru*

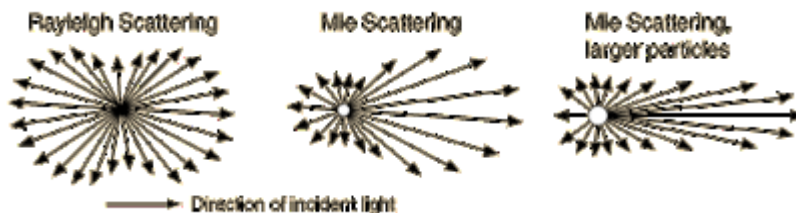

George Gabriel Stokes (1819 – 1903)

Anglický fyzik a matematik
působící na univerzitě v Cambridge

1852 – popsal fluorescenci

Název vznikl z anglického slova *fluospar*
(fluorit, kazivec = nerost CaF_2)

- ke svému pozorování použil roztok
chininu, jako zdroj světla sluneční
paprsky, jako excitační filtr sloužilo tmavě
modré okenní sklo a jako emisní filtr byla
použita sklenice bílého vína

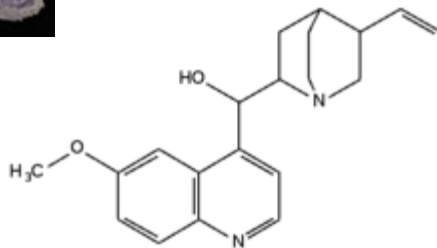

<http://www.nndb.com/people/131/000097837/>

G. C. Stokes „*On the Change of Refrangibility of Light*“ *Philosophical Transactions of the Royal Society of London*, 1852, vol. 142, p. 463.)

[463]

XXX. *On the Change of Refrangibility of Light.* By G. G. STOKES, M.A., F.R.S.,
Fellow of Pembroke College, and Lucasian Professor of Mathematics in the
University of Cambridge.

Received May 11,—Read May 27, 1852.

Princip fluorescence

Fluorescence je výsledek tří fázového u jevu některých chemických látek - fluorochromů, fluorescenčních barev. Fluorescenční značka (próba) -fluorochrom schopný lokalizace do určitého biologického vzorku nebo odpovídat na specifický podnět.

Stage 1 : Excitation

A photon of energy $h\nu_{EX}$ is supplied by an external source such as an incandescent lamp or a laser and absorbed by the fluorophore, creating an **excited electronic singlet state (S_1')**. This process distinguishes fluorescence from chemiluminescence, in which the excited state is populated by a chemical reaction.

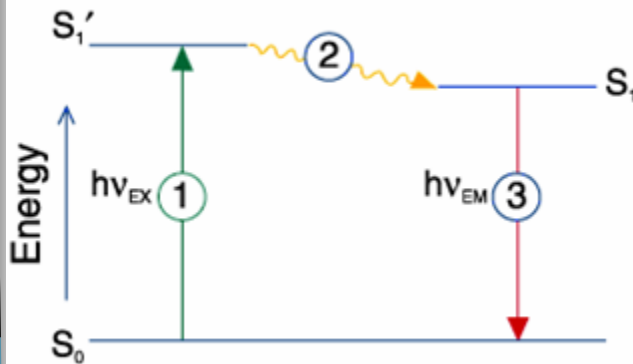

Jablonski diagram illustrating the processes involved in the creation of an excited electronic singlet state by optical absorption and subsequent emission of fluorescence. The labeled stages 1, 2, 3 are referred to in the text.

Stage 2 : Excited-State Lifetime

The excited state exists for a finite time (typically 1–10 10^{-9} seconds). During this time, the fluorophore undergoes conformational changes and is also subject to a multitude of possible interactions with its molecular environment. These processes have two important consequences. First, the energy of S_1' is partially dissipated, yielding a relaxed singlet excited state (S_1) from which fluorescence emission originates. Second, not all the molecules initially excited by absorption (Stage 1) return to the ground state (S_0) by fluorescence emission. Other processes such as collisional quenching, fluorescence energy transfer and intersystem crossing (see below) may also depopulate S_1 . The fluorescence quantum yield, which is the ratio of the number of fluorescence photons emitted (Stage 3) to the number of photons absorbed (Stage 1), is a measure of the relative extent to which these processes occur.

Stage 3 : Fluorescence Emission

A photon of energy $h\nu_{EM}$ is emitted, returning the fluorophore to its ground state S_0 . Due to energy dissipation during the excited-state lifetime, the energy of this photon is lower, and therefore of longer wavelength, than the excitation photon $h\nu_{EX}$. The difference in energy or wavelength represented by $(h\nu_{EX}-h\nu_{EM})$ is called the **Stokes shift**. The Stokes shift is fundamental to the sensitivity of fluorescence techniques because it allows emission photons to be detected against a low background, isolated from excitation photons. In contrast, absorption spectrophotometry requires measurement of transmitted light relative to high incident light levels at the same wavelength.



Fluorescenční spektra

Fluorescenční proces je cyklický.

Kromě fluorochromu nevratně zničeného (photobleaching - „vysvícení“) může být opakovaně excitován.

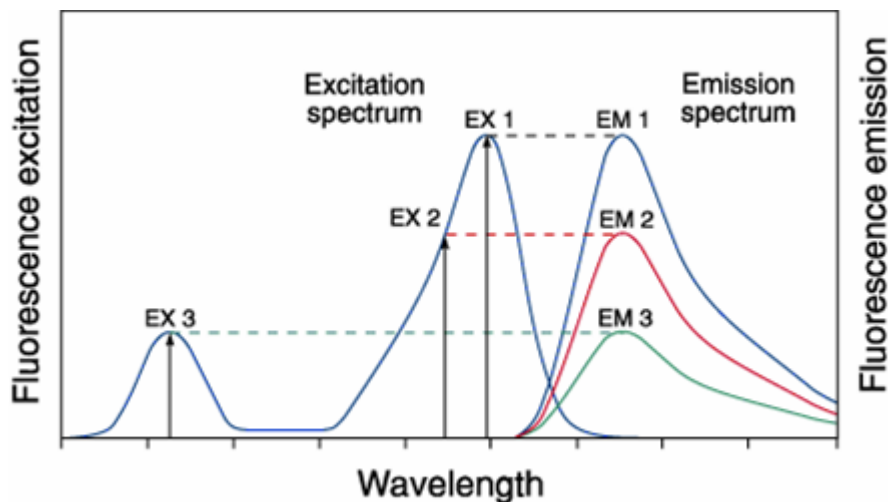

Excitation of a fluorophore at three different wavelengths (EX 1, EX 2, EX 3) does not change the emission profile but does produce variations in fluorescence emission intensity (EM 1, EM 2, EM 3) that correspond to the amplitude of the excitation spectrum.

Detekce fluorescence

Vybavení pro fluorescenci

- (1) zdroj excitace
- (2) fluorochrom
- (3) vlnové filtry pro izolaci emitovaných fotonů od excitovaných
- (4) detektory pro registraci emitovaných fotonů

Fluorescenční přístroje

- spektrofluorometer měří průměrné vlastnosti objemu vzorku v kyvetě.
- fluorescenční mikroskop popisuje fluorescenci jako jev v prostorovém systému souřadnic
- flow cytometr měří fluorescenci v proudícím toku, umožňuje detekovat a kvantifikovat subpopulace uvnitř velkého vzorku

Fluorescenční signál

- spektrofluorometer je flexibilní, umožňuje měřit v kontinuálním spektru excitačních a emisních vlnových délek
- flow cytometr potřebuje fluorescenční značky excitovatelné určitou vlnovou délkou.

Fluorescence pozadí

- endogenní složky - autofluorescence
- nenávanané nebo nespecificky vázané značk
= reagenční pozadí

Vícebarevné značení

- dvě a více značek, zároveň monitoruje různé funkce
- nutné: vhodně zvolit značky zdroj excitace a separační filtry

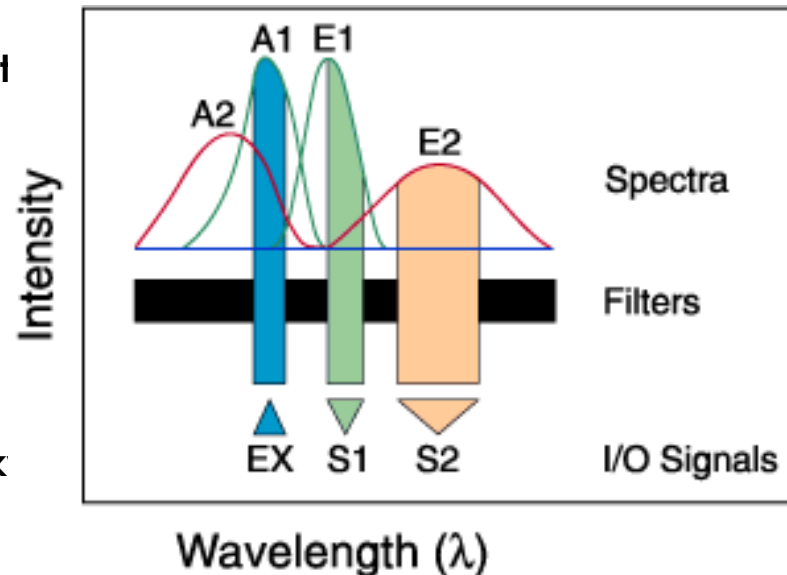

Fluorescence Output of Fluorophores

Comparing Different Dyes

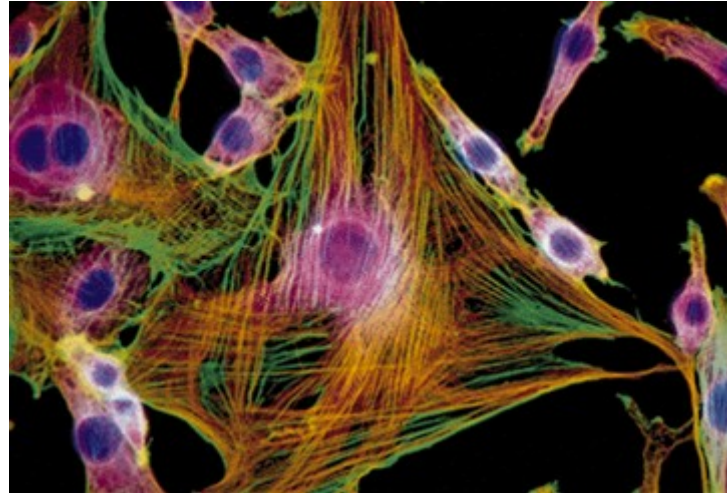
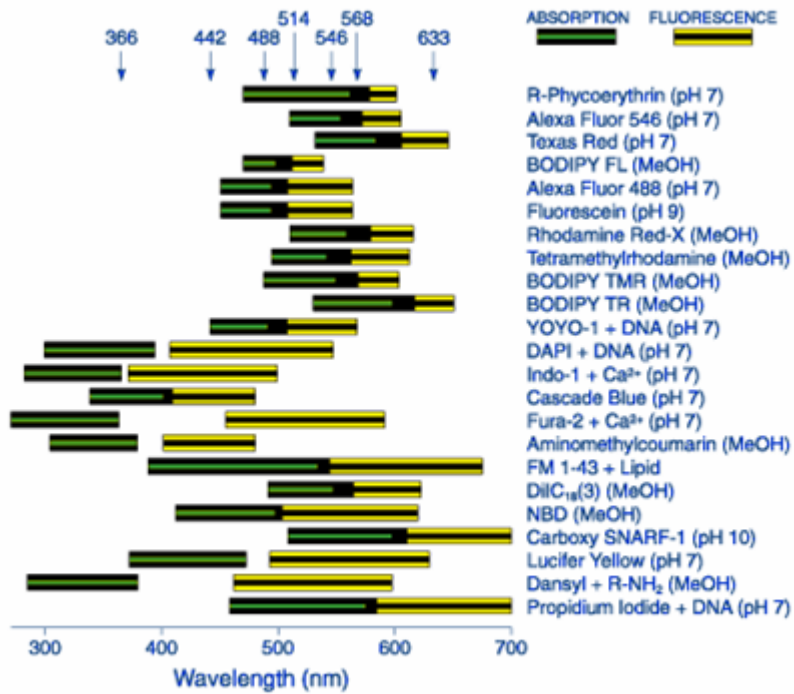

Mouse 3T3

F-actin ~
BODIPY FL phalloidin

anti- β tubulin ~
Texas Red
goat anti-mouse IgG

DNA ~
DAPI

POPO-1
BOBO-1
YOYO-1
TOTO-1
JOJO-1
POPO-3
LOLO-1
BOBO-3
YOYO-3
TOTO-3

λ Hind III

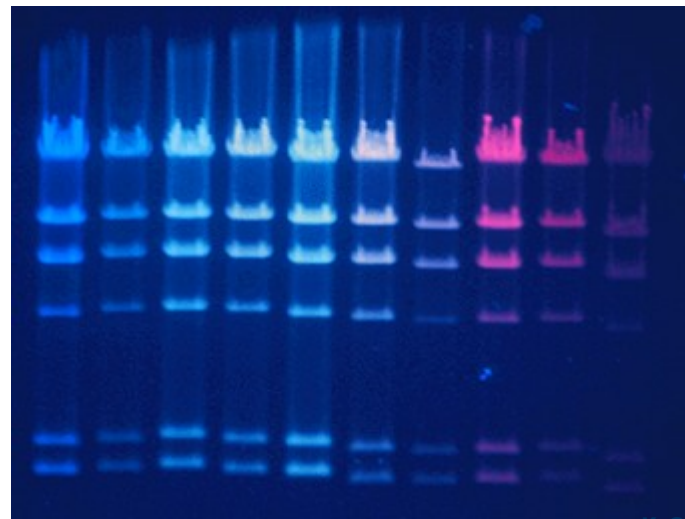
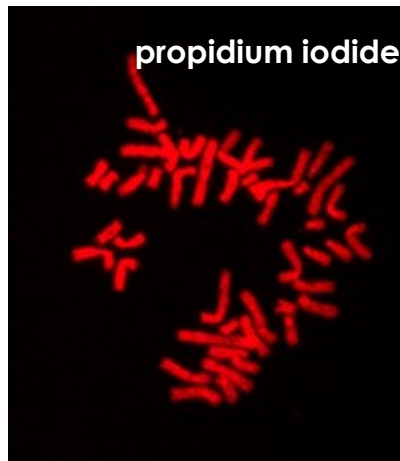

BD LSR II system

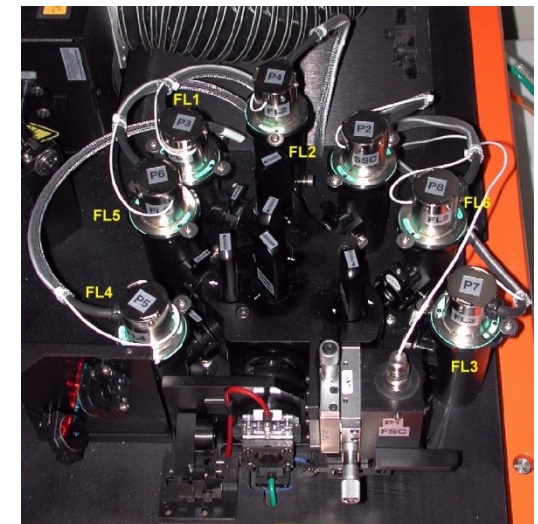
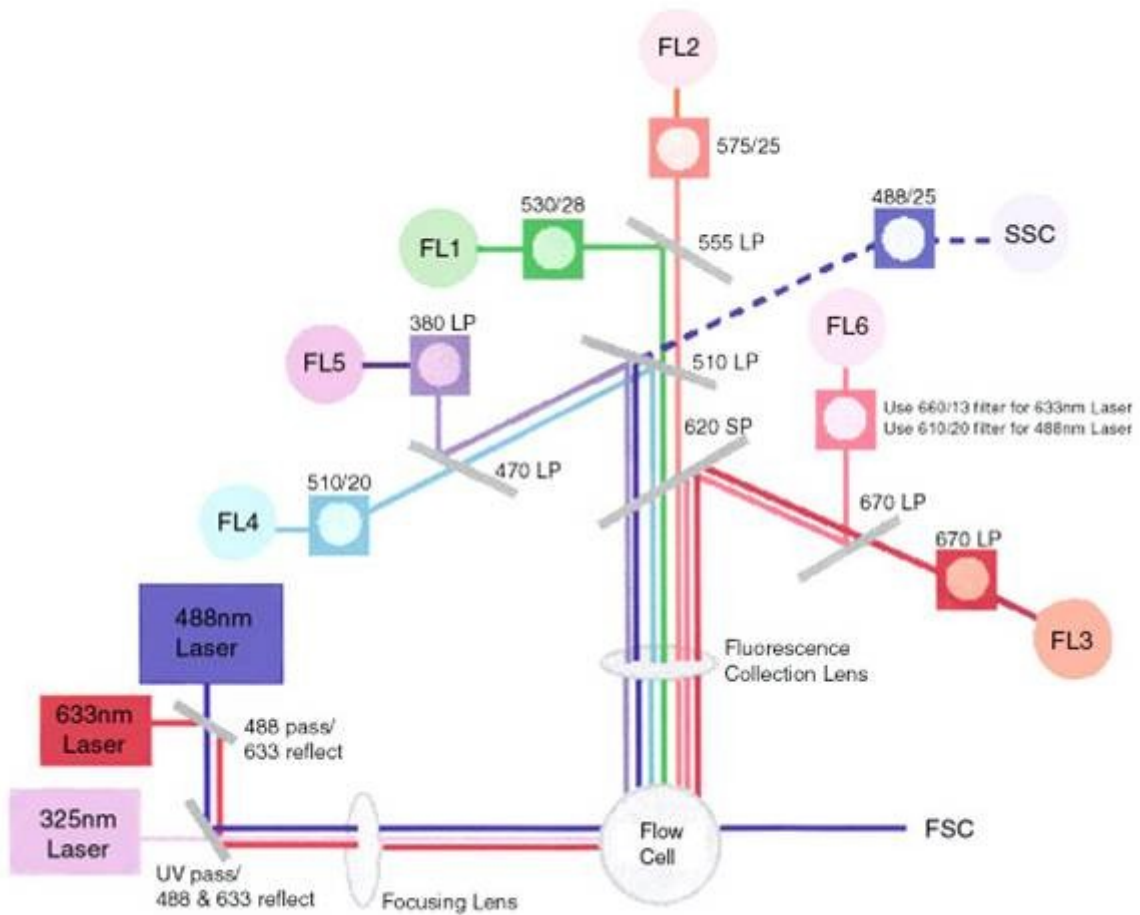



life technologies™

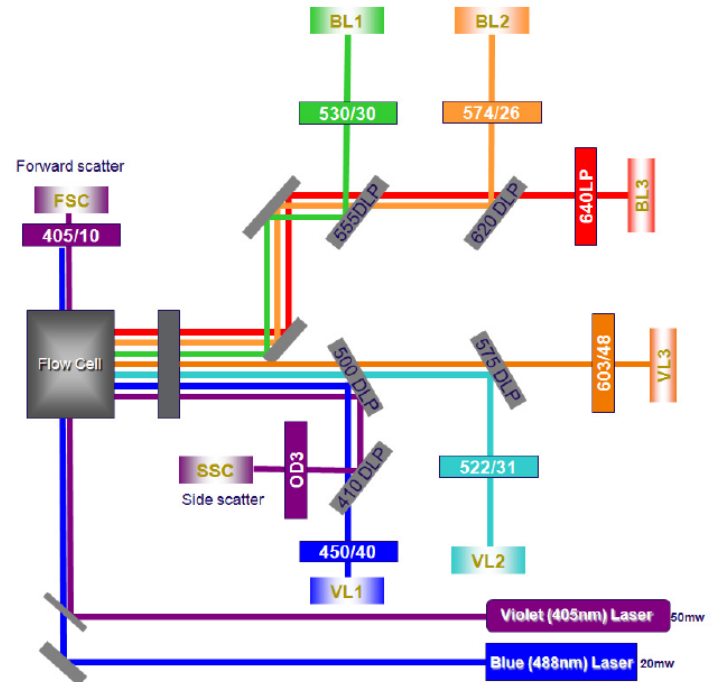
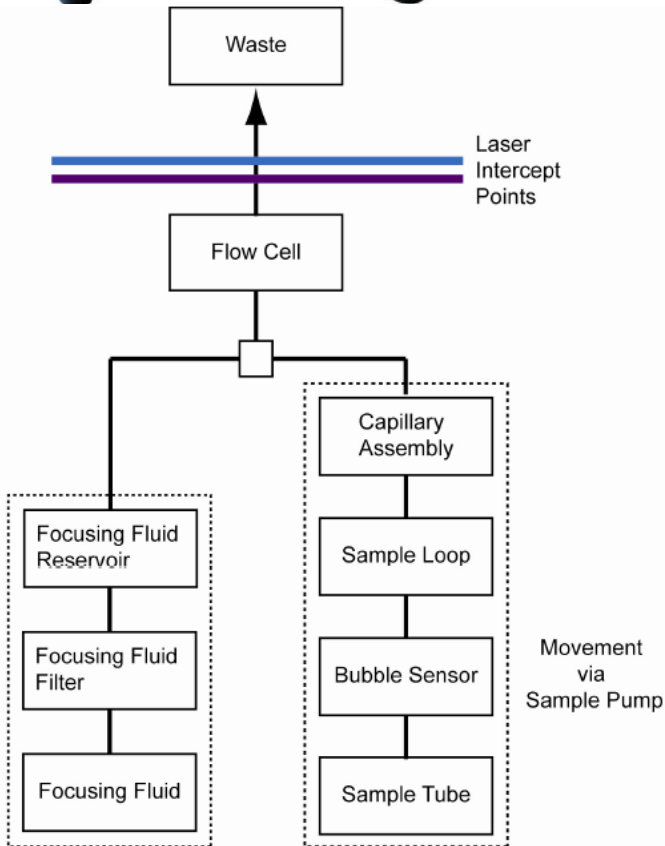

Způsoby pro zobrazení dat

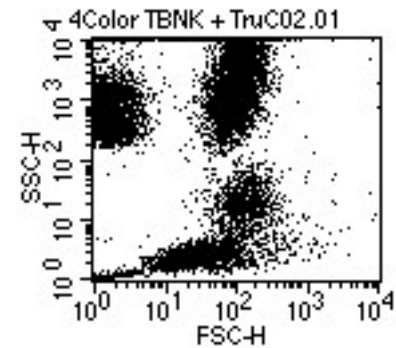
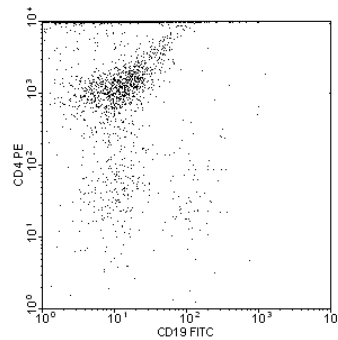
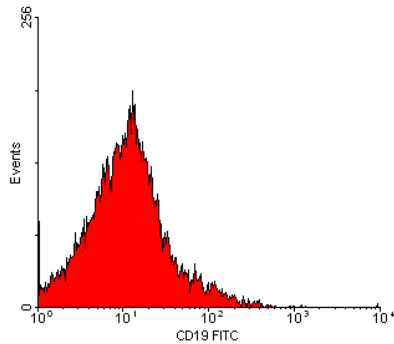

4Color TBNK + TruCO2.01

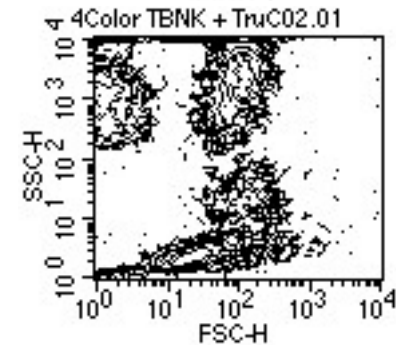
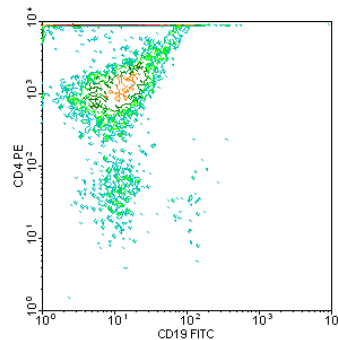
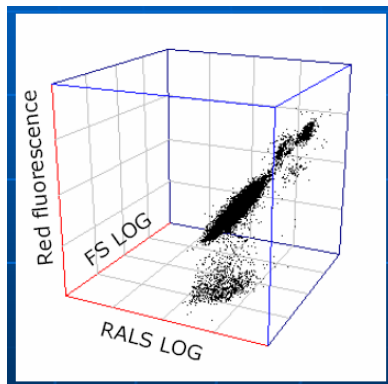
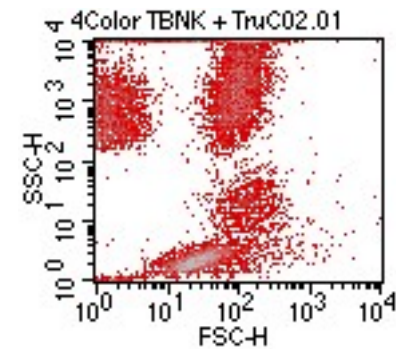
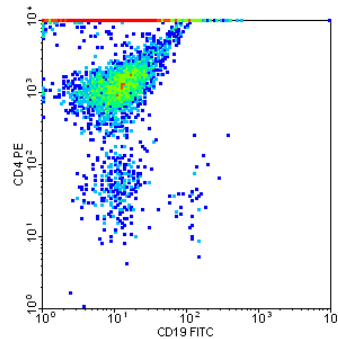

Vícebarevné analýzy generují mnoho dat...

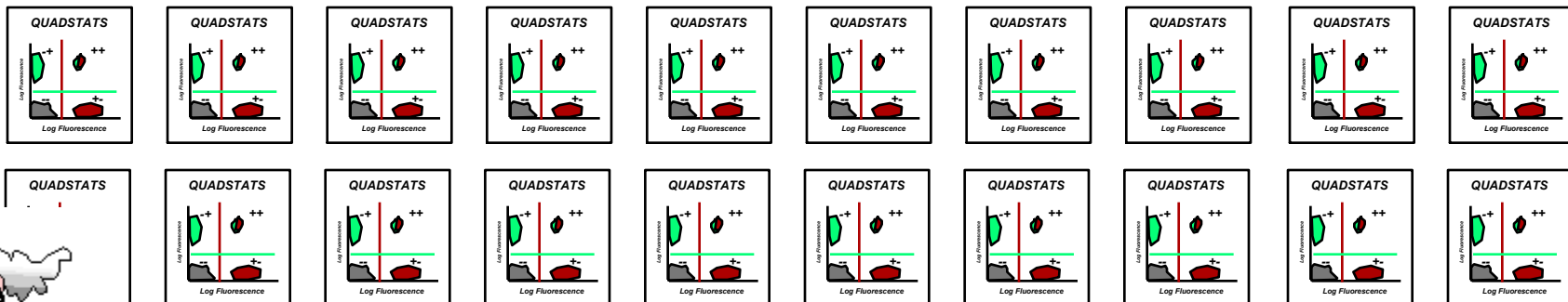
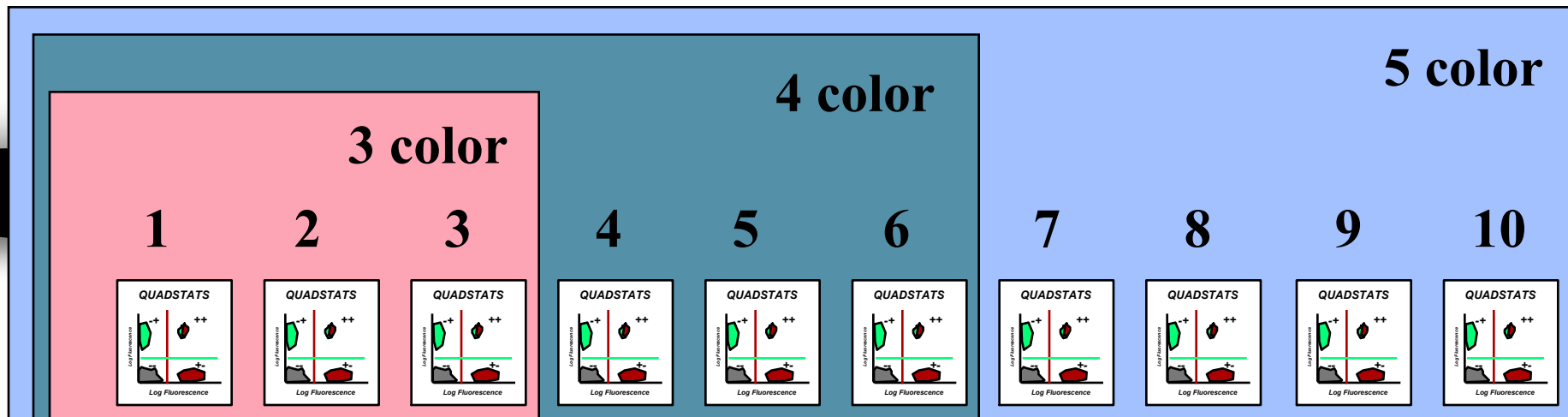

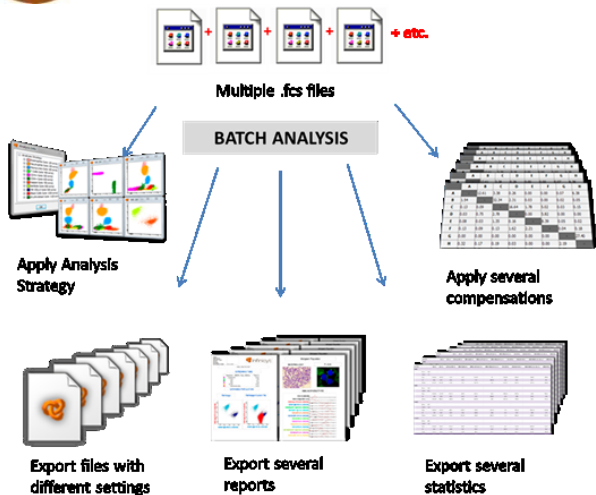

Automatic Population Separator

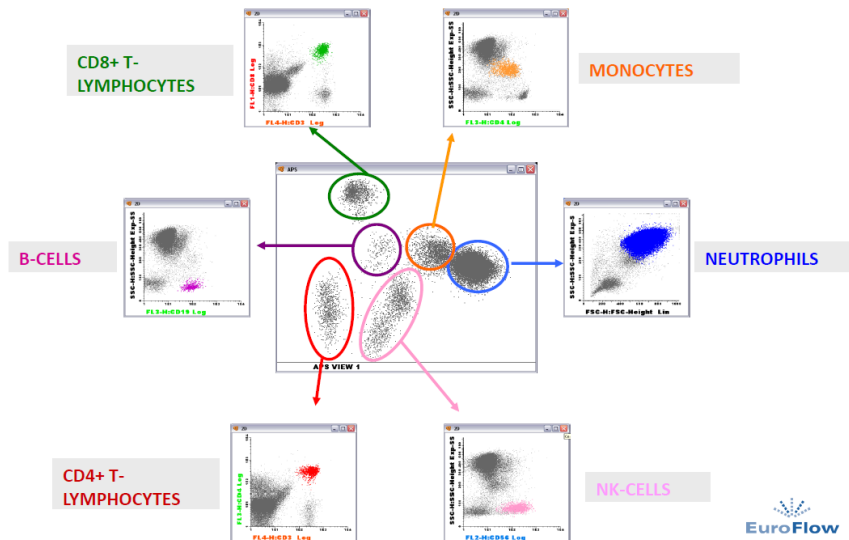

Cell tracking and proliferation

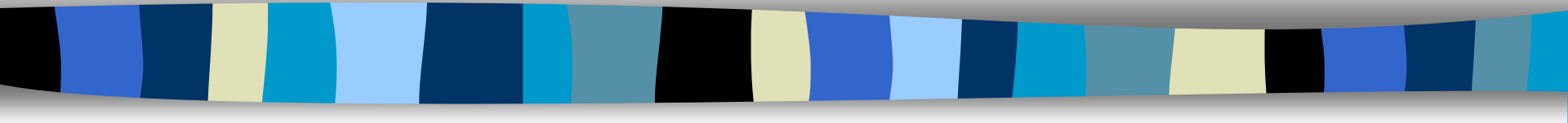

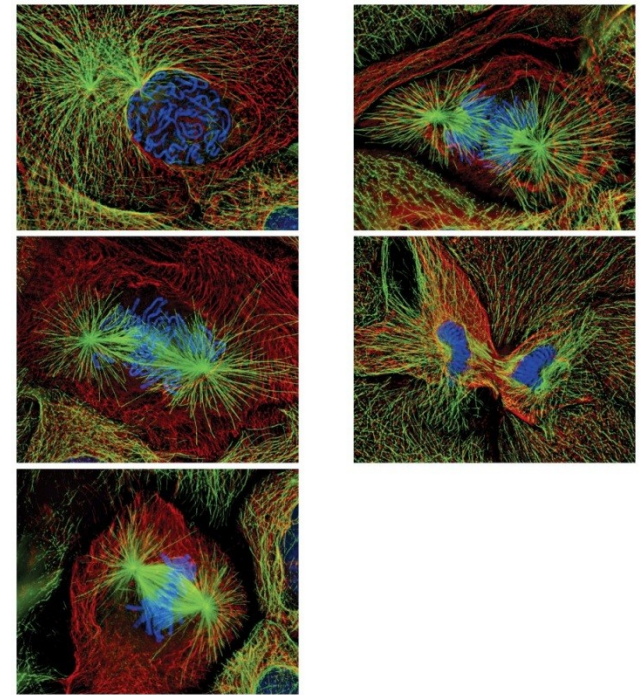
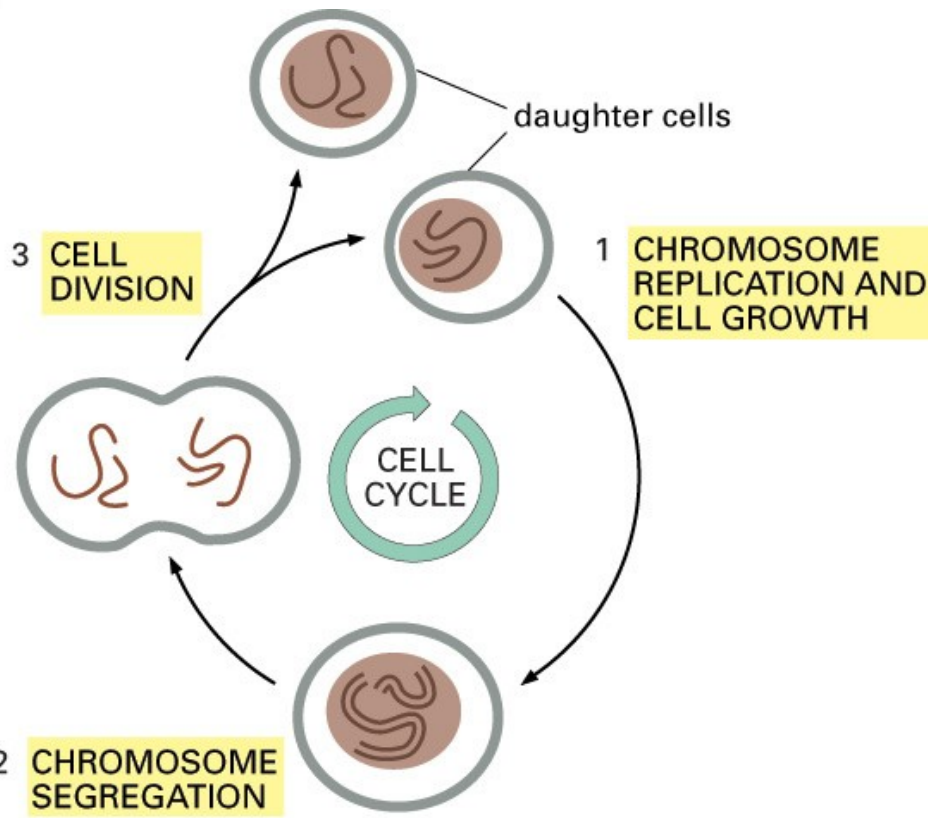

prophase, metaphase, anaphase, telophase

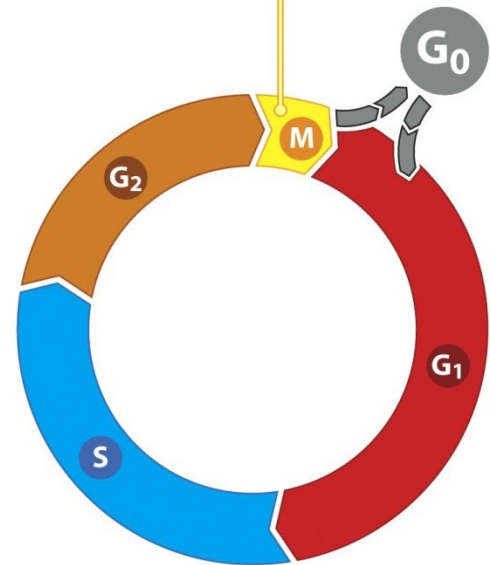

Figure 17-1. Molecular Biology of the Cell, 4th Edition.



Approaches

- Cell cycle analysis
- DNA synthesis analysis
- Cell tracking



What is important for sample preparation and staining ...

- Sample processing depends on the particular analysis ...
 - Single cell suspension
 - Vital stain
 - diffusion
 - active transport
 - fixation (ethanol, formaldehyde)
 - permeabilization (detergents)

Buněčný cyklus

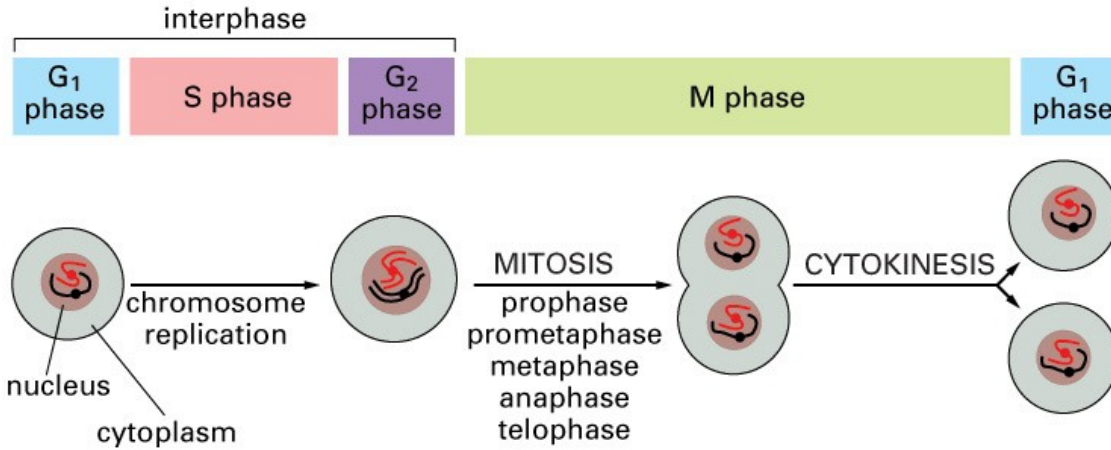

Figure 18-1. Molecular Biology of the Cell, 4th Edition.

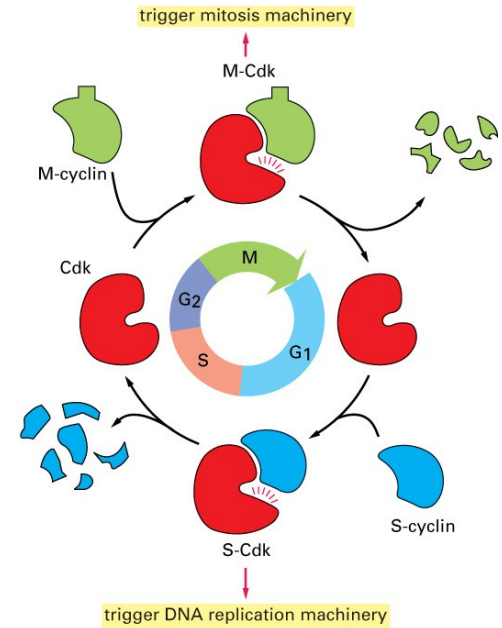
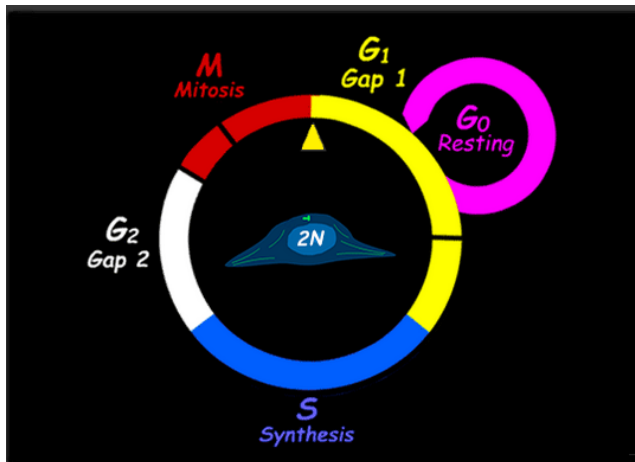

Figure 17-16. Molecular Biology of the Cell, 4th Edition.

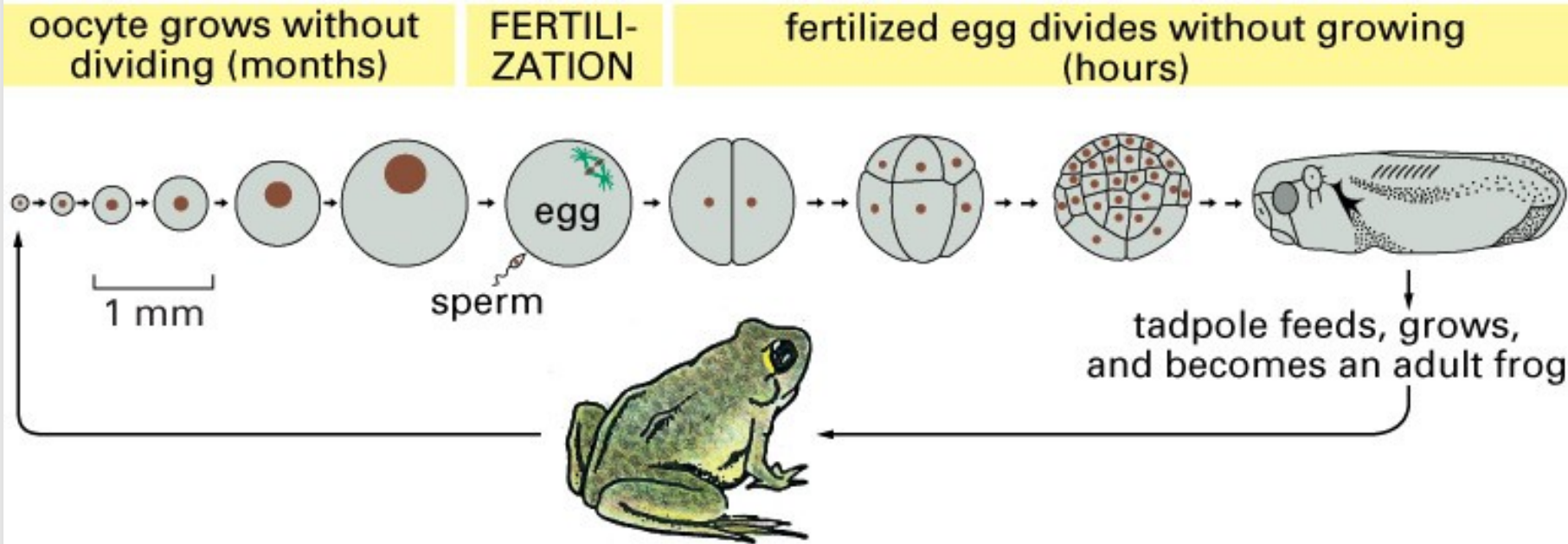
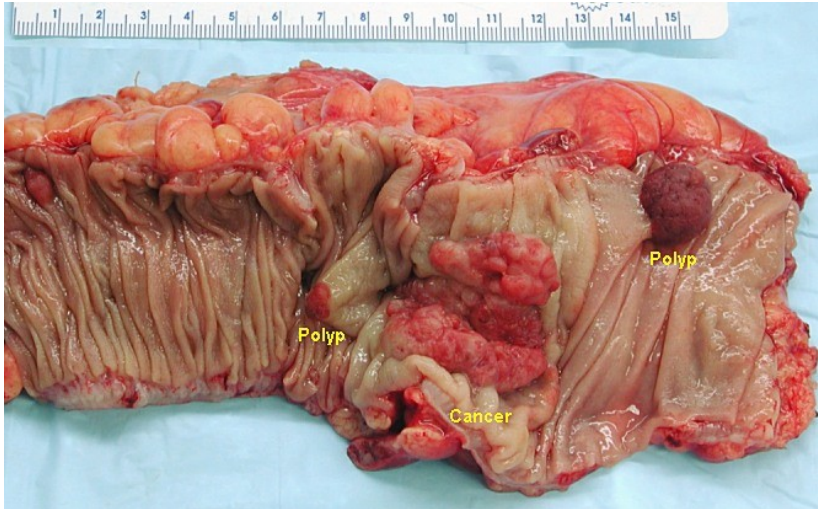

Figure 17-8. Molecular Biology of the Cell, 4th Edition.





Cell cycle analysis

- One of the oldest applications of flow cytometry, analysis of the cells in cell cycle phases based on the quantification of DNA
- flow cytometry is a convenient method for quick and relatively precise determination of cell cycle
- DNA is simply labeled using fluorescent dyes specific for DNA
 - Propidium iodide
 - 4',6-diamidino-2-phenylindole (DAPI)
 - fluorescence increases after binding to DNA. Membranes have to be permeabilized.
 - Hoechst 33342
 - Vybrant® DyeCycle™
 - DRAQ5
 - Quaternary benzo[c]phenanthridine alkaloids (QBAs)

I. Slaninova, J. Slanina and E. Taborska, "Quaternary benzo[c]phenanthridine alkaloids--novel cell permeant and red fluorescing DNA probes," *Cytometry A*, vol. 71, no. 9, pp. 700-708, 2007.

- labeling of live cells (possible cytotoxicity)

Normal Cell Cycle

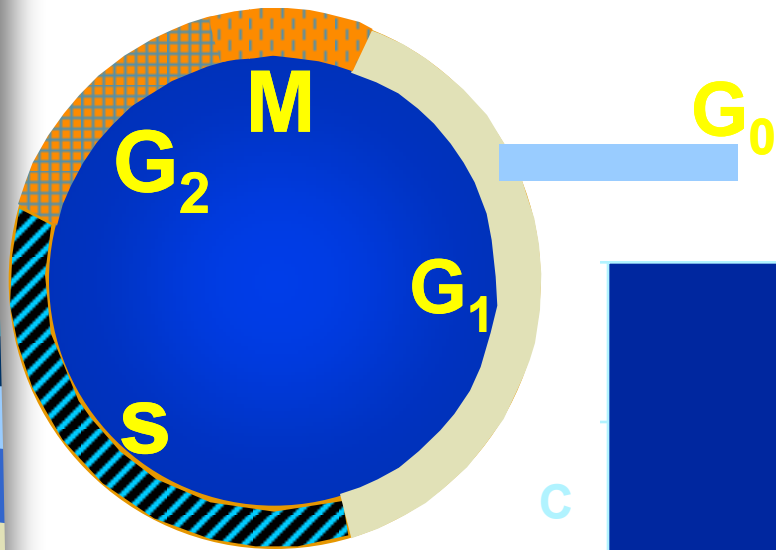

DNA Analysis

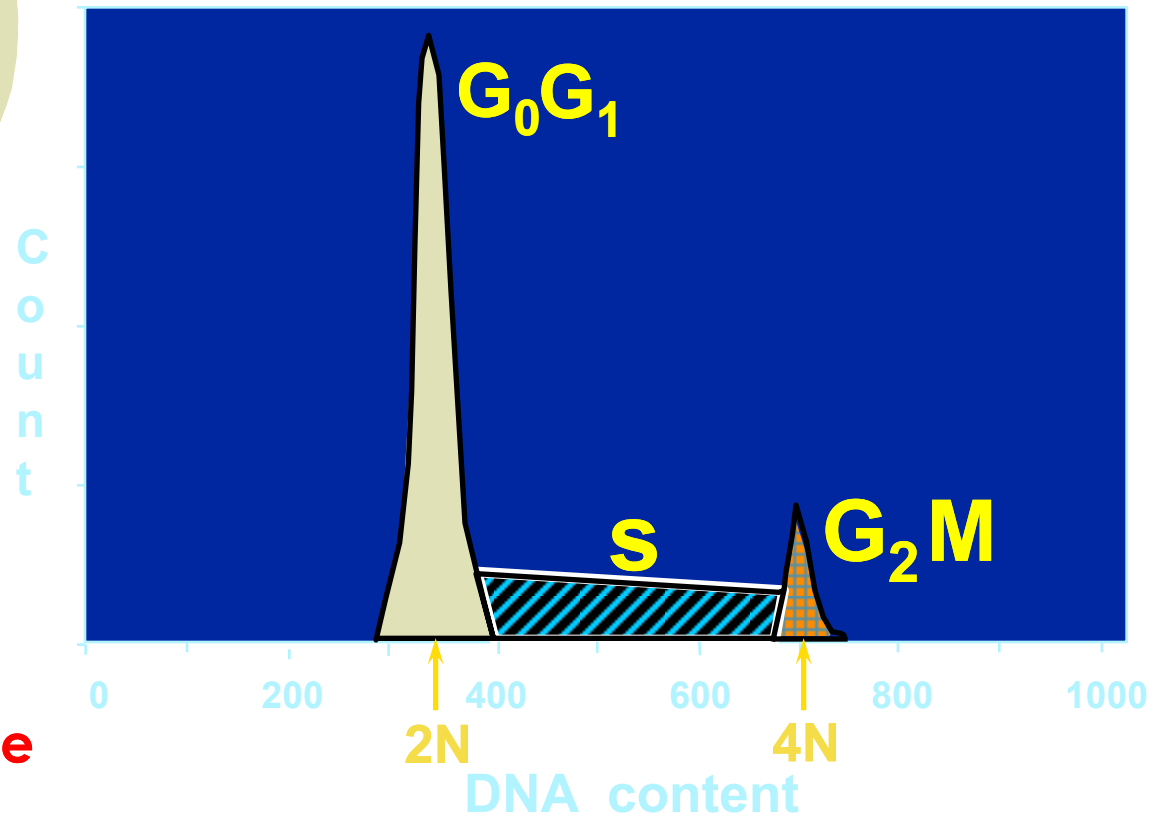

- propidium iodide
- DAPI
- Hoechst 33342
- 7-AAD

Cell cycle histogram: how to analyze?

- **It is not recommended** to statistically analyze it using simple gating in the histogram
- **It is necessary** to use software tools for modeling of distribution of cell cycle phases

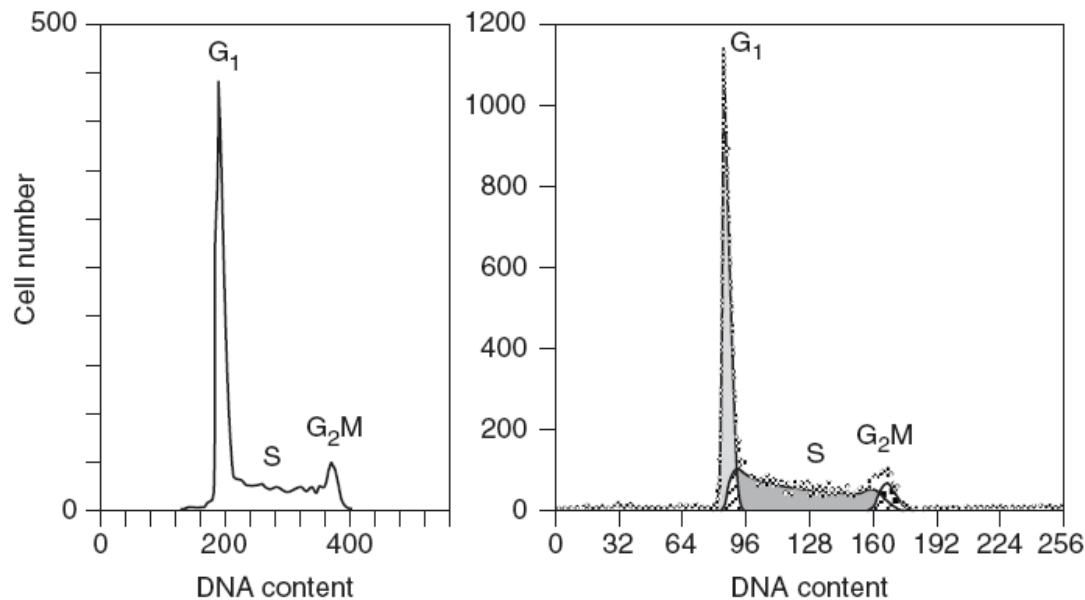

ModFit LT™

An impressive new version of the industry standard.

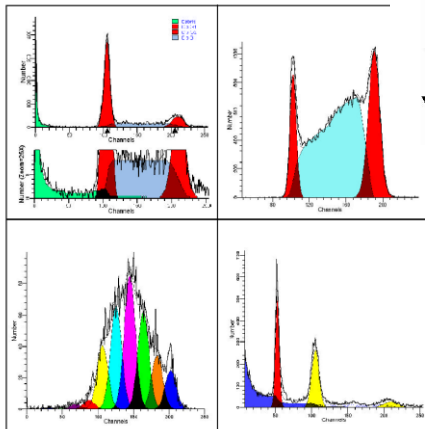

PHOENIX FLOW SYSTEMS

MultiCycle for Windows

Advanced DNA Cell Cycle Analysis Program

MultiCycle AV fits 6 different cell cycle models automatically. The variability in results is one aid to assessing confidence in S and G2 phase estimates. Display of statistics is optional.

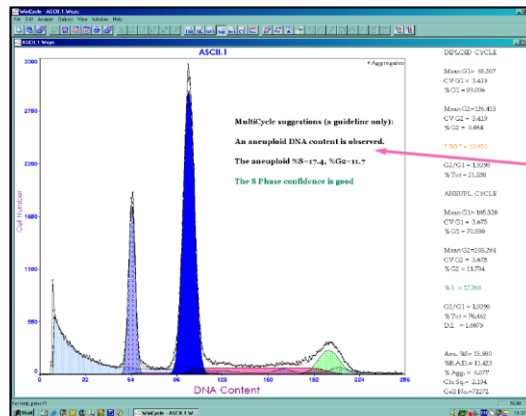

A summary interpretation clearly states results. A built-in decision tree helps take the guesswork out of evaluating the quality of the cell cycle analysis.

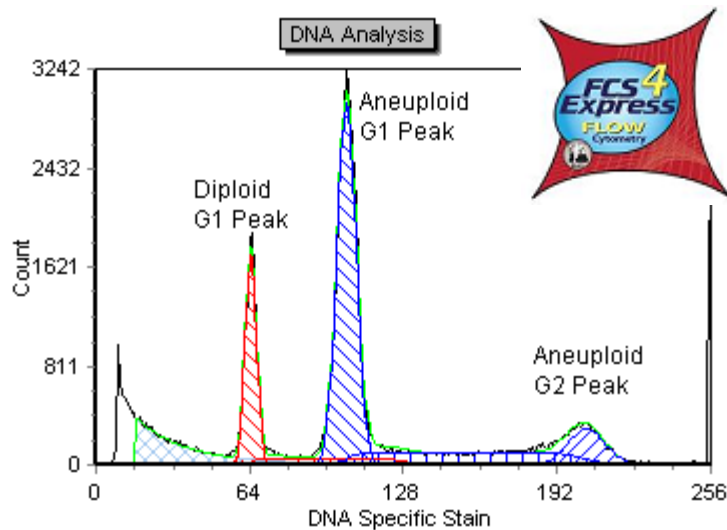
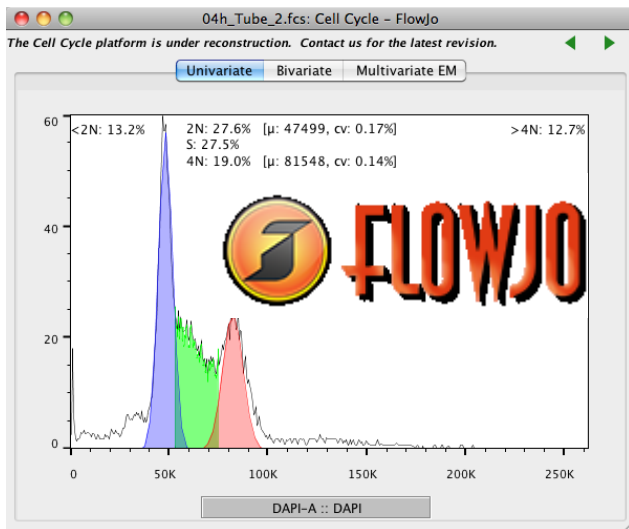

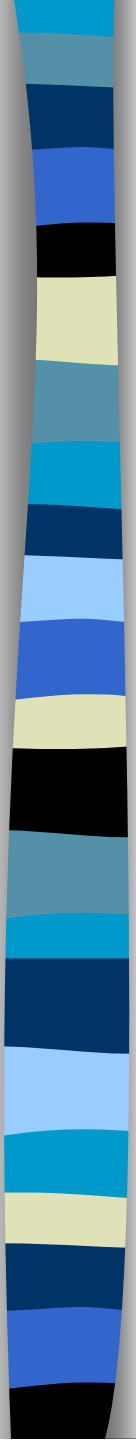

Analysis of synchronized cells

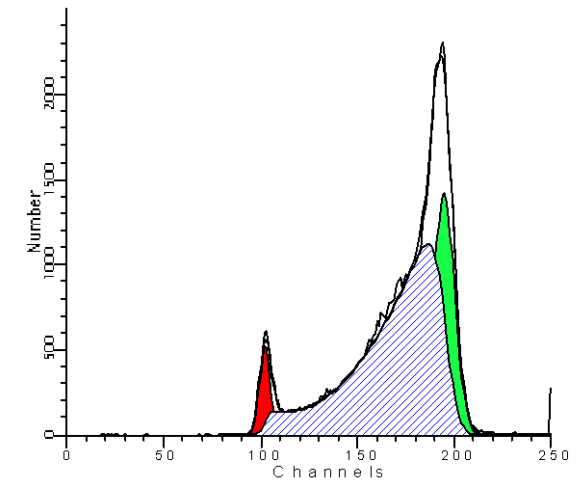
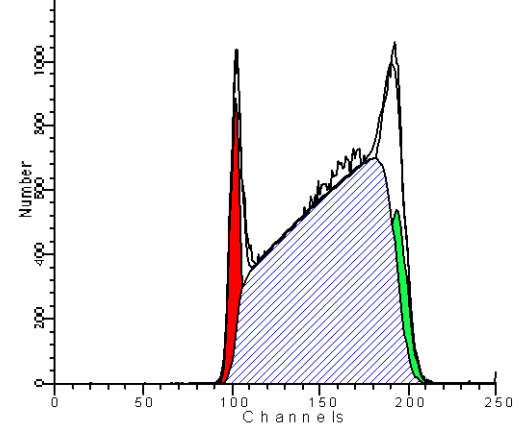
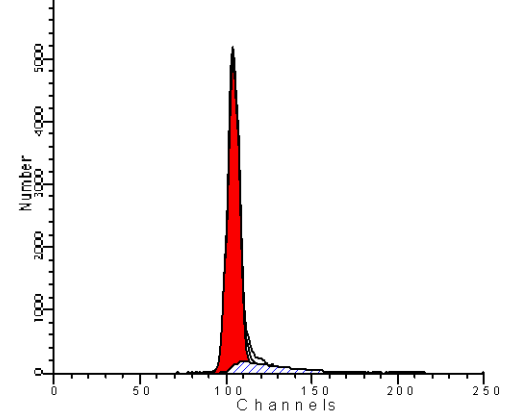
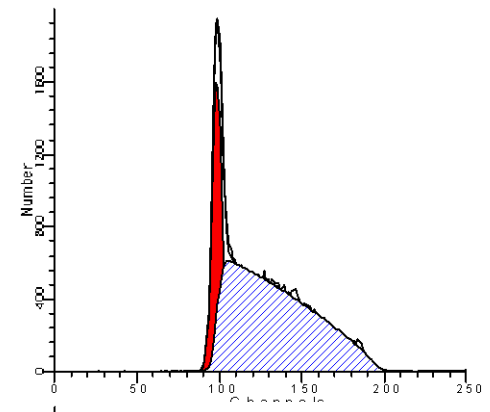
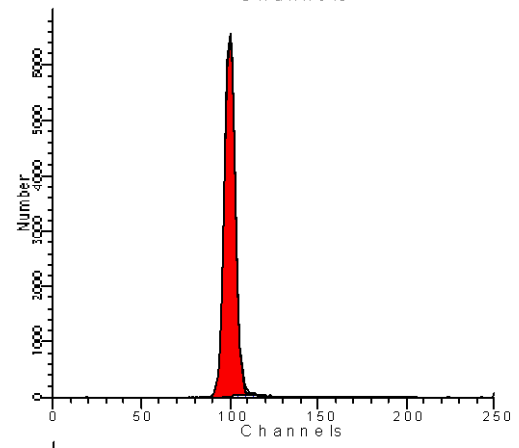
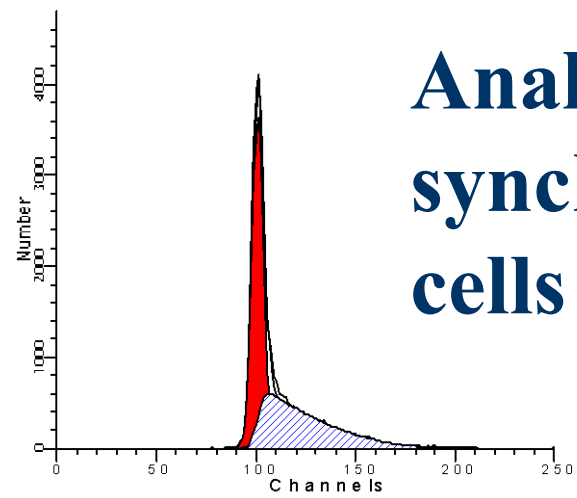
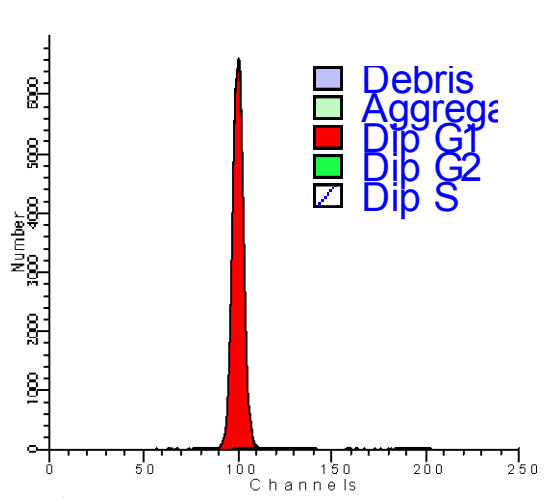



Analysis of BrdU incorporation

- Bromodeoxyuridin (BrdU) is incorporated into DNA instead of thymidine during S-phase
- BrdU is detected using specific antibody after the fixation and partial denaturation of DNA (acid, DNase)
- DNA can be stained in the last step

Analysis of BrdU incorporation

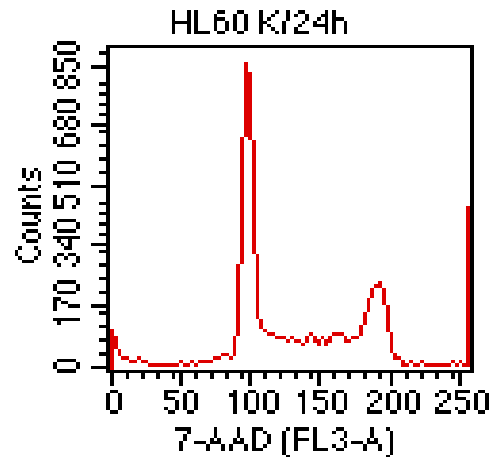
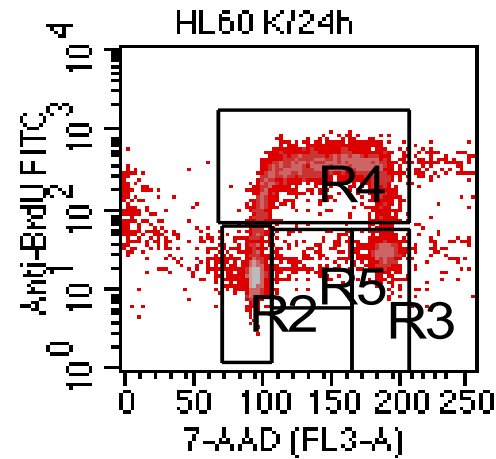
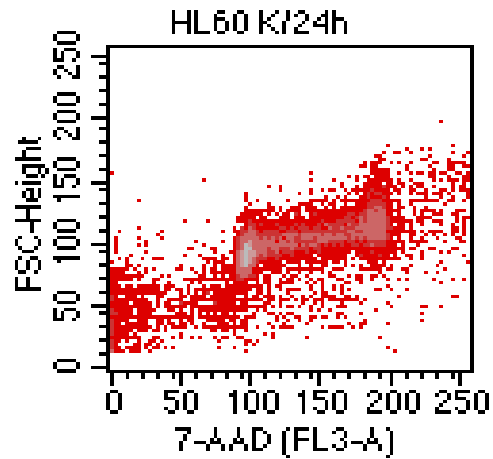

File: HL60 K/24

Regi	% Ga
R1	100.1
R2	35.4
R3	10.2
R4	47.8
R5	1.3

Flow Cytometer Setup for Becton Dickinson Hardware

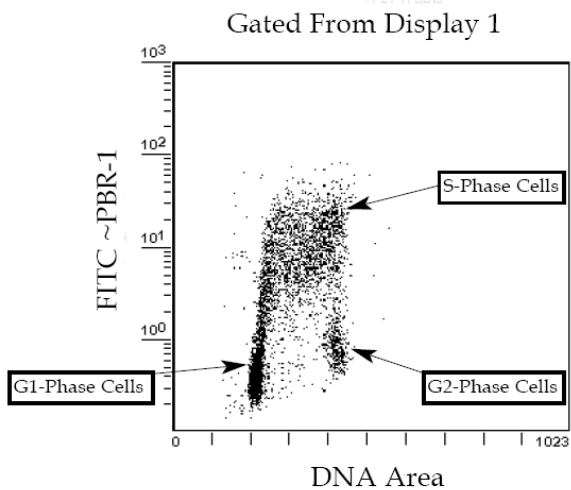
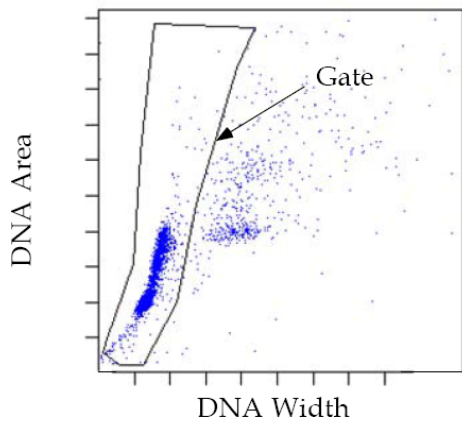

Flow Cytometer Setup for Coulter Hardware

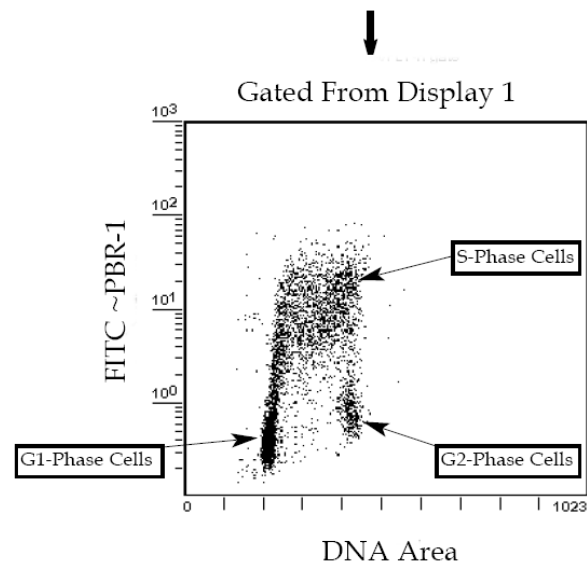
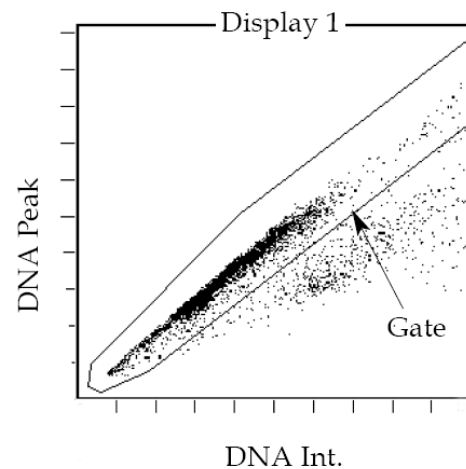

Click azide/alkyne reaction

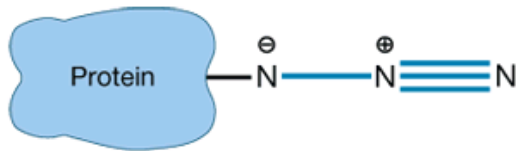

Metabolically or enzymatically
azide-modified protein

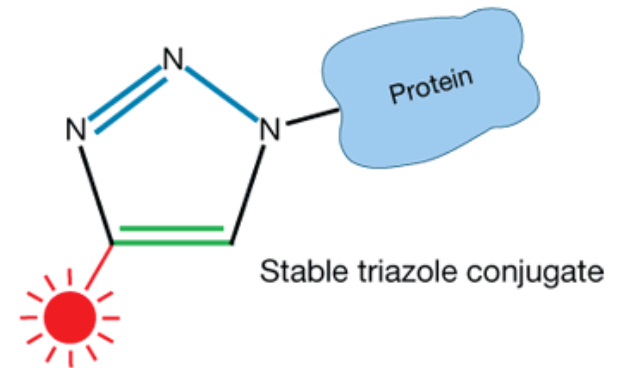
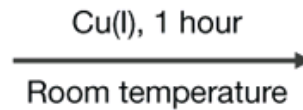

TAMRA, Dapoxyl®, or biotin alkyne

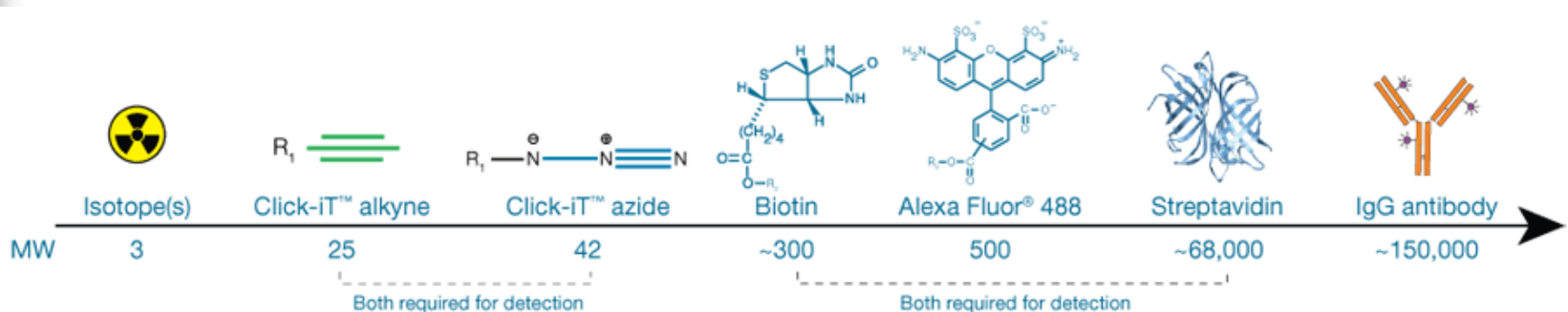

Aplikace Click-IT (Invitrogen)

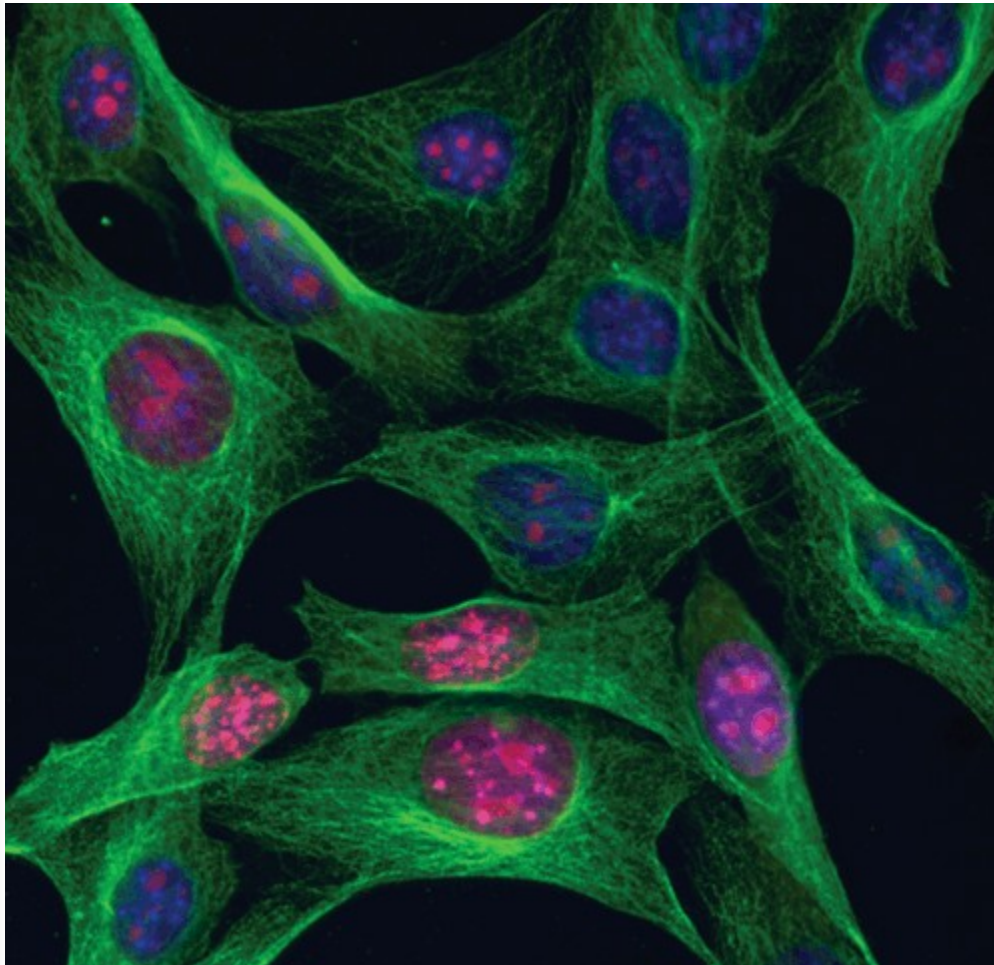

Multiplex imaging with Click-iT® RNA assays.

NIH3T3 cells were incubated with 1 mM EU, formaldehyde-fixed, and permeabilized with Triton® X-100. EU incorporated into newly synthesized RNA (red) in some cells was detected using the Click-iT® RNA Alexa Fluor® 594 Imaging Kit. Tubulin (green) was detected with anti-tubulin mouse IgG9 and visualized with Alexa Fluor® 488 goat anti-mouse IgG. Nuclei (blue) were stained with Hoechst 33342.

Click-IT (Invitrogen) applications

analysis of DNA synthesis (EdU - 5-Ethynyl-2'-deoxyuridine)

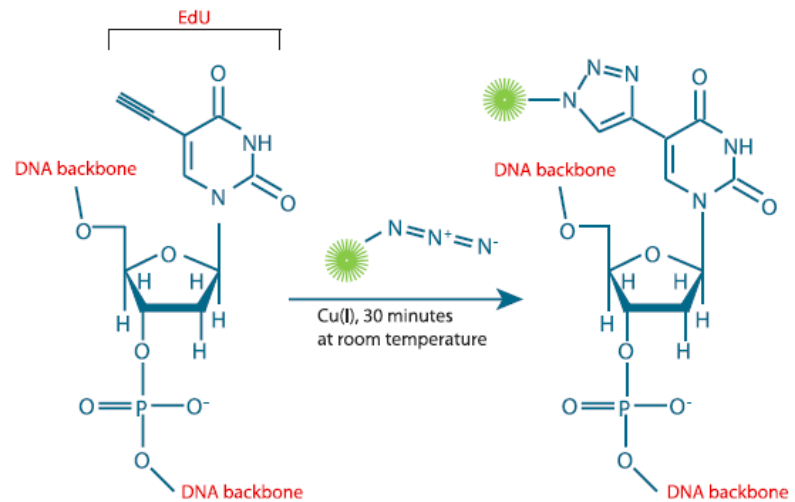

 Fluorescent dye or hapten

^3H -thymidine

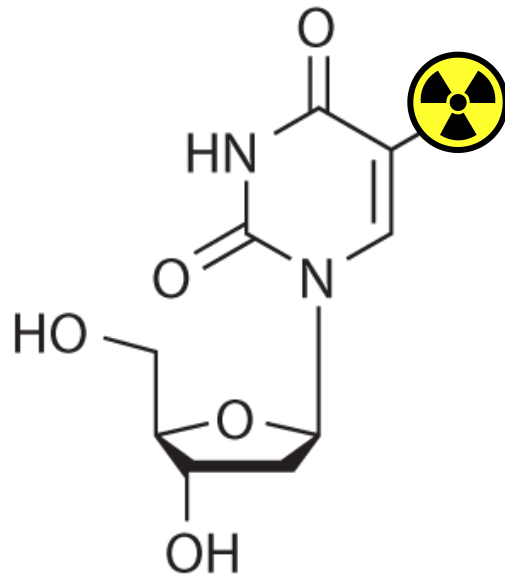

Tritiated (^3H) thymidine



^3H -thymidine

- Original method for measuring cell proliferation
- Radioactive
- Not compatible for multiplexed analyses

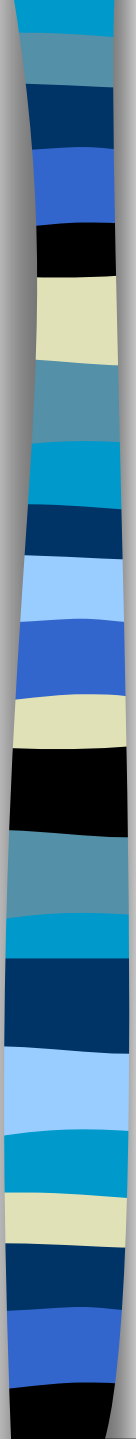

BrdU

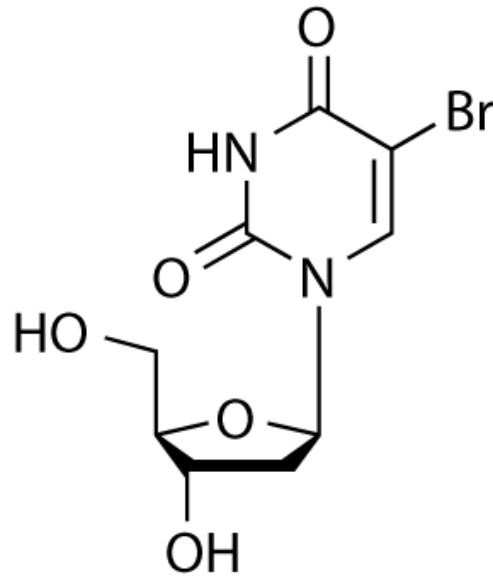

BrdU (5-bromo-2'-deoxyuridine)

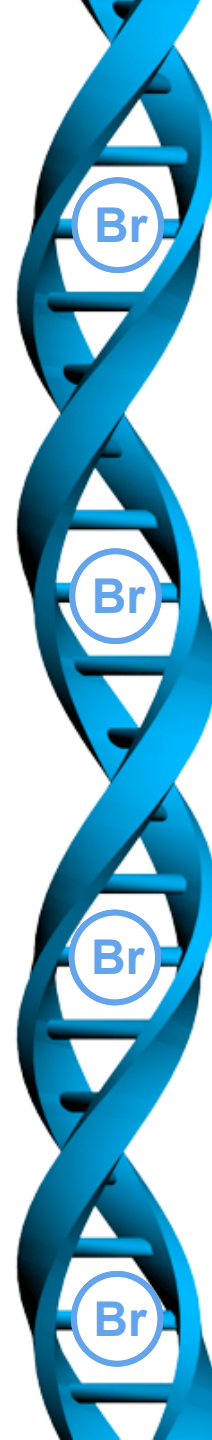

BrdU

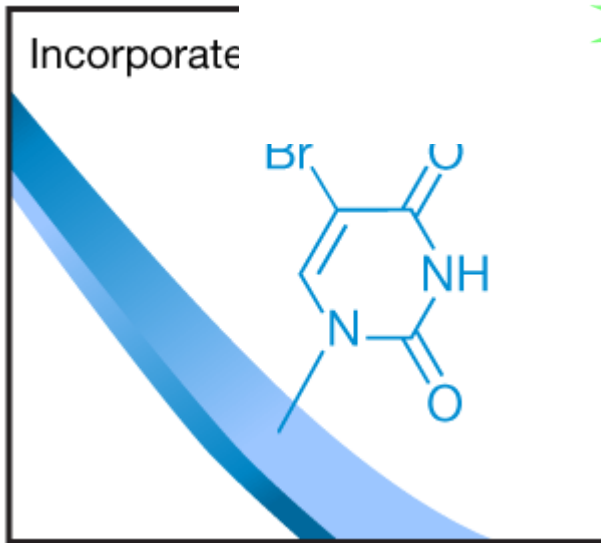
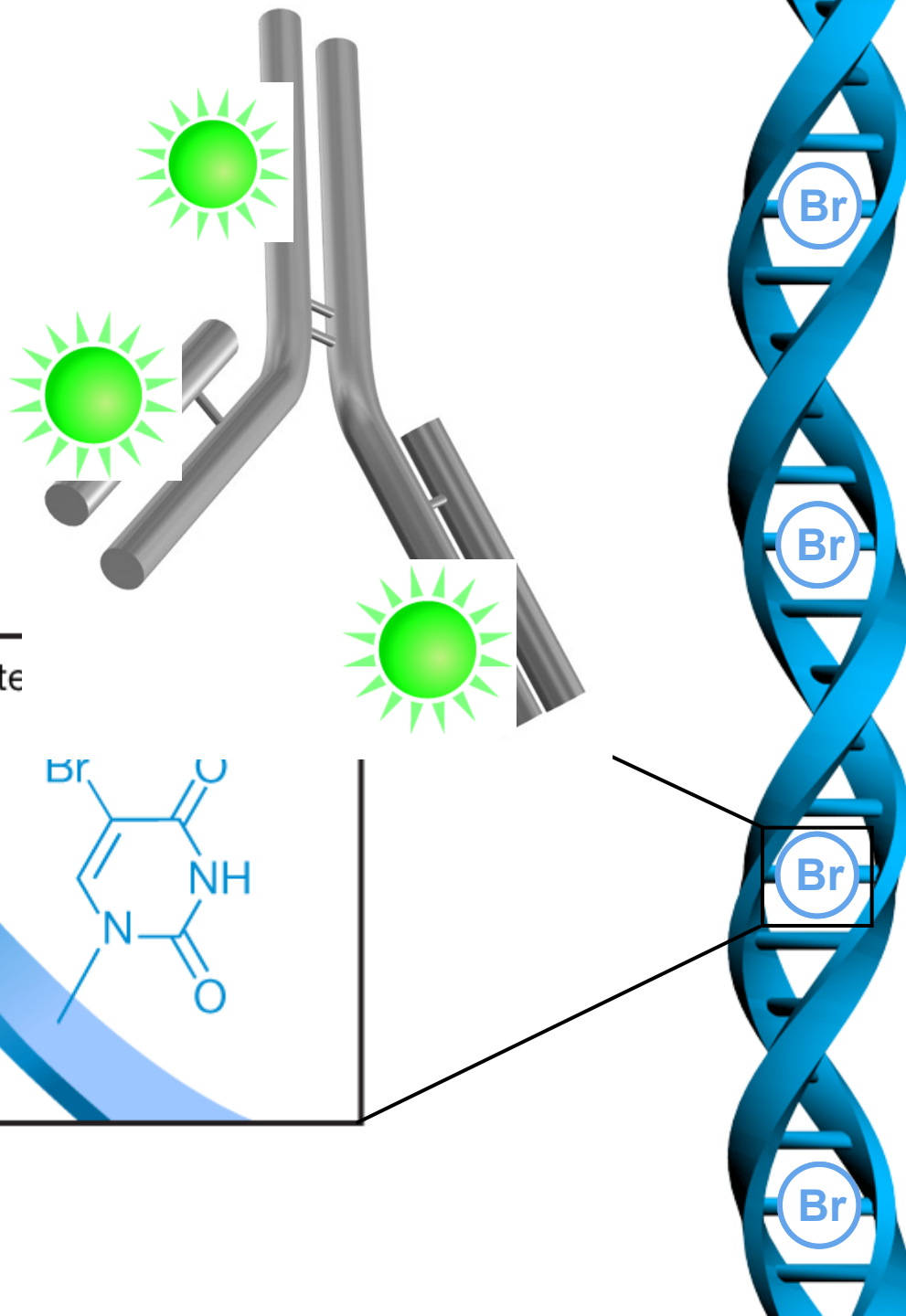

BrdU



Acid or DNase

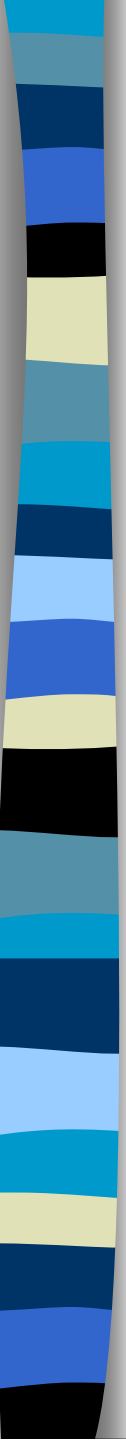

BrdU

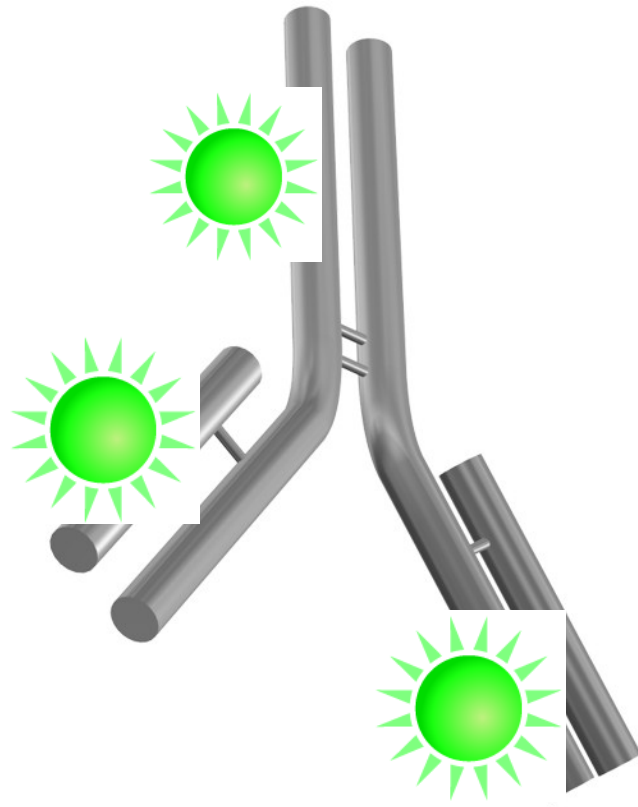

BrdU

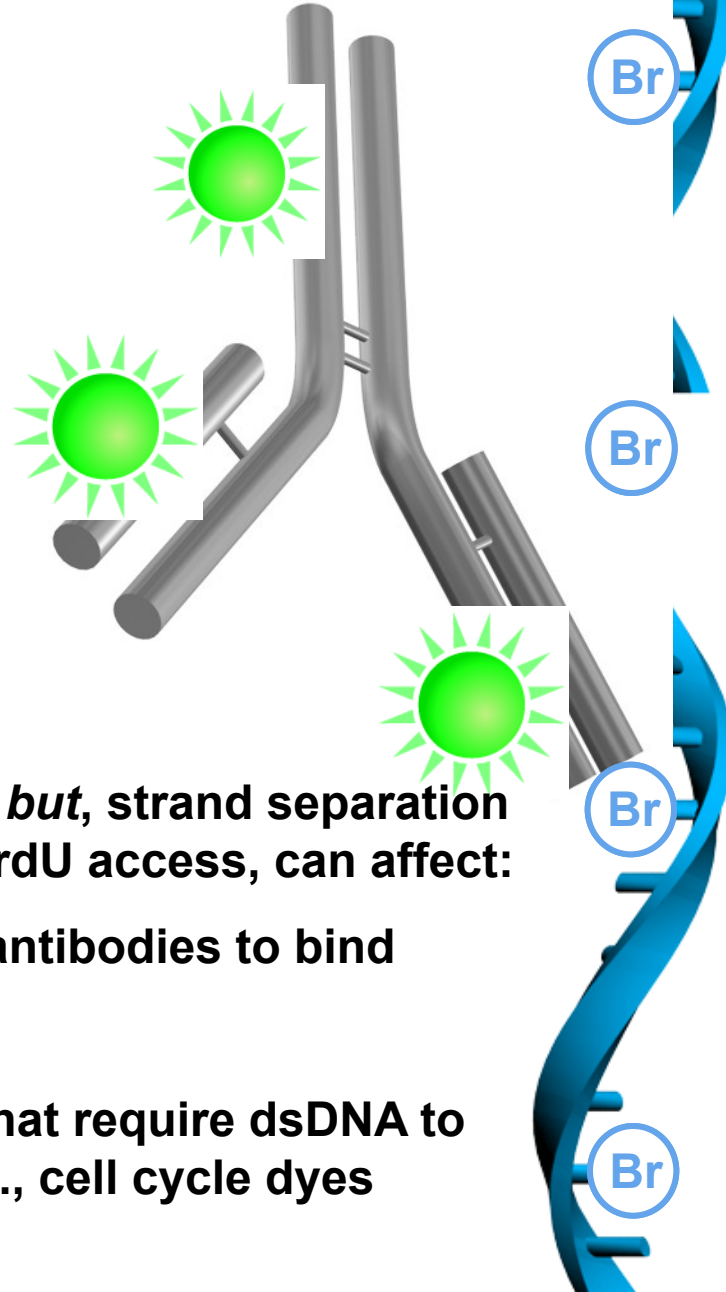

- **Non-radioactive**
- **Multiplex compatible *but*, strand separation requirement for anti-BrdU access, can affect:**
 - **Ability for other antibodies to bind**
 - **Morphology**
 - **Ability for dyes that require dsDNA to bind efficiently, i.e., cell cycle dyes**

Click-iT™ EdU

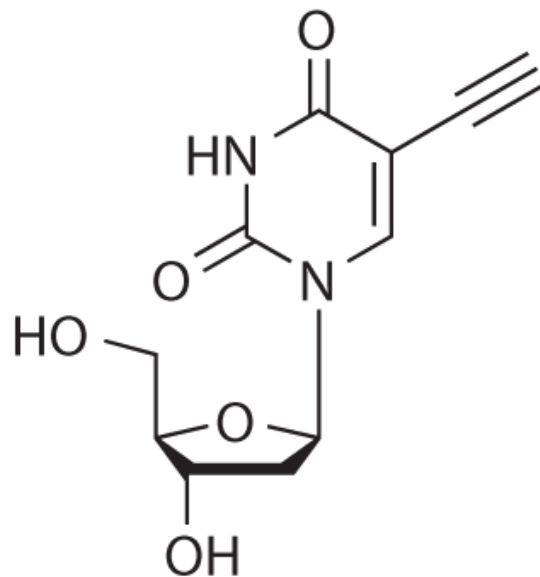

EdU (5-ethynyl-2'-deoxyuridine)



Click-iT™ EdU

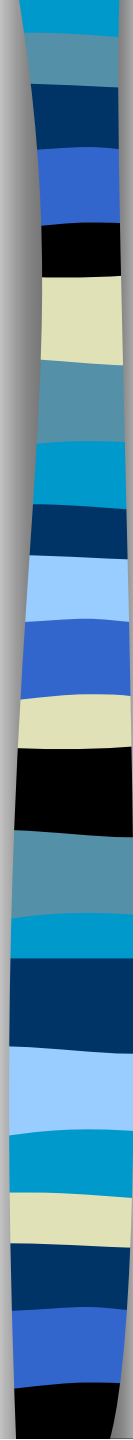
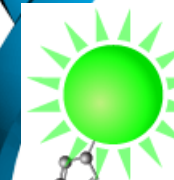
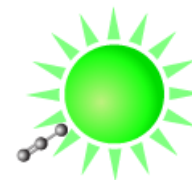
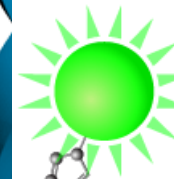
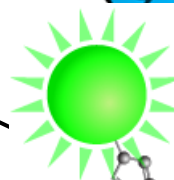
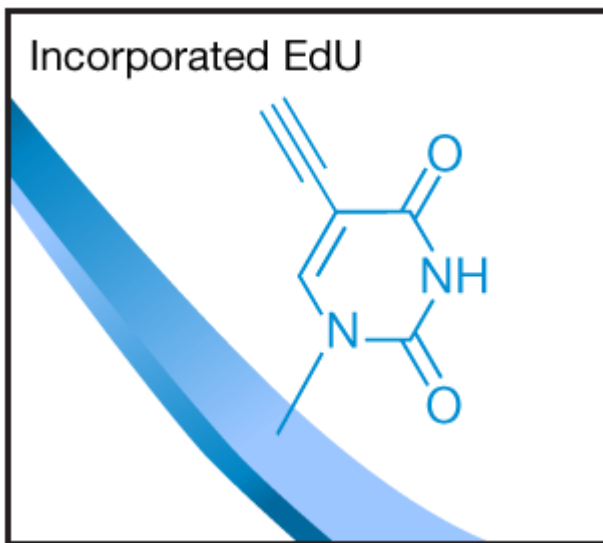
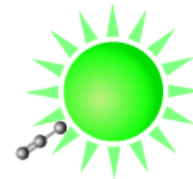
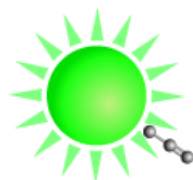
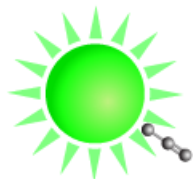

Click-iT™ Edu

- **Non-radioactive**
- **No DNA denaturation required**
- **Simplified protocol**
- **Small molecule detection**
- **Multiplex compatible, including**
 - **Other antibodies**
 - **Dyes for cell cycle analysis**

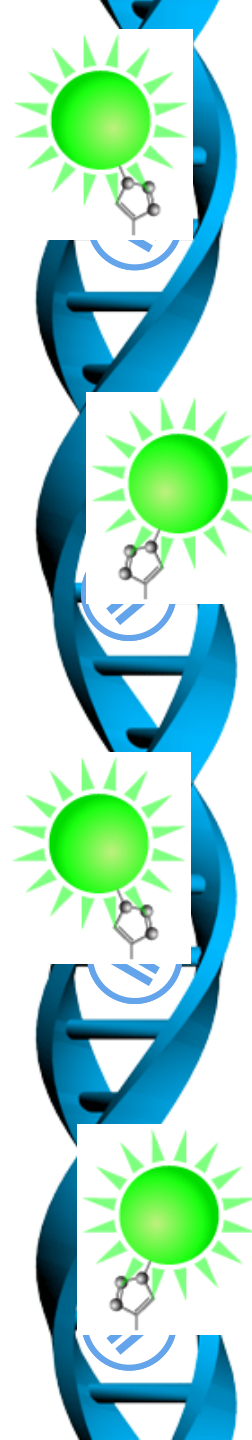

Click-iT™ EdU - limitations

Table 4 Click-iT® Plus EdU compatibility with DNA content stains

DNA Content Stain	Click-iT® Plus EdU Stain Compatibility		RNase required?
	Alexa Fluor® 647 picolyl azide	Alexa Fluor® 488 picolyl azide	
FxCycle™ PI/RNase	Yes	Yes	No
FxCycle™ Violet	Yes	Yes	No
FxCycle™ Far Red	No	Yes	Yes
SYTOX® AADvanced™	Yes	Yes	Yes
Propidium iodide (PI)	Yes	No	Yes

Table 2 Click-iT® Plus EdU detection reagent compatibility

Fluorescent molecule	Compatibility*
R-phycoerythrin (R-PE) and R-PE based tandems (i.e., Alexa Fluor® 610-RPE)	Compatible
Fluorescent proteins (GFP)	Compatible
PerCP, allophycocyanin (APC) and APC-based tandems (i.e. Alexa Fluor® 680-APC)	Compatible
Organic dyes such as Alexa Fluor® dyes, fluorescein (FITC)	Compatible
Qdot® nanocrystals	Use Qdot® nanocrystals after the Click-iT® Plus EdU detection reaction.

*Compatibility indicates whether the fluorescent molecule itself or the detection methods involve components that are unstable in the presence of the copper catalyst used for the Click-iT® Plus EdU detection reaction.

Cyclin Expression: Periodicity

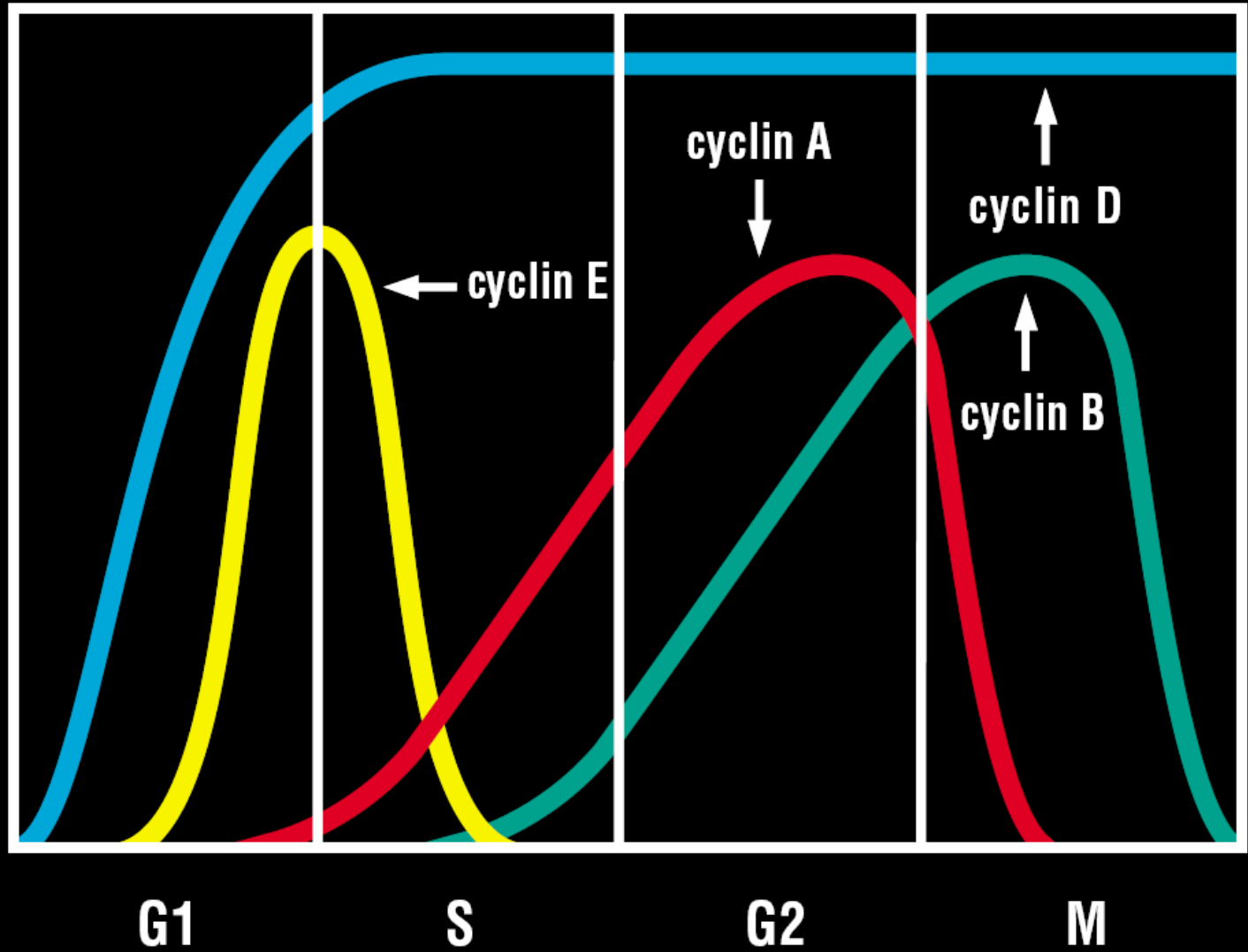

Intracellular protein detections in combinations with DNA analysis

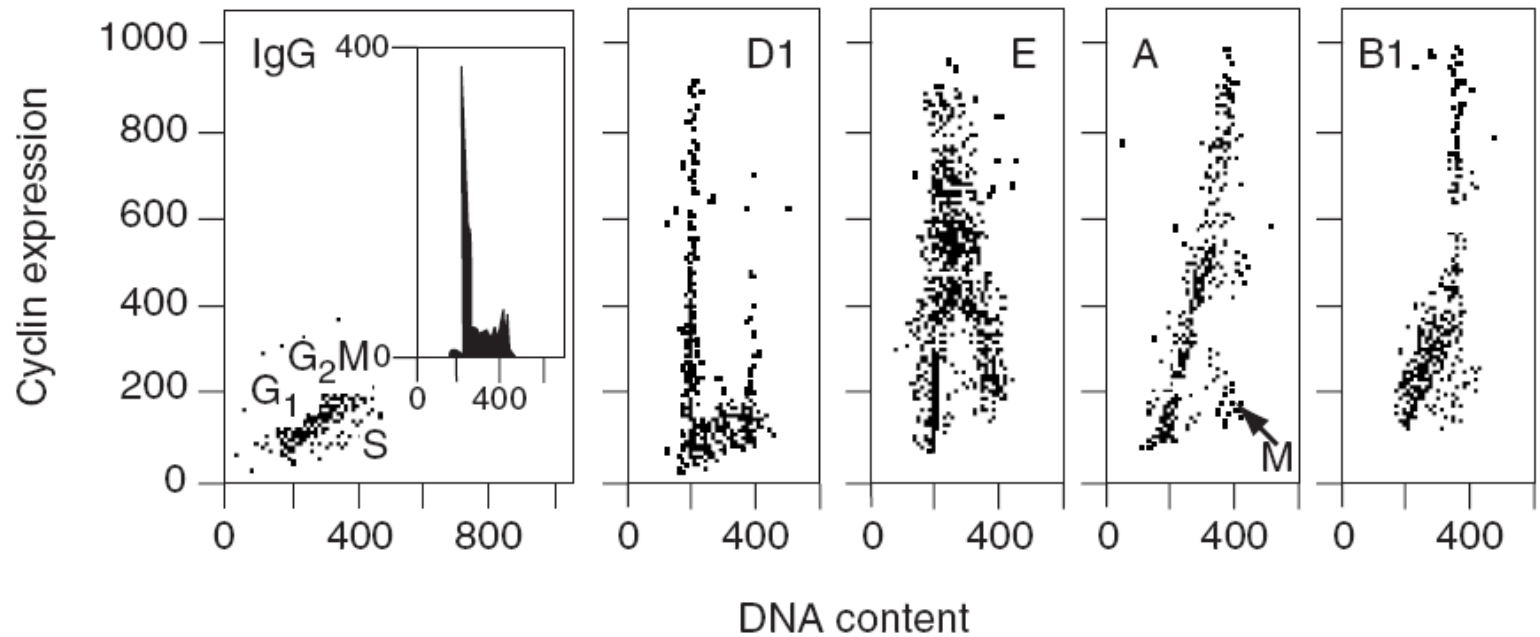

Detection of mitotic cells

- Histone H3 is specifically phosphorylated (Ser10, Ser28, Thr11)
- Double stain of DNA and H3-P identifies populations of the cells in M-phase

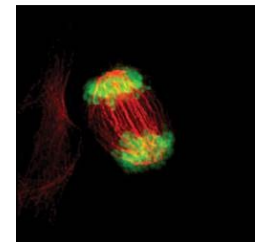
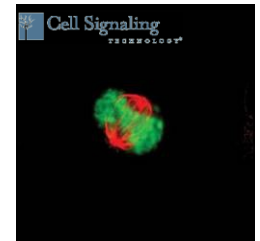
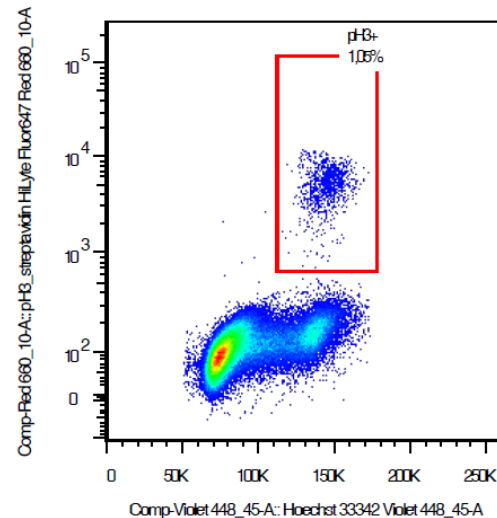
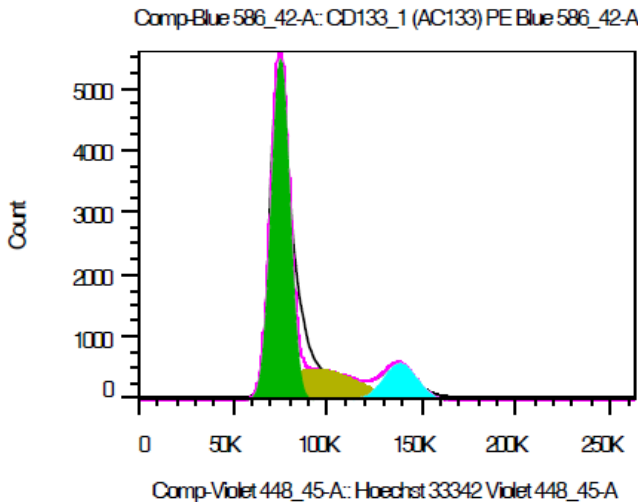

Tracking of cell division

- Nonspecific labeling of cellular proteins using **carboxyfluorescein diacetate succinimidyl ester** (CFDA-SE or CFSE, CellTrace™ Violet, CellTrace™ Far Red DDAO-SEt)

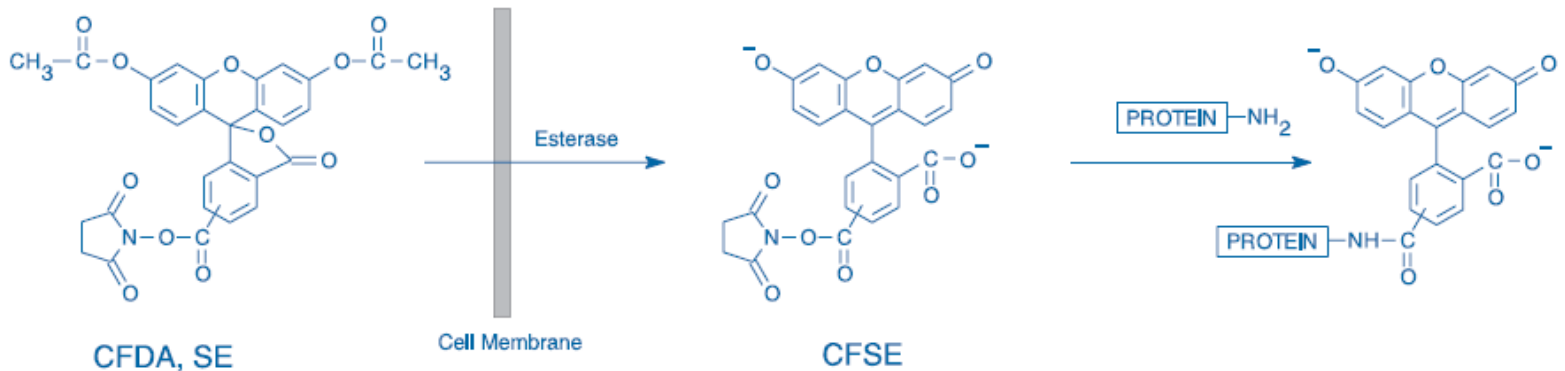

Tracking of cell division

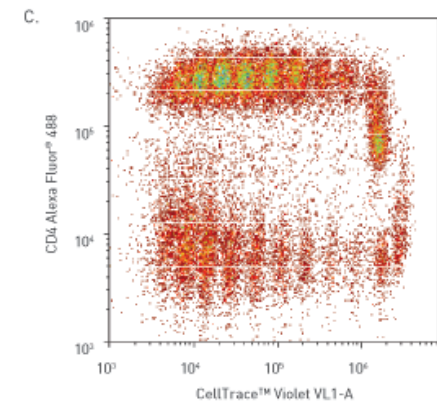
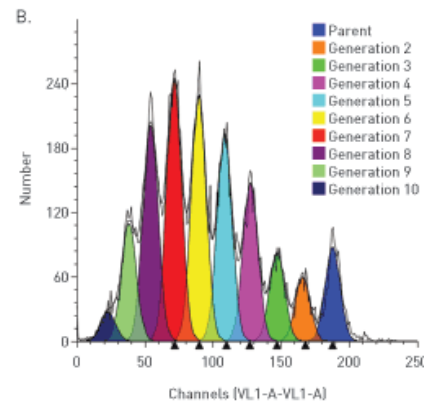
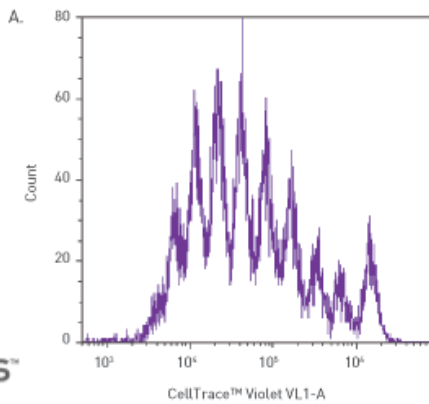
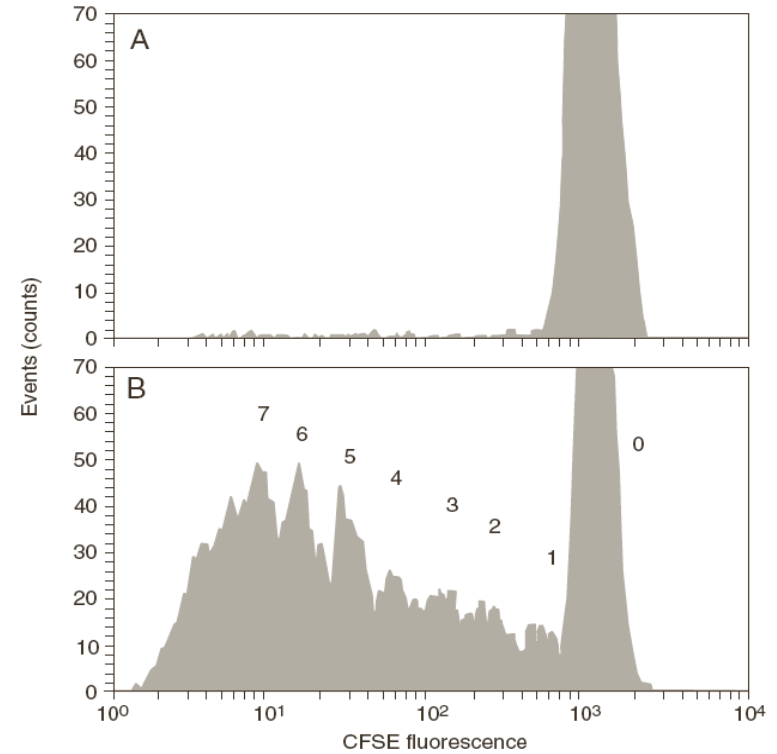
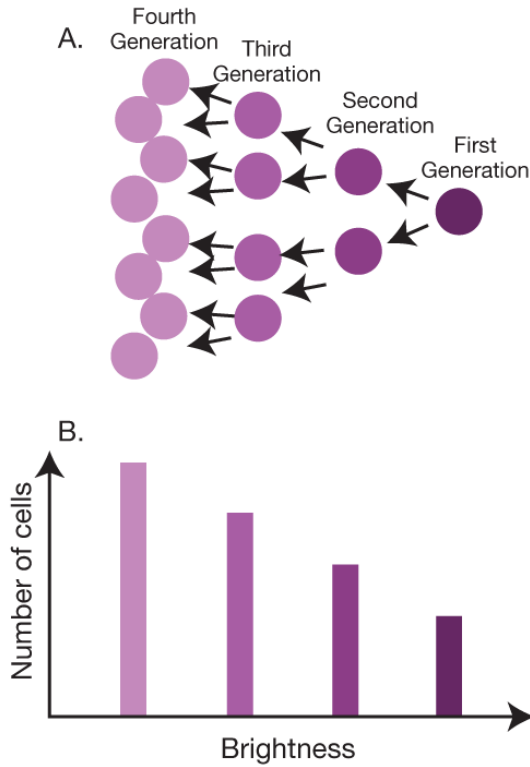



Garry Nolan



Peter Krutzik

„Fluorescent cell barcoding“

May 2006 | volume 3 | number 5

nature | methods

www.nature.com/naturemethods Techniques for life scientists and chemists

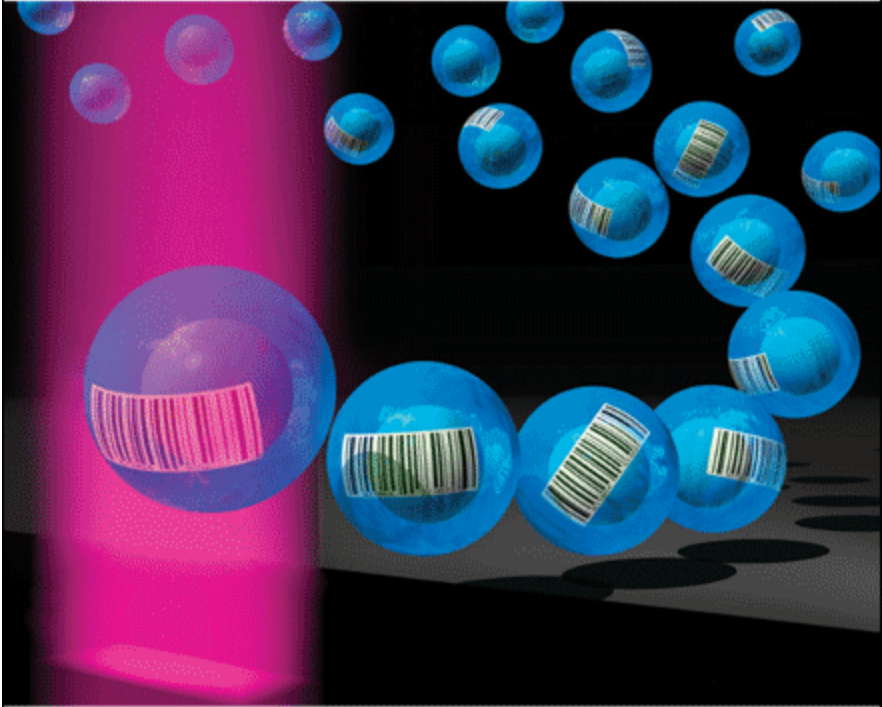

- High-throughput flow cytometry
- Measuring rapid neuronal firing
- Cell patterning in 3D
- Live-cell imaging of RNAi screens
- A review of force spectroscopy

<http://www.stanford.edu/group/nolan/>

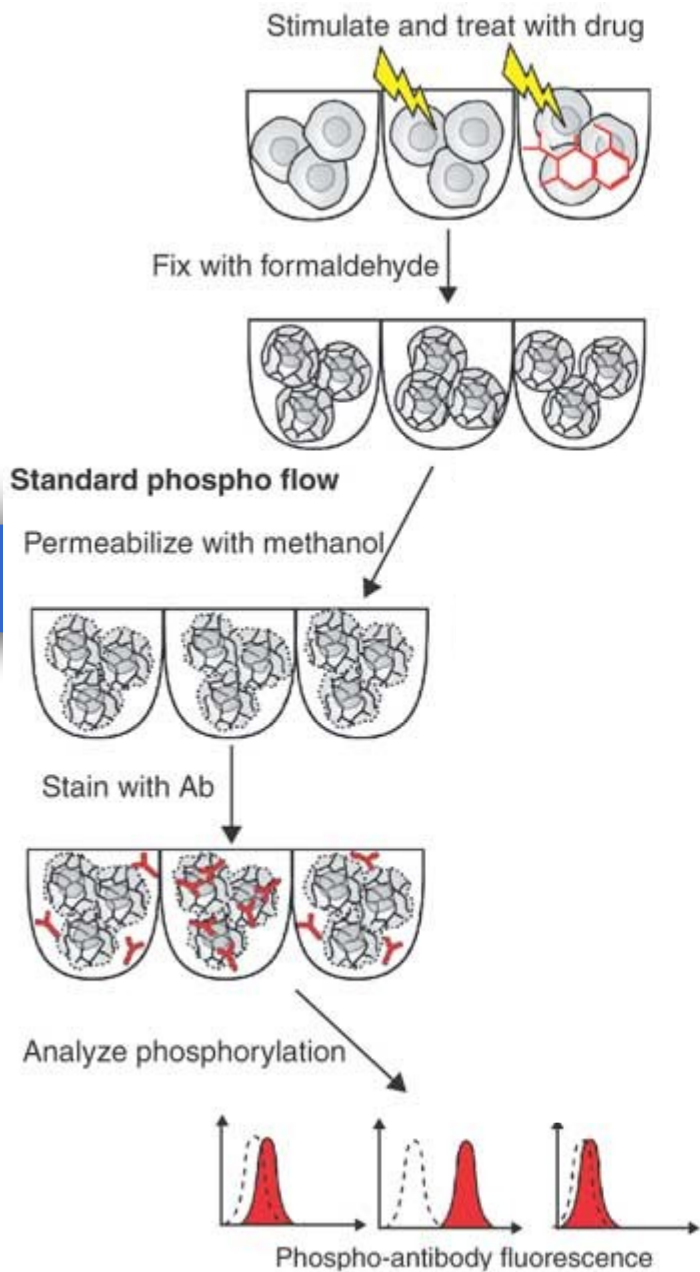

[Krutzik PO, Nolan](#) Fluorescent cell barcoding in flow cytometry allows high-throughput drug screening and signaling profiling. *Nat Methods*. 2006 May;3(5):361-8.

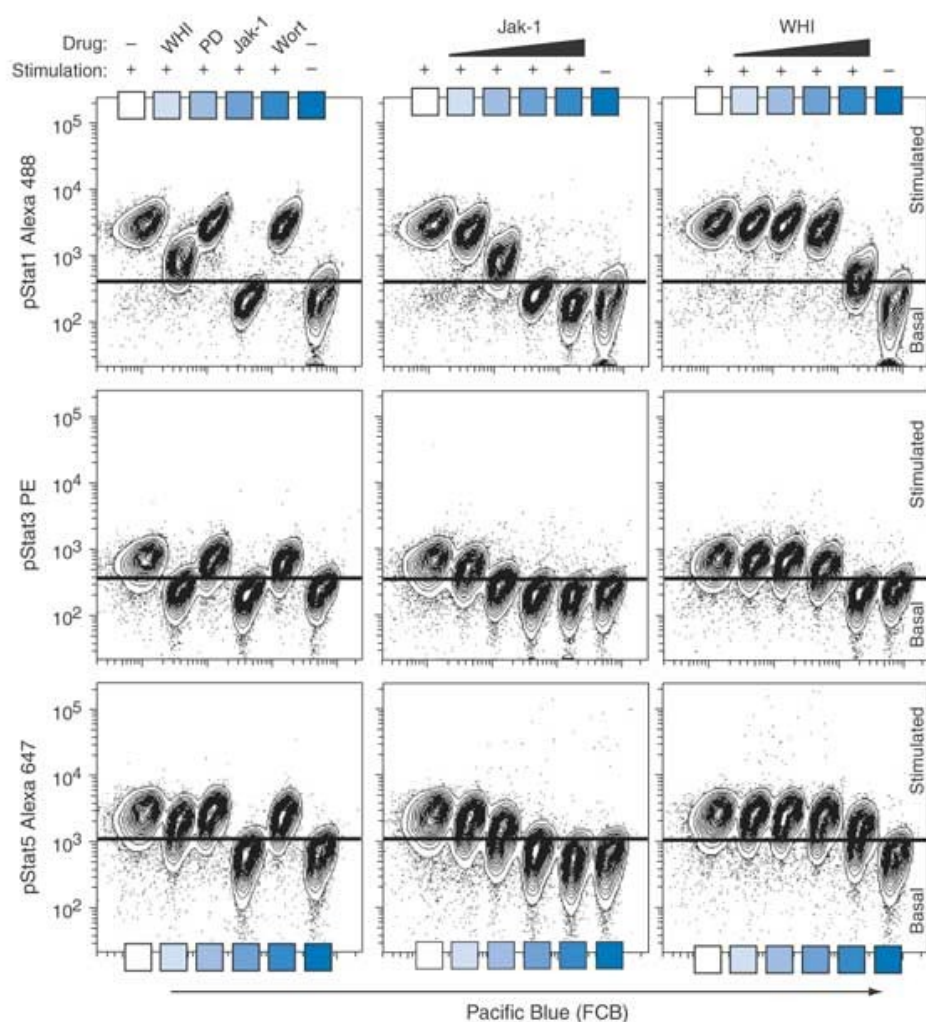
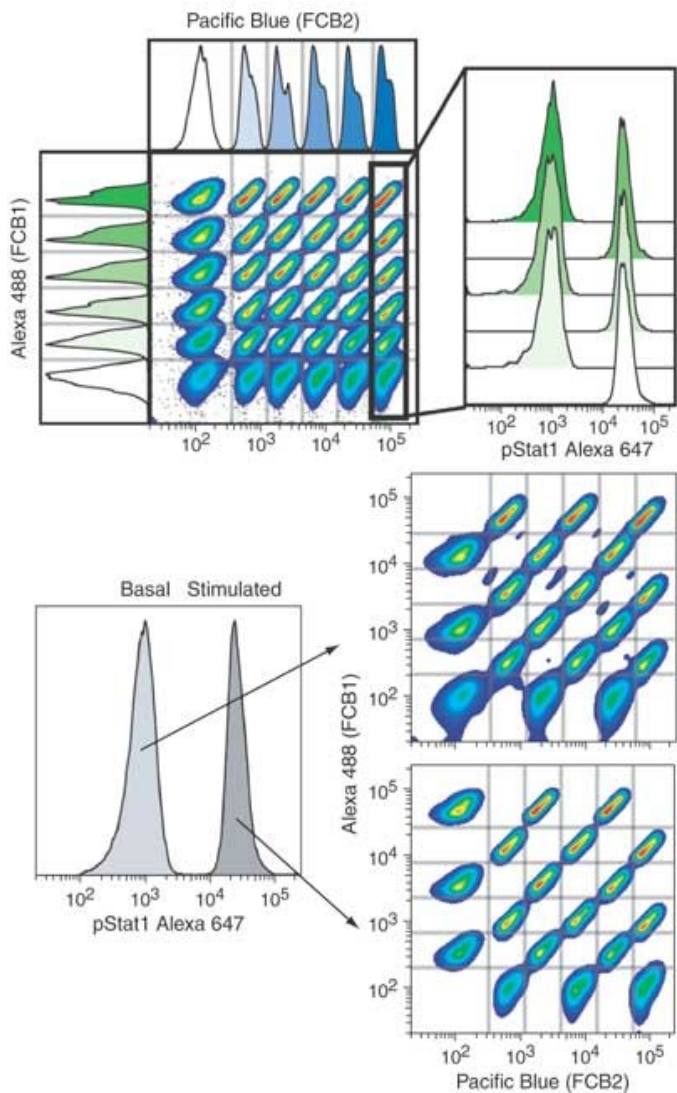

[Krutzik PO, Nolan](#) Fluorescent cell barcoding in flow cytometry allows high-throughput drug screening and signaling profiling. *Nat Methods*. 2006 May;3(5):361-8.



The Nobel Prize in Chemistry 2008

- "for the discovery and development of the green fluorescent protein, GFP"

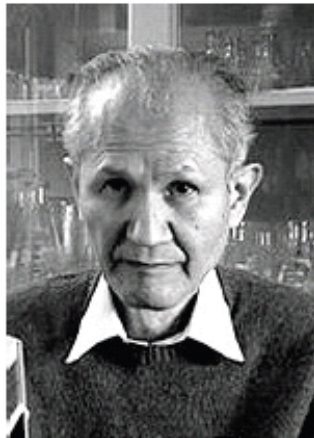

Photo: J. Henriksson/SCANPIX

Osamu Shimomura

🕒 1/3 of the prize

USA

Marine Biological Laboratory (MBL)
Woods Hole, MA, USA;
Boston University Medical School
Massachusetts, MA, USA

b. 1928
(in Kyoto, Japan)



Photo: J. Henriksson/SCANPIX

Martin Chalfie

🕒 1/3 of the prize

USA

Columbia University
New York, NY, USA

b. 1947



Photo: UCSD

Roger Y. Tsien

🕒 1/3 of the prize

USA

University of California
San Diego, CA, USA;
Howard Hughes Medical Institute

b. 1952

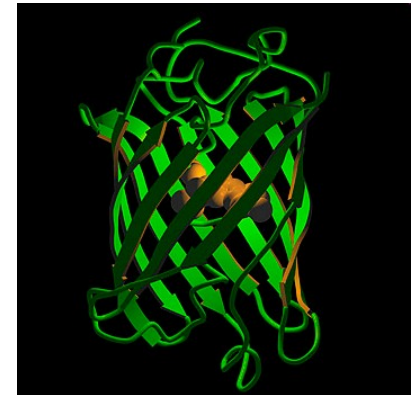

Fluorescent proteins

- bioluminescence resonance energy transfer (BRET)

Aequorea victoria - jellyfish

- Blue bioluminescence. Ca^{2+} interacts with aequorin photoprotein.
- Blue light excites **green fluorescent protein**.

Renilla reniformis – coral

- luminescence appears after degradation of coelenterazine in the presence of luciferase enzyme.
- Blue light excites **green fluorescent protein**

Aequorea victoria “Crystal jelly “

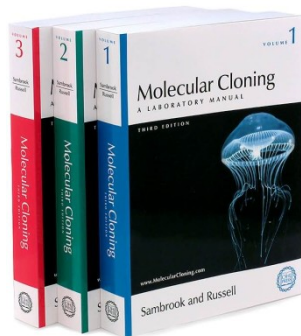

http://www.mbayaq.org/efc/living_species/default.asp?hOri=1&inhab=440

Renilla reniformis "Sea Pansy"



<http://www.whitney.ufl.edu/species/seapansy.htm>

Fluorescent proteins

- **Osamu Shimomura**
 - 1961 discovered GFP and aequorin

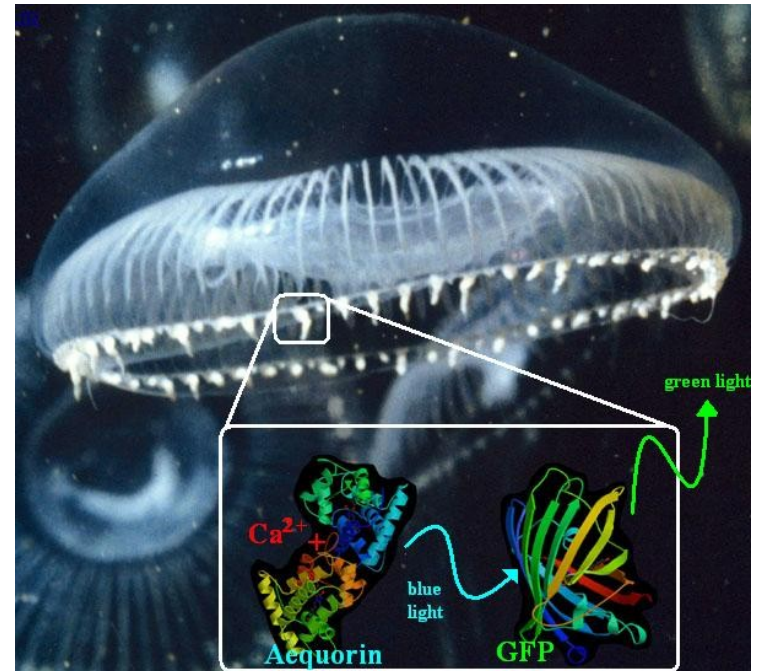
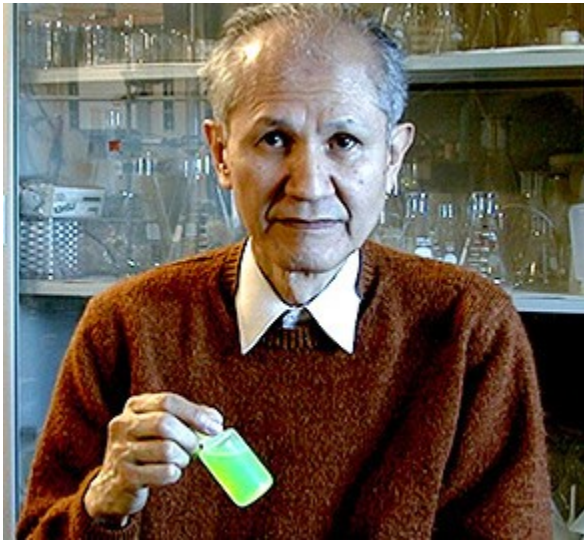

Fluorescent proteins

- Douglas Prasher

- Martin Chalfie

Science. 1994 Feb 11;263(5148):

Green fluorescent protein as a marker for gene expression.

Chalfie M, Tu Y, Euskirchen G, Ward WW, Prasher DC.

Department of Biological Sciences, Columbia University, New York, NY 10027.

- A complementary DNA for the *Aequorea victoria* green fluorescent protein (GFP) produces a fluorescent product when expressed in prokaryotic (*Escherichia coli*) or eukaryotic (*Caenorhabditis elegans*) cells. Because exogenous substrates and cofactors are not required for this fluorescence, GFP expression can be used to monitor gene expression and protein localization in living organisms.

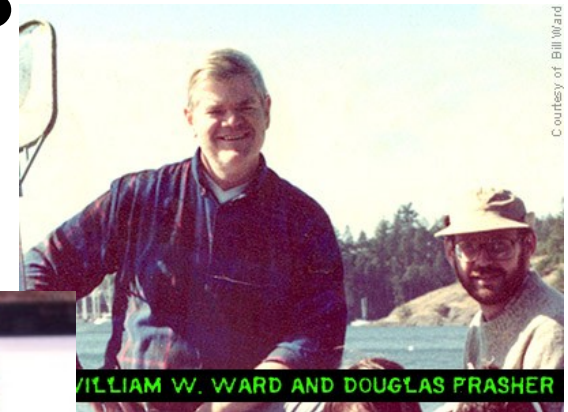

Courtesy of Bill Ward

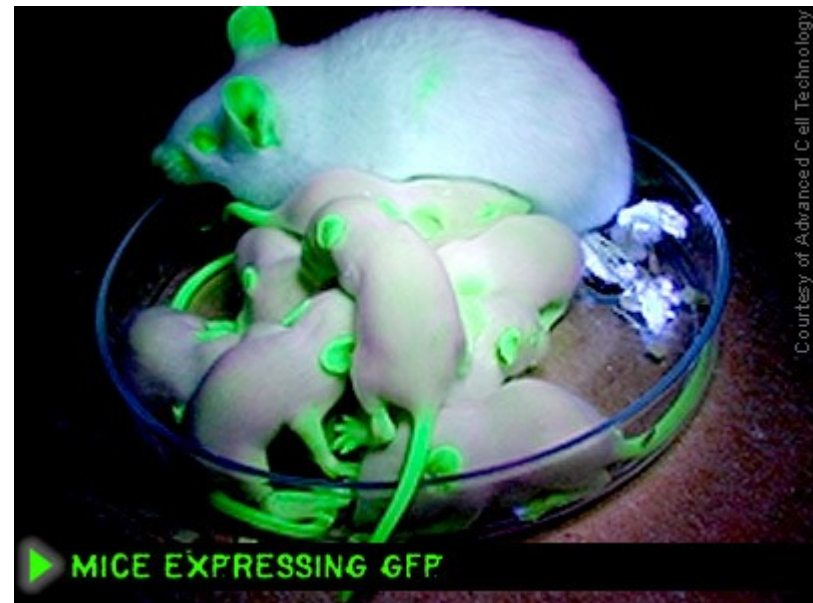

Courtesy of Advanced Cell Technology

Fluorescent proteins

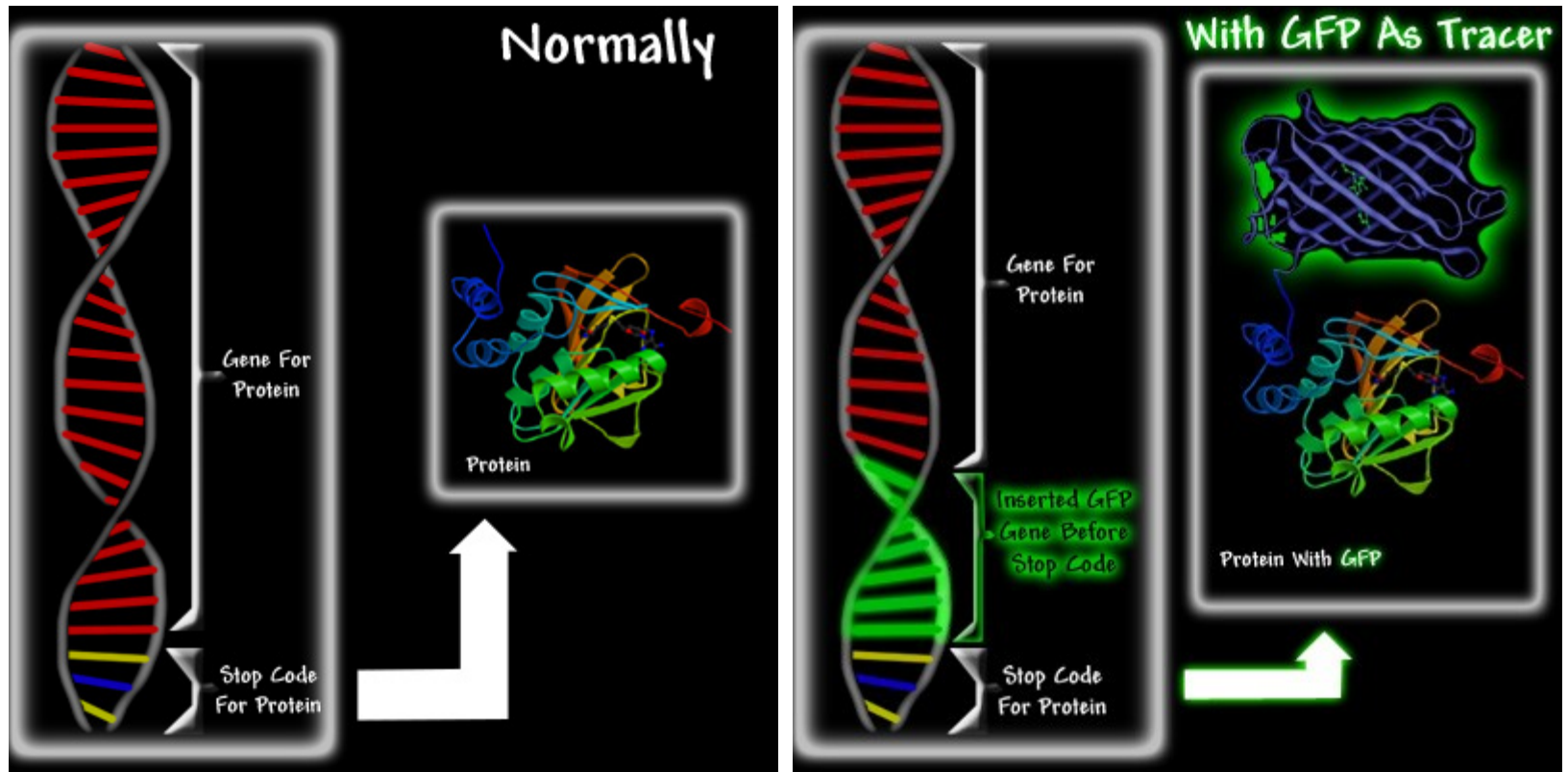

<http://www.conncoll.edu/ccacad/zimmer/GFP-ww/GFP2.htm>

Roger Tsien

- ~ 2002 – mutated FP = wide spectrum of colors

<http://www.tsienlab.ucsd.edu/>

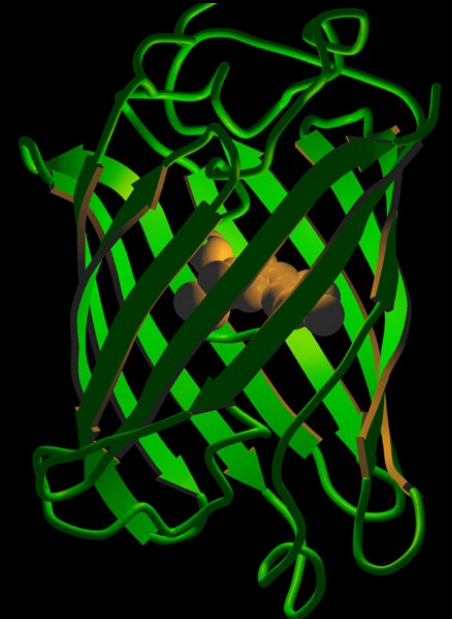
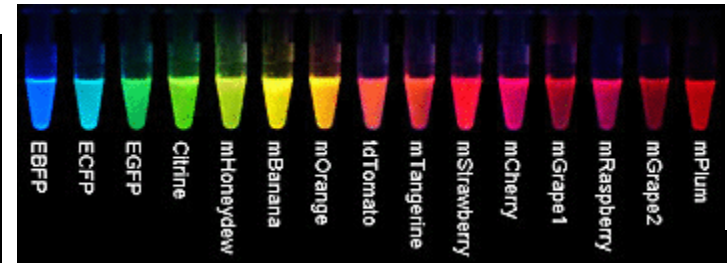
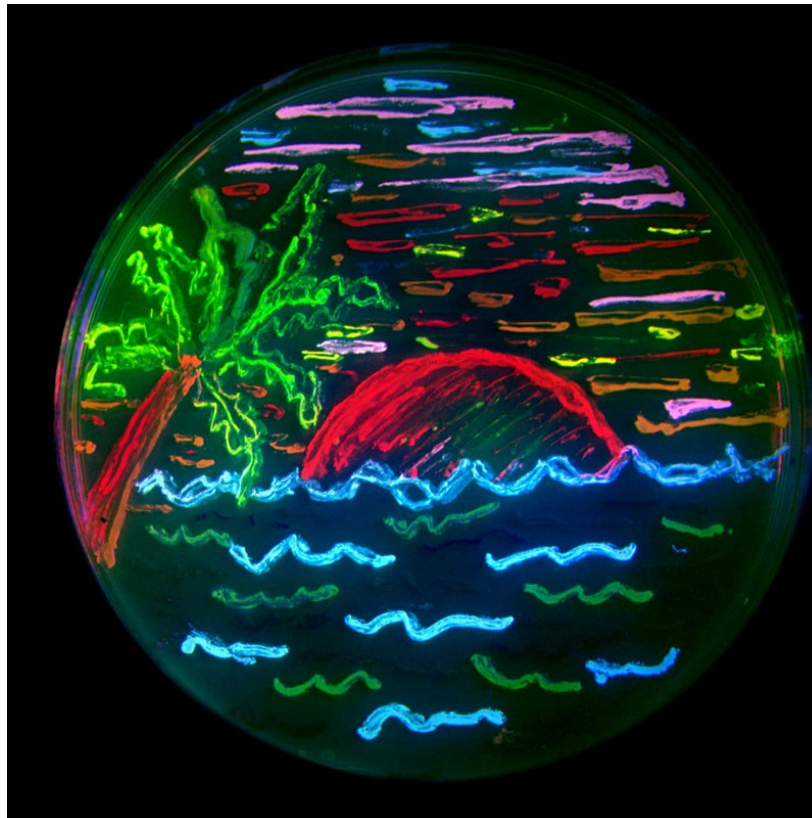

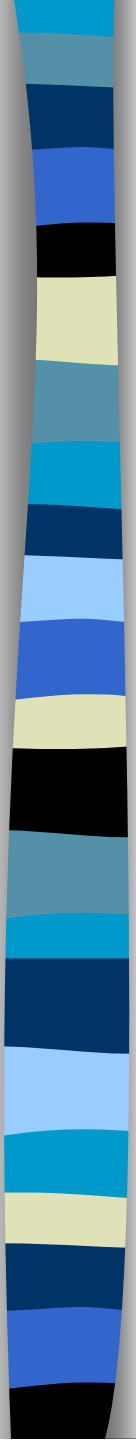

Analysis of synchronized cells

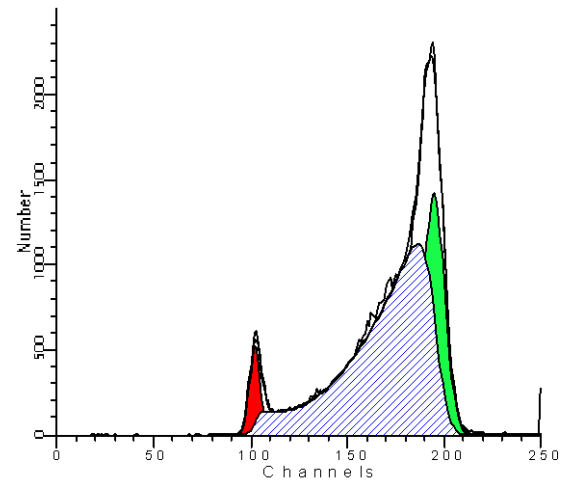
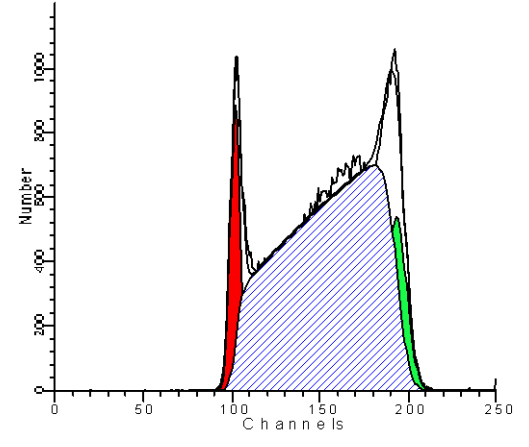
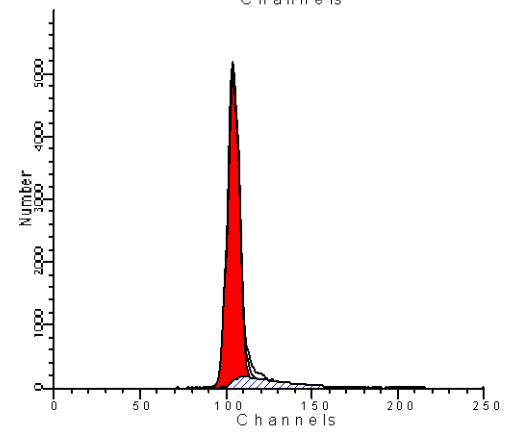
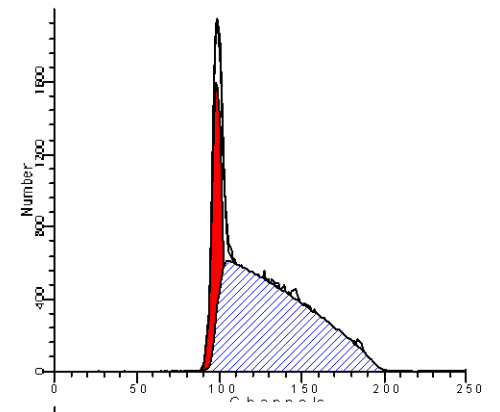
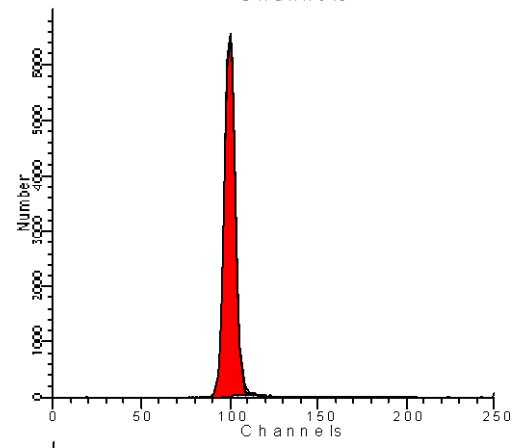
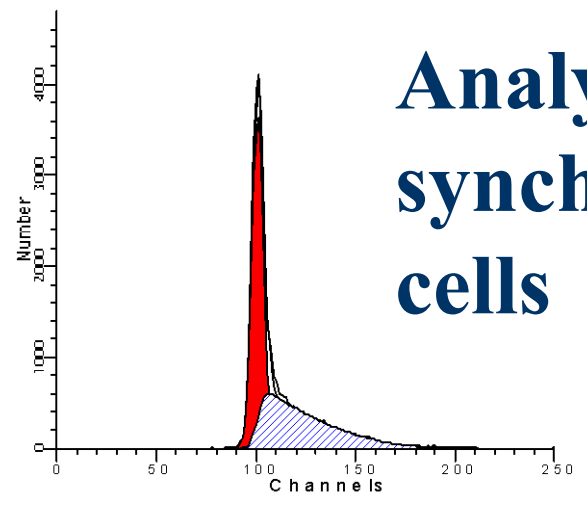
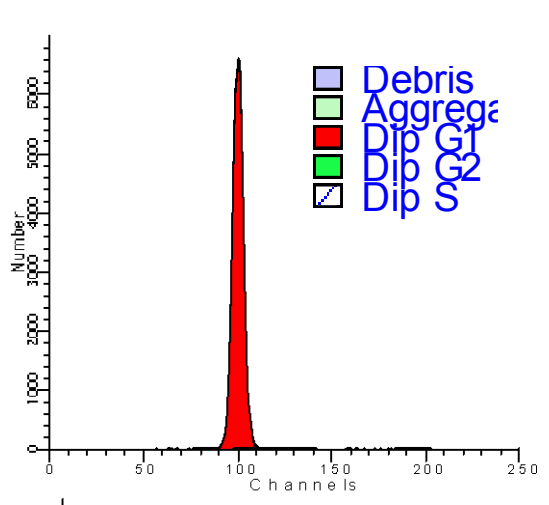

Fucci

(fluorescent ubiquitination-based cell cycle indicator)
cells

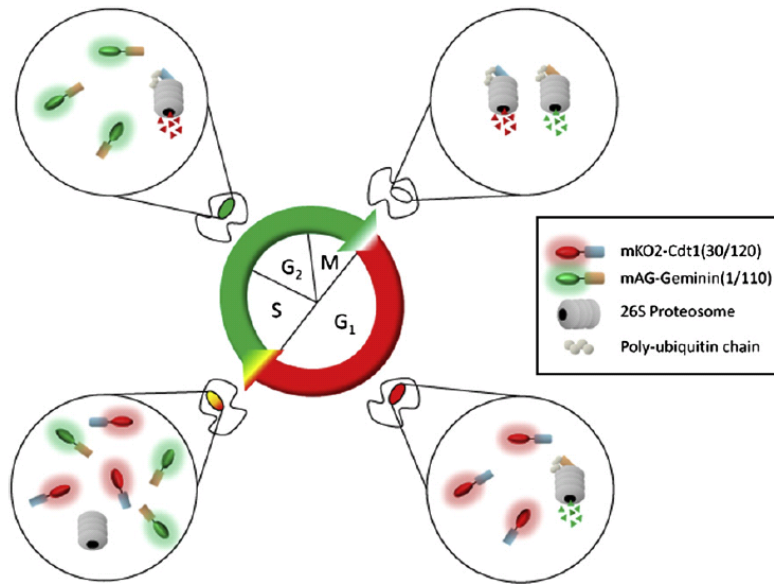

Chemistry & Biology 15, February 2008 ©2008 Elsevier Ltd

Ubiquitin E3 ligase complexes

G1 - APC^{Cdh1}

S, G2, M- SCF^{Skp2}

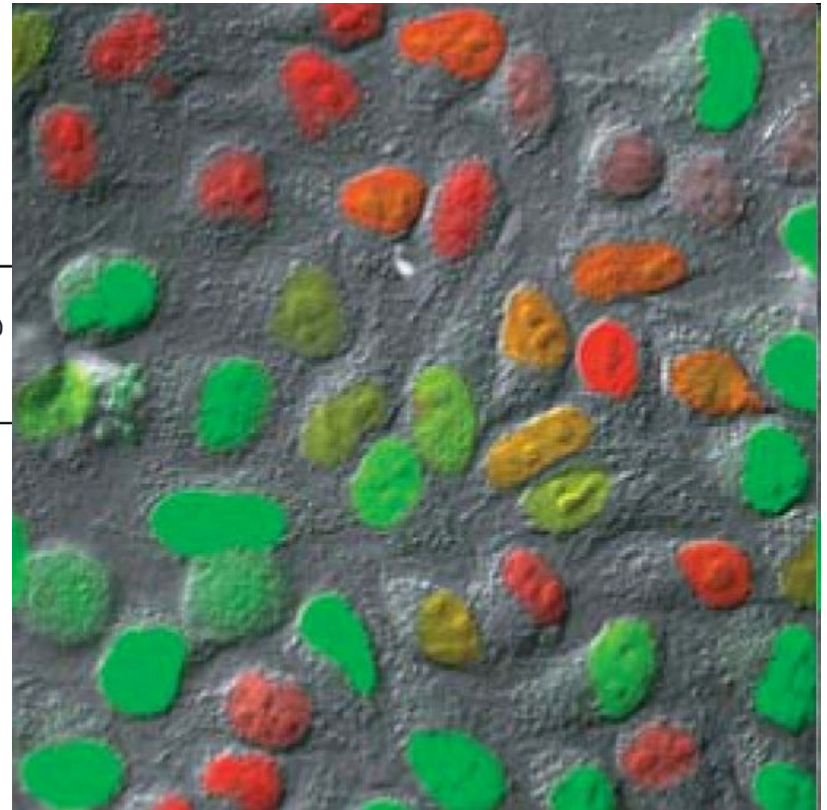

Nature Methods - 5, 283 (2008)

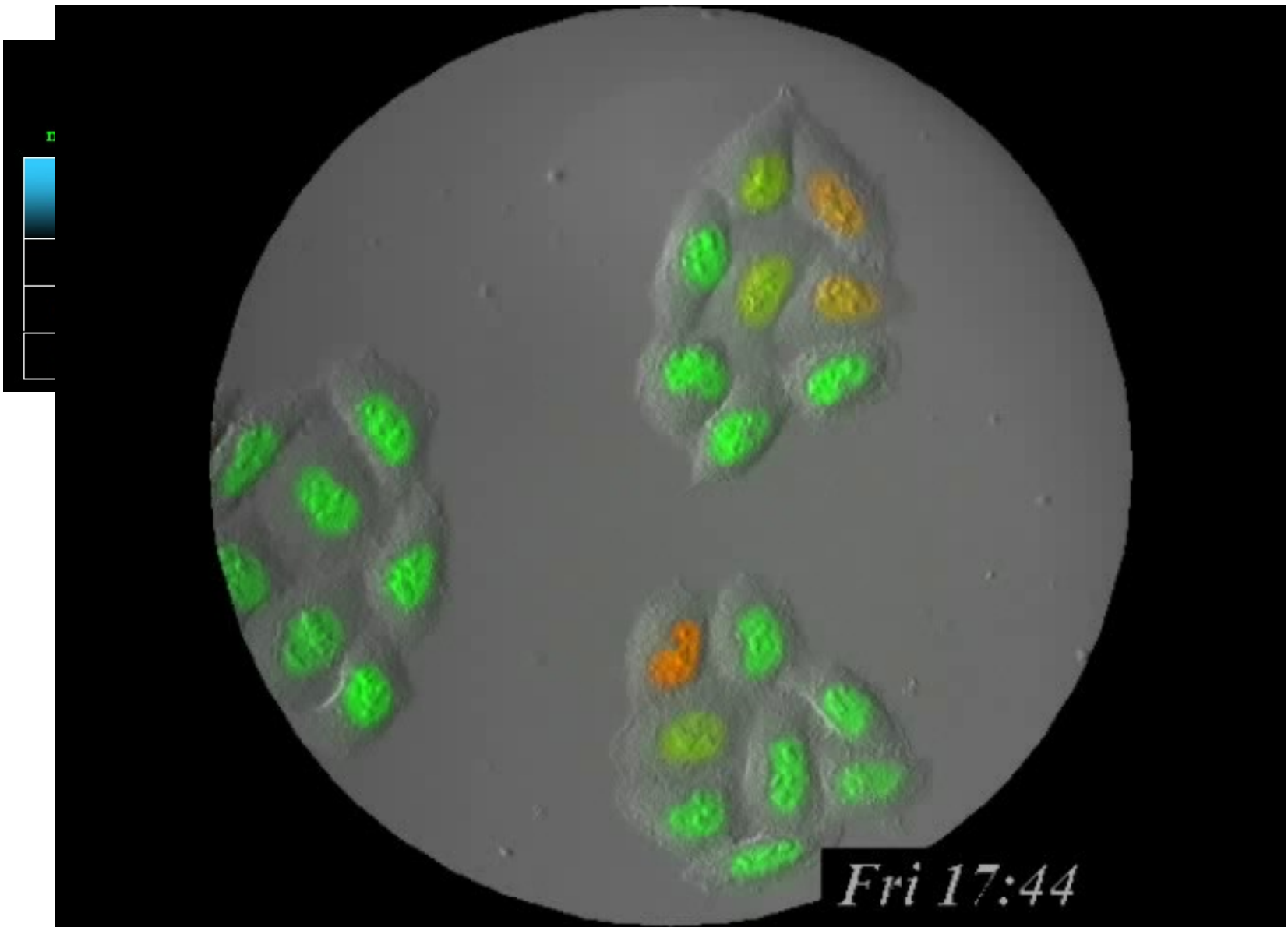
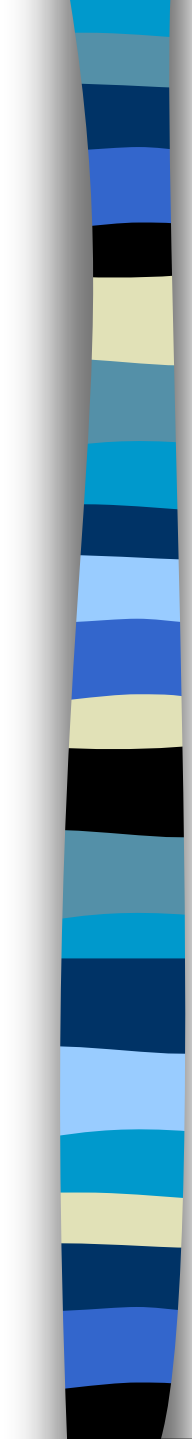

Fri 17:44

Fucci

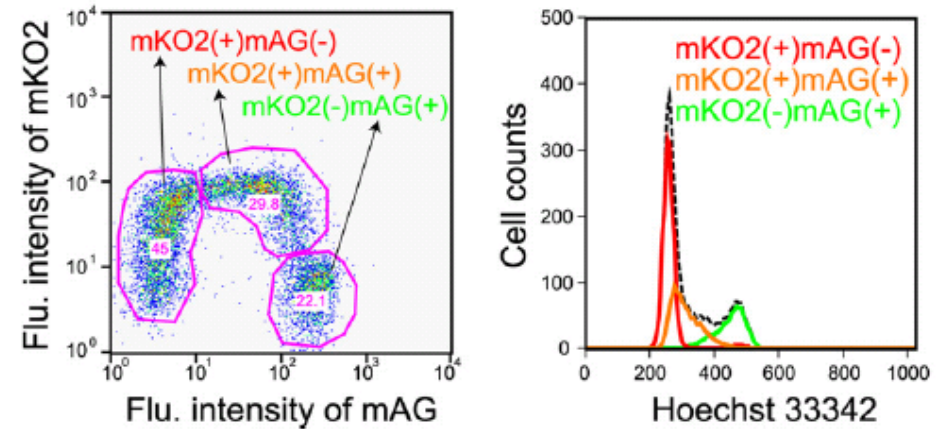
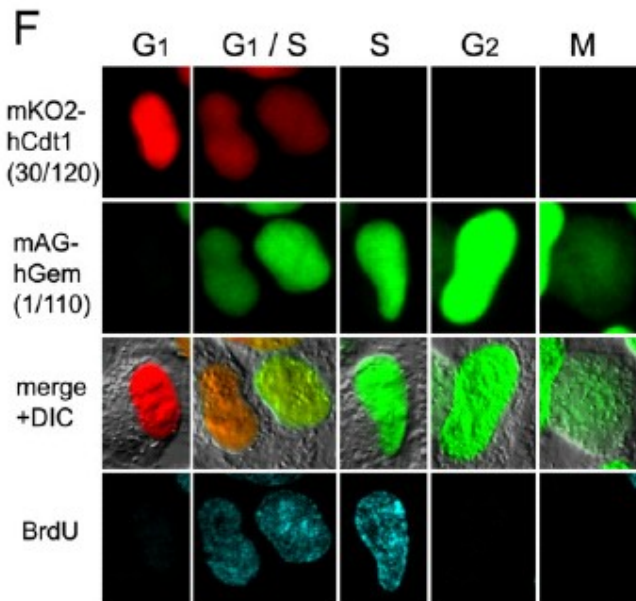

Resource

Cell

Visualizing Spatiotemporal Dynamics of Multicellular Cell-Cycle Progression

Asako Sakaue-Sawano,^{1,3} Hiroshi Kurokawa,^{1,4} Toshifumi Morimura,² Aki Hanyu,⁵ Hiroshi Hama,¹ Hatsuki Osawa,¹ Saori Kashiwagi,² Kiyoko Fukami,⁴ Takaki Miyata,⁶ Hiroyuki Miyoshi,⁷ Takeshi Imamura,⁵ Masaharu Ogawa,² Hisao Masai,⁸ and Atsushi Miyawaki^{1,3,*}

¹Laboratory for Cell Function and Dynamics

²Laboratory for Cell Culture Development

³Advanced Technology Development Group, Brain Science Institute, RIKEN, 2-1 Hirosawa, Wako-city, Saitama 351-0198, Japan

⁴Life Function and Dynamics, ERATO, JST, 2-1 Hirosawa, Wako-city, Saitama 351-0198, Japan

⁵School of Life Science, Tokyo University of Pharmacy and Life Science, 1432-1 Horinouchi, Hachioji, Tokyo 192-0392, Japan

⁶Departments of Biochemistry, The Cancer Institute of the Japanese Foundation for Cancer Research, 3-10-6 Ariake, Koto-ku, Tokyo 135-8550, Japan

⁷Department of Anatomy and Cell Biology, Nagoya University Graduate School of Medicine, 65 Tsurumai-cho, Syowa-ku, Nagoya, Aichi 466-8550, Japan

⁸Subteam for Manipulation of Cell Fate, BioResource Center, RIKEN Tsukuba Institute, 3-1-1 Koyadai, Tsukuba, Ibaraki 305-0074, Japan

*Genome Dynamics Project, Tokyo Metropolitan Institute of Medical Science, 3-18-22 Honkomagome, Bunkyo-ku, Tokyo 113-8613, Japan

*Correspondence: matsushi@brain.riken.jp

DOI 10.1016/j.cell.2007.12.033

<http://cfd brain.riken.jp/Fucci.html>



Summary

- **DNA analysis**

- Require fine sample preparation, debris elimination, sw tool for precise analysis of histograms
- It is possible to combine with analysis of other parameters e.g. DNA synthesis

- **Cell division enumeration**

- Mostly for synchronized populations

- **Fluorescent proteins**

- Fucci – elegant tool for *in vitro* a *in vivo* experiments

Detection of cell death

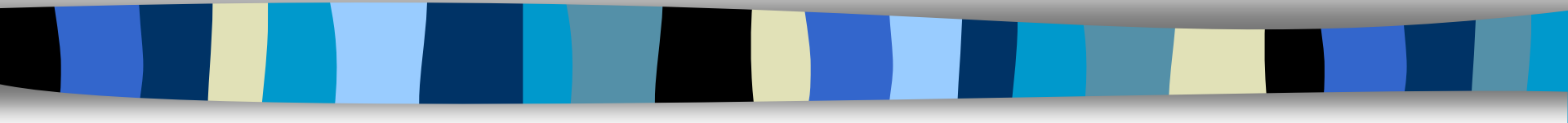

Viability detection

- Simple analysis
- principle
 - Detection of plasmatic membrane integrity using fluorescent probes – **propidium iodide, ethidium bromide, 7-amino actinomycin D**
 - **Only dead cells are positive**
 - Detection of physiological function of the cells (enzymatic activity) – **Rhodamine-123, Calcein-AM**
 - **Only live cells are positive**
- How to stain dead cell and fix&perm it afterwards?
 - **ethidium monoazide**
 - Pomocí **LDS-751** (laser dye styryl-751) je možné odlišit mrtvé buňky i po fixaci
 - **LIVE/DEAD® Fixable Dead Cell Stain Kits, Zombie Dyes™**

Reactive dye	Excitation source	Ex*	Em*
blue fluorescent reactive dye (L23105)	UV	350	450
violet fluorescent reactive dye (L34955)	405 nm	416	451
aqua fluorescent reactive dye (L34957)	405 nm	367	526
yellow fluorescent reactive dye (L34959)	405 nm	400	575
green fluorescent reactive dye (L23101)	488 nm	495	520
red fluorescent reactive dye (L23102)	488 nm	595	615
far red fluorescent reactive dye (L10120)	633/635 nm	650	665
near-IR fluorescent reactive dye (L10119)	633/635 nm	750	775

*Approximate fluorescence excitation (Ex) and emission (Em) maxima, in nm.

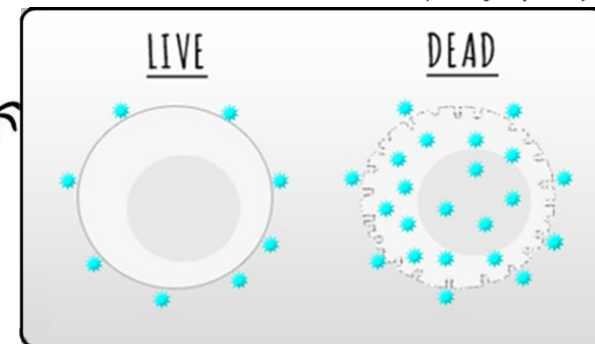

Viability detection

Propidium Iodide

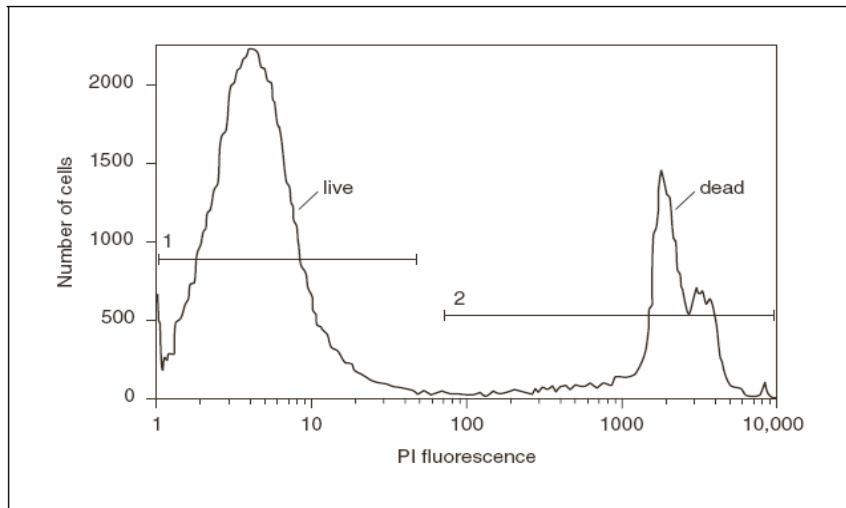

Current Protocols in Cytometry

LIVE/DEAD Far Red

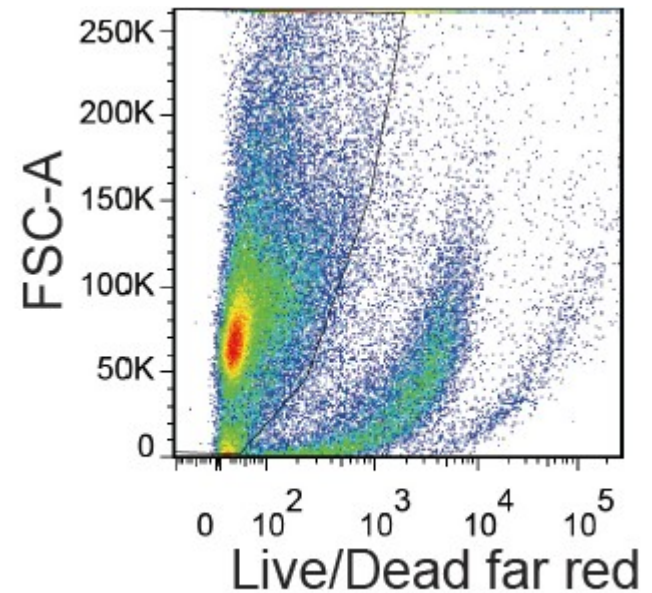



Apoptosis

- Programmed cell death
- described by J. F. Kerr in 1972 to differentiate it from necrosis
- genetically controlled, complex process, directed self-destruction of the cell
- important for homeostasis

Apoptóza

Viable



Apoptotic

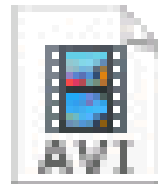
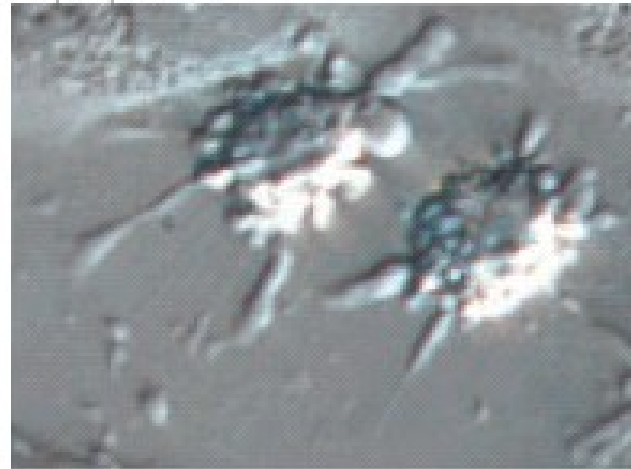

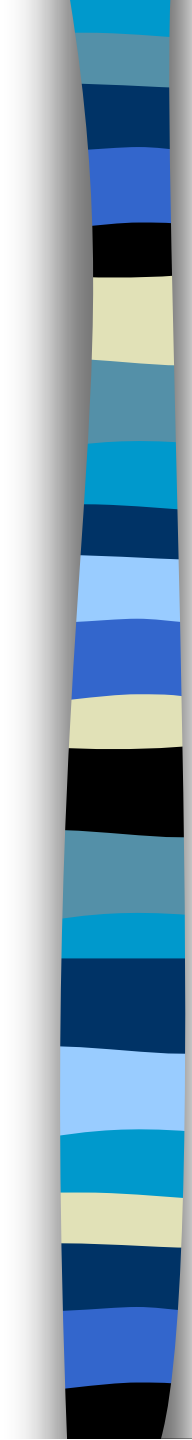

Morphology – necrosis vs. apoptosis

- Loss of integrity of cytoplasmic membrane
 - Swelling of cytoplasm, increase of cell volume
 - Desintegration of nucleus and other organelles
 - Lysis of the cell
- Swelling of cytoplasm without loss of cell integrity
 - Cell shrinkage
 - Condensation of the nucleus and specific chromatin fragmentation
 - Sustained organelle integrity
 - Formation of apoptotic bodies

Two Different Types of Cell Death

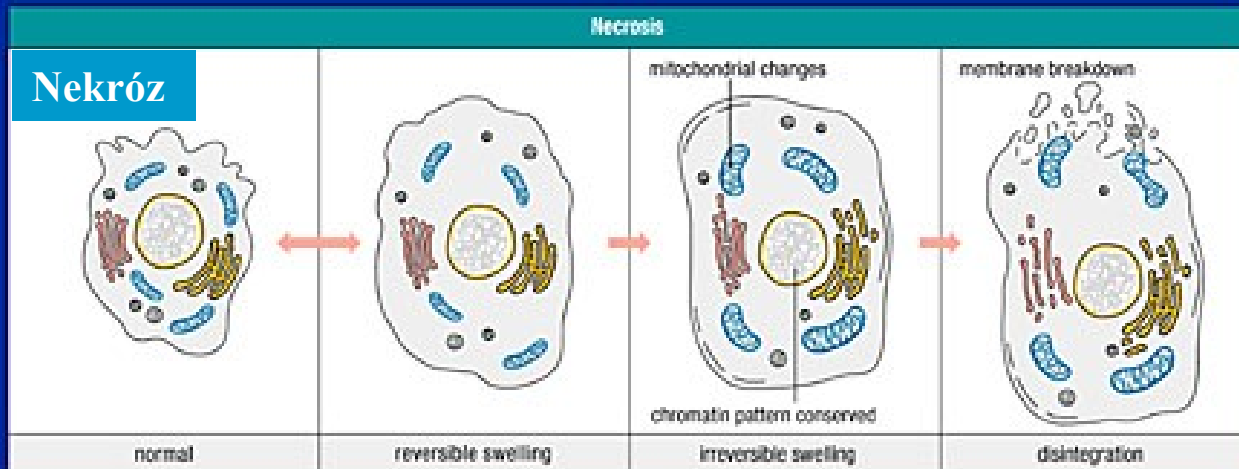

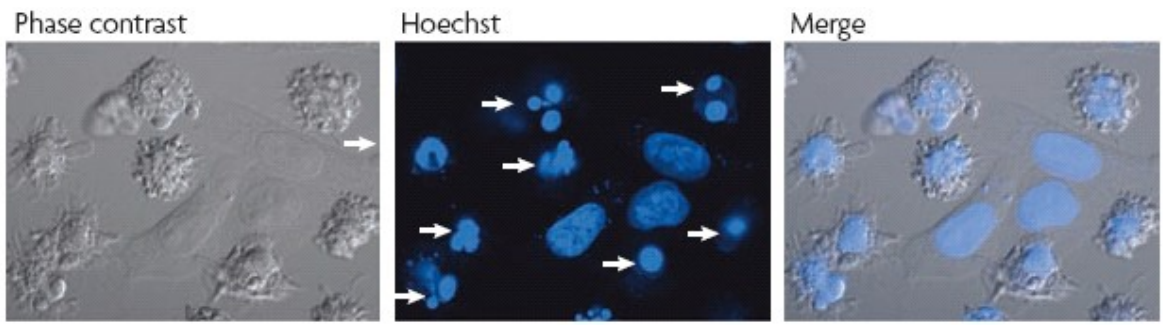

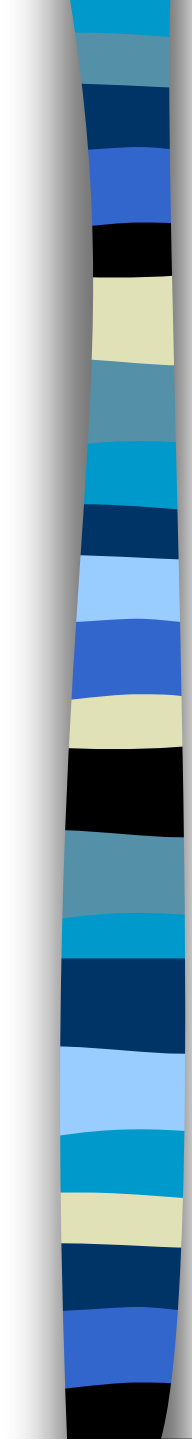

Biochemistry – necrosis vs. apoptosis

- Without specific molecular control
- Passive process without energy (ATP)
- Uncontrolled nuclear DNA destruction
- Without role of mitochondria
- Loss of ion balance control
- Activation of specific signaling pathways – **caspsases, nucleases**
- Energy (ATP) consumption
- **Specific fragmentation of DNA**
- Release of regulatory molecules from **mitochondria**
- Changes in **symmetry of lipid membranes**

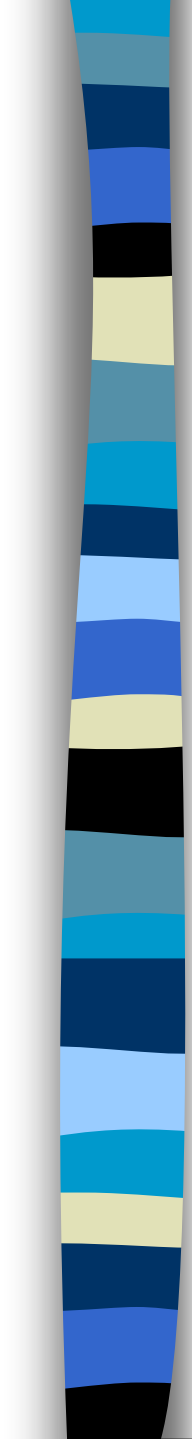

Physiological role— necrosis vs. apoptosis

- **Affects cell populations**
- **Induced by non-physiological stimuli**
- **Destruction of surrounding tissue – release of toxic compounds**
- **Induces inflammation**
- **Affects single cells**
- **Induces via physiological stimuli**
- **phagocytosis**
- **Withoutt presence of inflammation**



General hallmarks of apoptosis

- **Characteristics of cellular membranes**
- **Characteristics of nucleus**
- **Detection of specific genes and proteins regulating apoptosis**

Regulation of apoptosis

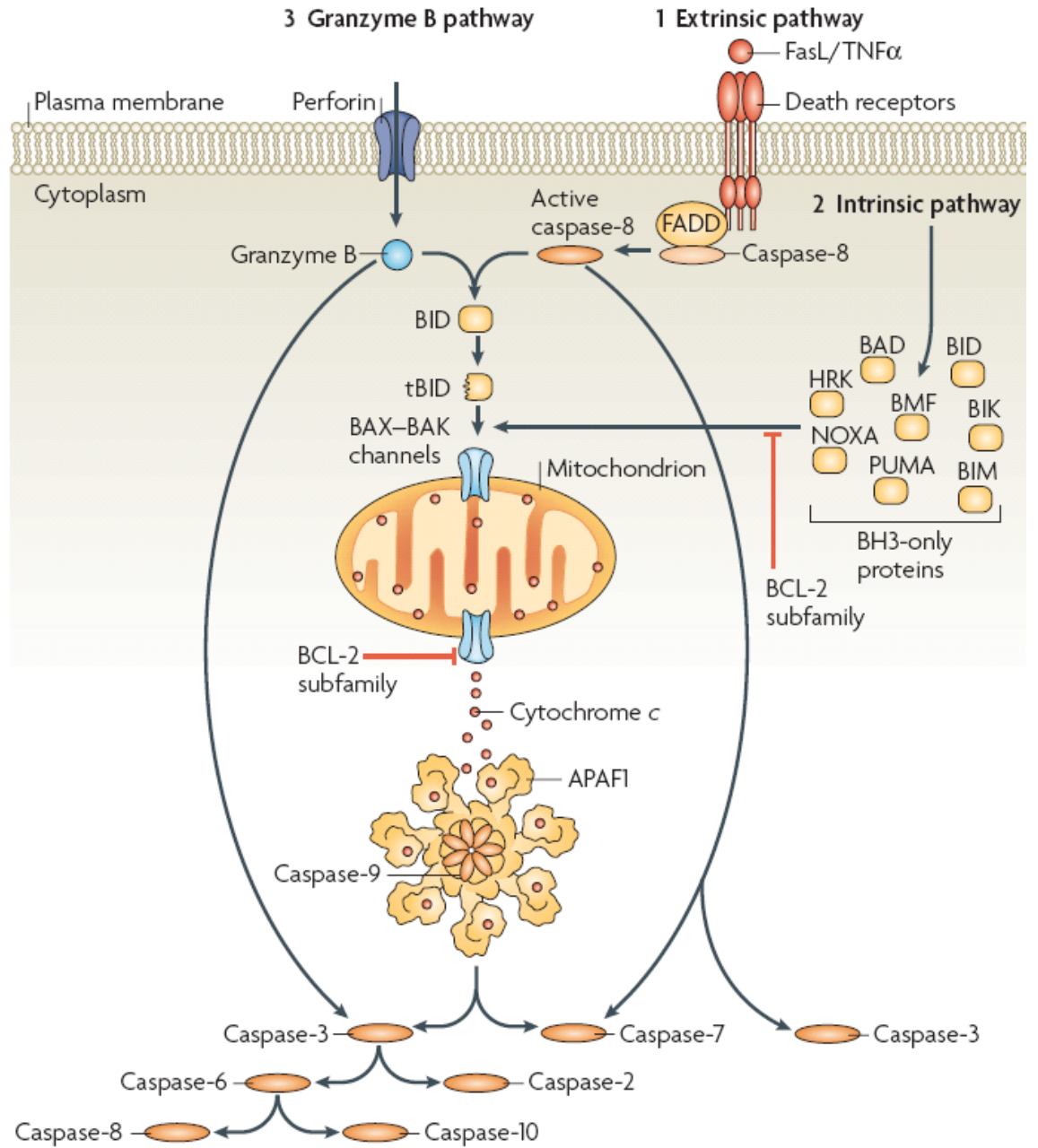



Characteristics of membranes

■ Plasmatic membrane

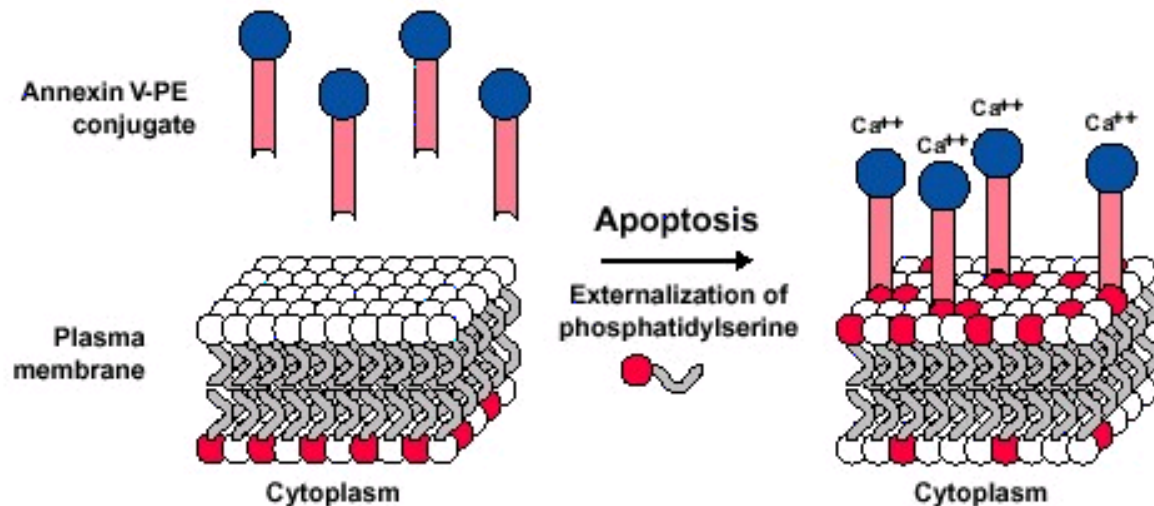
- Integrity of plasmatic membrane
- Important changes in symmetry
 - Externalization of phosphatidylserines (PS) – „eat me“ signal for phagocytes
 - Annexin V – high affinity to PS – sensitive probe for asymmetric membrane



Annexin V staining: phosphatidylserine exposure

 Annexin V-
 conjugate
 phosphatidyl-
 serine

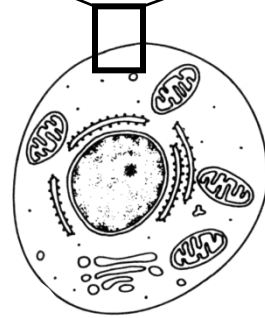
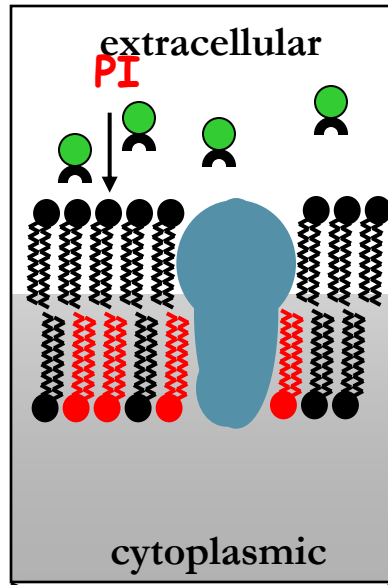

normal cell

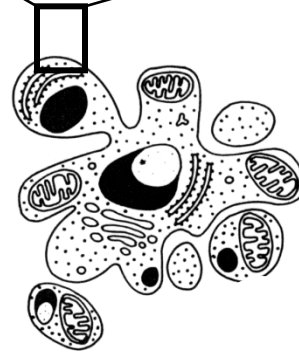
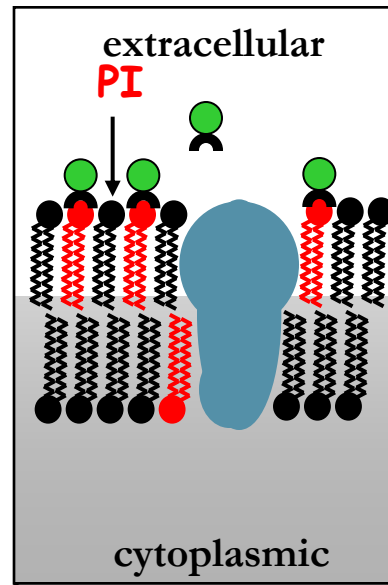

apoptotic cell

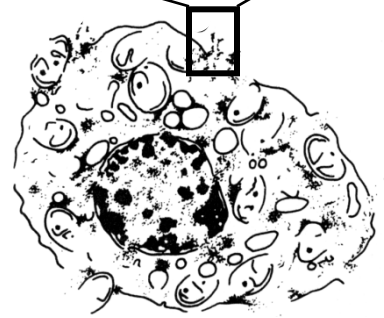
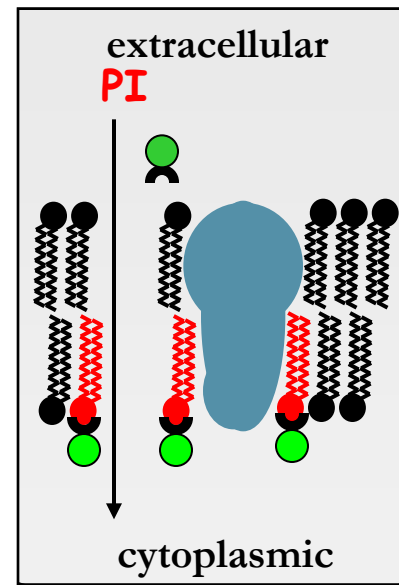

necrotic cell

staining	normal cell	apoptotic cell	necrotic cell
Annexin V	-	+	+
propidium iodide	-	-	+

Annexin V/PI assay

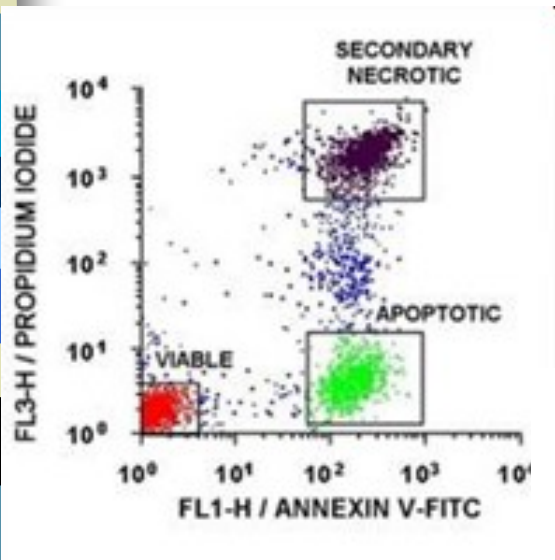

Importance of timing
(apoptosis, necrosis, secondary necrosis)

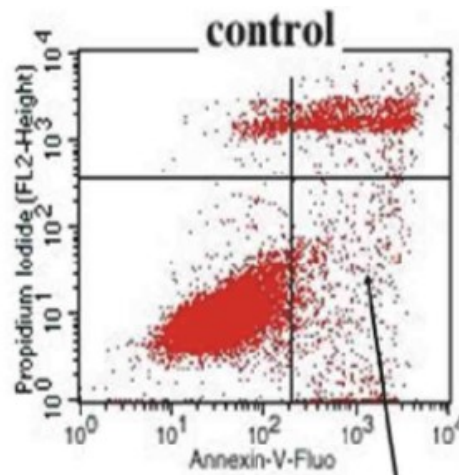

5 %

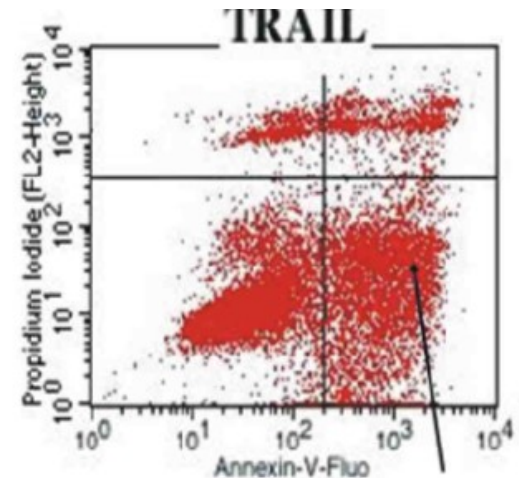

26 %

A. Hyršlová Vaculová



Detection of PS translocation

- **Pros**

- specific marker, relative early
- possible to combine with other vital markers e.g. CD antigens

- **Cons**

- Necessary to label already dead cells
- Optimization of the protocol for particular cell type
- Measurement has to be done quickly
- Not possible to analyzed in fixed cells



Characteristics of membranes

■ Mitochondrial membranes

- Changes in outer mitochondrial membrane permeability
- Changes in mitochondrial membrane potential $\Delta\Psi_m$
- Release of apoptosis mediator from mitochondrial intermembrane space into cytoplasm

Death signal convergence onto mitochondria

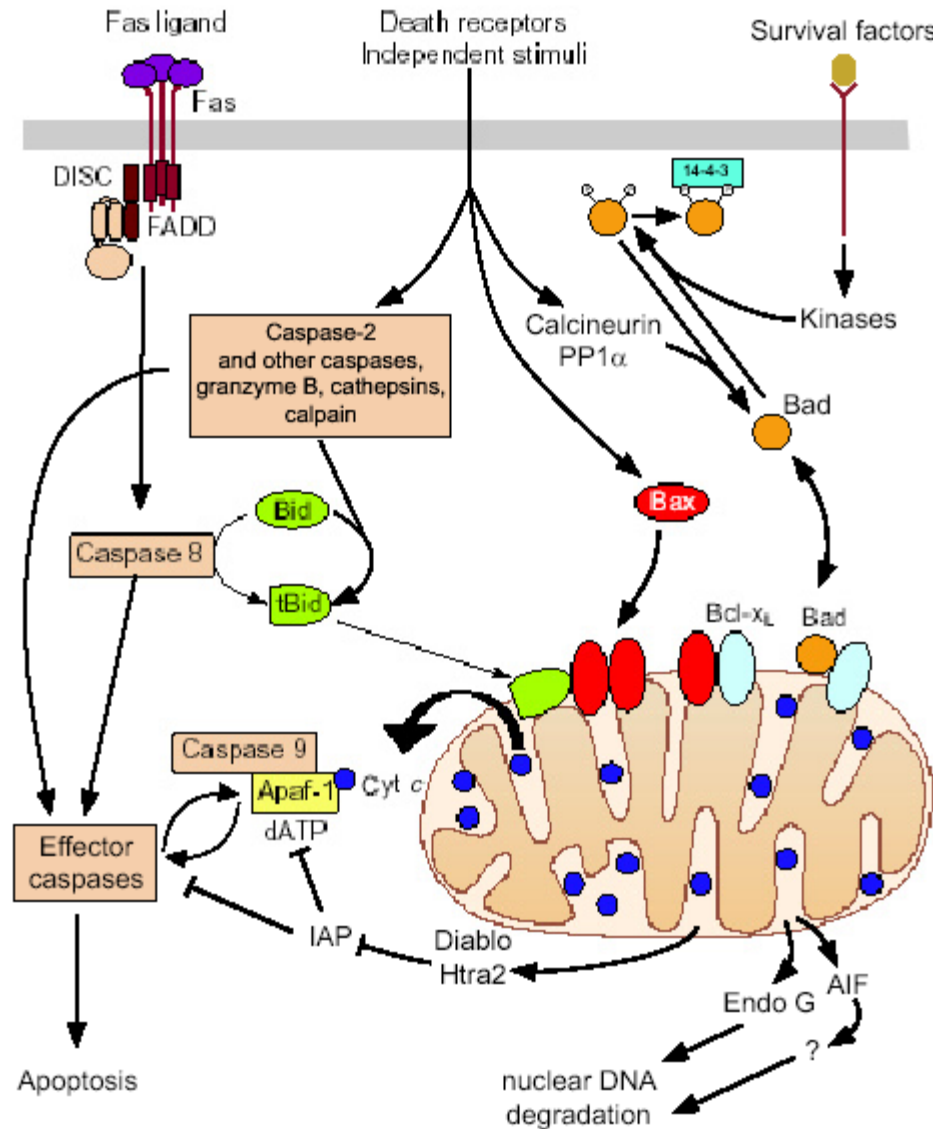

Baliga B., Kumar S. (2003) *Cell Death Differ.* 10: 16-18
 Desagher S., Martinou J. C. (2000) *Trends Cell Biol.* 10: 369-377
 Van Loo G., et al. (2002) *Cell Death Differ.* 9: 1031-1042

Mitochondria a $\Delta\Psi_m$

$$\Delta p = \Delta\Psi_m - 60 \Delta\text{pH}$$

$\Delta p \sim$ electrochemical proton gradient (180mV)

$\Delta\Psi_m \sim$ mitochondrial membrane potential (MMP)
(150mV)

$\Delta\text{pH} \sim$ pH gradient

Δp drives ATP-ADP transport, import mitochondrial proteins and transport of metabolites

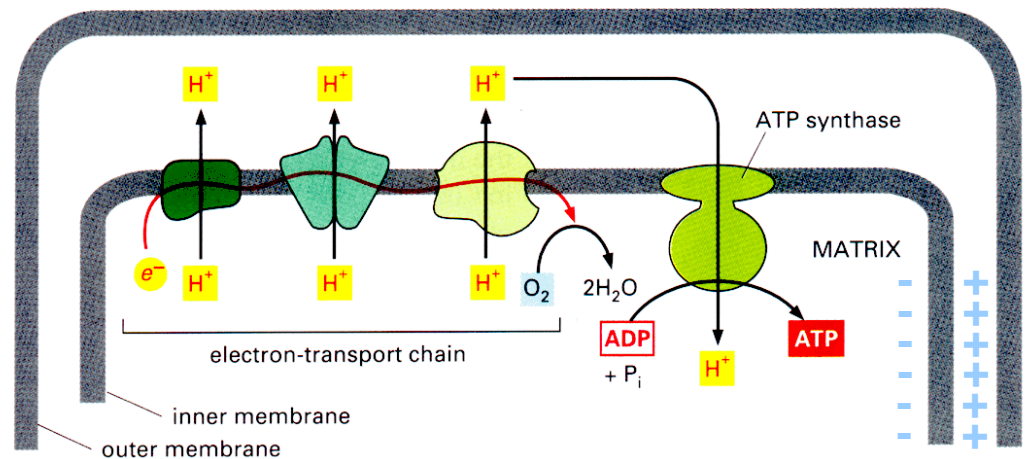



Mitochondria, $\Delta\Psi_m$ and apoptosis

Depolarization of mitochondrial membrane and $\Delta\Psi_m$ loss can be consequence of „permeability transition pores“ (PTP) or loss of integrity of outer mitochondrial membrane

Depolarization of mitochondria is associated with:

- ischemia/reperfusion
- oxidative stress
- cell death

Mitochondria, $\Delta\Psi_m$ and apoptosis

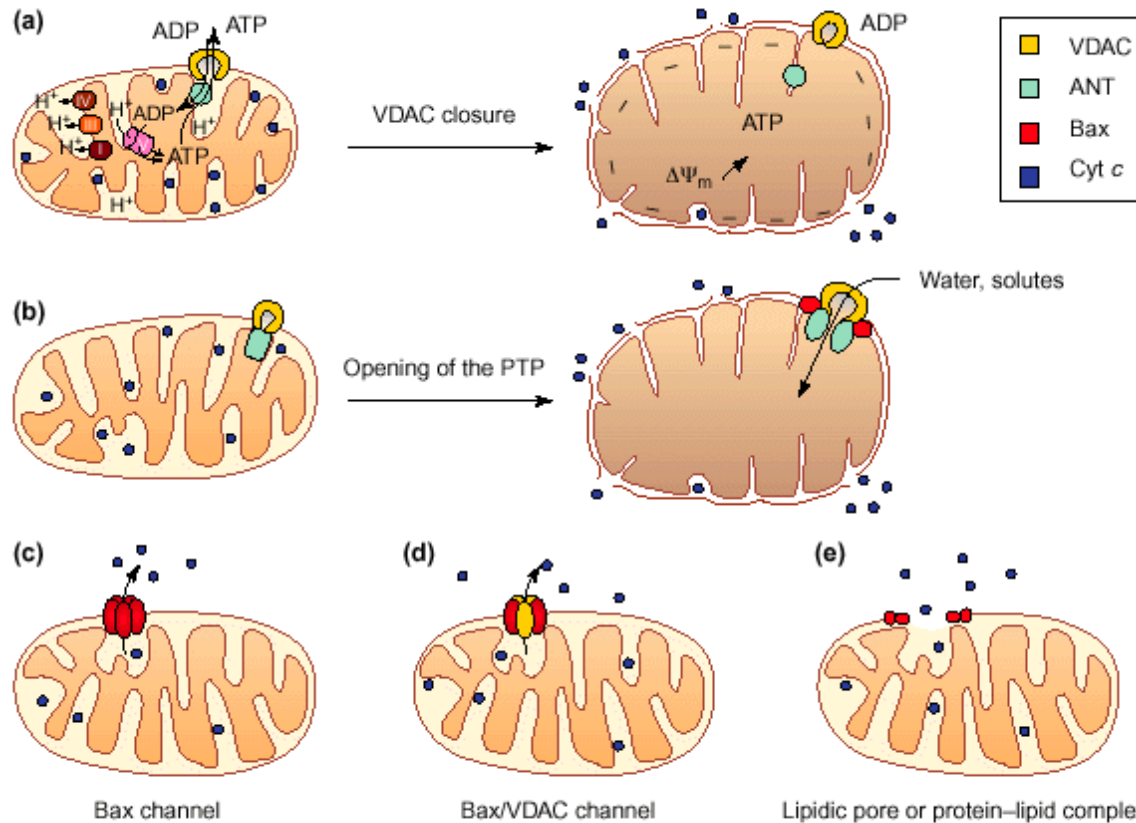

VDAC ~ voltage-dependent anion channel

ANT ~ adenine-nucleotide translocator

trends in Cell Biology

$\Delta\psi_m$ detection

- electrodes
- Radioactive probes
- Lipophilic fluorescent cation

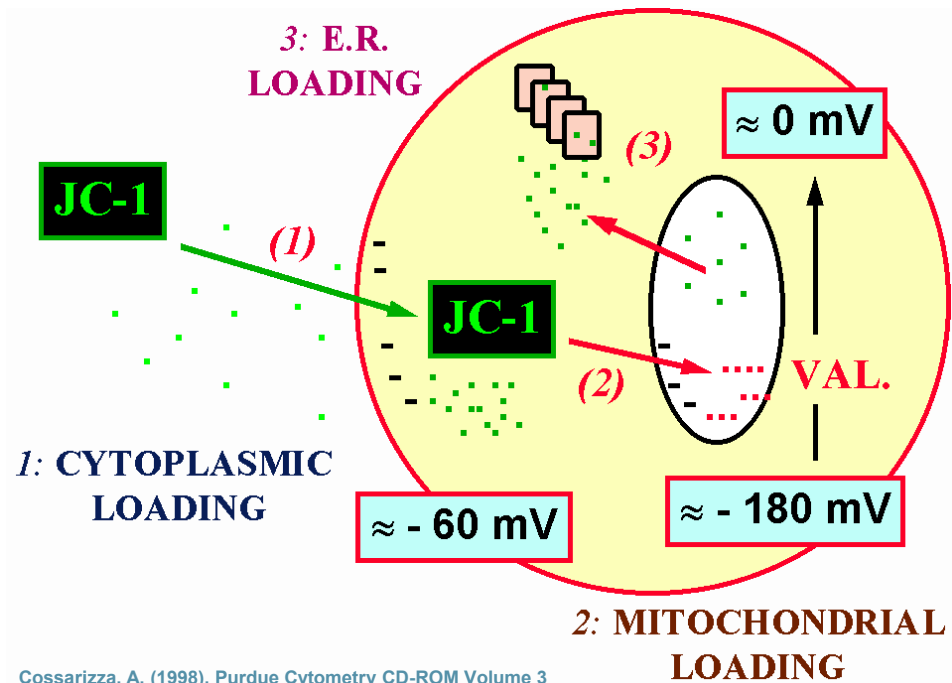

Fluorescent probes for $\Delta\Psi_m$ analysis

indicator	Ex. =>Em.	Notes
3,3'-dihexyloxacarbocyanine iodide (DiOC6(3))	484 => 501	- detects whole cellular potential - inhibition of Complex I - phototoxic
MitoTracker® Green	490 => 516	- covalent binding - activation of PTP, inhibition of Complex I
MitoTracker® Orange	554 => 576	Fixation compatibility ?
MitoTracker® Red	579 => 599	Fixation compatibility ?
<i>MitoFluor® Green</i>	490 => 516	
<i>MitoFluor® Red 594</i>	598 => 630	
<i>MitoFluor® Far Red 680</i>	680 => 700	
rhodamine 123	507 => 529	- phototoxicity - Inhibitory of mit. ATPase
5,5',6,6'-tetrachloro-1,1', 3,3'- tetraethylbenzimidazolylcarbocyanine iodide (JC-1 ; CBIC2(3))	514/585 => 529/590	monomers vs. aggregates - fotosensitive
tetramethylrhodamine, ethyl ester, perchlorate (TMRE)	549 => 574	- Low phototoxicity
tetramethylrhodamine, methyl ester, perchlorate (TMRM)	549 => 573	

$\Delta\Psi_m$ detection

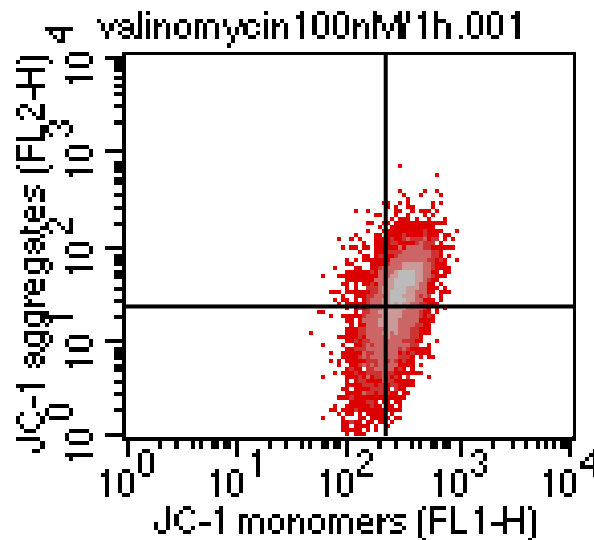
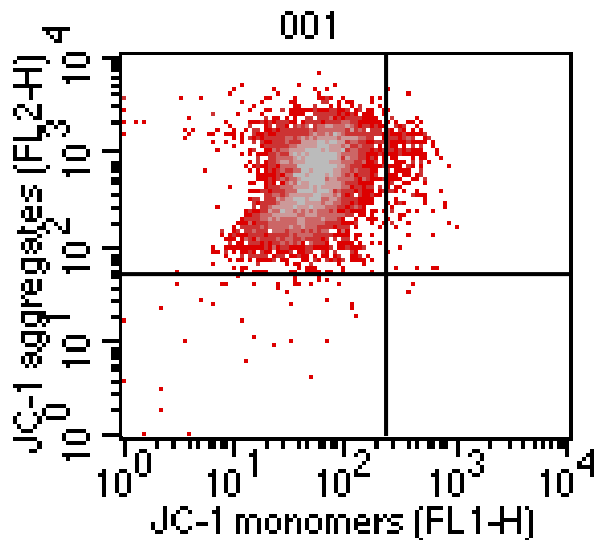

JC-1

5,5',6,6'-tetrachloro-1,1',3,3'-
tetraethylbenzimidazolylcarbocyanine iodide
ex./em. = 514/529 nm, monomer form;
585/590 nm J-aggregate form

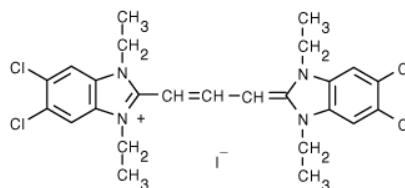

TMRE

ex./em. = 551/576 nm
tetramethylrhodamine, ethyl ester, perchlorate

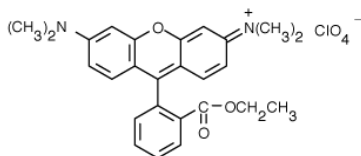

NIH 3T3

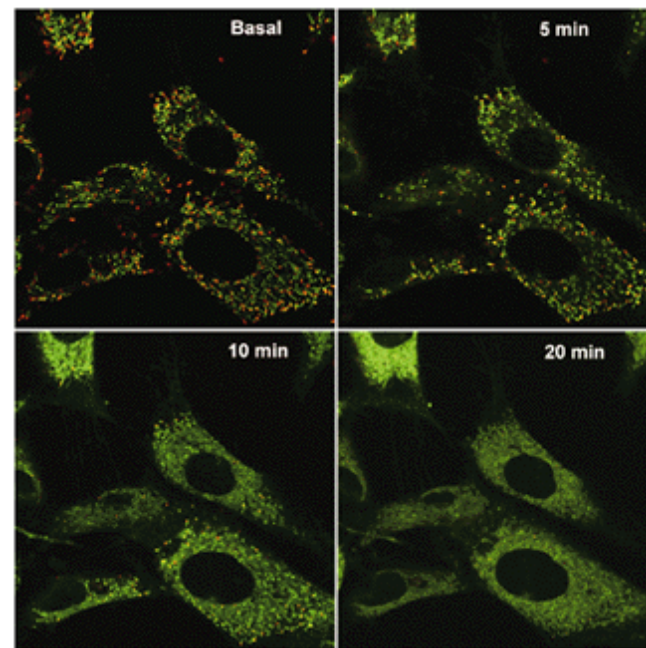



Possible combination of $\Delta\Psi_m$ analysis and other parameters

Vital staining

- CD antigens (TMRE, CMXRos/anti-CD Ab-FITC)
- PS translocation (TMRE, CMXRos/Annexin V-FITC)
- ROS productions (TMRE/DHR-123)
- Ca^{2+} (TMRE/Fluo-3)
- viability (propidium iodide, 7-AAD)
- fluorescent proteins (TMRE/GFP)

Detection $[Ca^{2+}]_i$ and $\Delta\Psi_m$

Fluo-3 AM/TMRE

(HL-60/DMSO/120 h)

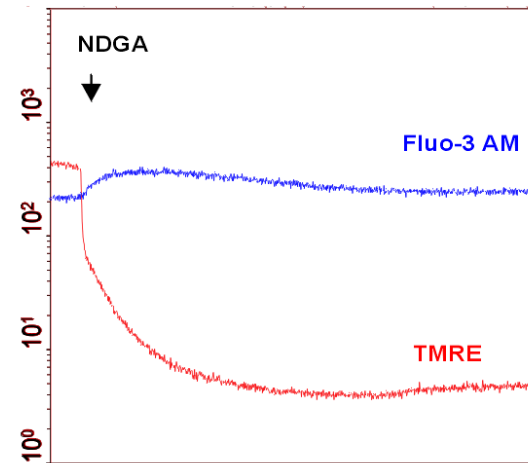
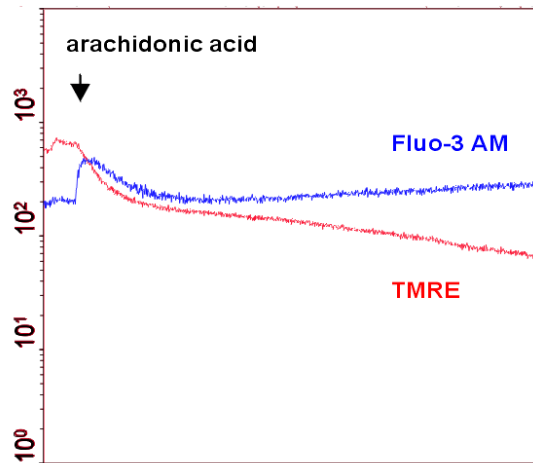
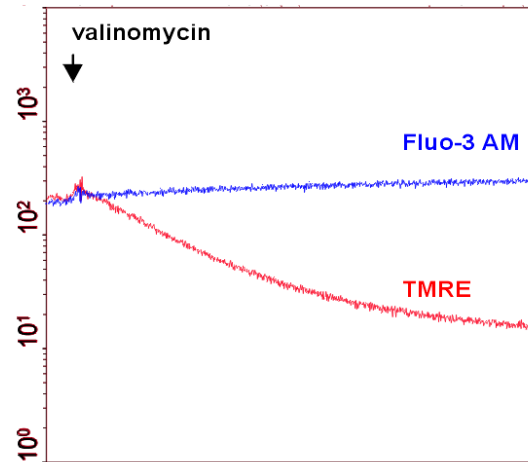
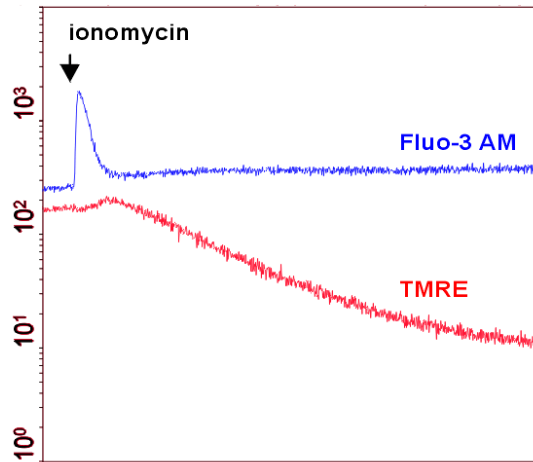

Detection of ROS and $\Delta\Psi_m$

DHR-123/TMRE

Human promyelocytes HL-60
Valinomycin (100 μM)
NDGA (20 μM)

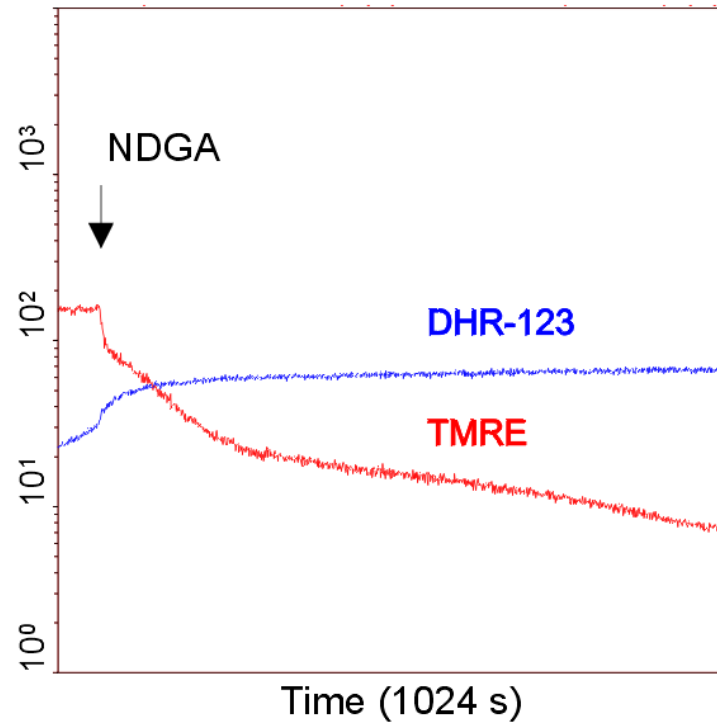
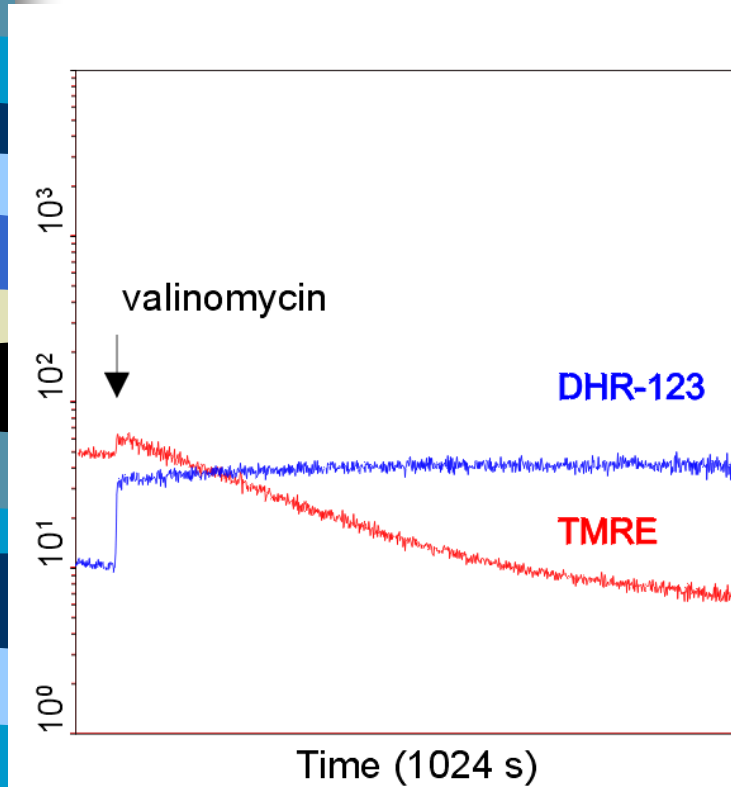



Analysis of MMP

- **Pros**

- **Simple, easy, relatively low cost**
- **Good separation between pos and neg populations**
- **Possible to combine with other vital analyses**

- **Cons**

- **Specificity has to be confirmed using different method**
- **Not always specific**
- **Optimization of probe concentration**

Changes at nucleus

- **Condensation and fragmentation of nuclear chromatin**
- **Characteristic morphology**

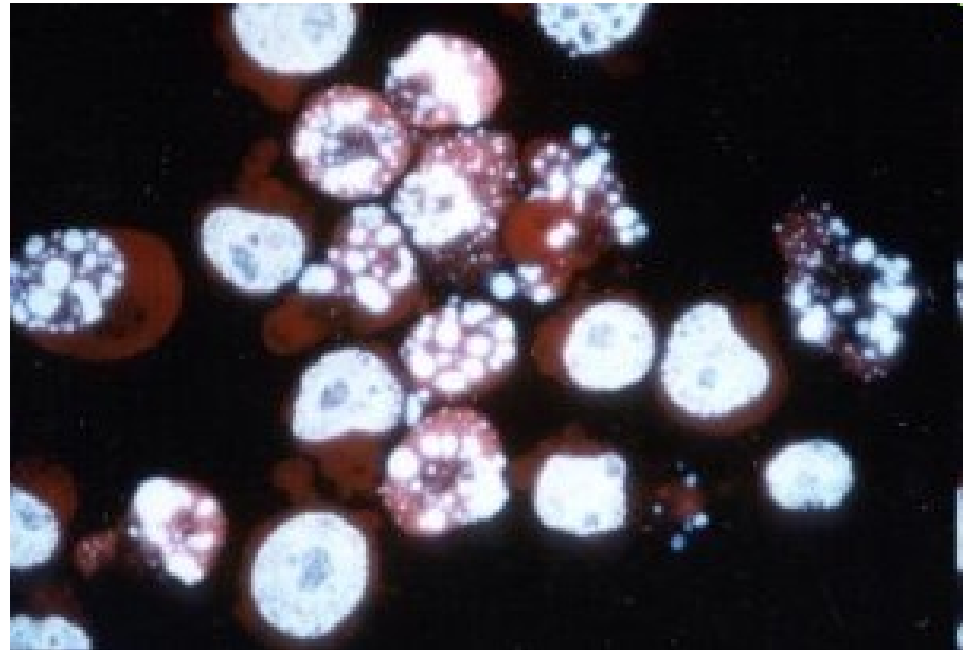

- Analysis of DNA fragmentation
 - sub G_0/G_1 population
 - TUNEL

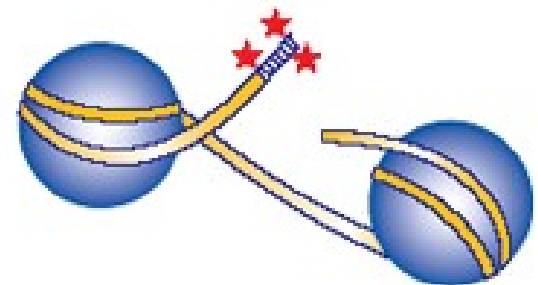
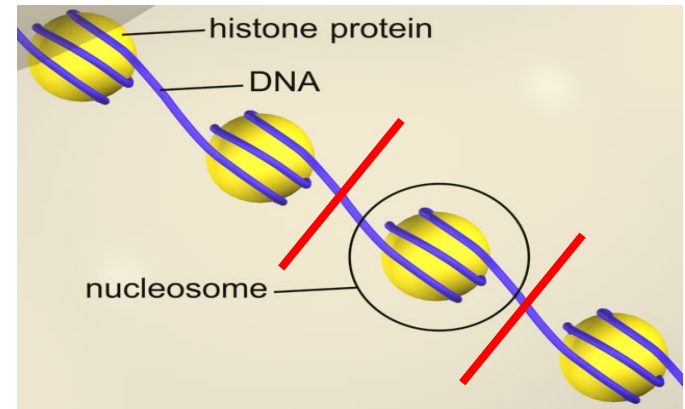

Normal Cell Cycle

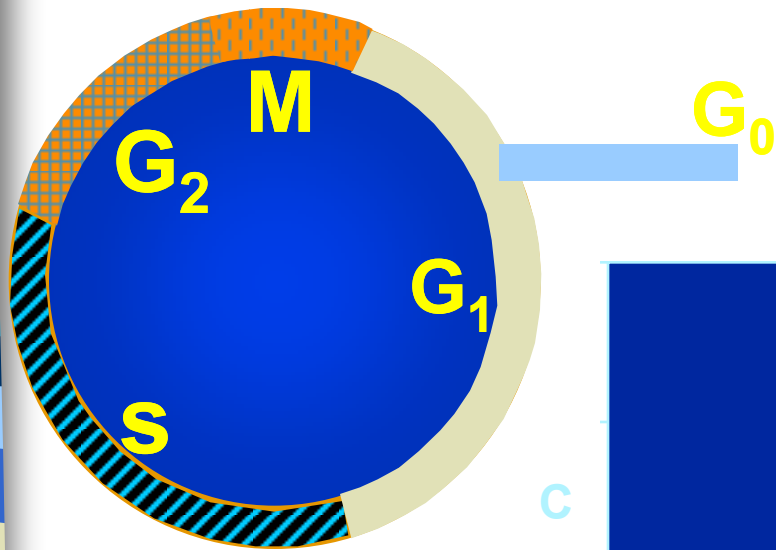

DNA Analysis

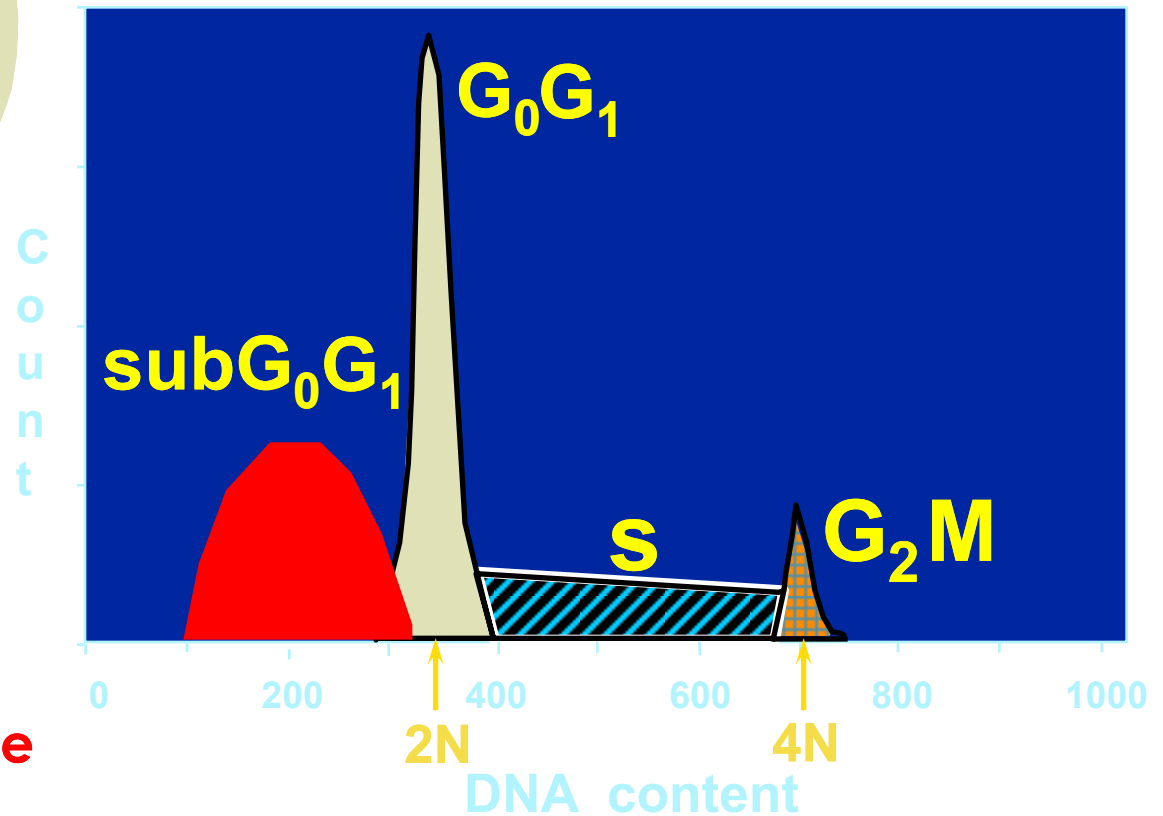

- propidium iodide
- DAPI
- Hoechst 33342
- 7-AAD

Analysis of subG₀/G₁ population

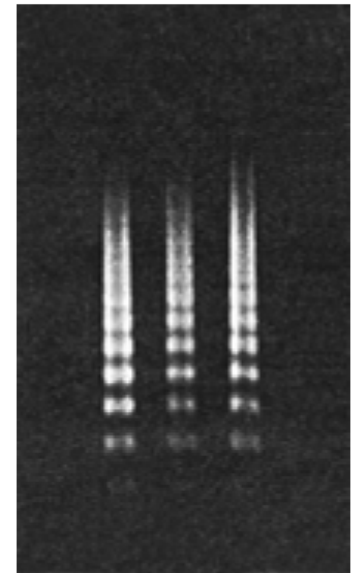
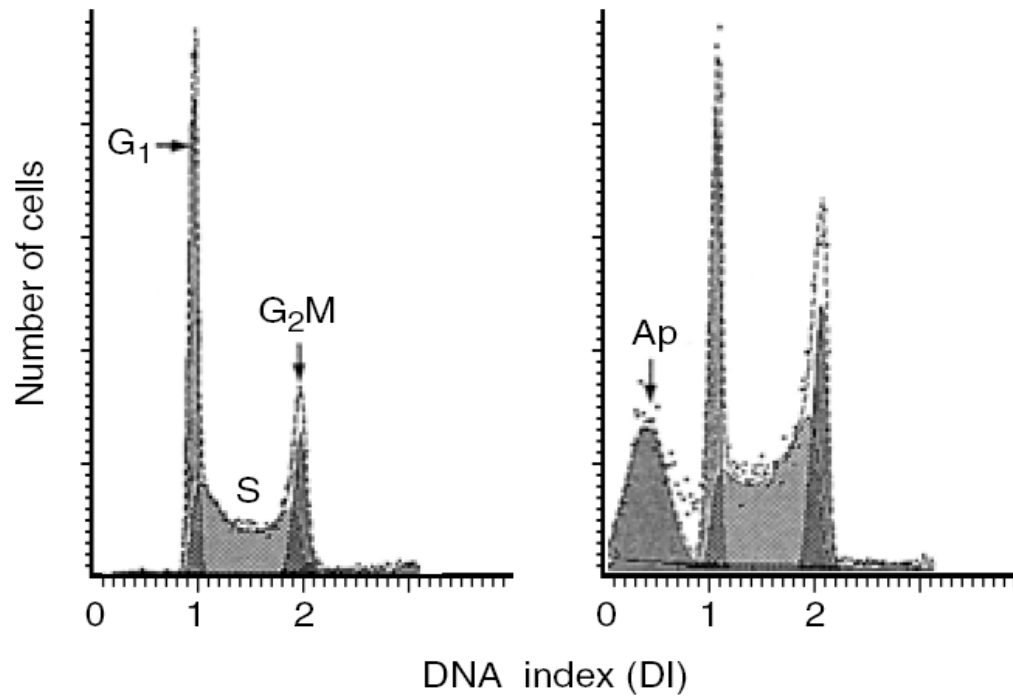

Analysis of subG₀/G₁ population

- extraction of low molecular weight fragments of DNA using citrate buffer

DARZYNKIEWICZ ET AL.

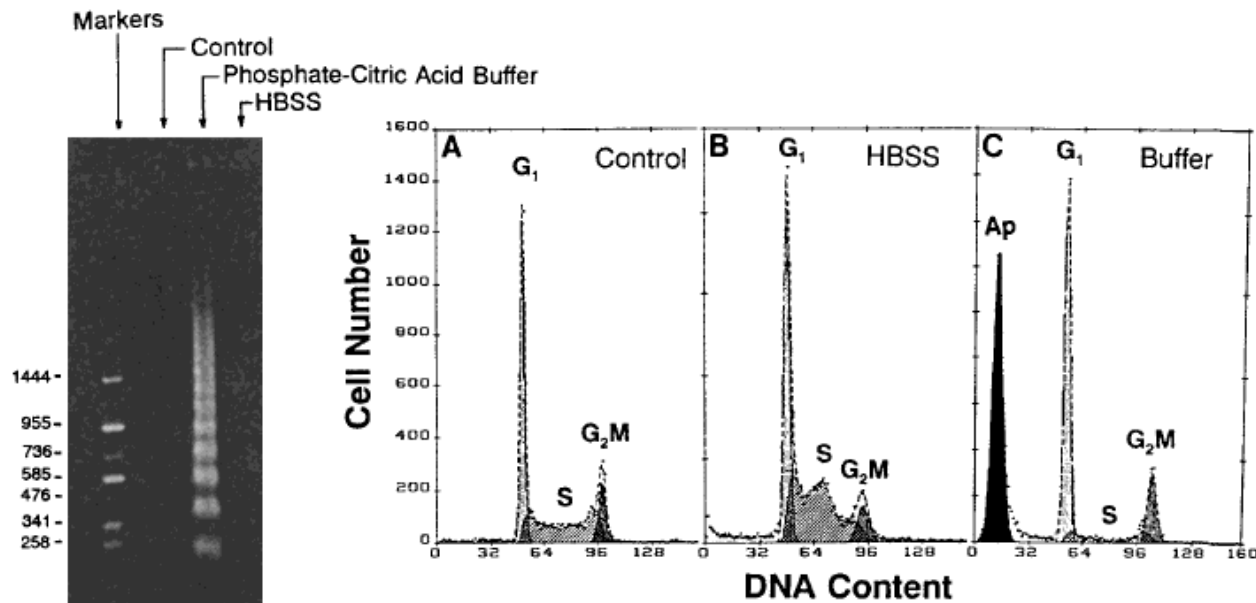

© 1997 Wiley-Liss, Inc.

Cytometry 27:1-20 (1997)

Review Article

Cytometry in Cell Necrobiology: Analysis of Apoptosis and Accidental Cell Death (Necrosis)

Zbigniew Darzynkiewicz,* Gloria Juan, Xin Li, Wojciech Gorczyca, Tomoyuki Murakami, and Frank Traganos

The Cancer Research Institute, New York Medical College, Valhalla, New York

Received 16 May 1996; Accepted 22 July 1996

Analysis of subG₀/G₁ population

■ pros

- Quick and cheap
- Analysis together with cell cycle detection
- Flexible regarding DNA labeling

■ cons

- Limited specificity– size of subG₀ population is overestimated, please **NEVER** use log scale
- Detectable also in mech cells
- Cells dying in G₂ phase

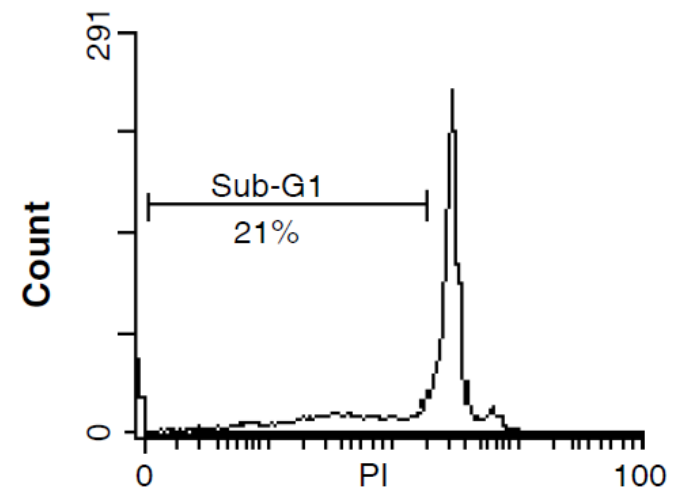

Terminal deoxynucleotidyl transferase-mediated dUTP nick end labeling - **TUNEL**

- DNA breaks detection
- 3'-OH ends of single or double strand breaks are labeled by modified base analogue using deoxynucleotidyl transferase
- vizualization
 - direct (FITC-dUTP)
 - indirect (AP, POD, anti-BrdU Ab)

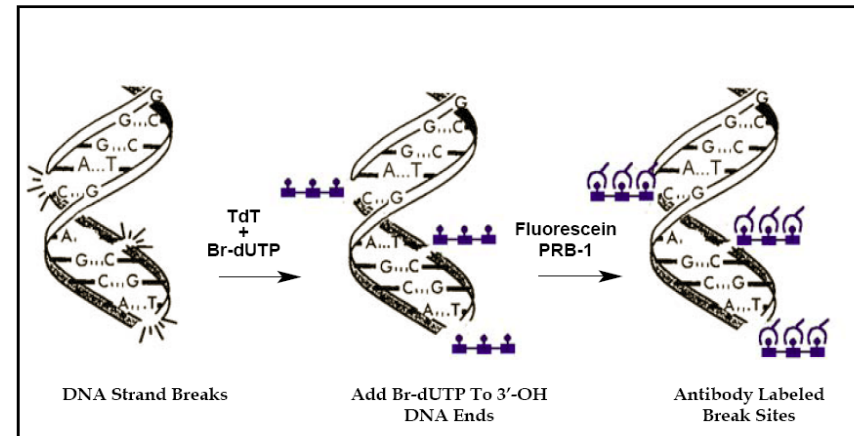

TUNEL

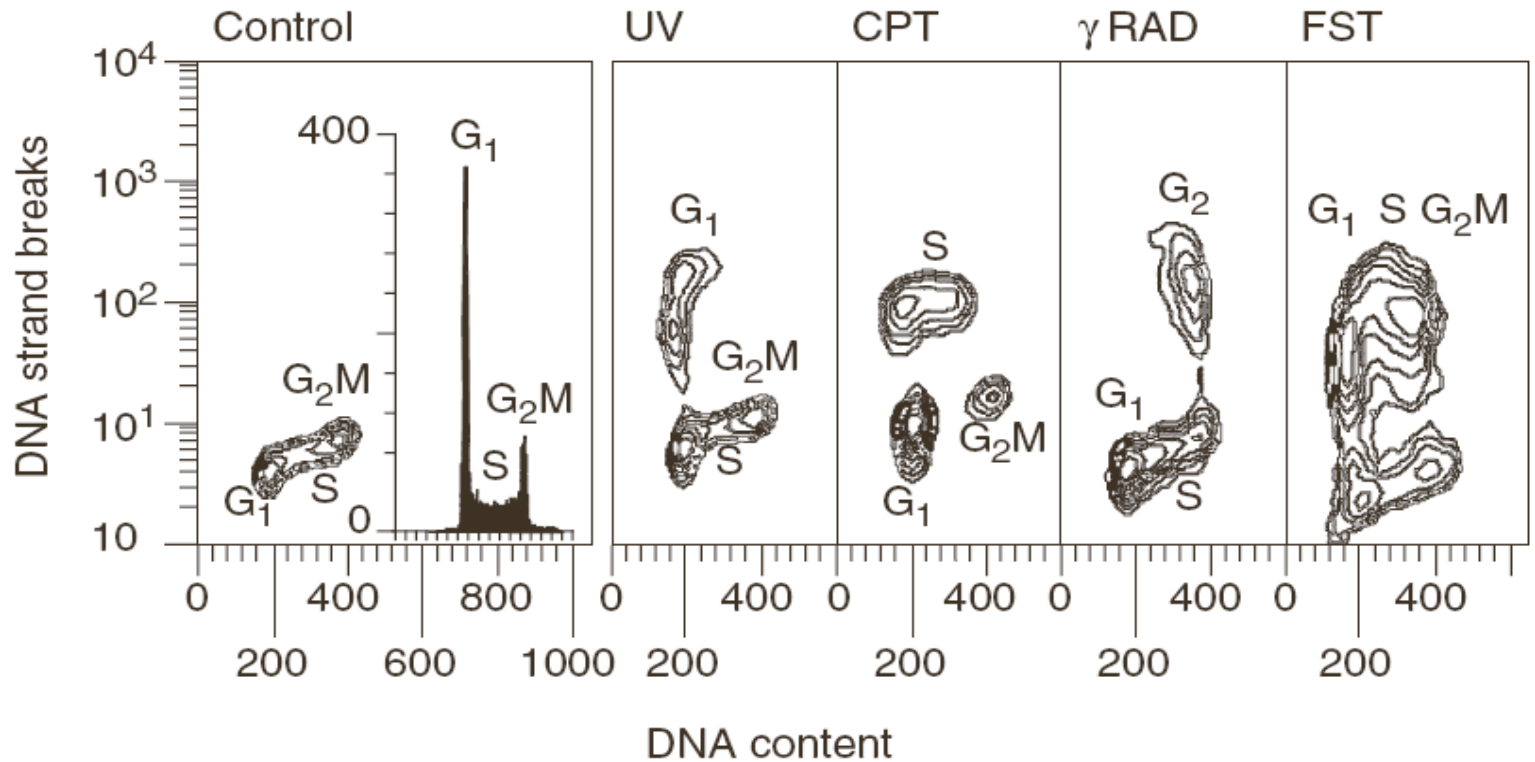

TUNEL

■ pros

- sensitive, specific
- Possible to combine with cell cycle detection

■ cons

- Costly and time consuming
- Large number of cells
- Some fixation procedures generate artifacts

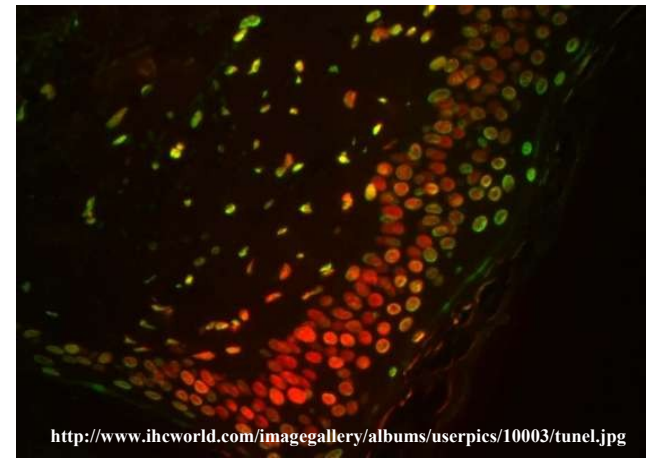



What method we should use?

- always use more than one method;
- recommended to combine methods of different principles;
- consider your experimental model (cell type and design) - „time window“ of each method is different



What else we should consider...?

- each method will give you different numbers (it is reality) - always specify methods you used
- kinetics and turnover of dying cell subpopulation is important
- there is more types of cell death, even in your tissue culture dish
- *in vitro* and *in vivo* situation is really different



Biologické aplikace průtokové cytometrie

■ Cytogenetika

- analýza chromozómů
 - karyotyp
 - sortování
 - chromozómové DNA knihovny
 - FISH značení (chromosome painting)



Analýza a sortování chromozómů

Proc. Natl. Acad. Sci. USA
Vol. 76, No. 3, pp. 1382–1384, March 1979
Genetics

Measurement and purification of human chromosomes by flow cytometry and sorting

(isolated chromosomes/DNA cytophotometry/flow microfluorometer)

A. V. CARRANO, J. W. GRAY, R. G. LANGLOIS, K. J. BURKHART-SCHULTZ, AND M. A. VAN DILLA

Biomedical Sciences Division, L-452, Lawrence Livermore Laboratory, Livermore, California 94550

Communicated by Donald A. Glaser, December 18, 1978

Analýza a sortování chromozómů

- synchronizace buněk – získání metafázních chromozómů (colcemid, hydroxyurea)
 - izolace chromozómů
 - značení DAPI nebo **Hoechst** vs. **chromomycin A3** (CA3) nebo mithramycin
- = celková DNA vs. G/C-bohaté oblasti

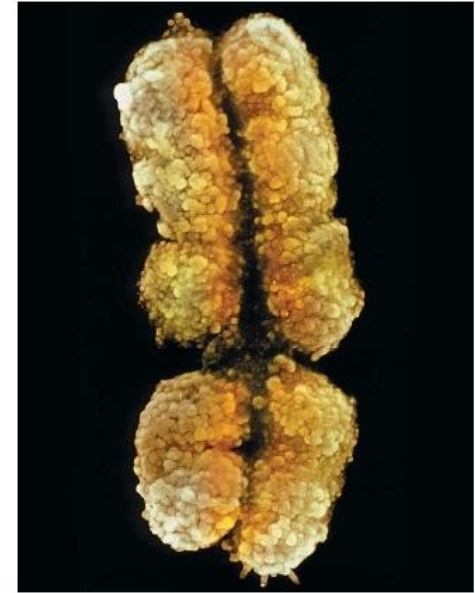

<http://www.scienceclarified.com/Ca-Ch/Chromosome.html>

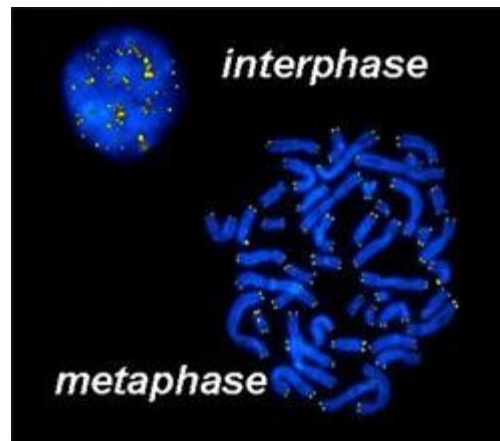

<http://www.nccr-oncology.ch/scripts/page9243.html>

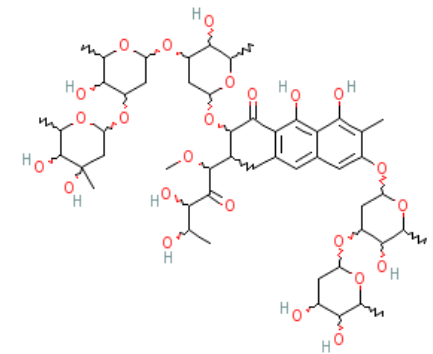

Analýza a sortování chromozómů

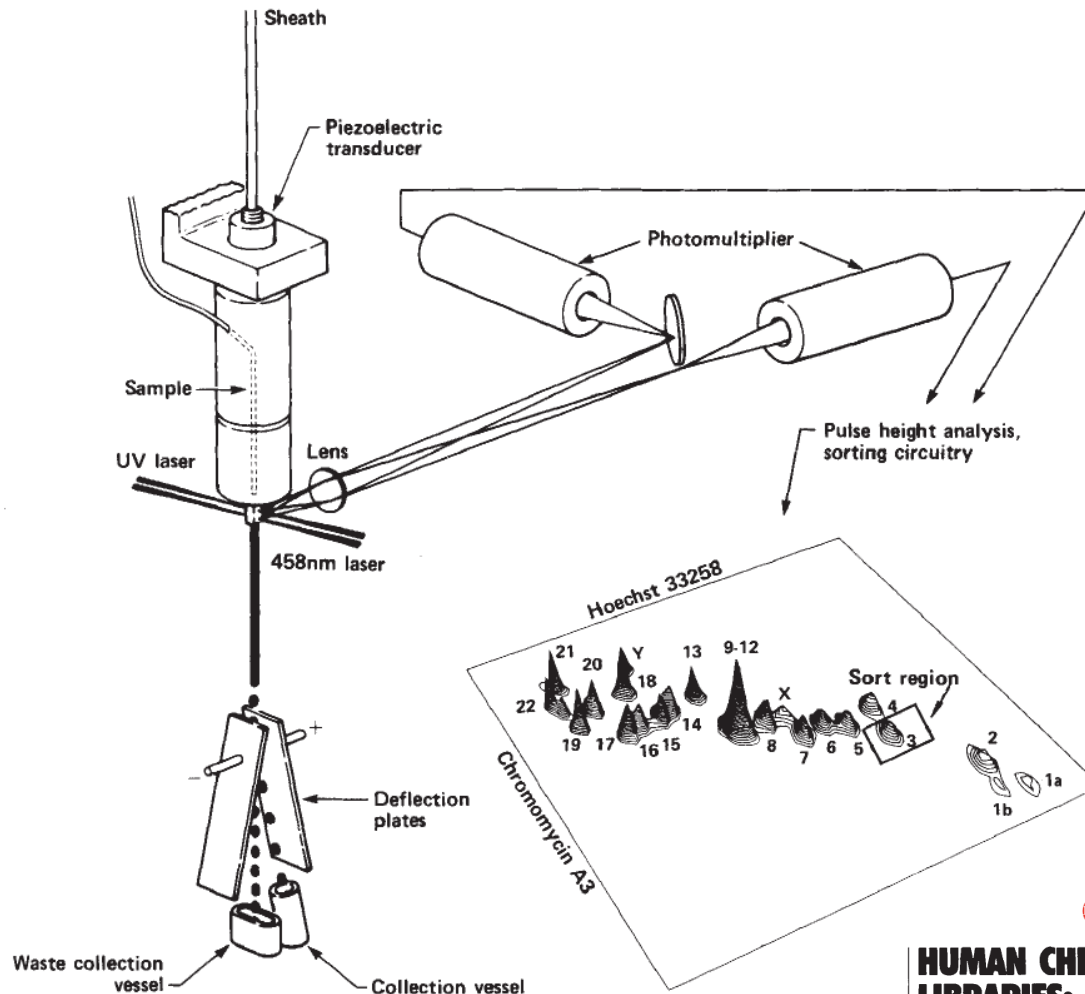

 © 1986 Nature Publishing Group <http://www.nature.com/naturebiotechnology>

HUMAN CHROMOSOME-SPECIFIC DNA LIBRARIES: CONSTRUCTION AND AVAILABILITY

M.A. Van Dilla[□], L.L. Deaven[□], K.L. Albright[†], N.A. Allen^{*}, M.R. Aubuchon^{*}, M.F. Bartholdi[†], N.C. Brown[†], E.W. Campbell[†], A.V. Carrano^{*}, L.M. Clark[†], L.S. Cram[†], B.D. Crawford[†], J.C. Fuscoe^{*}, J.W. Gray^{*}, C.E. Hildebrand[†], P.J. Jackson[†], J.H. Jett[†], J.L. Longmire[†], C.R. Lozes^{*}, M.L. Luedemann[†], J.C. Martin[†], J.S. McNinch^{*}, L.J. Meincke[†], M.L. Mendelsohn^{*}, J. Meyne[†], R.K. Moyzis[†], A.C. Munk[†], J. Perlman^{*}, D.C. Peters^{*}, A.J. Silva^{*}, and B.J. Trask^{*}.

National Laboratory Gene Library Project. ^{*} Lawrence Livermore National Laboratory, Biomedical Sciences Division, University of California, P.O. Box 5507 L-452, Livermore, California 94550. [†] Los Alamos National Laboratory, Life Sciences Division, University of California, Los Alamos, New Mexico 87545. [□] To whom correspondence should be directed.

„Flow karyotype“

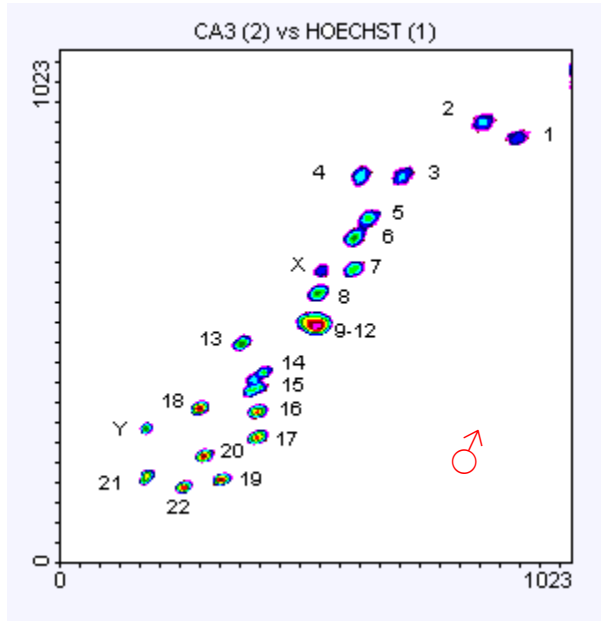

<http://www.sanger.ac.uk/HGP/Cytogenetics/>

The Preparation of Human Chromosomes for Flow Cytometry

DEREK DAVIES

FACS Laboratory, Imperial Cancer Research Fund, 44 Lincoln's Inn Fields, London WC2A 3PX

Vol. 33/2 Proceedings RMS June 1998

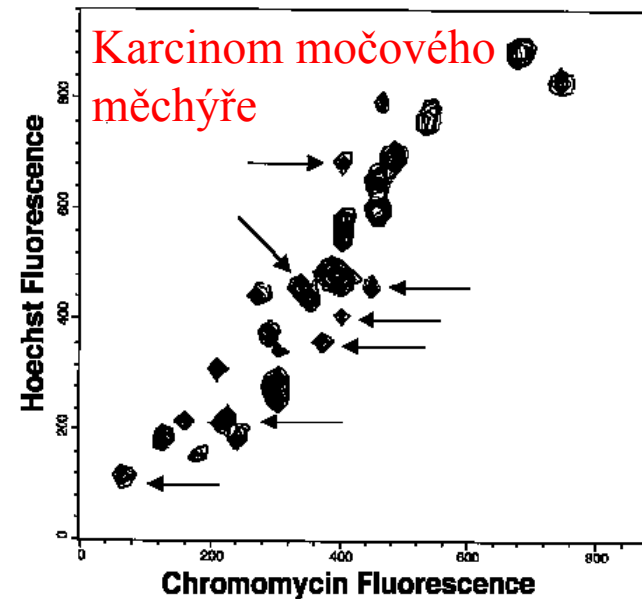
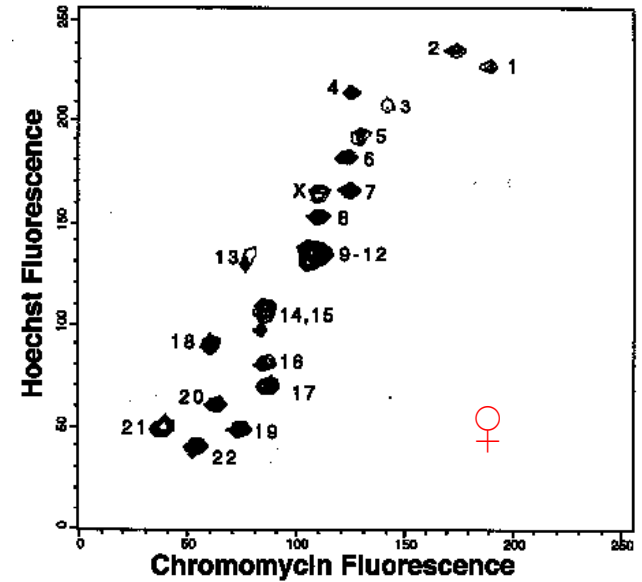

Sortování chromozómů

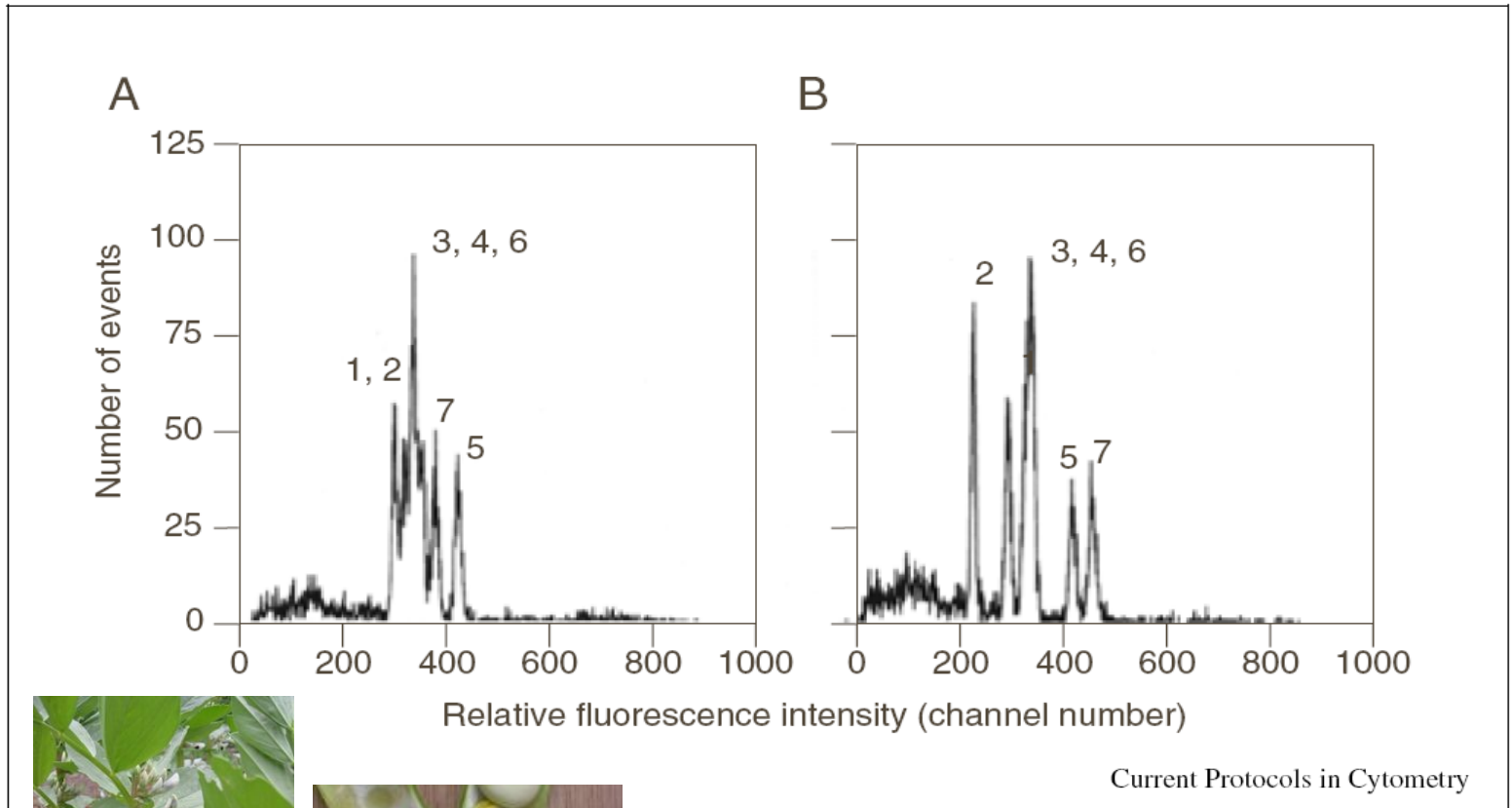

Pisum sativum

Sortování chromozómů

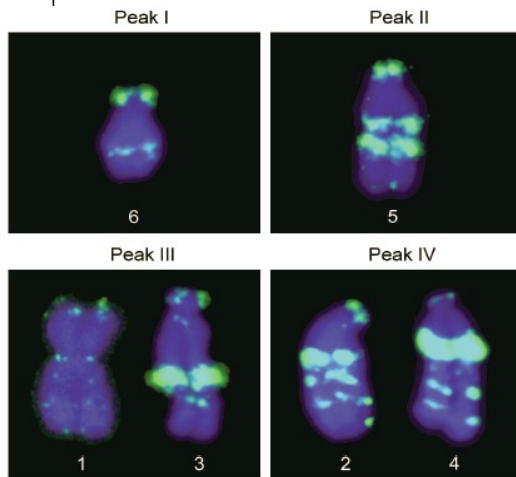
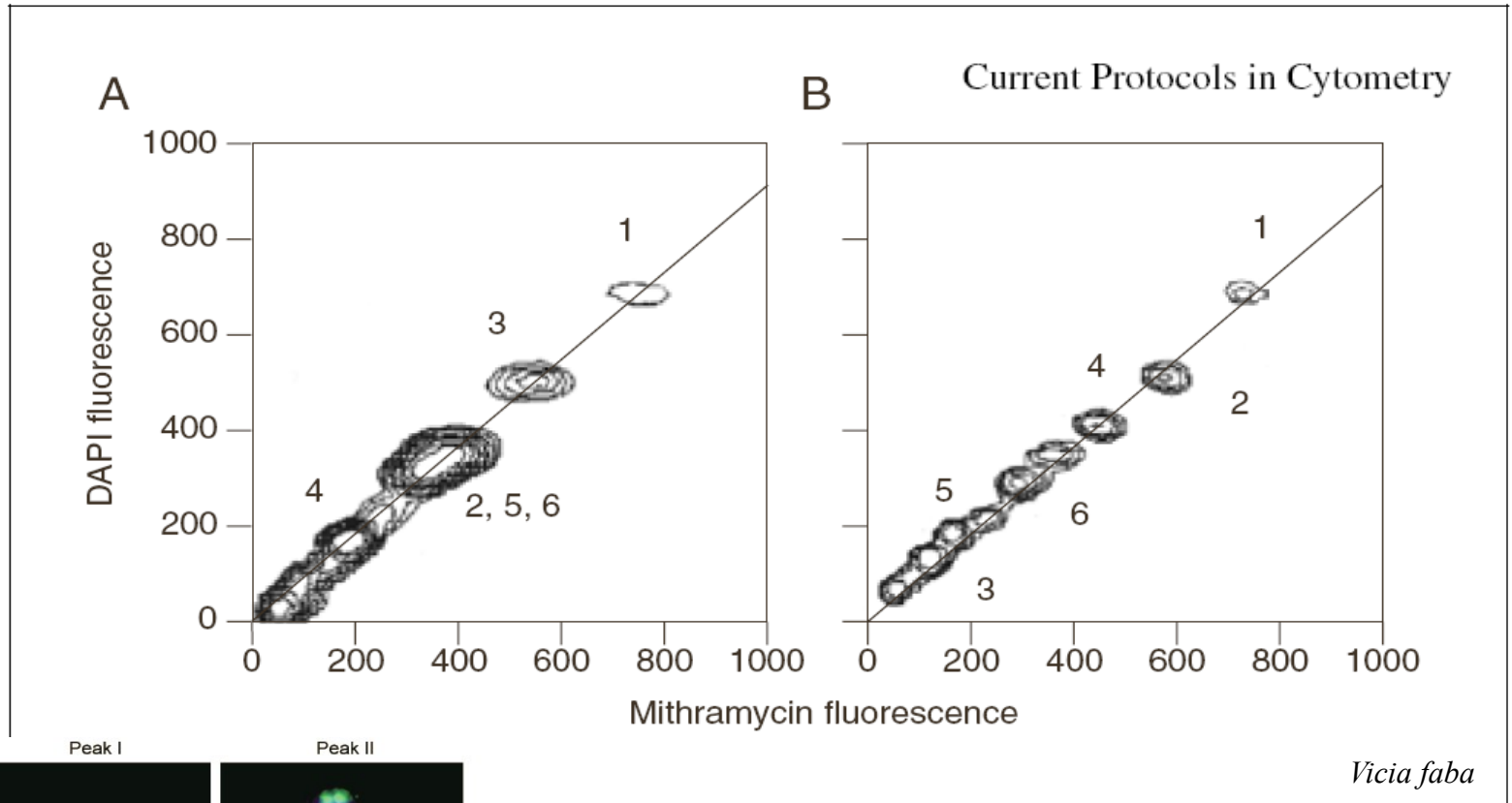

BIOLOGIA PLANTARUM 51 (1): 43-48, 2007

Chromosome analysis and sorting in *Vicia sativa* using flow cytometry

P. KOVÁŘOVÁ¹, A. NAVRÁTILOVÁ², J. MACAS² and J. DOLEŽEL^{1,3*}





Aplikace průtokové cytometrie v mikrobiologii

- ekologie
- potravinářství
- bioterorismus

<http://www.cyto.purdue.edu/flowcyt/research/micrflow/>

Aplikace průtokové cytometrie v mikrobiologii

Relative Size Ratios for Bacteria, Yeast, and Eukaryotes

Measurement	Bacteria	Yeast	Eukaryote
Diameter	0.5-5	3-5	10-30
Surface area	3-12	30-75	300-3000
Volume	0.3-3	20-125	500-1500
Dry cell mass	1	10	300-3000

Current Protocols in Cytometry



Aplikace průtokové cytometrie v mikrobiologii

- viabilita
- metabolické funkce
- sortování

Aplikace průtokové cytometrie v mikrobiologii

- Sortování
 - EPICS + Autoclone® modul

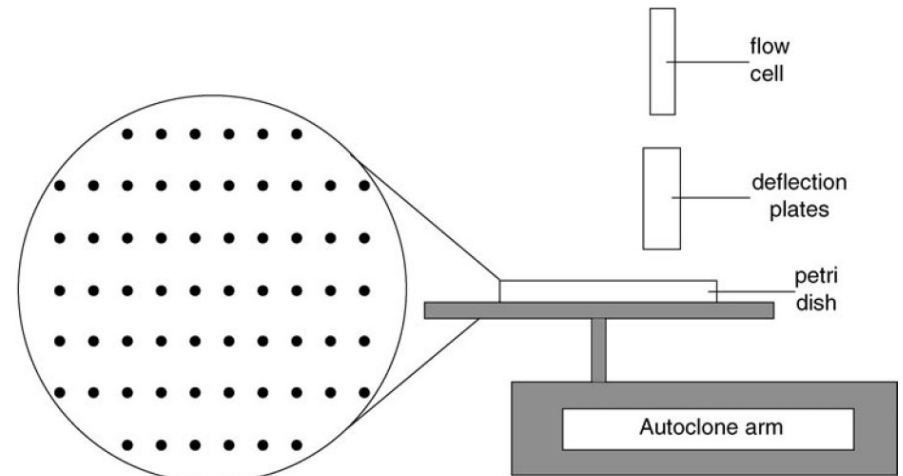

top view of petri dish showing sort grid

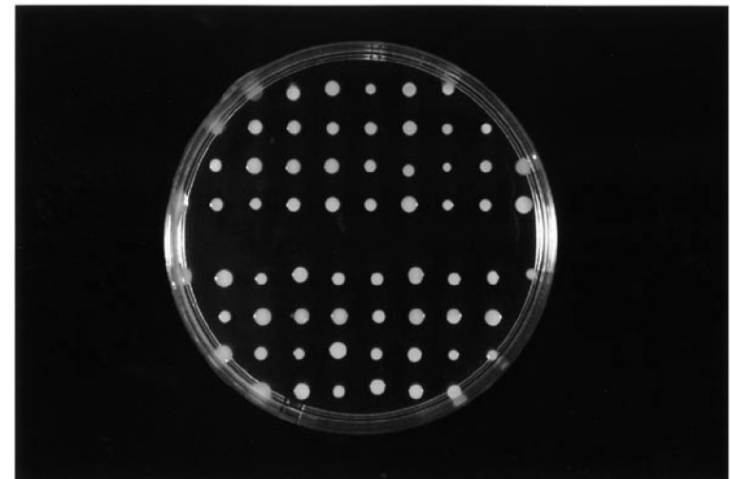

Průtoková cytometrie kvasinek

- buněčné dělení
- viabilita
- membránový potenciál
- respirace
- produkce H_2O_2
- citlivost k antibiotikům
- separace

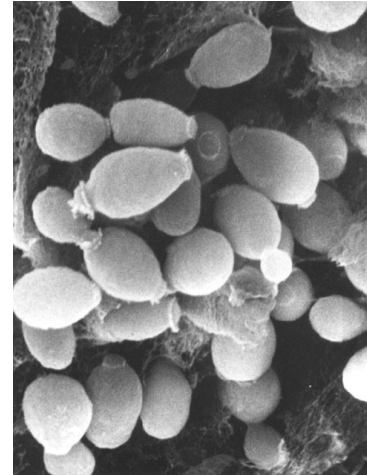

http://www.sbs.utexas.edu/mycology/sza_images_SEM.htm

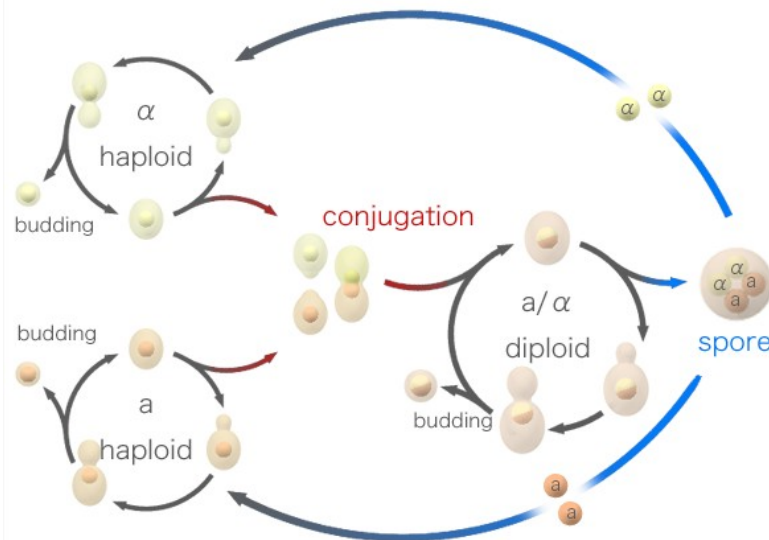

http://en.wikipedia.org/wiki/Image:Budding_yeast_Lifecycle.png

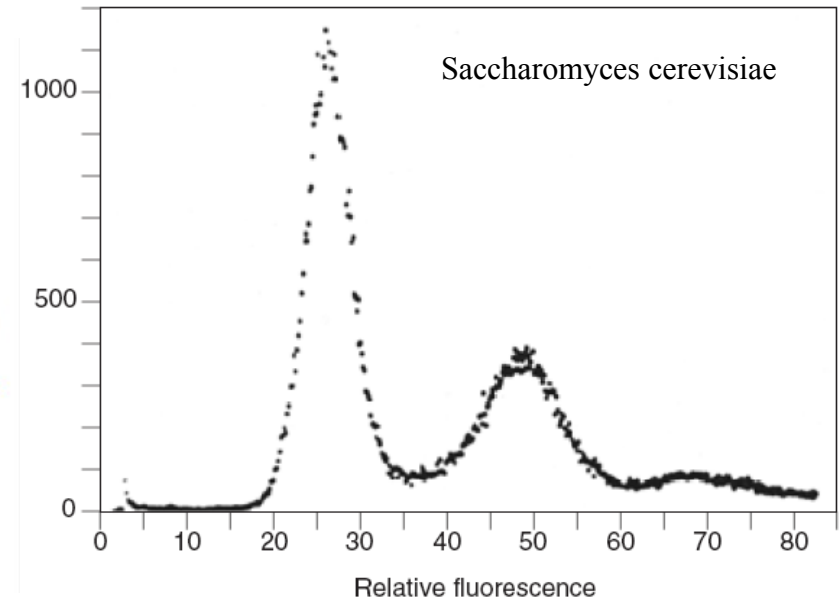

Průtoková cytometrie kvasinek

Yeast Cell Cycle During Fermentation and Beer Quality

Masahito Muro,¹ Kenichiro Izumi, Takeo Imai, Yutaka Ogawa, and Motoo Ohkochi, *Research Laboratories for Brewing, Kirin Brewery Co., Ltd., 1-17-1, Namamugi, Tsurumi-ku, Yokohama, 230-8628 Japan*

J. Am. Soc. Brew. Chem. 64(3):151-154, 2006



Průtoková cytometrie v hydrobiologii

- studium pico- a nanofytoplanktonu ($< 20 \mu\text{M}$)
- analýza metabolických funkcí planktonu
- studium pigmentace (analýza chlorofylu a fykoeritrinu)





Průtoková cytometrie v hydrobiologii

© 2001 Wiley-Liss, Inc.

Cytometry 44:236–246 (2001)

Monitoring Phytoplankton, Bacterioplankton, and Virioplankton in a Coastal Inlet (Bedford Basin) by Flow Cytometry

W.K.W. Li* and P.M. Dickie

Biological Oceanography Section, Bedford Institute of Oceanography, Dartmouth, Nova Scotia, Canada

Received 4 October 2000; Revision Received 2 May 2001; Accepted 2 May 2001

© 1989 Alan R. Liss, Inc.

Cytometry 10:659–669 (1989)

Using Phytoplankton and Flow Cytometry to Analyze Grazing by Marine Organisms

Terry L. Cucci, Sandra E. Shumway, Wendy S. Brown, and Carter R. Newell

Department of Marine Resources (S.E.S.) and Bigelow Laboratory for Ocean Sciences (T.L.C., S.E.S.), West Boothbay Harbor, Maine 04575; Chemistry Department, Bowdoin College (W.S.B.), Brunswick, Maine 04011; Great Eastern Mussel Farms (C.R.N.), Tenants Harbor, Maine 04857

Received for publication November 2, 1988; accepted April 17, 1989

Průtoková cytometrie v hydrobiologii

■ analýza DNA

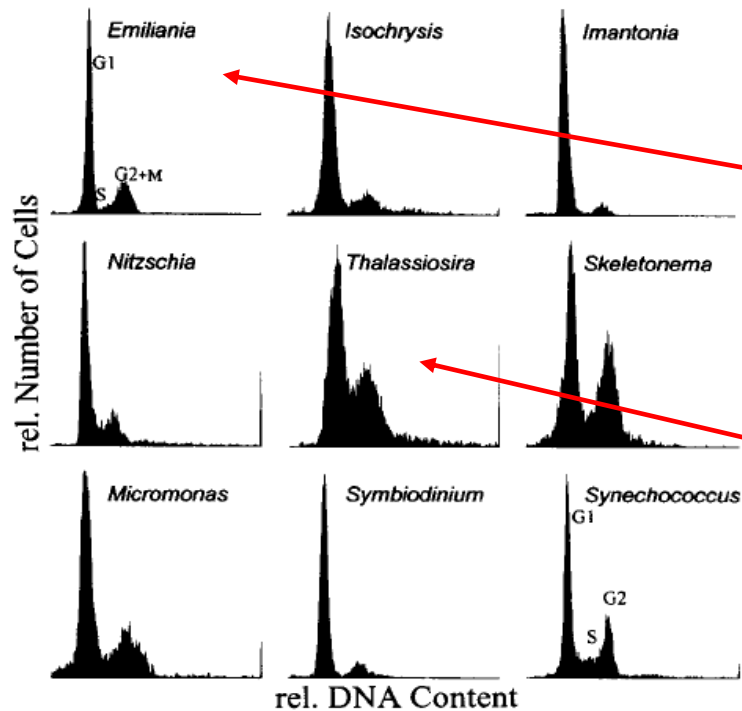

Vol. 185: 301–307, 1999	MARINE ECOLOGY PROGRESS SERIES Mar Ecol Prog Ser	Published August 20
-------------------------	---	---------------------

NOTE

Cytometric measurement of the DNA cell cycle in the presence of chlorophyll autofluorescence in marine eukaryotic phytoplankton by the blue-light excited dye YOYO-1

Frank J. Jochem^{1,*}, Doris Meyerdierks²

¹Institut für Meereskunde, Düsterbrookweg 20, D-24105 Kiel, Germany

²Universität Bremen, FB II Meeresbotanik, Postfach 330440, D-28334 Bremen, Germany

<http://www.soes.soton.ac.uk/staff/tt/>

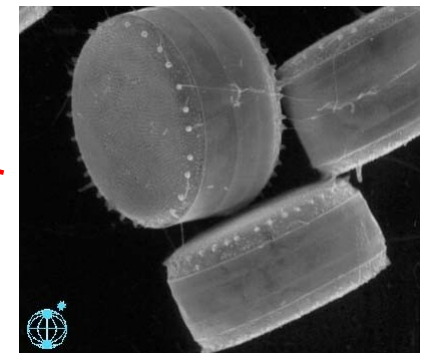
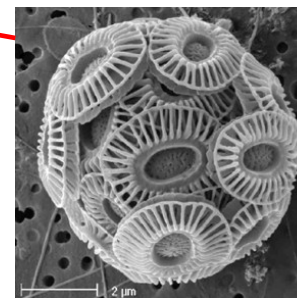

Průtoková cytometrie v hydrobiologii

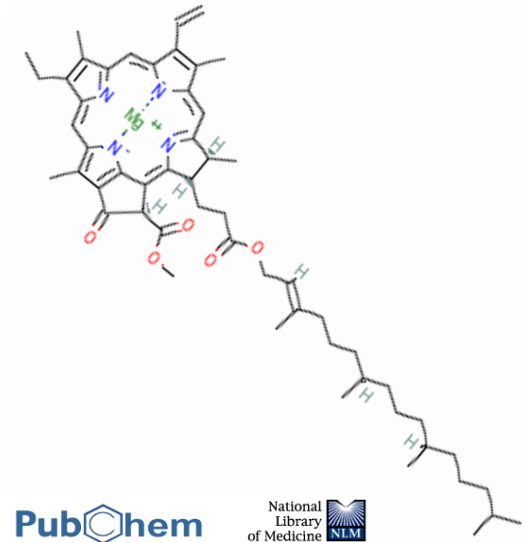
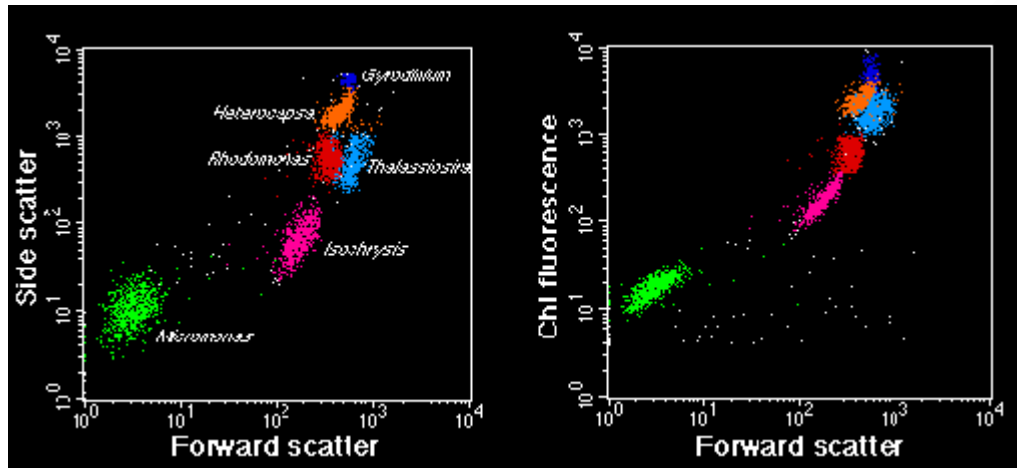

PubChem

National Library of Medicine NLM

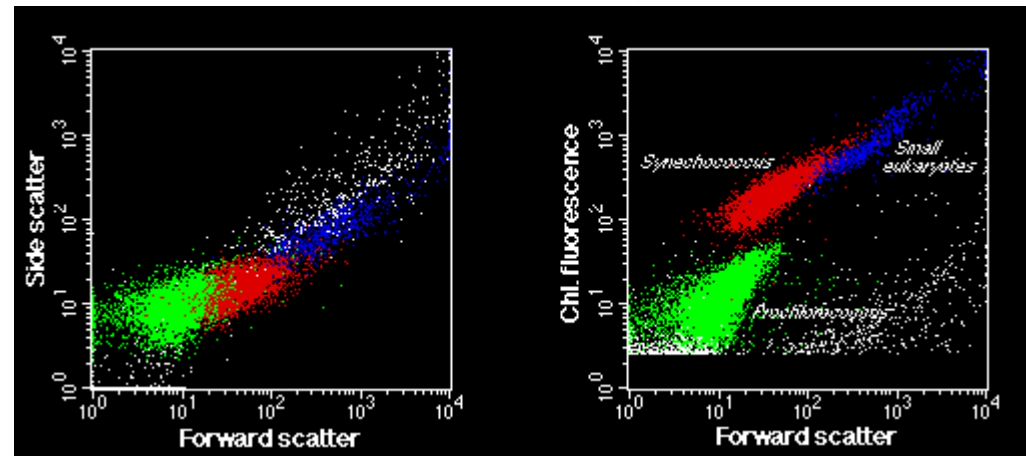
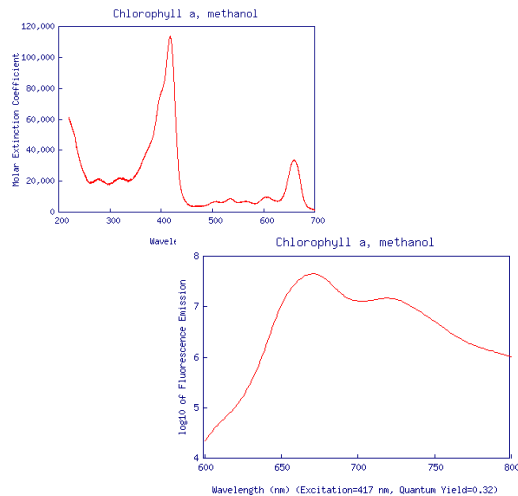

Průtoková cytometrie bezobratlých



- lze aplikovat běžné metodické přístupy a fluorescenční značky
- Příklady aplikací:
 - buněčný cyklus
 - cytotoxicita
 - apoptóza





Trendy: instrumentace

Spectral flow cytometry

SONY Sony Biotechnology Inc.   US

Products ▾ Resources ▾ Support ▾ About Us ▾ Contact Us ▾ Order Info ▾ Site Q

Overview Features Applications Specifications Literature

See Everything

The SP6800 Spectral Analyzer is Sony Biotechnology Inc.'s newest innovative life science system fundamentally expanding the way cell and biomarker analysis can be performed. This system incorporates a unique optical bench, Blu-ray™ disc technology, and advanced algorithms to deliver some of the most accurate and precise data available.

The SP6800 Spectral Analyzer also introduces new Flow Point technology to analyze core stream and sample event location within the flow cell. To improve accuracy of data, this system also provides unique functions to display and analyze cellular autofluorescence and allows the user to easily automatically remove.

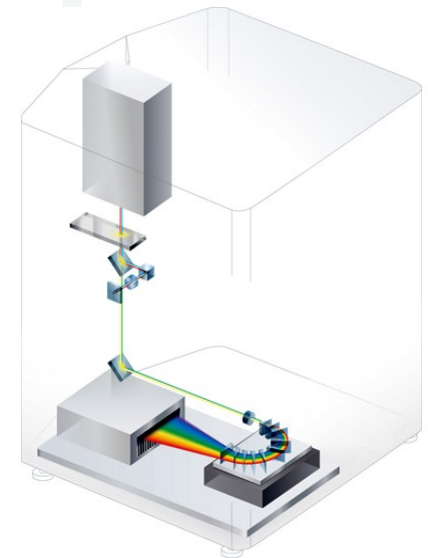
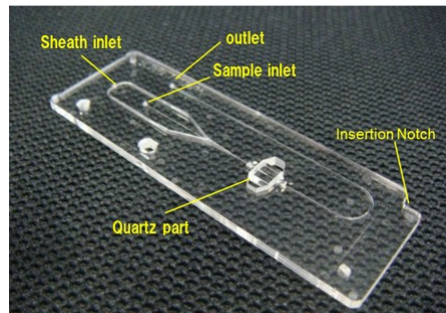

Conventional vs. spectral analysis

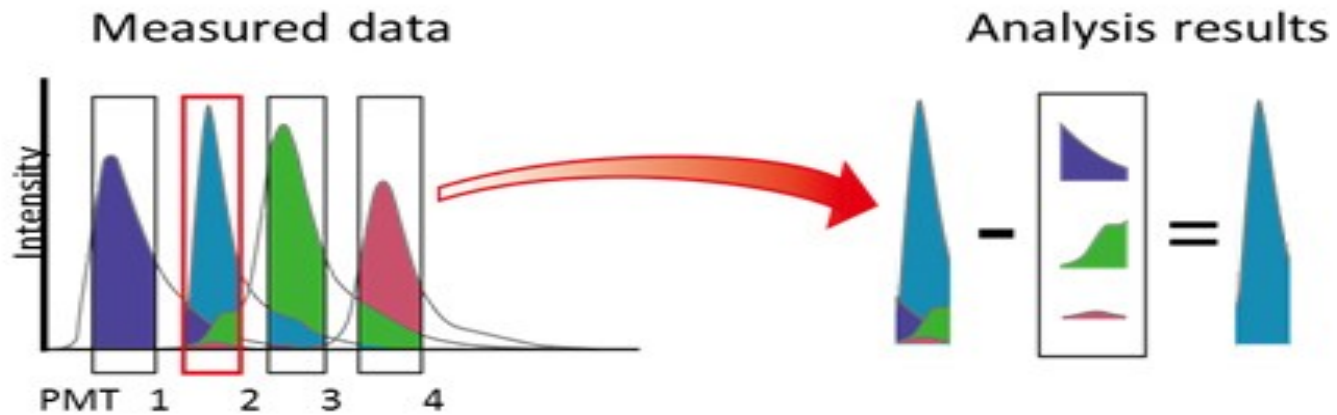

Why Mass Cytometry?

- Highly multi-parametric, on a single cell basis
- Facilitates exploration of complex pathways
- Enables discovery of cellular relationships, responses, and developmental pathways
- Allows deep-profiling of your cell system of interest

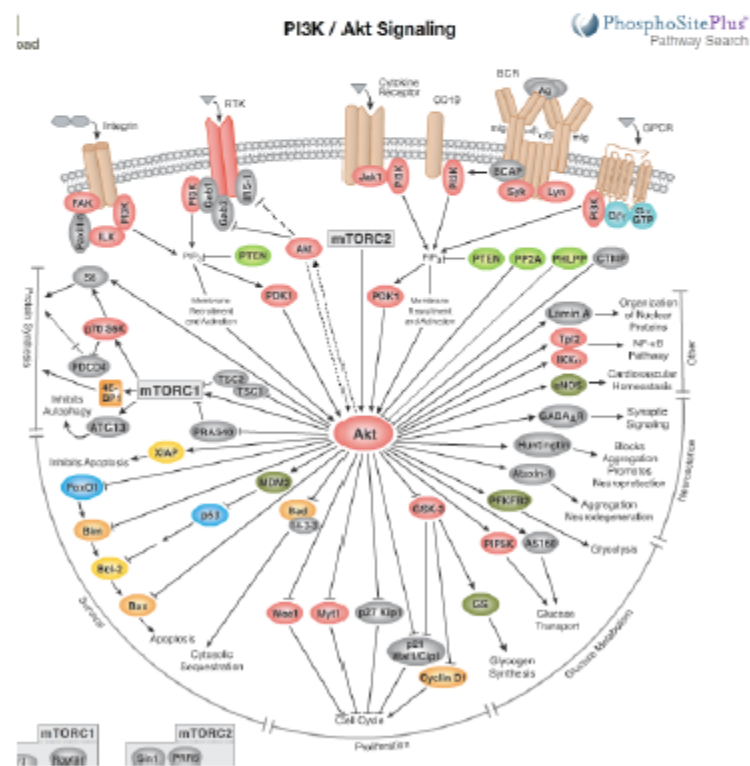
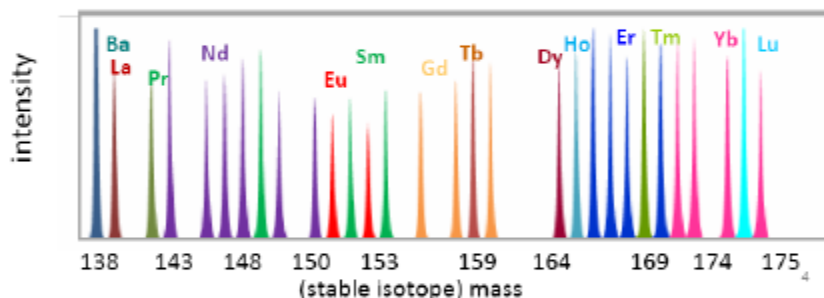

Single Cell Mass Cytometry

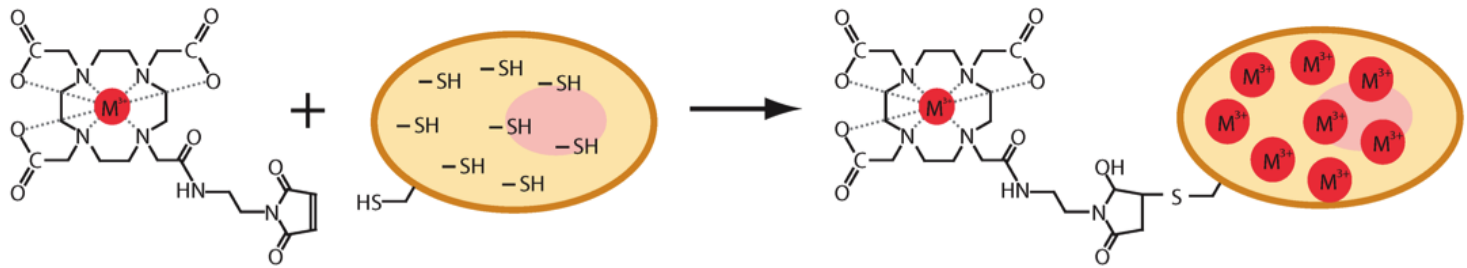

Cells were covalently labeled with a bifunctional compound, maleimido-mono-amide-DOTA (mDOTA). This compound can be loaded with a lanthanide(III) isotope ion, and reacts covalently with cellular thiol groups through the maleimide moiety.

Single-Cell Mass Cytometry of Differential Immune and Drug Responses Across a Human Hematopoietic Continuum

Sean C. Bendall, *et al.*

Science **332**, 687 (2011);

Single Cell Mass Cytometry

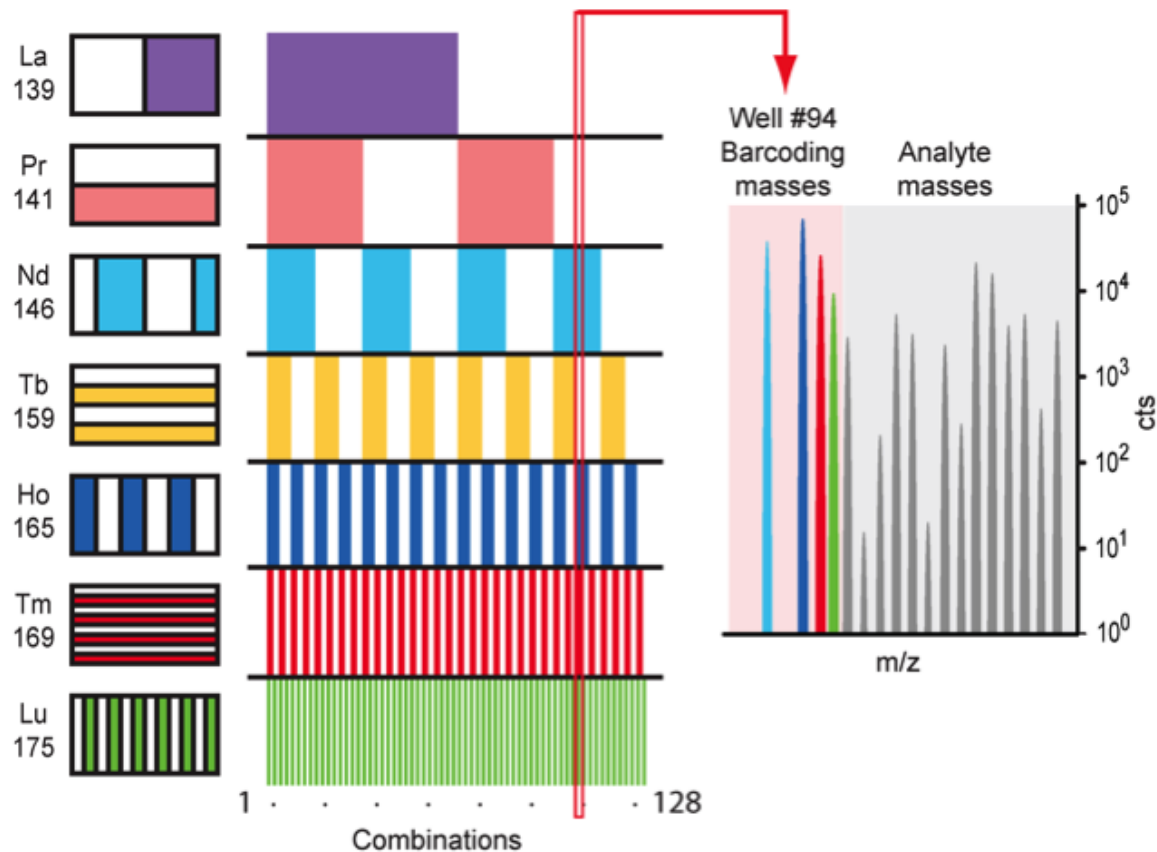

Seven unique lanthanide isotopes were used to generate 128 combinations, enough to barcode each sample in a 96-well plate. The seven lanthanide isotopes, their masses and their locations on the 96-well plate are shown.

Single-Cell Mass Cytometry of Differential Immune and Drug Responses Across a Human Hematopoietic Continuum

Sean C. Bendall, *et al.*
Science **332**, 687 (2011);

Personální systémy



Cytonome Viva™ G1 Desktop System

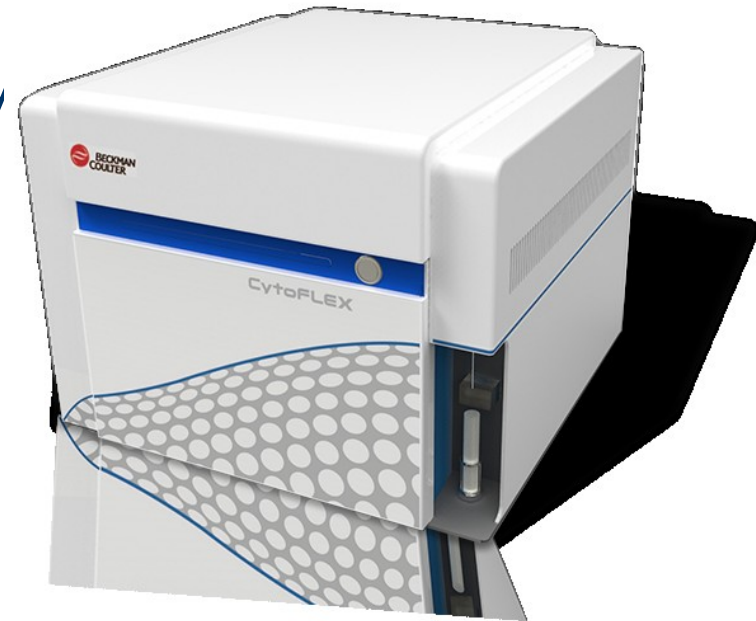



Trendy: Reagencie

PrimeFlow™ RNA Assay

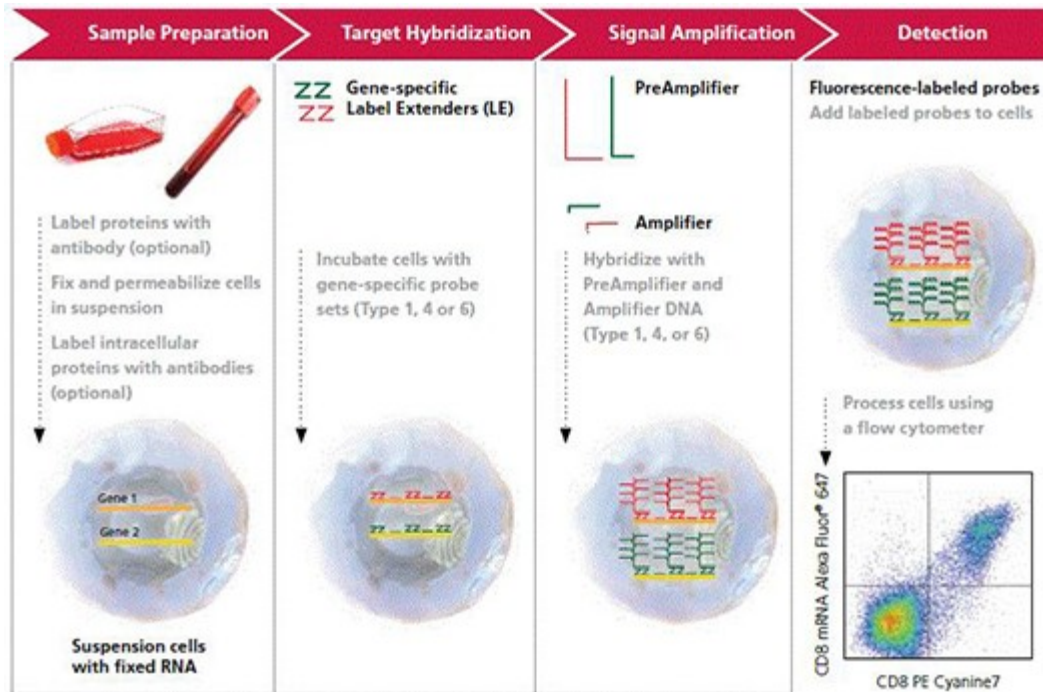

Brilliant Violet polymers

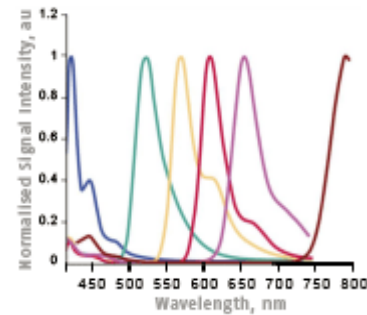



Shrnutí přednášky

průtoková cytometrie:

- nabízí široké spektrum aplikací;
- rychlý způsob analýzy a separace heterogenních populací;
- separace populací;
- multiparametrové analýzy