

CD spektroskopie a konformační vlastnosti DNA



Michaela Vorlíčková
Institute of Biophysics

Academy of Sciences of the Czech Republic, v.v.i. **Brno**

Laboratory of CD spectroscopy of nucleic acids



Hairpin



Coiled - coil

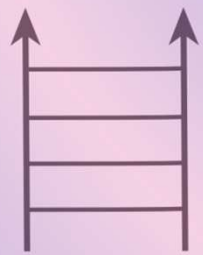

Parallel Homoduplex



B - form



A - form

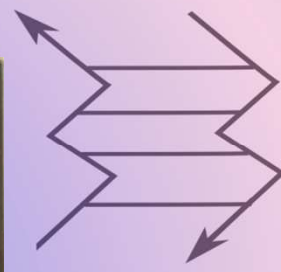
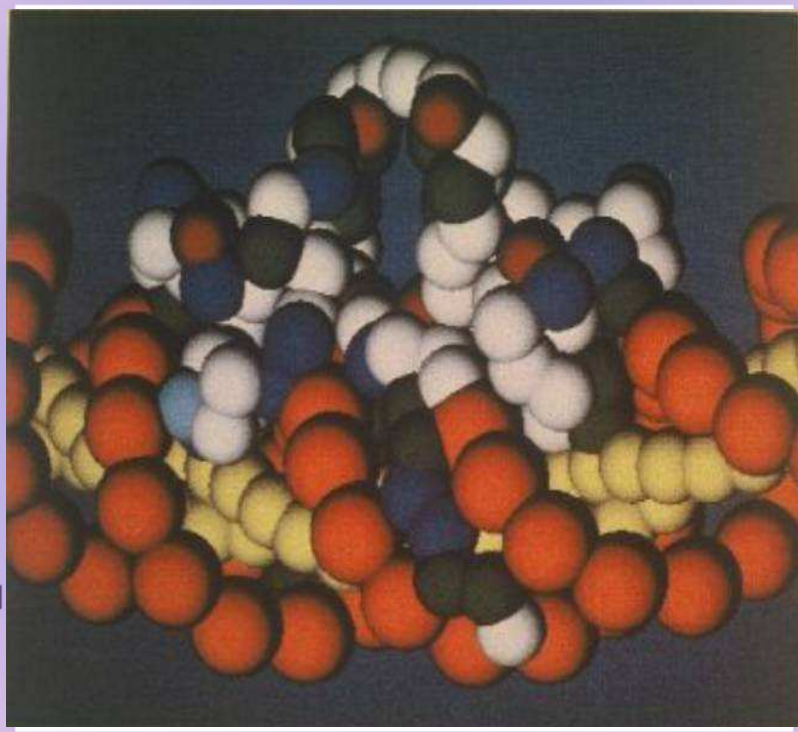

Z - form

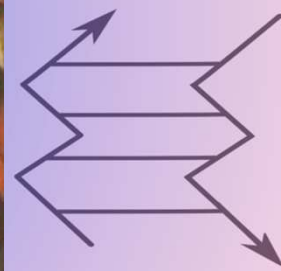

X - form

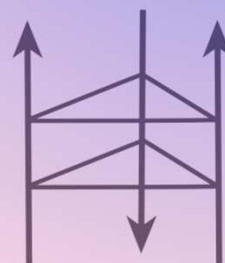

Triplex

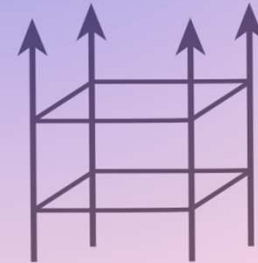

G - tetraplex

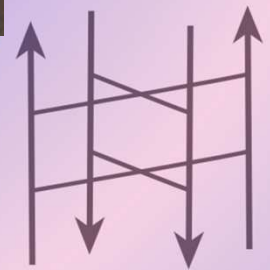

C - tetraplex

- Principles of circular dichroic (CD) spectroscopy
- Advantages and drawbacks of the use of CD spectroscopy to proteins and nucleic acids studies
- Characteristic CD spectra of particular nucleic acids types
- Structural properties of nucleic acids - fresh findings

Cirkulární dichroismus a optická aktivita biopolymerů

) optická aktivita – chirální látky (aminokyseliny, cukry) úhel stočení roviny polarizovaného světla, ORD

) CD – princip, veličiny, elipticita, ΔA , $\Delta \epsilon$, vztah mezi ORD a CD

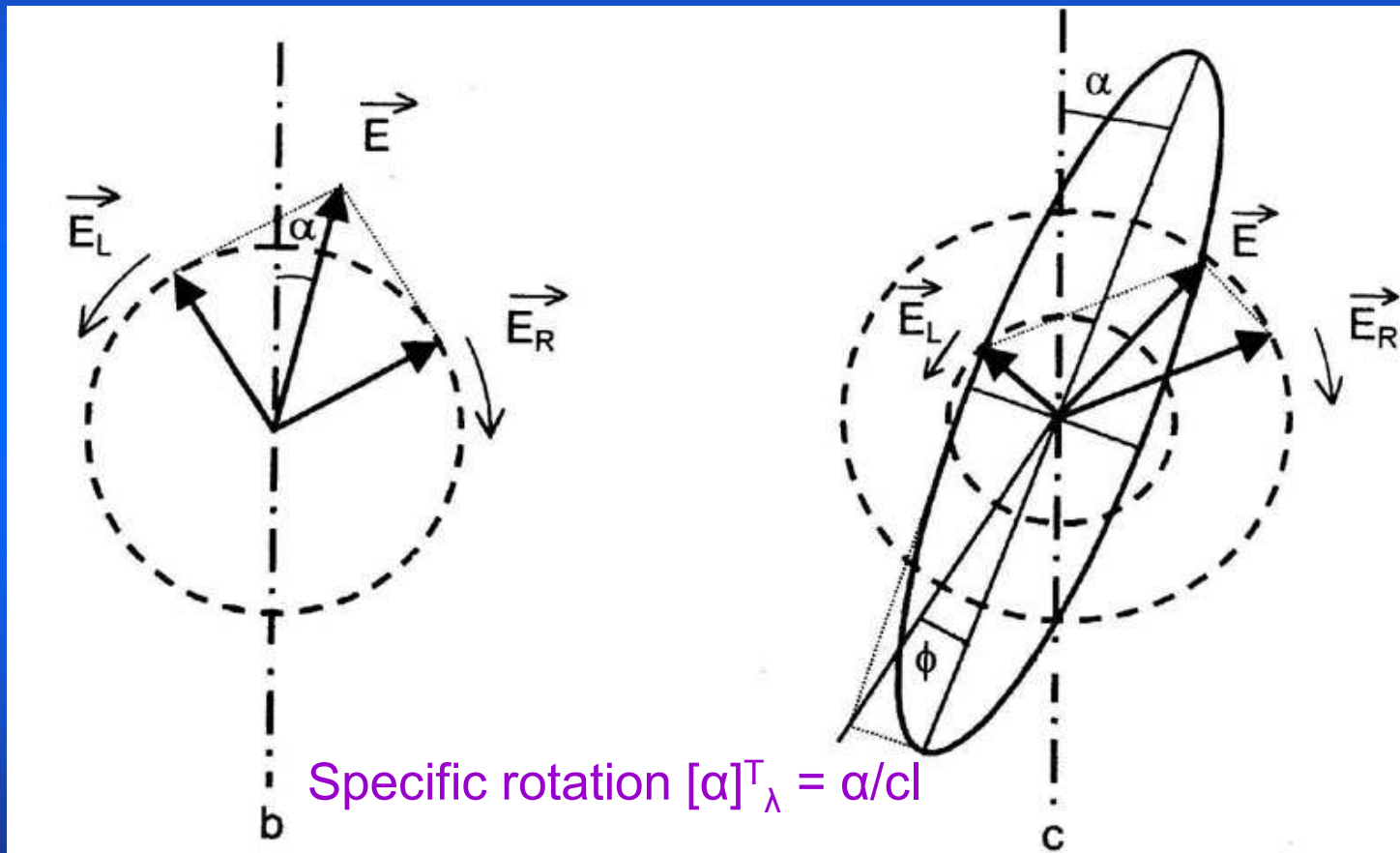

Elipticita

φ [ψ]

$$\operatorname{tg} \varphi = b/a = \frac{\epsilon_L - \epsilon_R}{\epsilon_L + \epsilon_R}$$

Cirkulární dichroismus $\Delta \epsilon$

$$\Delta \epsilon = \epsilon_L - \epsilon_R = \Delta A / l c, \quad \theta = 3300 \cdot \Delta \epsilon$$

Cotton'ün efekt

$[\alpha]$

λ [nm]

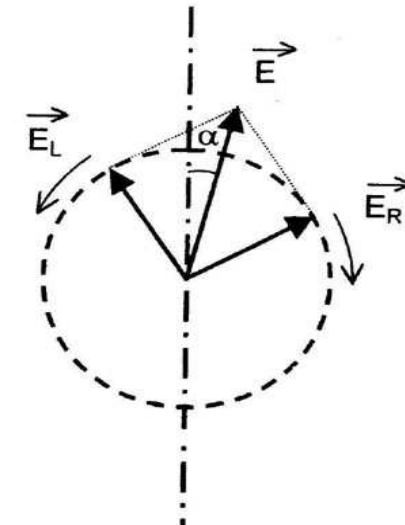
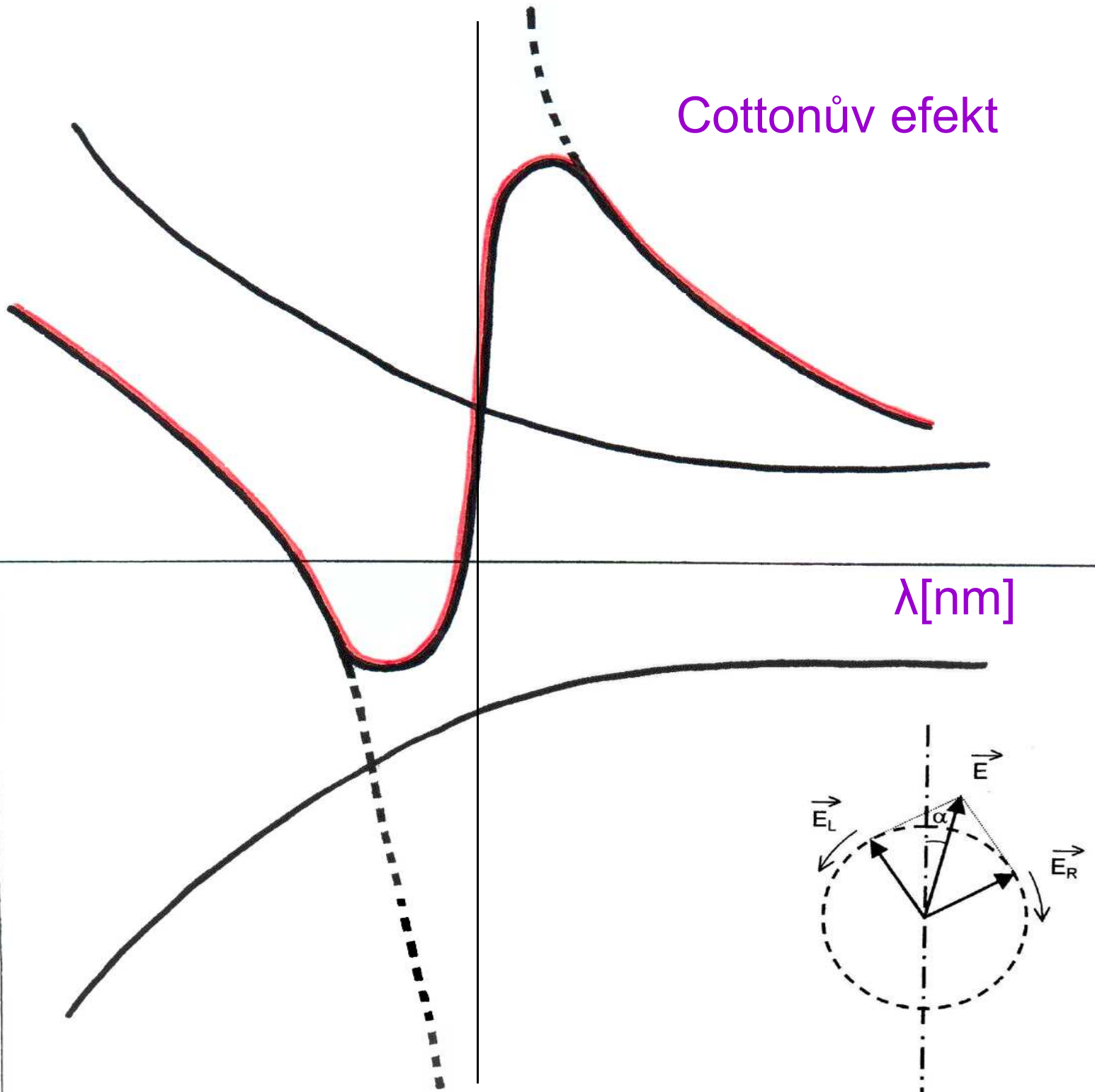

Cottonův efekt

λ [nm]

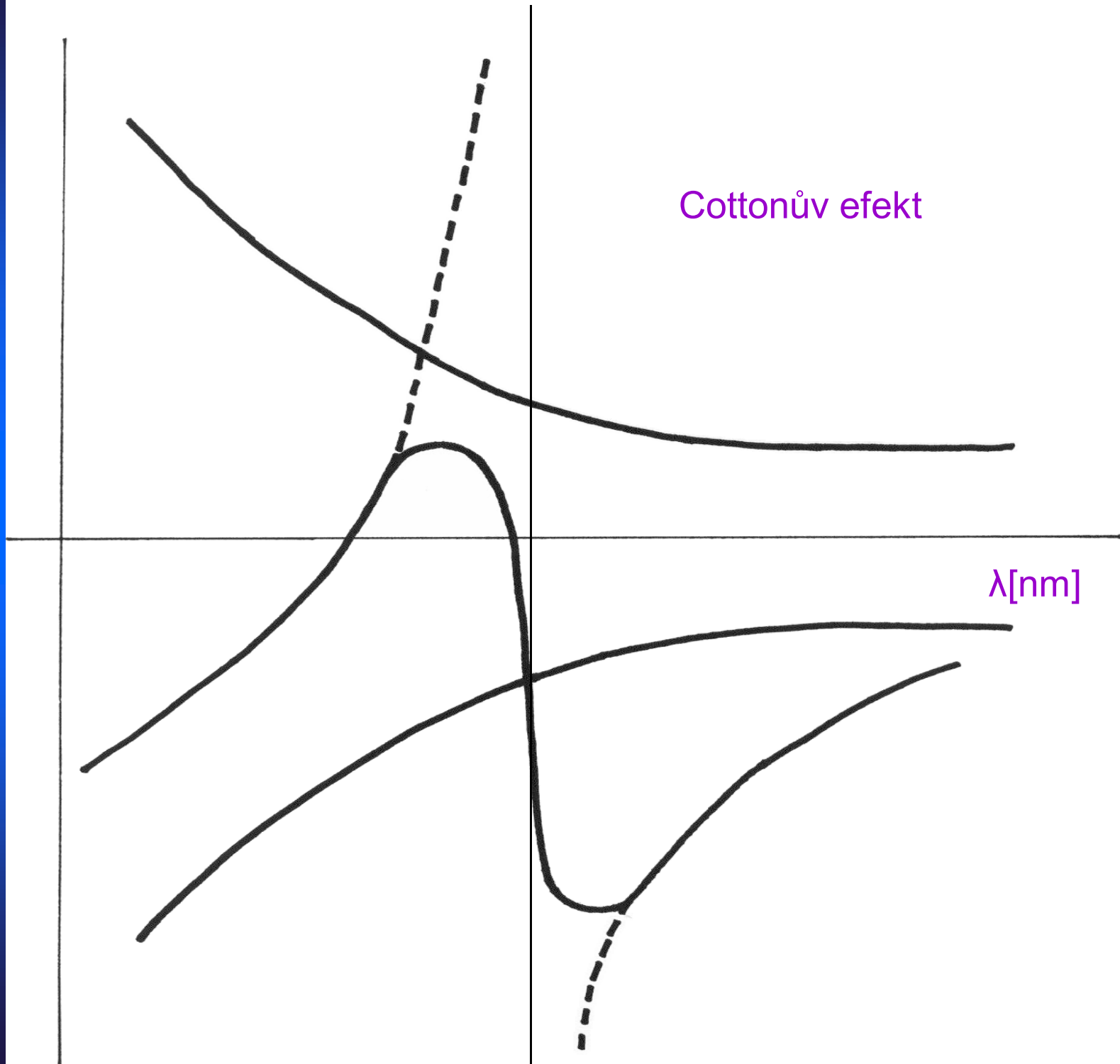

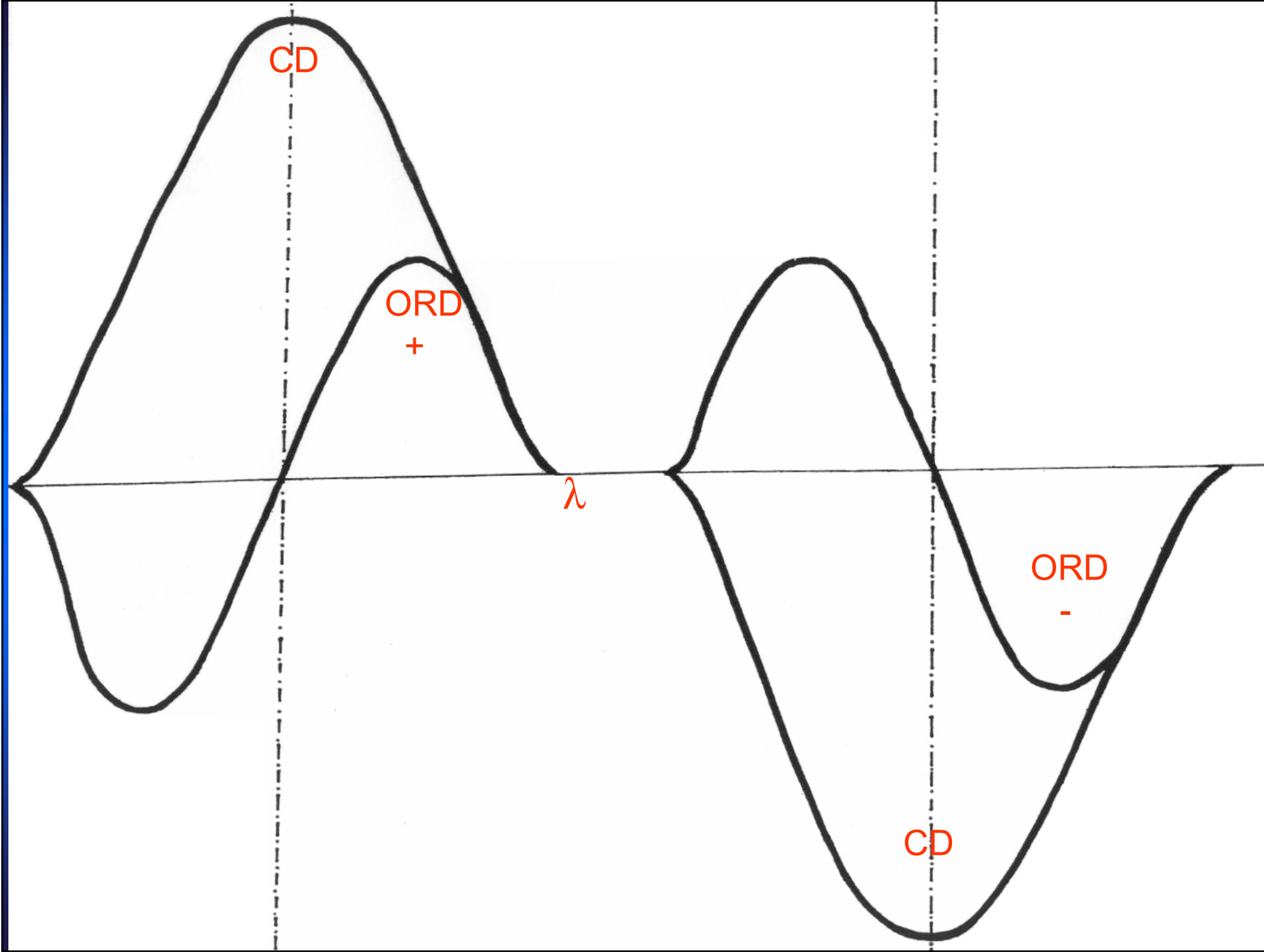

CD of proteins

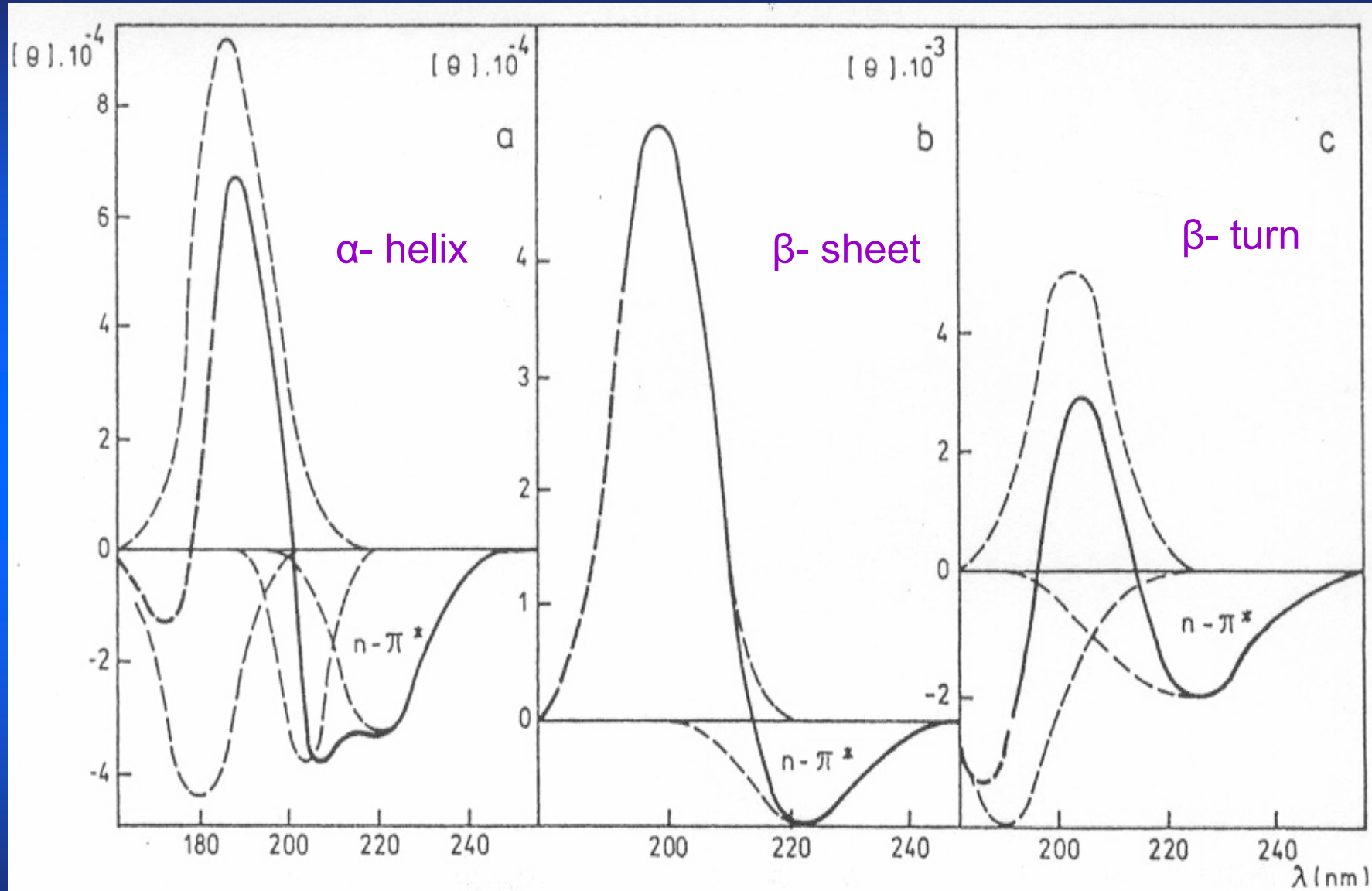

Podmínky vzniku CD DNA



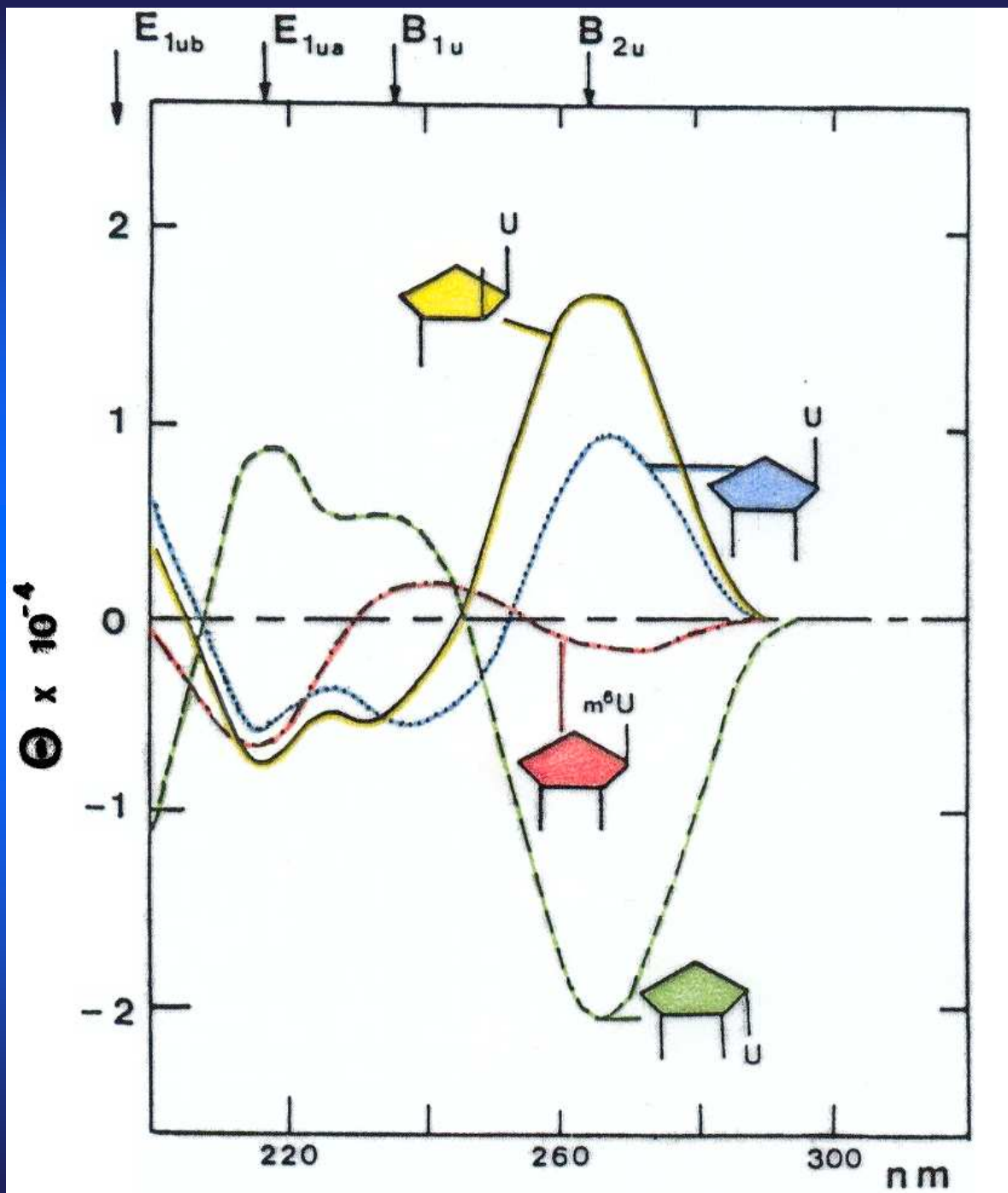

Podmínky vzniku CD DNA

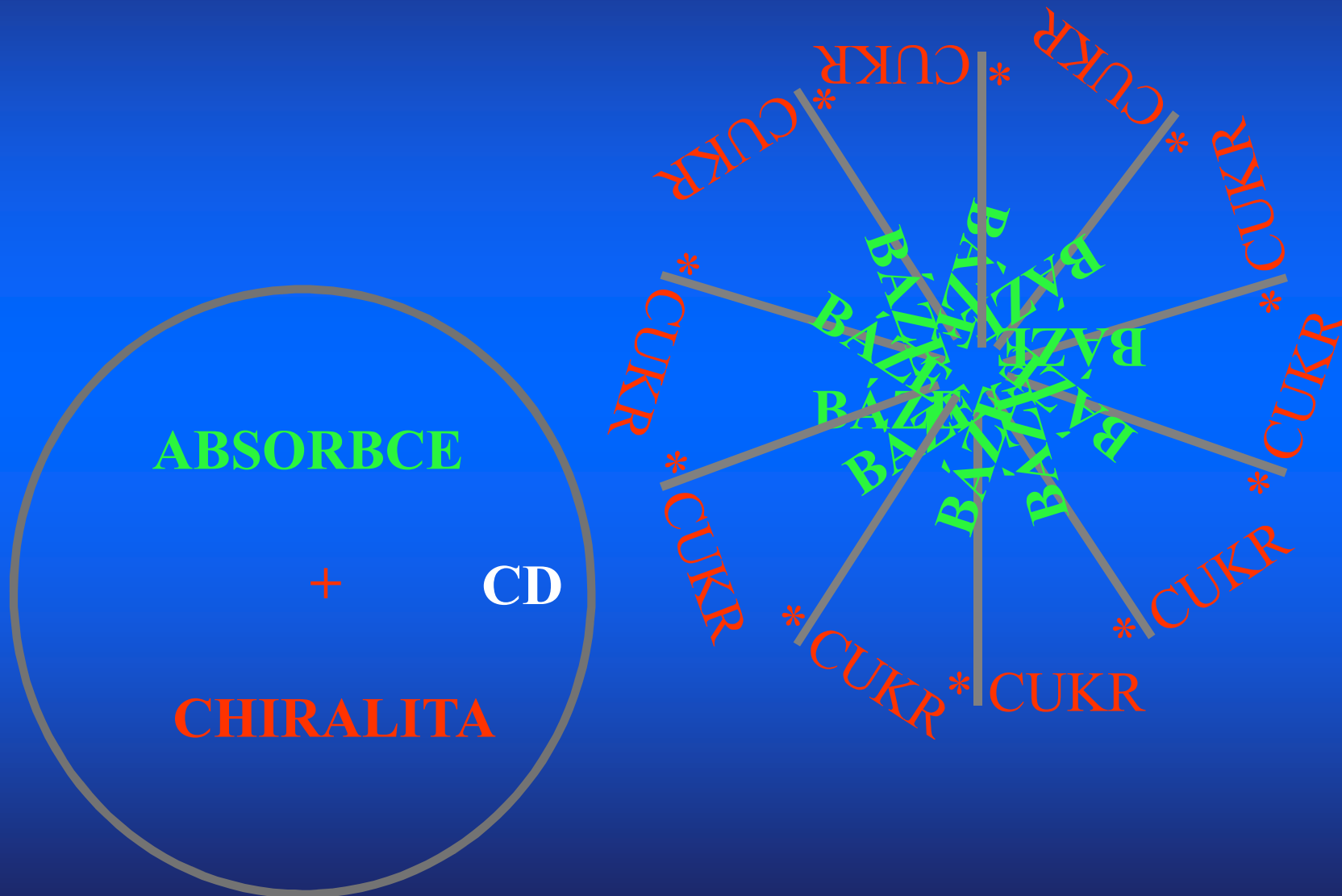

Cirkulární dichroismus a optická aktivita biopolymerů

-) optická aktivita – chirální látky (aminokyseliny, cukry) úhel stočení roviny polarizovaného světla, ORD
-) CD – princip, veličiny, elipticita, ΔA , $\Delta \epsilon$, vztah mezi ORD a CD
-) **Výhody a nevýhody CD spektroskopie ve srovnání s jinými metodami studia biopolymerů**

Výhody

Citlivost - nízká koncentrace studované látky
snadná rozpustnost
i v extrémních podmínkách

Snadná manipulace - titrace
přechody mezi různými strukturami
celý konformační prostor

Rozlišení mezi kooperativními a nekooperativními změnami

Nevýhody

Pro složité molekly jakými je DNA chybí explicitní vztah mezi spektrem CD a strukturou

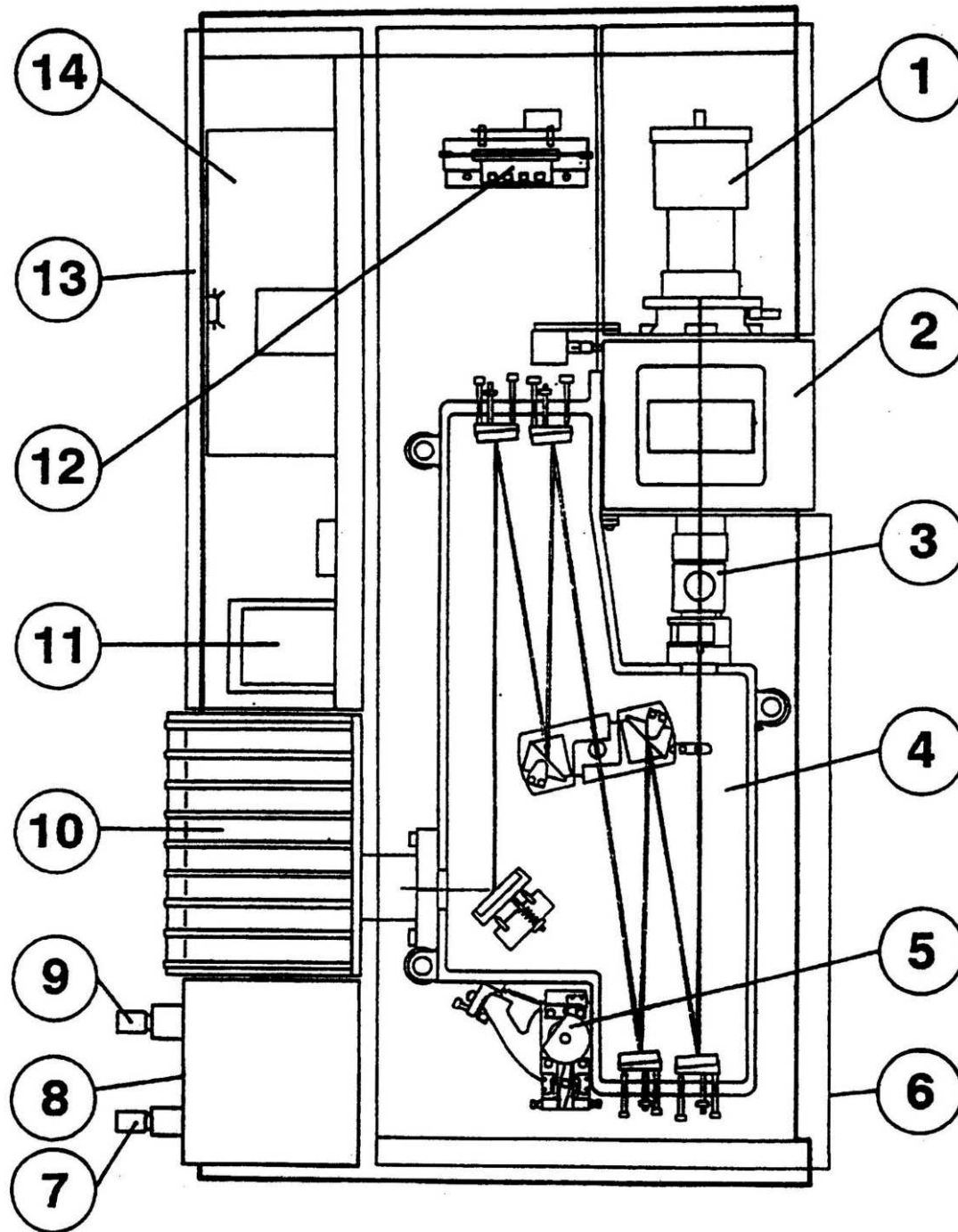

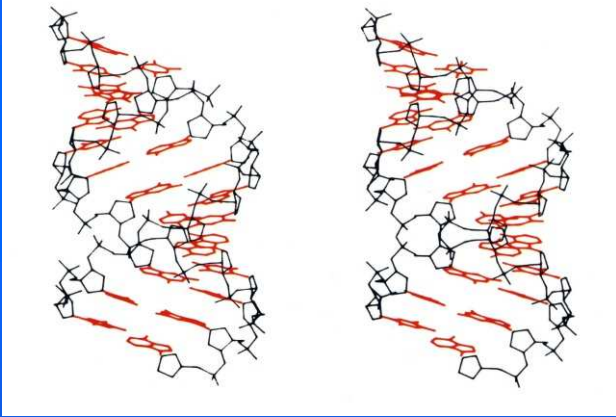
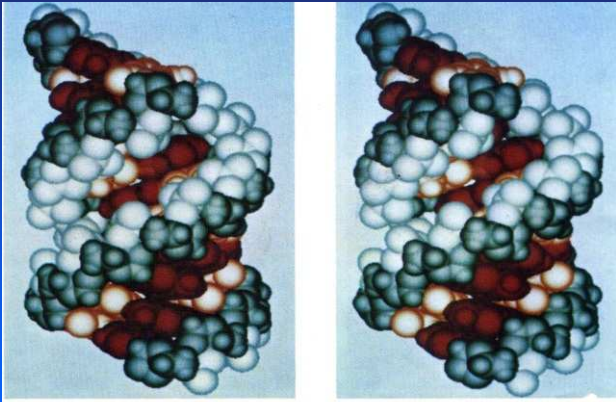

A

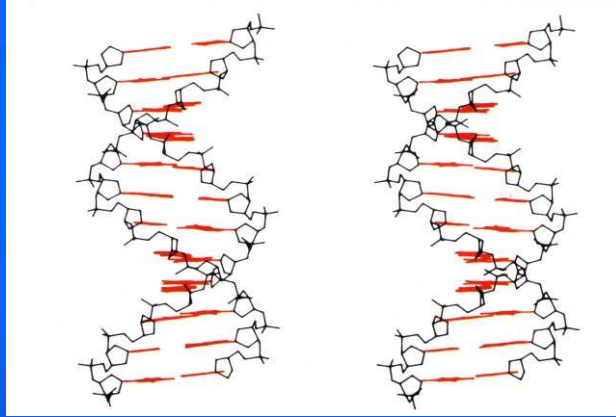
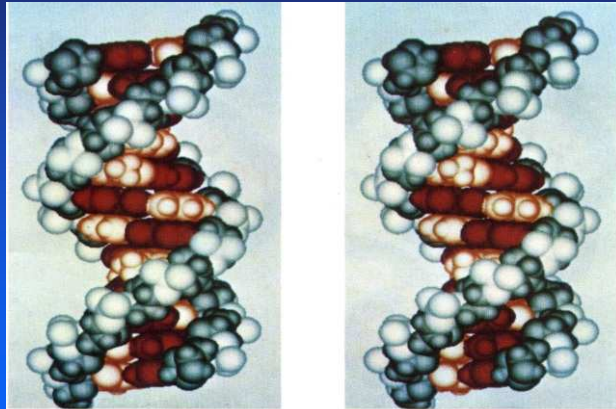

B

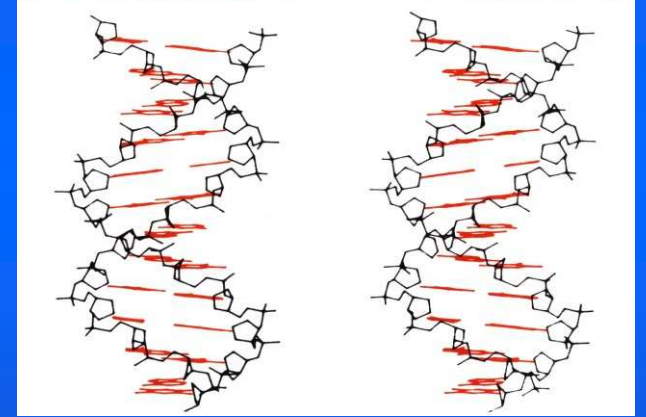
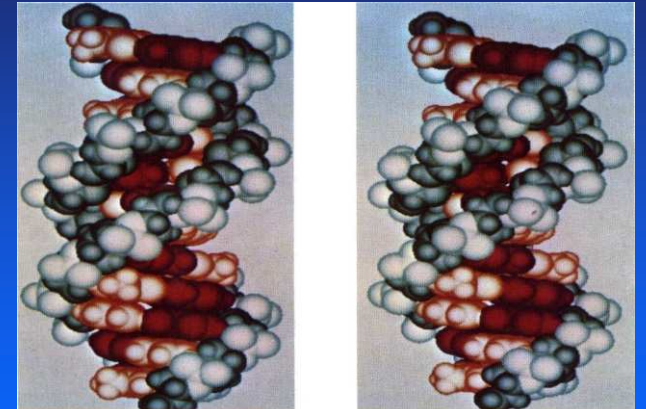

C,D,E,T

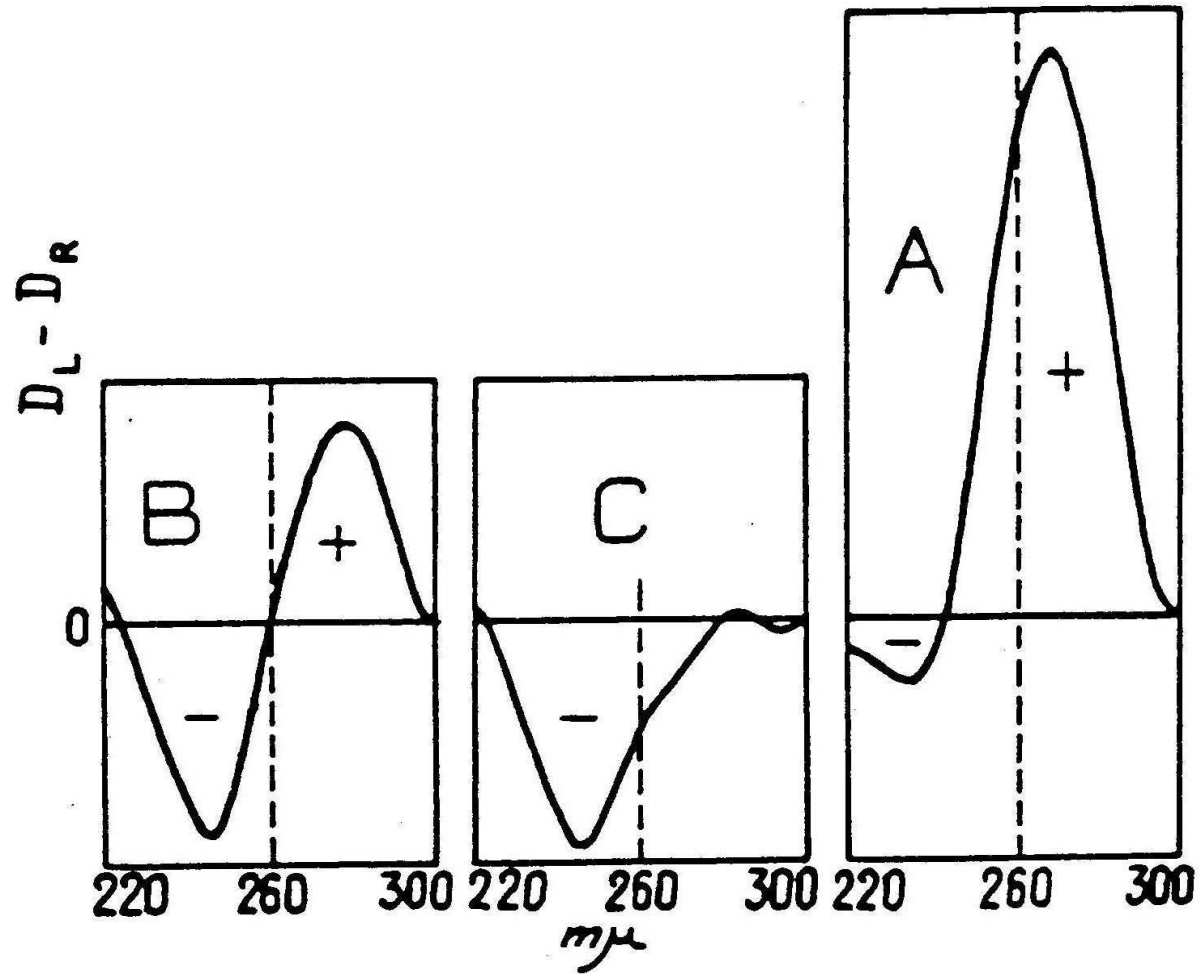

Tunis-Schneider, M.J.B. + Maestre, M.F.

Příklady nekooperativních a kooperativních změn

Nekooperativní změny
v rámci téže struktury

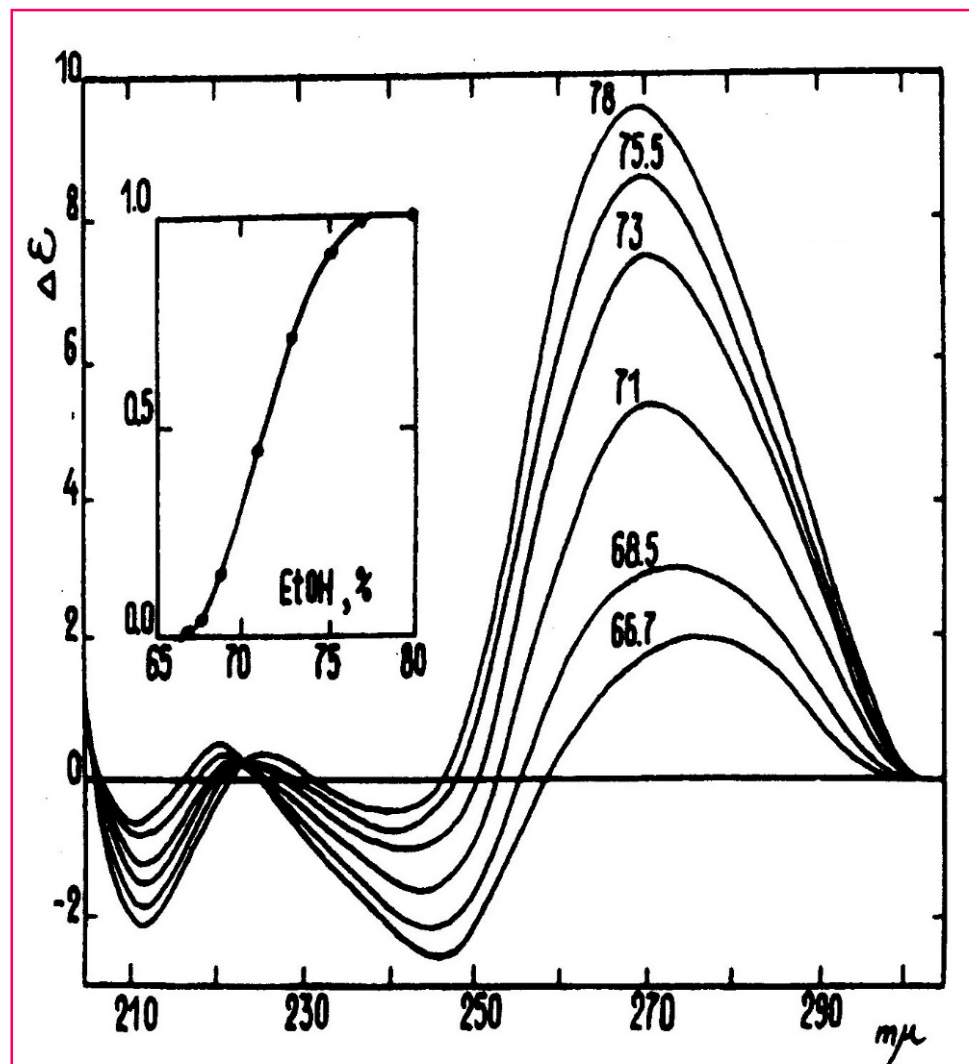
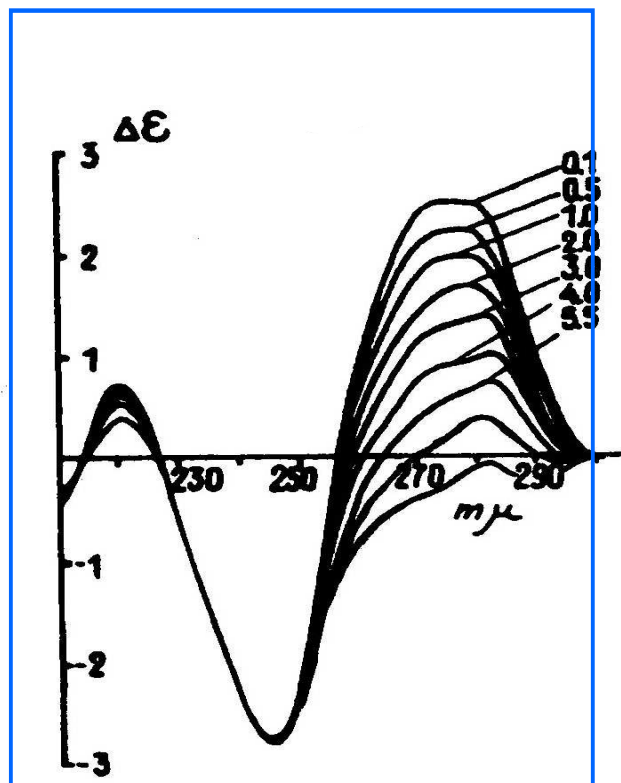

Kooperativní změny mezi diskrétními strukturami

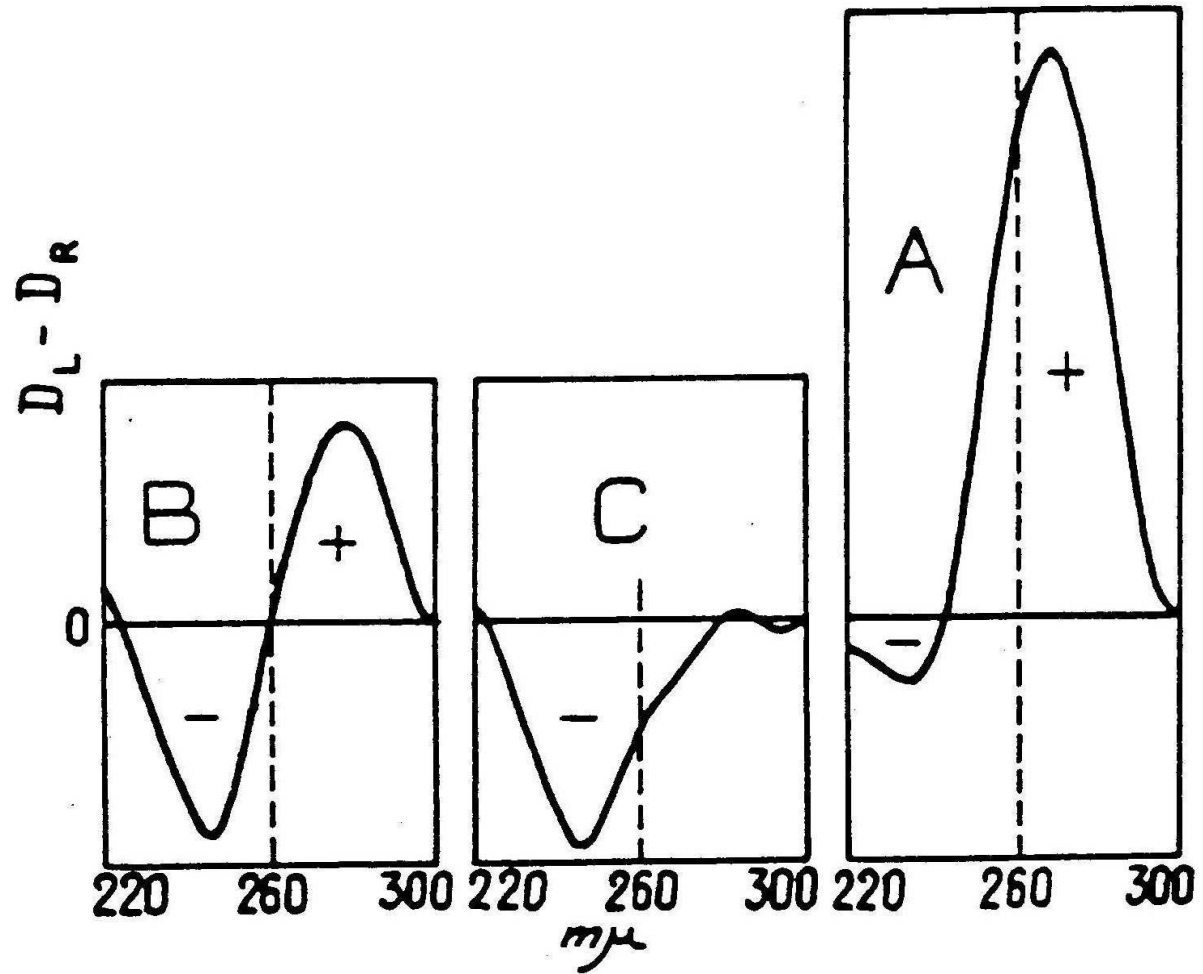

Tunis-Schneider, M.J.B. + Maestre, M.F.

Příklady nekooperativních a kooperativních změn

Nekooperativní změny
v rámci téže struktury

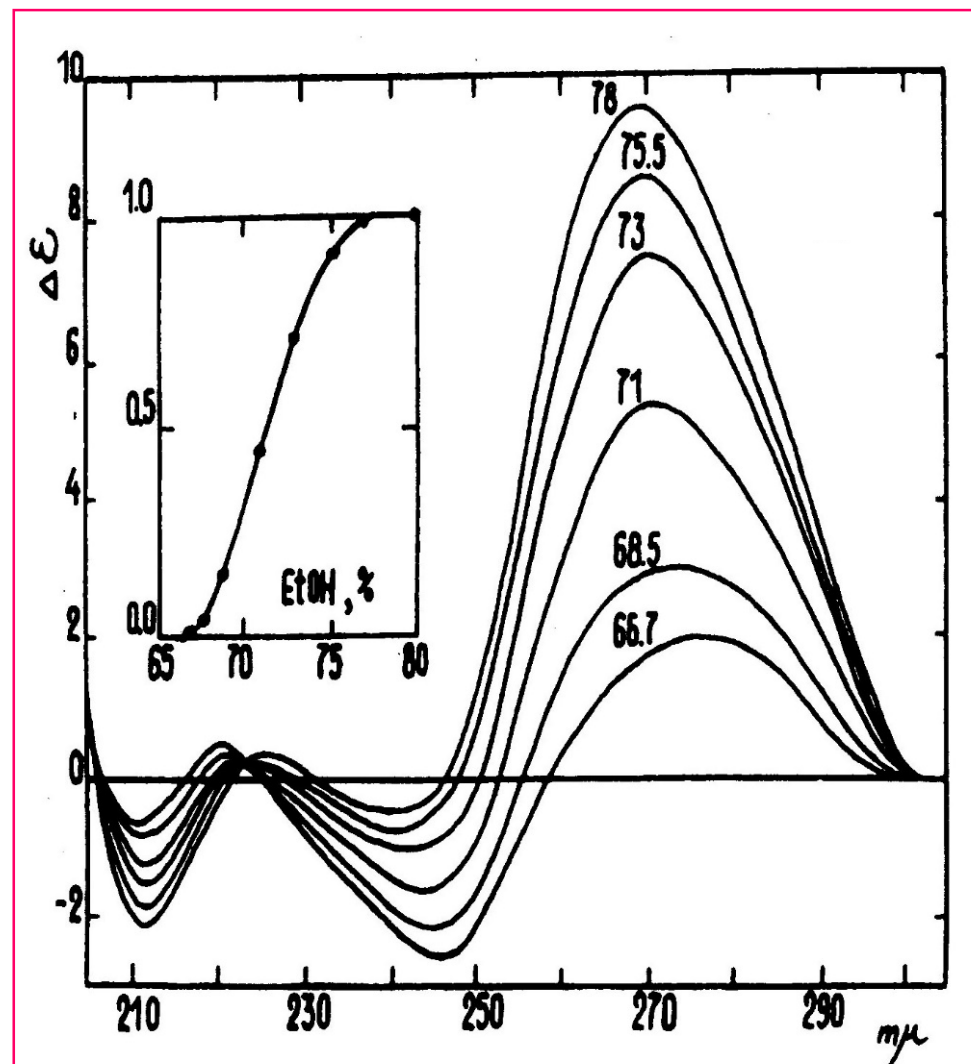
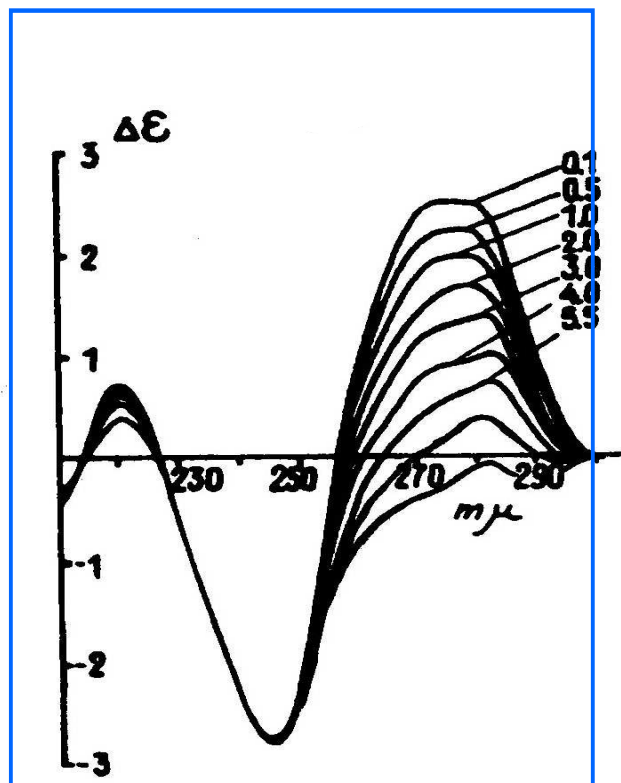

Kooperativní změny mezi diskrétními strukturami

B DNA

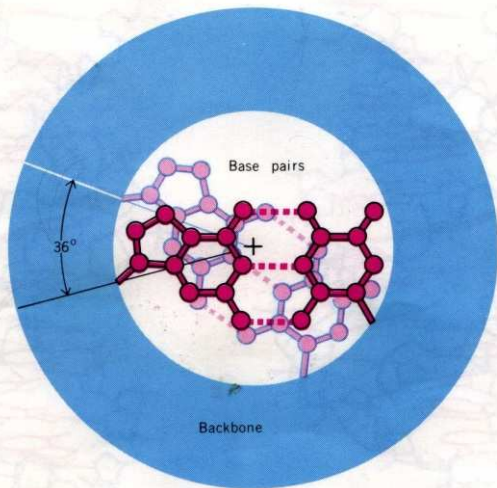
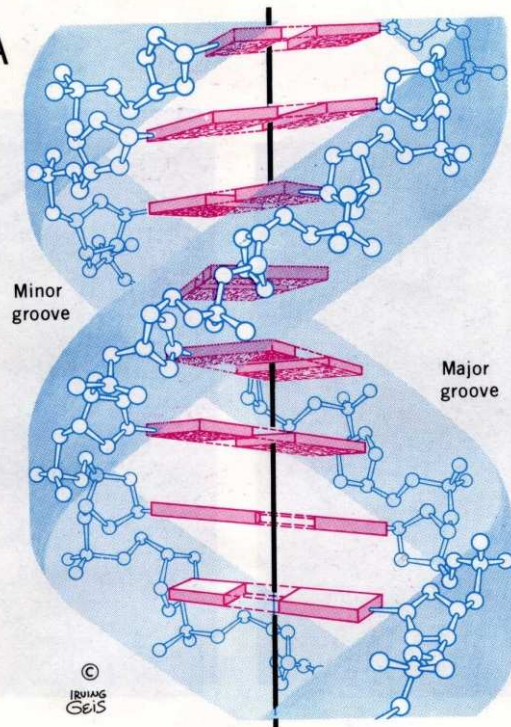

A DNA

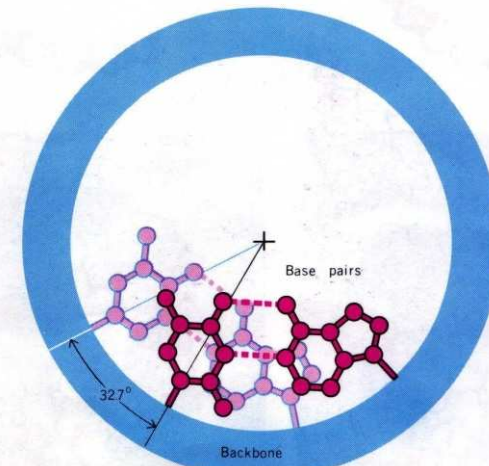
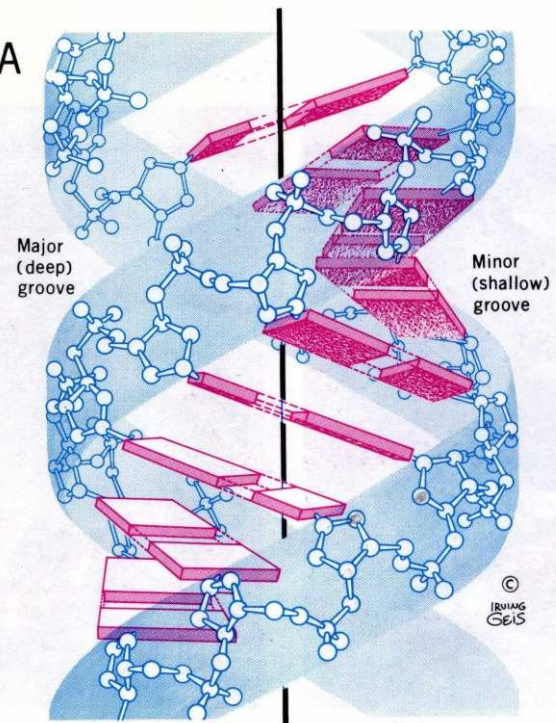

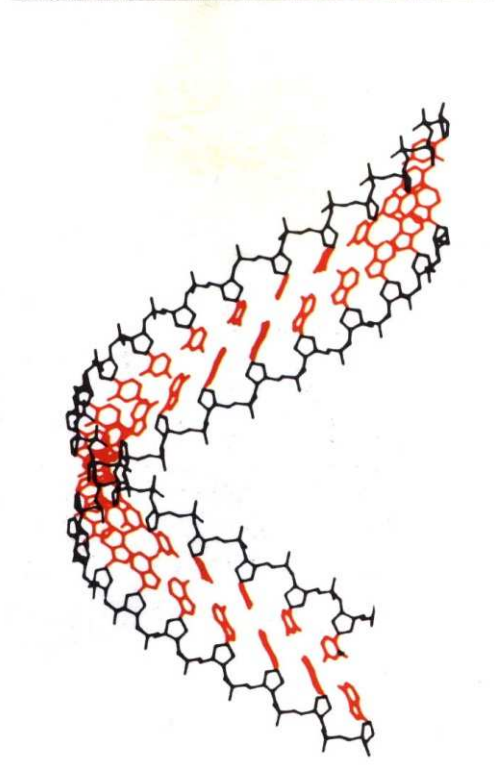
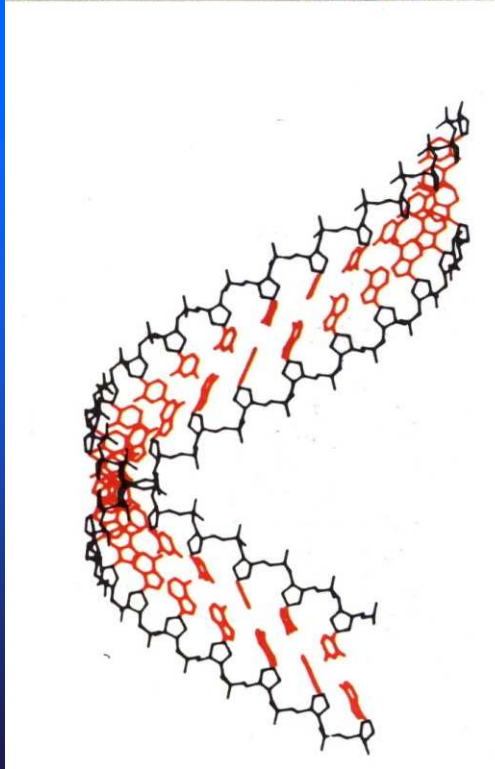
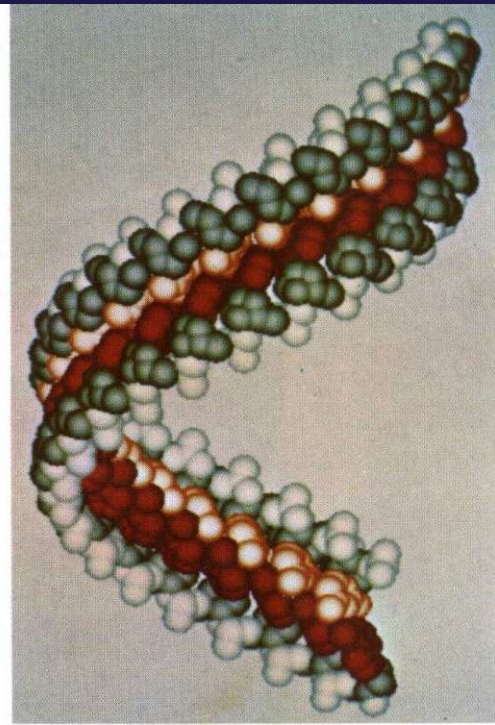
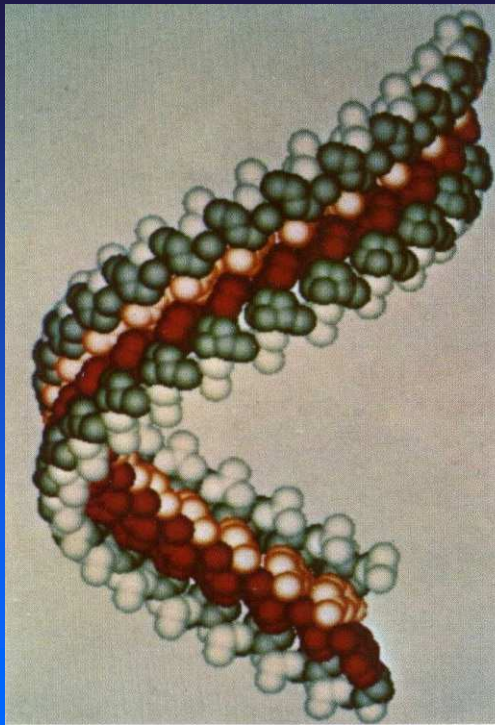

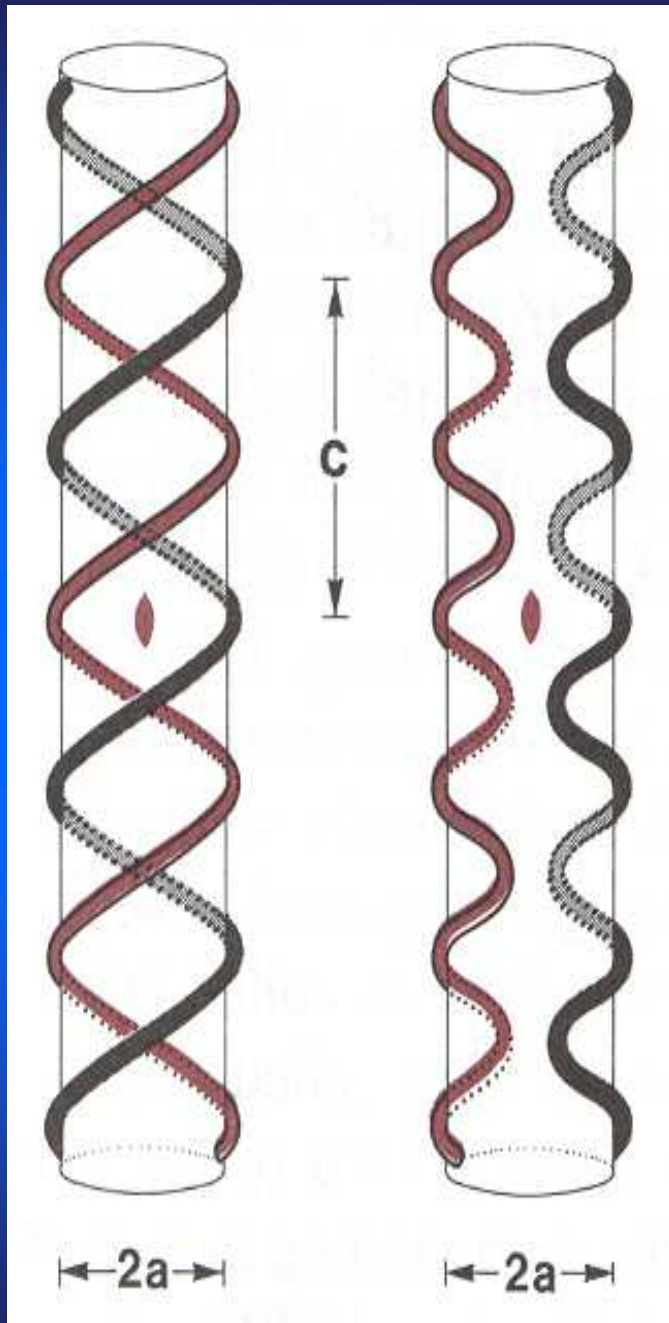

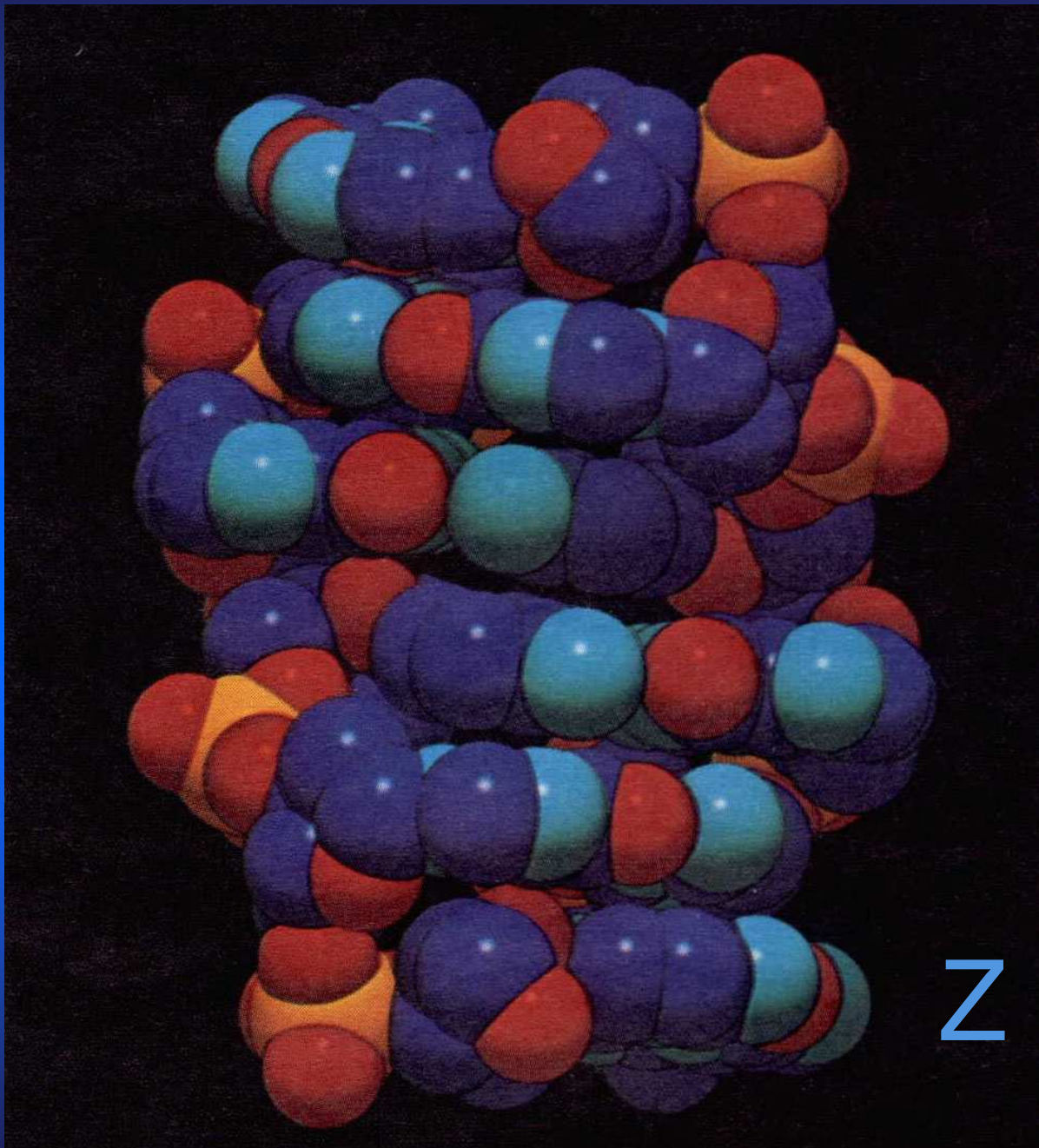

Z

Dickerson, R.

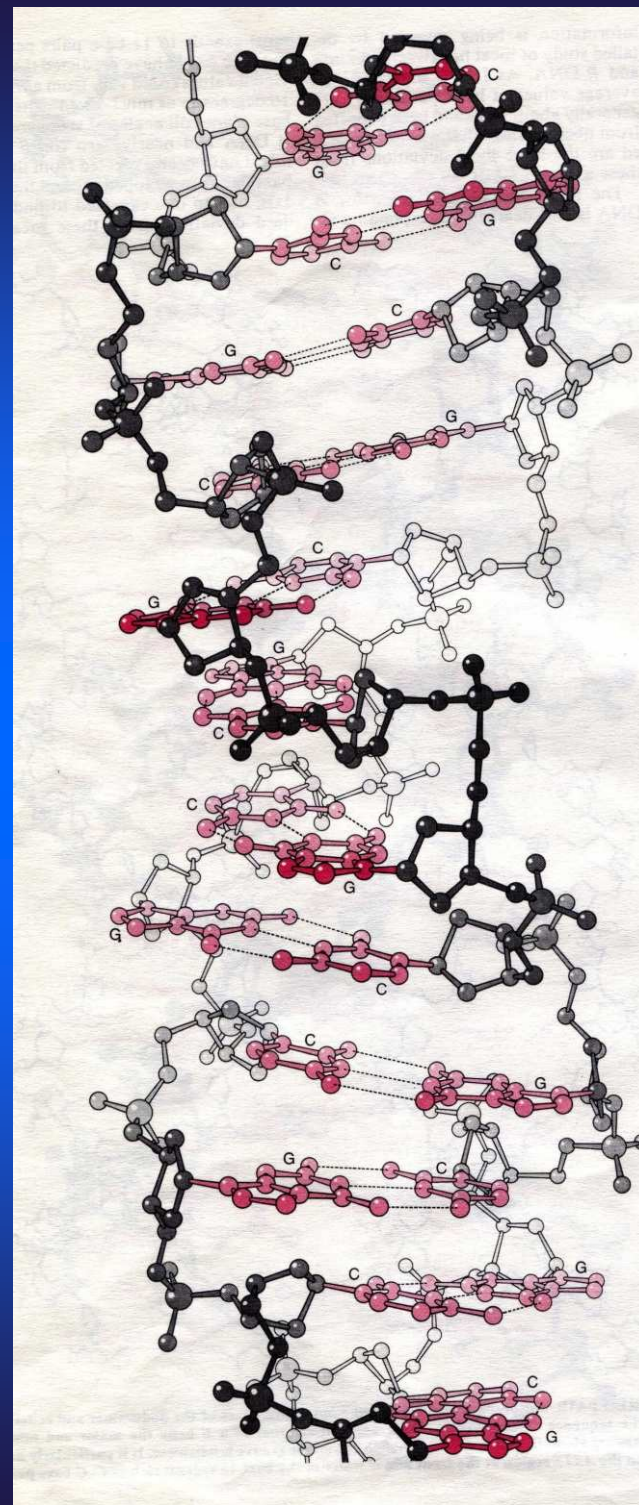

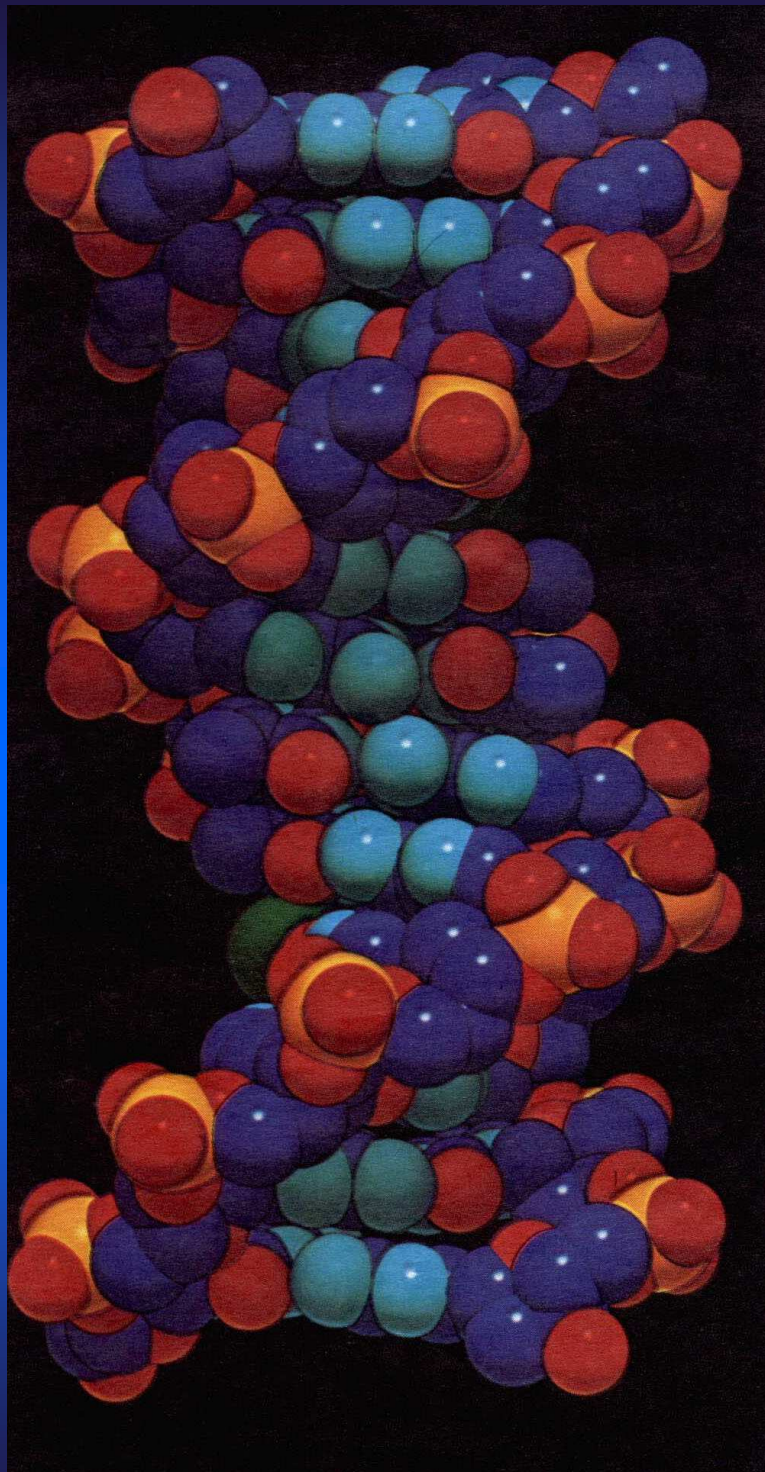

Dickerson, R.

B

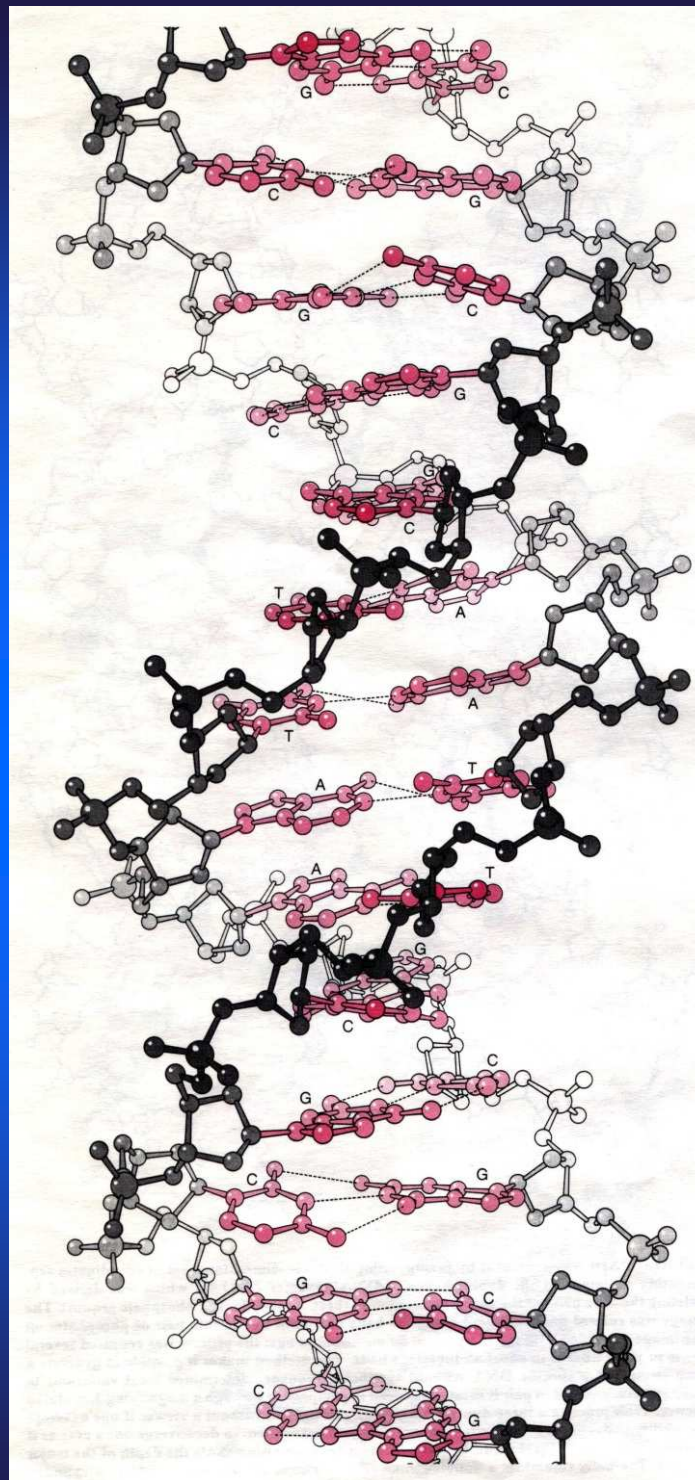

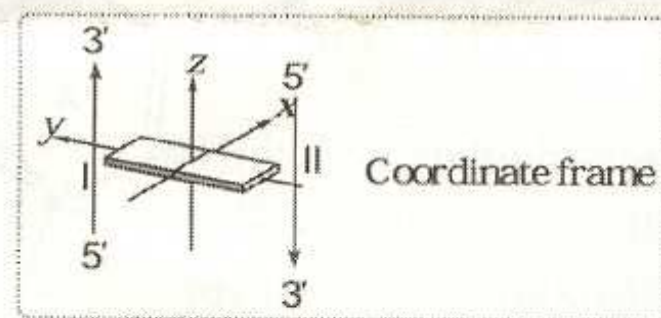
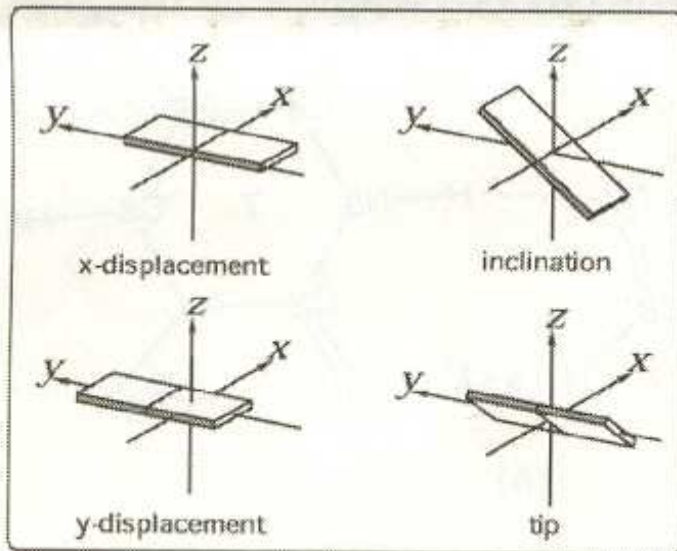
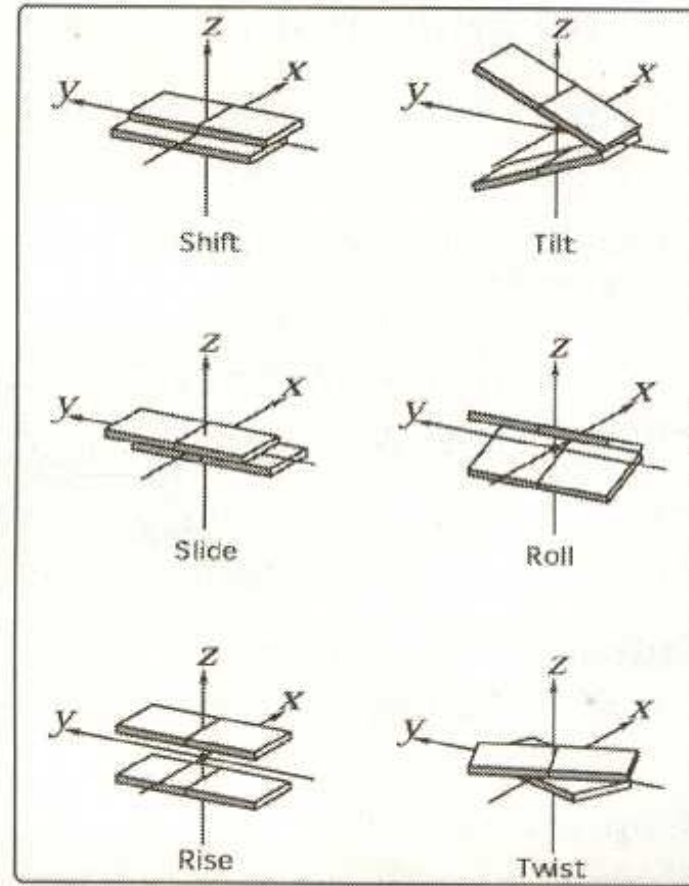
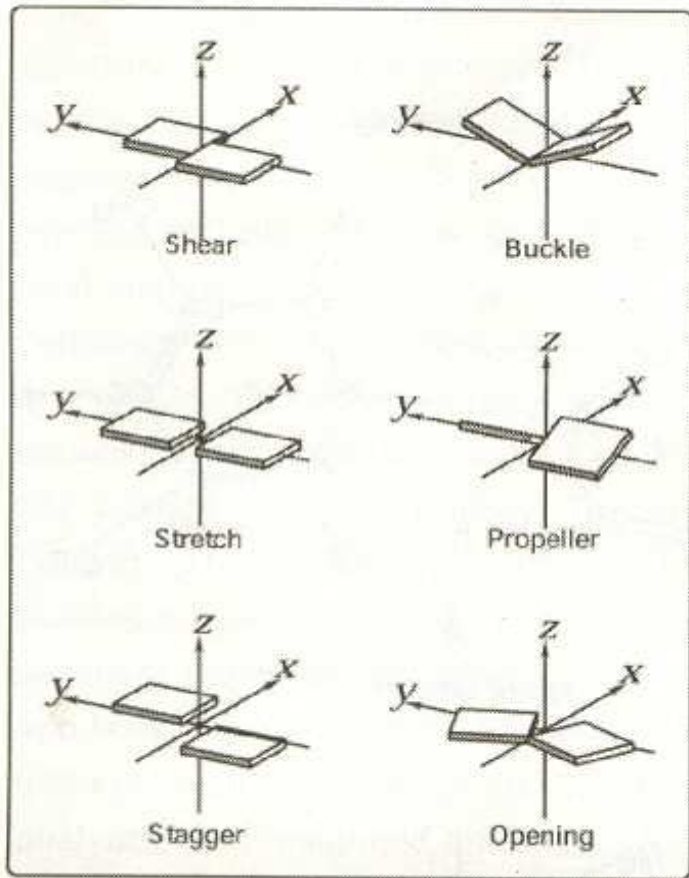

CD spectral changes accompanying B-Z transition of poly(dG-dC)

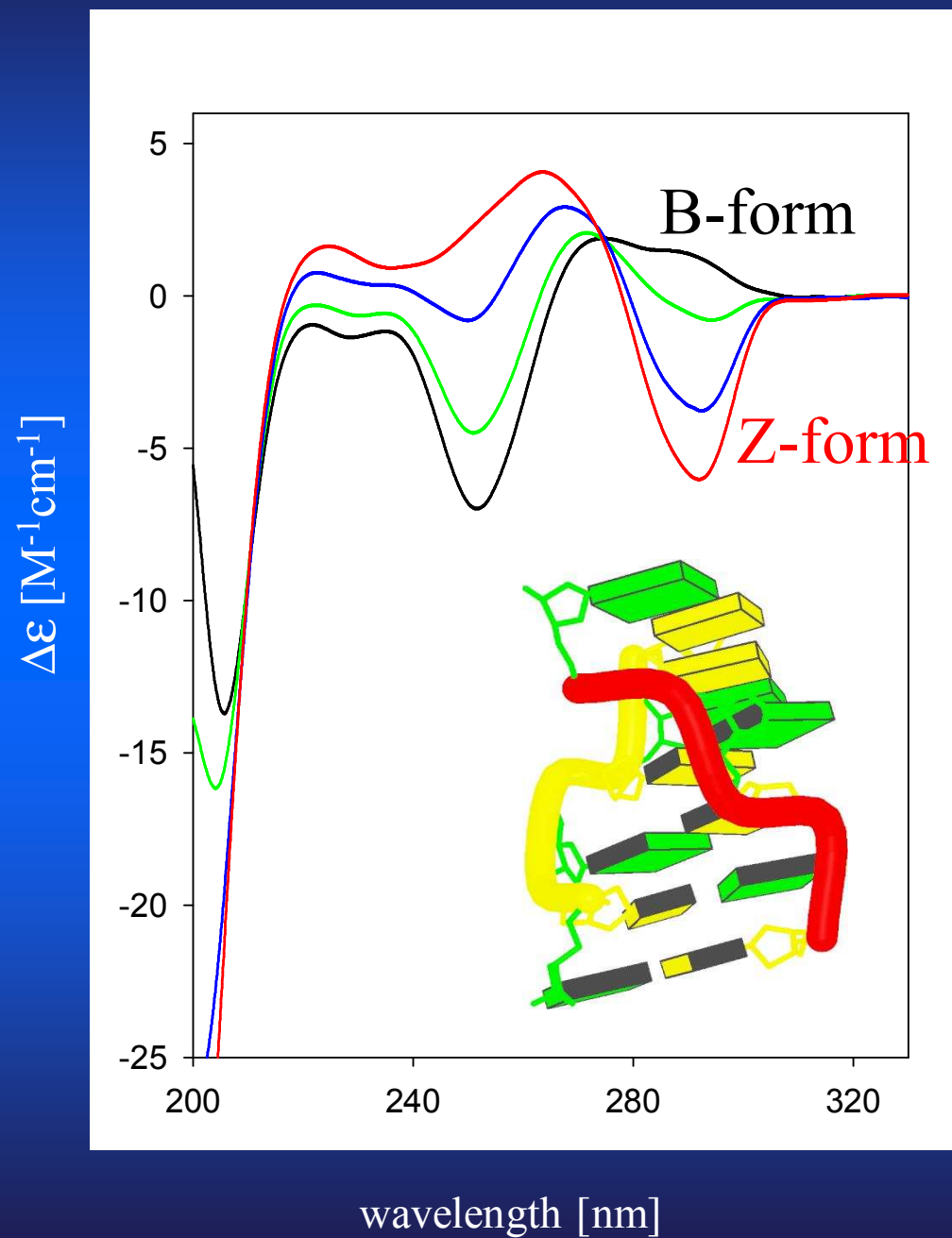

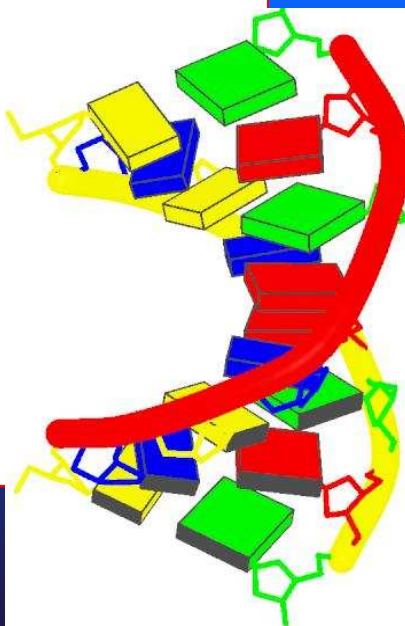
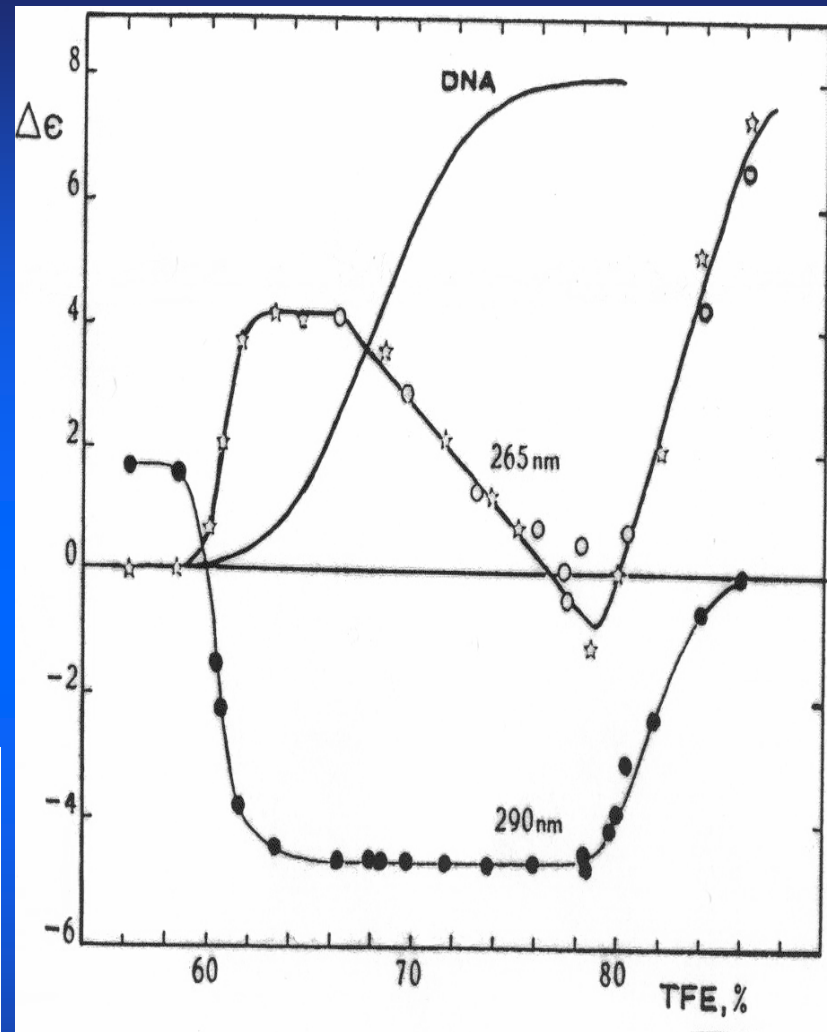
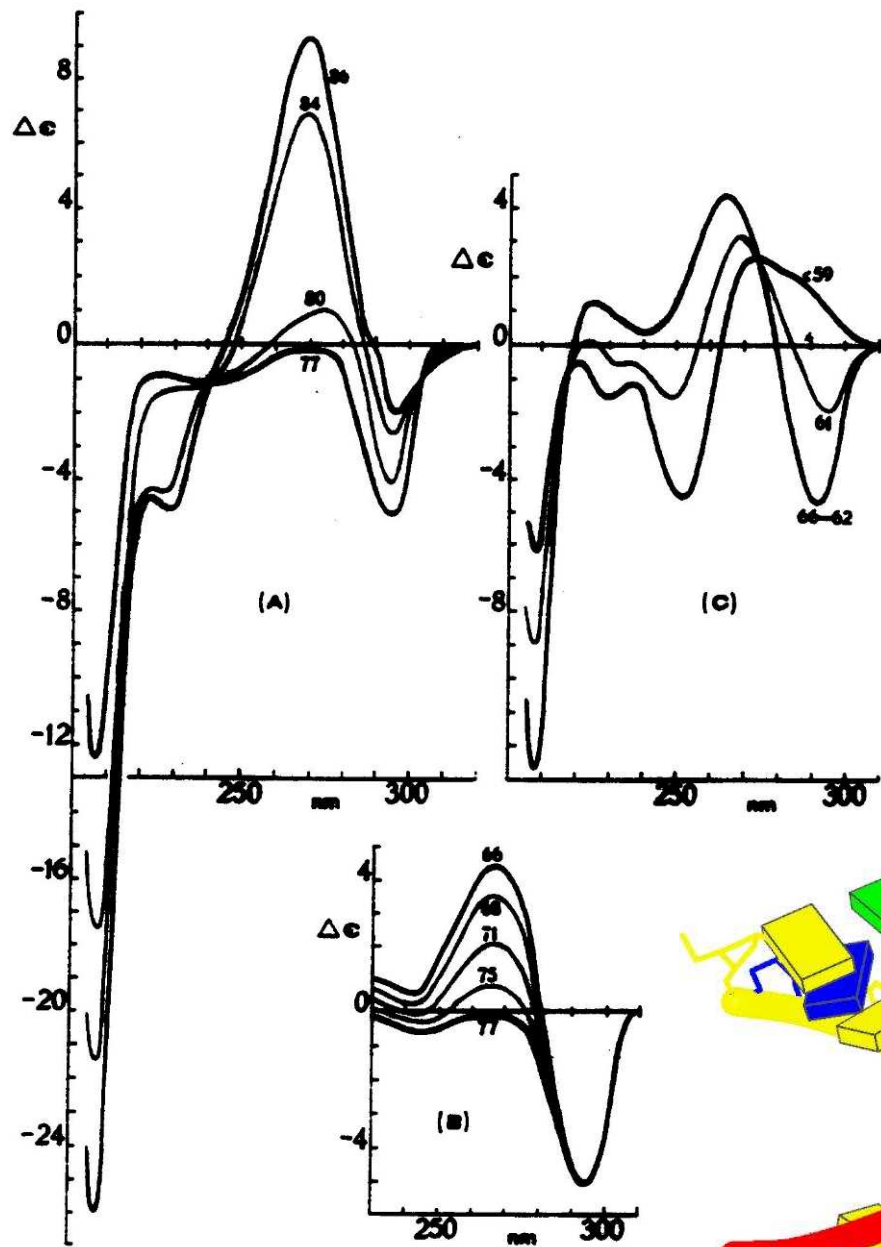

ATATATATATATATATATATATATATATATATATATATA

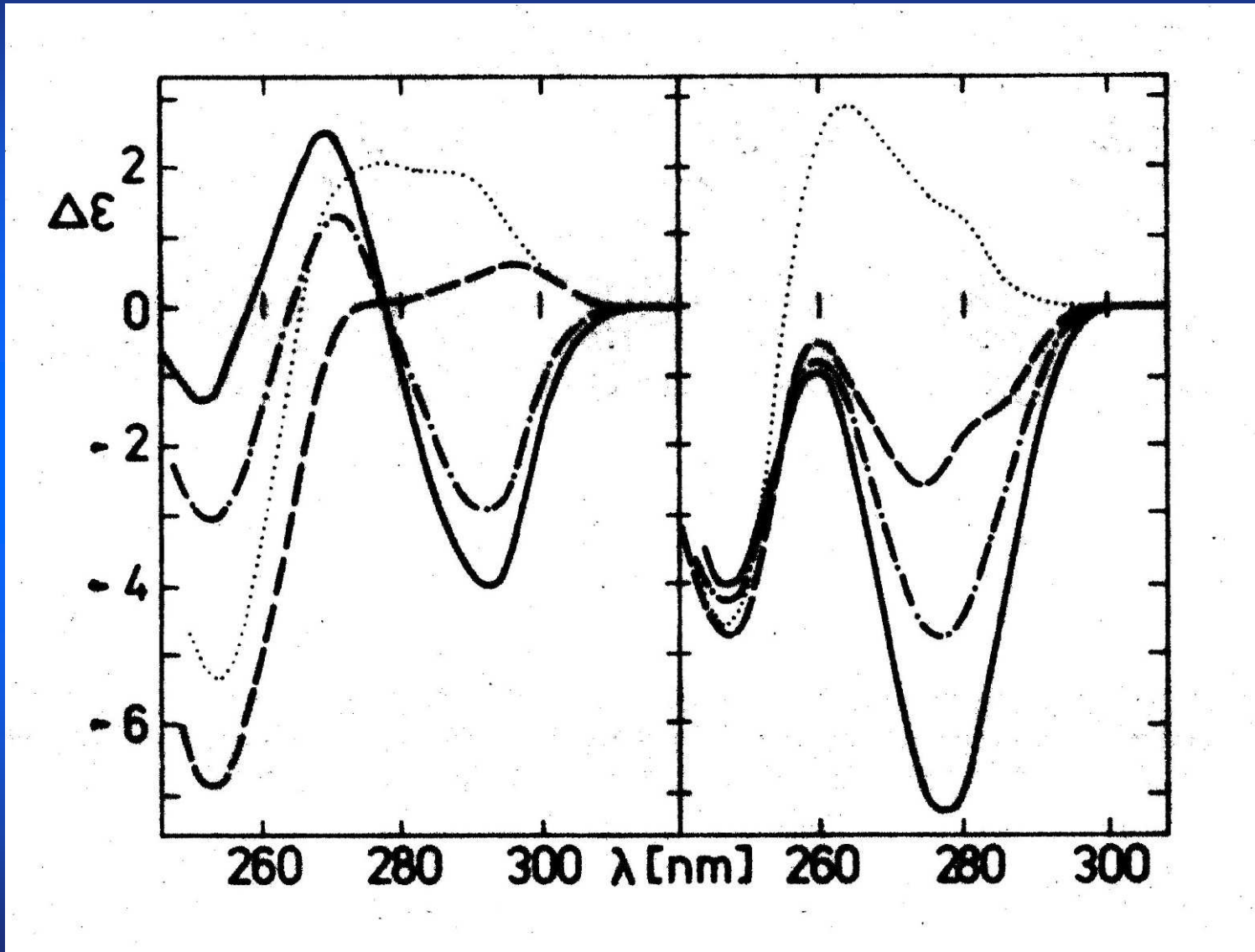

ATATATATATATATATATATATATATATATATATA

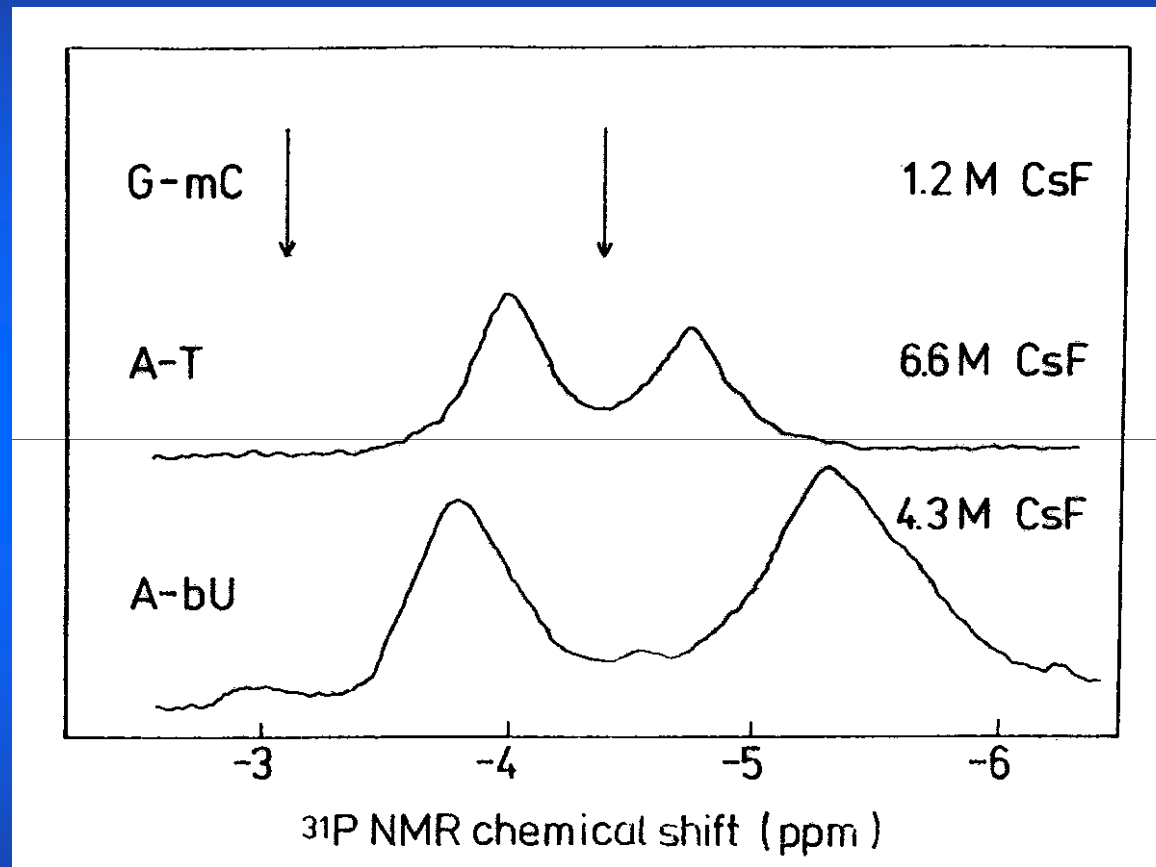

X-DNA

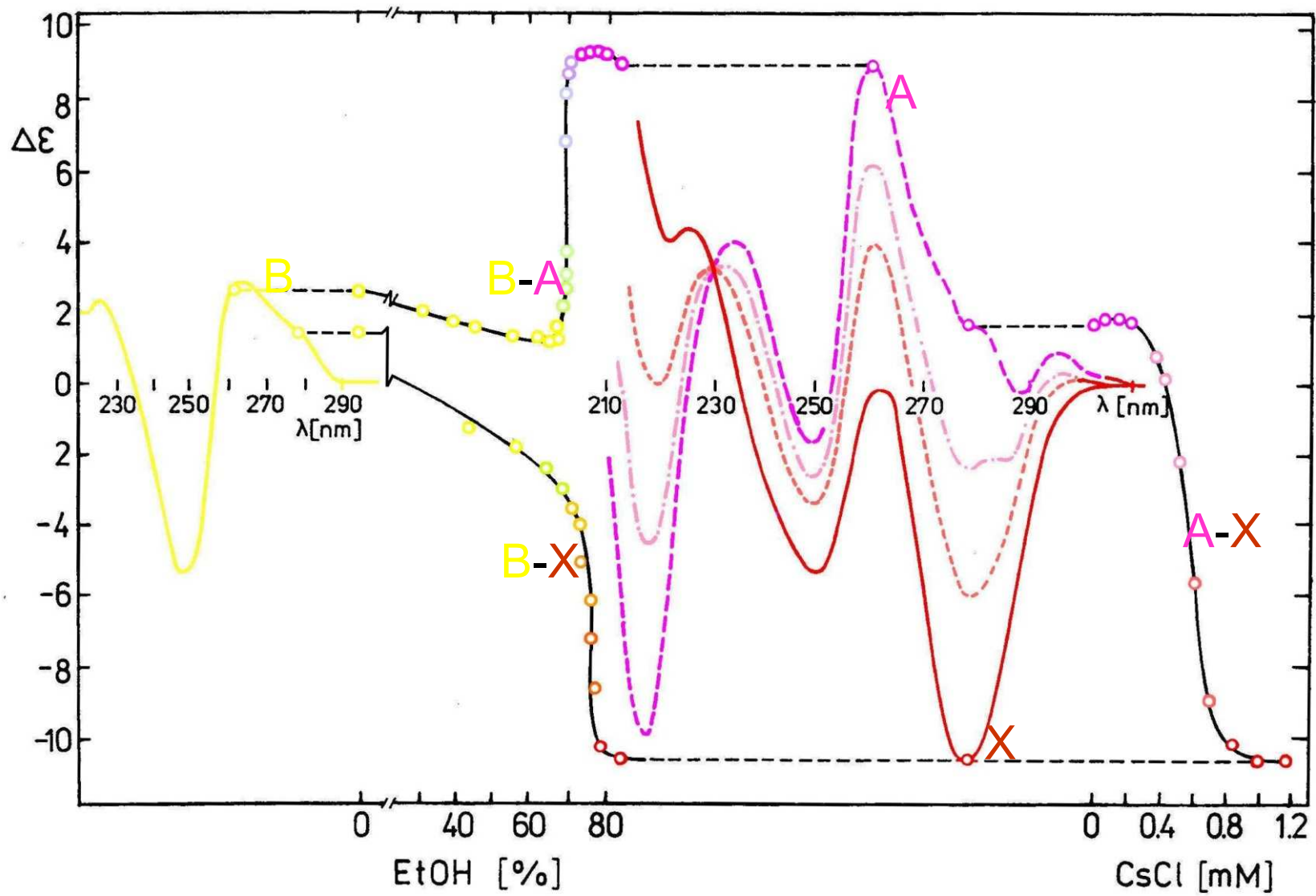

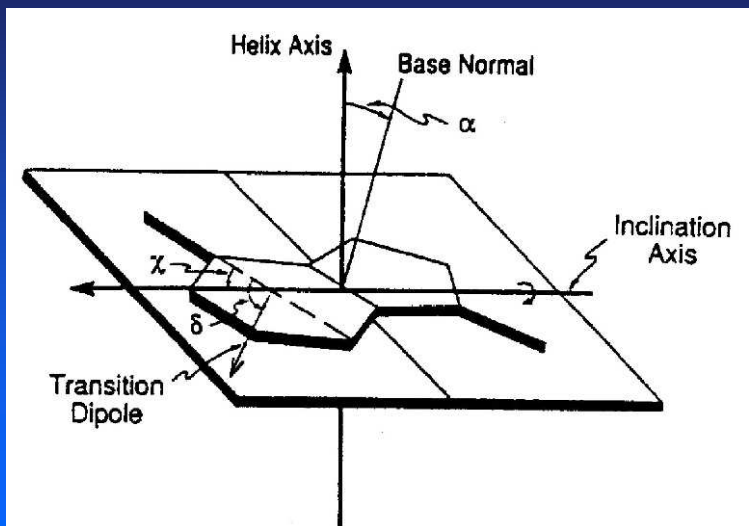

$$LD = A_{\parallel} - A_{\perp}$$

Lineární dichroismus

	α [deg]	χ [deg]
dA	20.9	95.2
dT	39.7	60.8

α - inclination of the base normal from the helix axis

χ - orientation of the inclination axis relative to the $C_4 - C_5$ bond of the purine base or the $C_6 - C_5$ bond for the pyrimidine base

Inclin.	Buckle	Propeller	Helical Twist		} 7 bp / turn
20°	31°	40°	36°	ApT	
			66°	TpA	

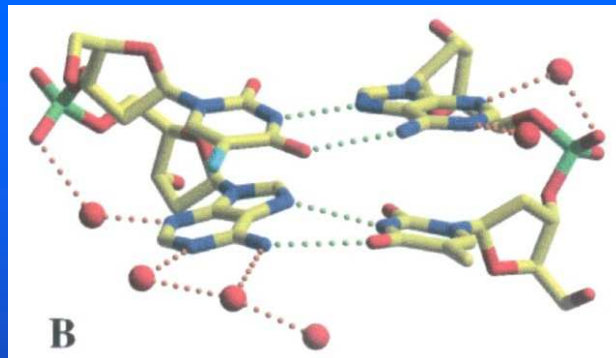
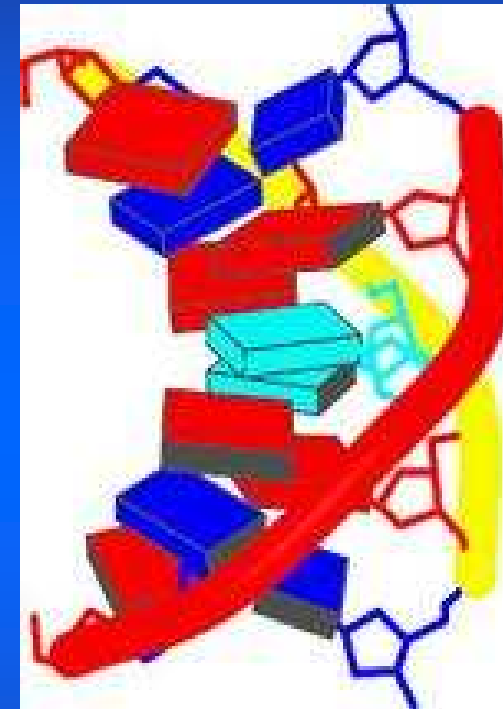
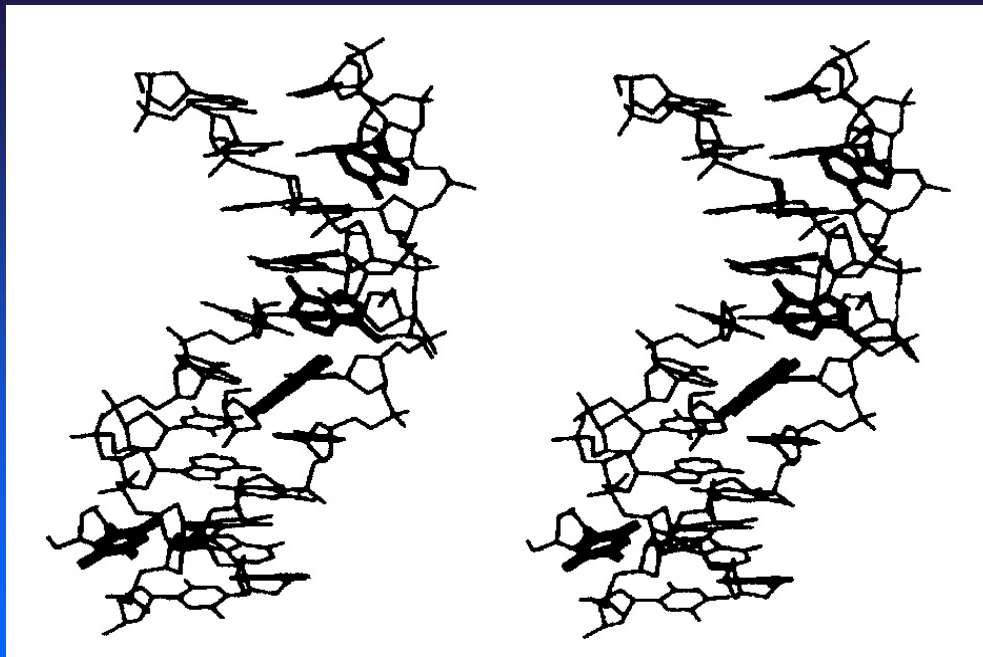

ALTERNATING A-T FRAGMENT WITH HOOGSTEEEN BASE PAIRING

Subirana, J.: *Proc.Nat.Acad.Sci.USA* , **99**, pp. 2806, 2002.
Biochemistry , **43**, pp. 4092 - 4100, 2004.

Alternating (Pu-Py)_n

(Pu)_n · (Py)_n complexes

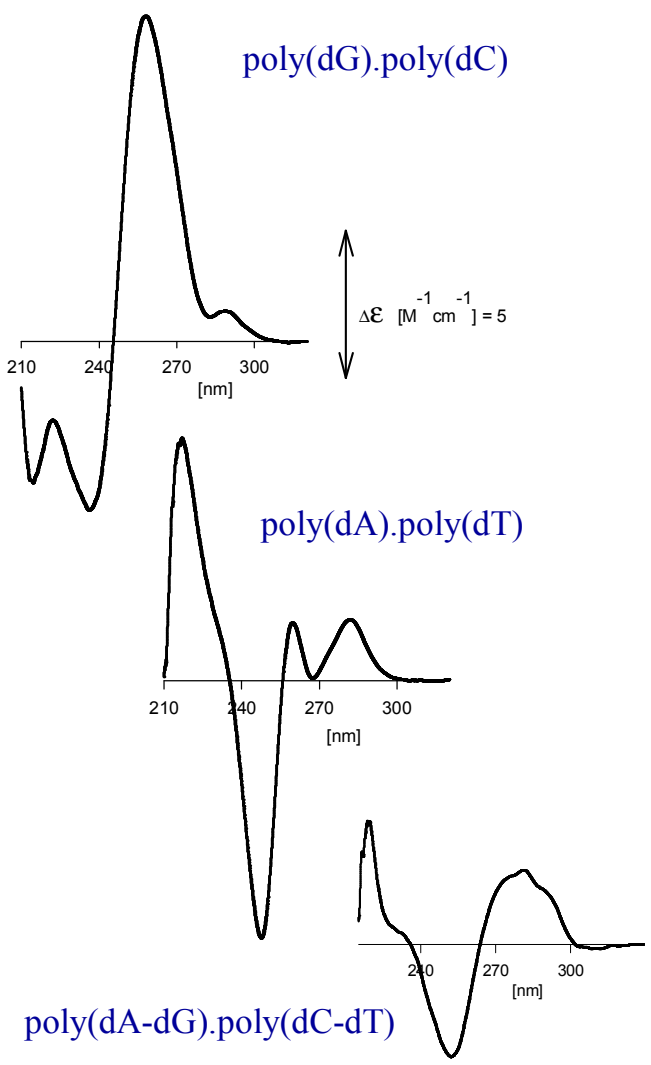

DNA Triplex

Pyrimidine. Purine. Pyrimidine

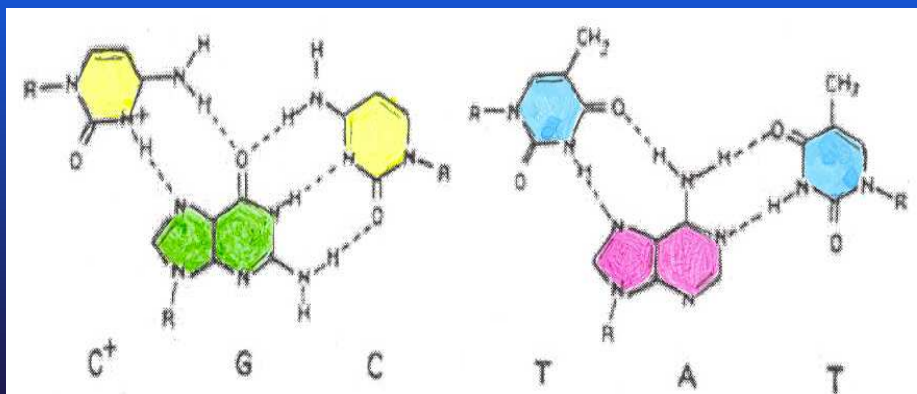
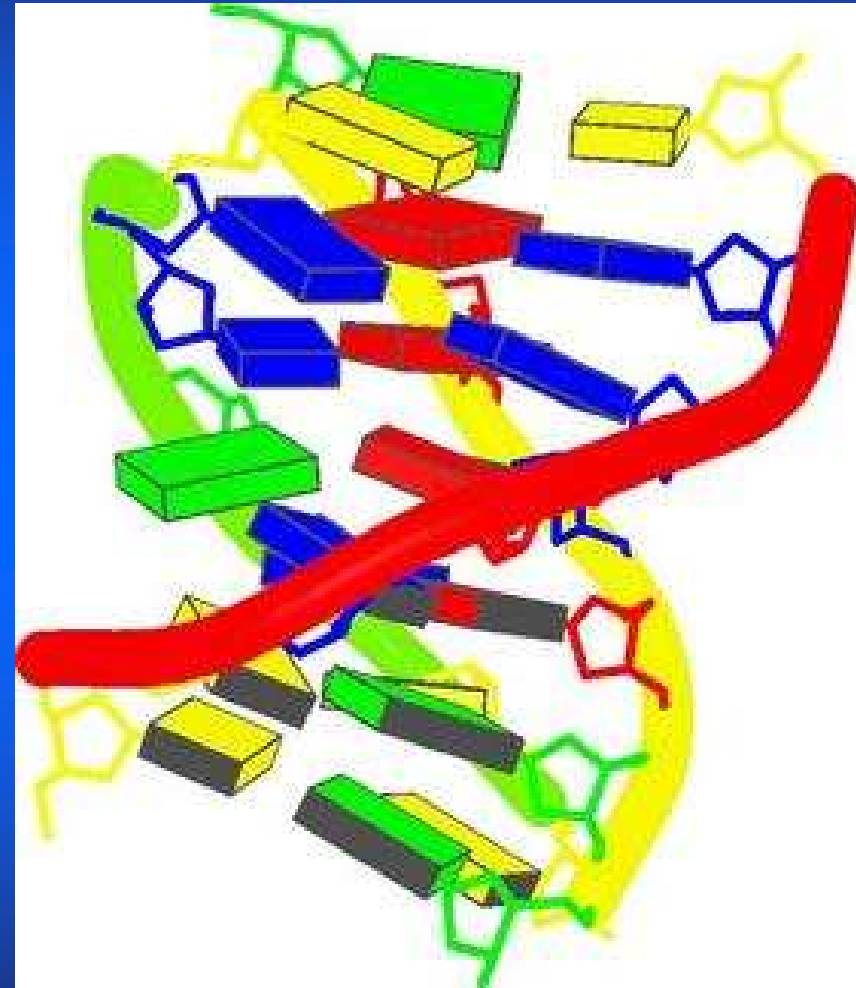

Radhakrishnan, I., Patel, D.J. (1994)

DNA TRIPLEX

TCCTCCTTTT TAGGAGGATTTT TGGTGGT

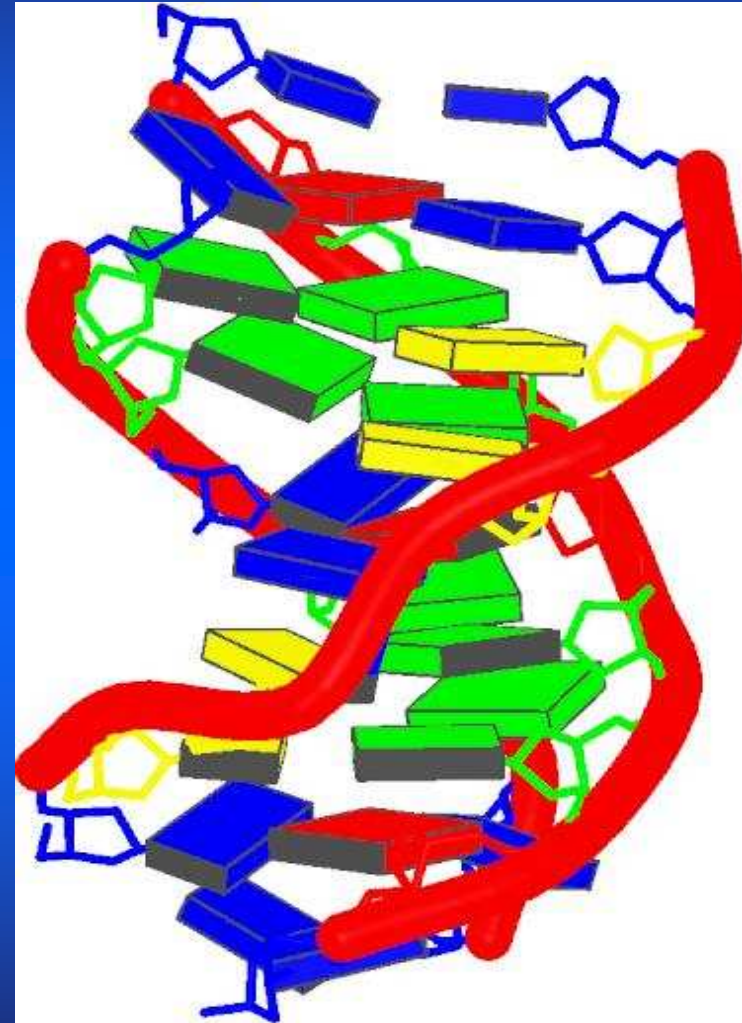
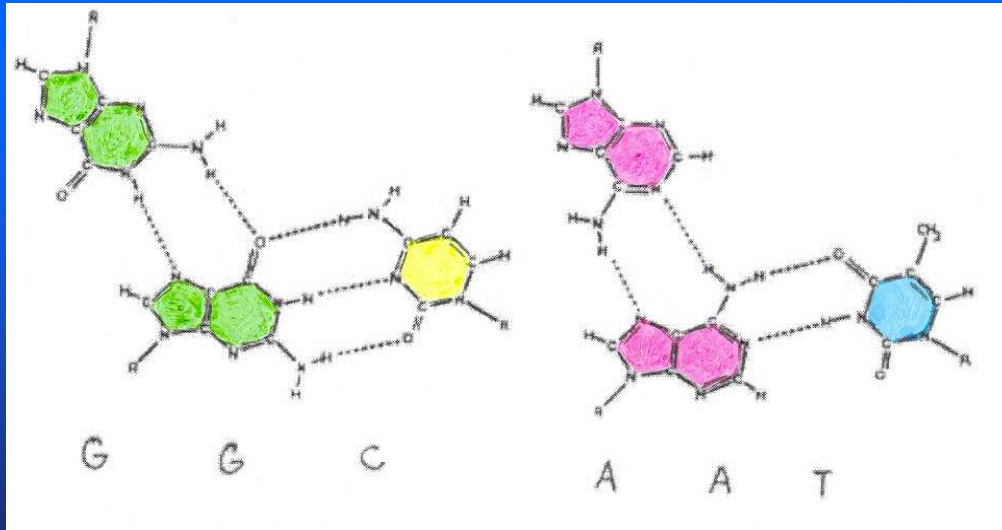

Radhakrishnan, I., Patel, D.J. (1993)

Pyrimidine. Purine. Purine

The triplex formation determined by mixing curves

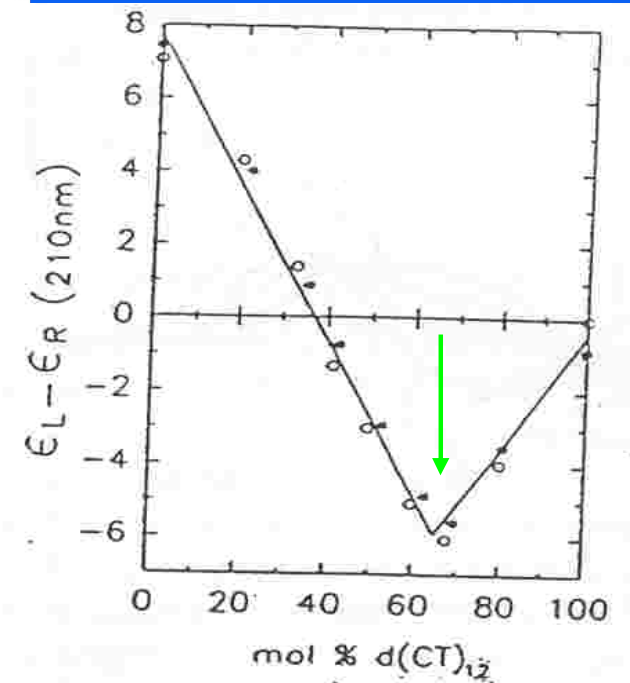
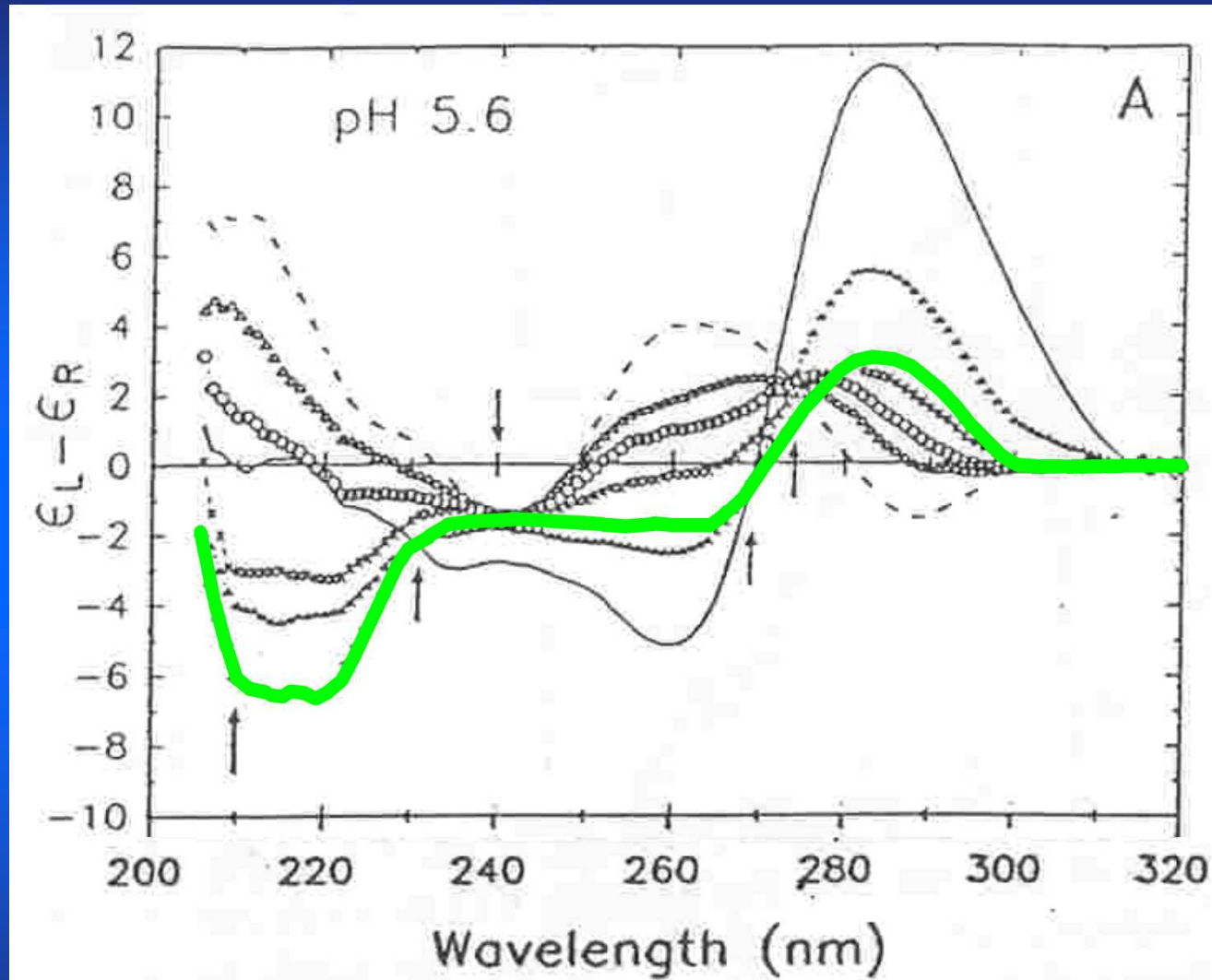

T Gray, D.M., Hung, S-H., Johnson, K.H.:
Methods Enzymol. 246 (1995) 19-34.

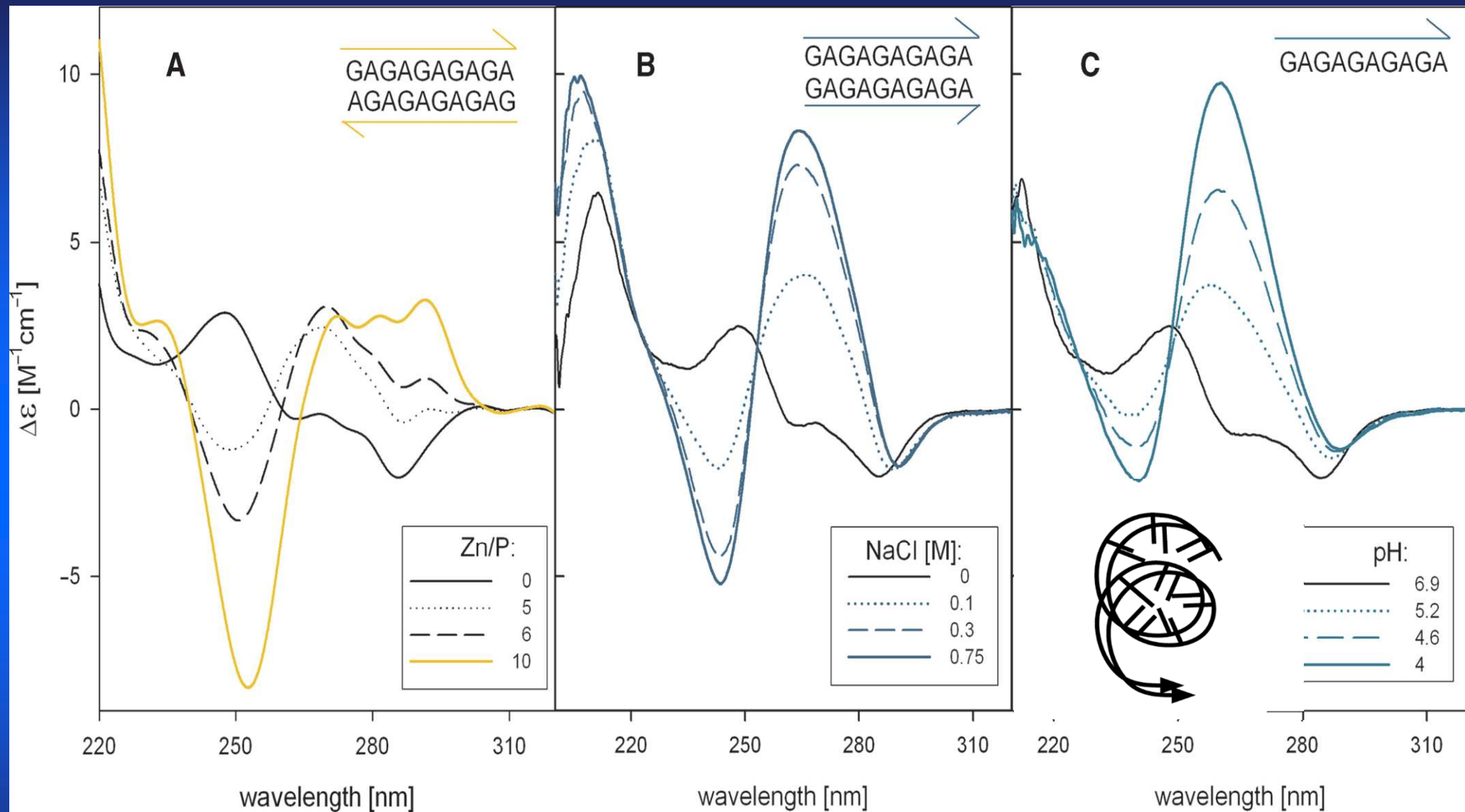

Quadruplexes

frequently occur in promoters of genes and were shown to control their expression.

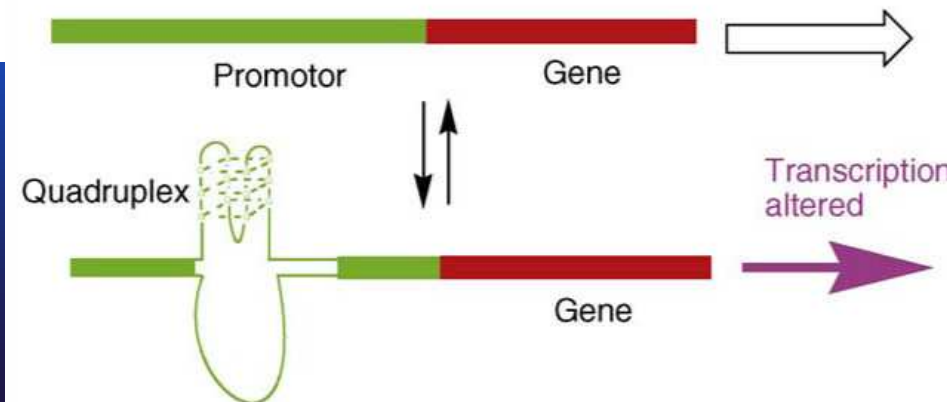
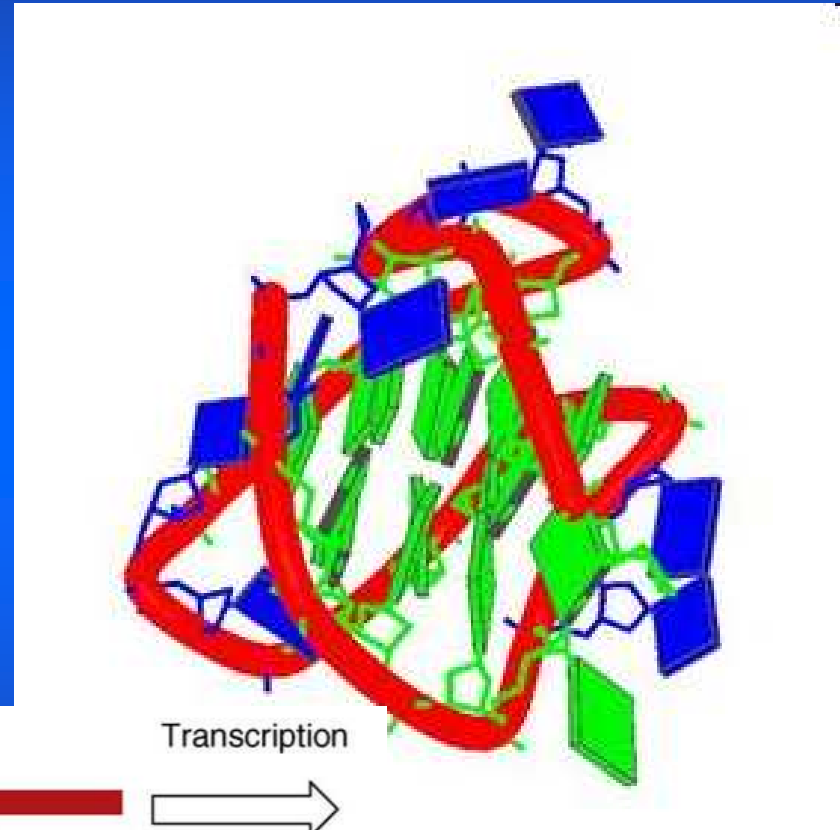
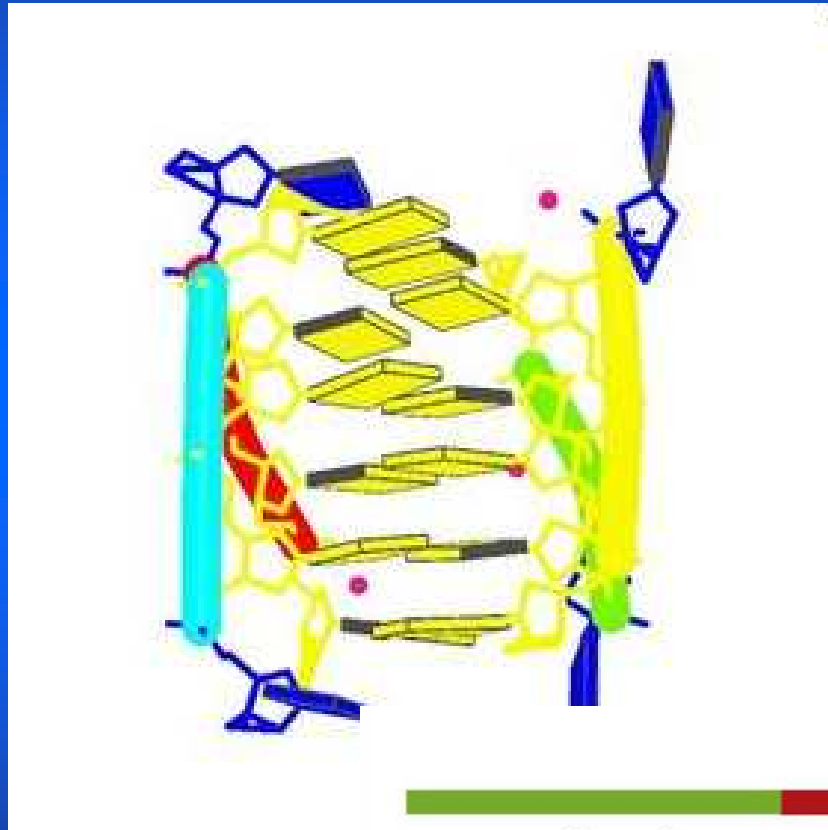

i - tetraplex

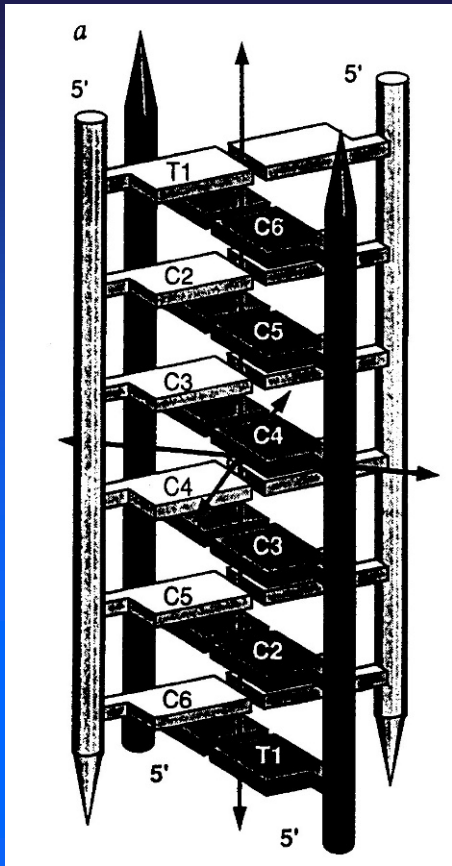

Leroy, J.L., Gueron, M., 1995

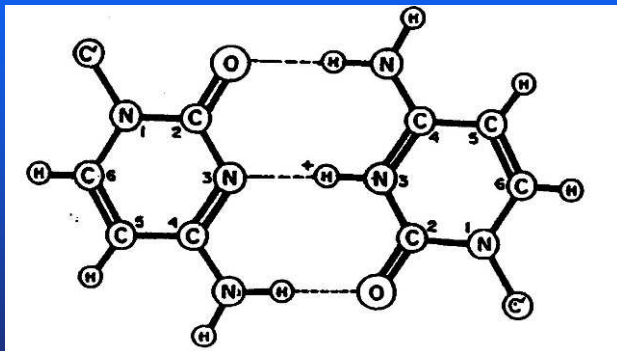

Two parallel-bonded duplexes are intercalated in the antiparallel fashion

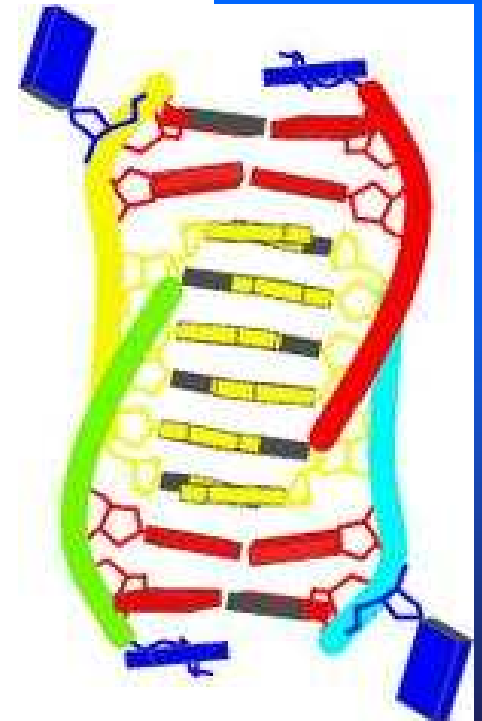
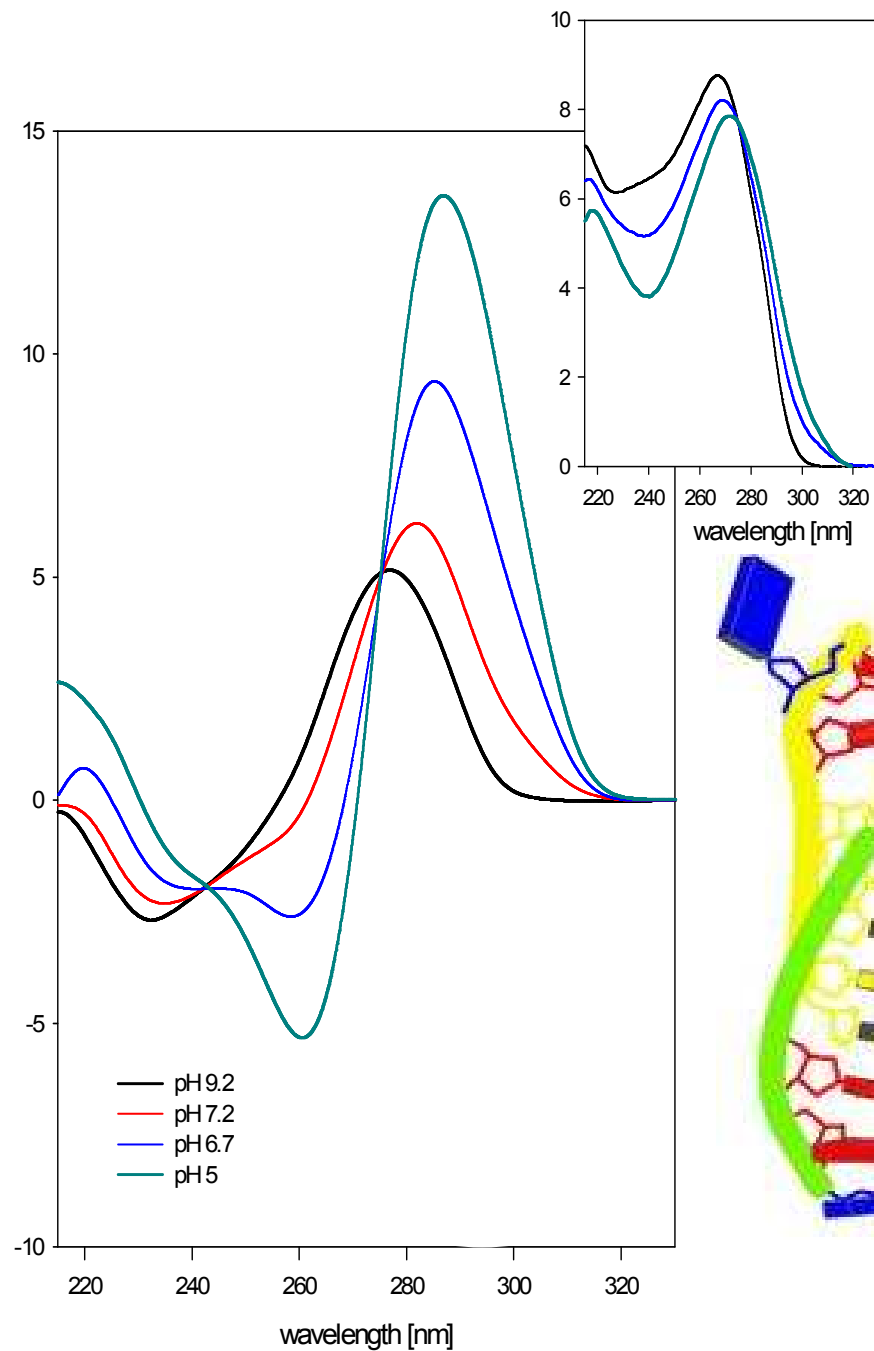

CD spectra reflecting formation of a parallel and antiparallel guanine quadruplex

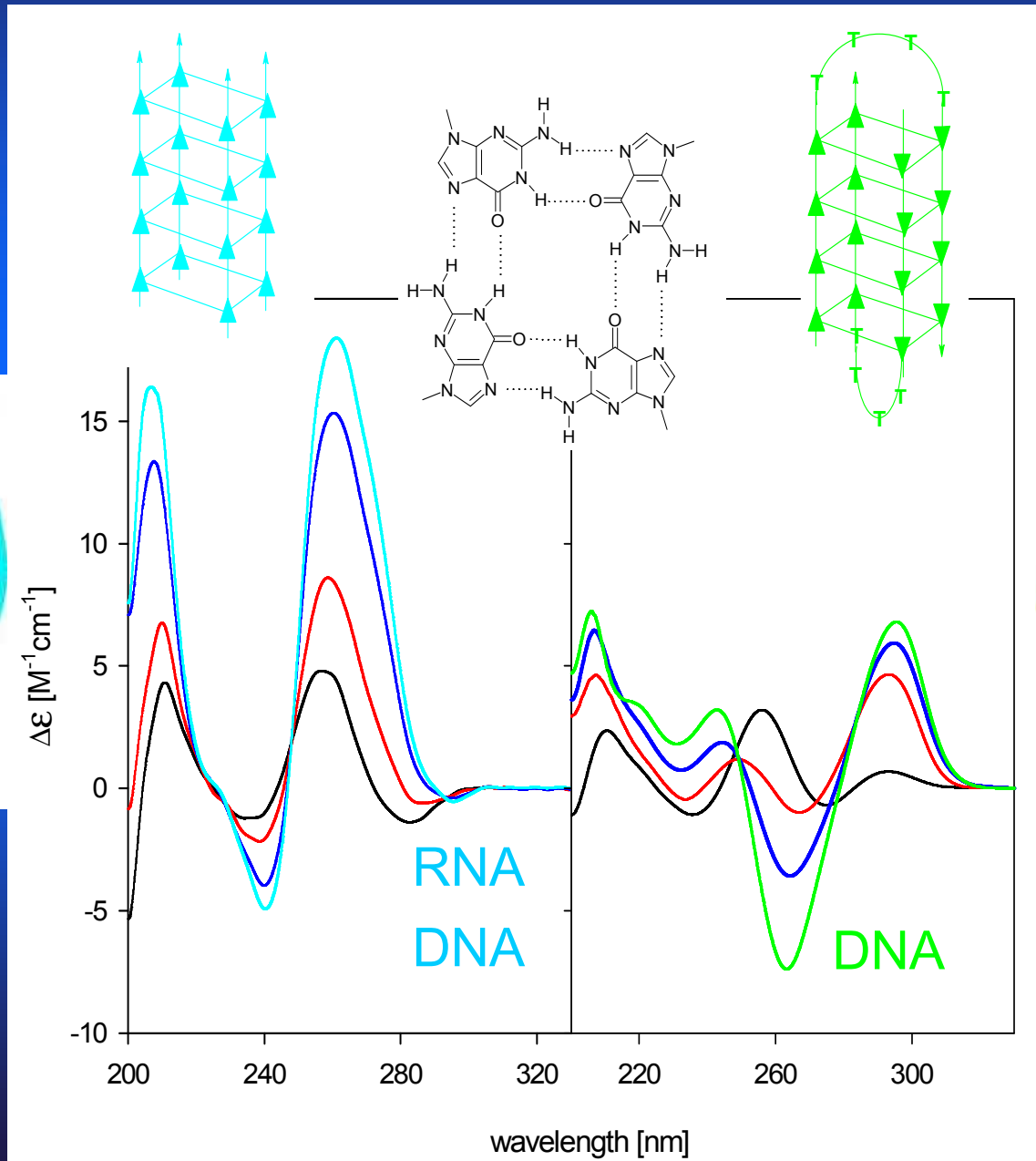

Fragment Pu-27 promotoru c-myc:

TGGGGAGGGGTGGGGAGGGGTGGGGGAAGG

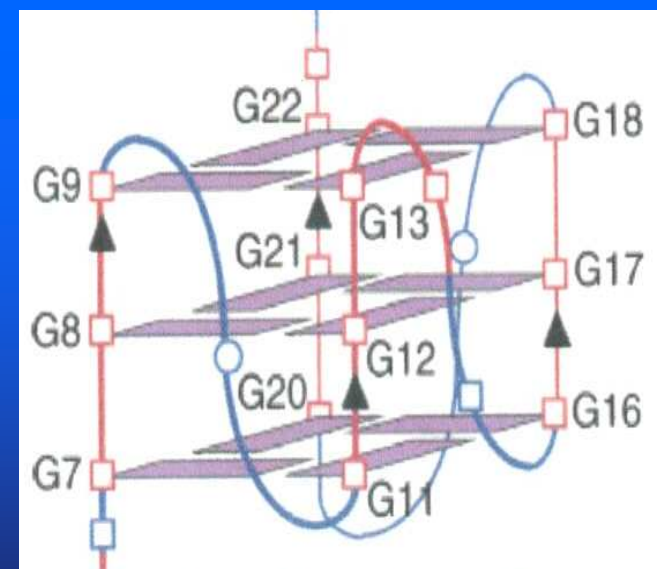
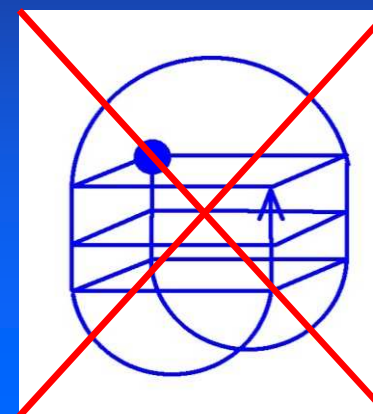
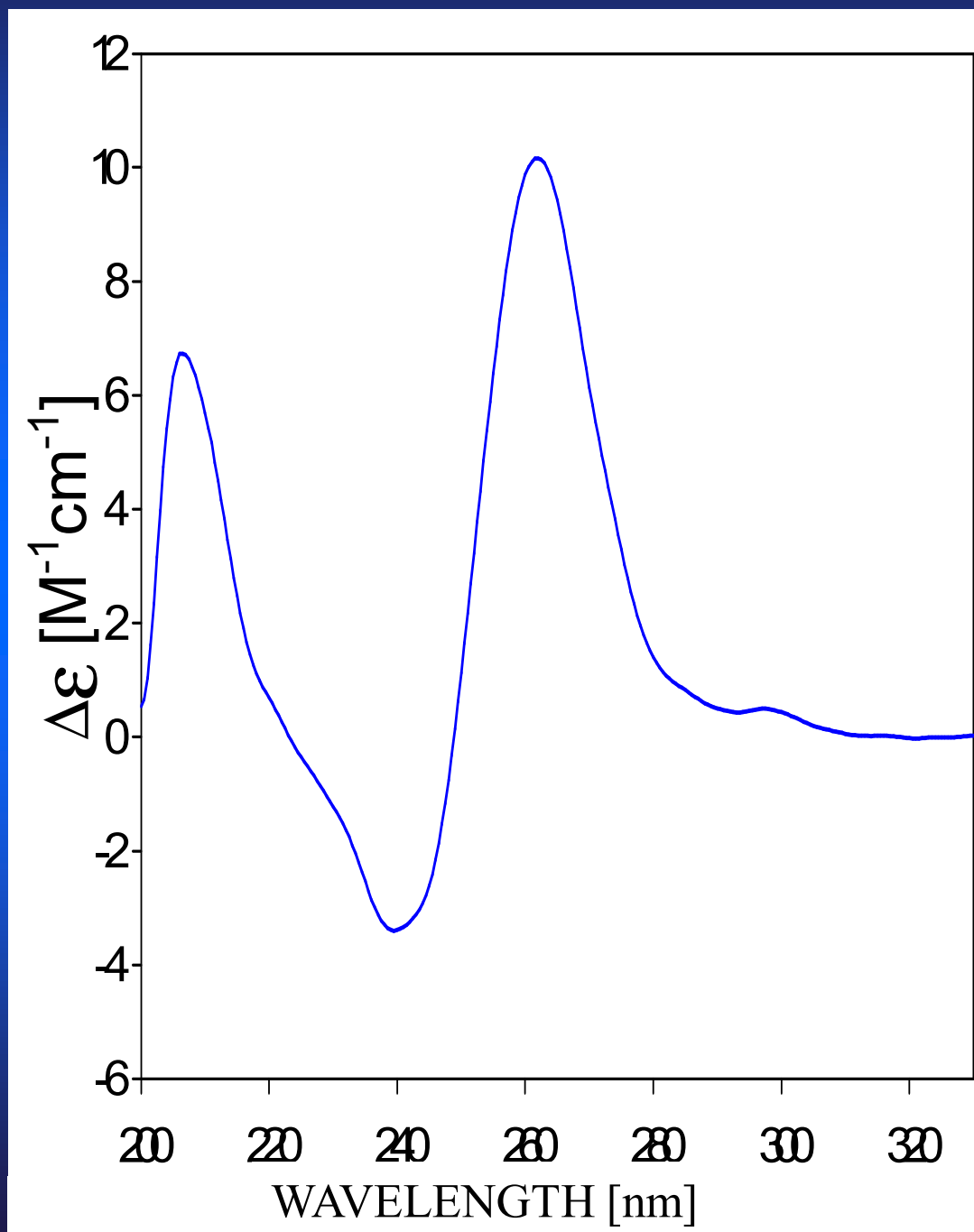

Pan, A.T. et al.:
J. Am. Chem. Soc. **126**(2004)8710

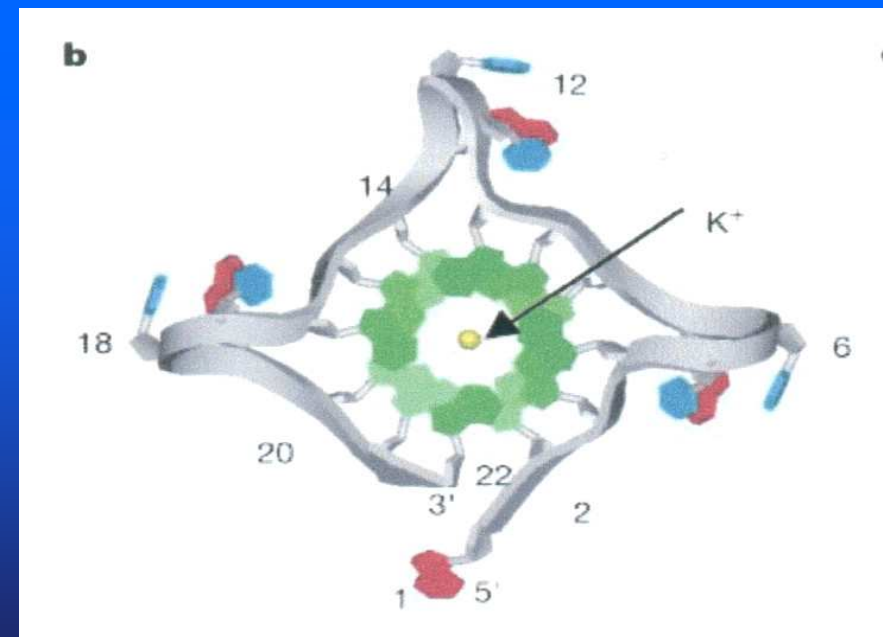
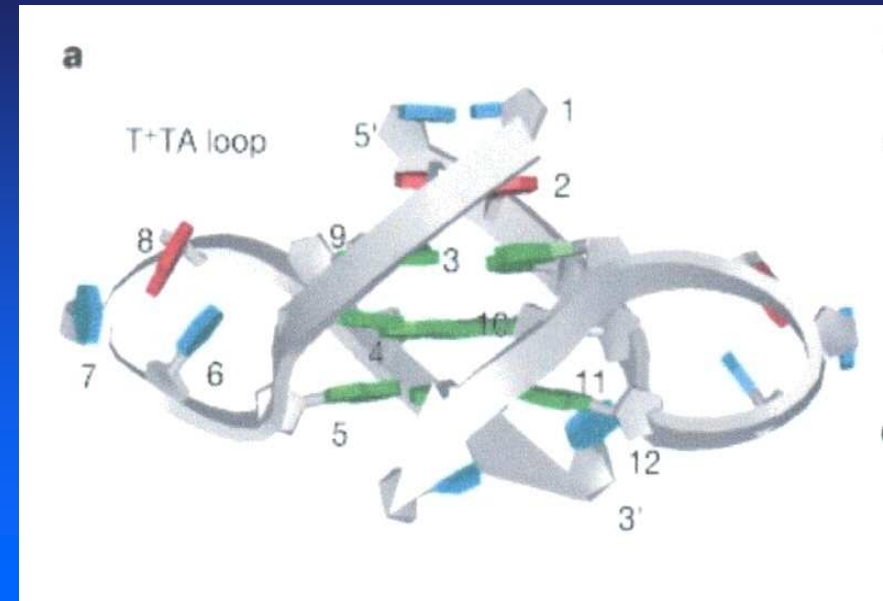
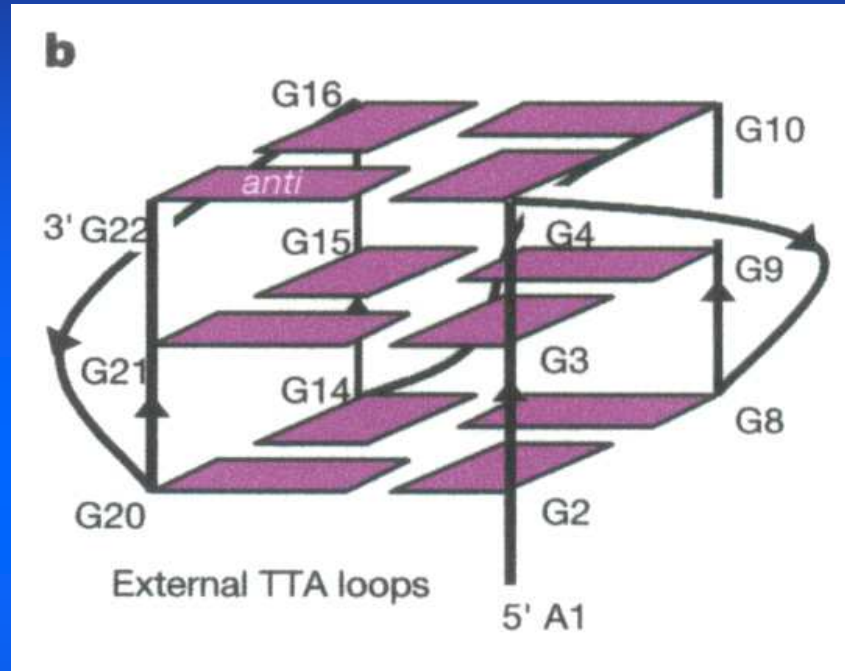

Parkinson, G.N., Lee, M.P.H., Neidle, S.
Nature **417** (2002) 876-880.

Human telomeric DNA forms quadruplex

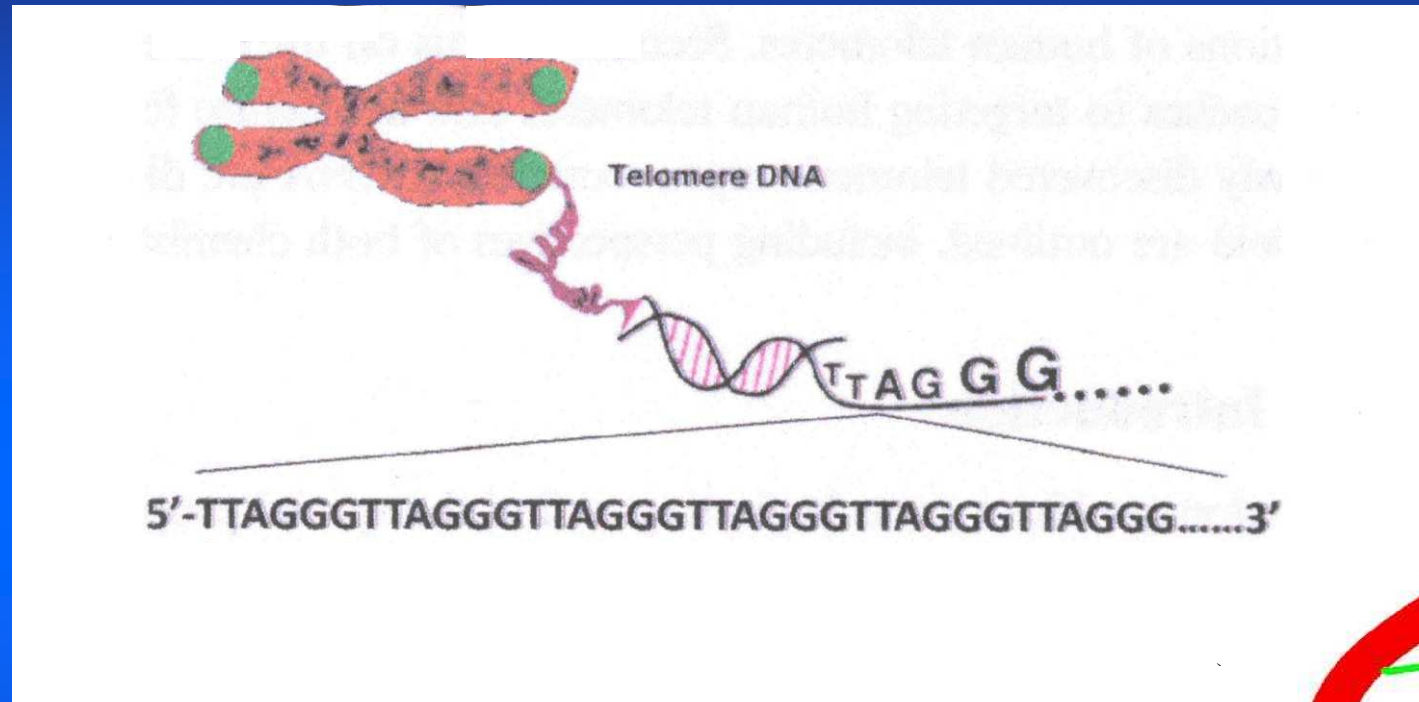

Telomeric DNA is associated with aging

The telomere quadruplex became a target for developing anticancer drugs



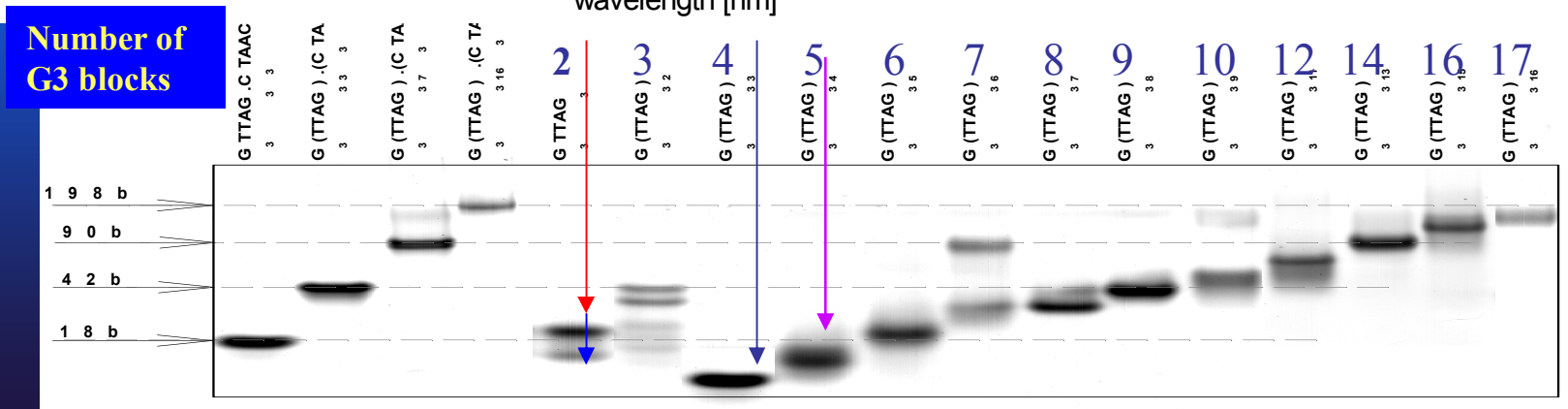
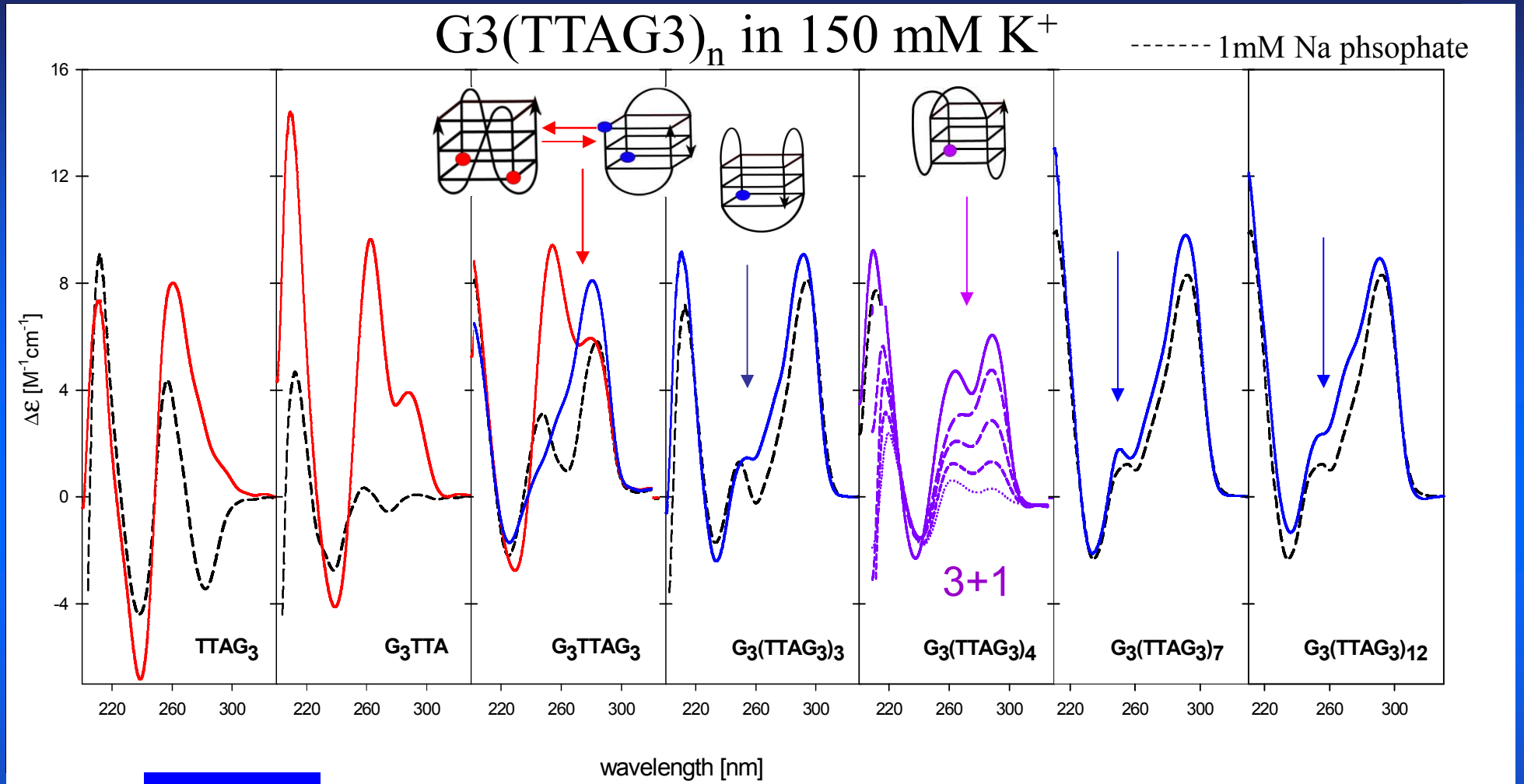

3 + 1

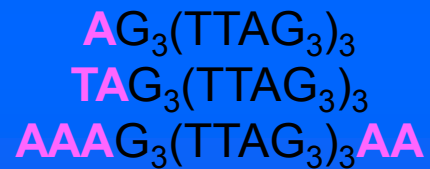
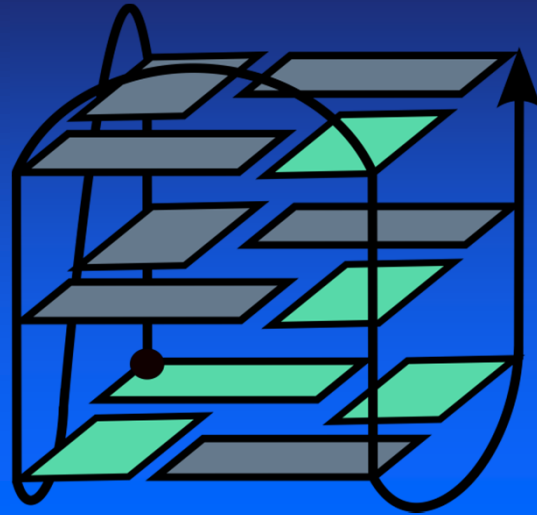

K^+

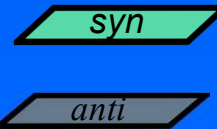

3 + 1



- Luu, K.N., Phan, A.T., Kuryavyi, V., Lacroix, L., Patel, D.J. (2006) *J.Am.Chem.Soc.*, 128, 9963-9970.
- Ambrus, A., Chen, D., Dai, J., Bialis, T., Jones, R.A., Yang, D. (2006) *Nucleic Acids Res.* 34, 2723-2735.

- Phan, A. T., Luu, K.N., Patel, D.J. (2006) *Nucleic Acids Res.*, 34, 5715-5719.

How does the structure of the long telomere DNA look like?

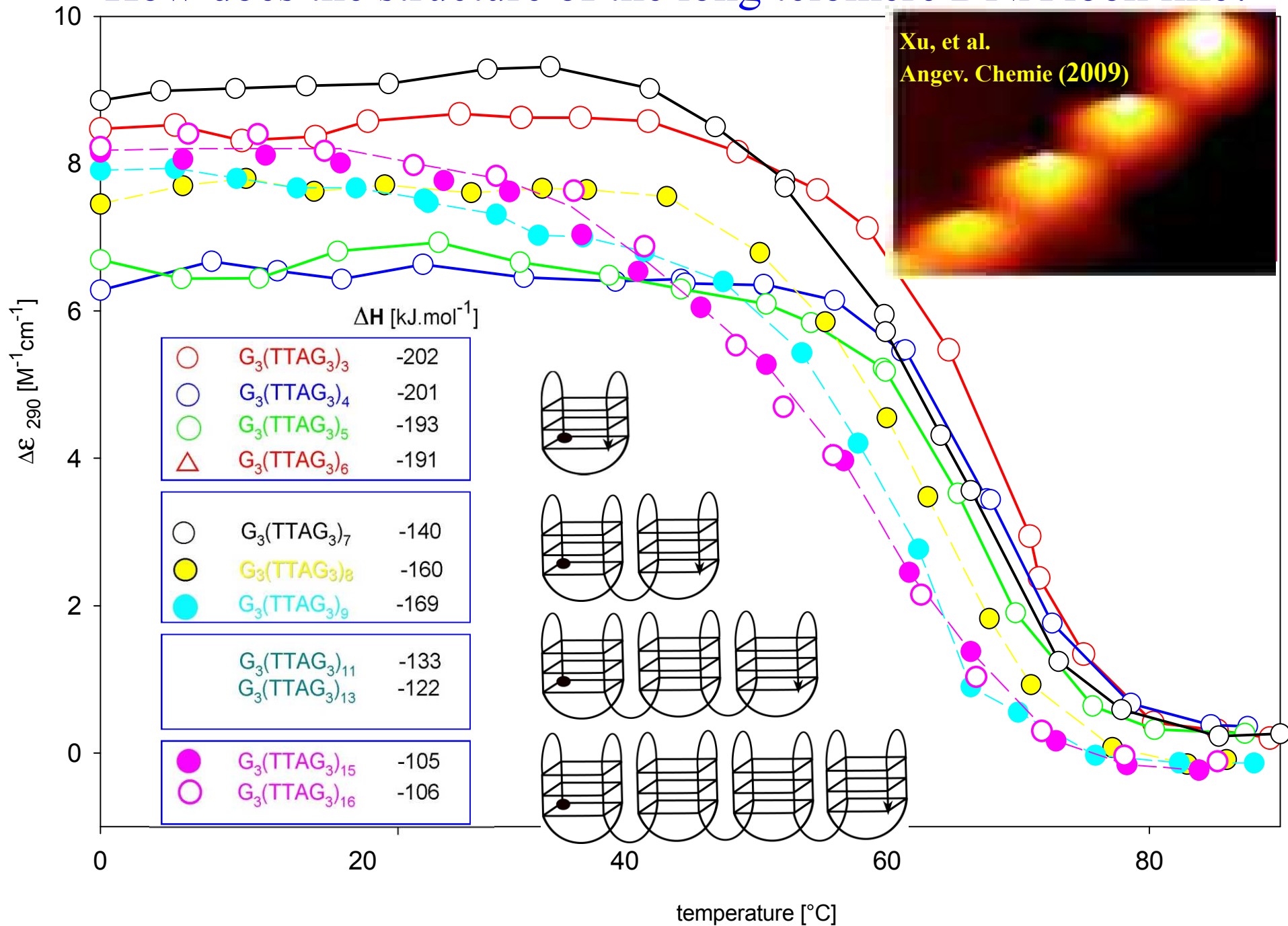

3 + 1



$AG_3(TTAG_3)_3$

$TAG_3(TTAG_3)_3$

$AAAG_3(TTAG_3)_3AA$

Luu, et al.: J.Am.Chem.Soc.,
128 (2006) 9963-9970.

Ambrus, et al.: Nucleic Acids
Res. 34 (2006) 2723-2735.

3 + 1



$TAG_3(TTAG_3)_3TT$

Phan, et al.: Nucleic
Acids Res. 34 (2006)
5715-5719.

BASKET
two tetrads

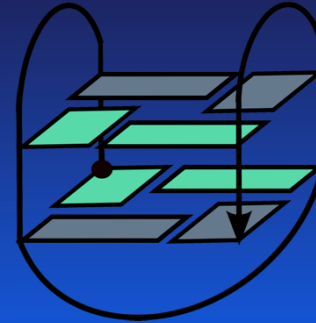

$G_3(TTAG_3)_3T$

Lim, et al.: J.Am.Chem.Soc.
131 (2009) 4301-4309.

CHAIR



$AG_3(TTAG_3)_3$

He et al.: Nucleic Acids Res. 32 (2004)
5359-5367.

Matsugami, et al.: Nucleic acids
symp. series, 50 (2006) 45-46.

Xu et al.: Bioorg. & Medicinal Chem.
14 (2006) 5584 - 5591.

K⁺

0.2-5 mM strand concentration in NMR
3-50 μ M strand concentration in CD

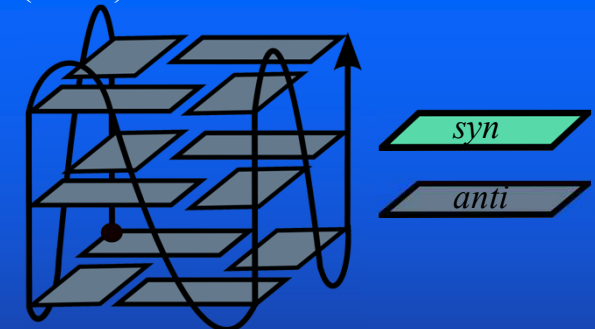

PARALLEL

BASKET

Parkinson, Lee, Neidle: $AG_3(TTAG_3)$
Nature 417 (2002) 876-880.

Different quadruplex structures of human telomere DNA sequence were observed by various methods

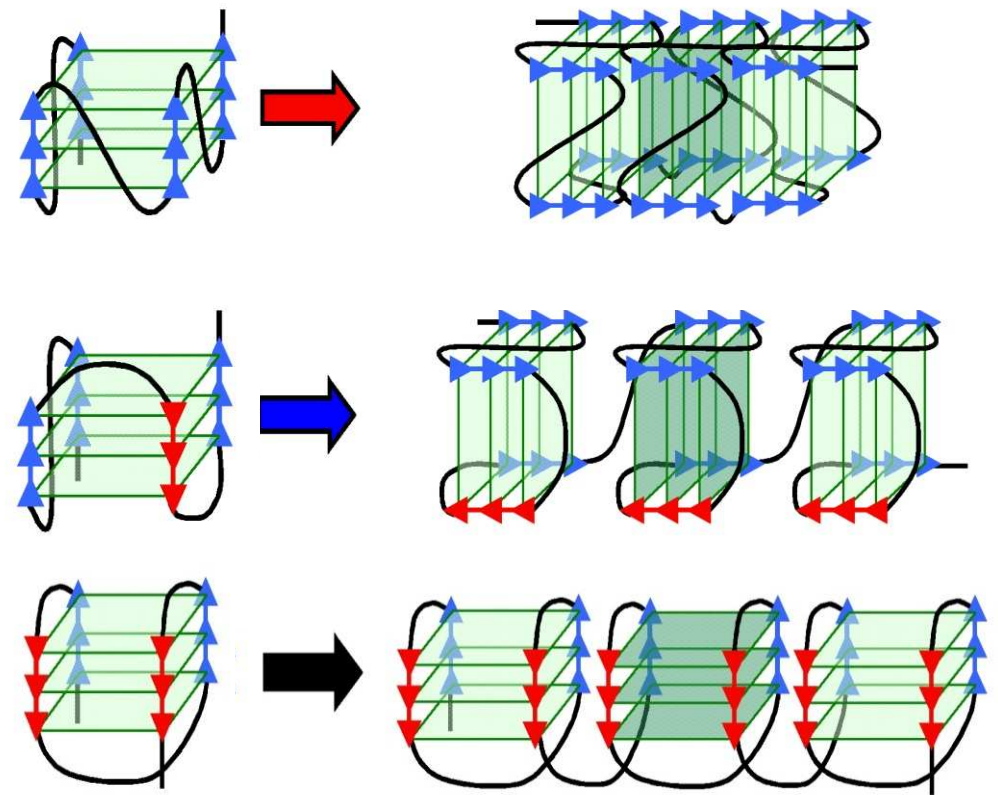
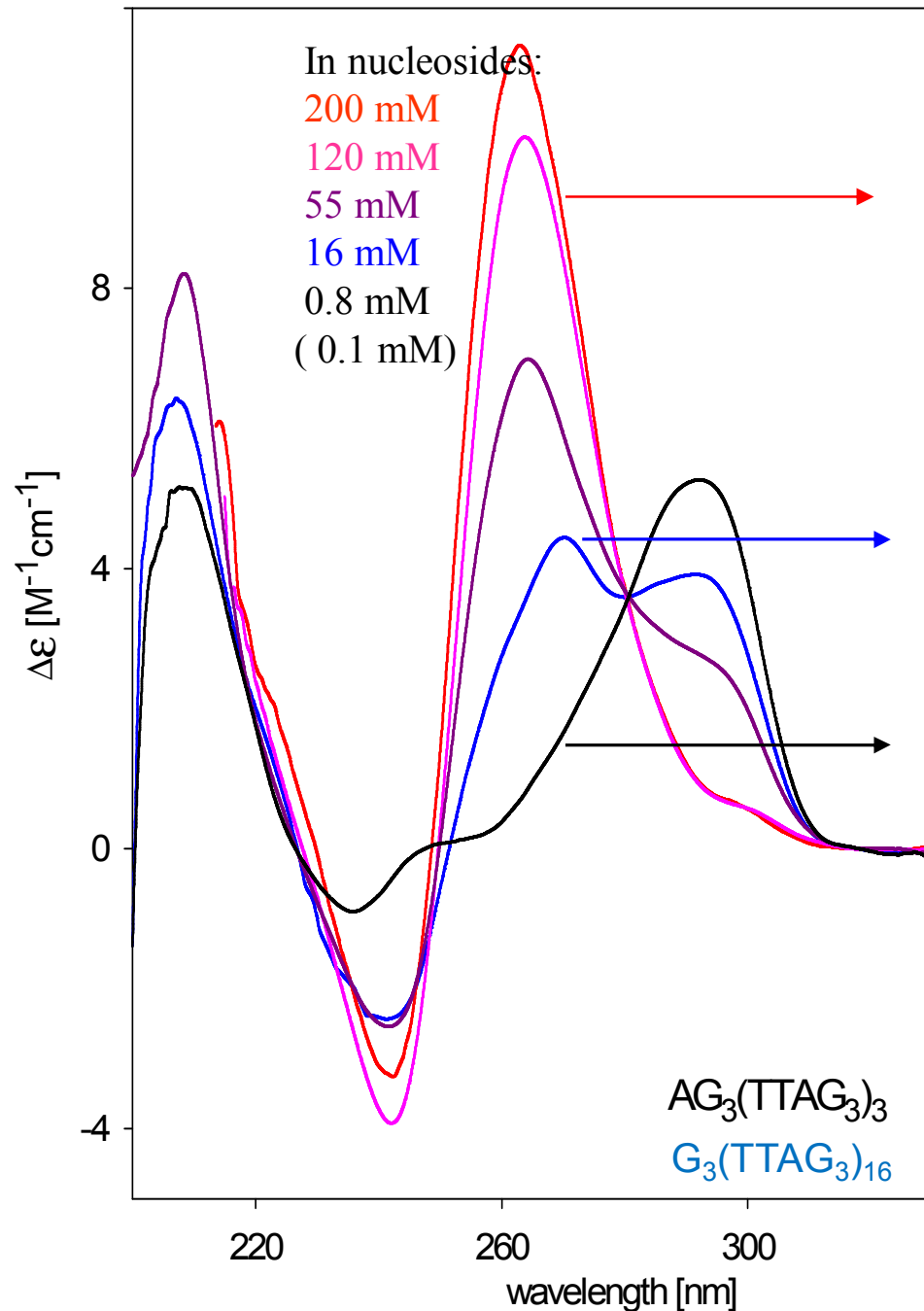

The arrangement of the human telomere quadruplex is polymorphic and depends on DNA concentration. The particular structures may perform distinct functions.

CHIROPTICKÉ METODY

Optická rotační disperze-ORD

Závislost úhlu stočení roviny polarizace lineárně polarizovaného světla průchodem opticky aktivní látkou na vlnové délce procházejícího záření. (180-800 nm)

Cirkulární dichroismus-CD

Závislost rozdílu absorpce pro vlevo a vpravo kruhově polarizované světlo na vlnové délce absorbovaného záření v oblasti energií elektronových přechodů. (180-1000 nm)

Infračervený cirkulární dichroismus-IRCD (VCD)

Závislost rozdílu absorpce pro vlevo a vpravo kruhově polarizované světlo na vlnové délce absorbovaného záření v oblasti energií vibračních přechodů. (1-5 μm)

Fluorescenčně detegovaný cirkulární dichroismus-FDCD

Závislost rozdílu intenzity fluorescence, excitované vlevo a vpravo kruhově polarizovaným světlem na vlnové délce excitačního záření. (~ 200 nm až vlnová délka emise)

Cirkulárně polarizovaná luminiscence (emise)-CPL (CPE)

Spektrální průběh rozdílu intenzit (spontánní) emise vlevo a vpravo cirkulárně polarizovaného světla. (Interval vlnových délek emise chromoforu)

Cirkulární diferenciální Ramanův rozptyl-Raman CID

Spektrální průběh rozdílu intenzit Ramanova rozptylu vlevo a vpravo kruhově polarizovaného dopadajícího záření. (Interval vlnových délek Ramanova jevu)

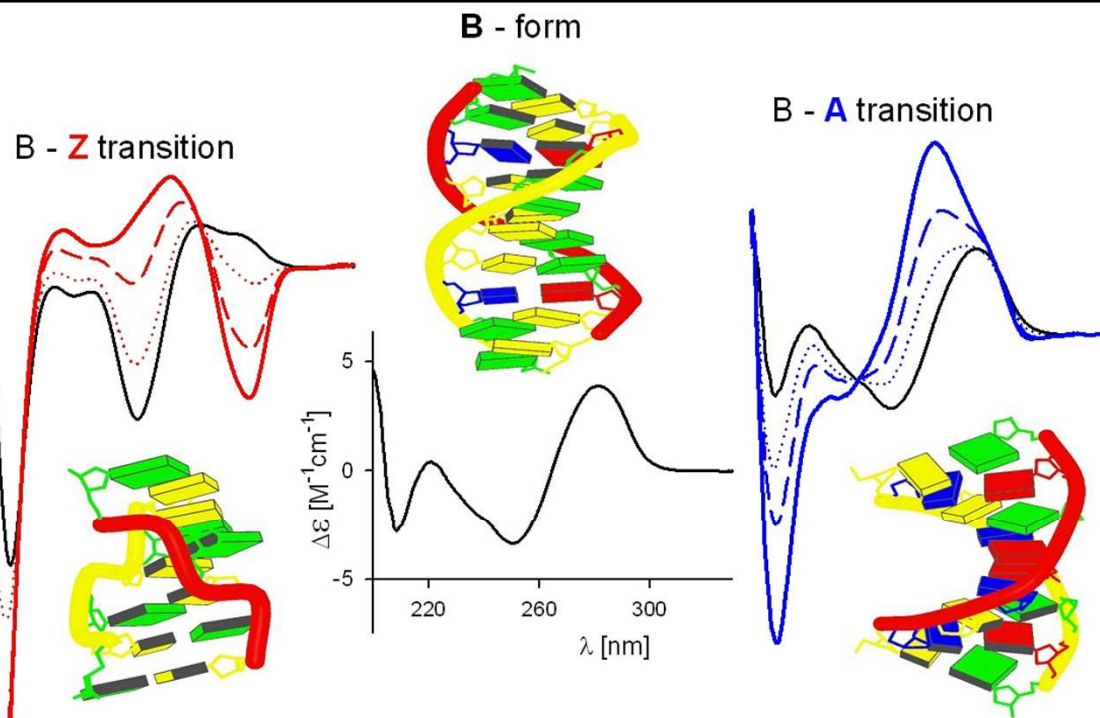

QUADRUPLEXES

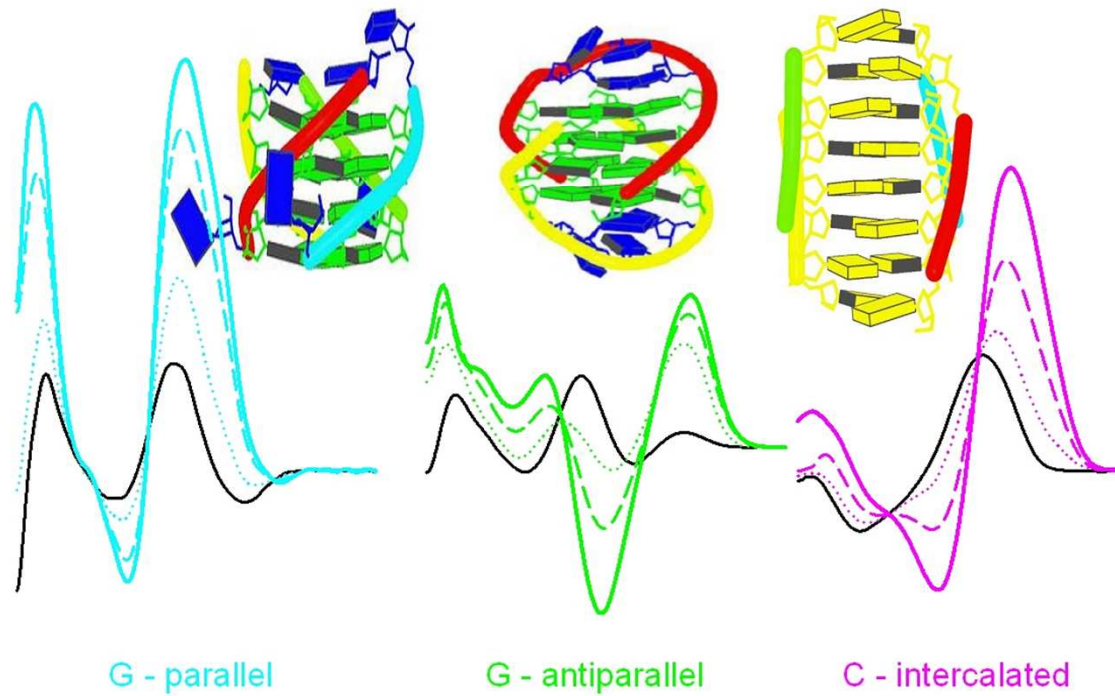

Kejnovska, I.,
 Renciuik, D.,
 Vorlickova, M.:
 Nucleic Acids
 Res. **37** (2009)
 1713-1725.

Laboratory of the CD spectroscopy of Nucleic Acids

Jaroslav Kypr
Iva Kejnovská
Jana Chládková
Petr Fojtík
Daniel Renčiuk
Klára Bednářová
Martin Tomaško
Petra Školáková
Helena Kašparová
Zuzana Dvořáková

