

Biochemie

Česká studijní literatura

- Zdeněk Vodrážka. *Biochemie*.
3. opr. vyd. Praha : Academia, 2007.
- Šípal, Zdeněk. *Biochemie*. 1. vyd. Praha : Státní pedagogické nakladatelství, 1992.
- Voet, Donald - Voet, Judith G. *Biochemie*.
Translated by Arnošt Kotyk. 1. vyd. Praha :
Victoria Publishing, 1995.

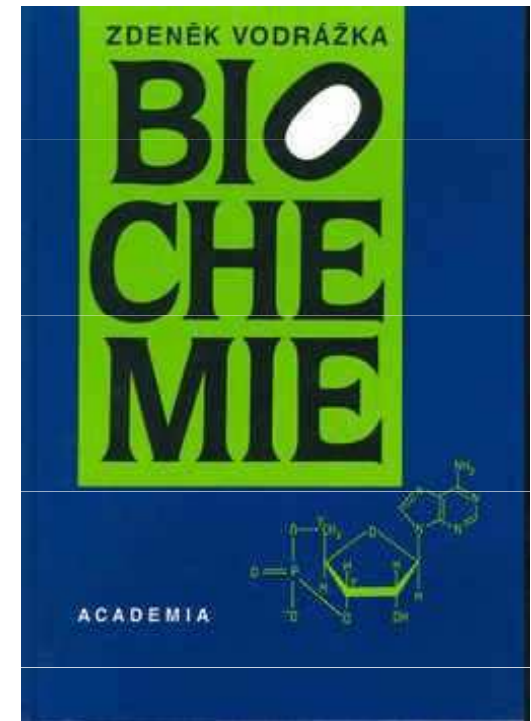

Biochemie

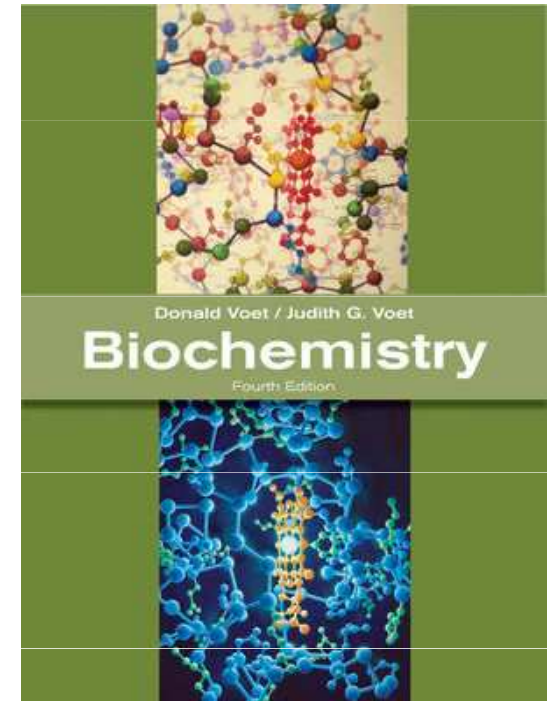

Anglická studijní literatura

- Voet, Donald - Voet, Judith G.
Biochemistry. 4th ed. Hoboken :
John Wiley & Sons, 2011
- Voet, Donald - Voet, Judith G. - Pratt, Charlotte
W. *Fundamentals of biochemistry :life at the
molecular level*. 3rd ed. Hoboken, N.J. : John
Wiley & Sons, 2008.
- Boyer, Rodney. *Concepts in biochemistry*. 2nd ed.
New York : John Wiley & Sons, 2002.

Biochemie

1. ÚVOD

2. BÍLKOVINY - Struktura, vlastnosti a funkce

3. NUKLEOVÉ KYSELINY - Struktura, vlastnosti a funkce

4. SACHARIDY - Struktura, vlastnosti a funkce

5. LIPIDY - Struktura, vlastnosti a funkce

6. ENZYMOLOGIE

7. METABOLISMUS A BIOENERGETIKA

8. METABOLISMUS SACHARIDŮ

9. FOTOSYNTÉZA

10. METABOLISMUS LIPIDŮ

11. METABOLISMUS BÍLKOVIN

12. REGULACE BIOCHEMICKÝCH PROCESŮ

13. MOLEKULÁRNÍ FYZIOLOGIE

14. XENOBIOCHEMIE

Zkouška z biochemie

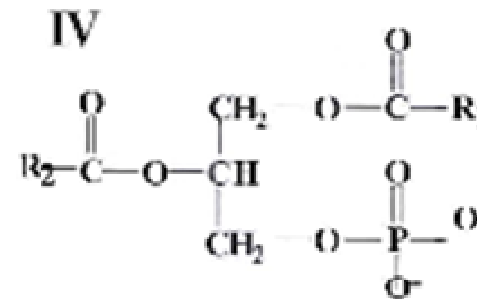
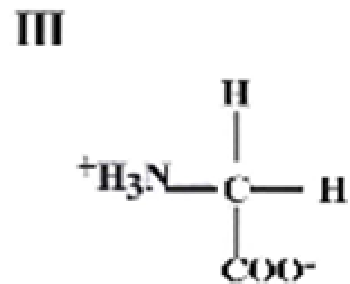
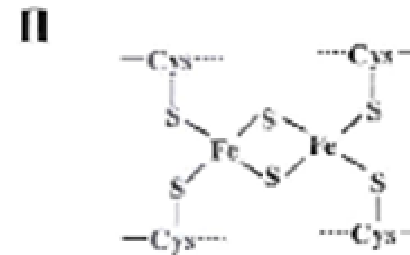
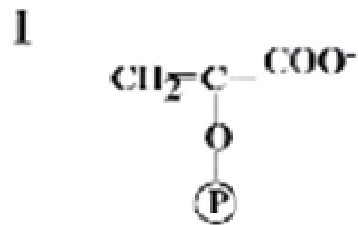

1. Metody purifikace bílkovin
2. Kinetika jednosubstrátové enzymové reakce
3. Biosyntéza mastných kyselin

Biochemie

- chemická disciplína, která studuje chemické složení živé hmoty a chemické procesy, které v ní probíhají
- je hraniční vědní disciplínou, na pomezí mezi chemií a biologií, zkoumá biologické objekty chemickými metodami

Historický úvod

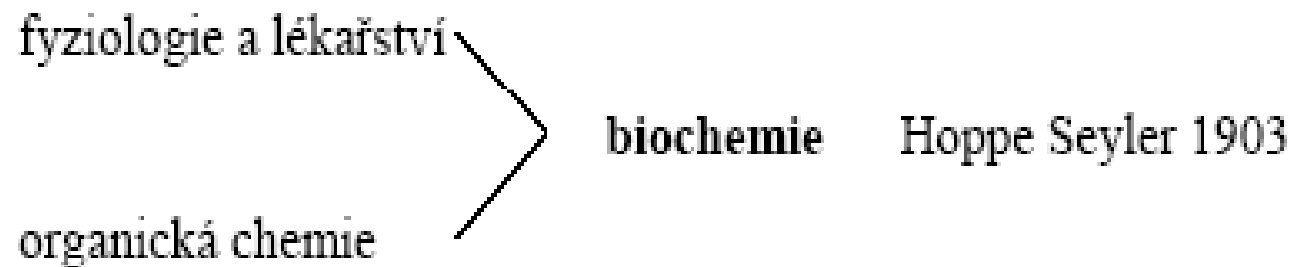

Synonyma : Biological Chemistry
Physiologische Chemie

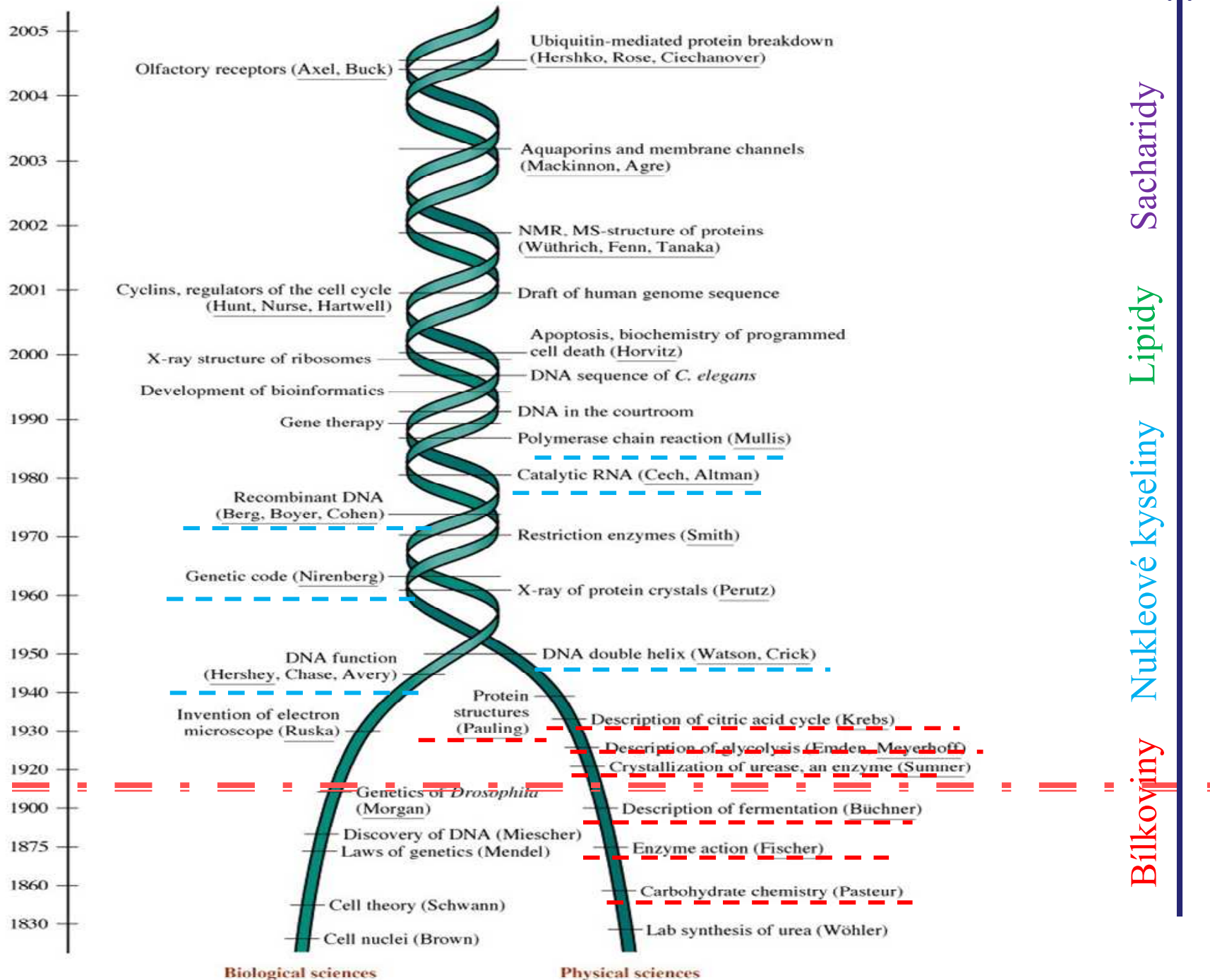
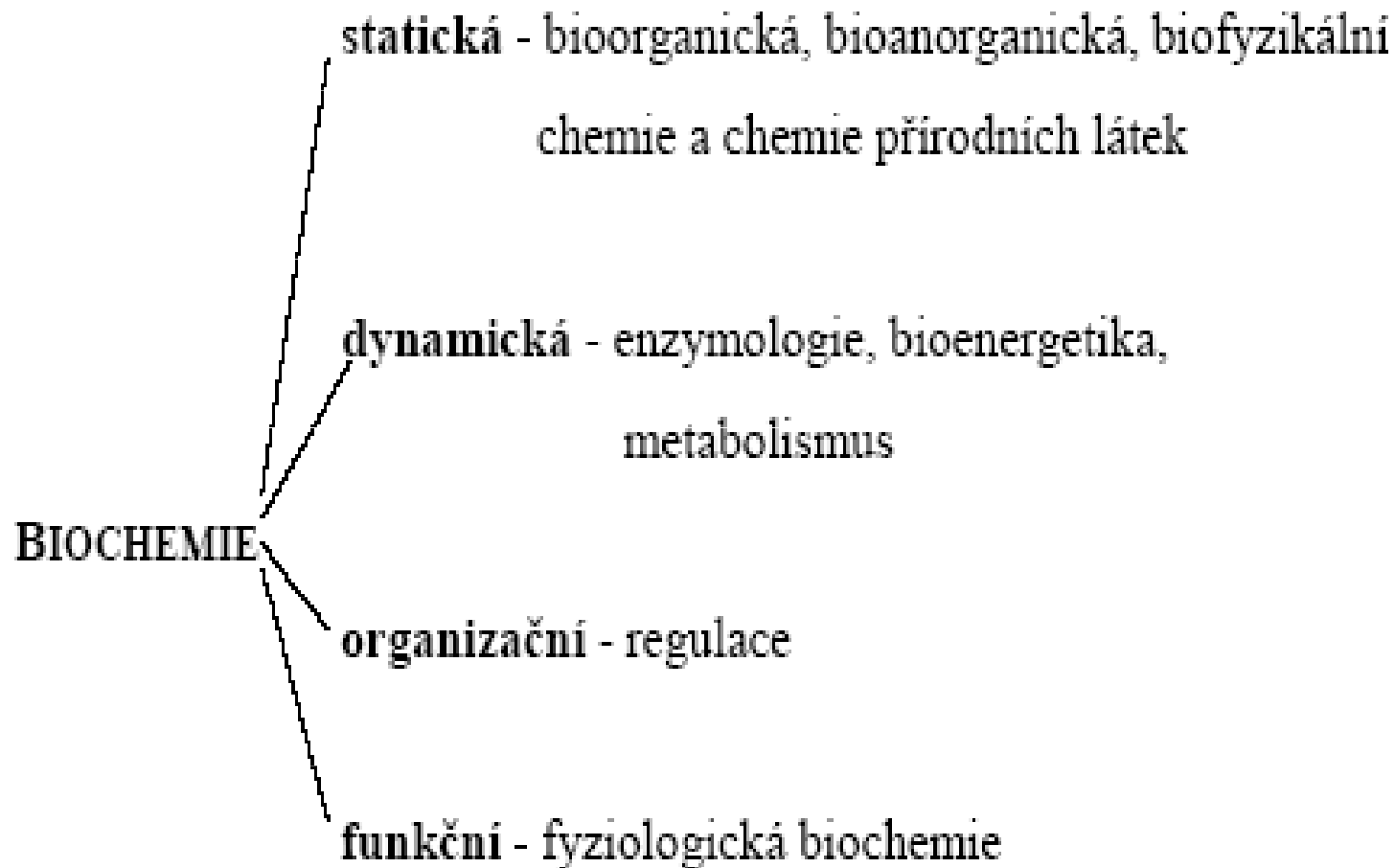
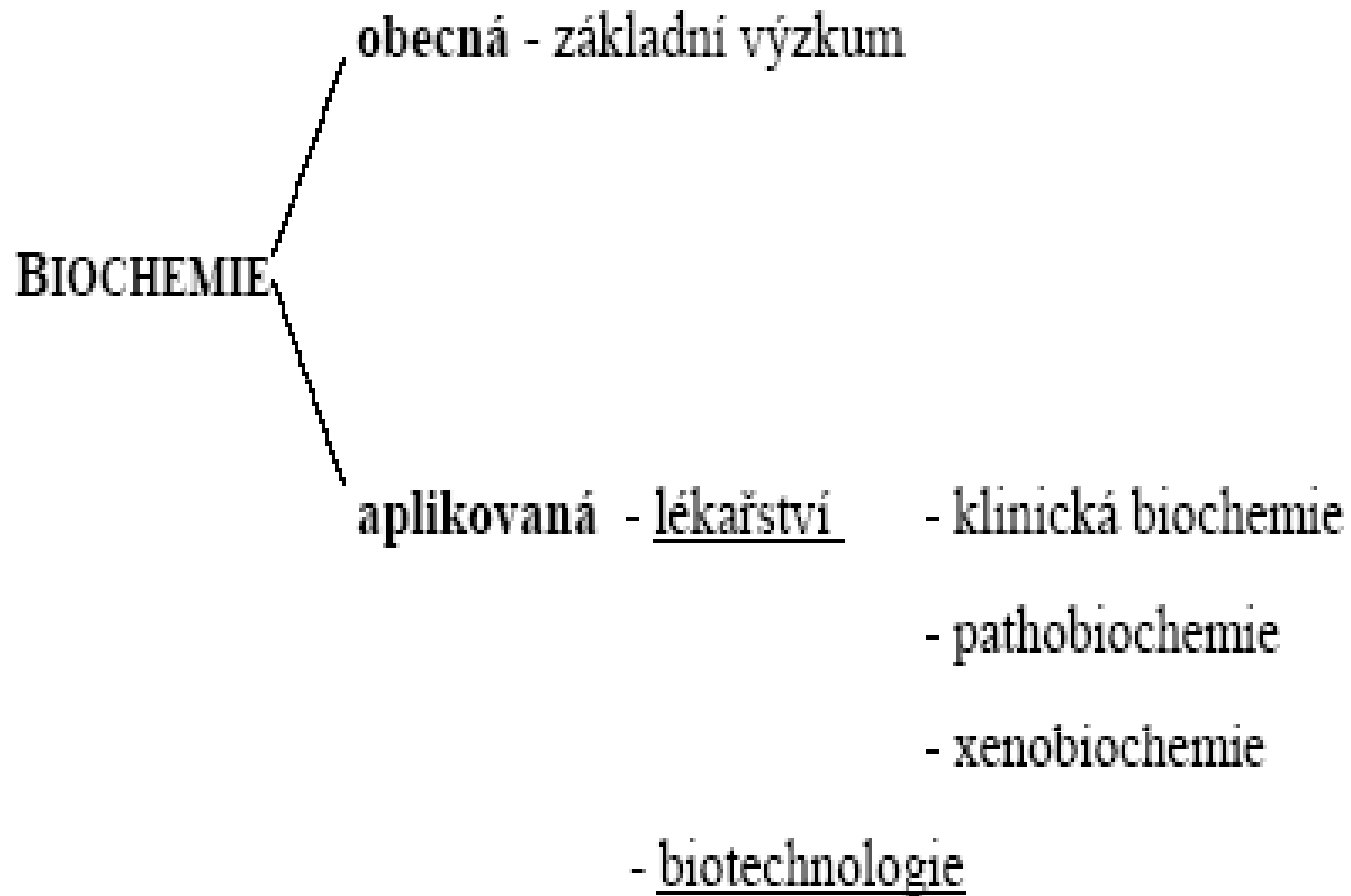

Figure 1-2 Concepts in Biochemistry, 3/e
 © 2006 John Wiley & Sons

Dvě období : A. období statické biochemie

B. období dynamické biochemie





Molekulární biologie - W.T. ASTBURY - 60.léta

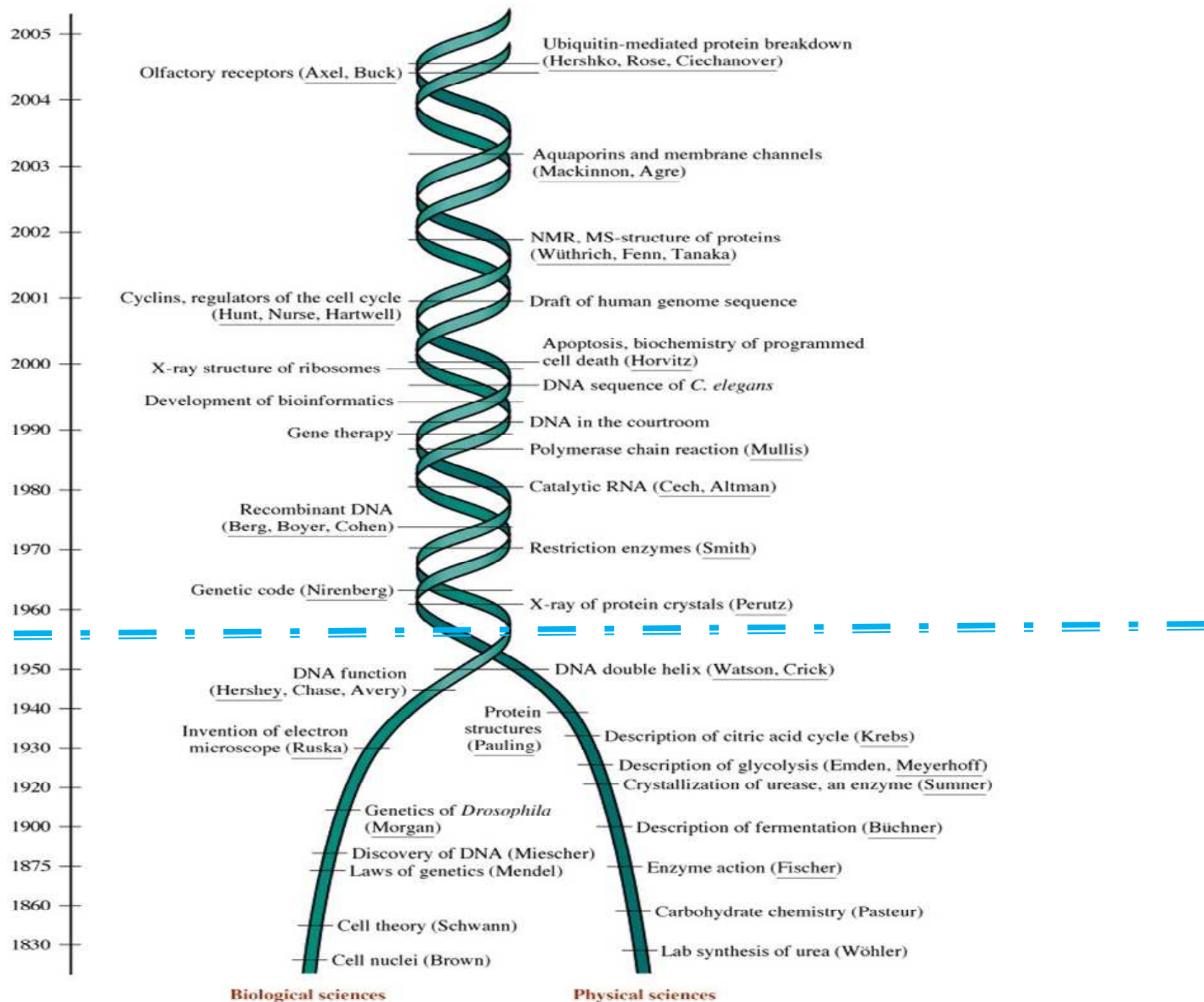
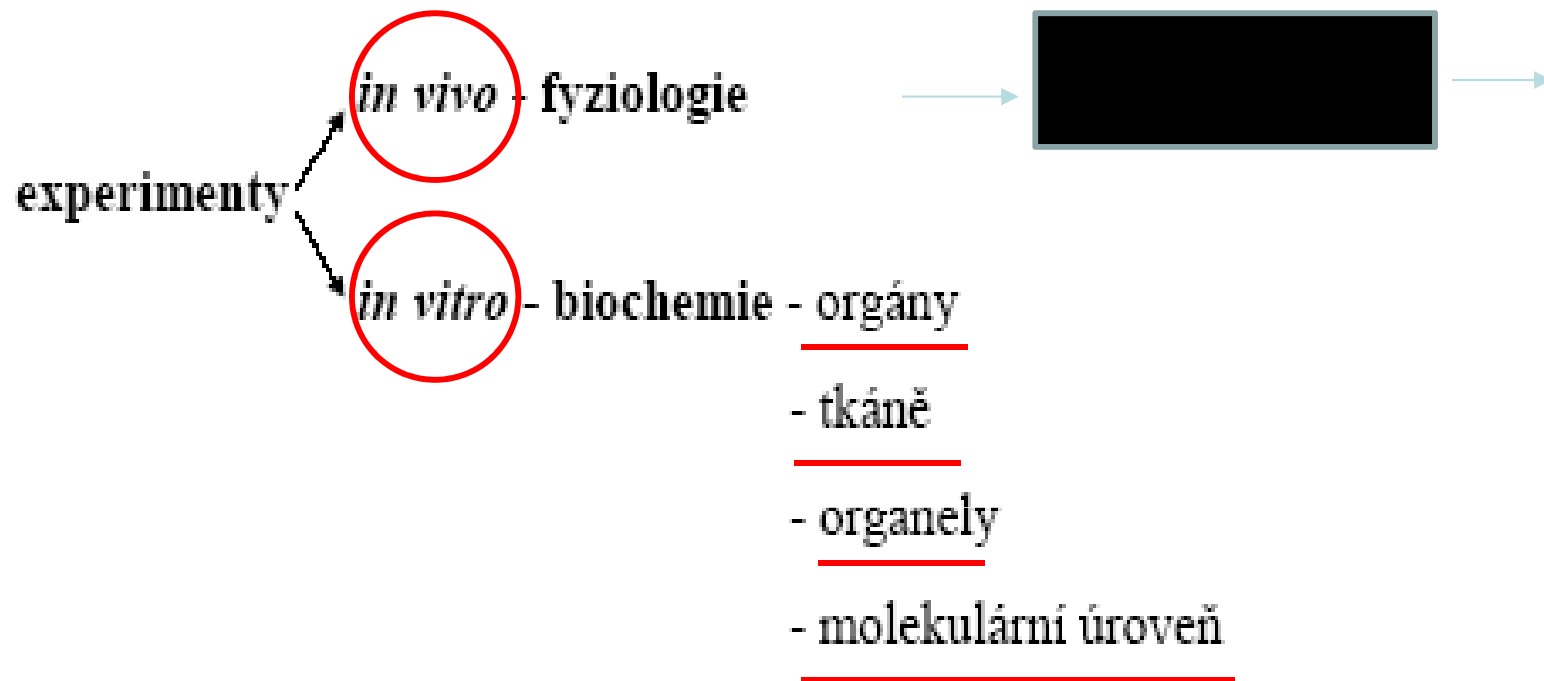

Figure 1-2 Concepts in Biochemistry, 3/e
 © 2006 John Wiley & Sons

Biochemické metody :



Biochemické metody - metody anorganické, organické, fyzikální a analytické chemie

- biologické metody

Problémy se vzorkem - práce s komplexními vzorky

- práce s labilním biologickým materiálem
- práce s malým množstvím látek

**P. Anzenbacher, J. Kovář - Metody chemického výzkumu pro
biochemiky - Dočasná vysokoškolská
učebnice 1986**

**M. Ferenčík, B. Škárka - Biochemické laboratorné metody, SNTL
1981**

Literatura

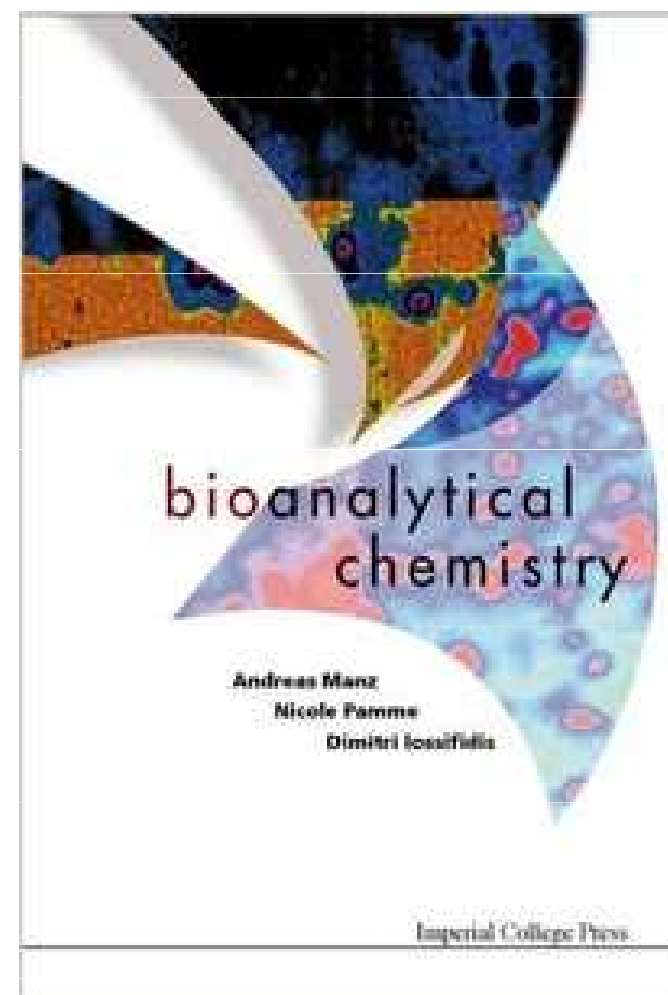
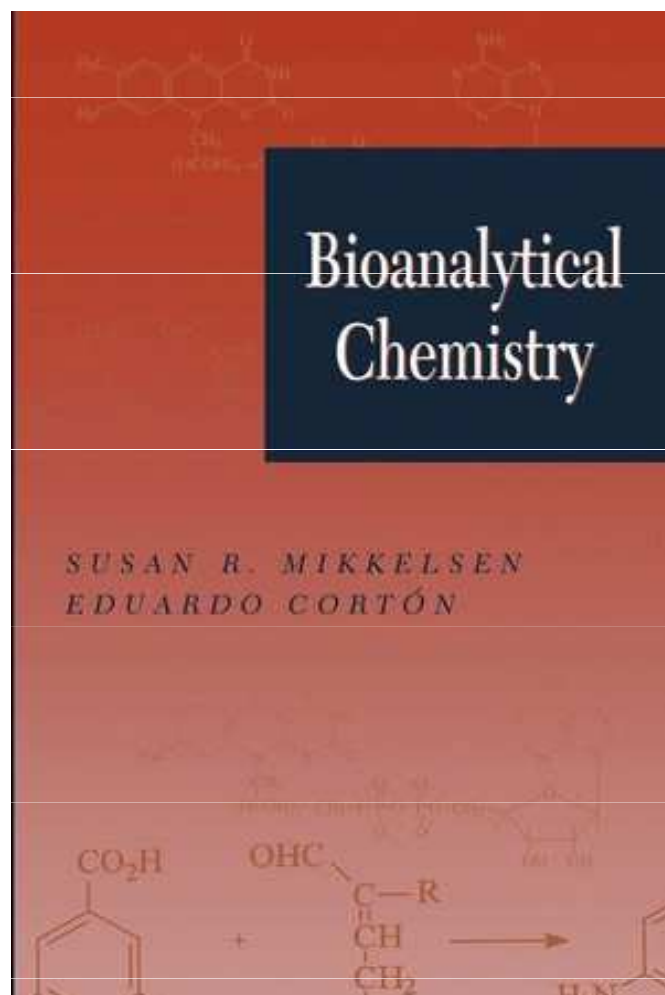
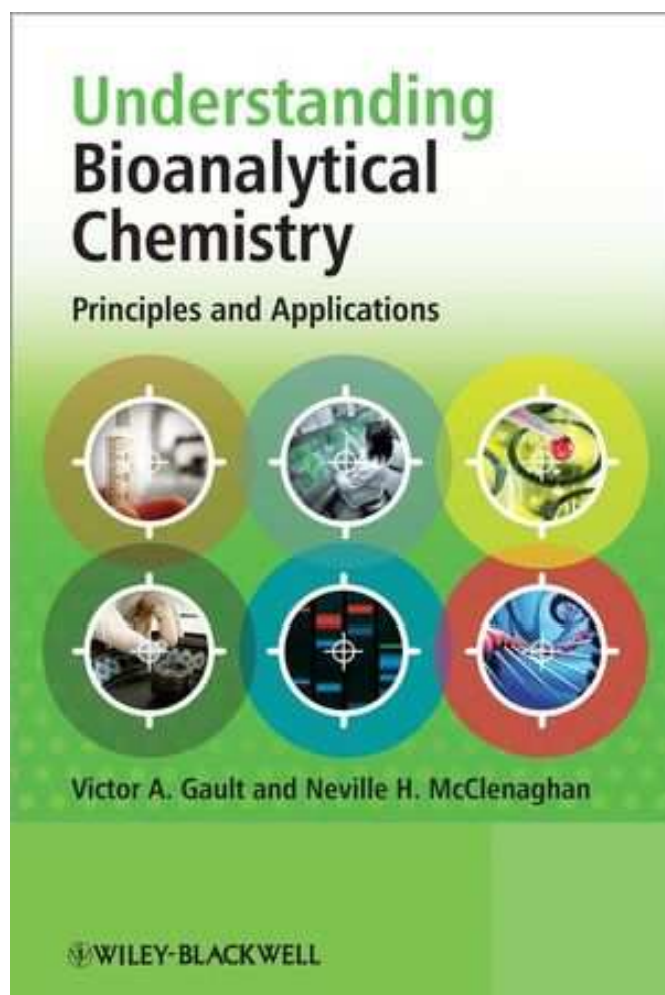

Látkové složení

	Group IA	Group IIA	TRANSITION METALS										Group IIIB	Group IVB	Group VB	Group VIB	Group VIIB	Group 0
Period 1	1 H hydrogen																	2
Period 2	3	4											5 B boron	6 C carbon	7 N nitrogen	8 O oxygen	9 F fluorine	10
Period 3	11 Na sodium	12 Mg magnesium											13 Al aluminum	14 Si silicon	15 P phosphorus	16 S sulfur	17 Cl chlorine	18
Period 4	19 K potassium	20 Ca calcium	21	22	23 V vanadium	24 Cr chromium	25 Mn manganese	26 Fe iron	27 Co cobalt	28 Ni nickel	29 Cu copper	30 Zn zinc	31 Ga gallium	32	33 As arsenic	34 Se selenium	35 Br bromine	36
Period 5						42 Mo molybdenum						48 Cd cadmium					53 I iodine	
Period 6						74 W tungsten												
Period 7																		

Figure 1-3 Concepts in Biochemistry, 3/e
© 2006 John Wiley & Sons

Prvkové složení vesmíru, zemské kůry a člověka

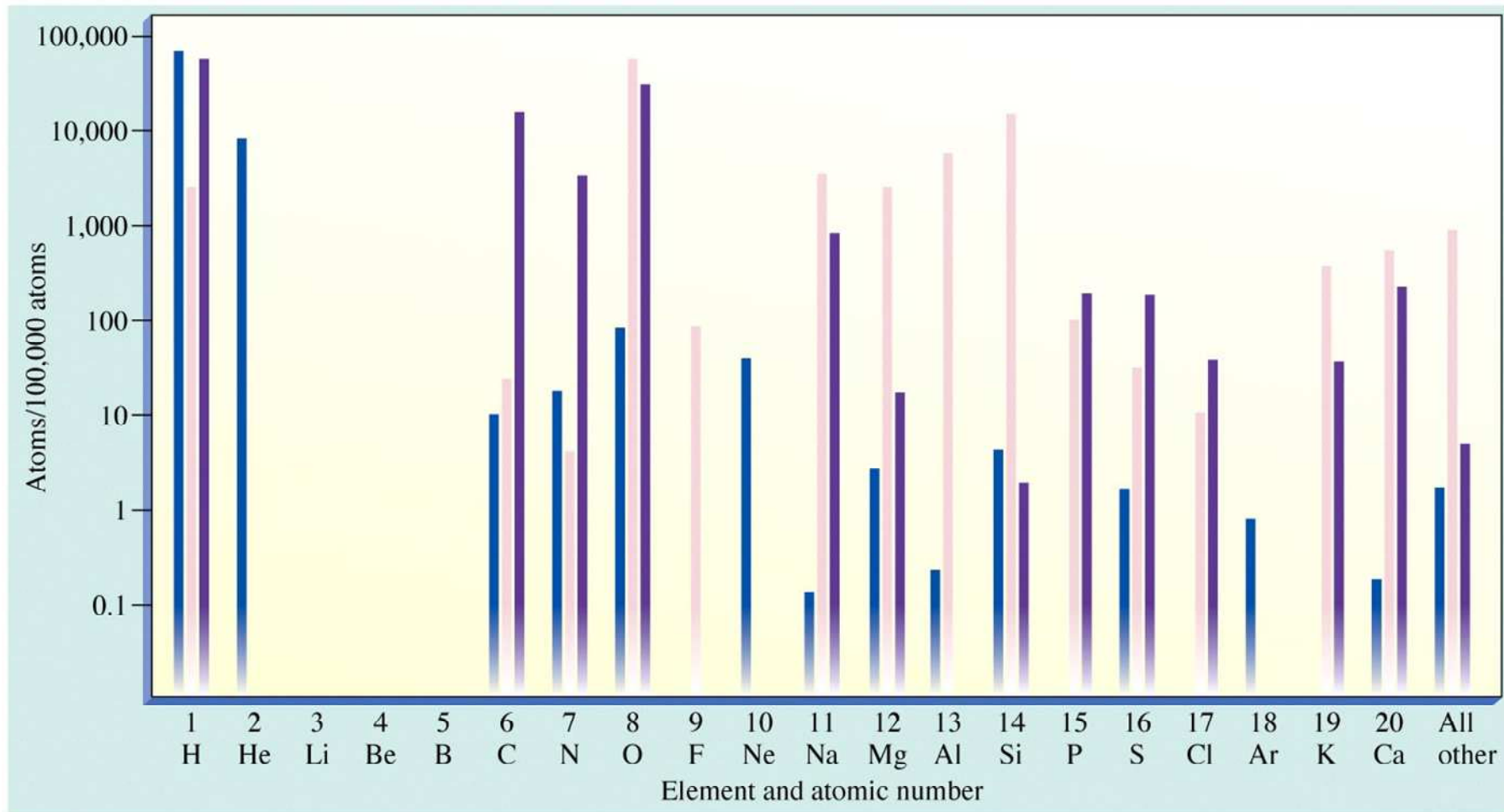

Figure 1-4 Concepts in Biochemistry, 3/e
© 2006 John Wiley & Sons

LÁTKOVÉ SLOŽENÍ ORGANISMŮ

Látka	člověk	rostliny	bakterie
voda	60	75	70
bílkoviny	18	4	15
nukleové k.	1.5	1	7
sacharidy	0.5	16	3
lipidy	16	1	2
org. látky	1	1	2
anorg. látky	3	2	1

Anorganické látky - voda

- Na, K, Cl⁻, SO₄⁻, HCO₃⁻, HPO₄²⁻,

Ca, Mg, Fe, Zn, Va, Cu, Mo, Ni, Mn, Se

- plyny - O₂, N₂, CO₂, NO

Organické látky - vysokomolekulární - biopolymery

- bílkoviny

- nukleové kyseliny

- sacharidy

- lipidy

Voda

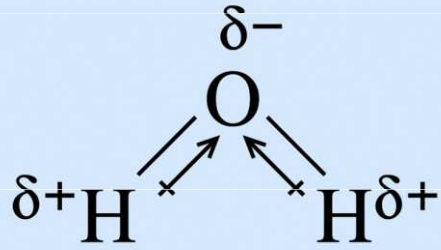
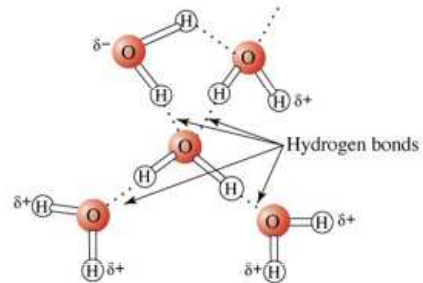
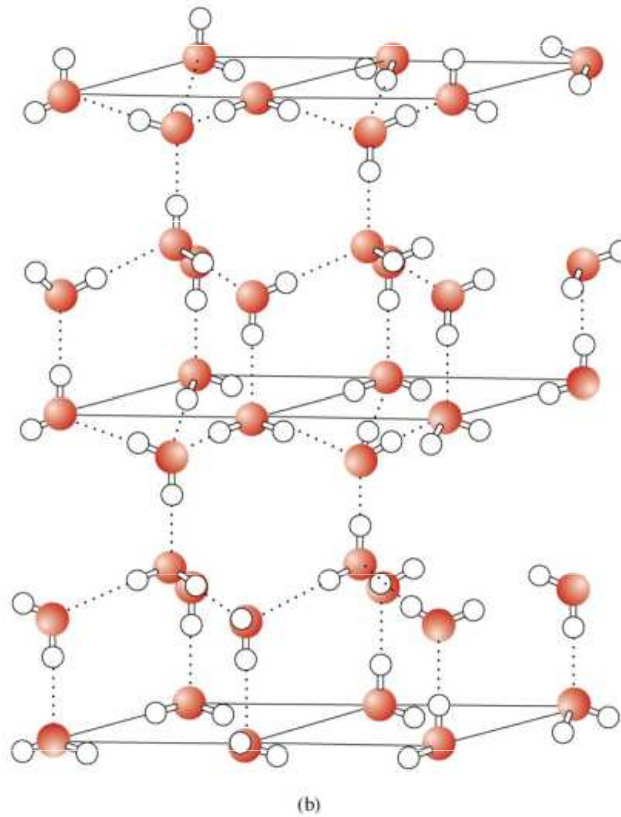
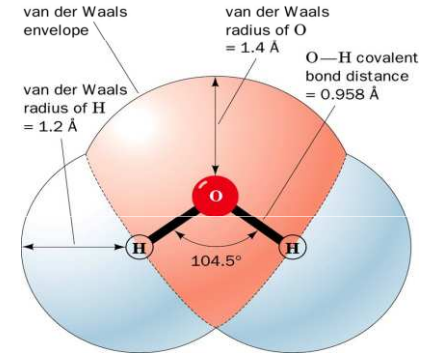

Figure 2-1b Concepts in Biochemistry, 3/e
© 2006 John Wiley & Sons



(a)

Figure 2-5 Concepts in Biochemistry, 3/e
© 2006 John Wiley & Sons

Voda

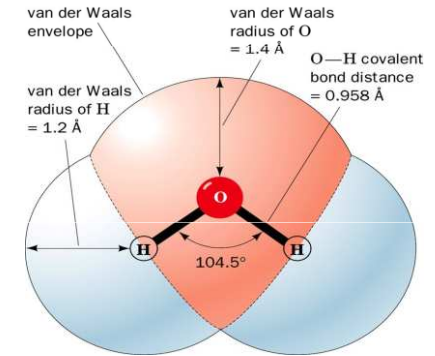
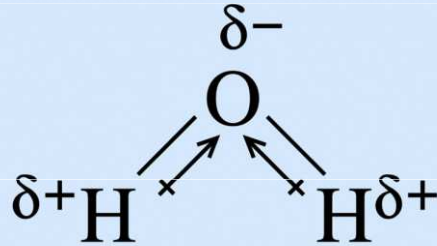

Figure 2-1b Concepts in Biochemistry, 3/e
© 2006 John Wiley & Sons

Table 2.3

A comparison of some physical properties of water with hydrides of other nonmetallic elements: N, C, and S

Property	H ₂ O	NH ₃	CH ₄	H ₂ S
Molecular weight	18	17	16	34
Boiling point (°C)	100	-33	-161	-60.7
Freezing point (°C)	0	-78	-183	-85.5
Viscosity ^a	1.01	0.25	0.10	0.15

^aUnits are centipoise.

Table 2-3 Concepts in Biochemistry, 3/e
© 2006 John Wiley & Sons

Voda

- Na vodu vázán vznik života
- Je rozpouštědlo
- Má transportní funkci
- Účastní se chemických reakcí
- Udržuje stálost vnitřního prostředí –I, pH, T

Anorganické látky

- Na, K, Cl⁻, SO₄⁻, HCO₃⁻, HPO₄²⁻,

Ca, Mg, Fe, Zn, Va, Cu, Mo, Ni, Mn, Se

- plyny - O₂, N₂, CO₂, NO

5 %

Organické látky

- vysokomolekulární - biopolymery

- bílkoviny

- nukleové kyseliny

- sacharidy

- lipidy

95 %

**S
u
š
i
n
a**

Obecný princip výstavby biopolymerů :

1. Jsou tvořeny monomery
2. Monomery vytvářejí lineární řetězce
3. Monomery jsou spojovány jediným typem vazby

mono, di-, tri- , tetra-,....

oligo < 10

poly > 10

	bílkoviny	nukleové kyseliny	polysacharidy
monomery	aminokyseliny 20	nukleotidy 4	monosacharidy 5
vazba	peptidická	3,5-diesterová	glykosidická

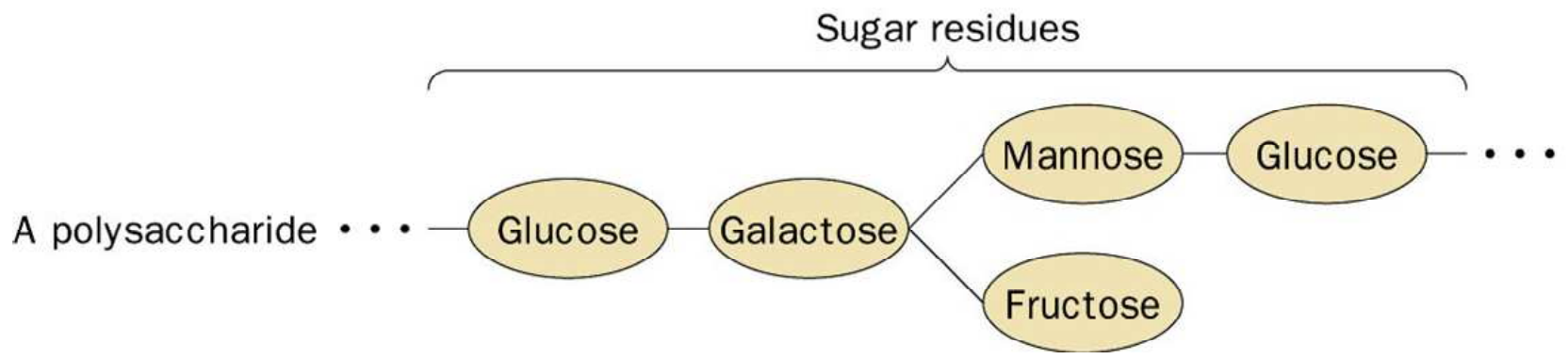
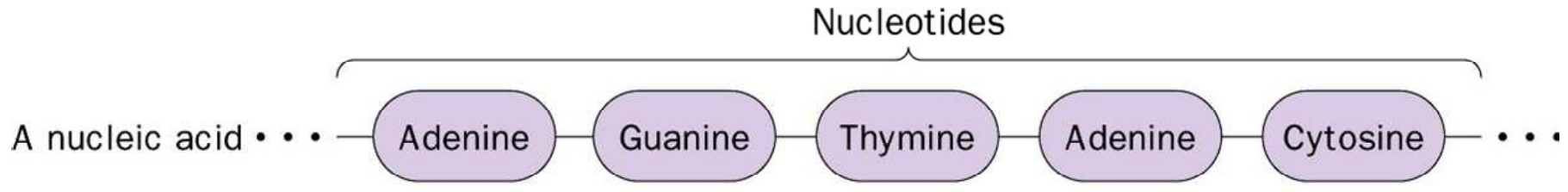
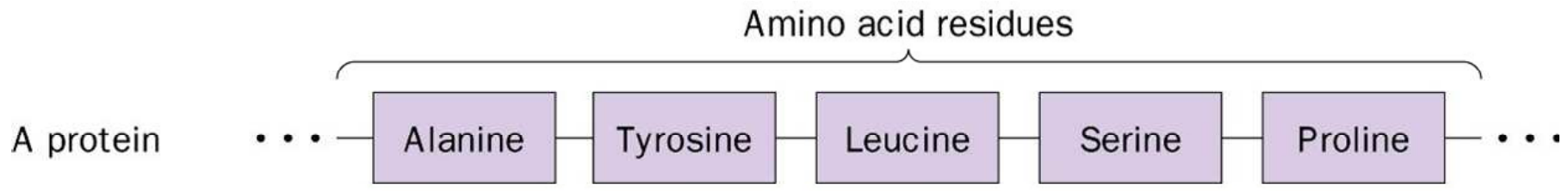

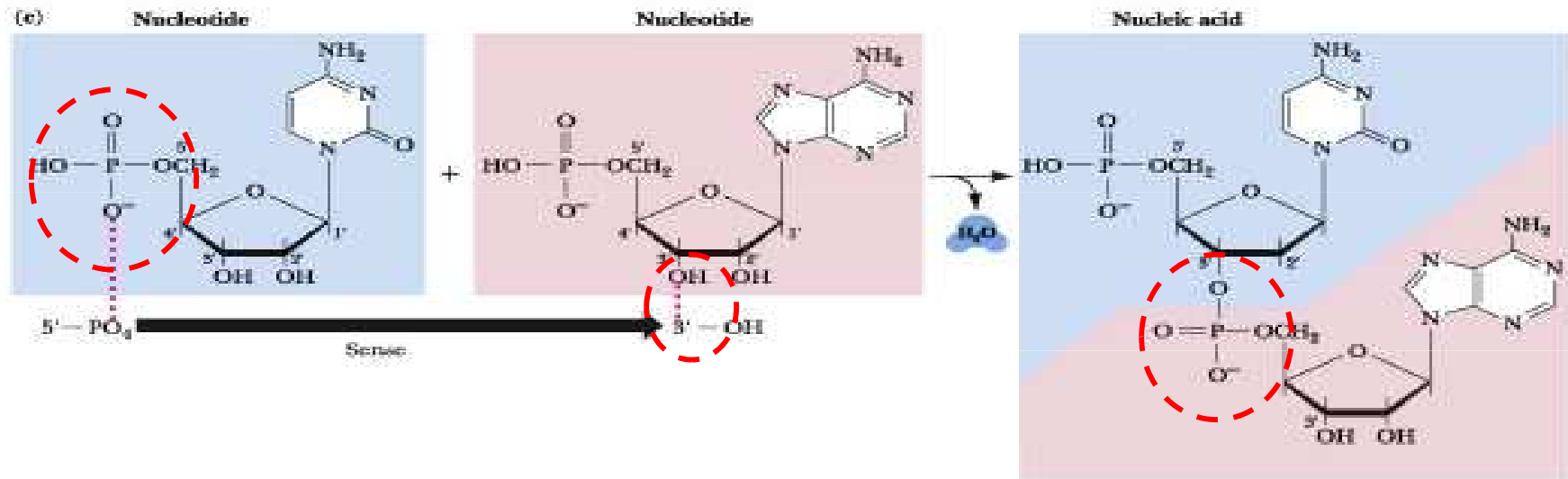
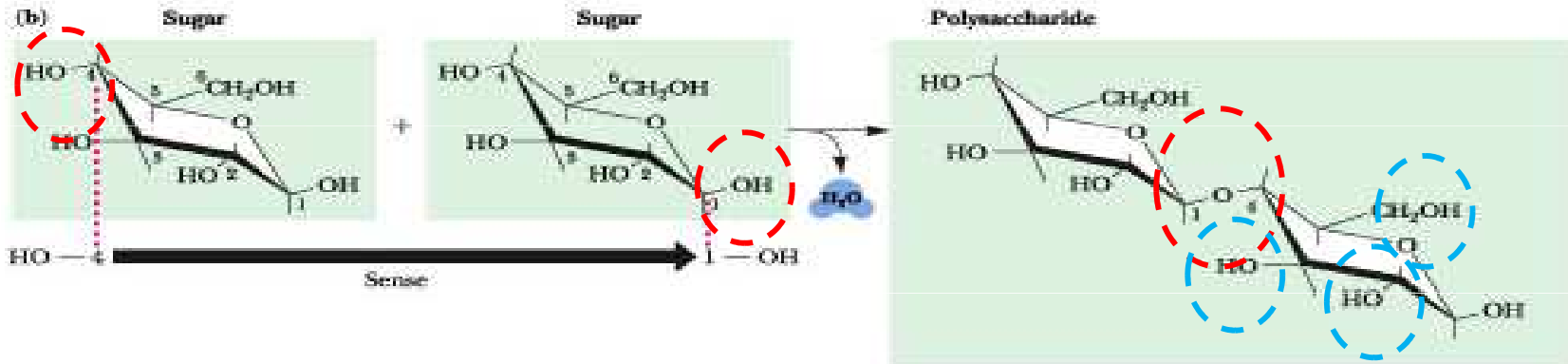
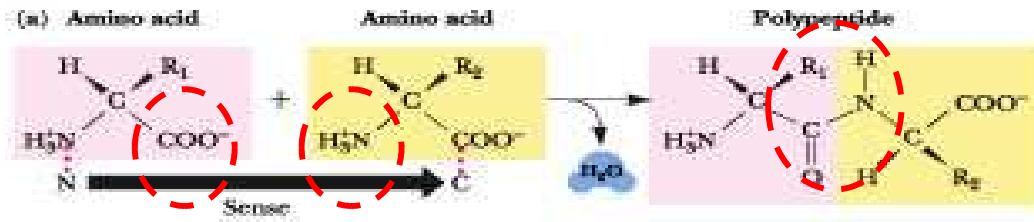

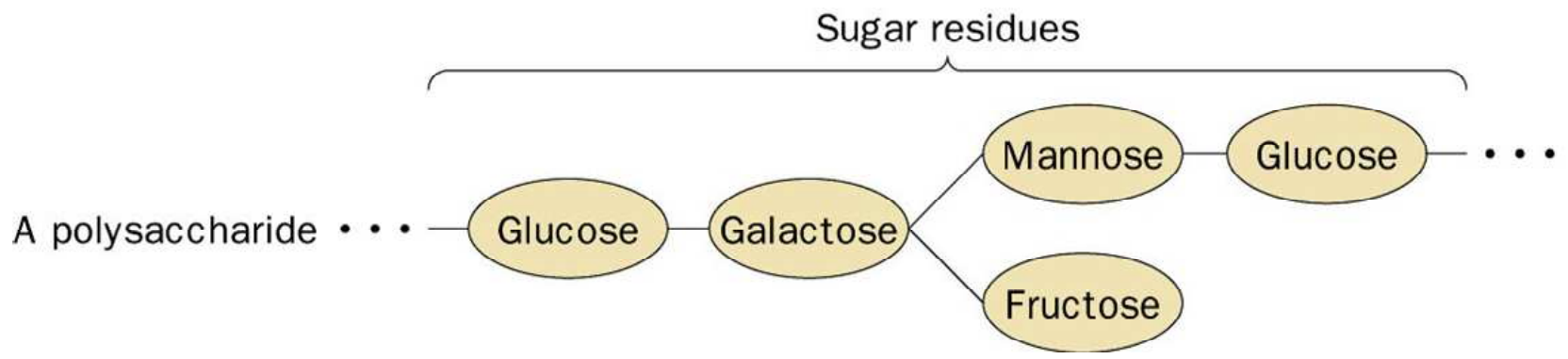
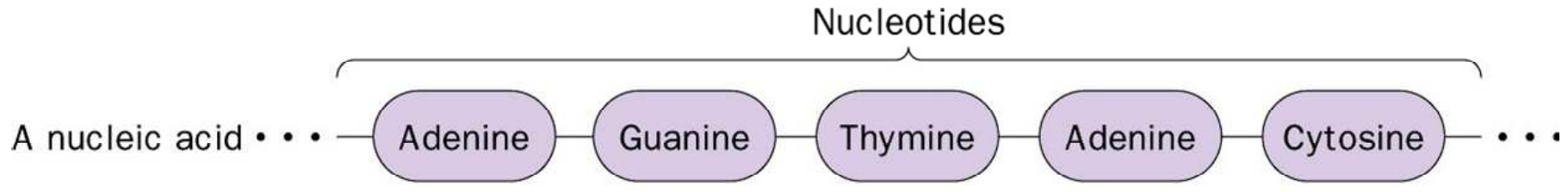
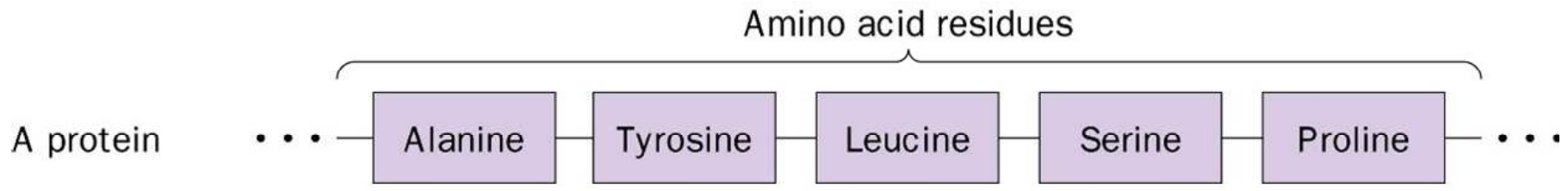

- nízkomolekulární - produkty meziprodukty metabolismu
- sekundární metabolity
- regulační látky

Fylogenetický strom (rRNA)

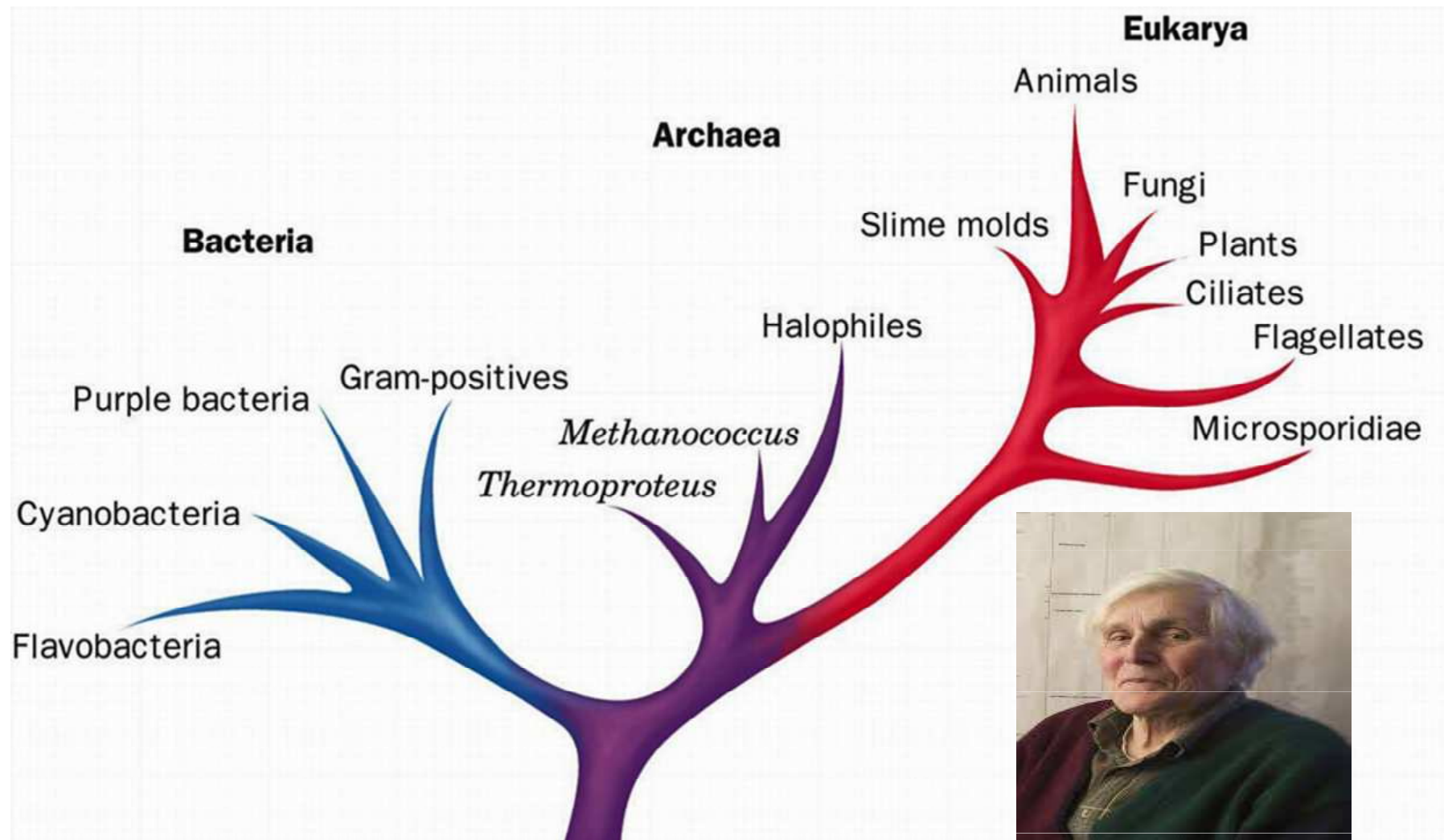

Carl Woese
Srovnání molekul rRNA

Fylogenetický strom

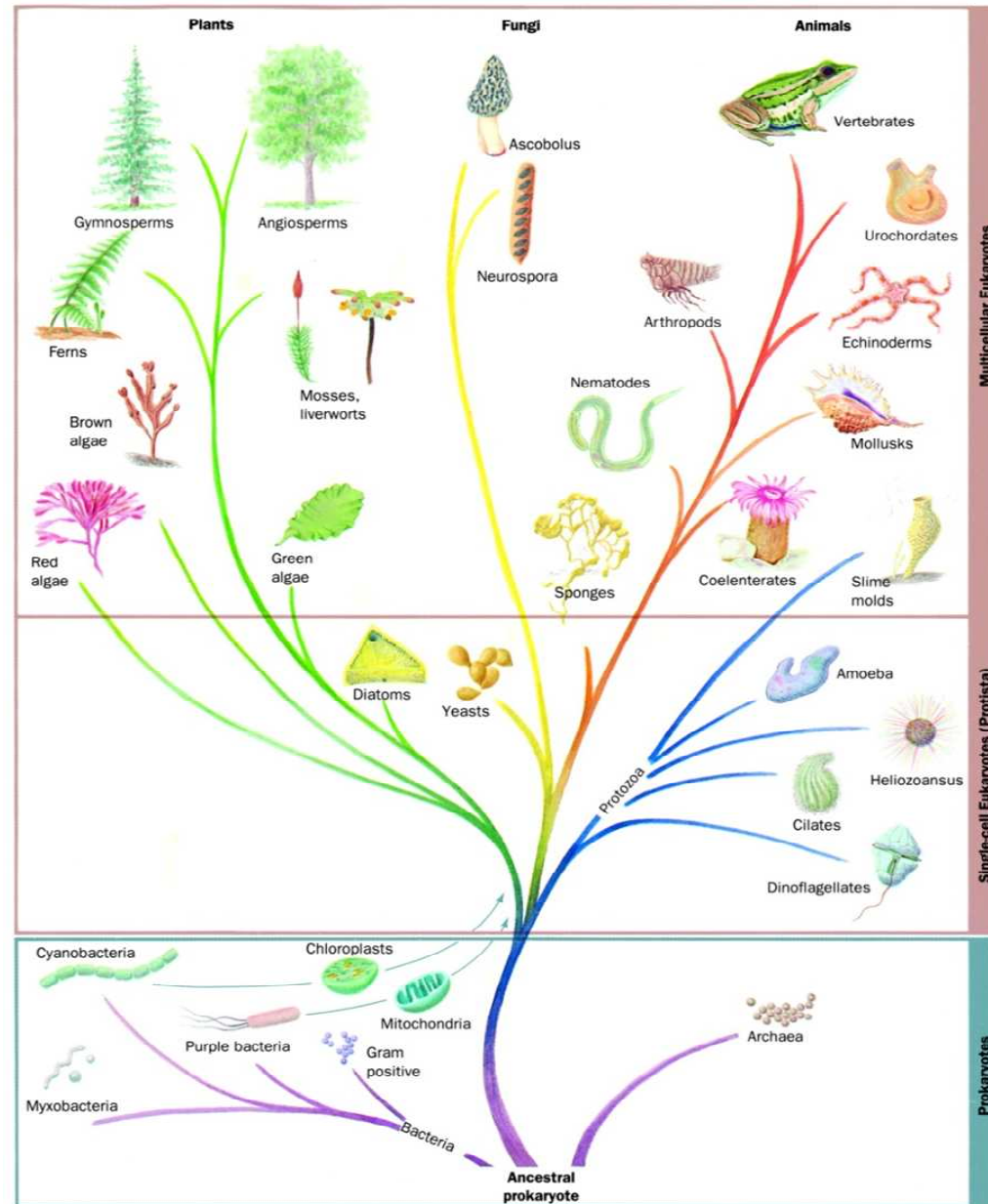

Margulis – endosymbiotická teorie

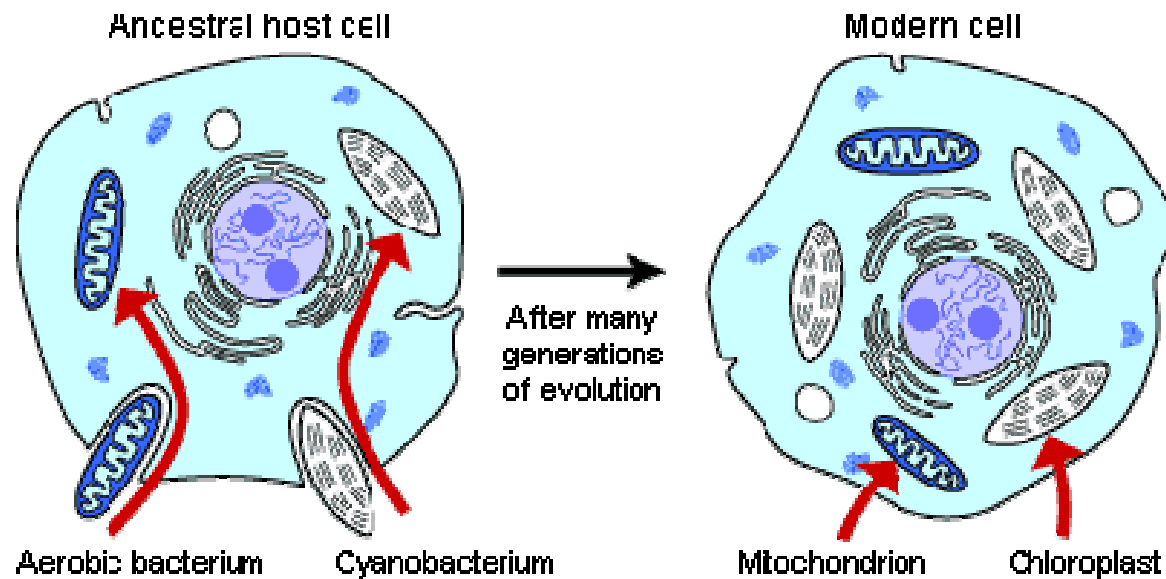

Prokaryontní bakteriální buňka

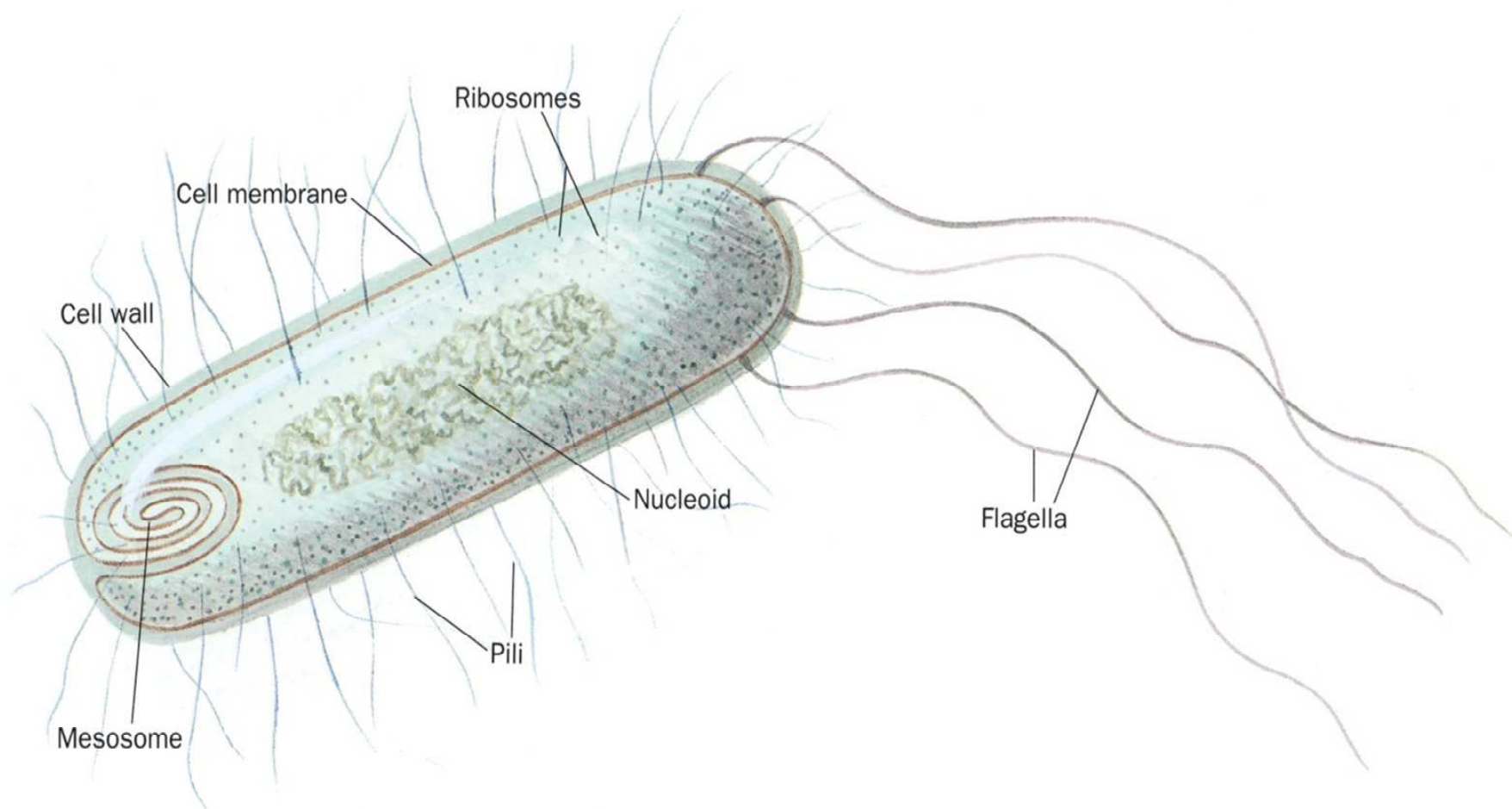

Prokaryontní bakteriální buňka

Table 1.1

Molecular composition and biological function of prokaryotic cell components

Structural Feature	Molecular Composition	Biological Function
Cell wall, pili, and flagella	Polysaccharide chains cross-linked by proteins; coated with lipopolysaccharide; pili and flagella are extensions of the cell wall	Protection against mechanical and hypertonic stress; flagella assist in movement; pili assist in sexual conjugation
Cell membrane, mesosome	Bilayer of 40% lipid, 60% protein, perhaps some carbohydrate; mesosome is infolded membrane	Permeable boundary that allows for entry and exit of nutrients, waste; mesosome may play role in DNA replication
Nucleoid region	Contains chromatin, a complex of chromosomal DNA and histone proteins	The genome; storage of genetic information; site of DNA replication
Ribosomes	Complexes of RNA (65%) and protein (35%)	Sites of protein synthesis
Vacuoles	Nutrients stored as small molecules or polymers	Storage of fuel molecules for energy metabolism
Cytoplasm	Small molecules, soluble proteins, enzymes, nutrients, inorganic salts; dissolved in aqueous solution	Region where many metabolic reactions occur

Eukaryontní živočišná buňka

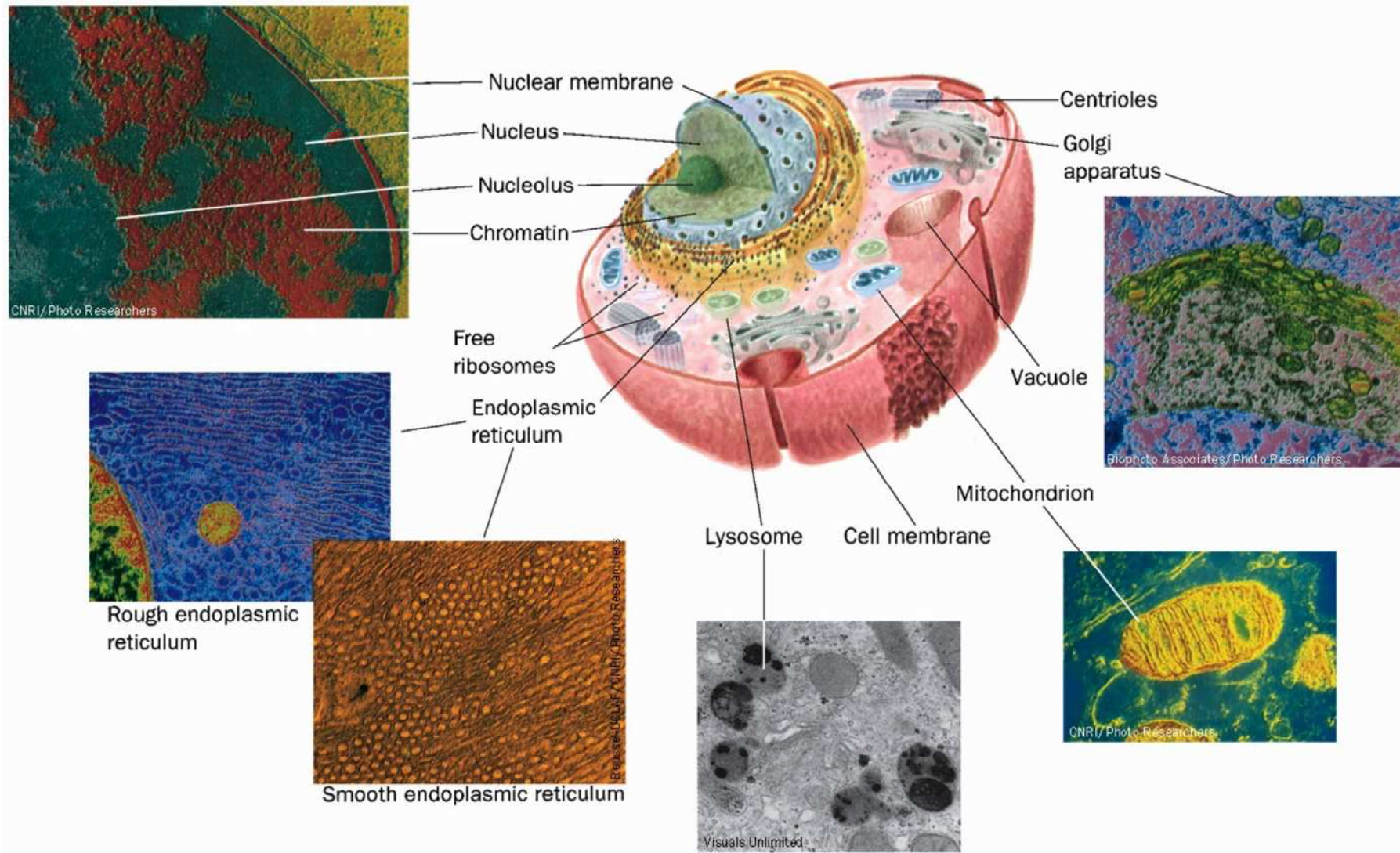

Eukaryontní rostlinná buňka

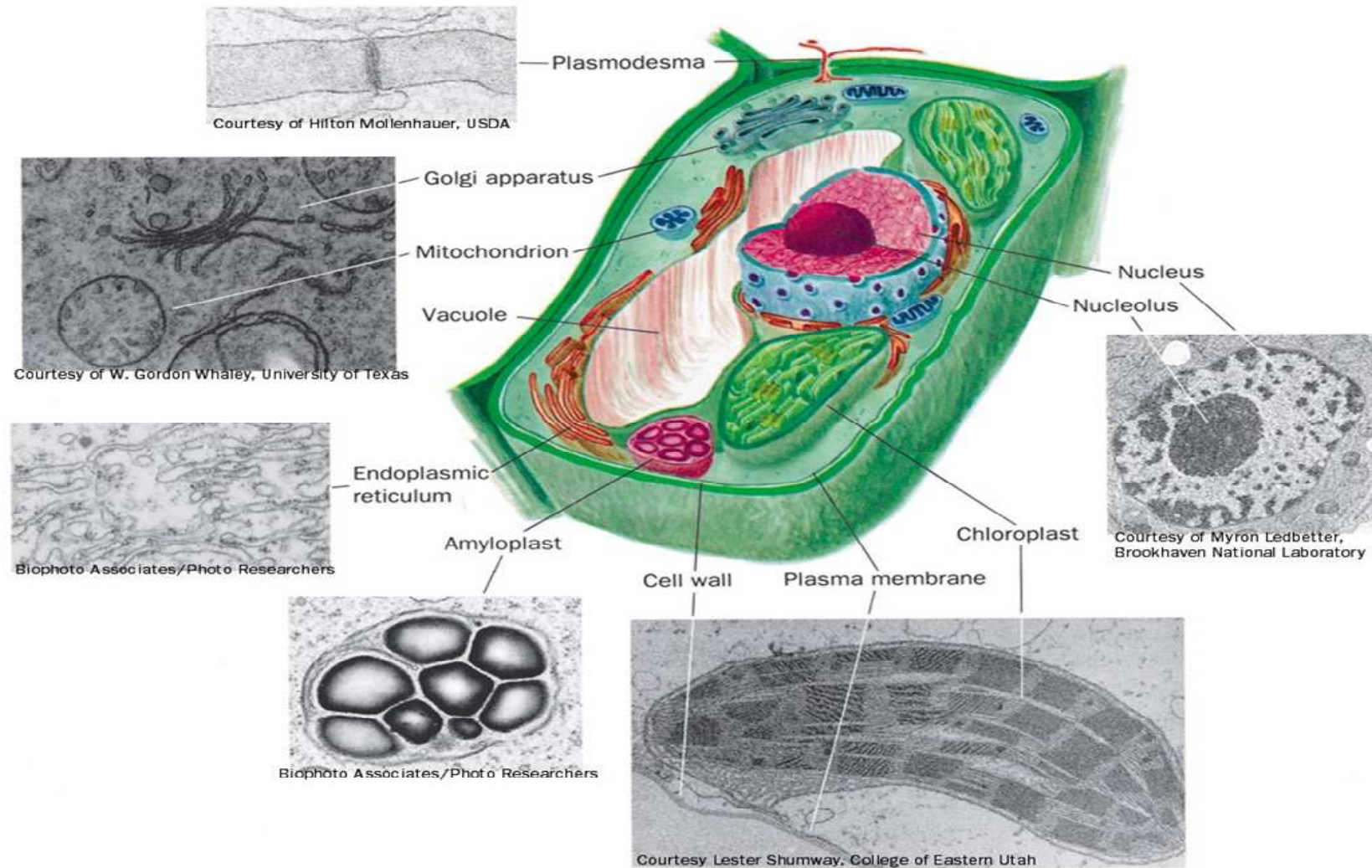

Eukaryontní buňka

Table 1.2
Eukaryotic organelles, their constituent biomolecules, and biological function

Structural Feature	Molecular Composition	Biological Function
Cell membrane	Bilayer of proteins (50%) and lipids (50%) and some carbohydrate	Selectively permeable boundary for entry and exit of nutrients and waste; some important enzyme activities; location of receptors for signaling
Nucleus	Contains genomic DNA, and histone proteins as chromatin; RNA	Storage of genetic information; site of DNA replication and transcription to RNA
Endoplasmic reticulum with ribosomes	Flat, single-membraned vesicles of lipid and protein; ribosomes consist of RNA and proteins	Surfaces on which ribosomes bind for protein synthesis
Golgi apparatus	Flattened vesicles of lipid, protein, and polysaccharide	Secretion of cell waste products; site of protein processing
Mitochondria	Double-membraned with protein and lipids; interior (matrix) contains soluble and insoluble enzymes, RNA, and DNA	Site of energy metabolism and synthesis of high-energy ATP
Lysosomes (animal)	Single-membraned vesicles containing enzymes for hydrolysis	Metabolism of materials ingested by endocytosis
Peroxisomes (animal) or glyoxysomes (plant)	Single-membraned vesicles containing catalase and other oxidative enzymes	Oxidative metabolism of nutrients using O ₂ to generate H ₂ O ₂
Chloroplasts (plant)	Double-membraned organelles containing protein, lipid, chlorophyll, RNA, DNA, and ribosomes	Sites of photosynthesis; convert light energy into chemical energy (ATP)
Cytoplasm	Cytoskeleton made of proteins; small molecules, soluble proteins, enzymes, nutrients, and salts in aqueous solution	Provides shape to cell; region where many metabolic reactions occur

Table 1-2 Concepts in Biochemistry, 3/e
 © 2006 John Wiley & Sons

Organizace biologických struktur

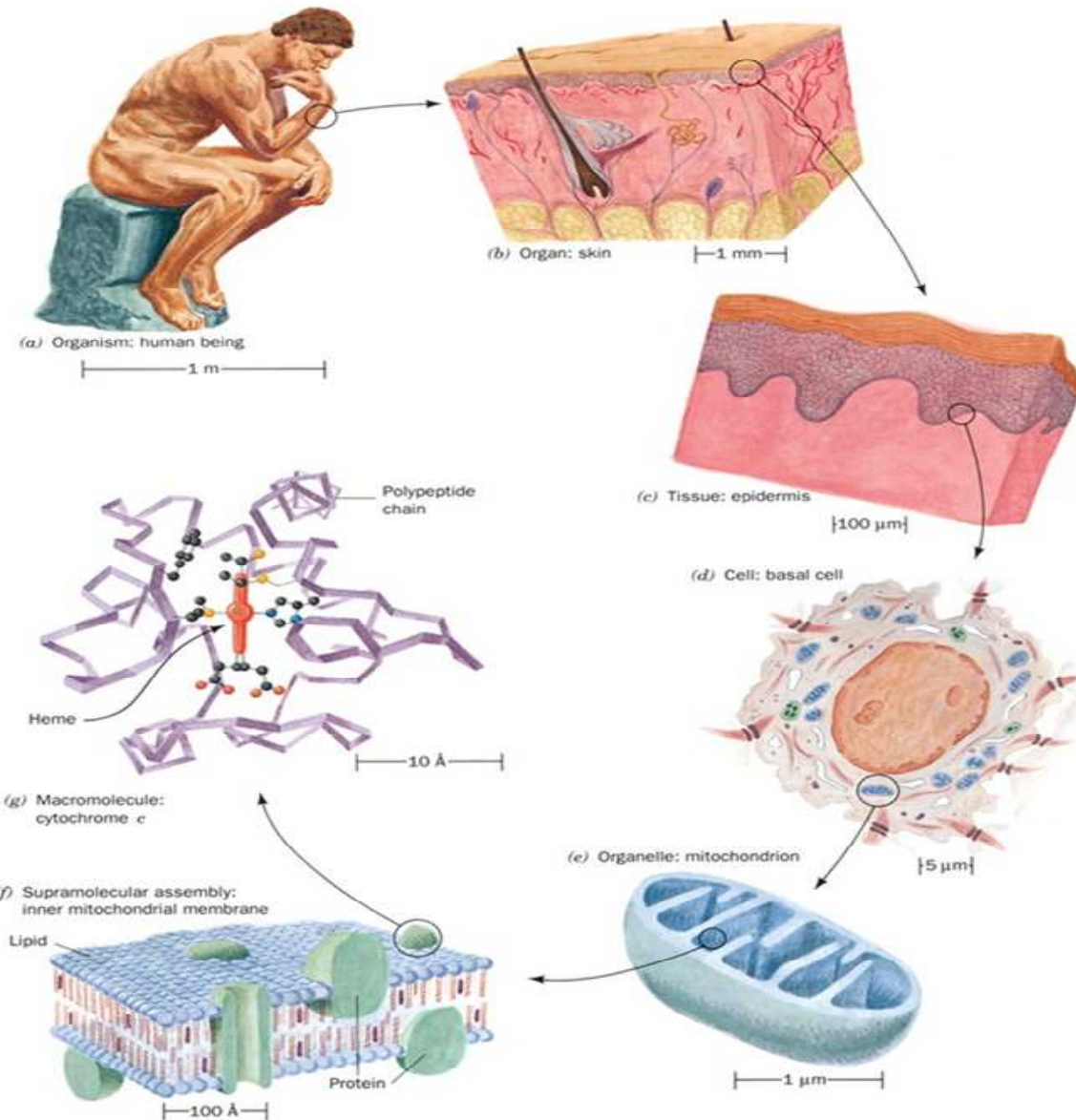

Viry

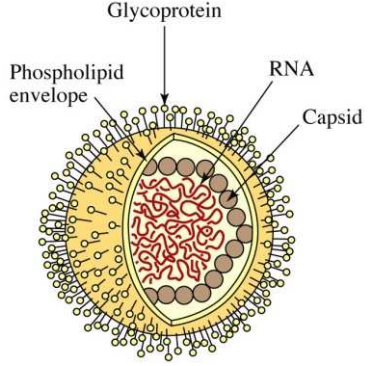

(a) Influenza virus (globular)

Figure 1-7a Concepts in Biochemistry, 3/e

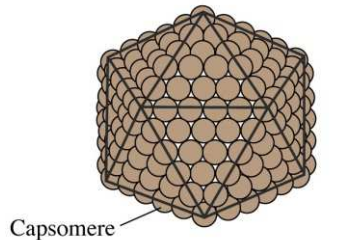
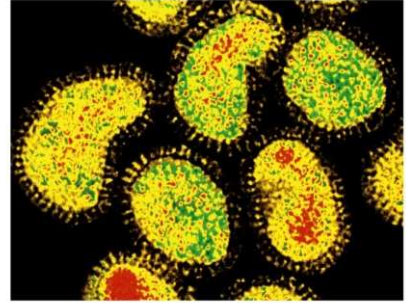

(b) Adenovirus (polyhedral)

Figure 1-7b Concepts in Biochemistry, 3/e

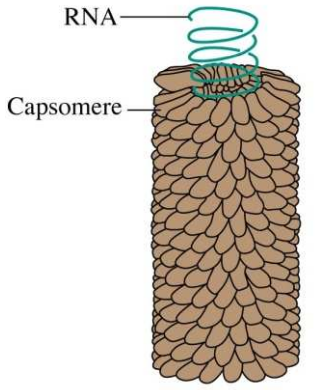
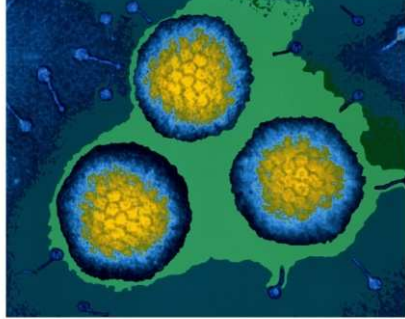

(c) Tobacco mosaic virus (cylindrical)

Figure 1-7c Concepts in Biochemistry, 3/e

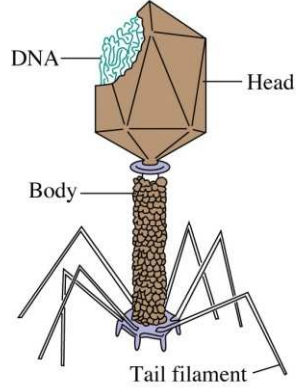
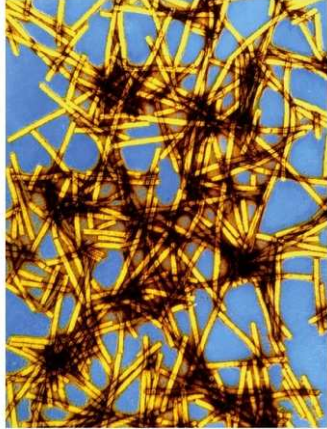

(d) Bacteriophage (complex shape)

Figure 1-7d Concepts in Biochemistry, 3/e

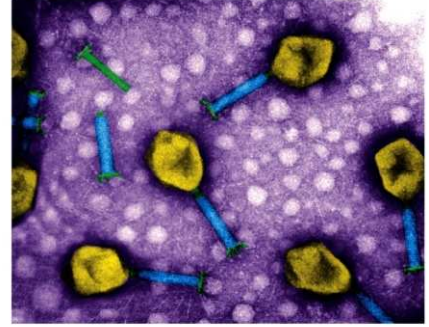

Viry

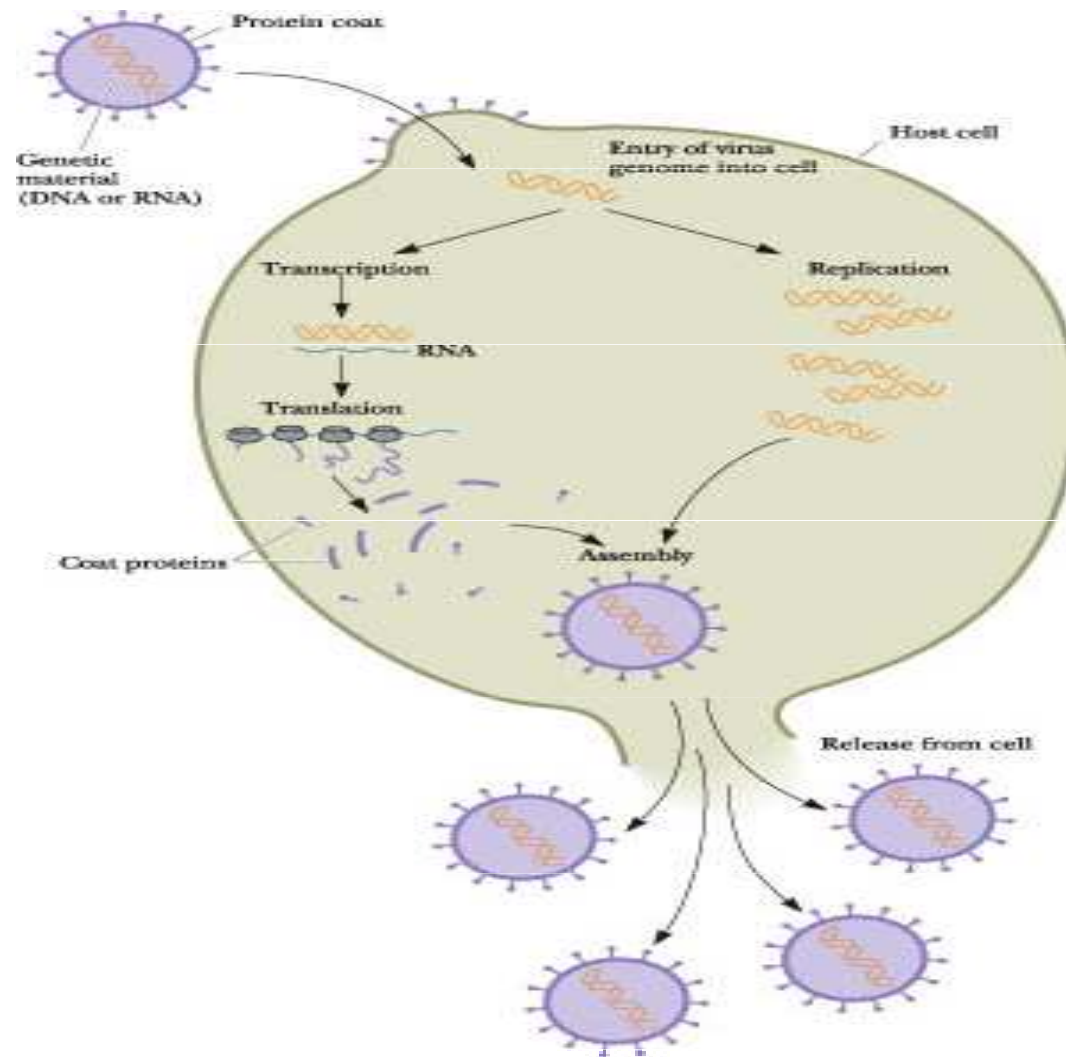

Evolve života na zemi

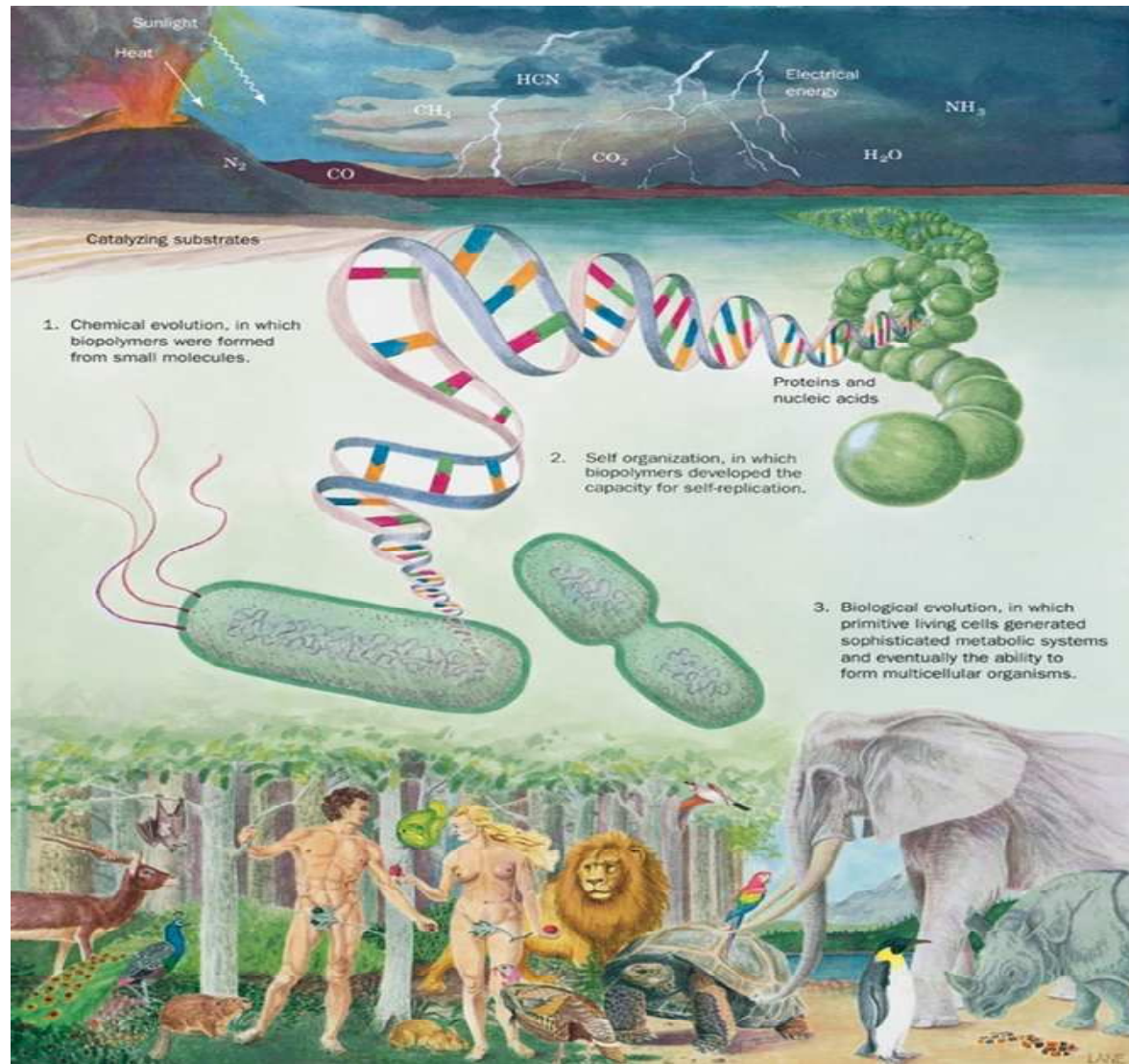

Evolve života na zemi

1. Chemická evolve — jednoduché anorganické molekuly dávají vznik organickým polymerům
2. Vznik uspořádaných struktur biopolymerů — ty jsou schopná autoreplikace- RNA
3. Biologická evolve — evolve od jednobuněčných k mnohobuněčným živočichům

Evolve životu na zemi

Miller Orgel

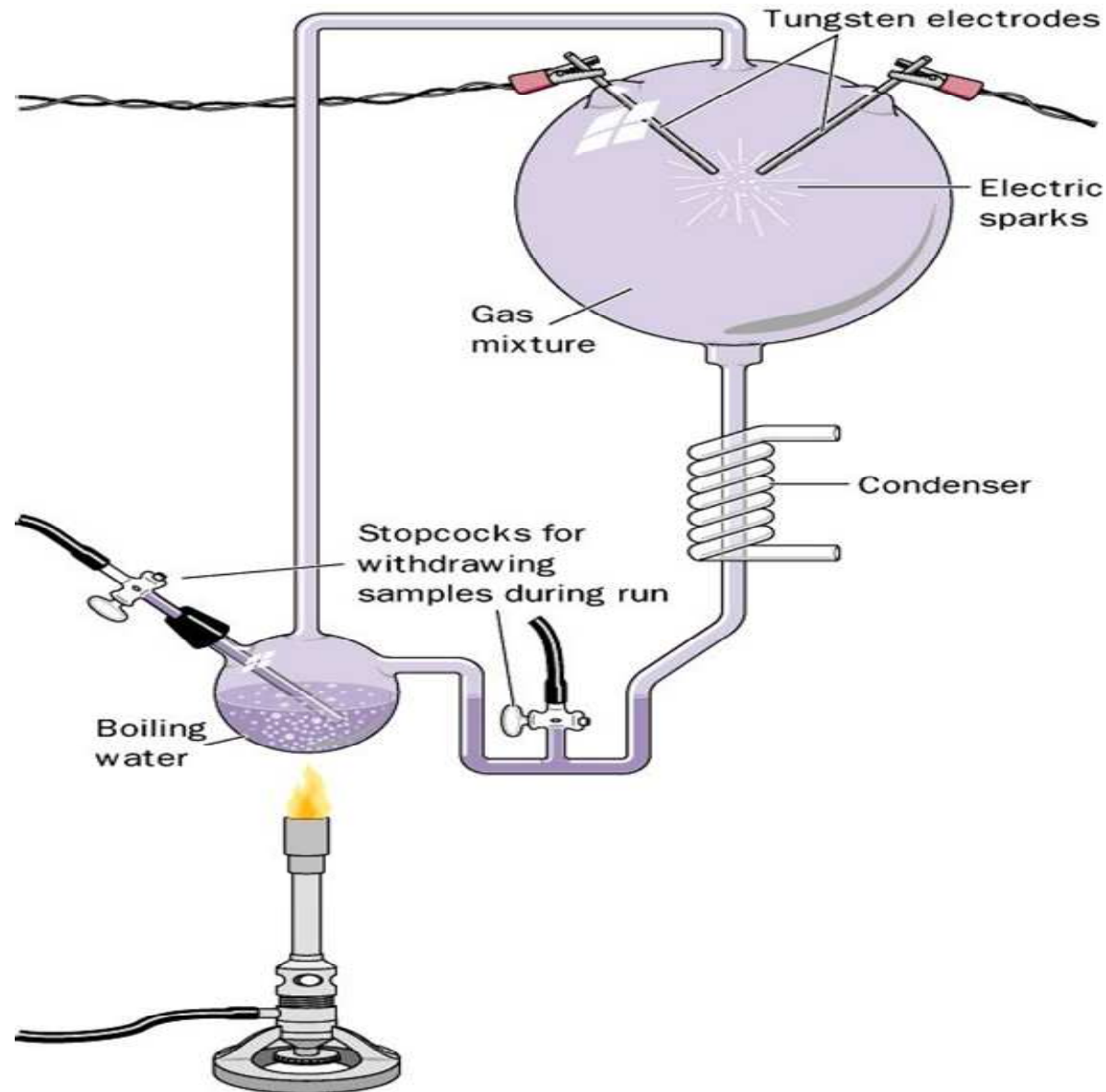

Evolve života na zemi

Compound	Yield (%)
Glycine ^a	2.1
Glycolic acid	1.9
Sarcosine	0.25
Alanine ^a	1.7
Lactic acid	1.6
<i>N</i> -Methylalanine	0.07
α -Amino- <i>n</i> -butyric acid	0.34
α -Aminoisobutyric acid	0.007
α -Hydroxybutyric acid	0.34
β -Alanine	0.76
Succinic acid	0.27
Aspartic acid ^a	0.024
Glutamic acid ^a	0.051
Iminodiacetic acid	0.37
Iminoaceticpropionic acid	0.13
Formic acid	4.0
Acetic acid	0.51
Propionic acid	0.66
Urea	0.034
<i>N</i> -Methylurea	0.051

^a Amino acid constituent of proteins.

Source: Miller, S.J. and Orgel, L.E., *The Origins of Life on Earth*, p. 85, Prentice-Hall (1974).

BÍLKOVINY - PROTEINY

Protein - MULDER, BERZELIUS (1838)

πρωτεΐνη - „zaujímající první místo“

Funkce - katalýza

transport

pohyb

podpora

imunita

regulace

vznik a přenos nervového vzruchu

AMINOKYSELINY (20 AMK)

MW 50 - 200



2 až 50 AMK PEPTIDY → POLYPEPTIDY

MW < 10 000



> 50 AMK BÍLKOVINY - PROTEINY

MW > 10 000

Aminokyseliny :

chemicky - substituční deriváty karboxylových kyselin

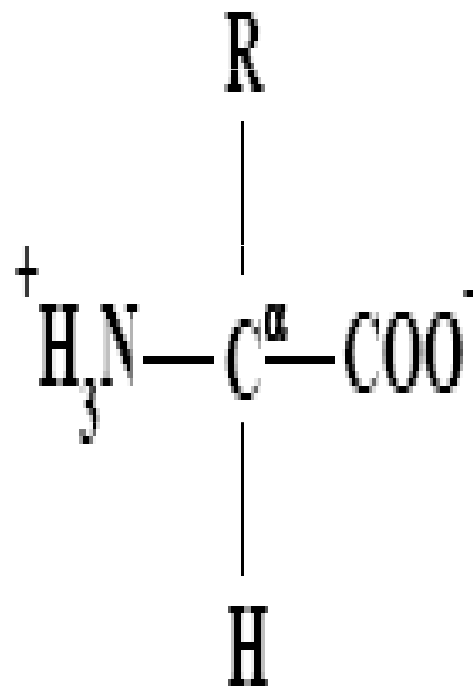

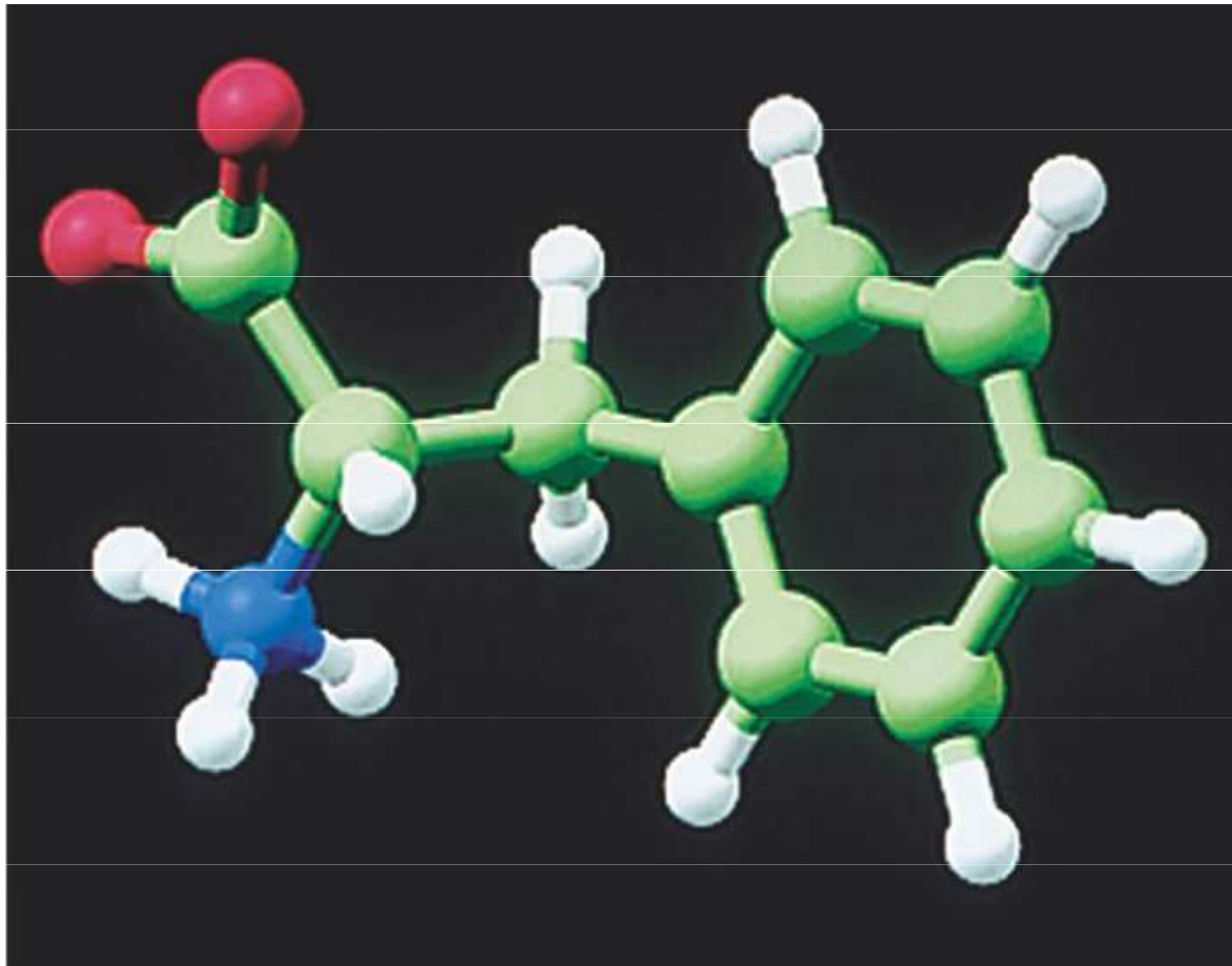

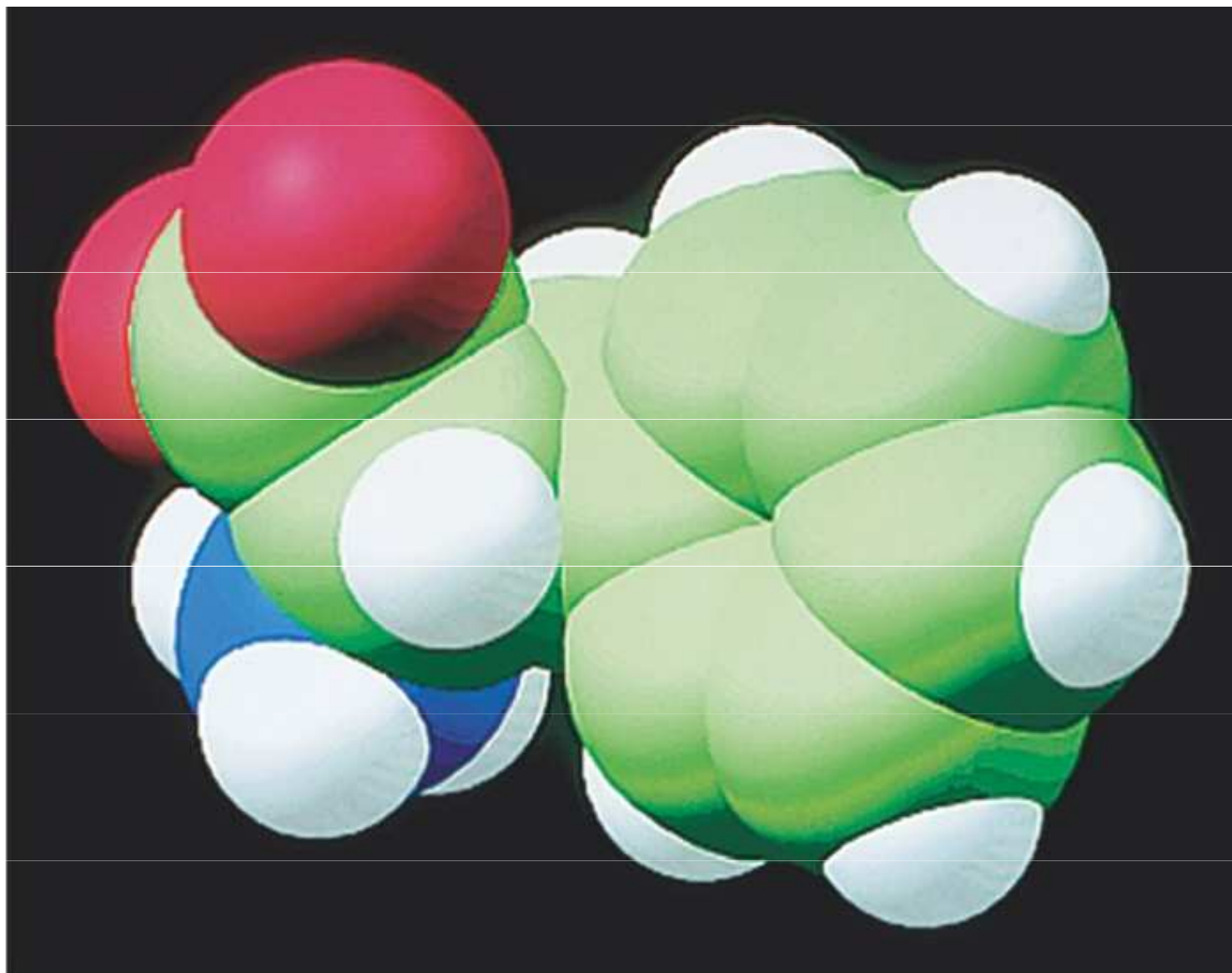

I. Kódované aminokyseliny

Rozdělení :

A. Nepolární aminokyseliny - Gly, Ala, Val, Leu, Ile, Phe, Pro

B. Polární aminokyseliny

OH skupinu - Ser, Thr, Tyr

SH skupinu - Cys, Met

indolovou skupinu - Try

CONH₂ skupinu - AspNH₂, GluNH₂

C. Nabité - kyselé COOH skupinu - Asp, Glu

- basické NH₂ skupinu - Lys

guanidinovou skupinu - Arg

imidazolovou skupinu - His

Name, Three-letter Symbol, and One-letter Symbol	Structural Formula ^a	Residue Mass (D) ^b	Average Occurrence in Proteins (%) ^c	pK ₁ α-COOH ^d	pK ₂ α-NH ₃ ⁺ ^d	pK _R Side Chain ^d
Amino acids with nonpolar side chains						
Glycine Gly G		57.0	6.8	2.35	9.78	
Alanine Ala A		71.1	7.6	2.35	9.87	
Valine Val V		99.1	6.6	2.29	9.74	
Leucine Leu L		113.2	9.5	2.33	9.74	
Isoleucine Ile I		113.2	5.8	2.32	9.76	
Methionine Met M		131.2	2.4	2.13	9.28	
Proline Pro P		97.1	5.0	1.95	10.64	
Phenylalanine Phe F		147.2	4.1	2.20	9.31	
Tryptophan Trp W		186.2	1.2	2.46	9.41	

(continued)

^aThe ionic forms shown are those predominating at pH 7.0 (except for that of histidine^e), although residue mass is given for the neutral compound. The C atoms, as well as those atoms marked with an asterisk, are chiral centers with configurations as indicated according to Fischer projection formulas. The standard organic numbering system is provided for heterocycles.

^bThe residue masses are given for the neutral residues. For molecular masses of the parent amino acids, add 18.0 D, the molecular mass of H₂O, to the residue masses. For side chain masses, subtract 56.0 D, the formula mass of a peptide group, from the residue masses.

^cThe average amino acid composition in the complete SWISS-PROT database (<http://www.expasy.ch/sprot>), Release 40.7.

^dFrom Dawson, R.M.C., Elliott, D.C., Elliott, W.H., and Jones, K.M., *Data for Biochemical Research* (3rd ed.), pp. 1–31, Oxford Science Publications (1986).

^eBoth the neutral and protonated forms of histidine are present at pH 7.0 because its pK_R is close to 7.0. The imidazole ring of histidine is numbered here according to the biochemistry convention. In the IUPAC convention, N3 of the biochemistry convention is designated N1 and the numbering increases clockwise around the ring.

^fThe three- and one-letter symbols for asparagine or aspartic acid are Asx and B, whereas for glutamine or glutamic acid they are Glx and Z. The one-letter symbol for an undetermined or "nonstandard" amino acid is X.

Name Three-letter Symbol, and One-letter Symbol	Structural Formula ^a	Residue Mass (D) ^b	Average Occurrence in Proteins (%) ^c	pK ₁ -COOH ^d	pK ₂ -NH ₃ ⁺ ^d	pK _R Side Chain ^d
Amino acids with uncharged polar side chains						
Serine Ser S		87.1	7.1	2.19	9.21	
Threonine Thr T		101.1	5.6	2.09	9.10	
Asparagine ^f Asn N		114.1	4.3	2.14	8.72	
Glutamine ^f Gln Q		128.1	3.9	2.17	9.13	
Tyrosine Tyr Y		163.2	3.2	2.20	9.21	10.46 (phenol)
Cysteine Cys C		103.1	1.6	1.92	10.70	8.37 (sulfhydryl)
Amino acids with charged polar side chains						
Lysine Lys K		128.2	6.0	2.16	9.06	10.54 (-NH ₃)
Arginine Arg R		156.2	5.2	1.82	8.99	12.48 (guanidino)
Histidine ^e His H		137.1	2.2	1.80	9.33	6.04 (imidazole)
Aspartic acid ^f Asp D		115.1	5.2	1.99	9.90	3.90 (-COOH)
Glutamic acid ^f Glu E		129.1	6.5	2.10	9.47	4.07 (-COOH)

Cystin

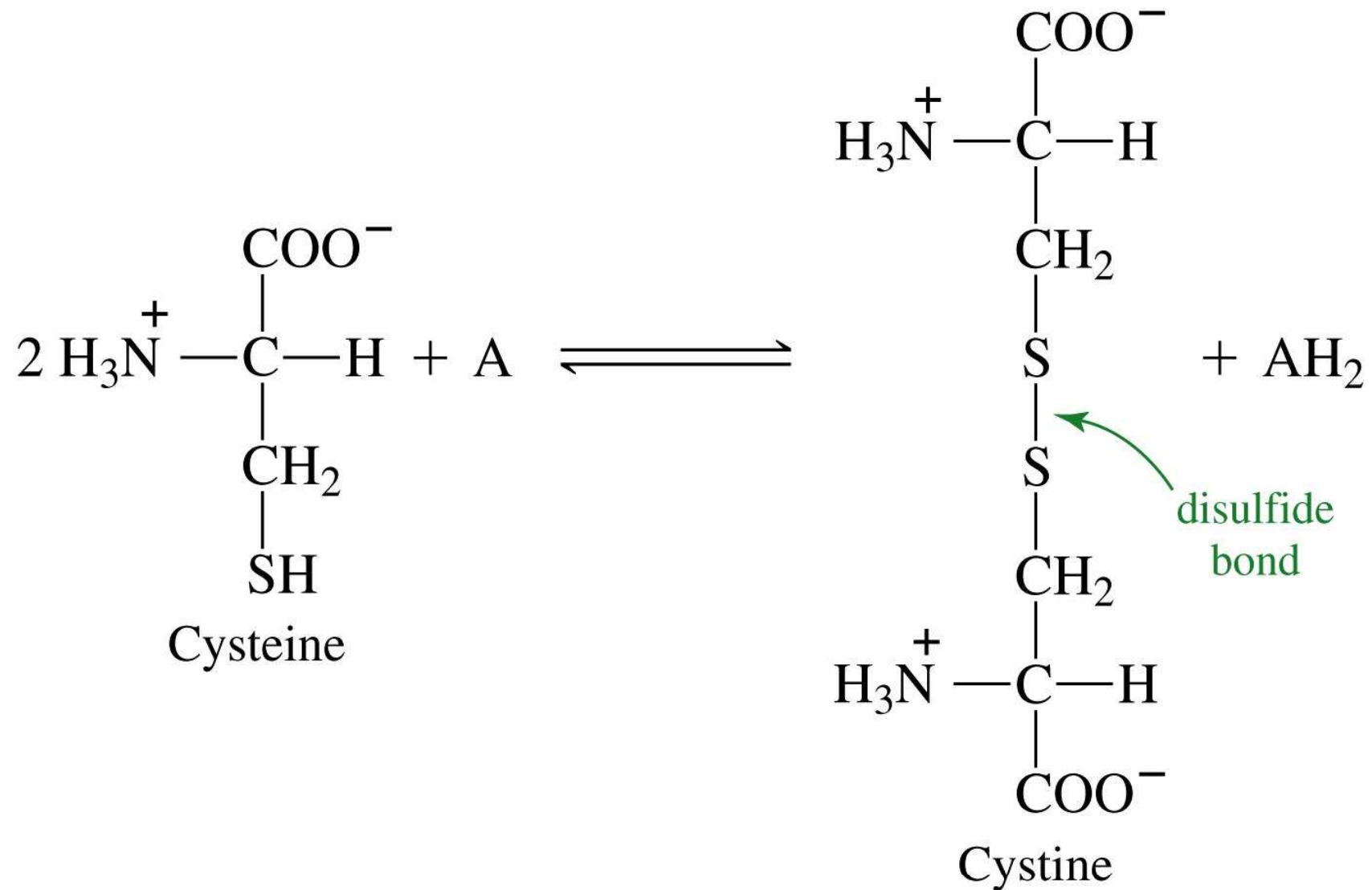

Cystin

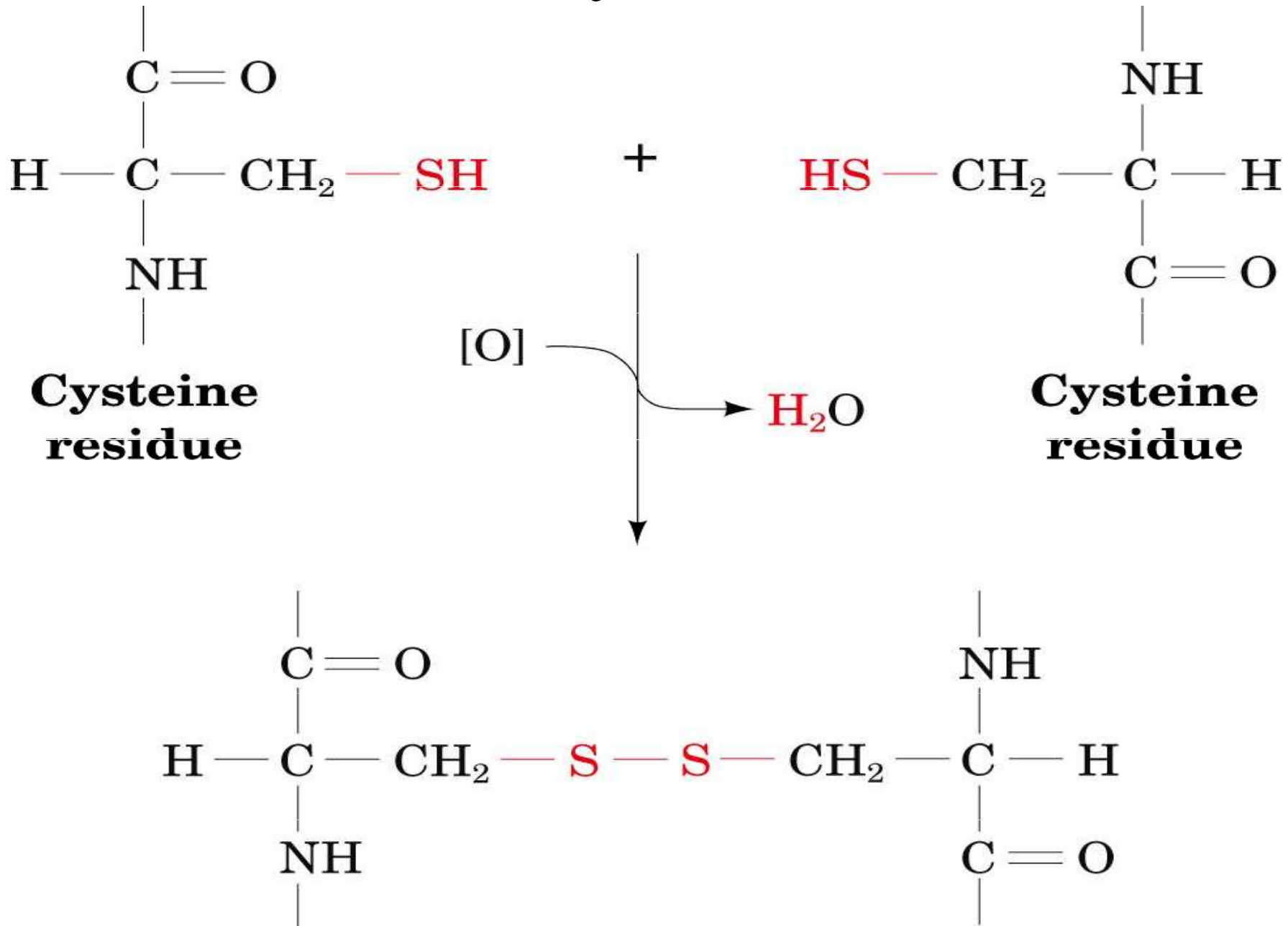

Selenocystein (UGA) SECIS

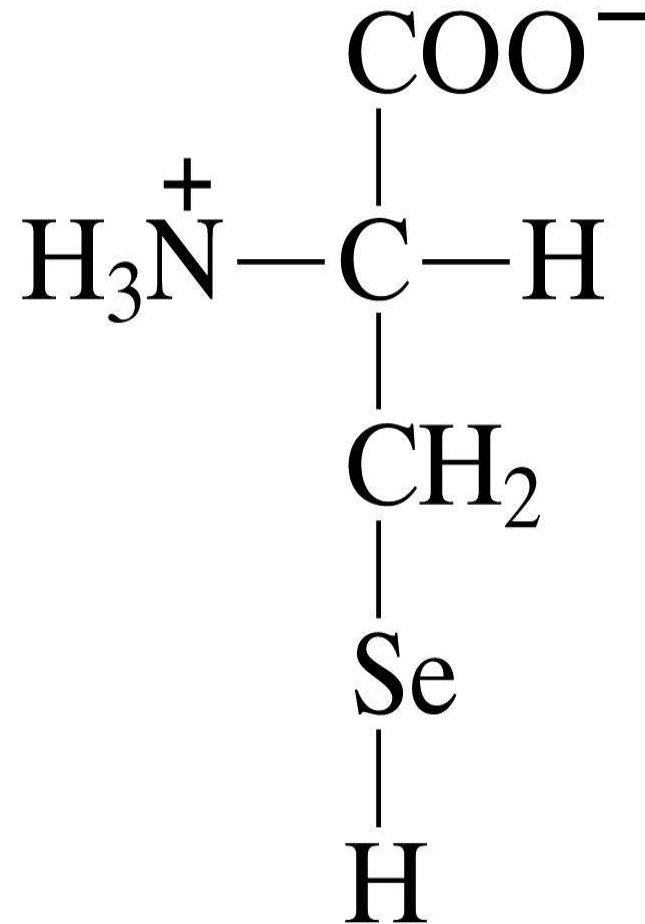

Selenocysteine

Pyrrolysine (UAG) PYLIS

Desulfitobacterium hafniense

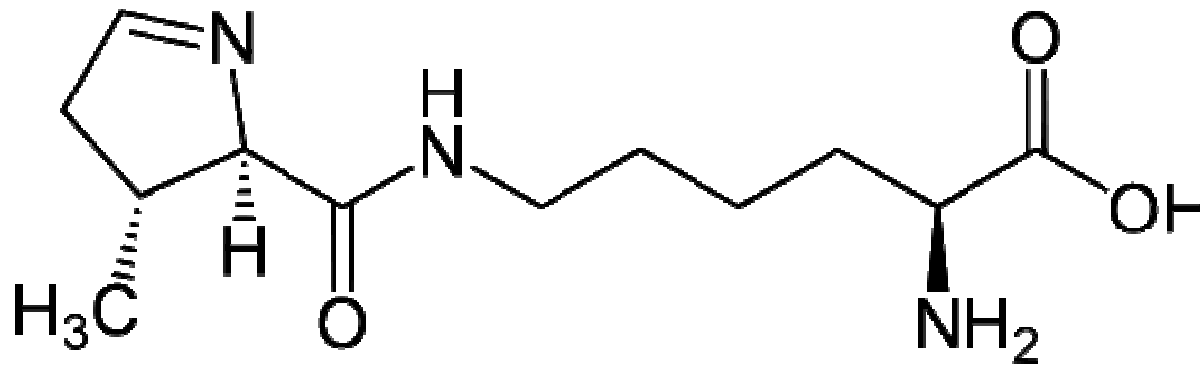

Názvosloví

- Triviální
 - Glycin
 - Tyrosin
 - Asparagová kyselina
- Systematické
 - 2-aminoethanová kyselina

Používané zkratky
 / }
 třípísmenkové
 jednopísmenkové

AMK	Symboly		AMK	Symboly	
glycin	Gly	G	methionin	Met	M
alanin	Ala	A	glutamová k.	Glu	E
valin	Val	V	asparagin	Asn	N
leucin	Leu	L	glutamin	Gln	Q
izoleucin	Ile	I	lysin	Lys	K
serin	Ser	S	arginin	Arg	R
threonin	Thr	T	tyrosin	Tyr	Y
cystein	Cys	C	fenylalanin	Phe	F
histidin	His	H	tryptofan	Trp	W
prolin	Pro	P	asparagová k.	Asp	D

Esenciální AMK

- Rostliny + mikroorganismy 0
- Člověk – biosyntéza -12

esenciální - 8 Lys, Try, Phe, Met,

Thr, Ile, Leu, Val, *Arg, His?*

II. Nekódované aminokyseliny

A. v bílkovinách posttranslační modifikací AMK

OH-Lys

OH-Pro

fosfo-Ser

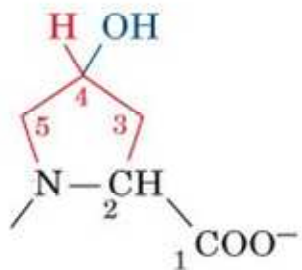

4-Hydroxyproline

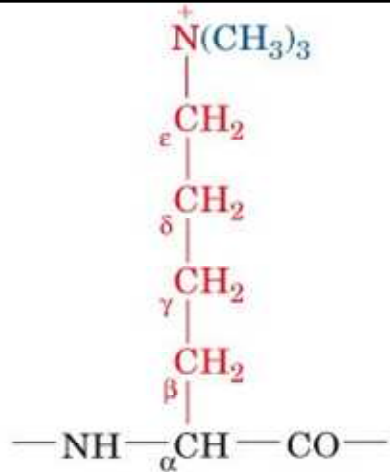

ε-N,N,N-Trimethyllysine

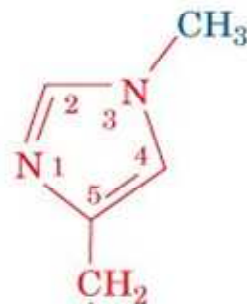

3-Methylhistidine

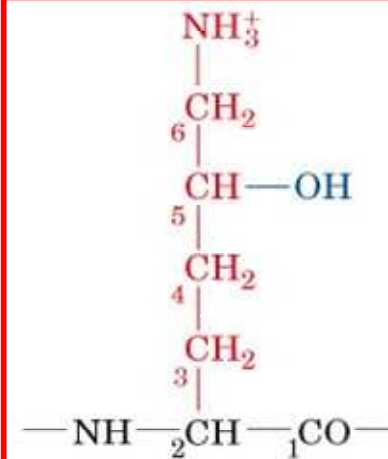

5-Hydroxylysine

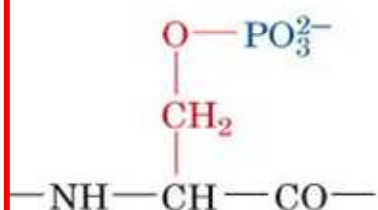

O-Phosphoserine

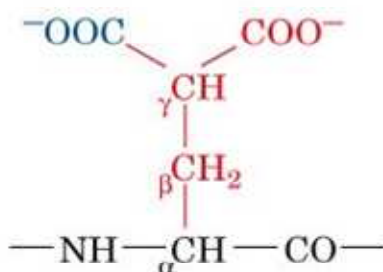

γ-Carboxyglutamate

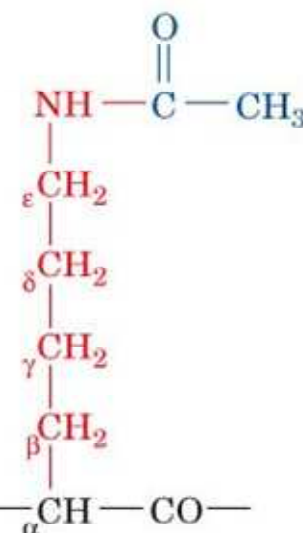

ε-N-Acetyllysine

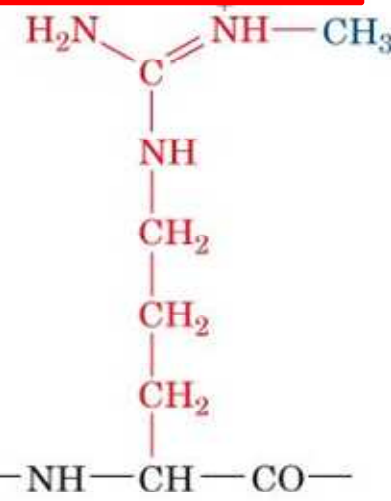

ω-N-Methylarginine

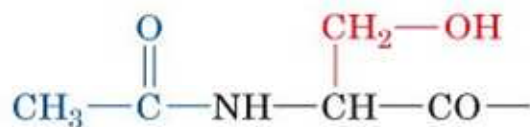

N-Acetylserine

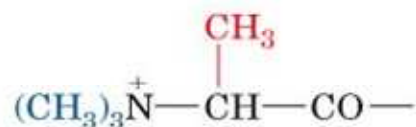

N,N,N-Trimethylalanine

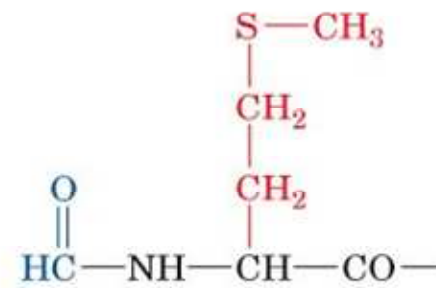

N-Formylmethionine

B. volné s biologickou funkcí

β alanin

ornitin a citrulin

γ aminomáselná

antibiotika - azaserin, cykloserin, chloramfenikol

nervové mediátory - DOPA, dopamin, adrenalin

hormony - thyroxin, trijodthyronin

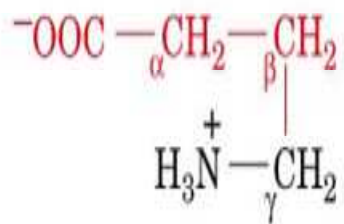

γ -Aminobutyric acid (GABA)

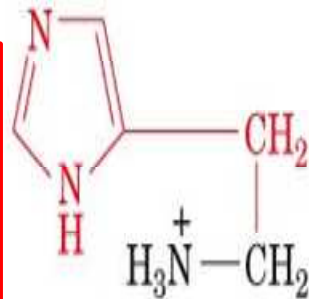

Histamine

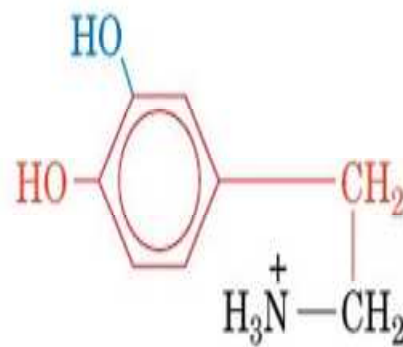

Dopamine

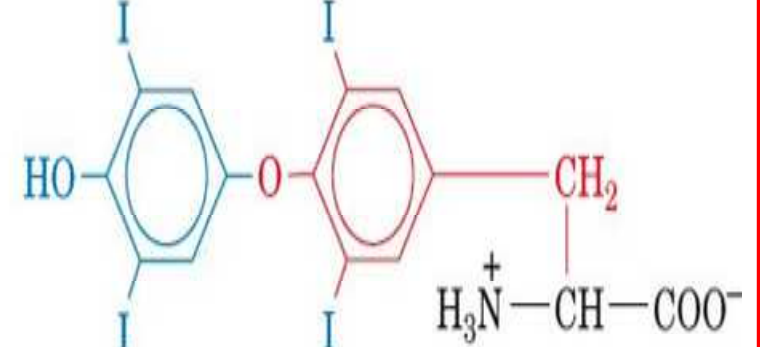

Thyroxine

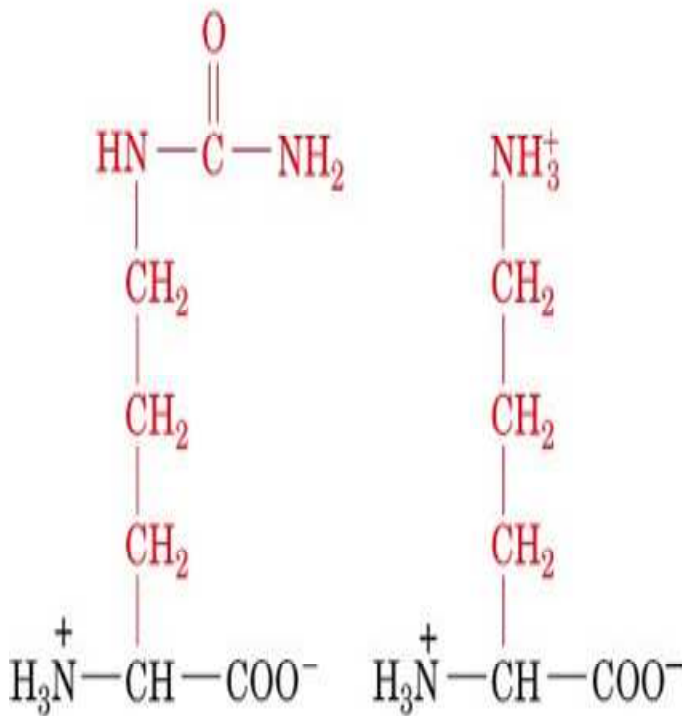

Citrulline

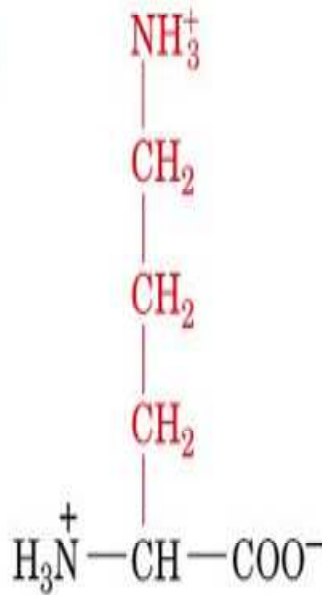

Ornithine

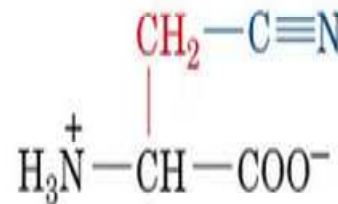

β -Cyanoalanine

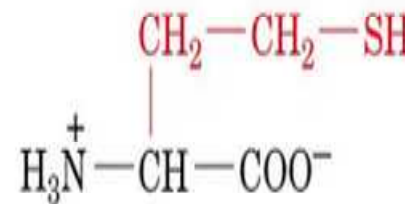

Homocysteine

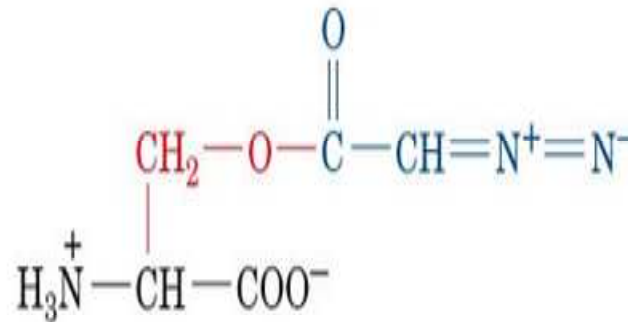

Azaserine

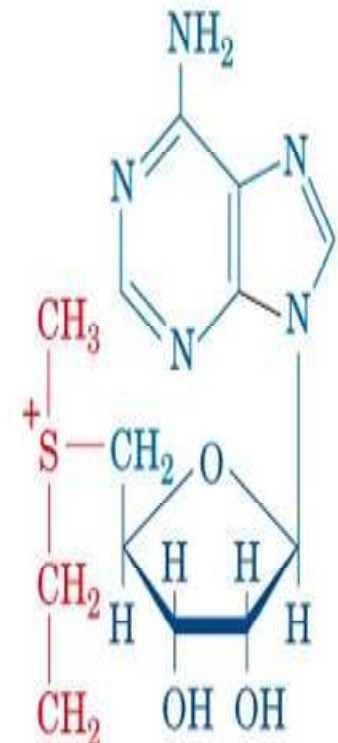

S-Adenosylmethionine



k. aminocyklopropyl-
karboxylová

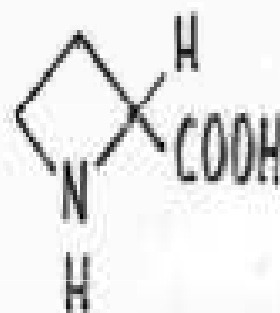

k. azetidinkarboxylová

Vlastnosti aminokyselin

ACIDOBAZICKÉ VLASTNOSTI

Amfoterní charakter - zwitterionty

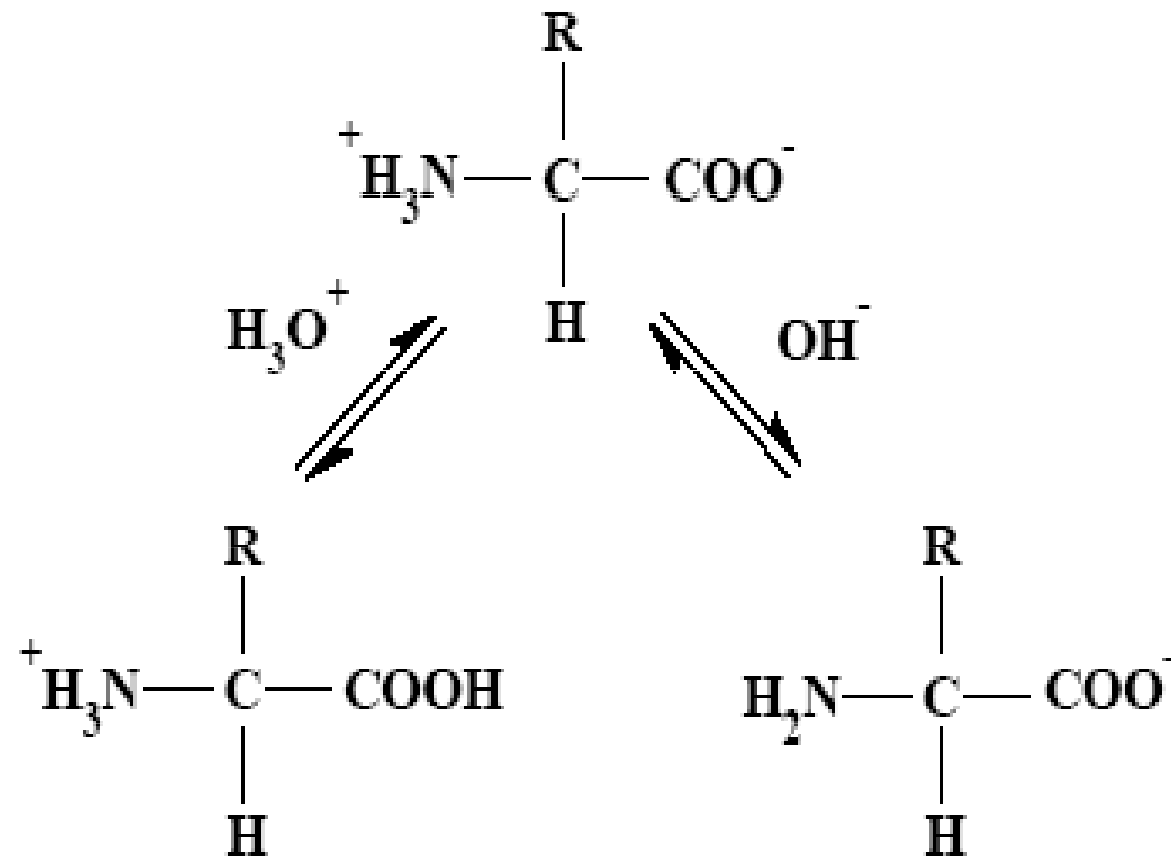

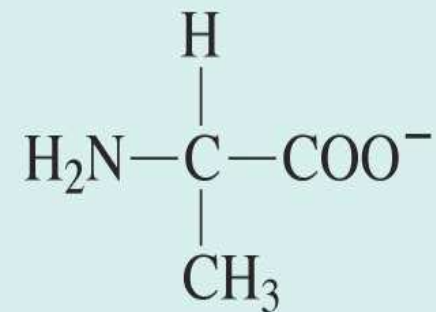
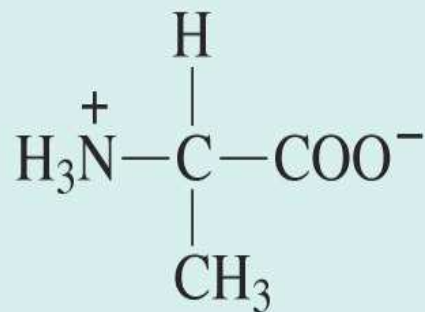
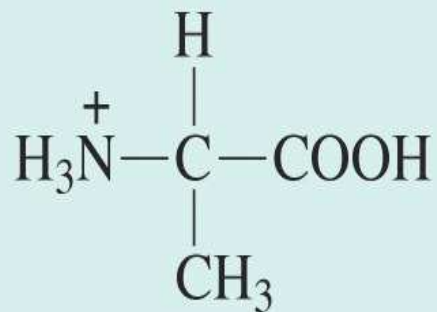
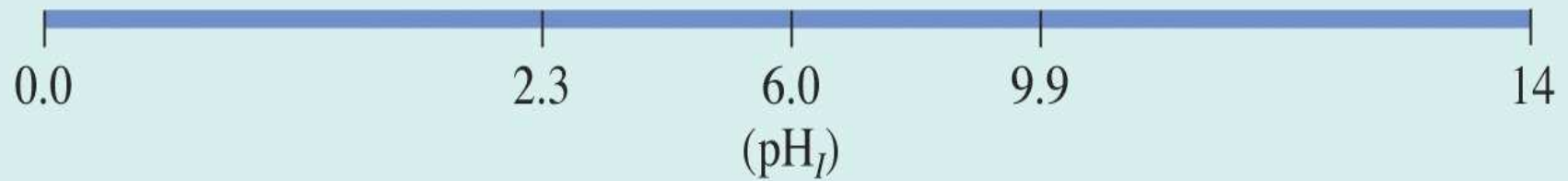
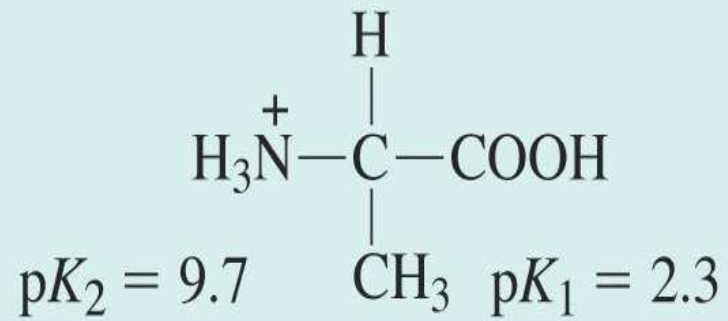

Figure 3-4b Concepts in Biochemistry, 3/e
© 2006 John Wiley & Sons

Izoelektrický bod $pI = \frac{pK_{COOH} + pK_{NH_2}}{2}$

Tabulka pK

Skupina	pK	Skupina	pK	Skupina	pK
α COOH	1.8 - 2.5	β COOH	3.9	γ COOH	4.1
α NH₂	9 - 10	ϵ NH₂	10.8	guanidin	12.5
imidazol	6.0	SH	8.3	OH	10.1

Pufrační kapacita

Titrační křivky

Titrační křivka glycinu

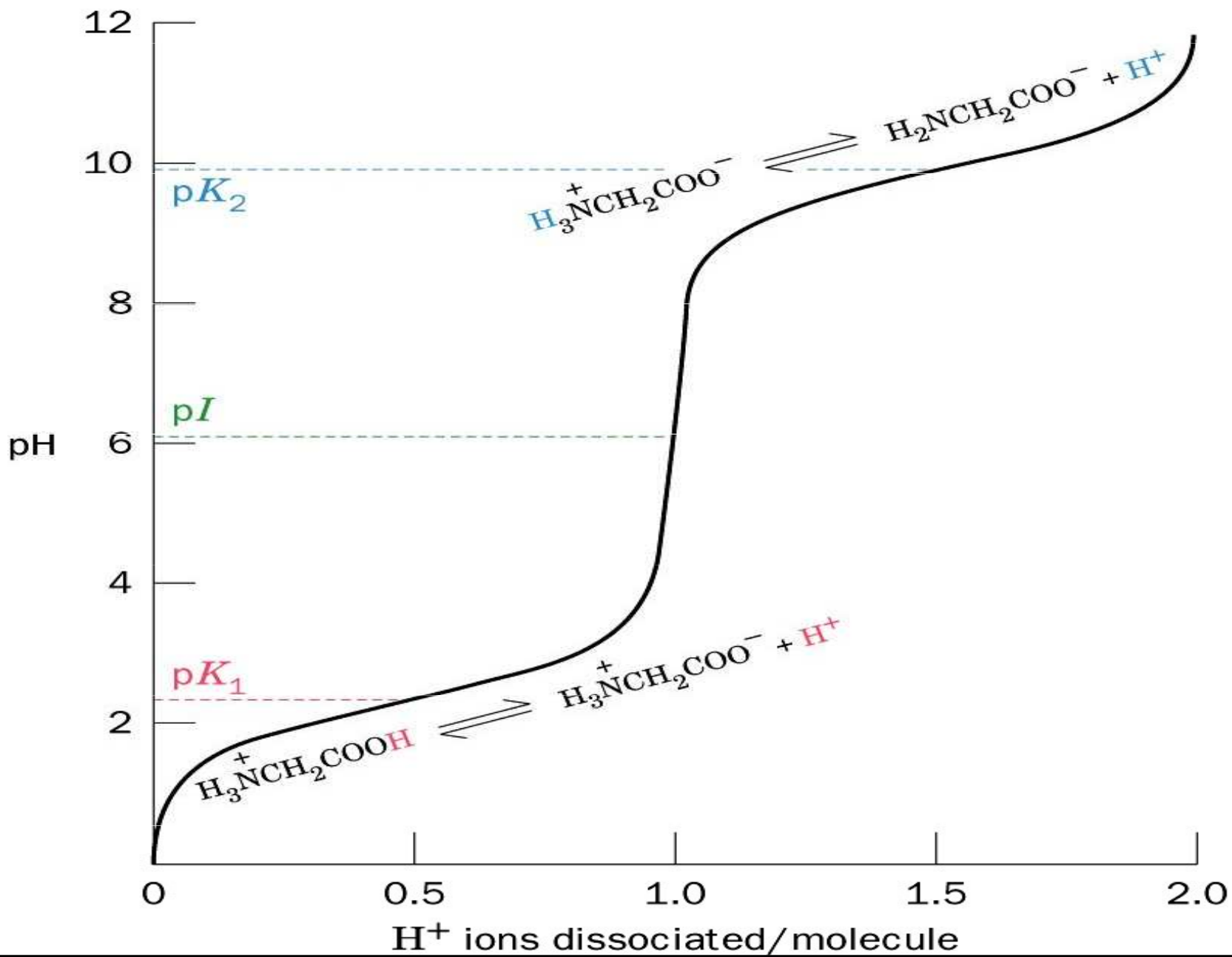

Henderson-Hasselbachova rovnice

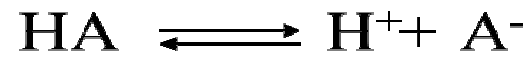

$$K_a = \frac{[\text{H}^+][\text{A}^-]}{[\text{HA}]}$$

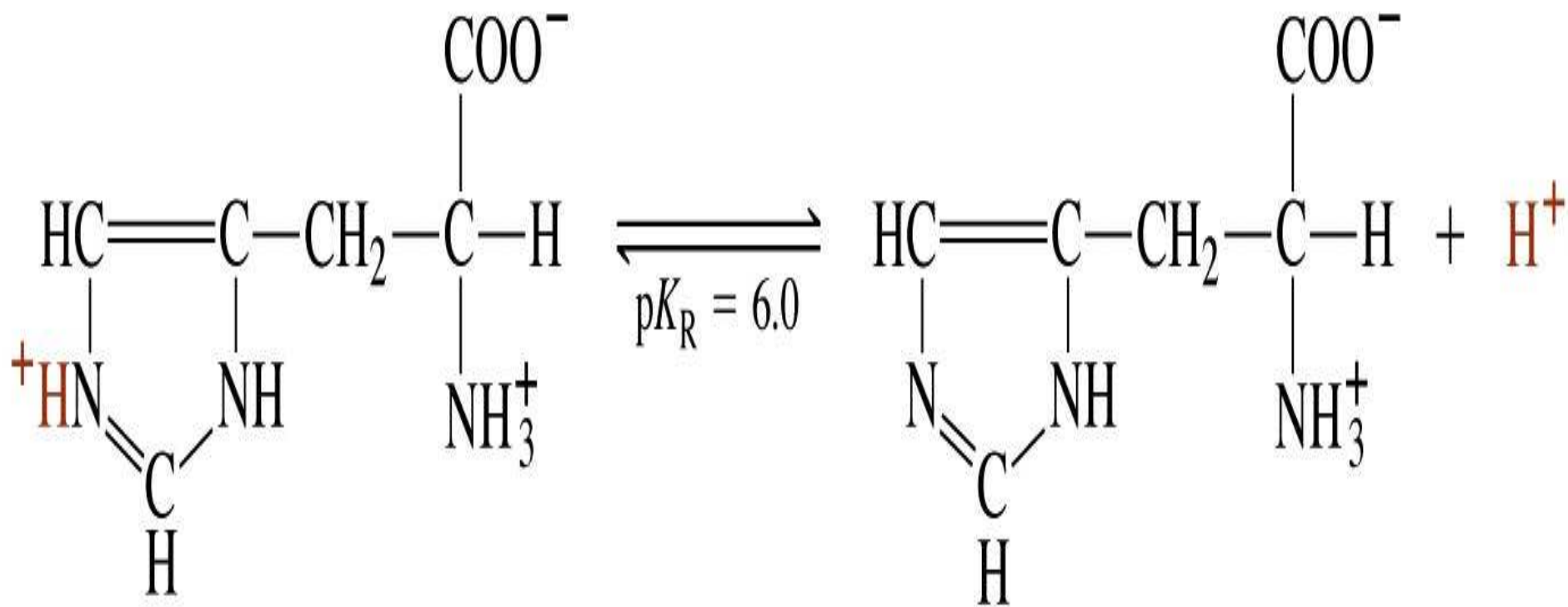

Histidine (His)

OPTICKÁ AKTIVITA

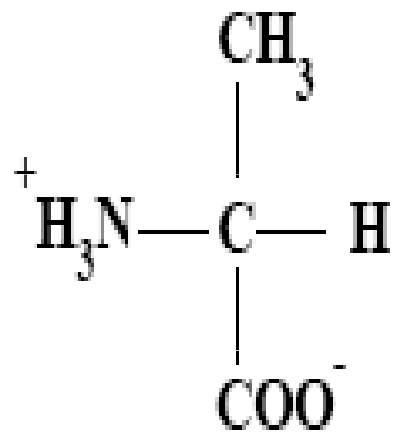

L -alanin

L

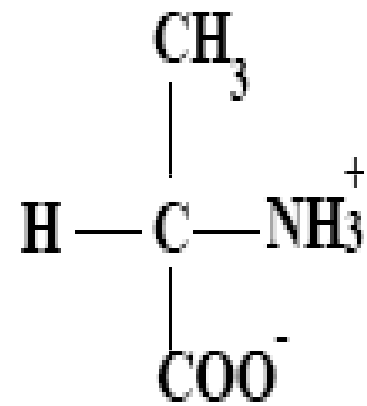

D-alanin

R

enantiomery

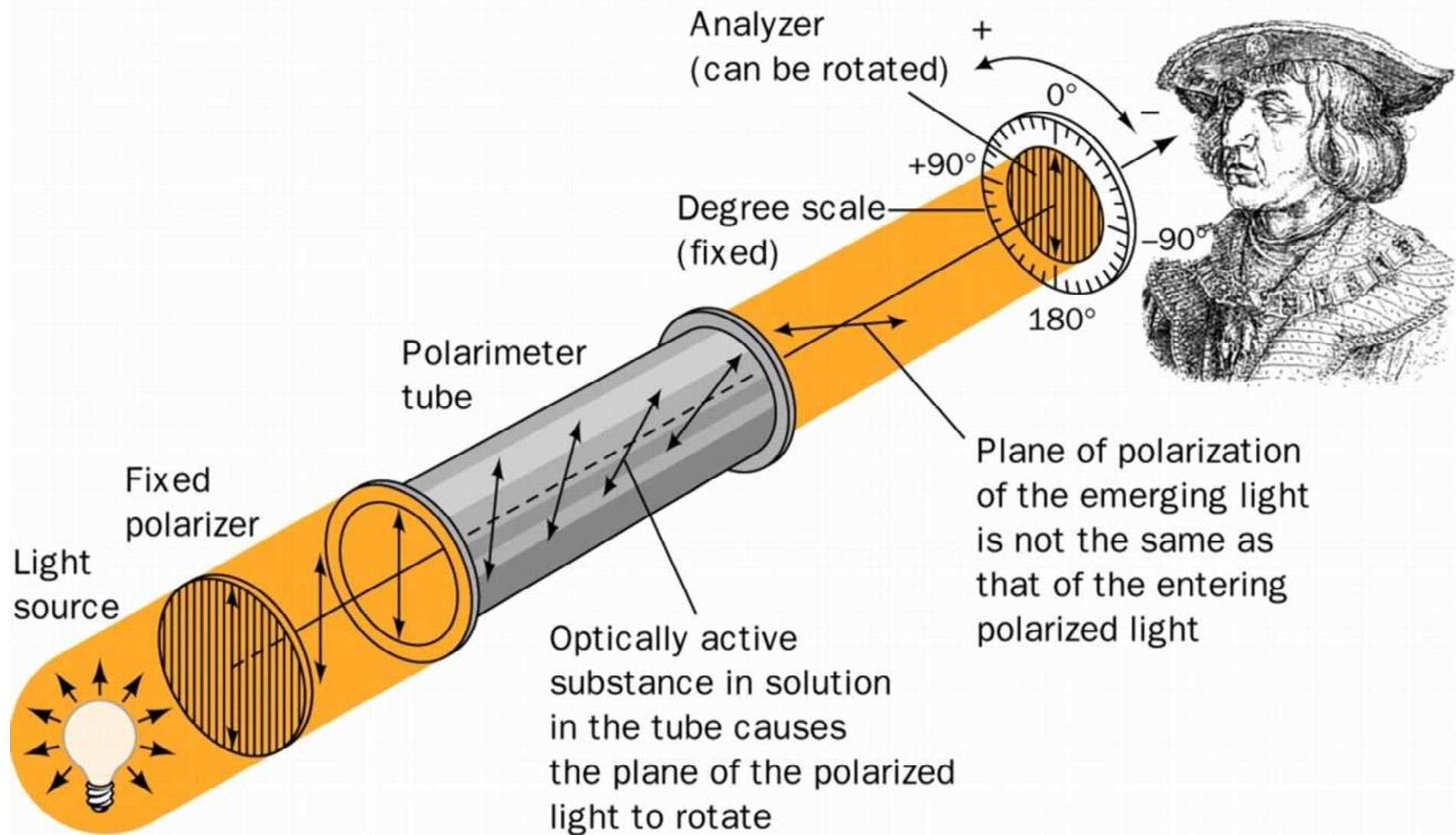

Thalidomid

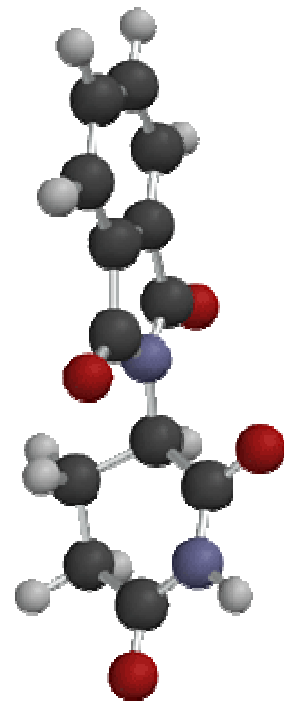

(R)-(+)-Thalidomide

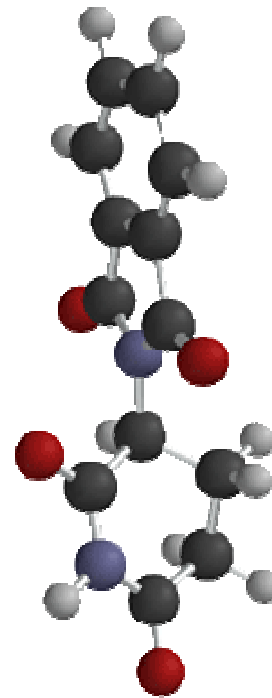

(S)-(-)-Thalidomide

Thalidomid



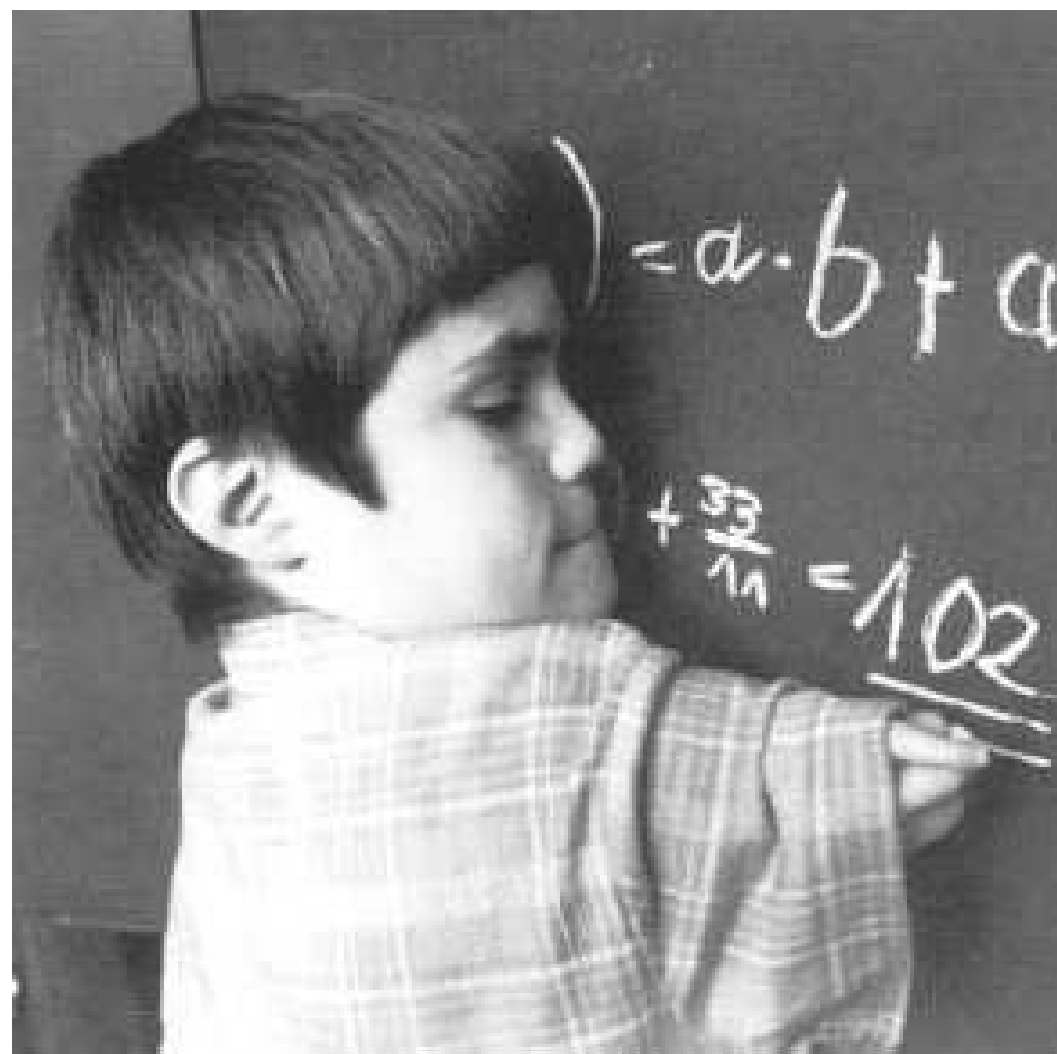

Thalidomid

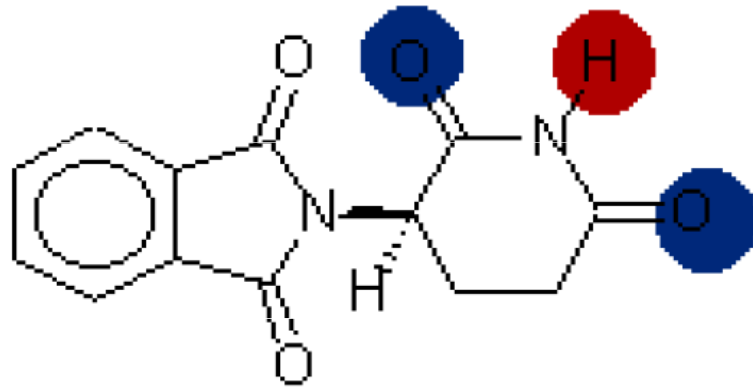

Thalidomid

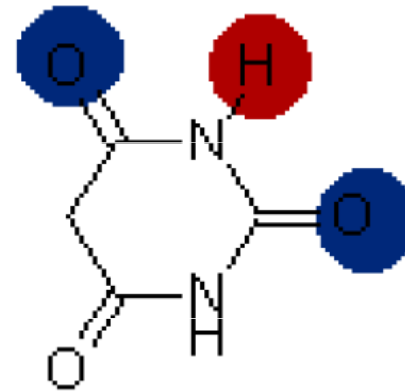

Barbitursäure

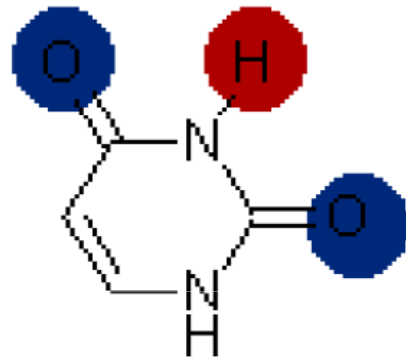

Uracil

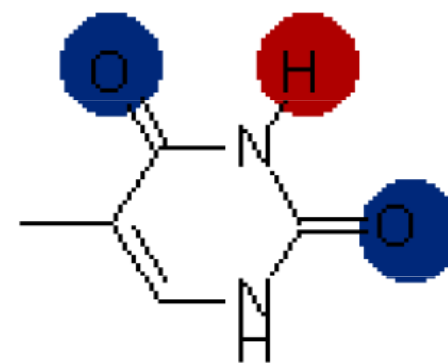

Thymin

OPTICKÁ AKTIVITA

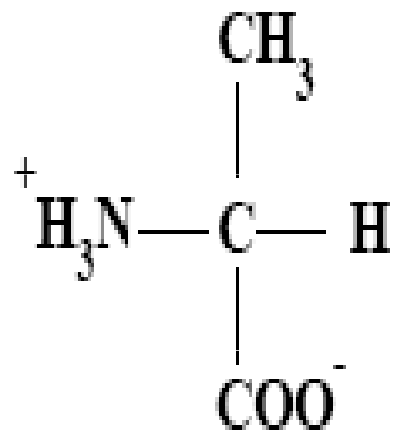

L -alanin

L

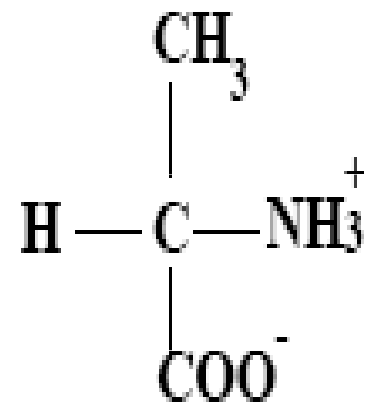

D-alanin

R

enantiomery

L AMK - CO-R-N

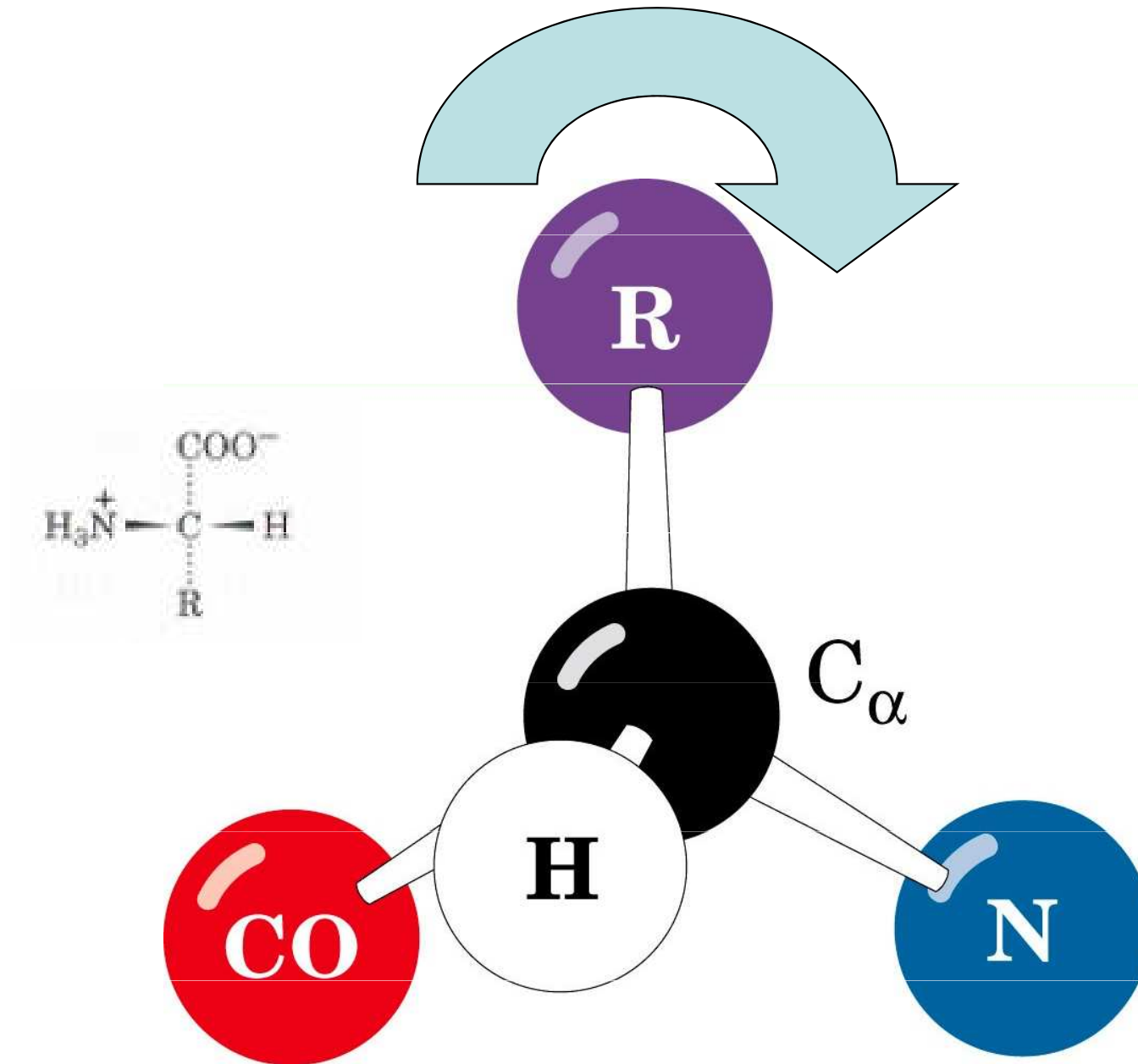

Diastomery threoninu

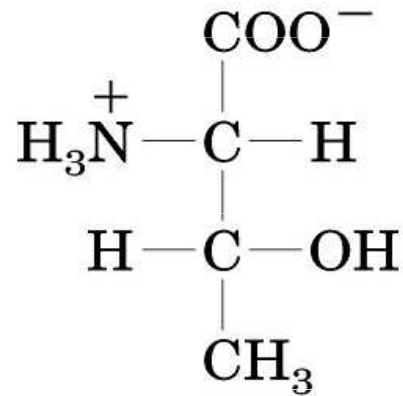

L-Threonine

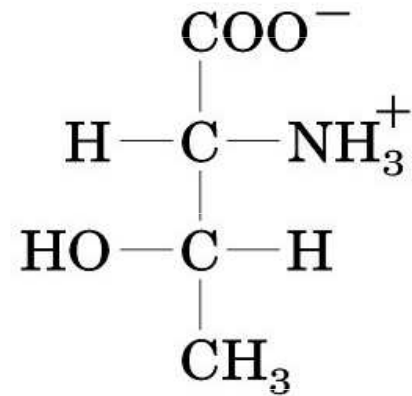

D-Threonine

Mirror
plane

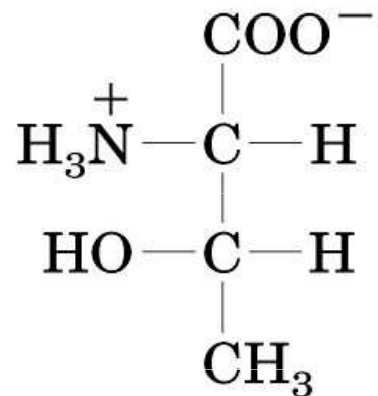

L-*allo*-Threonine

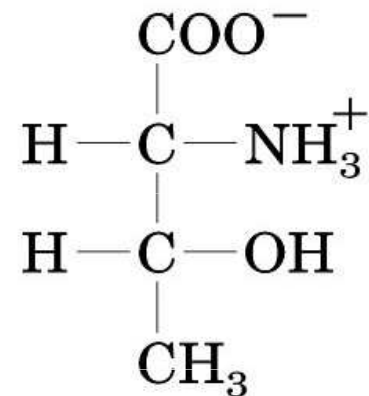

D-*allo*-Threonine

CHEMICKÉ VLASTNOSTI

- reakce dané přítomností COOH a NH₂ skupin

ninhydrinová reakce - NH₂

- reakce vedlejších skupin

reakce Sakaguchiho - guanidinová skupina

xantoproteinová reakce - aromatické aminokyseliny

Paulyho reakce - tyrosin

Adamkiewiczova reakce - indol

Ninhydrinová reakce

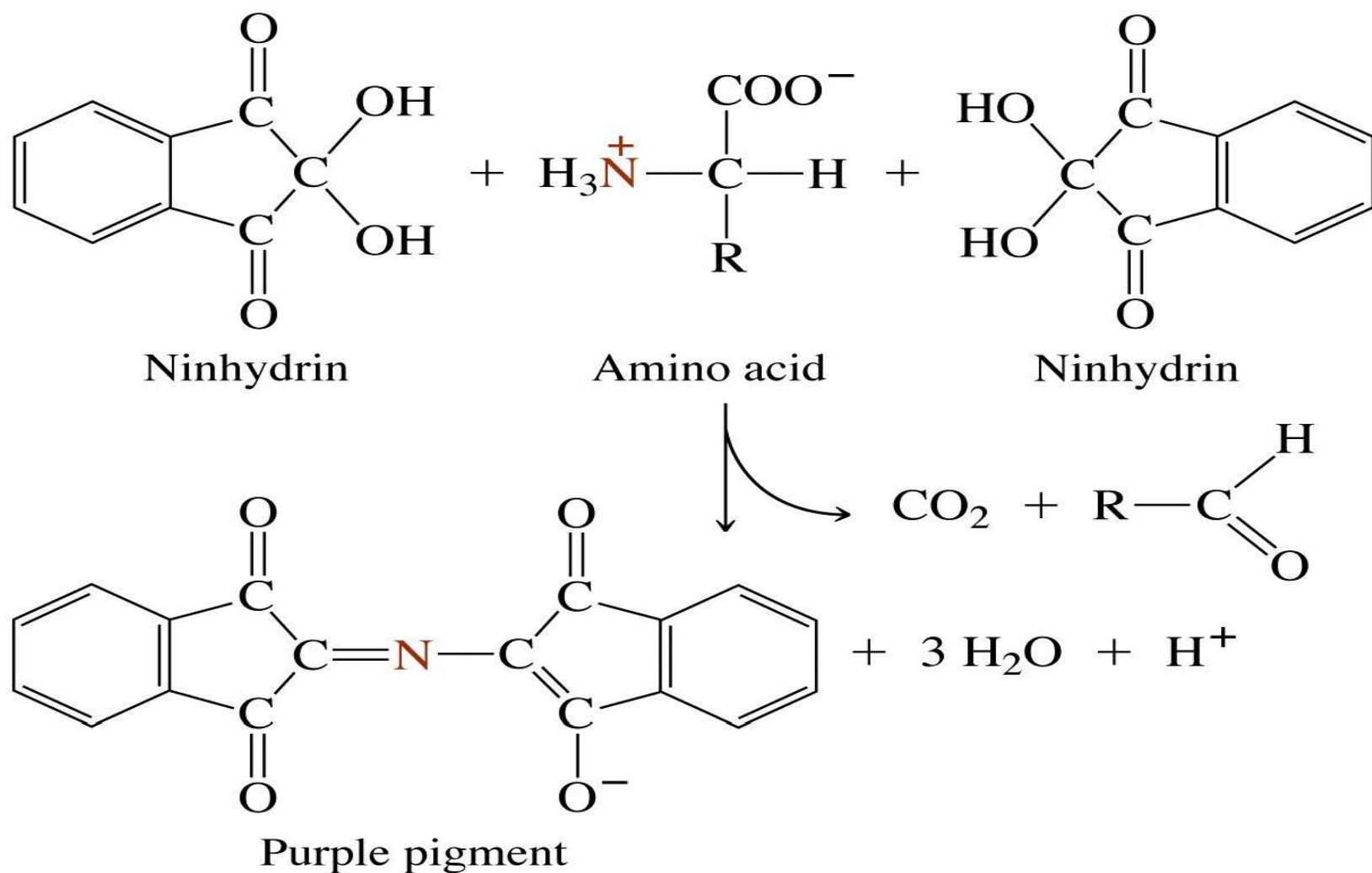

Reakce AMK s dansylchloridem

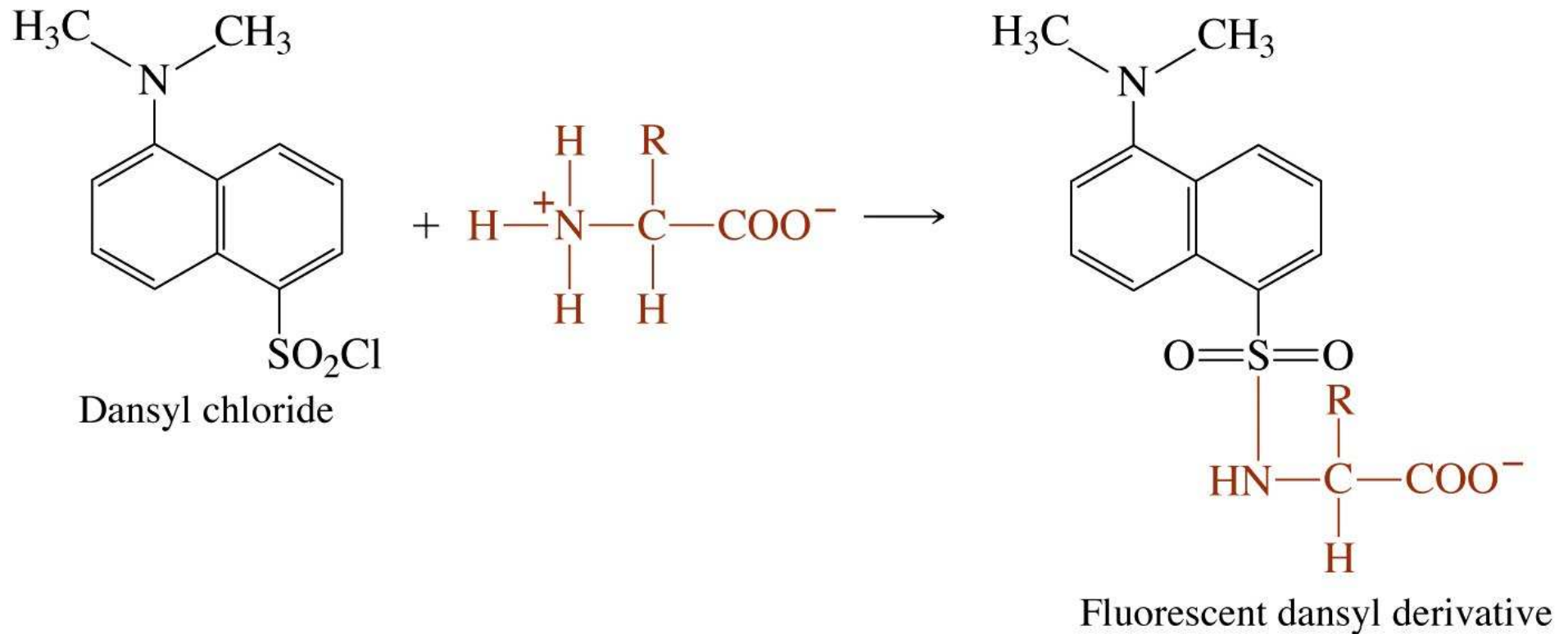

Analýza aminokyselin

- papíroví a tenkovrstvá chromatografie
- ionexová chromatografie
- reverzně fázová chromatografie

Papírová chromatografie AMK

Martin Syngge Nobelova cena za chemii 1952

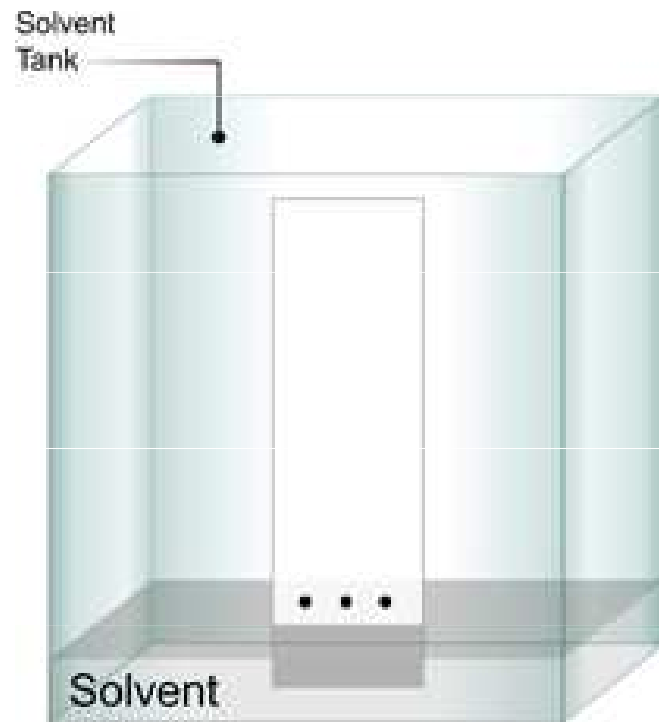

Time Zero

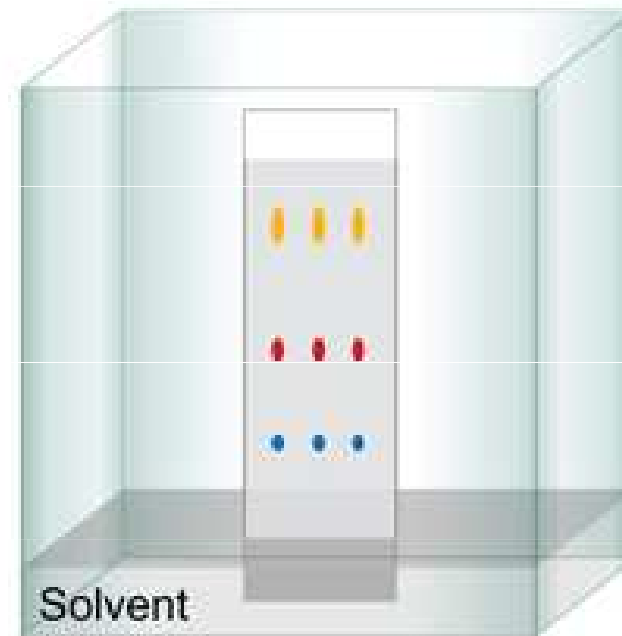

After Ten Minutes

Papírová chromatografie AMK

Martin Syngge Nobelova cena za chemii 1952



Mikhail Semyonovich Tsvet

Chromatographia 1906

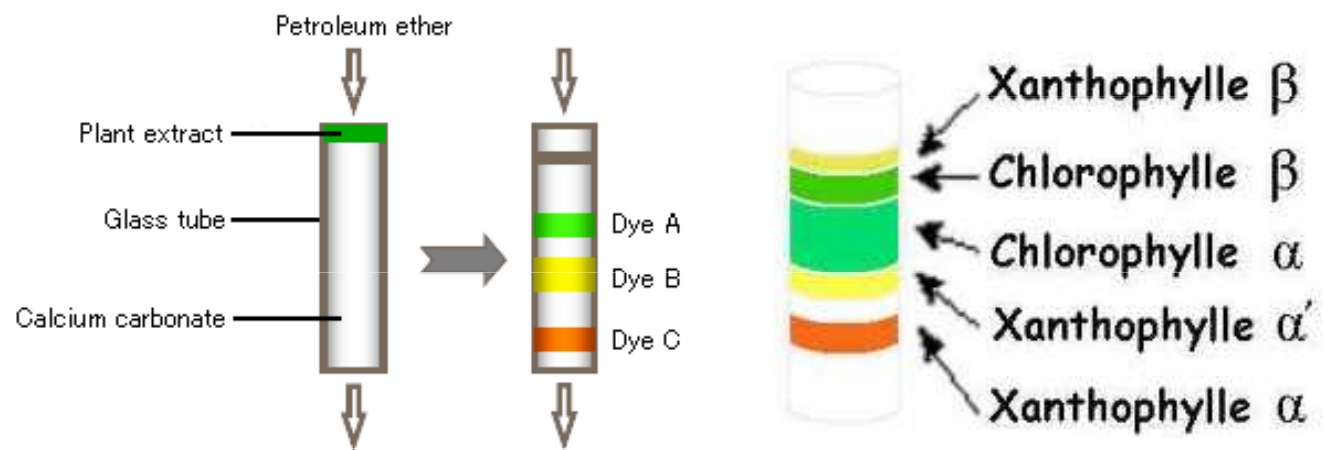
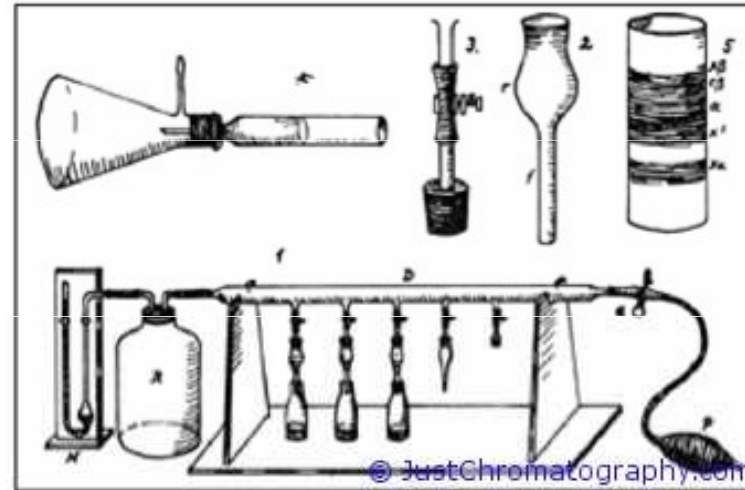

Kolonová chromatografie

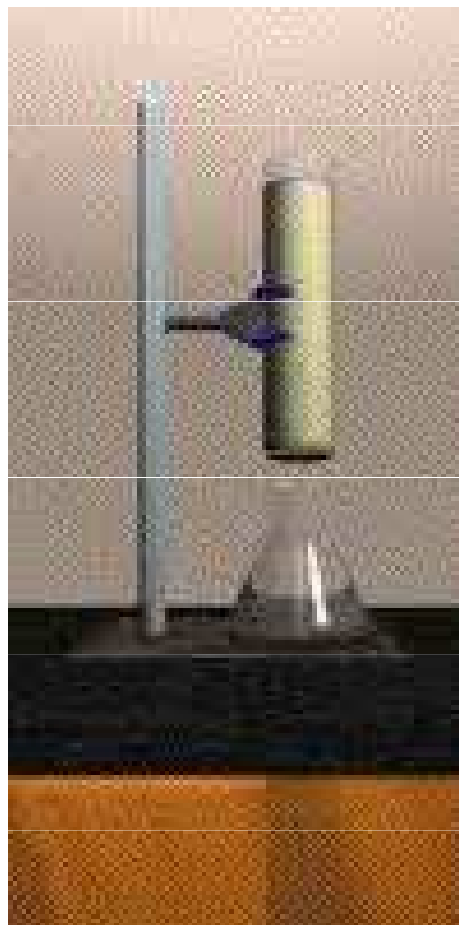

RP HPLC AMK

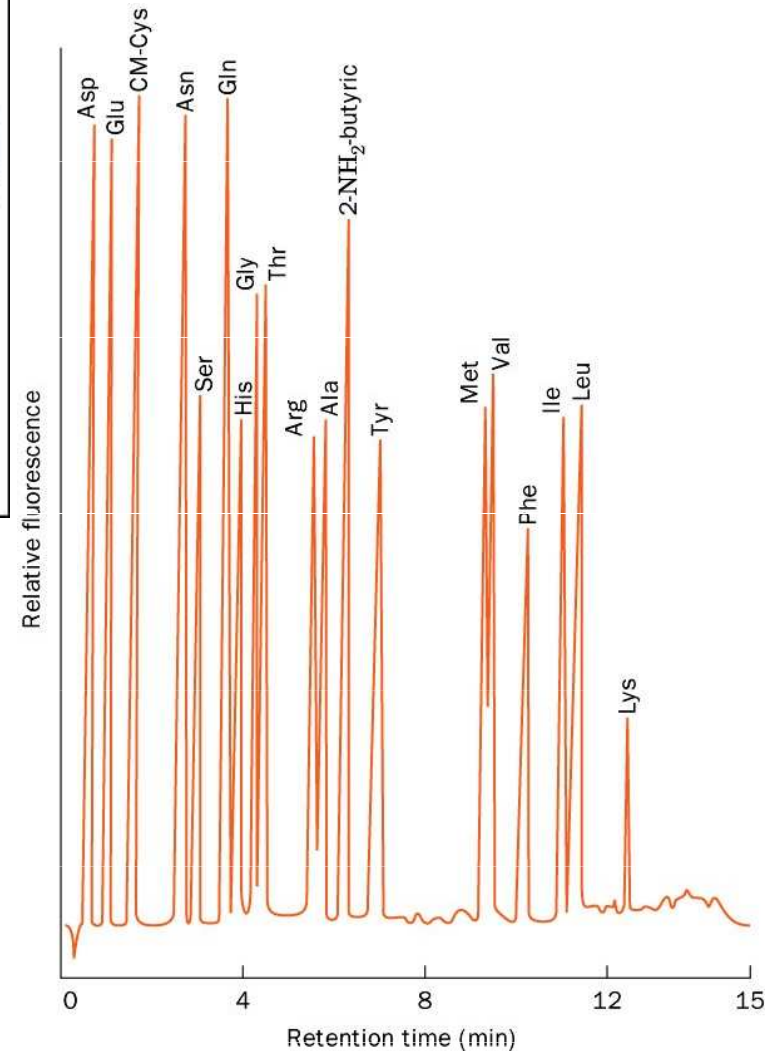
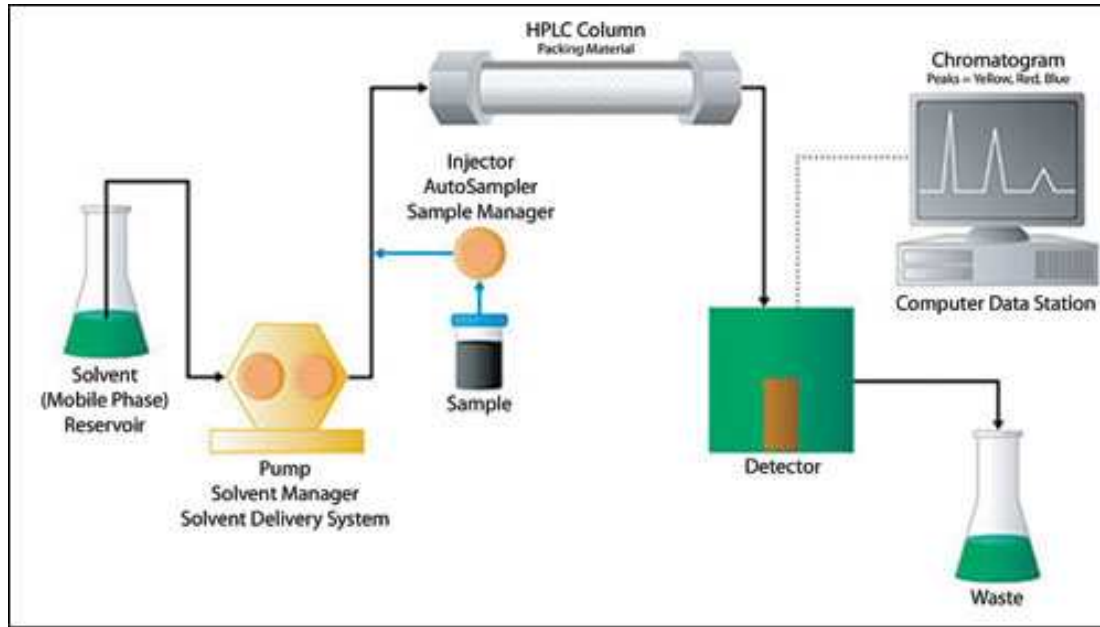

PEPTIDY :

(E.FISHER 1902)

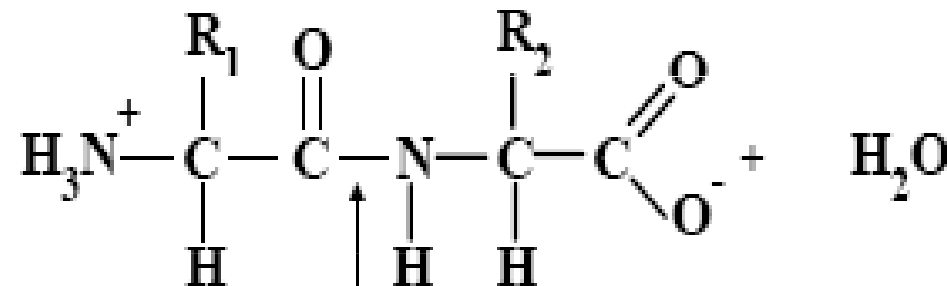
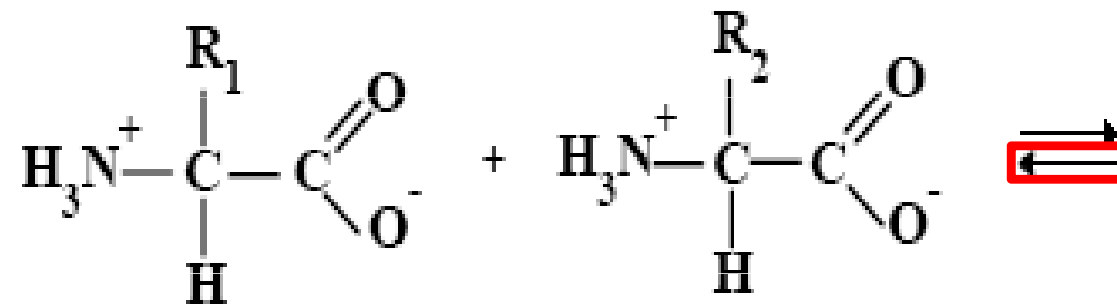

↑
Peptidická vazba - amidová vazba

di, tri, tetra oligopeptidy polypeptidy

Názvosloví peptidů



glycyl-arginyl-histidin

Biosyntéza peptidů - meziprodukty odbourávání bílkovin

- jednoduchá biosyntéza bez proteosyntézy

Přírodní peptidy:

Di - karnosin

anserin

Tri - glutathion GSH

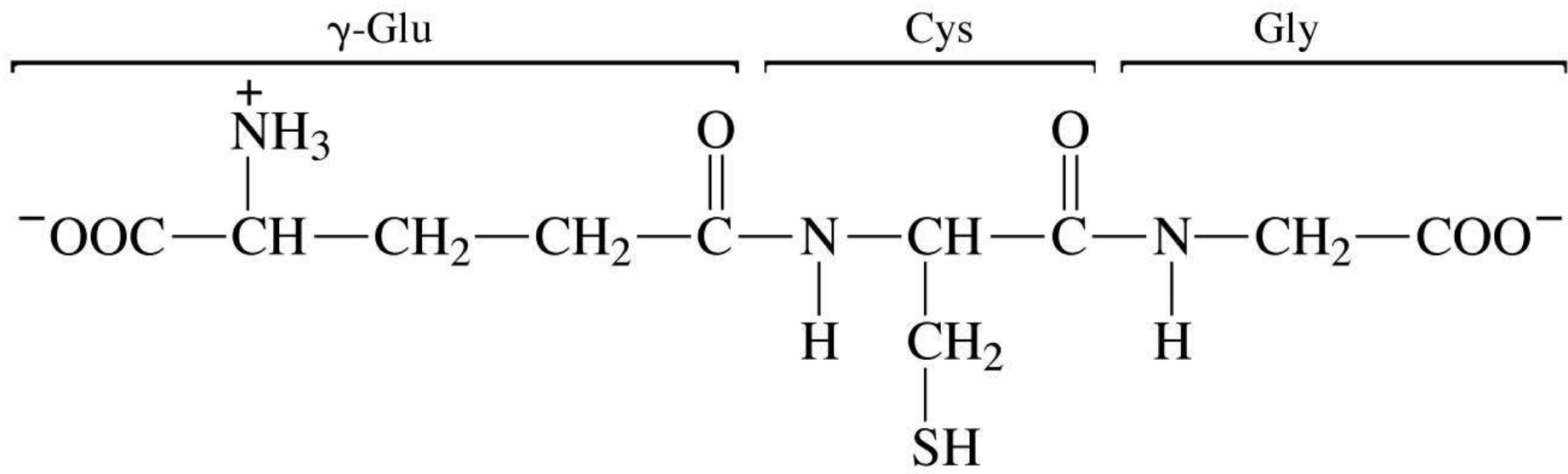

Glutathione (GSH)
(reduced)

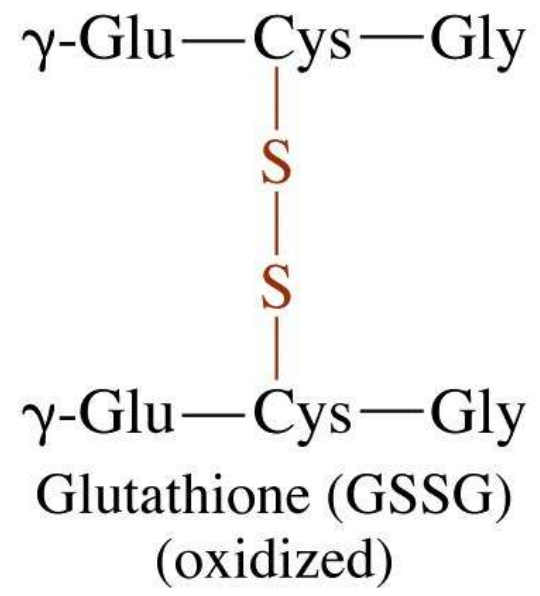

Figure 3-11a Concepts in Biochemistry, 3/e
© 2006 John Wiley & Sons

Přírodní peptidy:

Di - karnosin
anserin

Tri - glutathion GSH

Peptidové hormóny - oxytosin
vasopresin
inzulin
glukagon

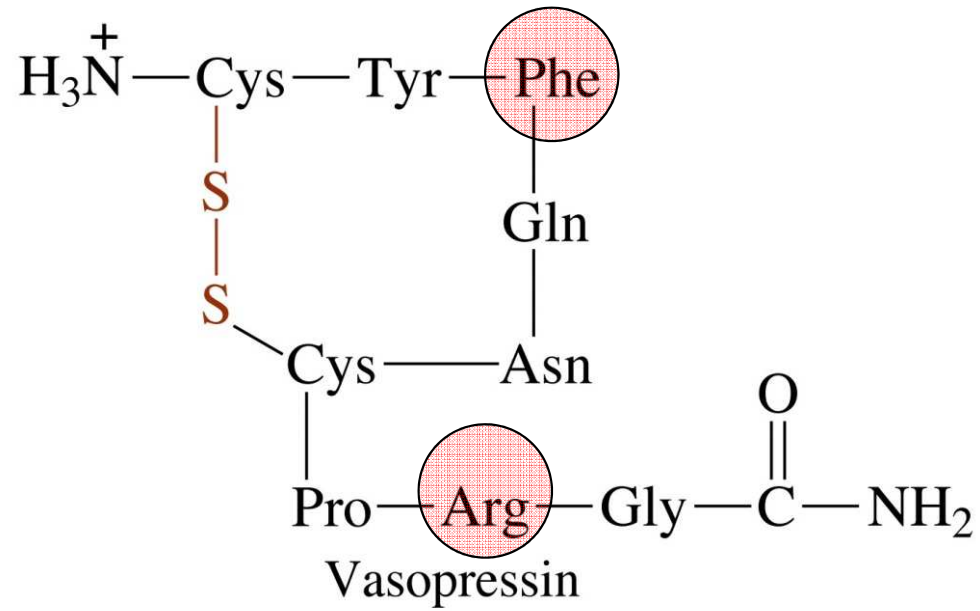

Figure 3-11c Concepts in Biochemistry, 3/e
© 2006 John Wiley & Sons

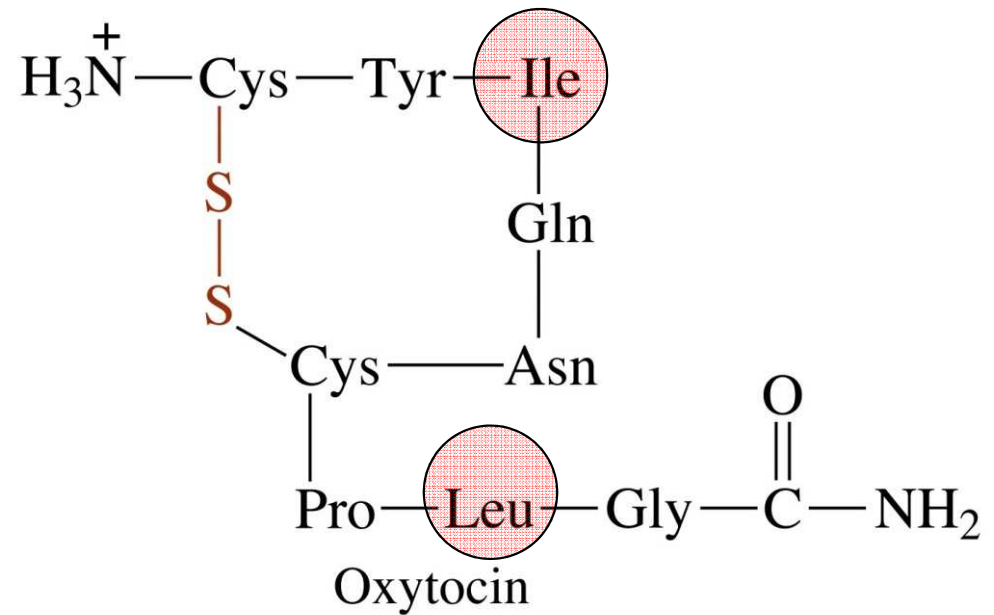
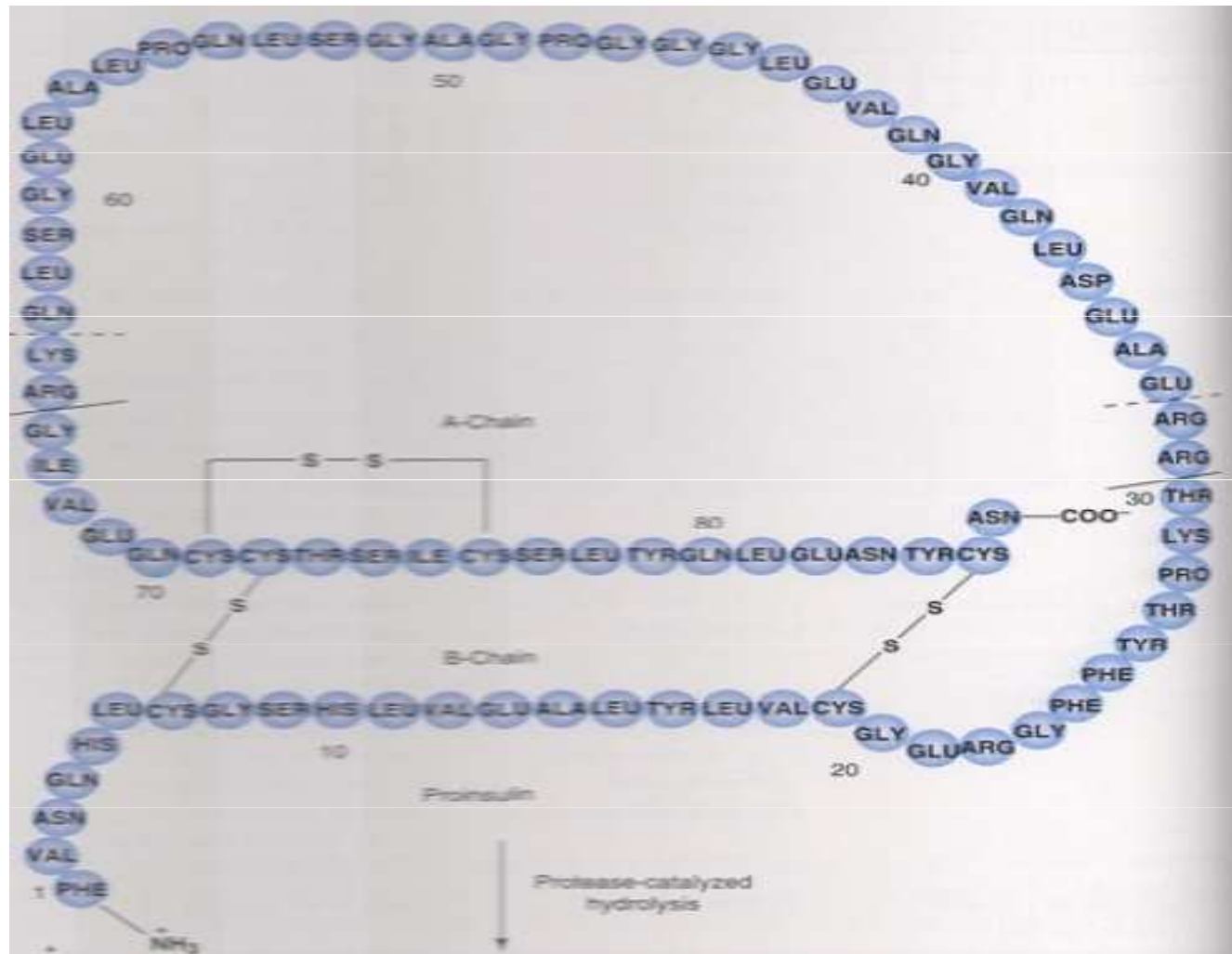
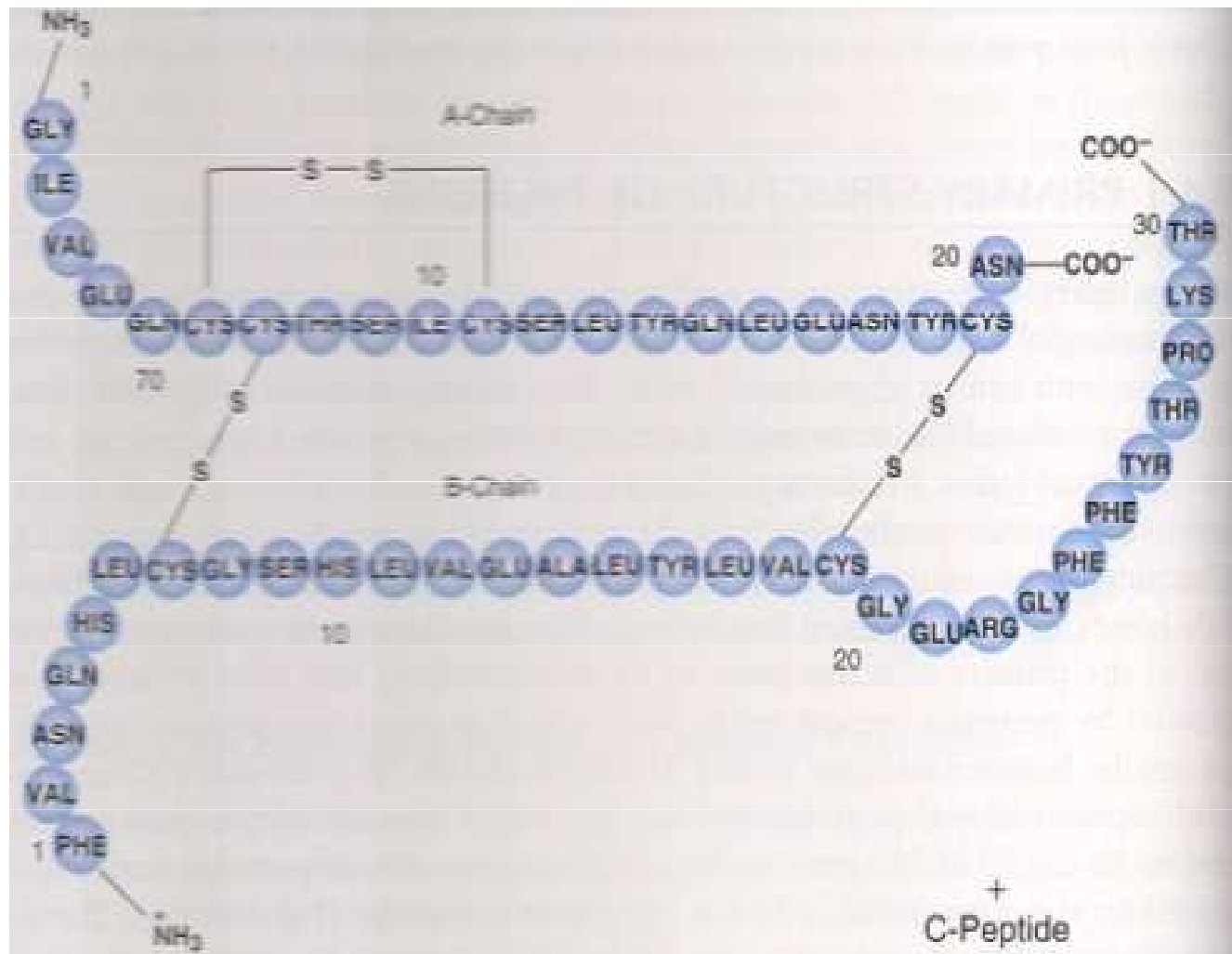

Figure 3-11b Concepts in Biochemistry, 3/e
© 2006 John Wiley & Sons

Proinzulín 84 AMK



Inzulín – 51 AMK



Peptidové neuromodulátory

- enkefaliny 5 AMK
endorfiny 15-32 AMK

Tyr—Gly—Gly—Phe—Leu
Leucine enkephalin

Tyr—Gly—Gly—Phe—Met
Methionine enkephalin

Figure 3-11e Concepts in Biochemistry, 3/e
© 2006 John Wiley & Sons

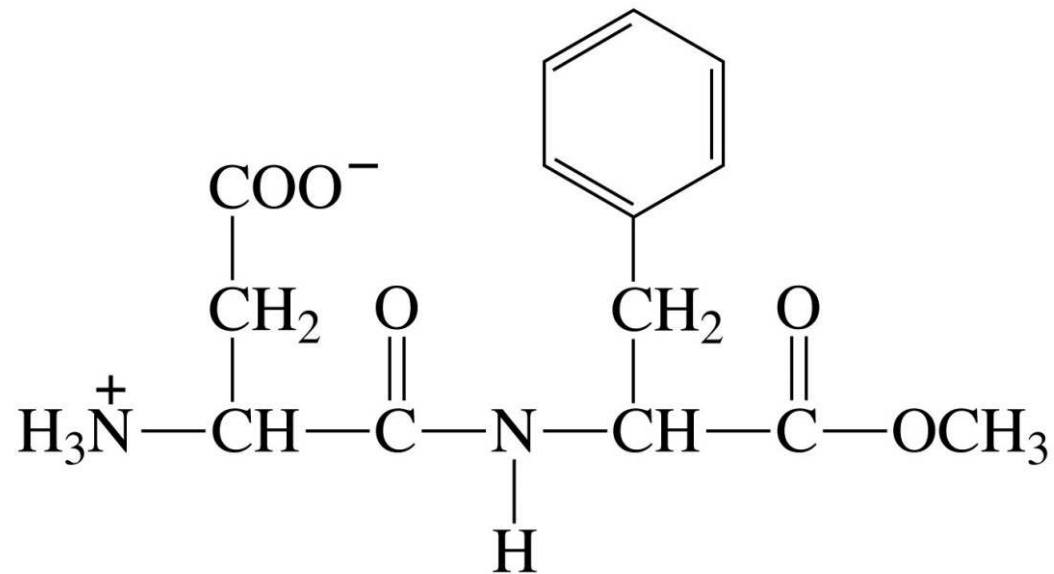

L-Aspartyl-L-phenylalanine methyl ester
(aspartame)

Peptidové neuromodulátory - enkefaliny
endorfiny

Peptidová antibiotika - penicilin
gramicidin
valinomycin
aktinomycin

Peptidové fyto a zootoxiny - neurotoxiny hadů štírů a včel
mikrocystiny
falloidin
amanitin

Polypeptidy - protaminy

Falotoxiny

Amanitin

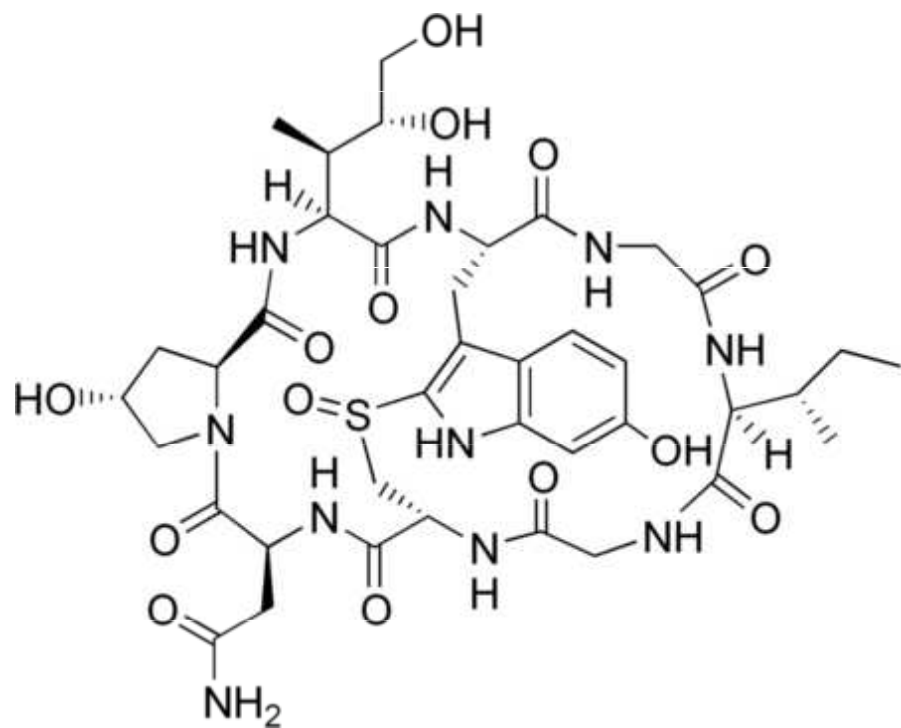

Faloidin

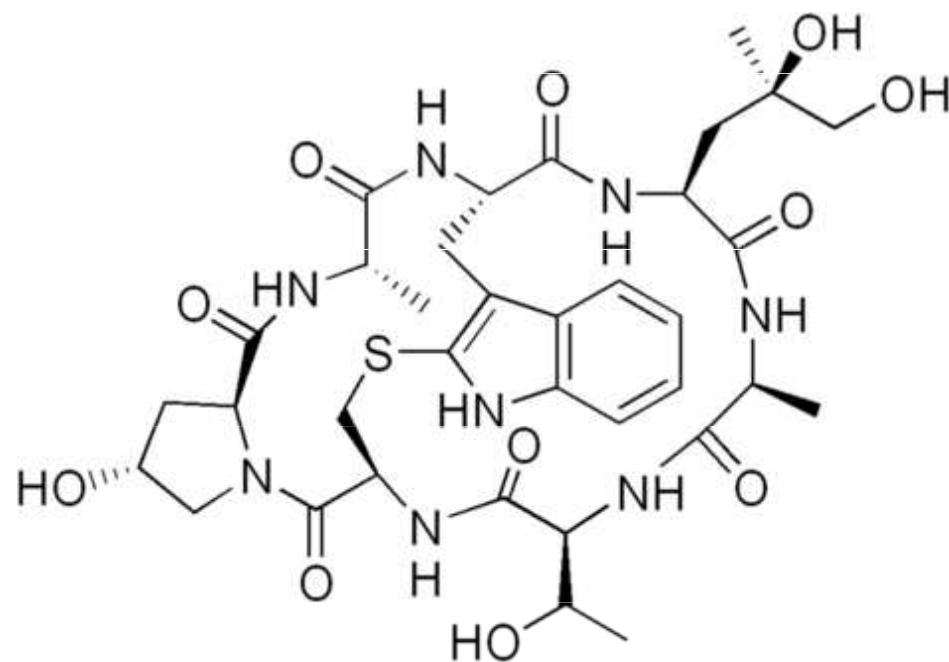

Amanita phalloides





A. PILÁT
O. UŠÁK



Kapesní
**ATLAS
HUB**

SPN

můrka hlišovitá obsahuje několik jedovatých látek. Roku 1937 podařilo se Lynenovi a Wielandovi izolovat z ní v krystalované podobě jedovatou látku, zvanou p h a l l o i d i n. Oba badatelé zjistili, že $\frac{1}{10}$ miligramu této látky usmrtí myš ve 12 hodinách. V roce 1941 izolovali

Wieland a Hallermayer hlavní jed muchomůrky hlišovité, tzv. a m a n i t i n, který je tak prudce jedovatý, že jedna dvouseštiná miligramu usmrtí myš ve 2–3 dnech. Je to dávka tak nepatrná, že množství jedu, které bychom nabrali na špičku nože (o váze $\frac{1}{4}$ g), usmrtilo by 100 000 myši, které, seřazeny za sebou, utvořily by řadu 18 km dlouhou, podle níž bychom si vykračovali $4\frac{1}{2}$ hodiny vojenským krokem. Otrava muchomůrkou hlišovitou obvykle končí smrtí.

Microcystiny

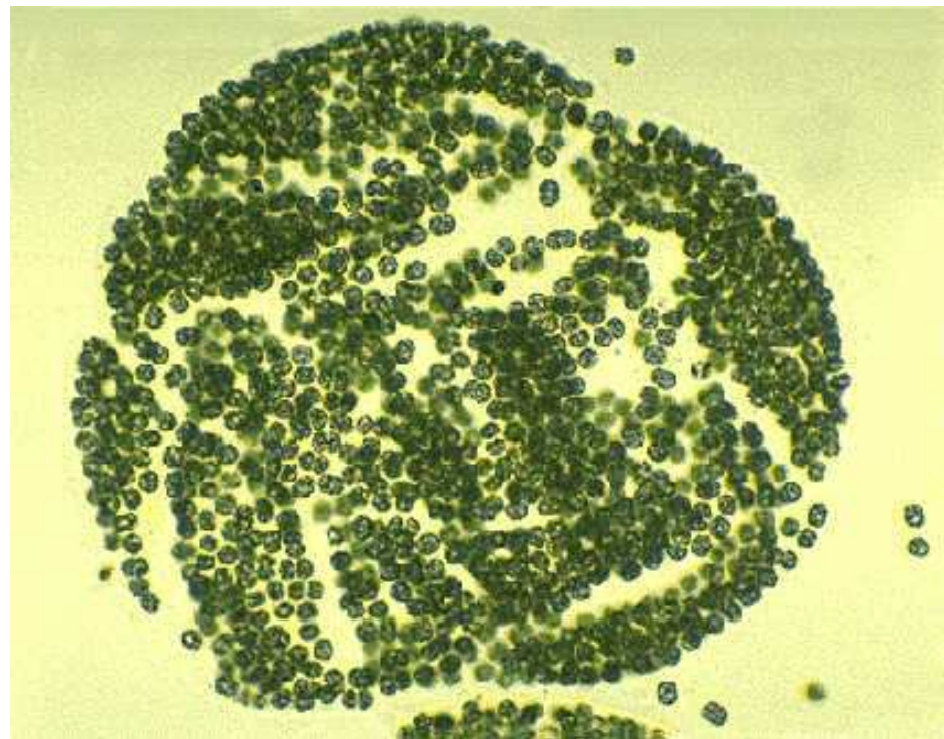

Microcystins

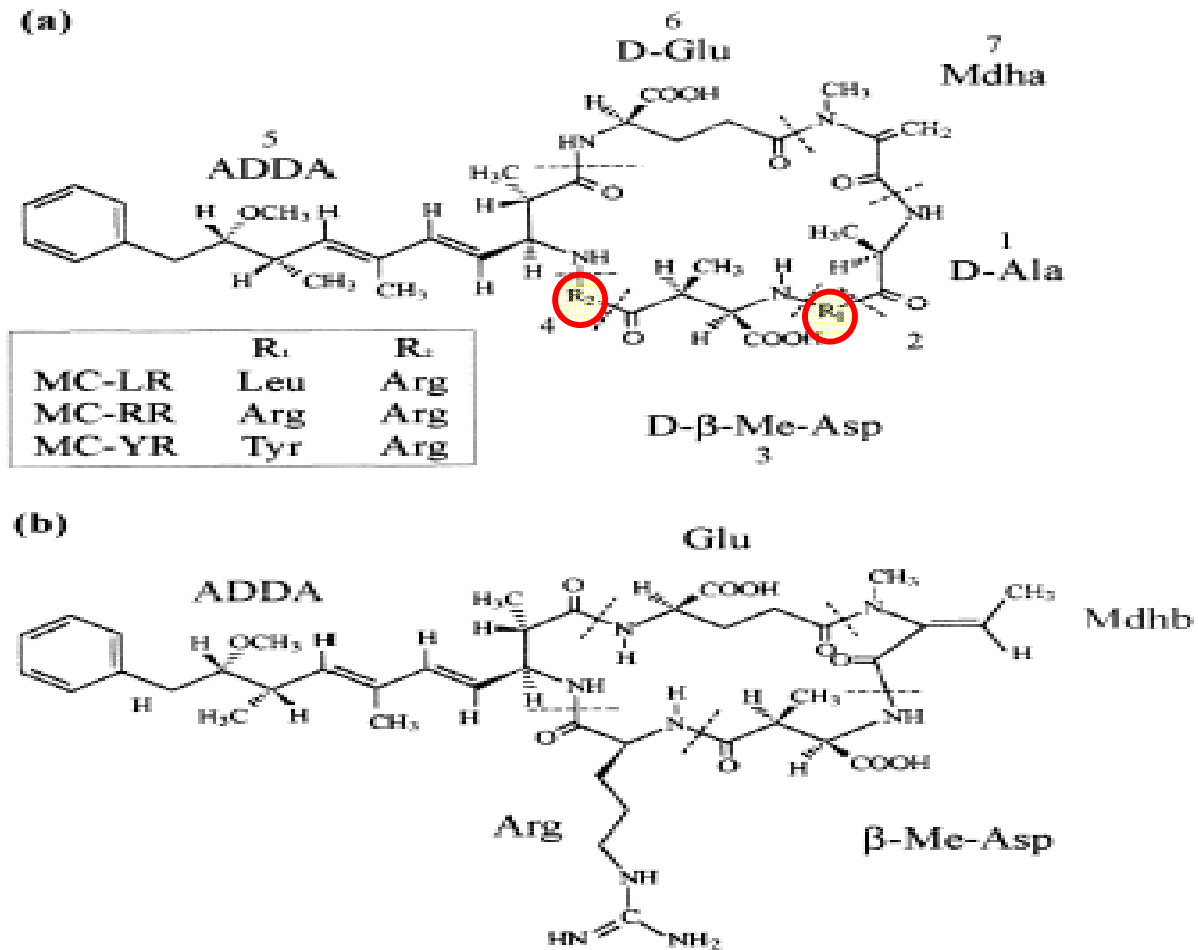

Fig. 1. General chemical structure of (a) microcystins and (b) nodularins.

BÍLKOVINY :

Funkce



(a) – Lys – Ala – His – Gly – Lys – Lys – Val – Leu – Gly – Ala –
Primary structure (amino acid sequence in a polypeptide chain)

Konformace

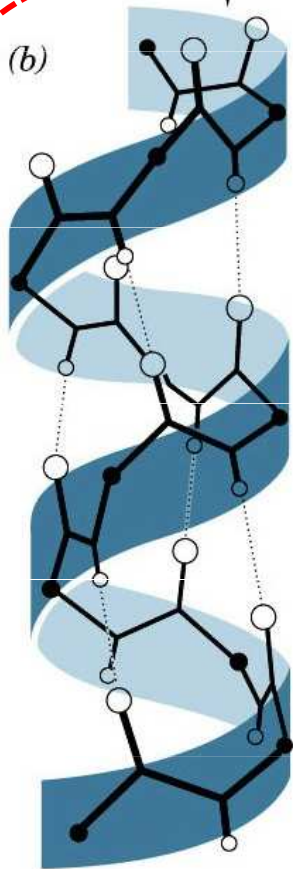

Secondary structure (helix)

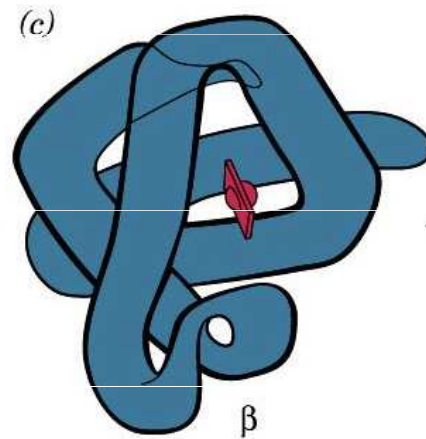

Tertiary structure:
one complete protein chain
(β chain of hemoglobin)

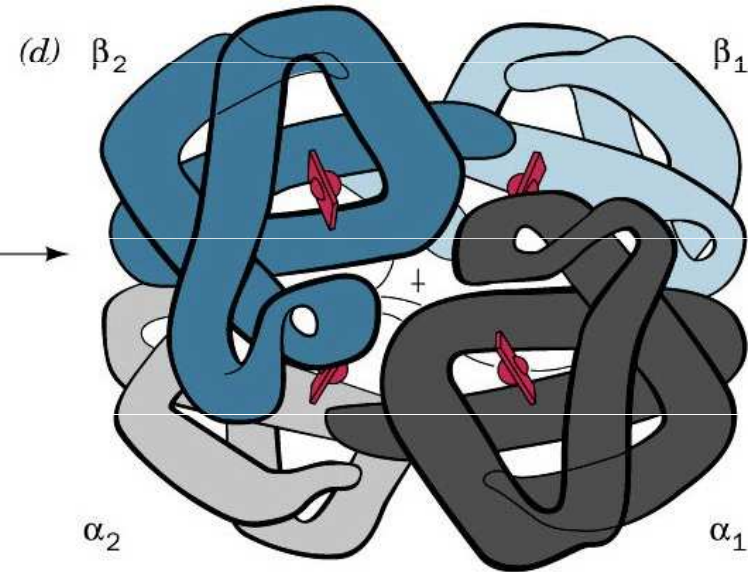

Quaternary structure:
the four separate chains
of hemoglobin assembled
into an oligomeric protein

Aminokyselinová analýza

1. Izolace homogenní bílkoviny
2. Úplná hydrolyza - kyselá - 6 M HCl, 100 - 120 °C, 10 - 100 hod.
 - bazická - 2 - 4 M NaOH, 100 °C, 4 - 8 hod.
 - enzymová - Pronasa
3. Aminokyselinová analýza -RP, IEX

AMK analyzátor

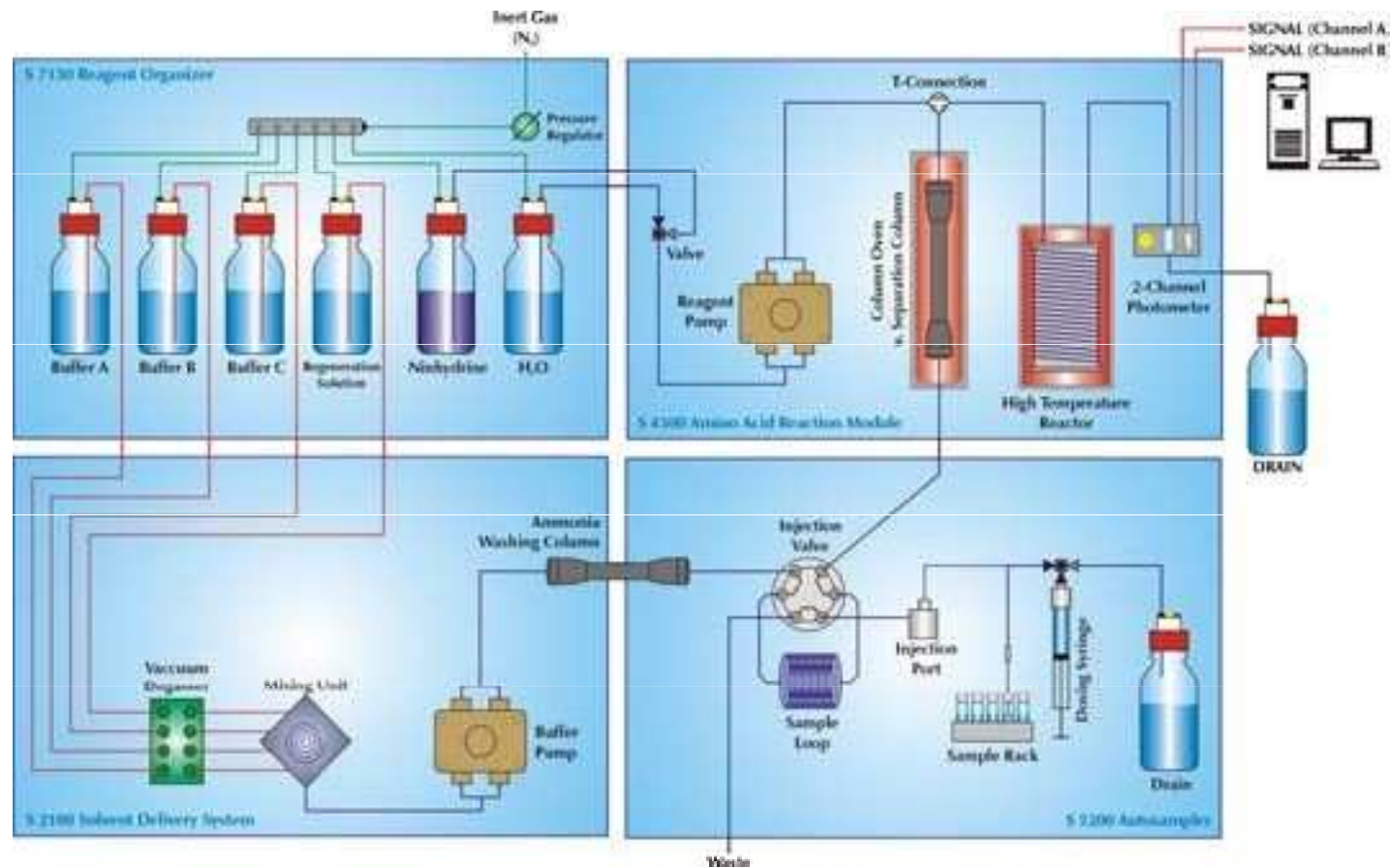

AMK analyzátor



Primární struktura

1953 - Sanger - inzulin (51 AMK), 100 g materiálu, 10 let

⇒ aminokyselinový sekvenátor

1978 - β -galaktosidasa (1028 AMK), μg materiálu, dny

Proč je nutné znát primární strukturu

- Pro objasnění vyšších struktur
- Pro porozumění jejich funkce
- Taxonomické evoluční studie
- Klinický význam

Taxonomické evoluční studie

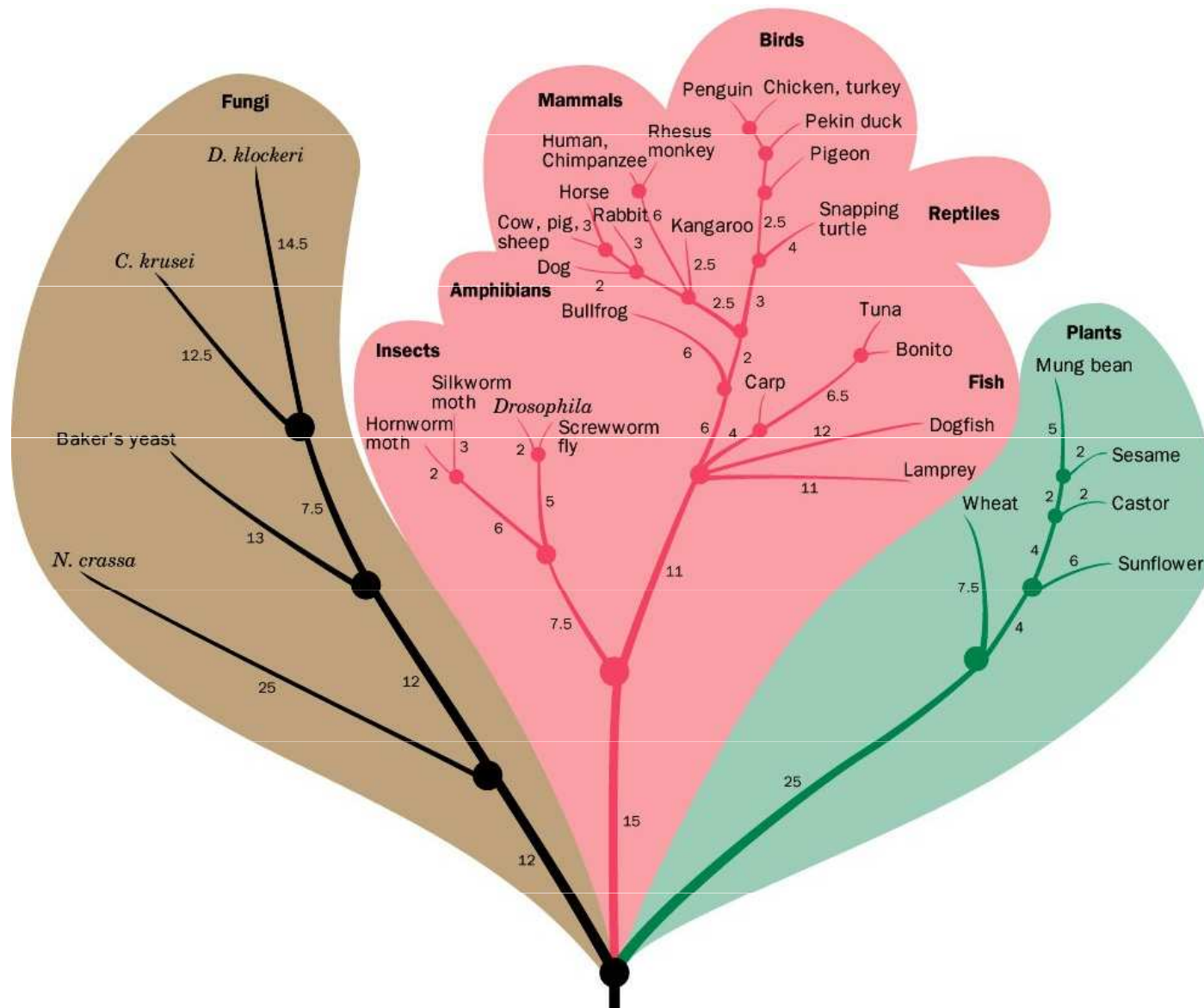

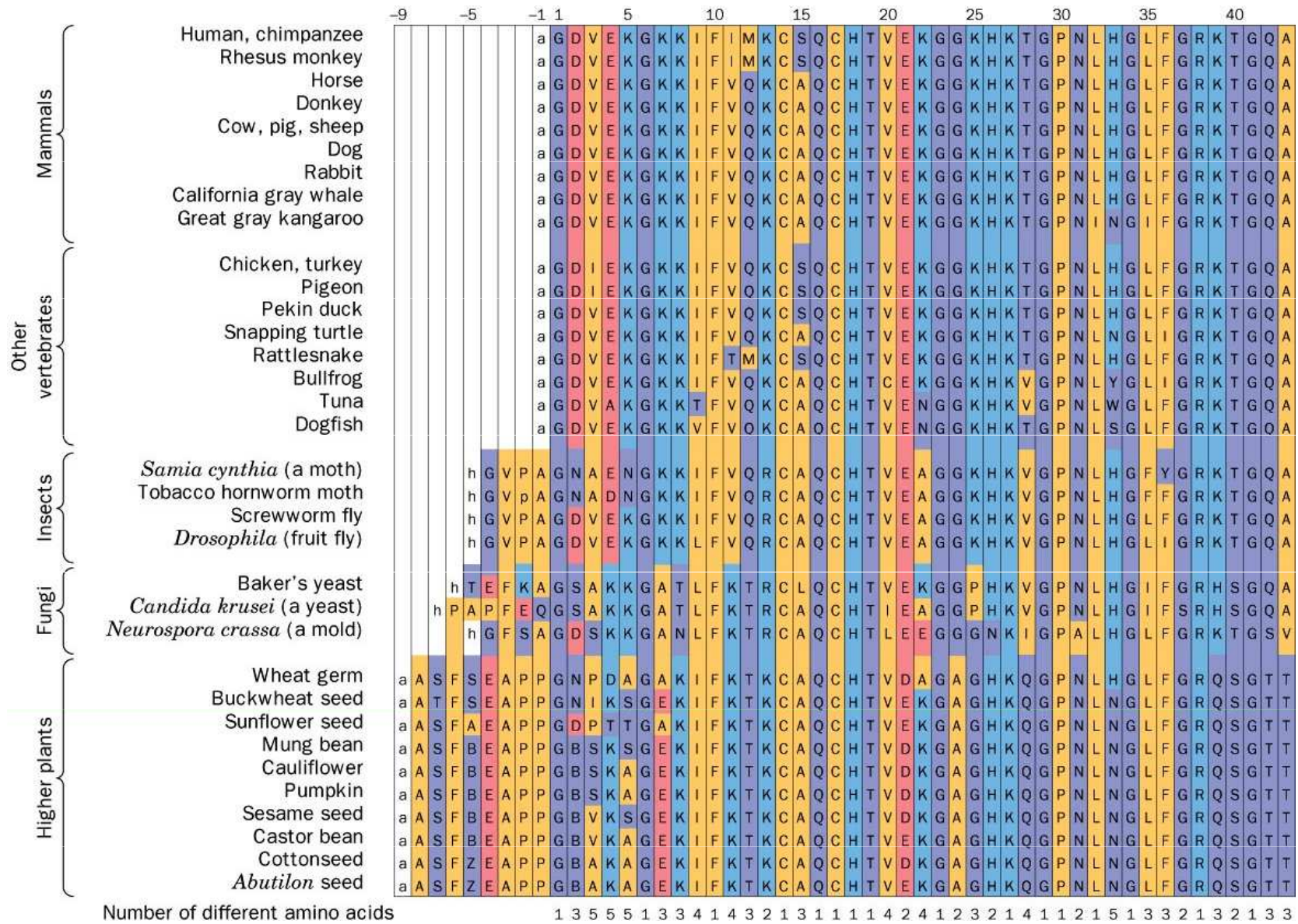

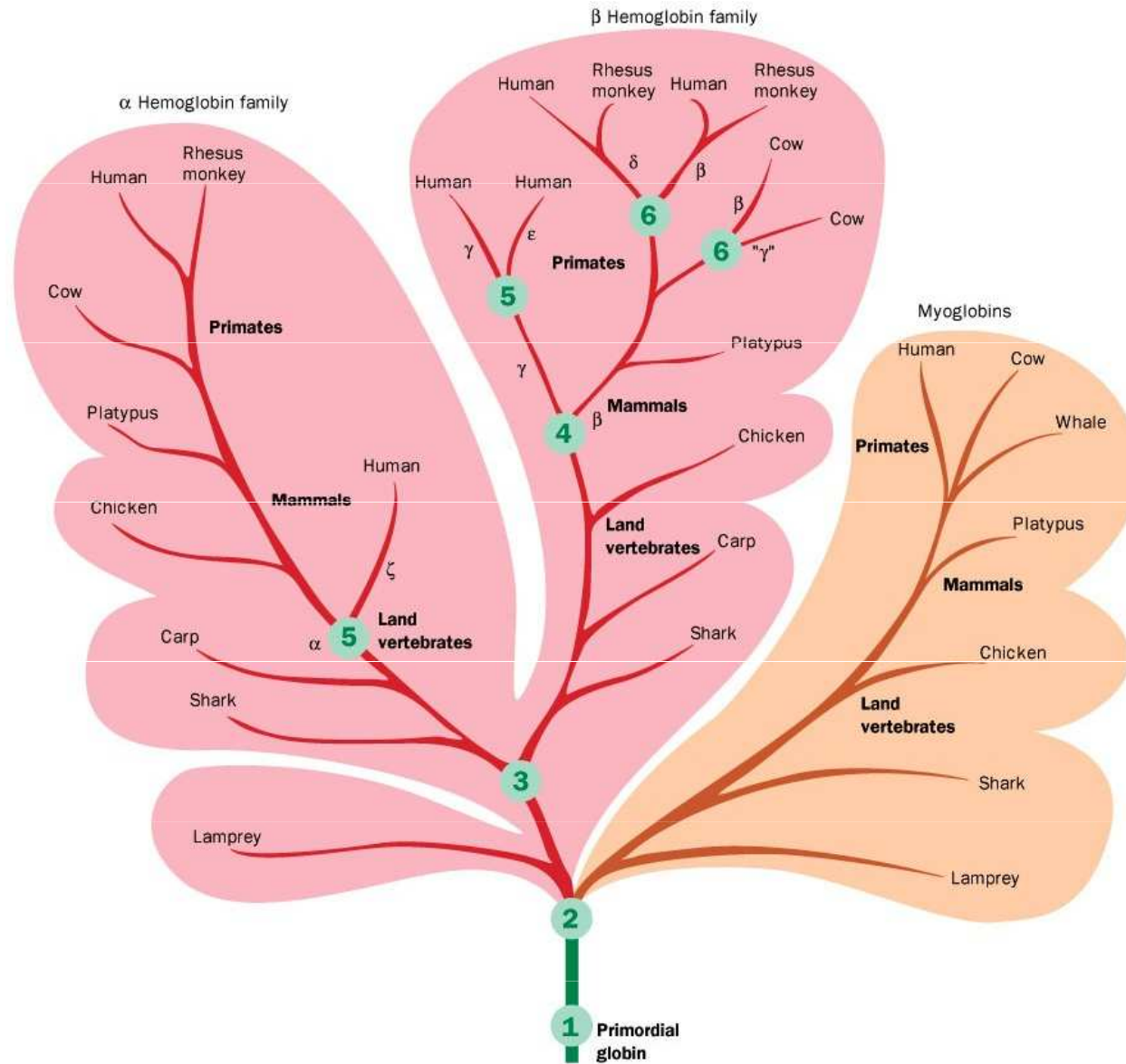

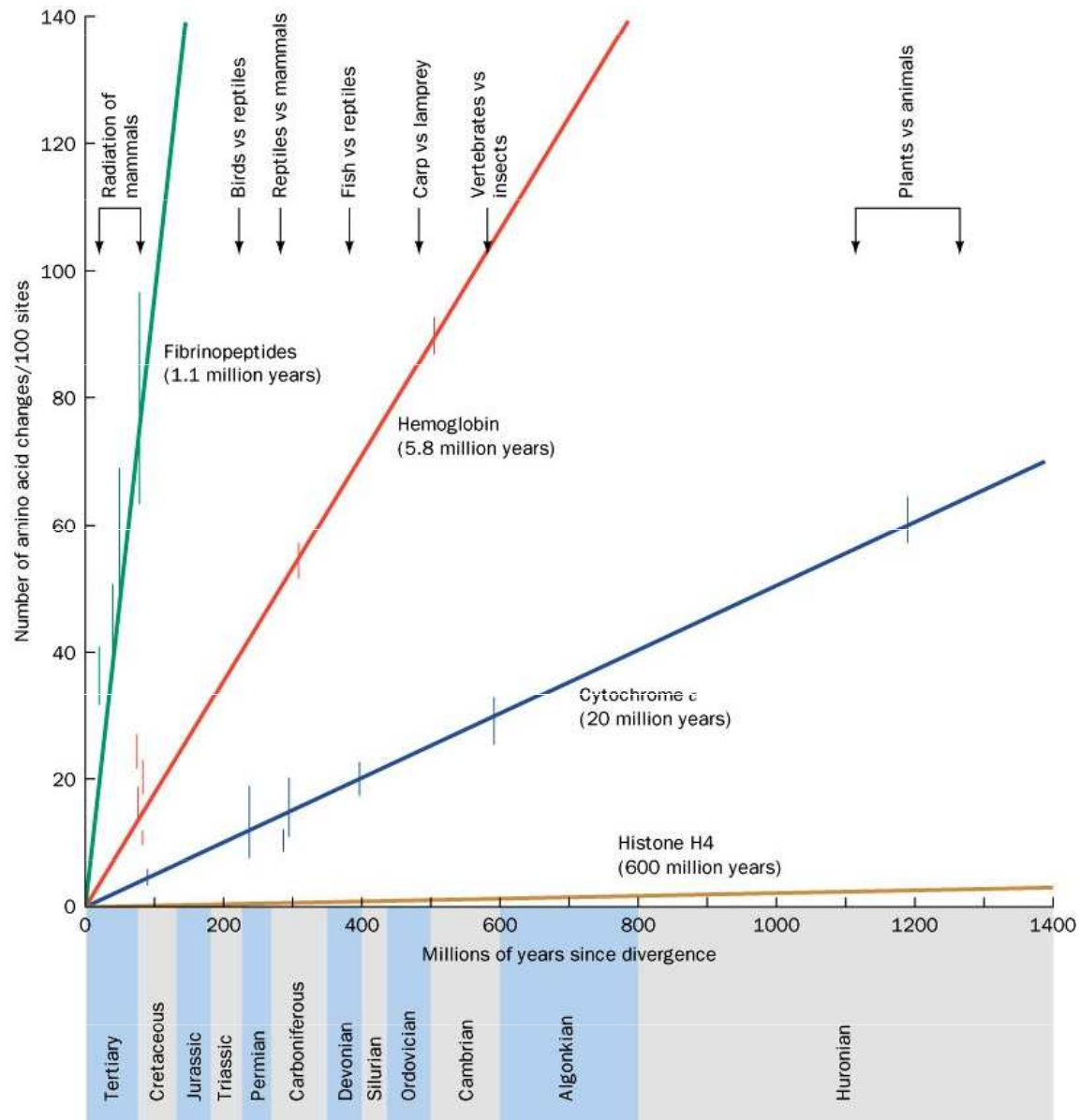

Srpkovitá anémie

HbA HbS

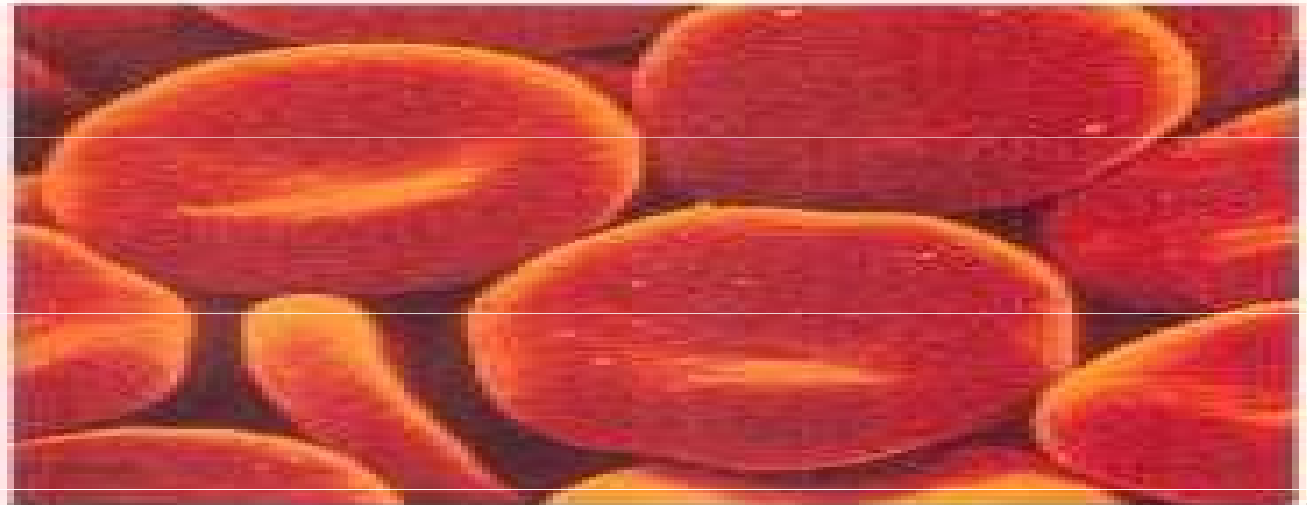

Norm.



Srpkovitá

Srpkovitá anémie versus malárie

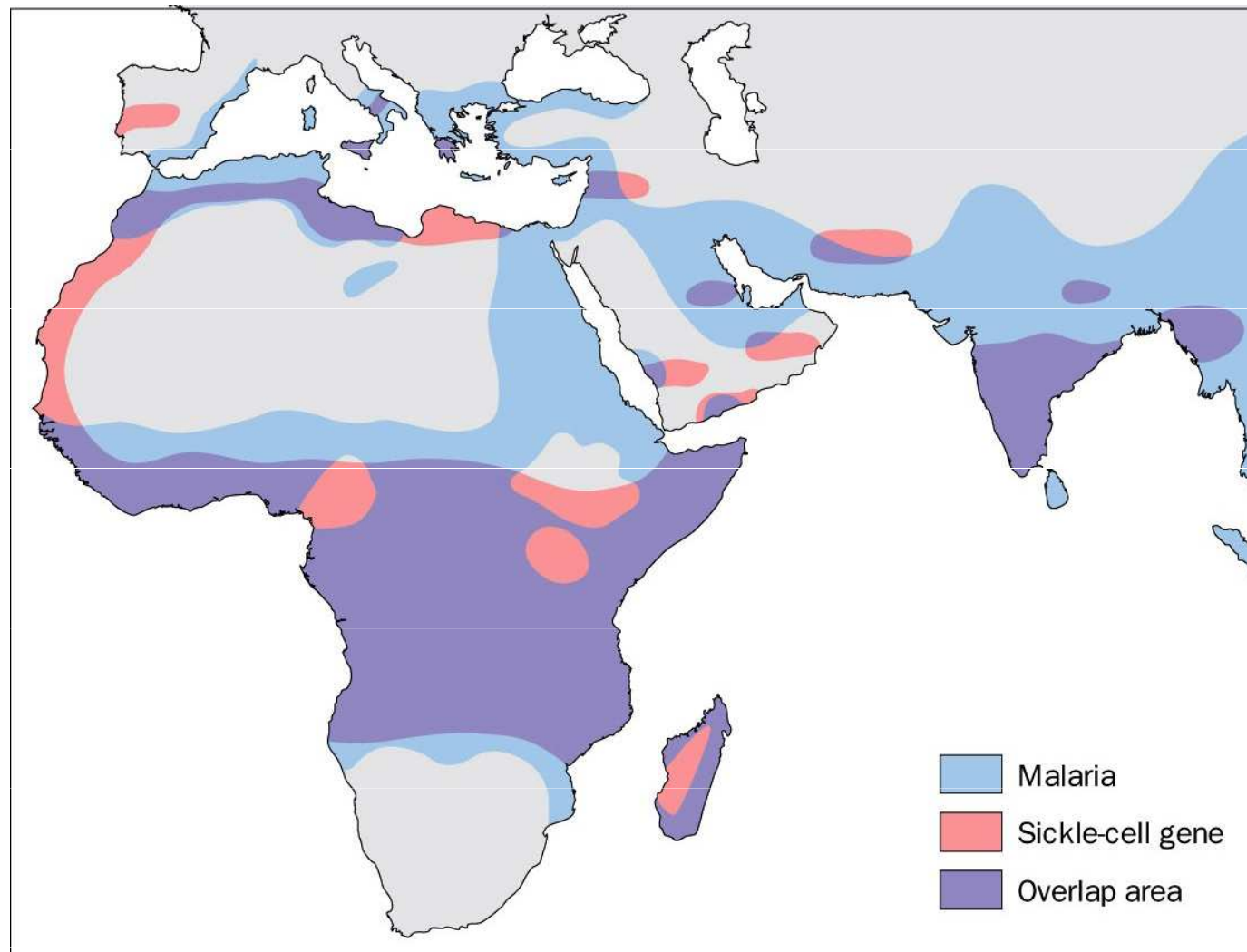

Primární struktura

1953 - Sanger - inzulin (51 AMK), 100 g materiálu, 10 let

⇒ aminokyselinový sekvenátor

1978 - β - galaktosidasa (1028 AMK), μ g materiálu, dny

--

Stanovení sekvence - Edmanovo odbourávání

na základě sekvence nukleových kyselin

MS – hmotnostní spektrometrie

Určování primární struktury AMK sekvenátorem

- A. **Purifikace bílkoviny** – získání homogenní bílkoviny
- B. **Aminokyselinové složení** – určení počtu jednotlivých AMK zbytků (kyselá hydrolyza 6N HCl, 100 –110 °C, 24 h)
- C. **Pořadí aminokyselin:**
 1. Oddělit a izolovat jednotlivé řetězce(redukce nebo oxidace disulfidických můstků)
 2. Určit N-konec a C-konec
 3. Určit pořadí aminokyselin Edmanovým odbouráváním (kam až to jde)
 4. 2 nezávislá specifická štěpení → izolovat štěpy (peptidy)
 5. Opakovat bod 3.
 6. Sestavit primární strukturu řetězce
 7. Určit způsob propojení původních řetězců

Zjišťování N-koncových AMK

$$X + A-B-C = X-A + B + C$$

Zjišťování N-koncových AMK

Frederick Sanger

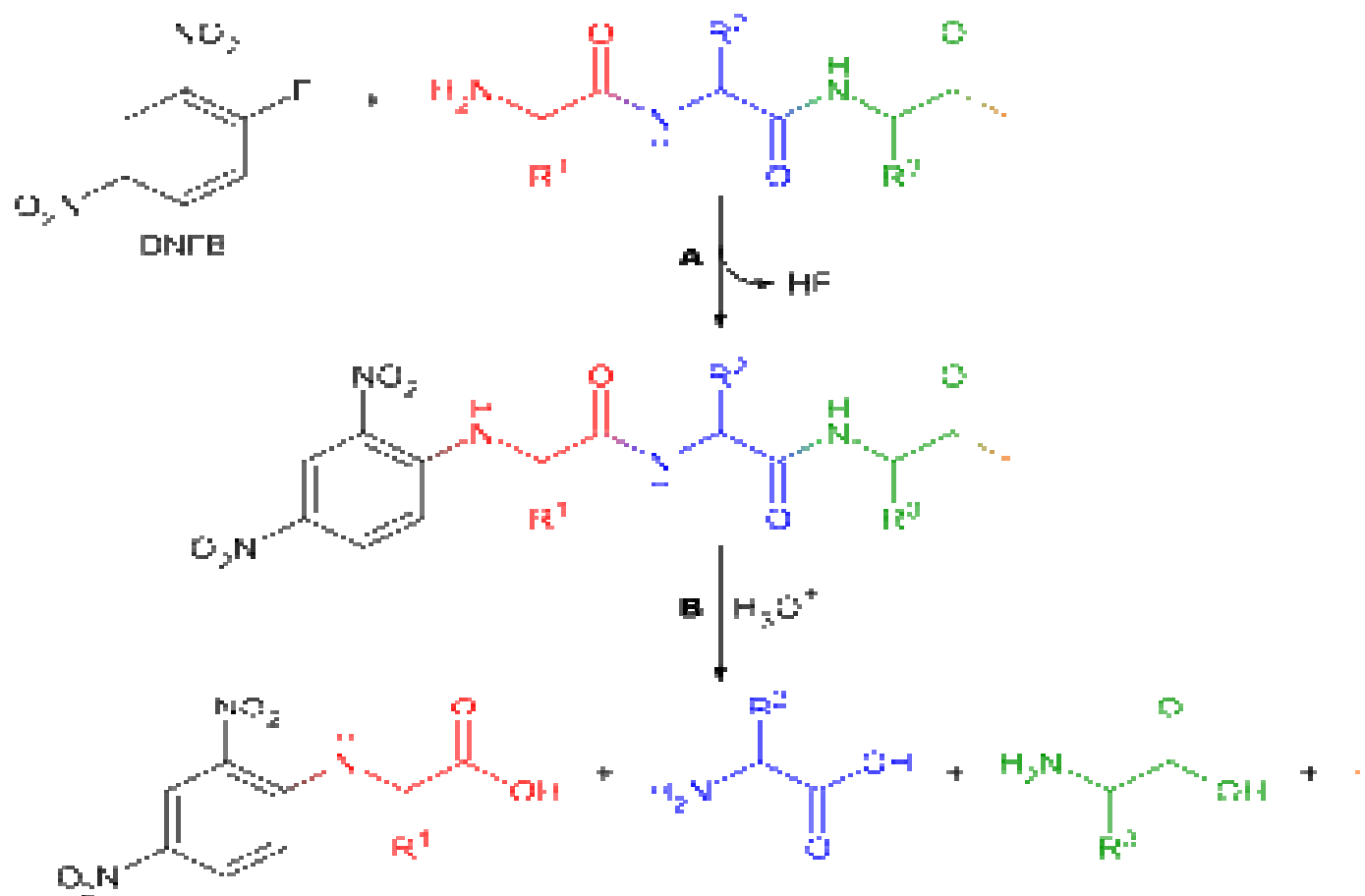

Zjišťování N-koncových AMK

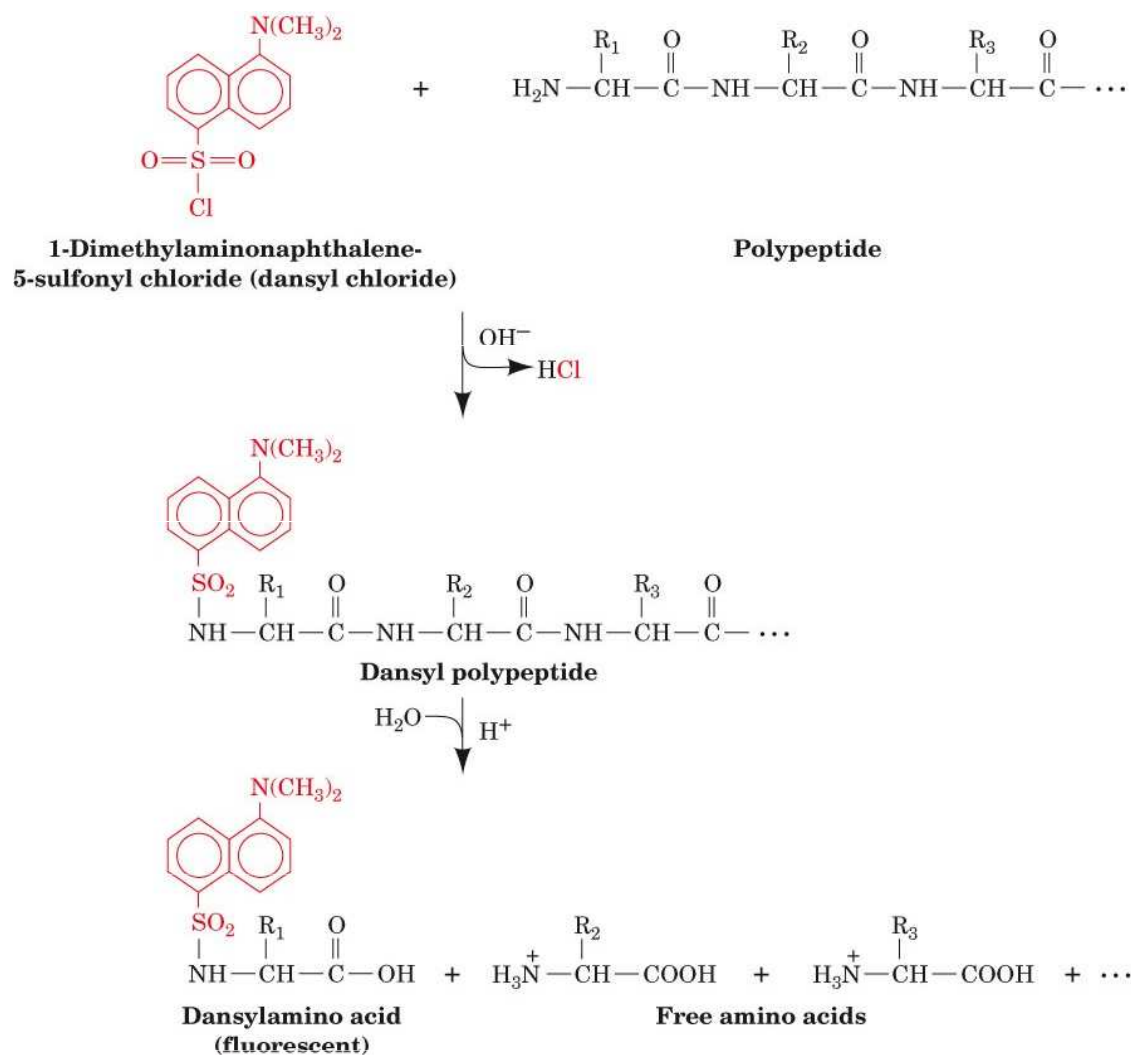

Edmanovo sekvenování

Pehr Victor Edman

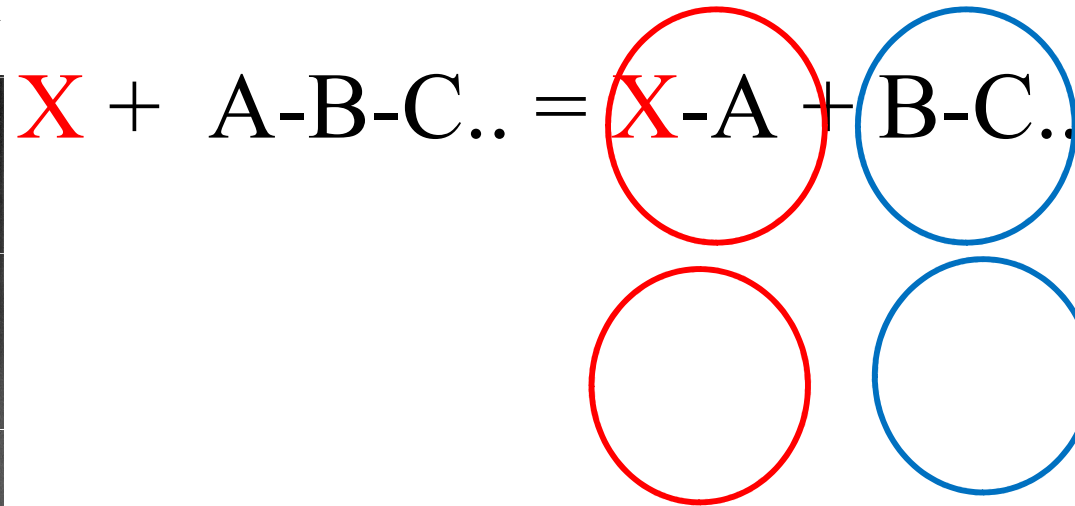

Edmanovo sekvenování

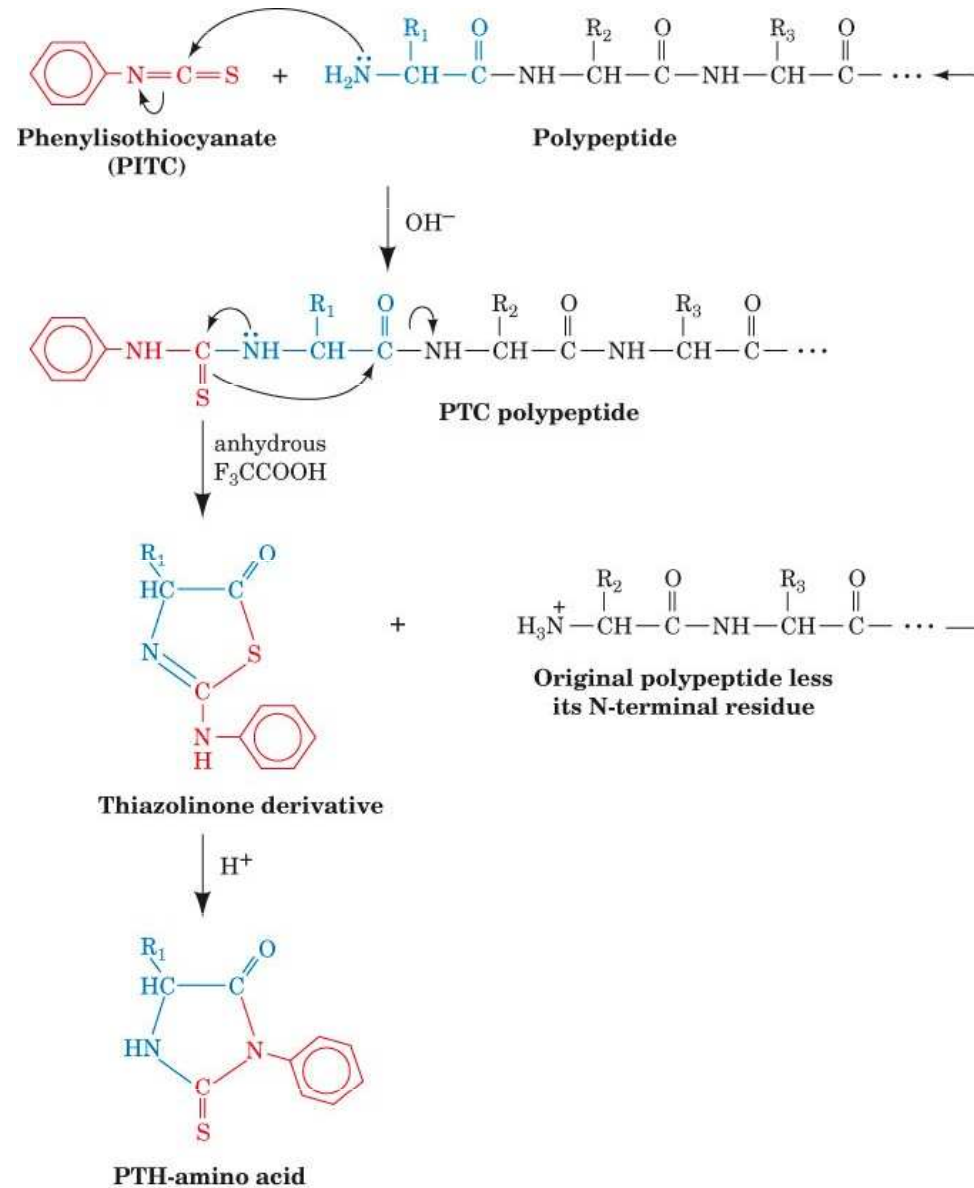

Možnosti štěpení

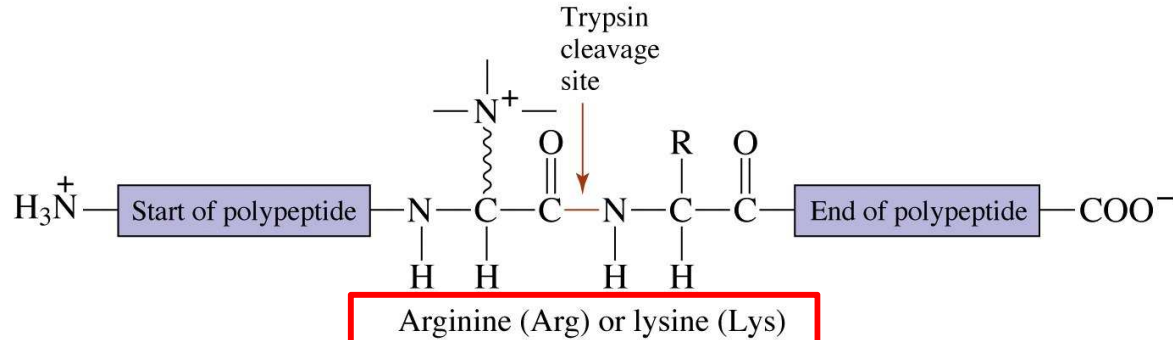

Figure 3-17a Concepts in Biochemistry, 3/e
© 2006 John Wiley & Sons

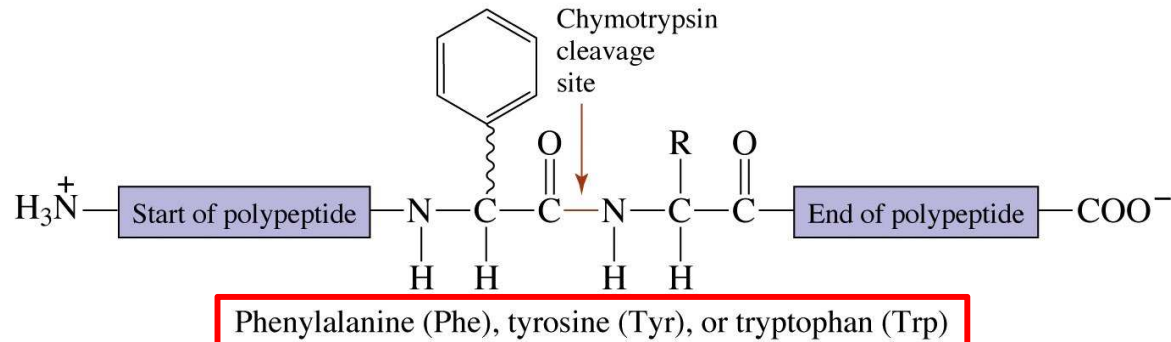

Figure 3-17b Concepts in Biochemistry, 3/e
© 2006 John Wiley & Sons

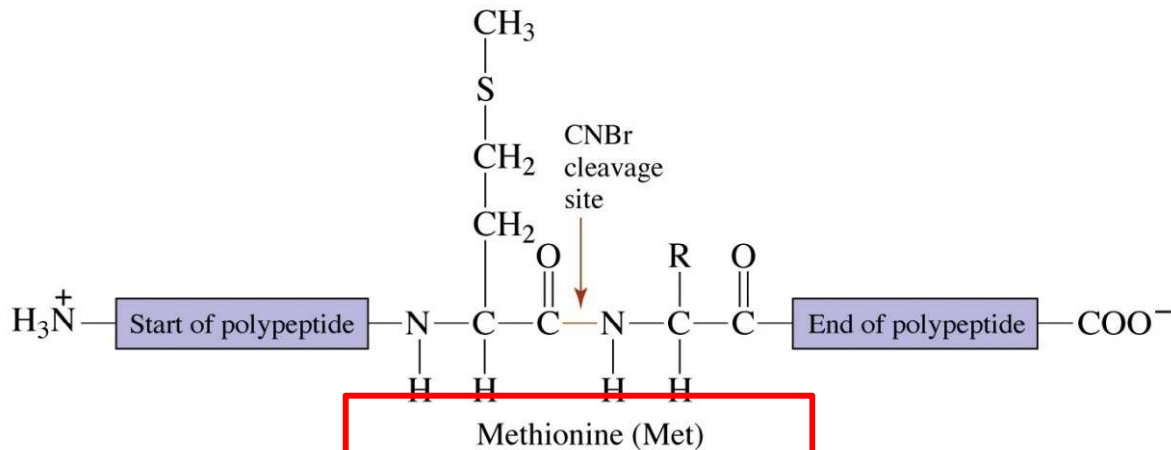
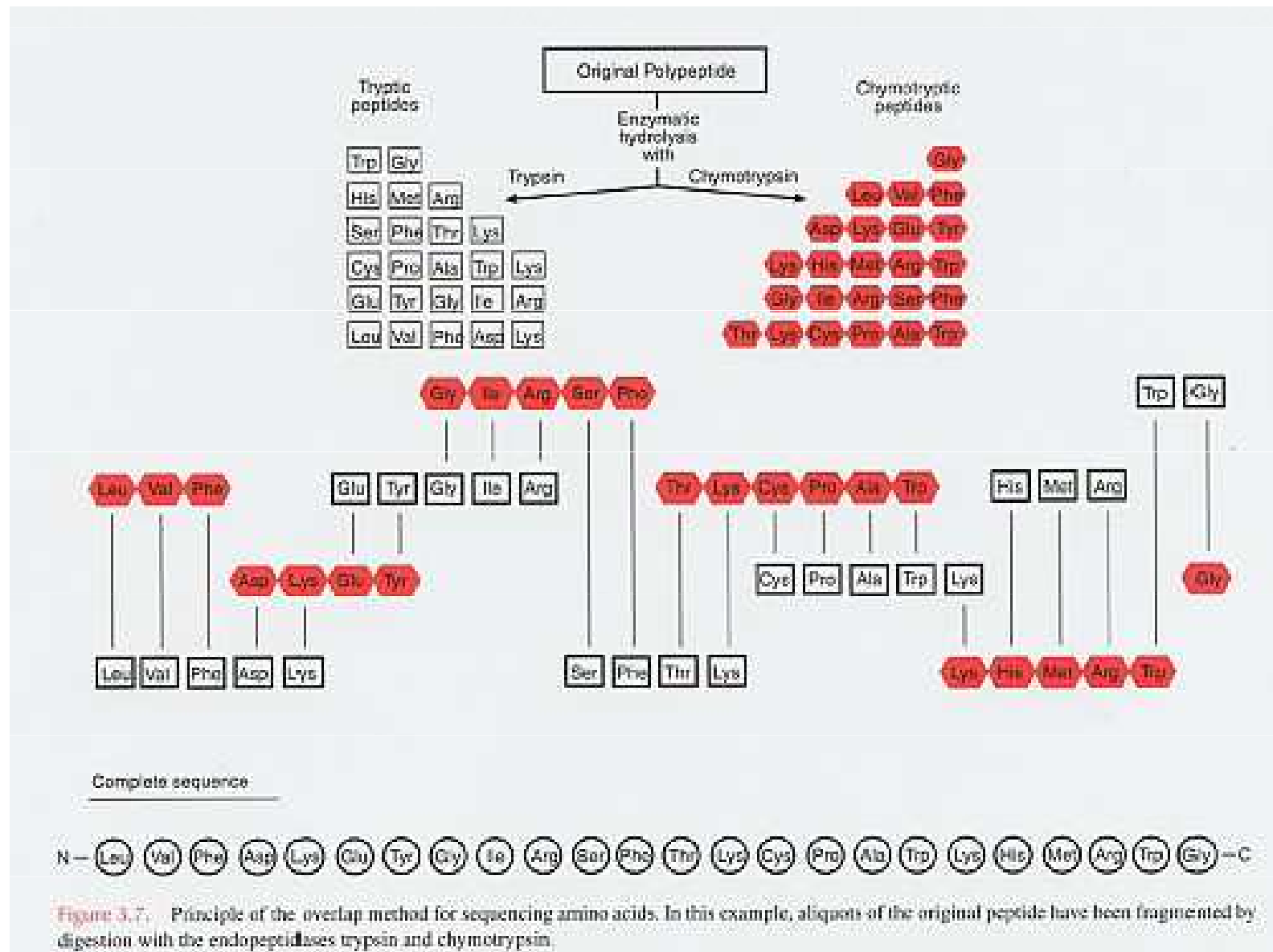

Figure 3-17c Concepts in Biochemistry, 3/e
© 2006 John Wiley & Sons

Metoda překrývajících se štěpů



Primární struktura

Stanovení na základě sekvenace NK

- Není snadné identifikovat gen kódující daný protein
- Nelze takto zjistit posttranslační modifikace
- V genetické, kódu mohou být chyby
- Genetický kód není universální

Primární struktura

Pomocí hmotnostní spektrometrie - MS

Hmotnostní spektrometr

Hmotnostní spektrometr je iontově-optické zařízení, které separuje ionty podle poměru jejich m/z .

Blokové schéma MS

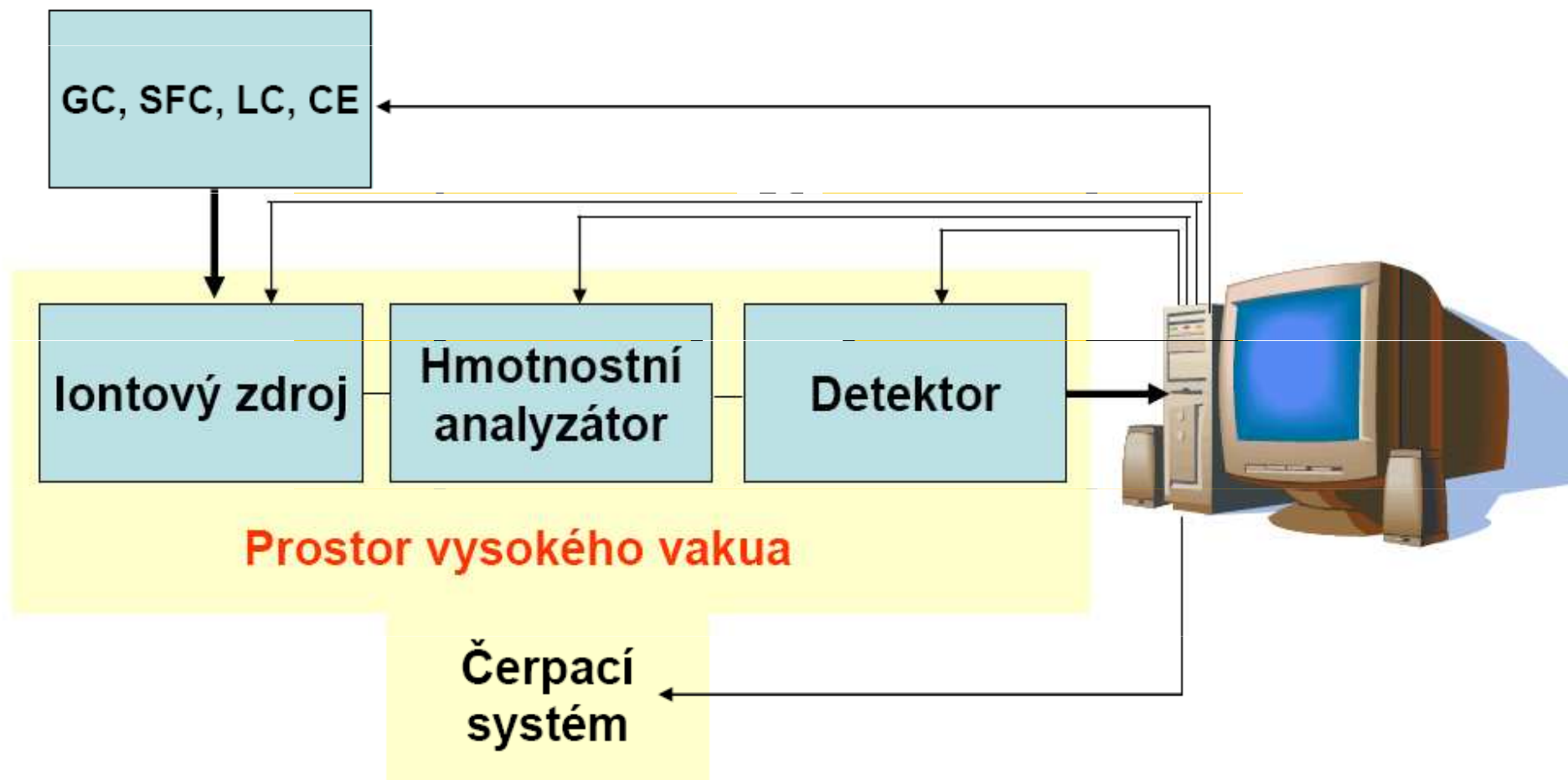

MS – NC 2002 (Tanaka, Fen)

(a) Electrospray ionization (ESI)

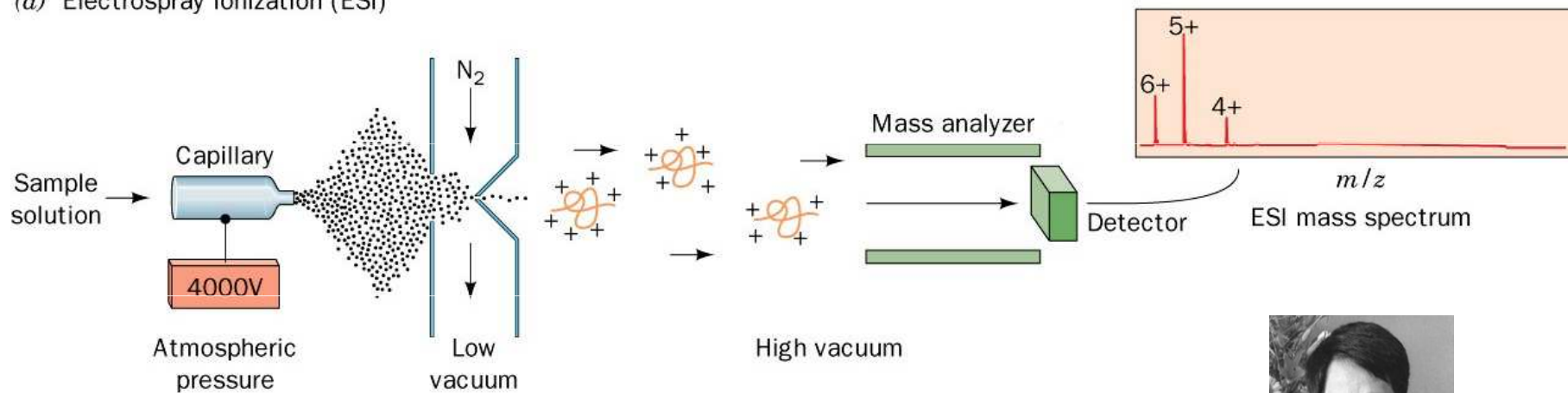

(b) Matrix-assisted laser desorption/ionization (MALDI)

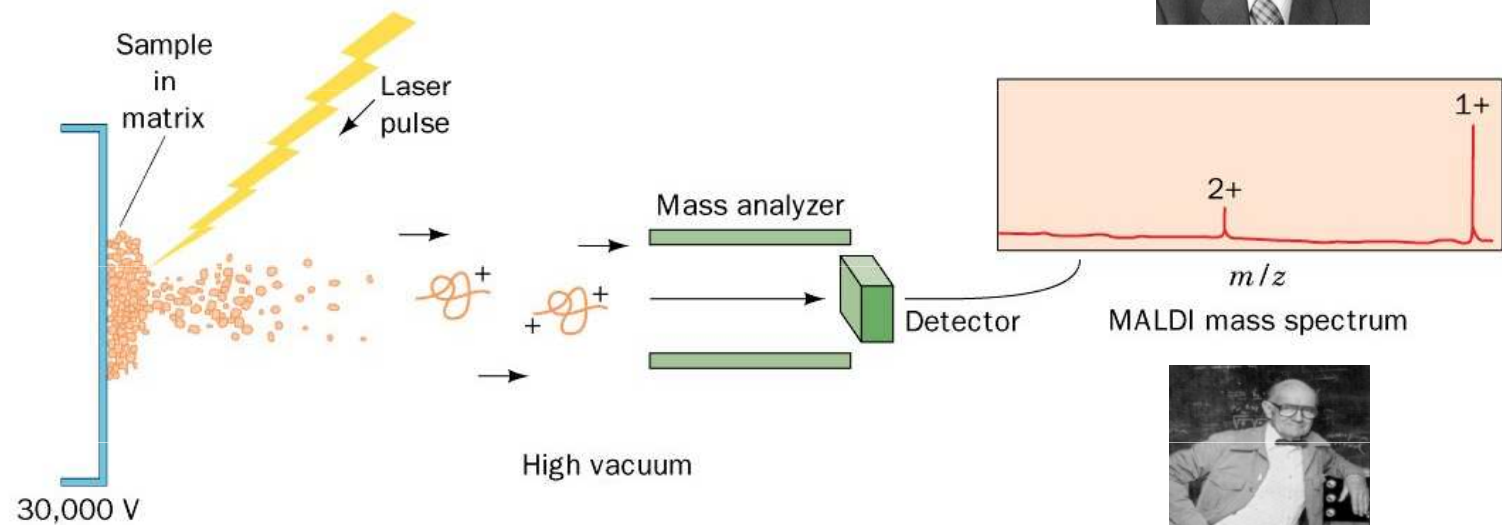

Electrospray (ESI) Tanaka

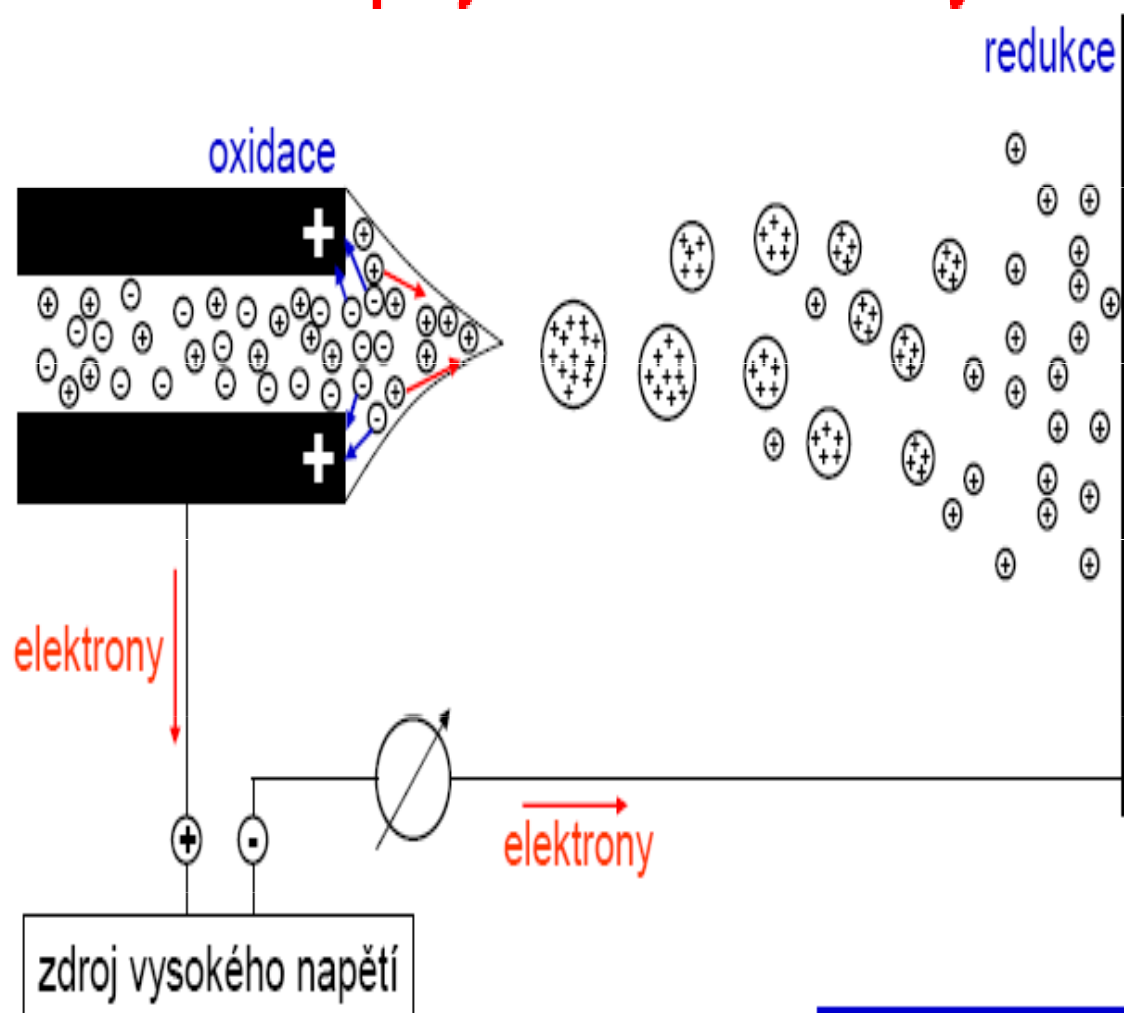

$[M+H]^+$
 $[M+NH_4]^+$
 $[M-H]^-$
 $[M \pm zH]^{z \pm}$

$t_{N_2} \approx 50 - 400 \text{ }^\circ\text{C}$ (přidatné)
Napětí: 2 - 8 kV
Průtok m. f. 0,001 - 1 ml/min
Ionizace za
atmosférického tlaku
Těkavé přísady: octan amonný,
mravenčí k.
Netěkavé přísady: fosfátové
pufry

Ionizace

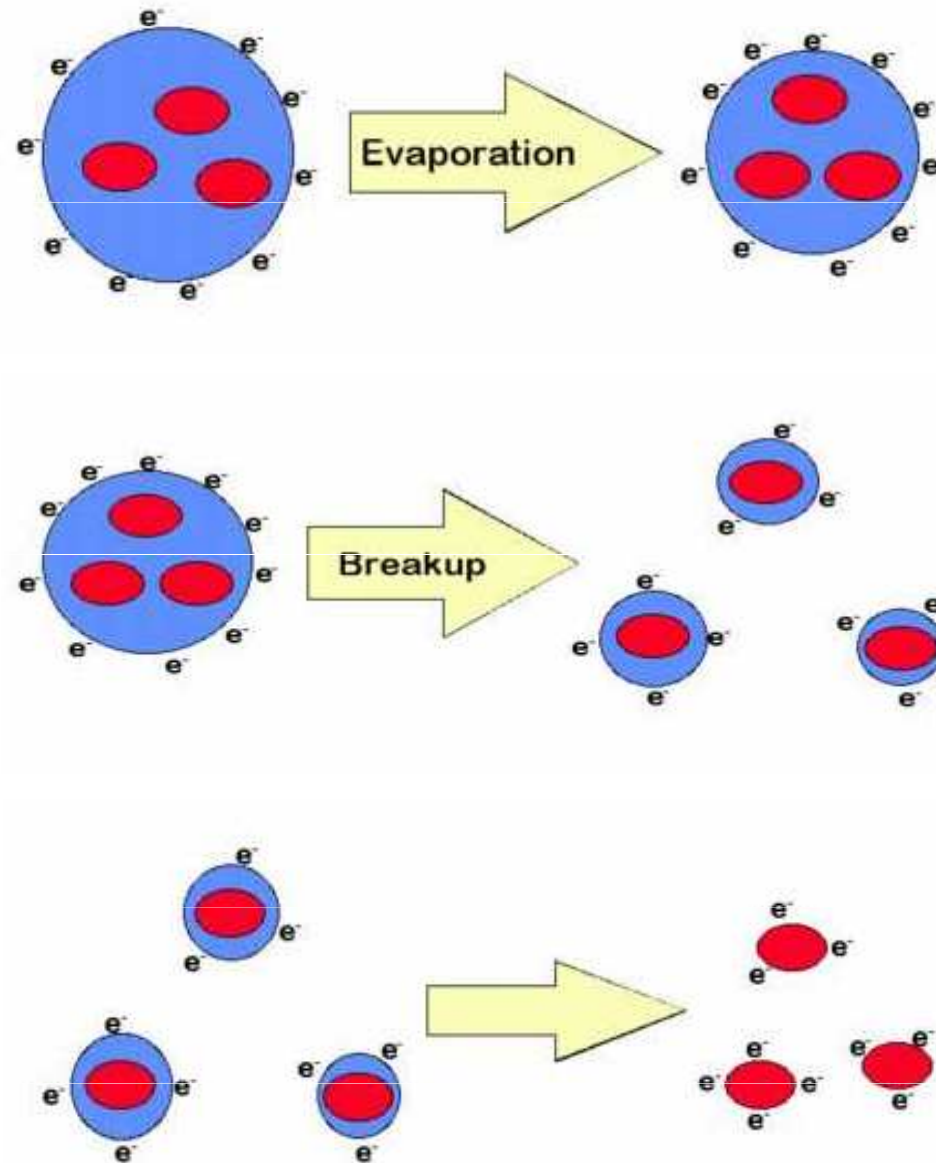

Matrix Assisted Laser Desorption Ionisation (MALDI) Fen

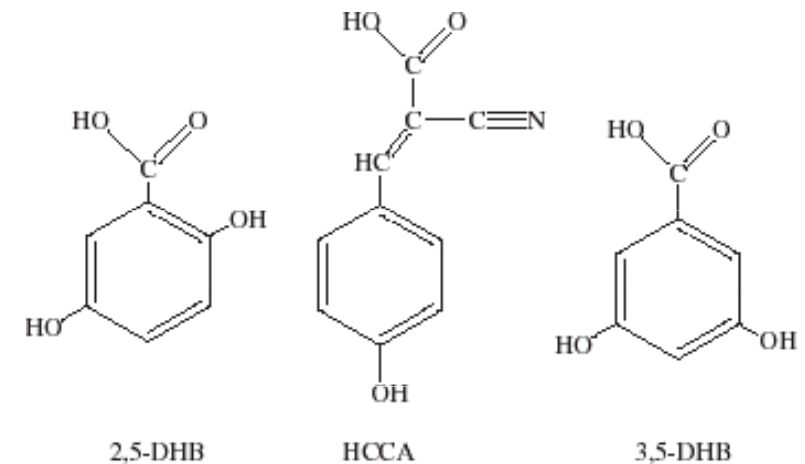
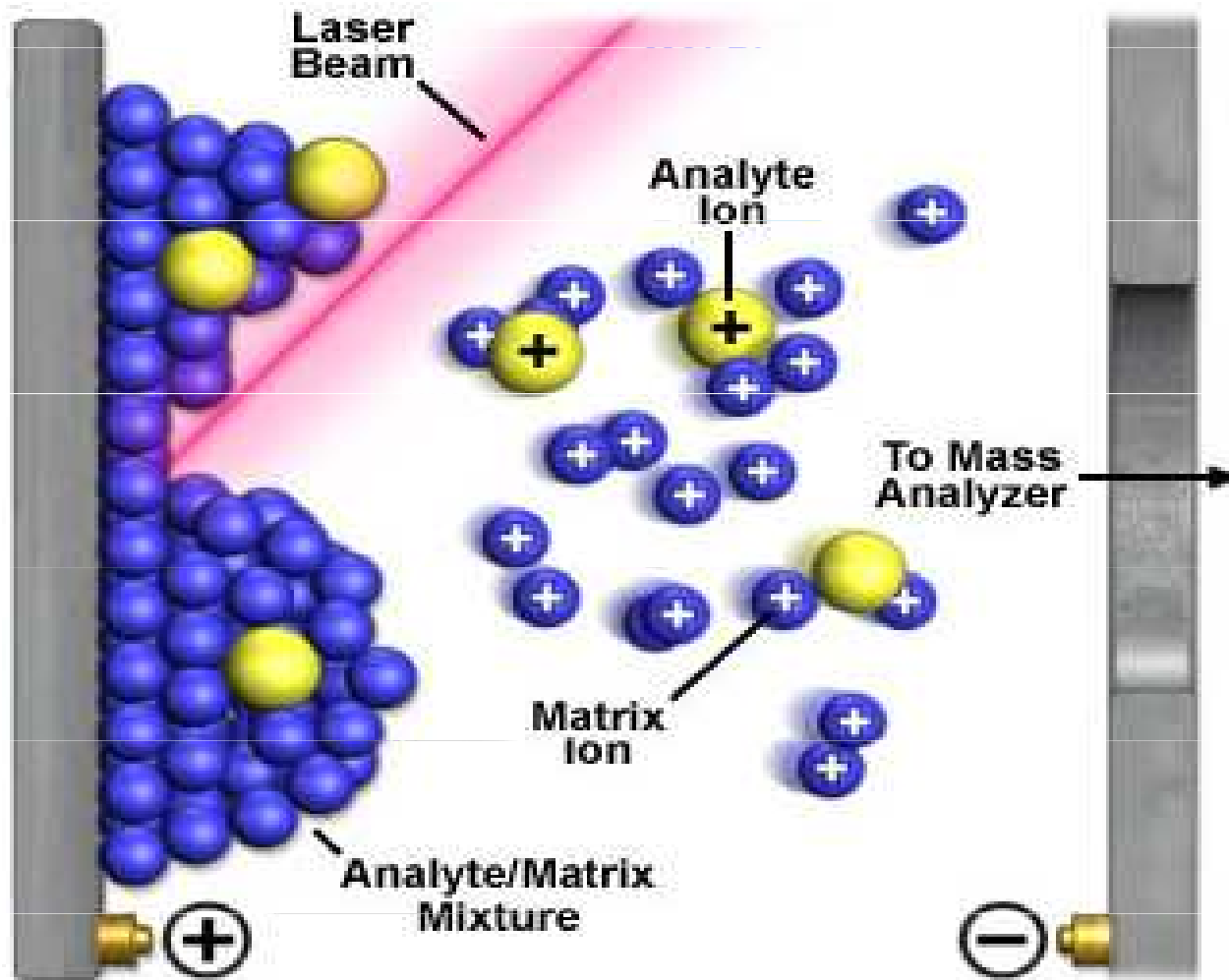

Analyzátor doby letu (TOF)



Analyzátor doby letu (TOF)

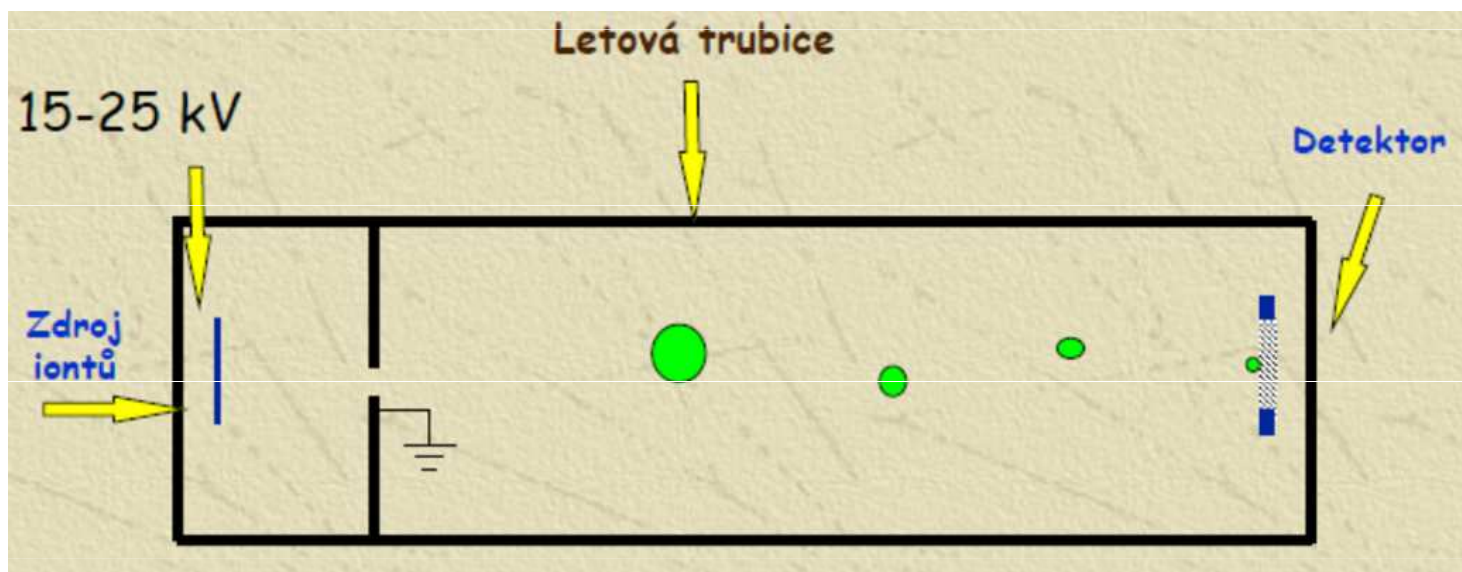

MS

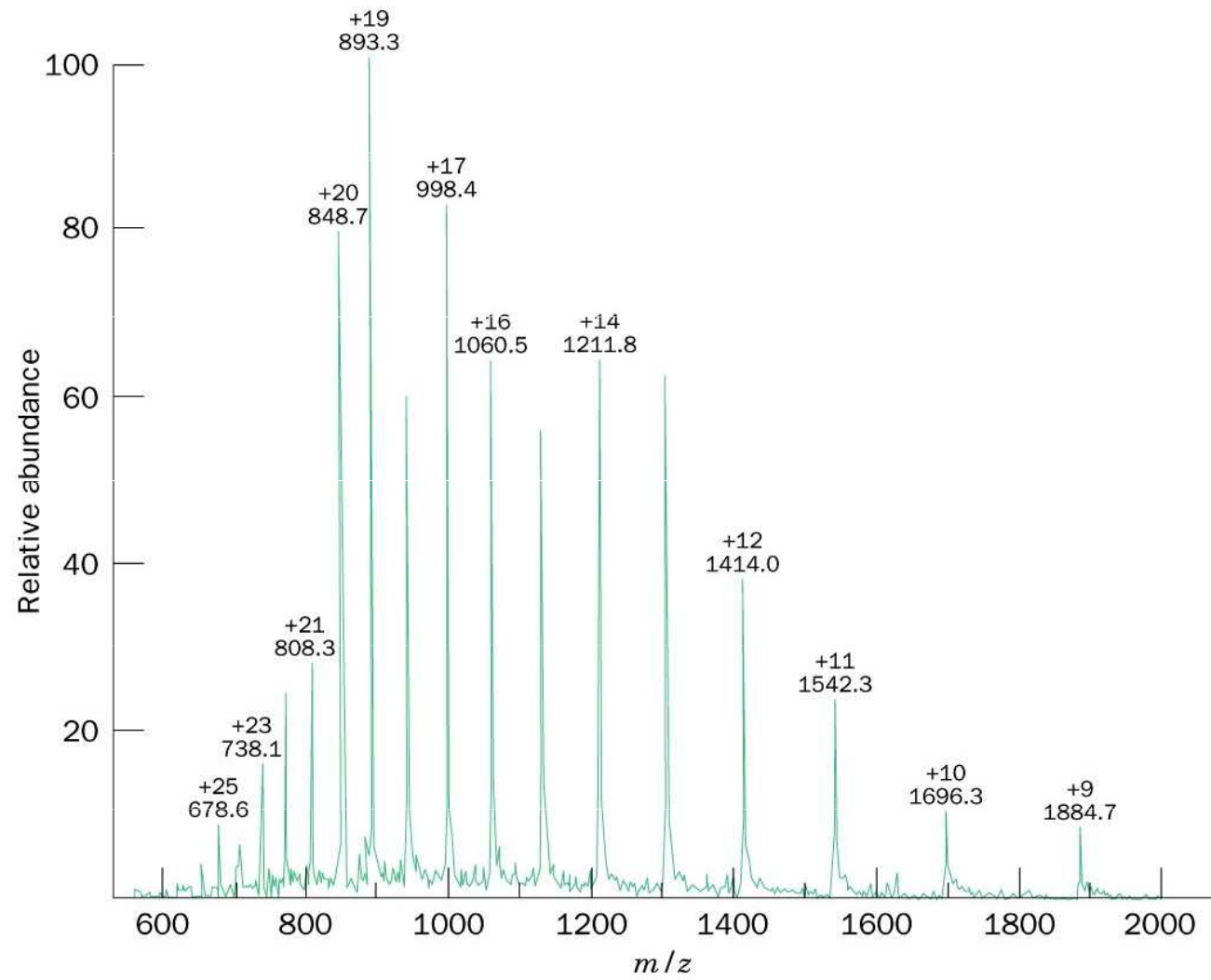

Tandemová MS-MS

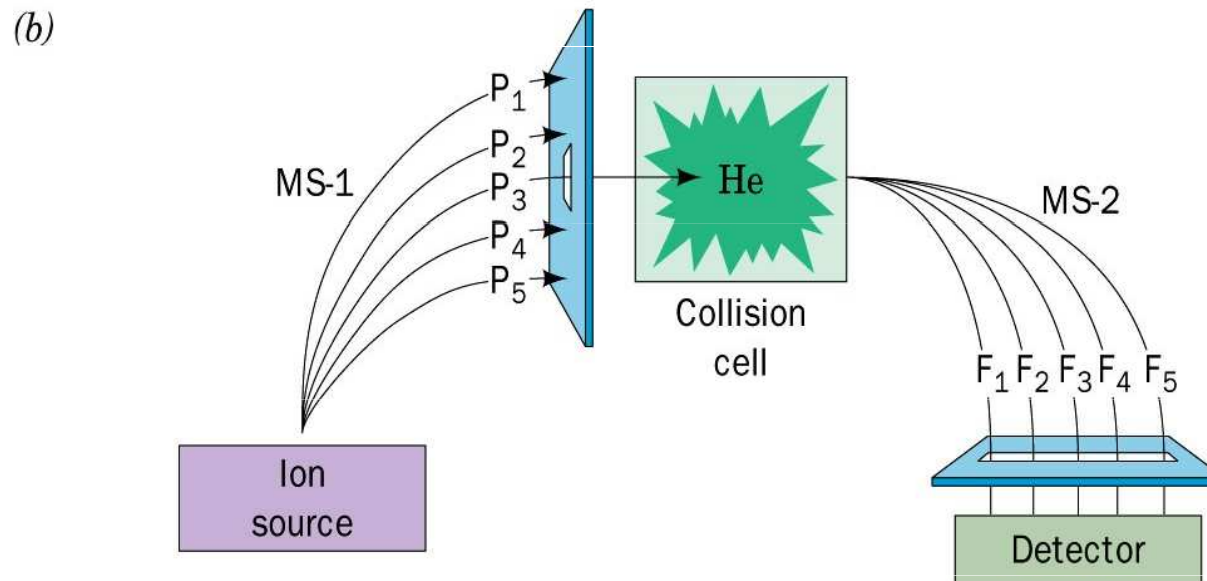
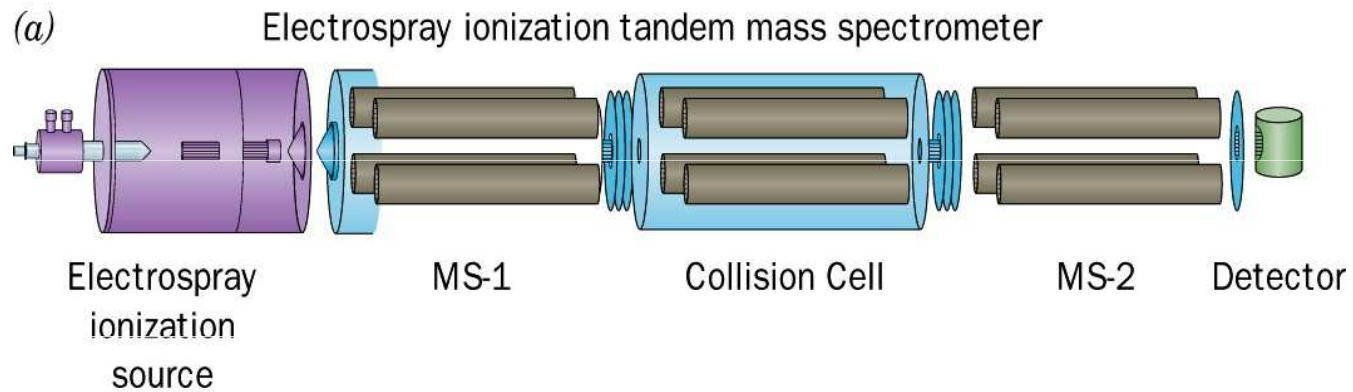

Tandemová MS-MS

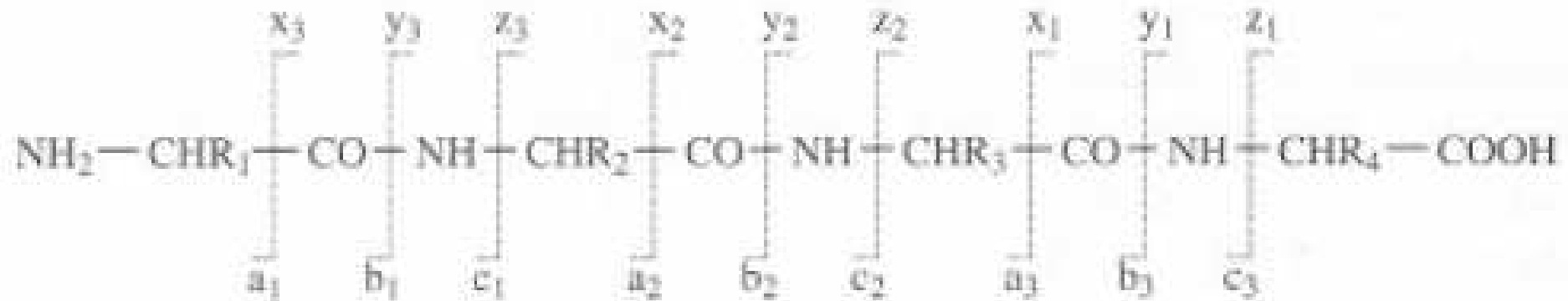

Tandemová MS-MS

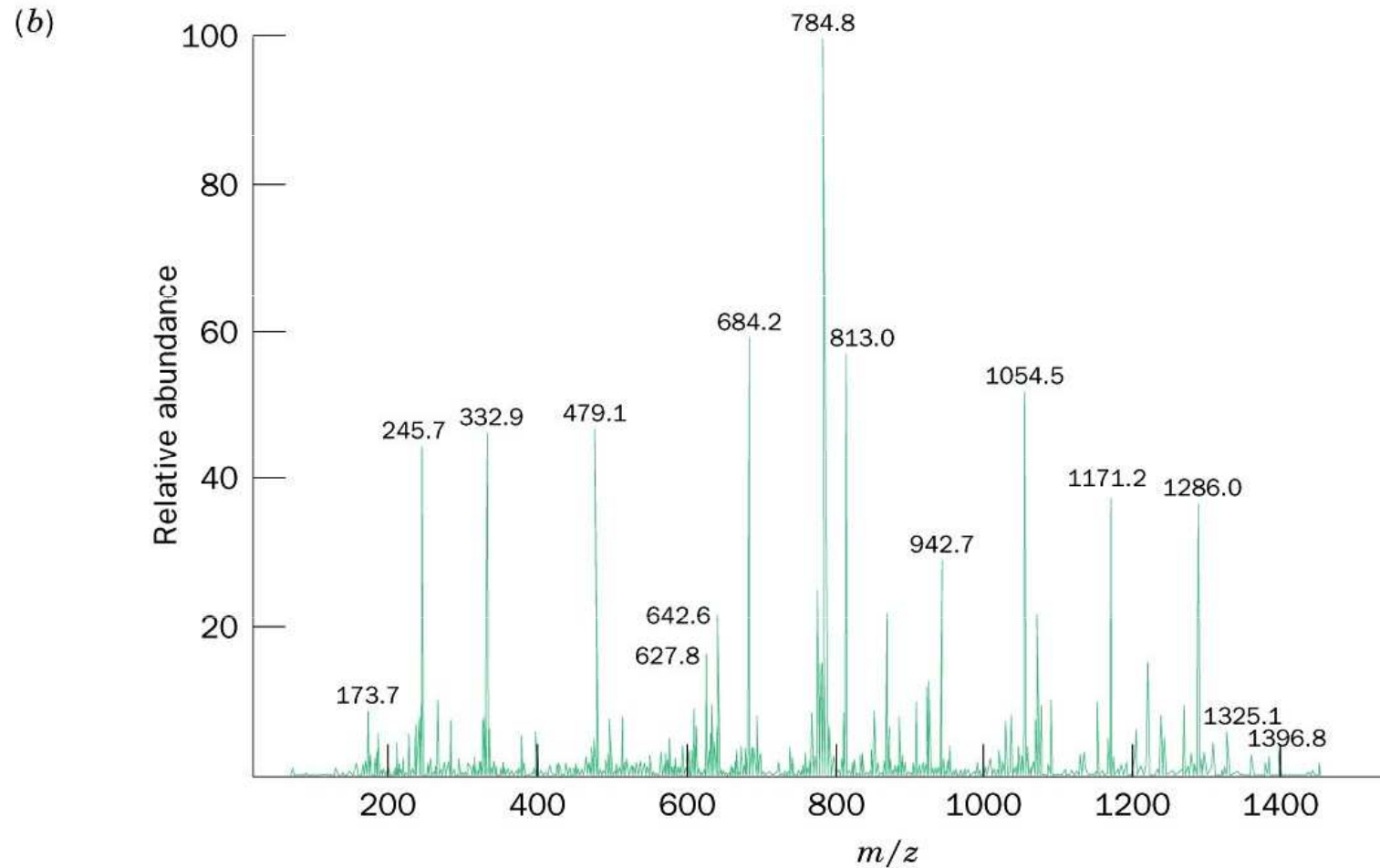
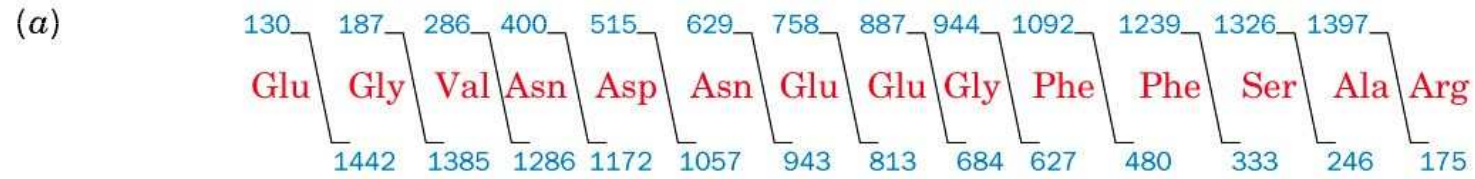

Syntéza peptidů

1953 - oxytosin (9 AMK) DE VIGNEAND

Proč syntéza peptidů

- Proteinové inženýrství
- Příprava modifikovaných peptidů
- Příprava peptidových léčiv a vakcín

Pravidla syntézy

- Pořadí AMK je dáno genetickým kódem
- COOH málo reaktivní, musí se aktivovat
- Je nutné blokovat další skupiny aby se zabránilo vedlejším reakcím, blokace musí být reverzibilní
- Nesmí být narušena L-konfigurace
- Co největší výtěžek (90 % u dekaeptidu = celkový 39%)

V ROZTOKU



X – chránicí skupina

Y – aktivační skupina

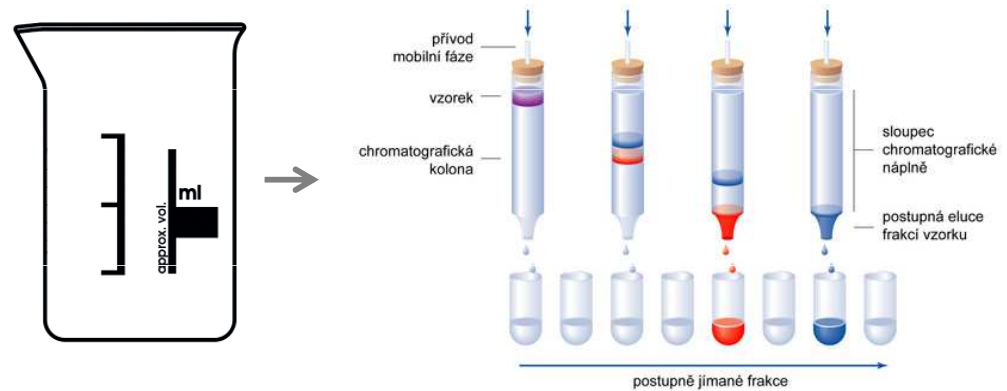

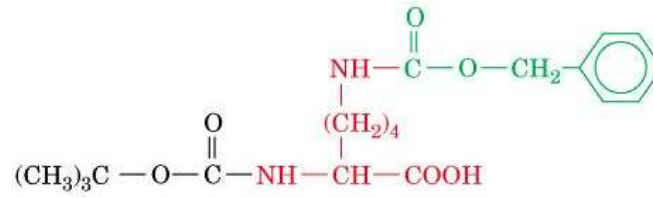

Boc, *N*^ε-benzyloxycarbonyl-Lys

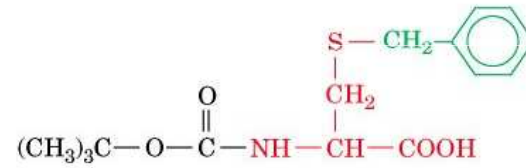

Boc, *S*-benzyl-Cys

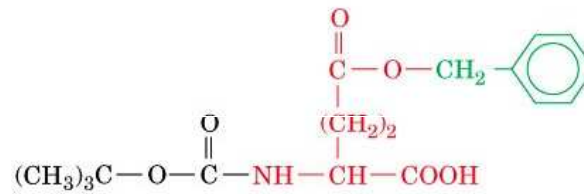

Boc-Glu, γ -Benzyl ester

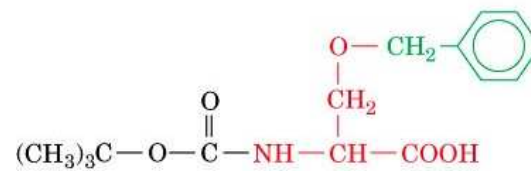

Boc, *O*-benzyl-Ser

Bruce Merrifield
1962

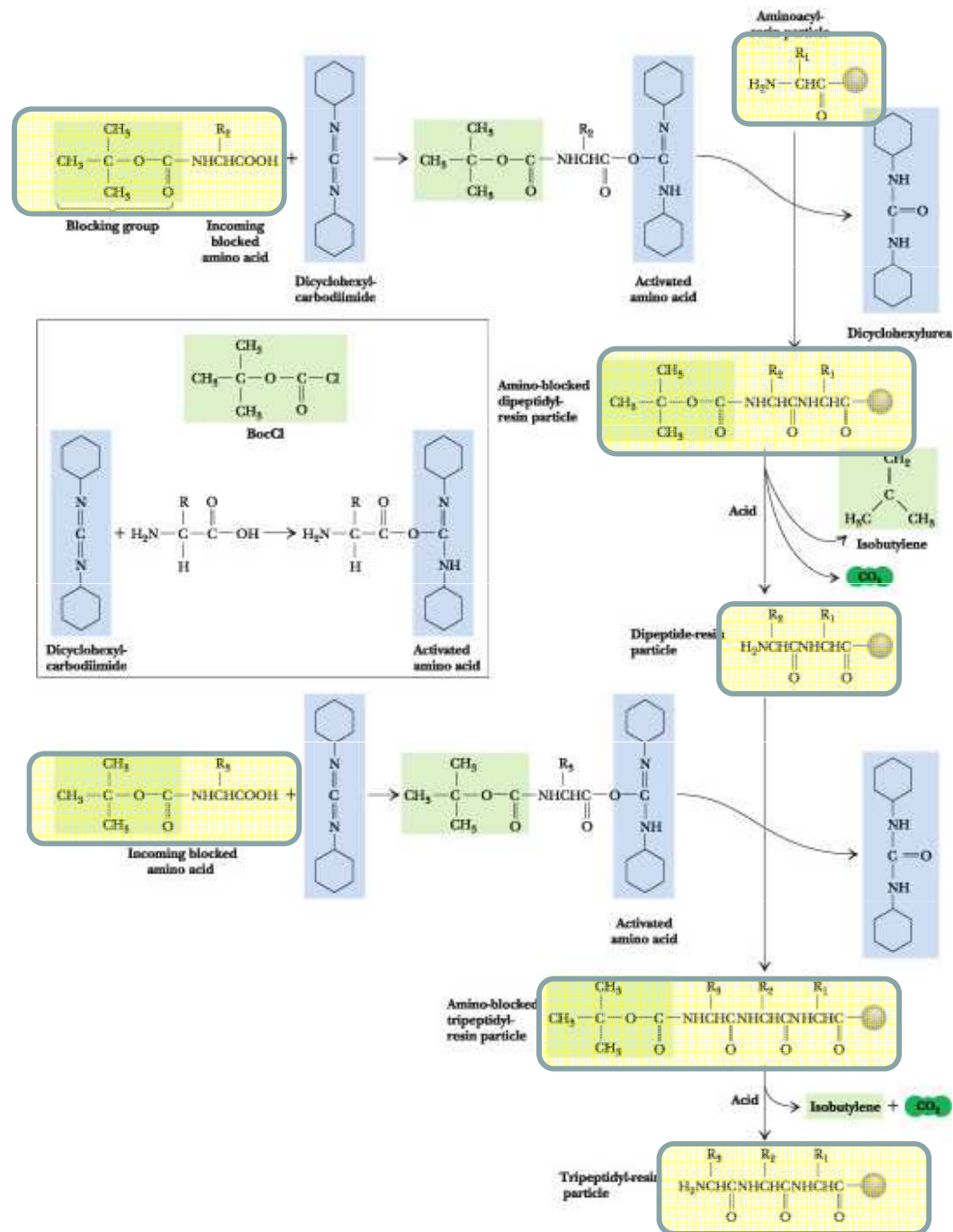

Imobilizovaná AMK

Volná aktivovaná AMK
s blokovanou aminoskupinou

Reakce - dipeptid

Odstranění blokování

Atd.

Atd.

Tripeptid

Syntetizátor peptidů



Syntéza peptidů

1953 - oxytosin (9 AMK) DE VIGNEAND

1962 - syntéza na pevné fázi - MERRIFIELD

1971 Merrifield syntetizova RNAsu - 128 AMK z 80 % aktivní
(výtěžek 3 % na původní množství valin)

(a) – Lys – Ala – His – Gly – Lys – Lys – Val – Leu – Gly – Ala –
Primary structure (amino acid sequence in a polypeptide chain)

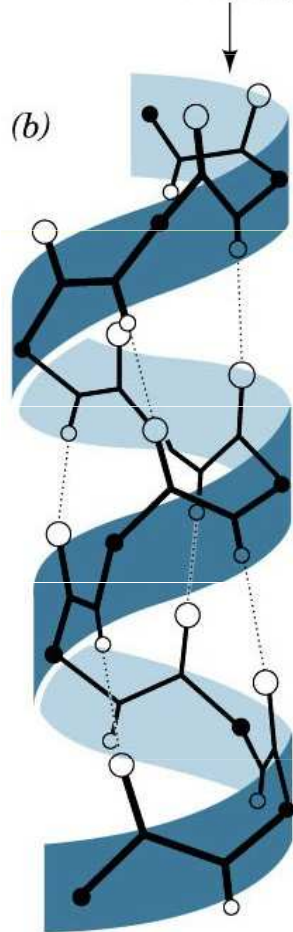

Secondary structure (helix)

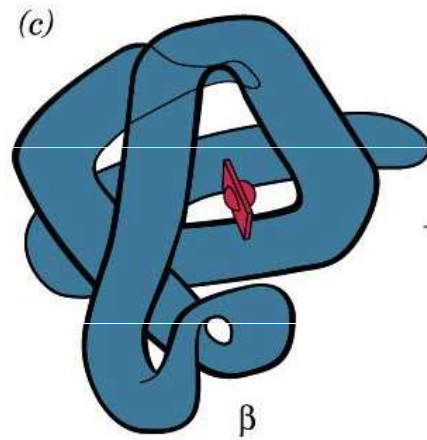

Tertiary structure:
one complete protein chain
(β chain of hemoglobin)

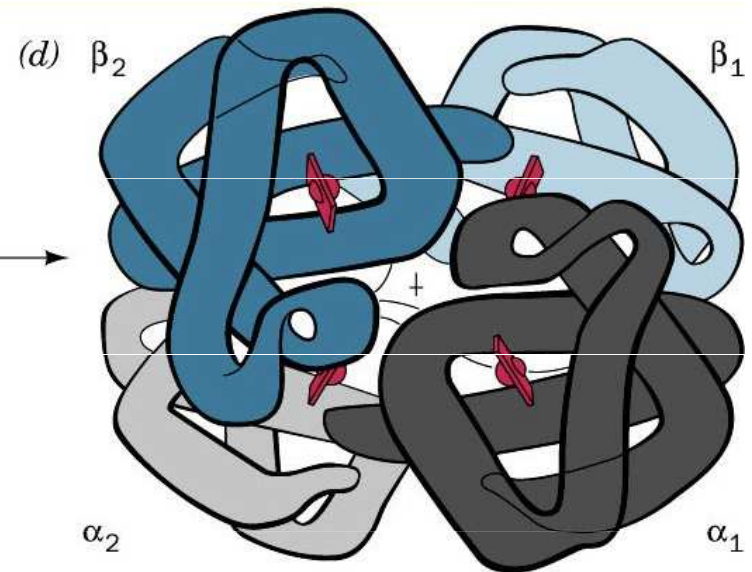

Quaternary structure:
the four separate chains
of hemoglobin assembled
into an oligomeric protein

Sekundární struktura

peptidická vazba - PAULING a COREY

30 až 40.léta

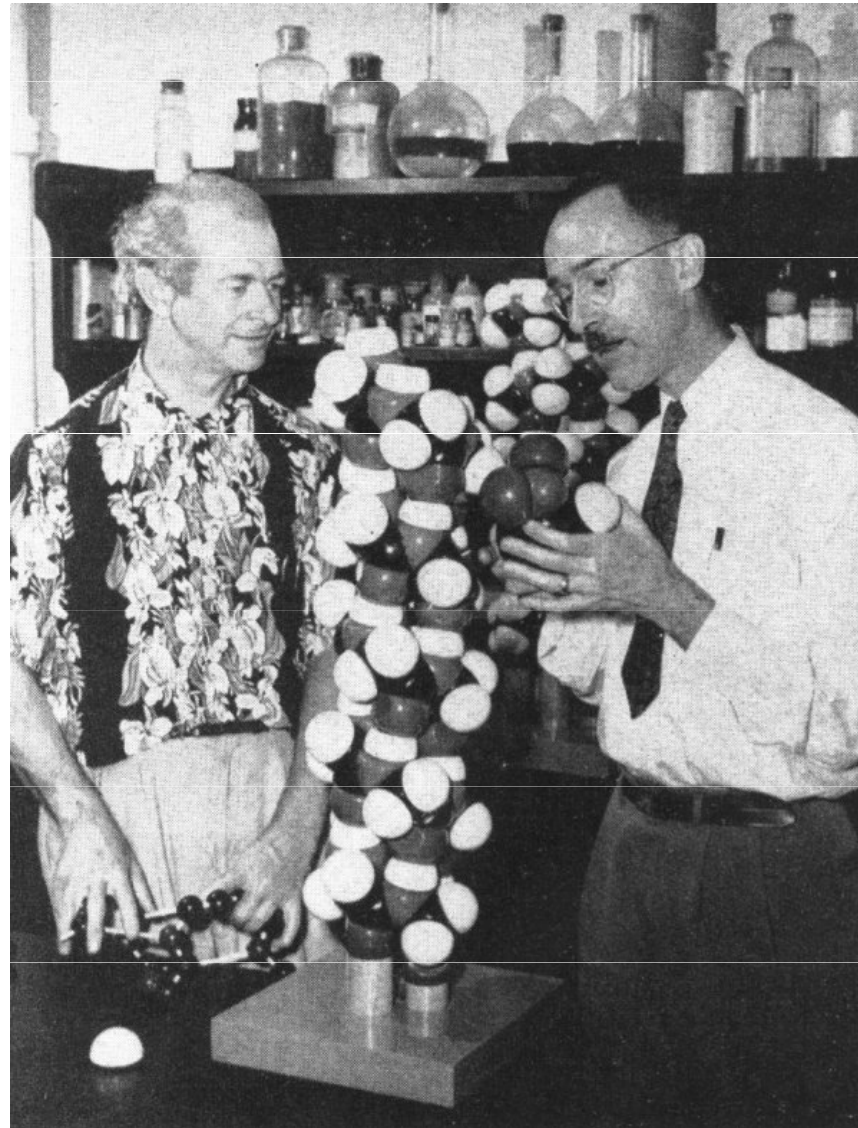

Sekundární struktura

peptidická vazba - PAULING a COREY

30 až 40.léta

A. Peptidická vazba leží v rovině

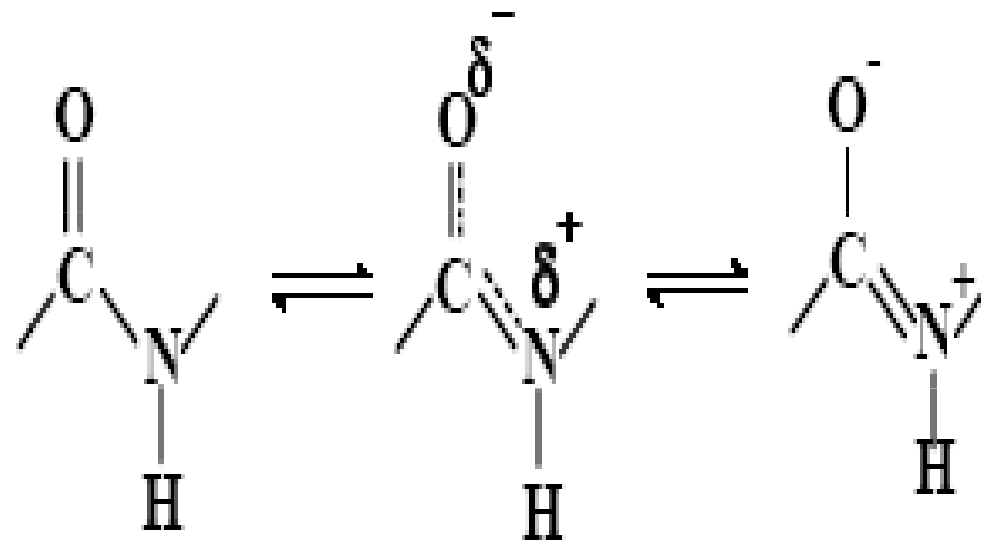

B. Peptidické vazby jsou v trans konfiguraci

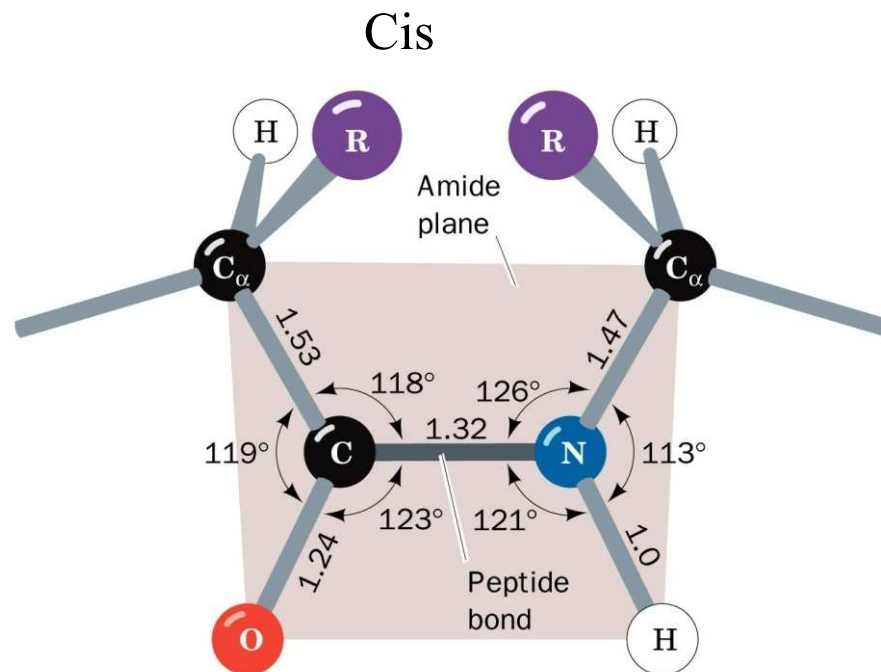
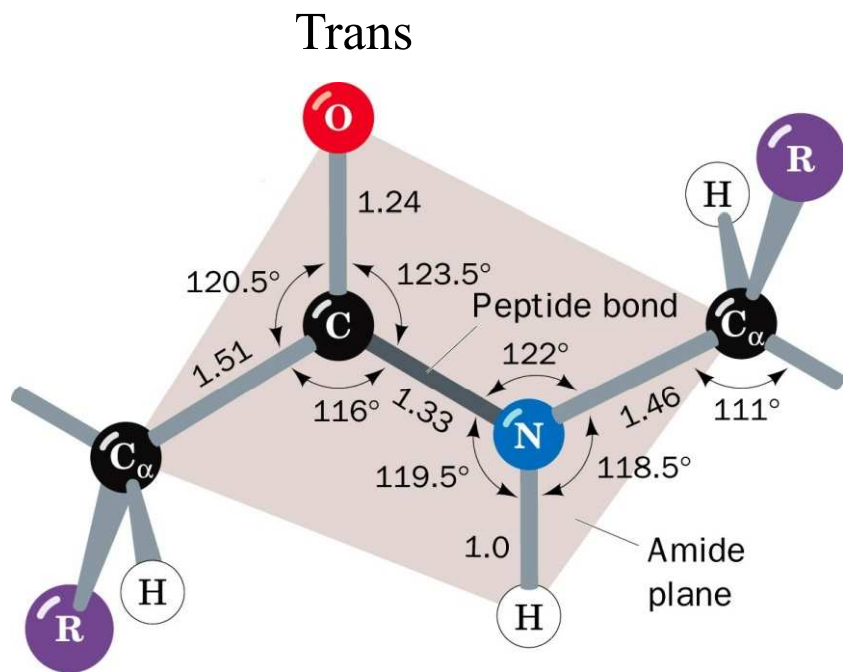
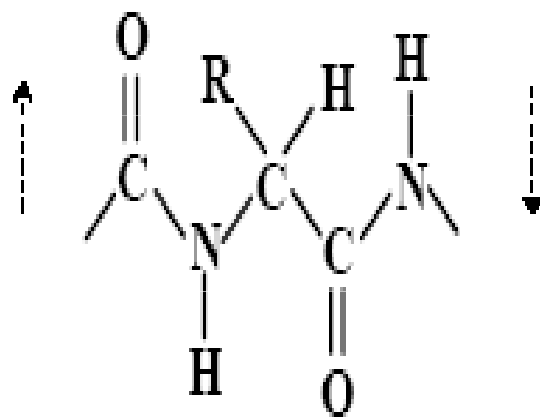

C. Peptidické vazby ležící v rovině mohou svírat určité torzní uhly

ϕ, ψ

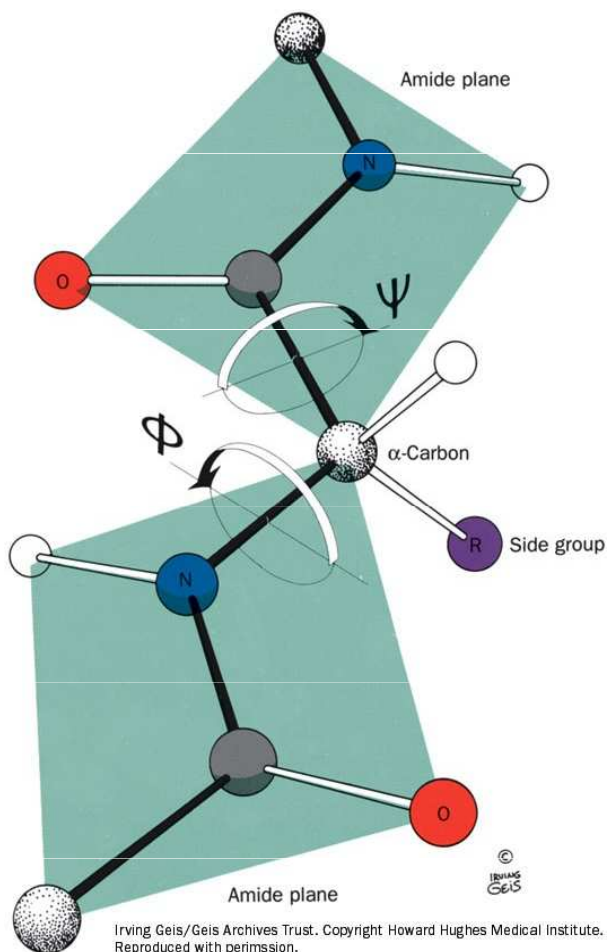
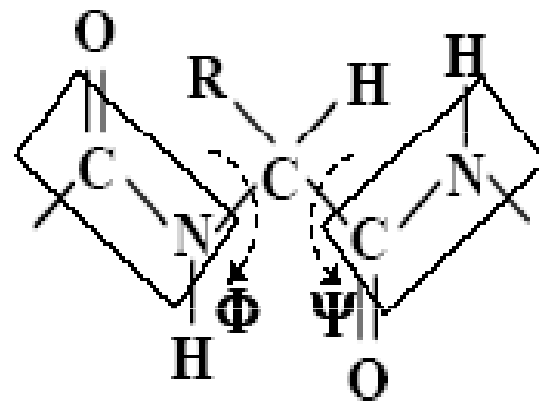

Irving Geis/Geis Archives Trust. Copyright Howard Hughes Medical Institute. Reproduced with permission.

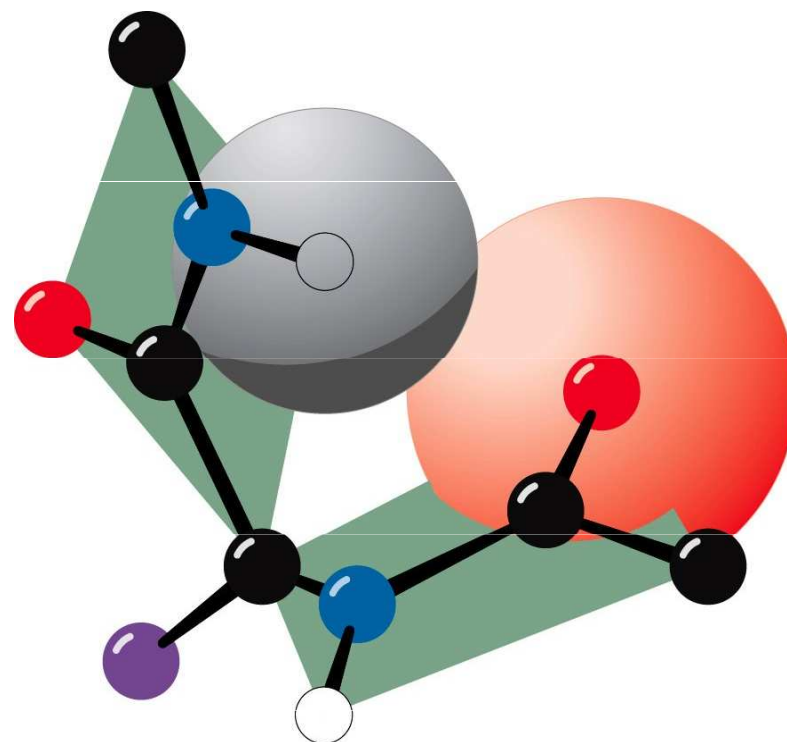

Irving Geis/Geis Archives Trust. Copyright Howard Hughes Medical Institute. Reproduced with permission.

Ramachandrov diagram stability sekundárních struktur bílkovin

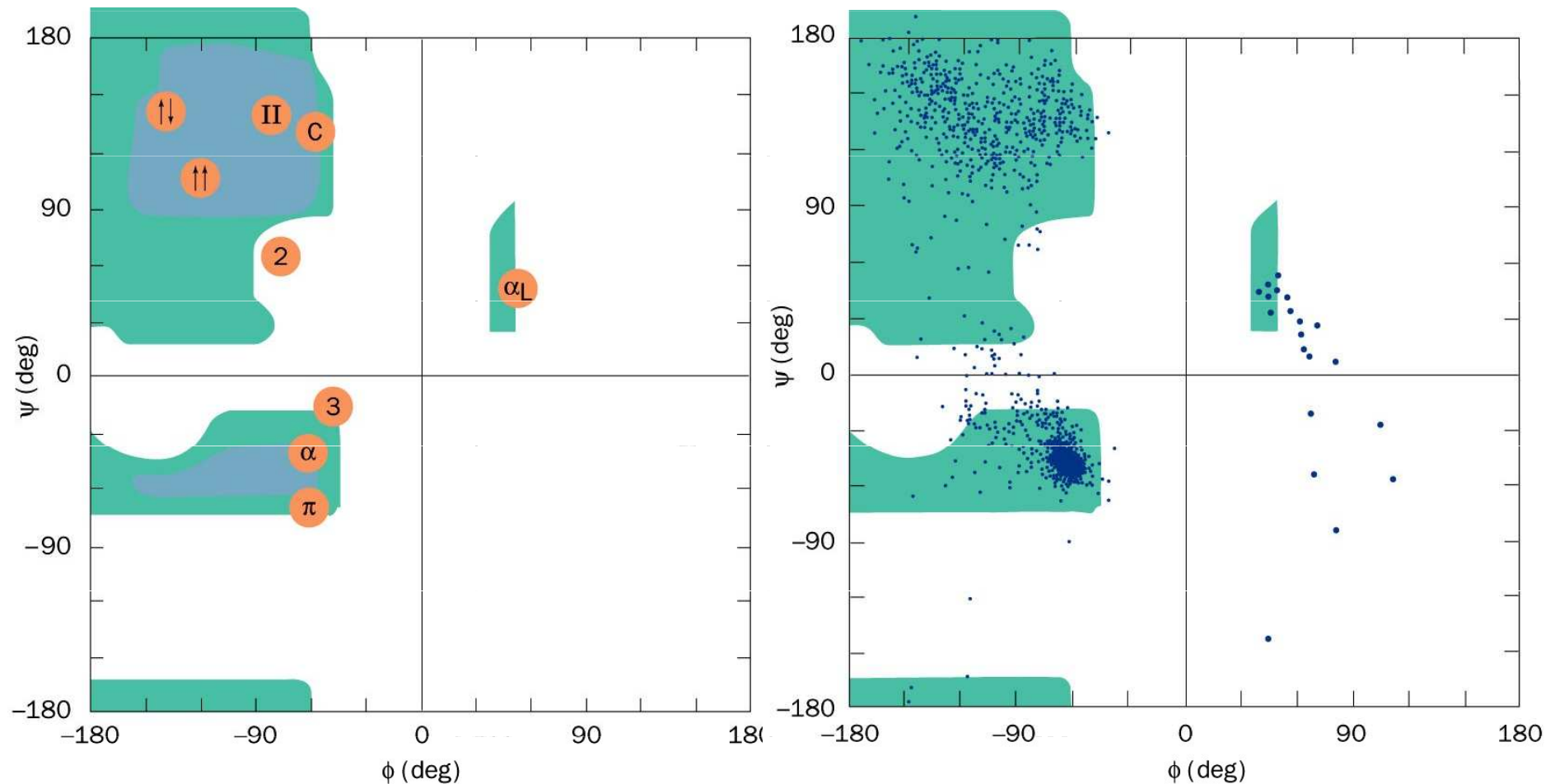

D. Řetězec musí umožňovat maximální počet vodíkových vazeb mezi peptidickými vazbami

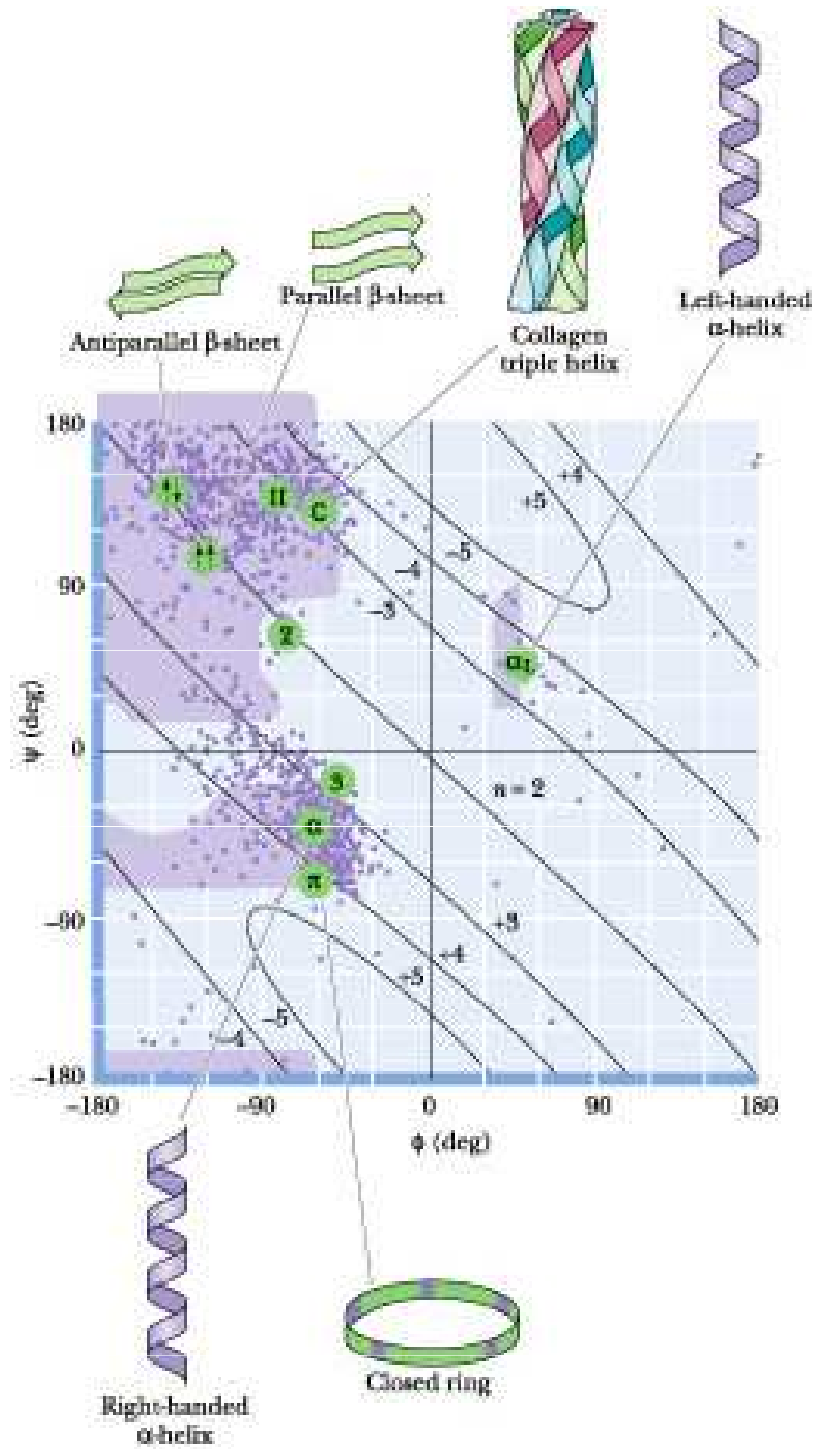

Typy sekundárních struktur :

A. Pravidelné - helikální struktury - α helix (-56, -47)

- β struktury - skládaný list - paralelní (-139, +135) a
antiparalelní (-119, +113)

B. Ohybové - β ohyb

C. Nepravidelné

α - helix

- Torzní úhly
- Počet AMK na závit
- Výška závitů

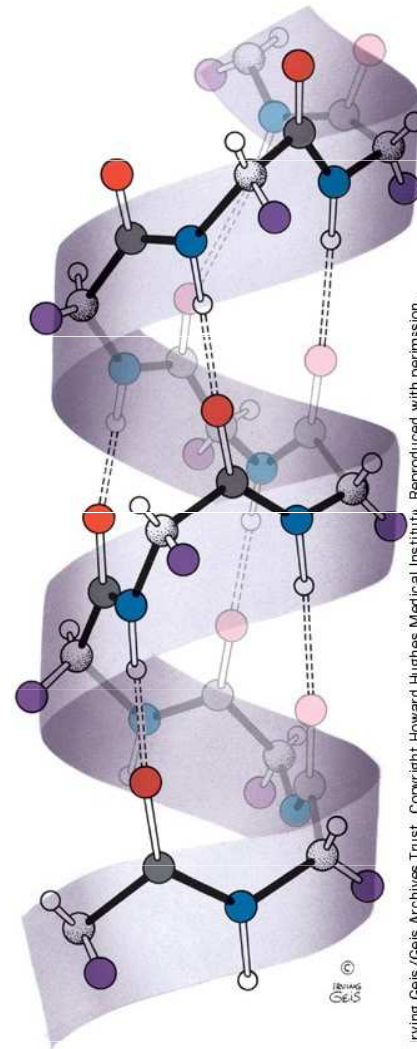

3,6 AMK na závit

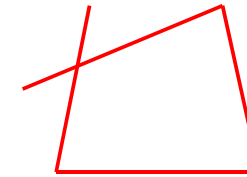

H můstek mezi C=O n-té peptidické vazby a N-H n+4 peptidické vazby



Optimální vzdálenost 0,28 nm

α - helix

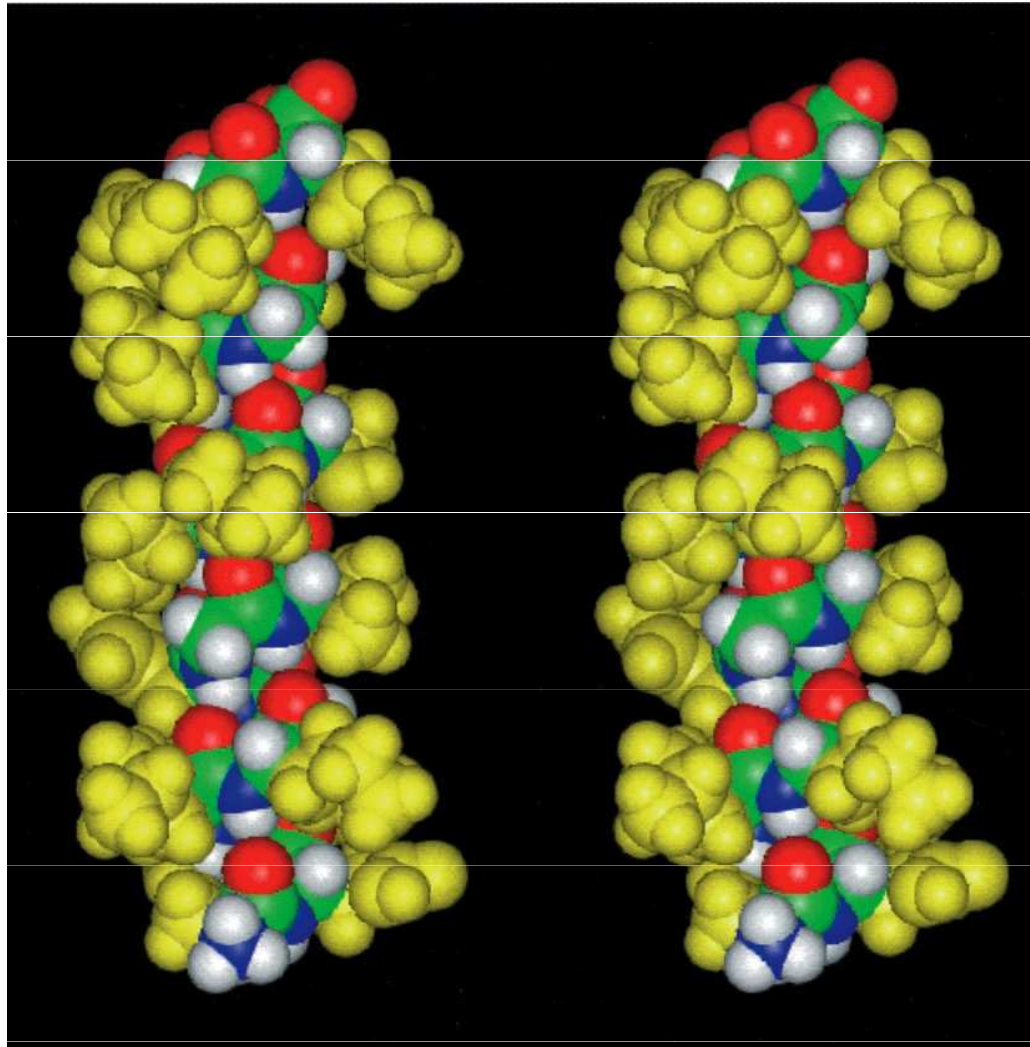

β - sheet

(a) **Antiparallel**

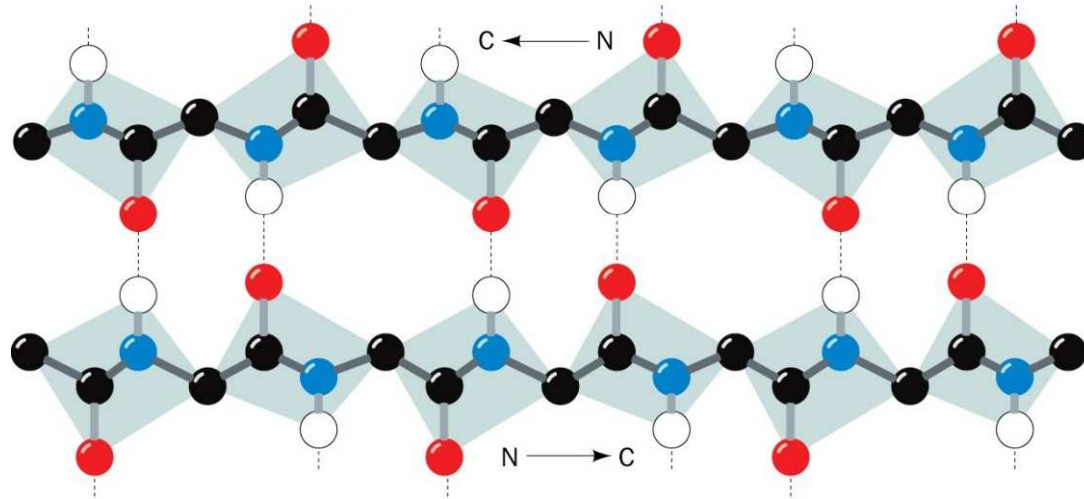

Irving Geis/Geis Archives Trust. Copyright Howard Hughes Medical Institute. Reproduced with permission.

(b) **Parallel**

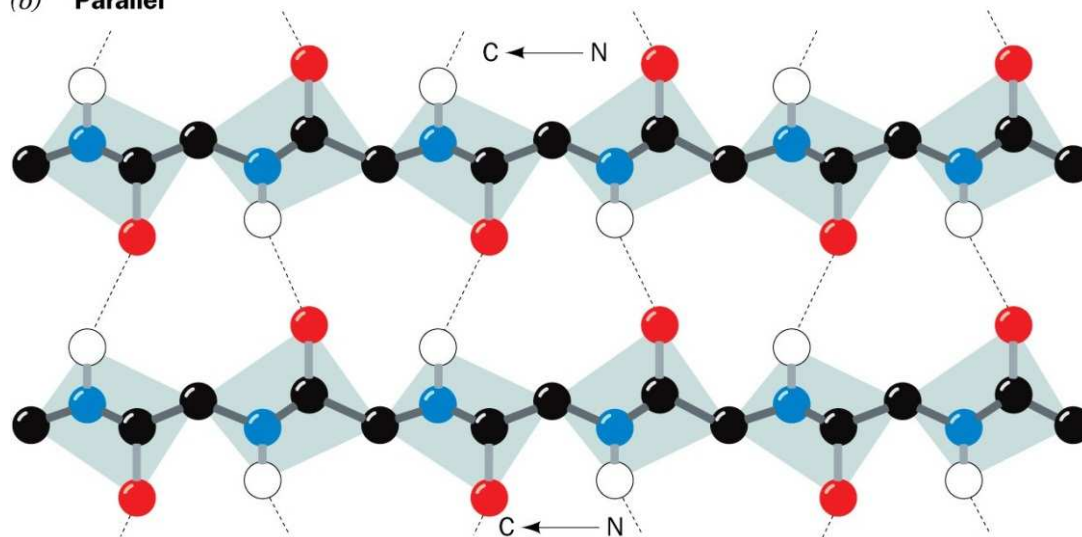

Irving Geis/Geis Archives Trust. Copyright Howard Hughes Medical Institute. Reproduced with permission.

β - sheet

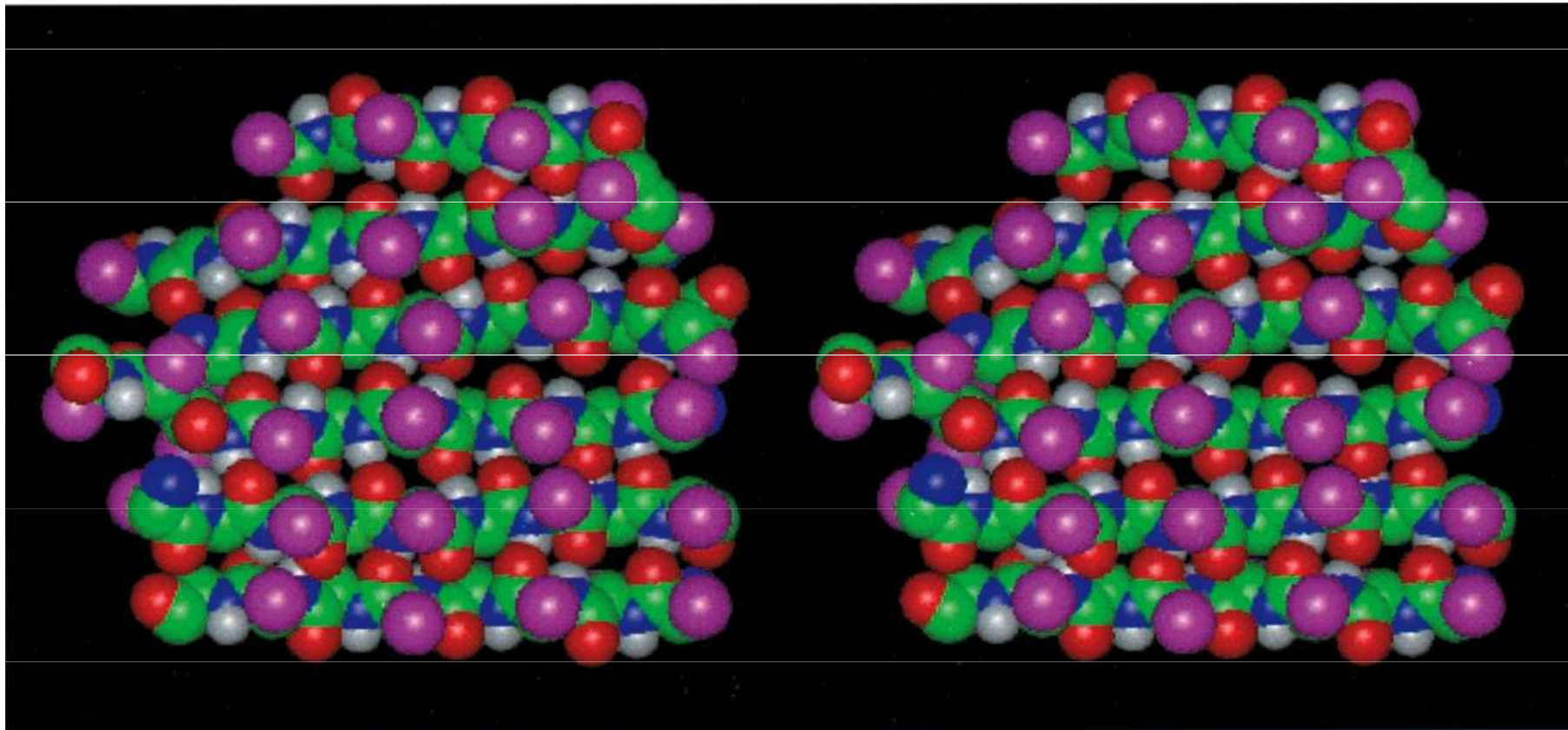

β - turn

(a) Type I β bend

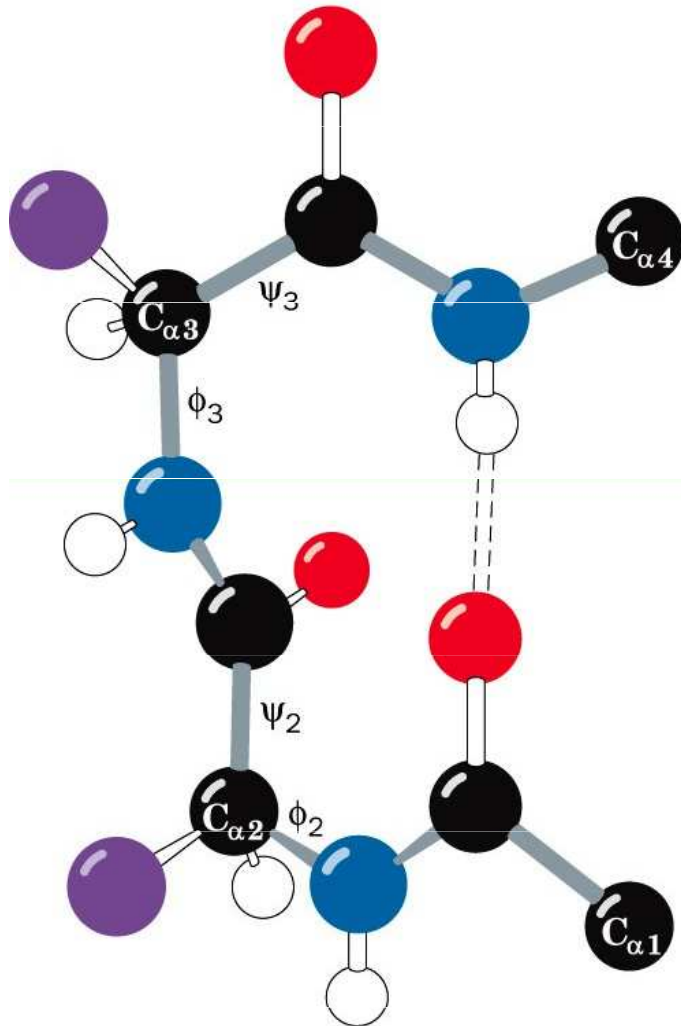

(b) Type II β bend

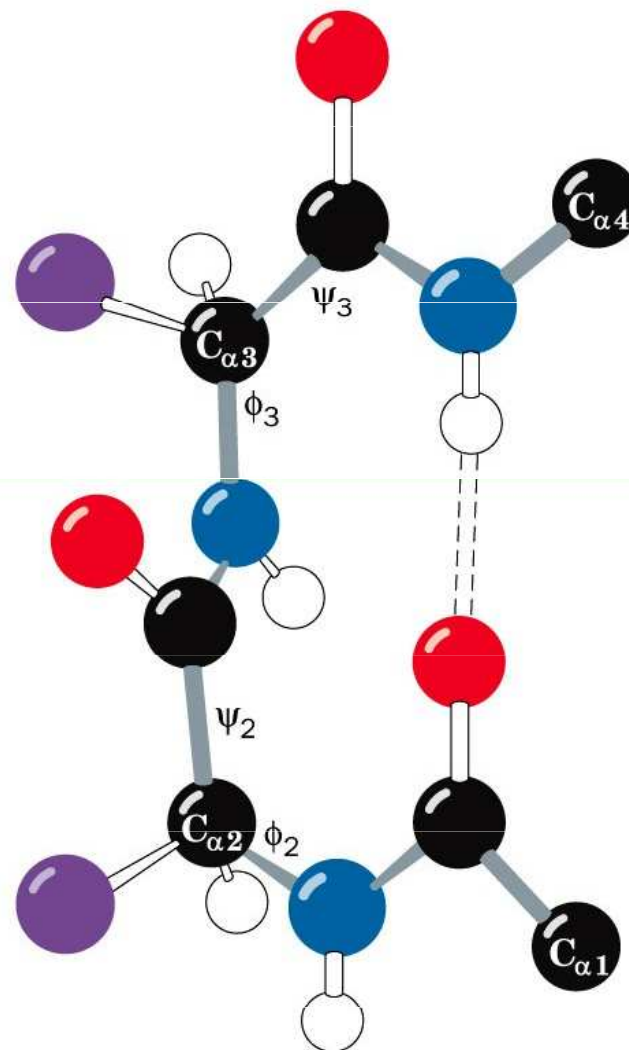

β - turn

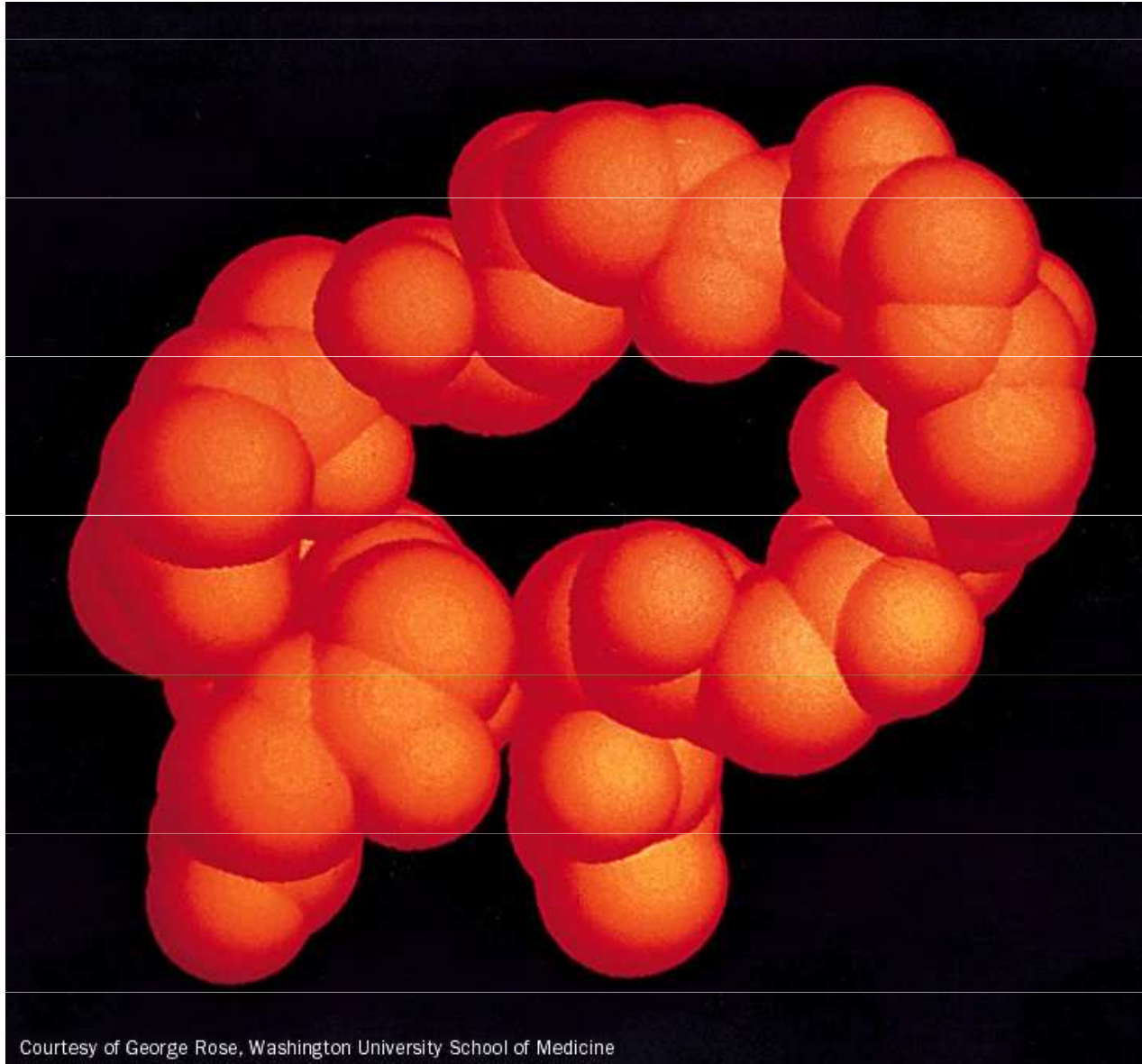

Terciální struktura

1. Iontové interakce
2. Dipolové interakce
3. Vodíkové můstky
4. Hydrofobní interakce
5. Bisulfidické můstky

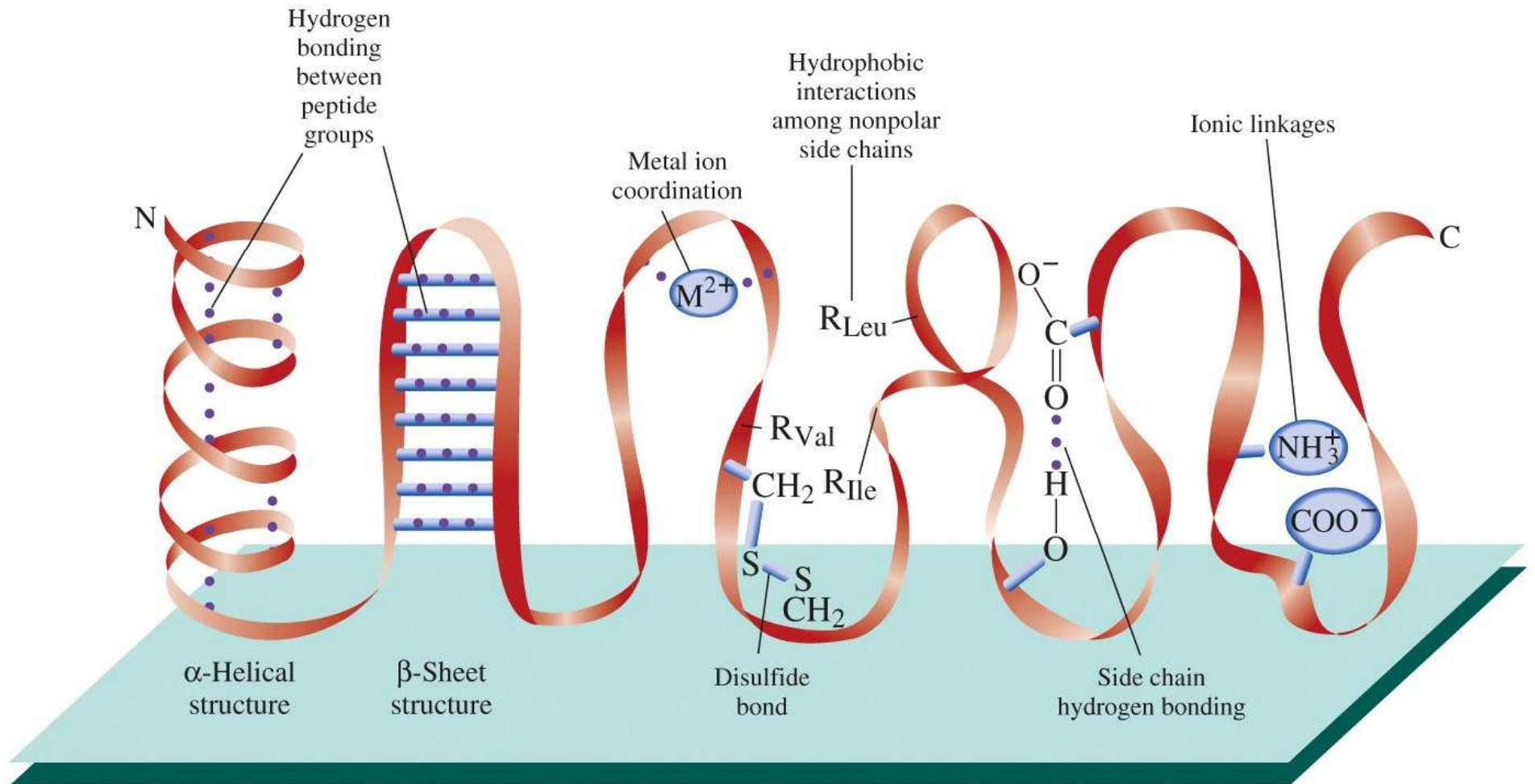
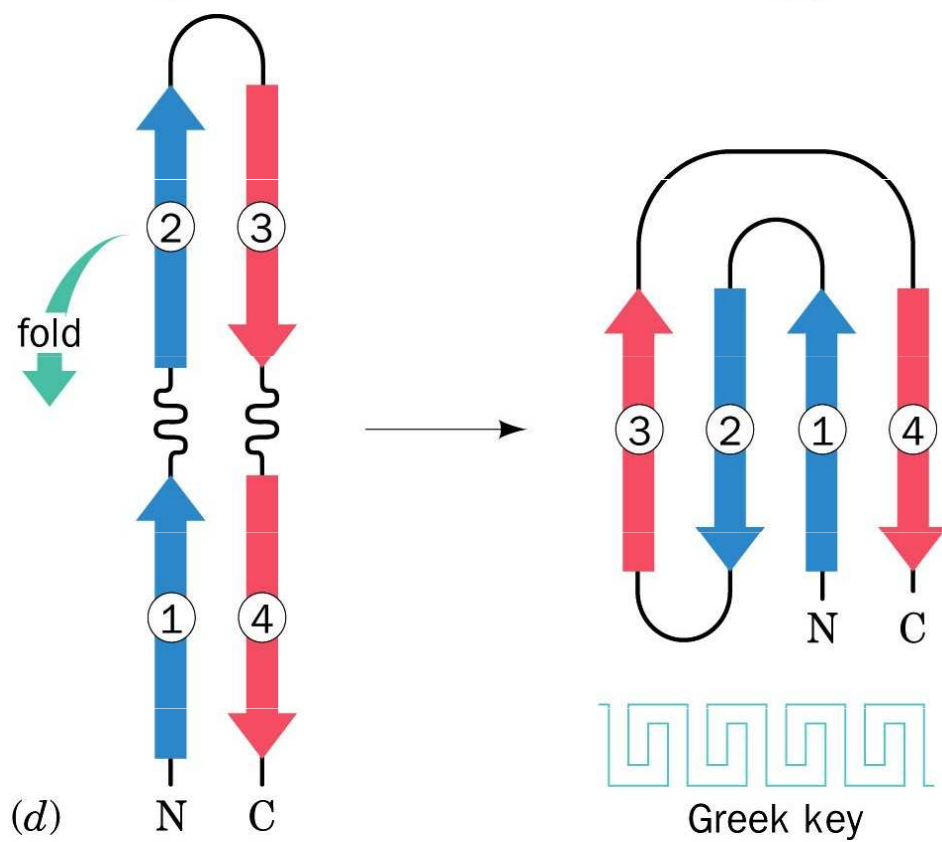
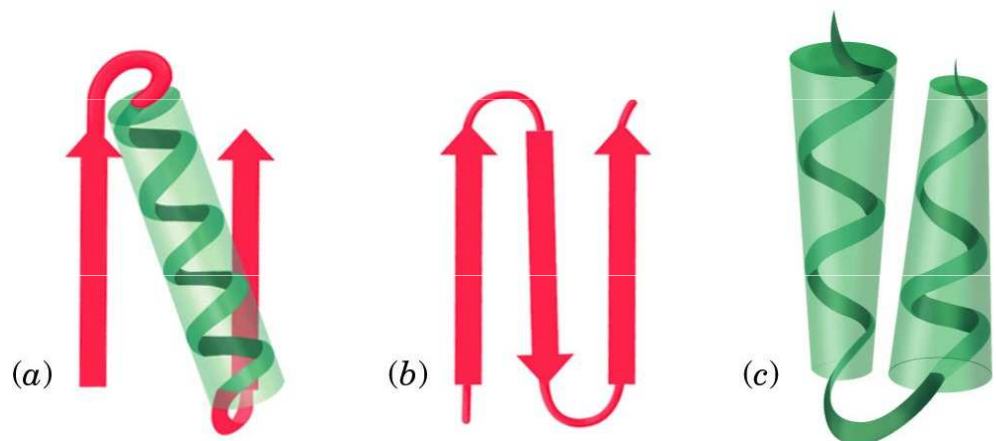
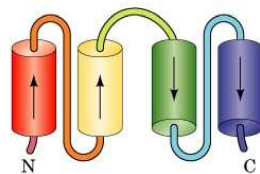
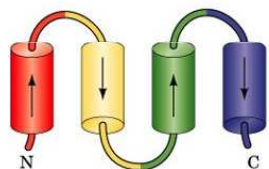
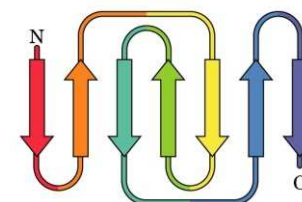
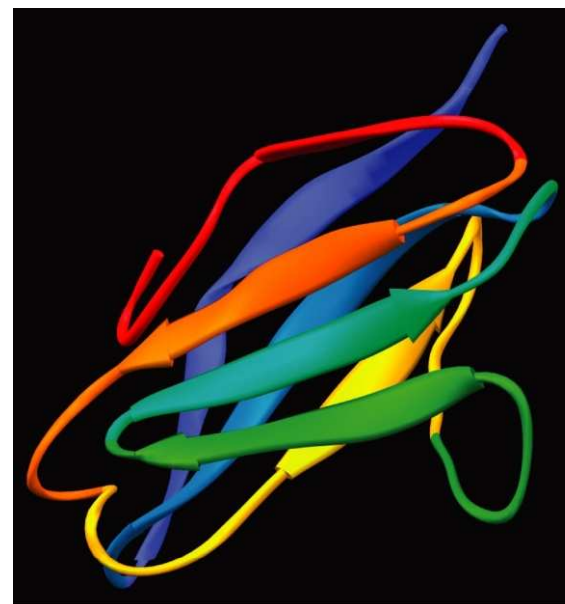
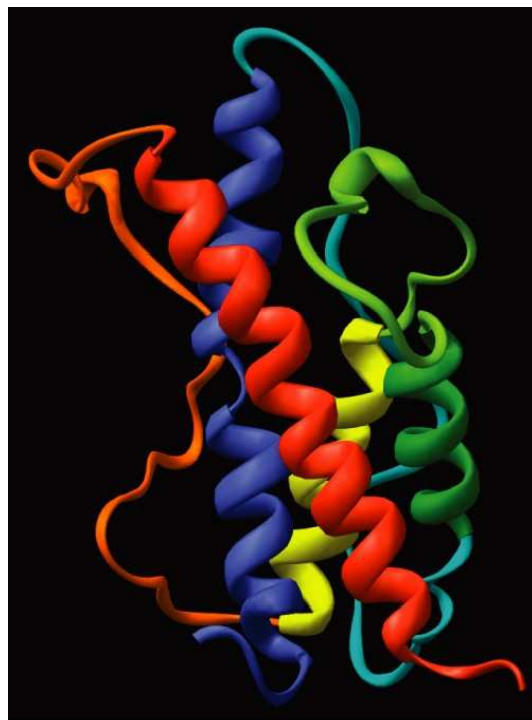
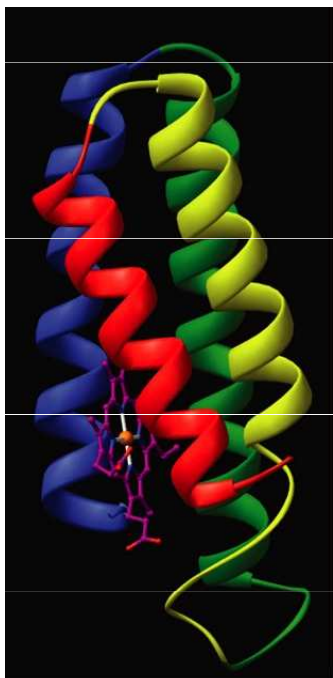

Figure 4-3 Concepts in Biochemistry, 3/e
 © 2006 John Wiley & Sons

Strukturní motivy



Strukturní motivy



Strukturní domény

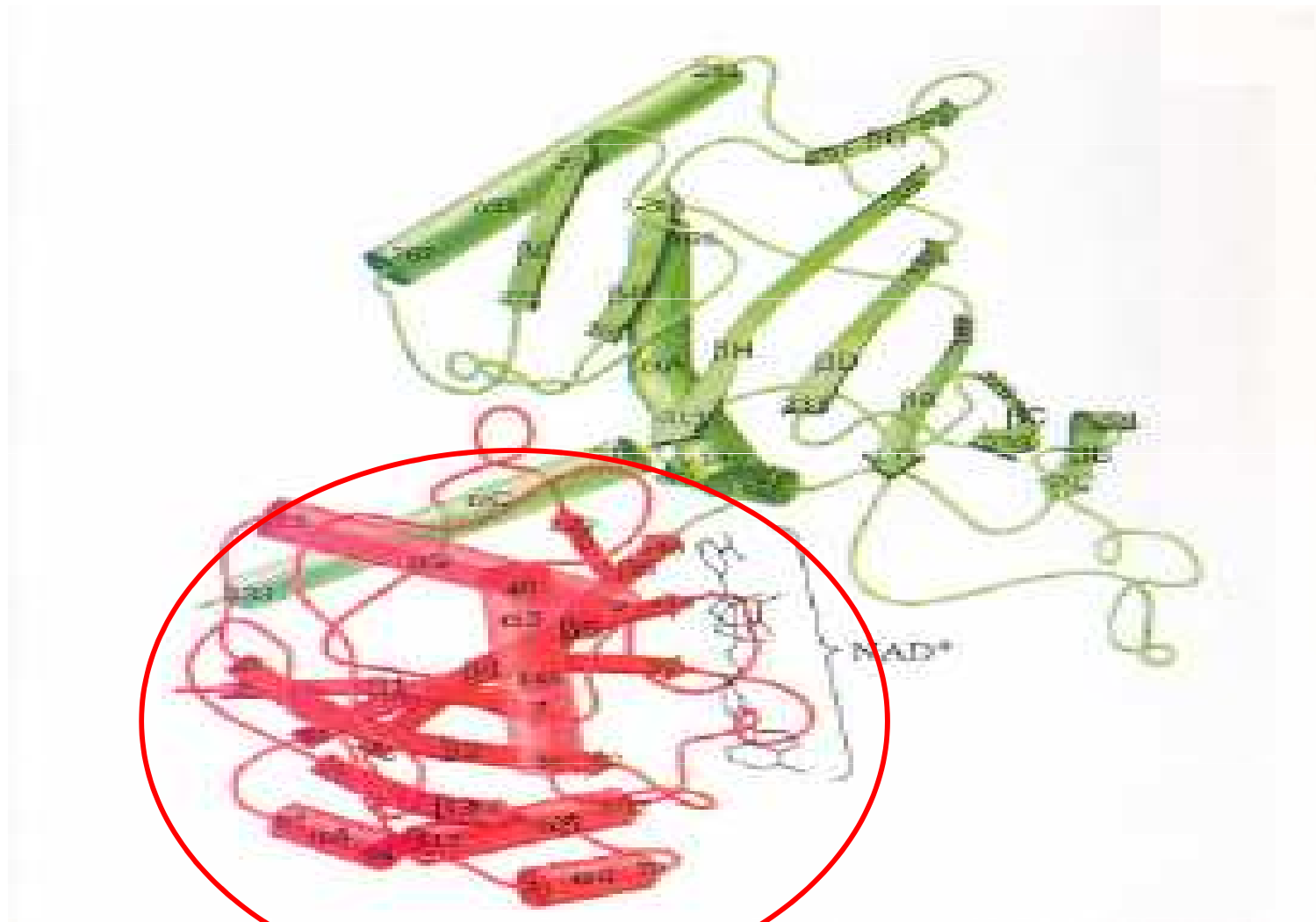

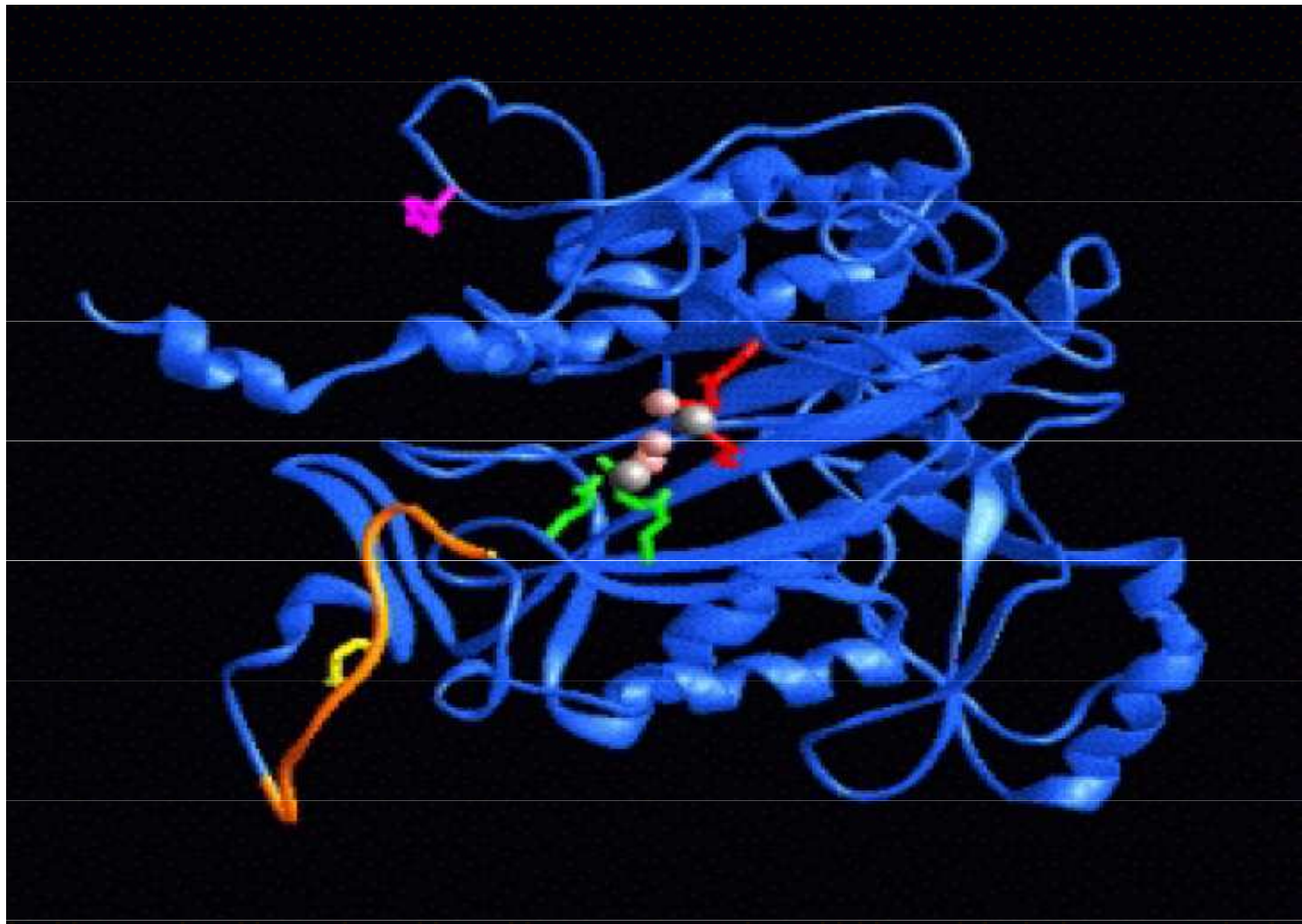

Strukturní domény IgG

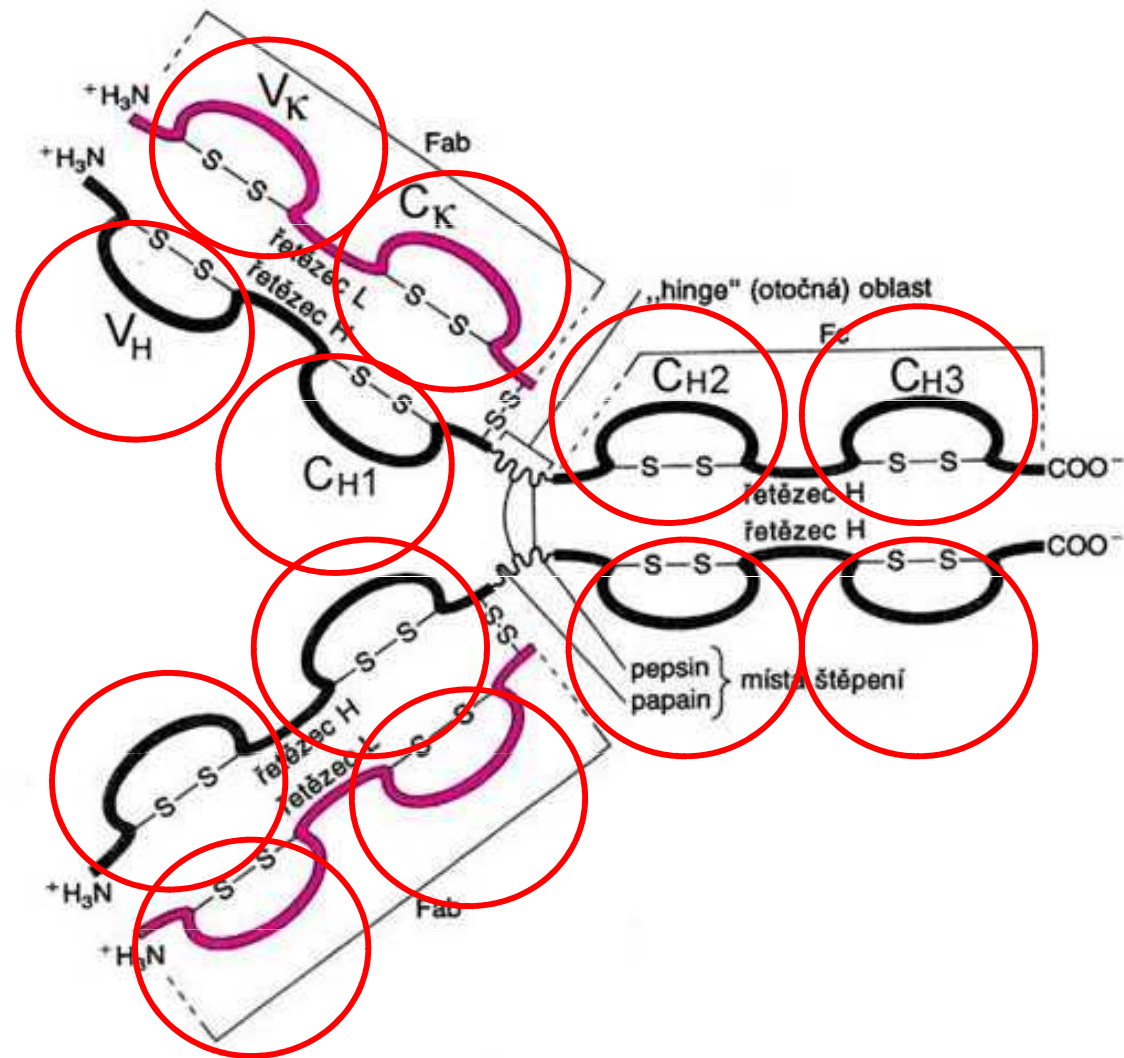

Kvarterní struktura

Podjednotkové složení – více polypeptidických řetězců

- **Usnadnění proteosyntézy**
- **Možnost regulací – allosterie, izoenzymy**
- **Multienzymové komplexy – enzymové továrny**

Hemoglobin

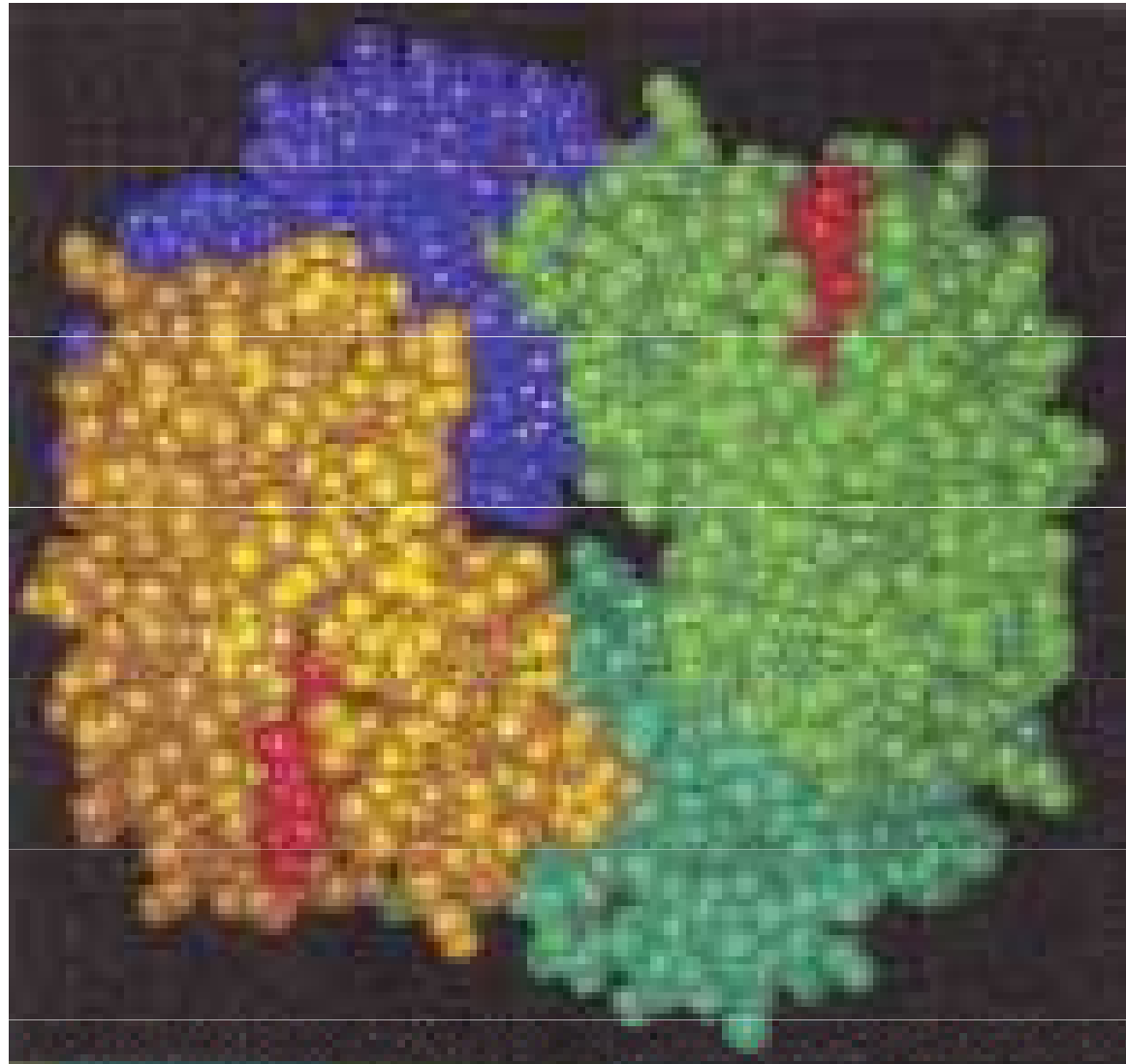

Hemoglobin allosterie

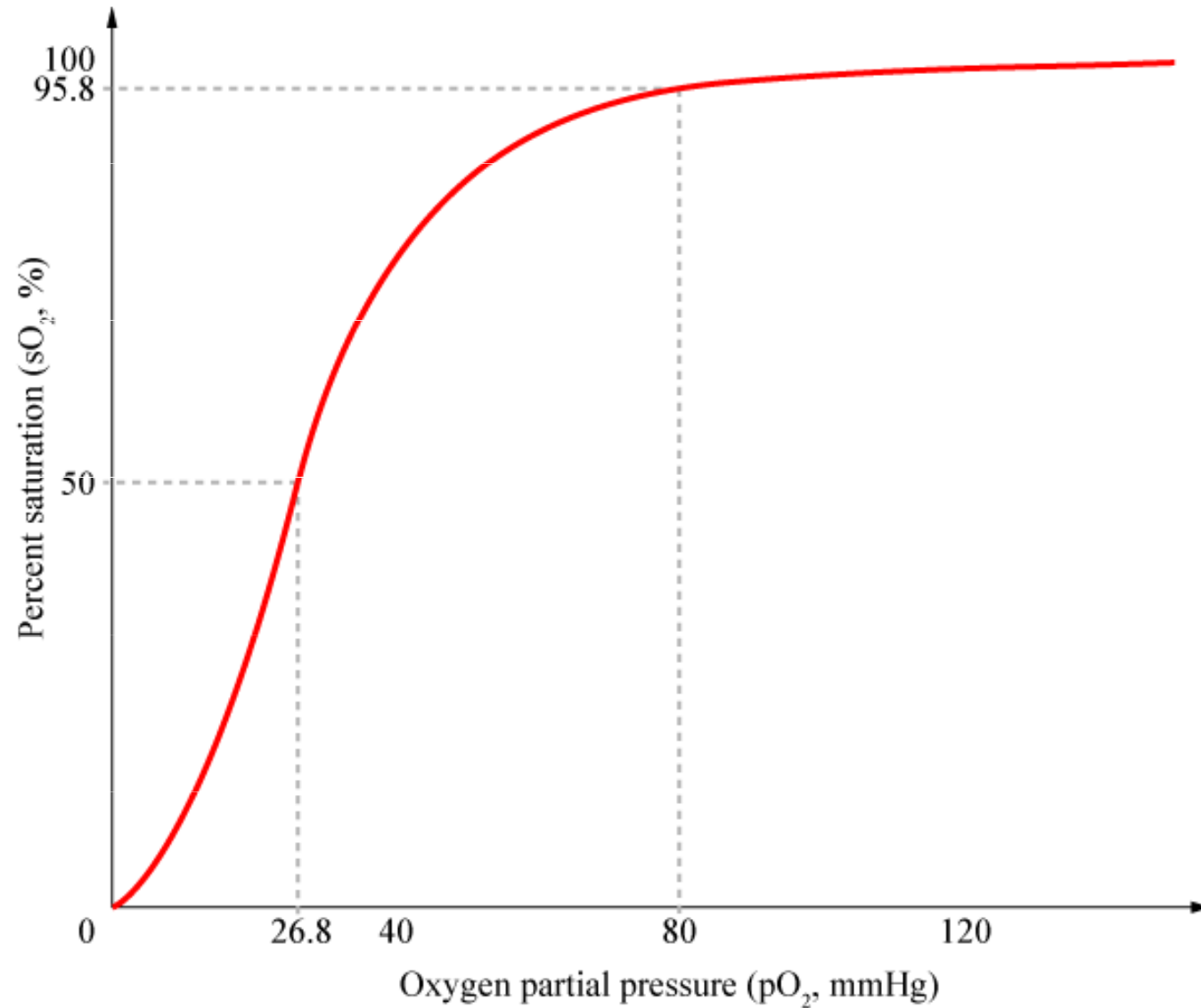

Hb versus Mb

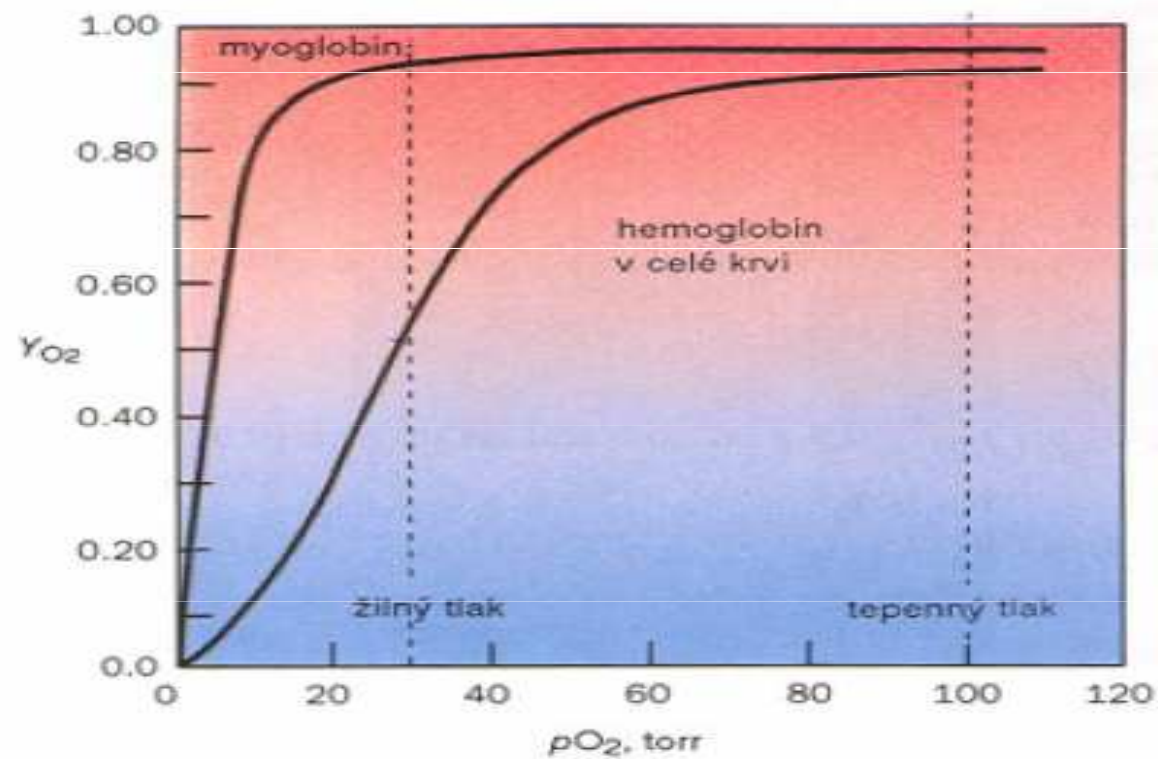
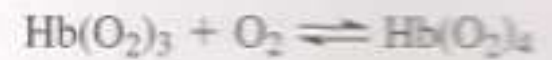
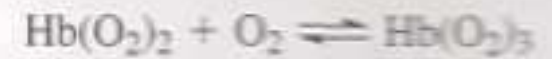
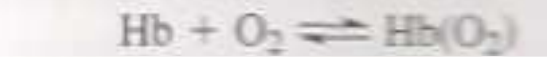

Laktátdehydrogenáza

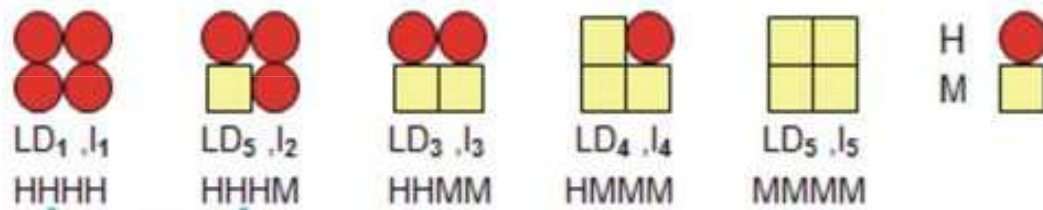
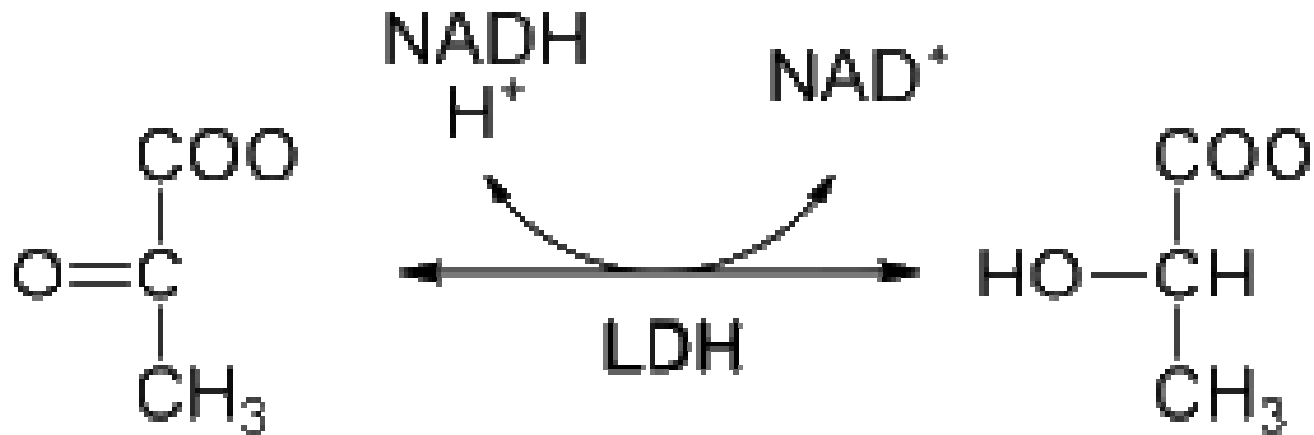

Sávra



Corriho cyklus

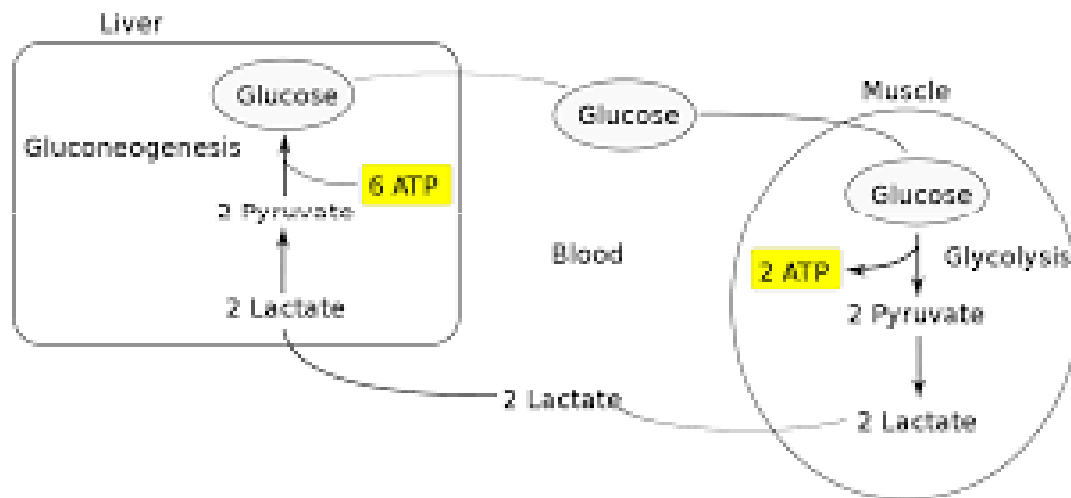

Pyruvátdehydrogenáza

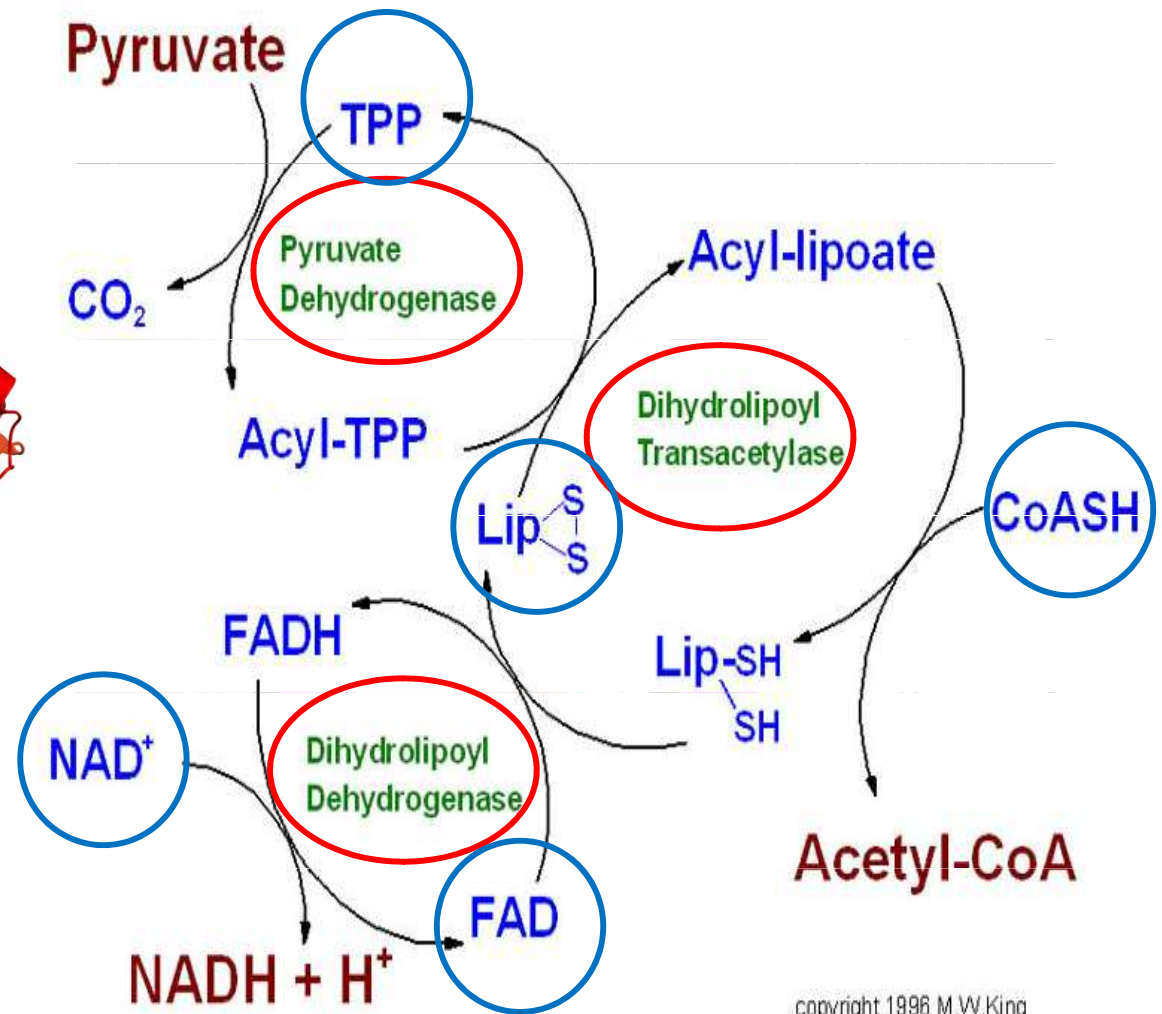
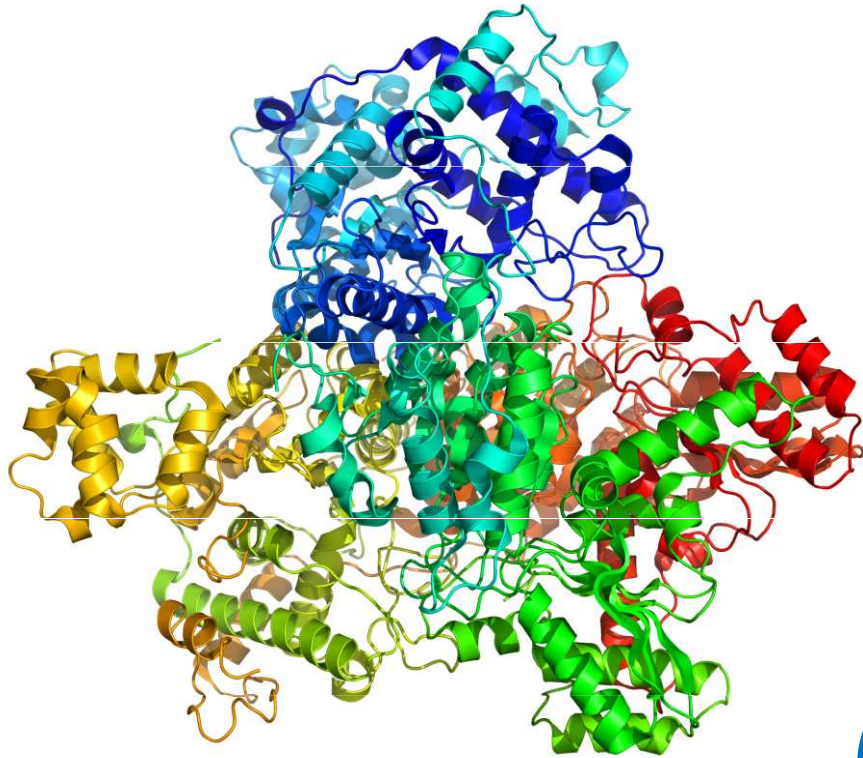

Synthasa mastných kyselin

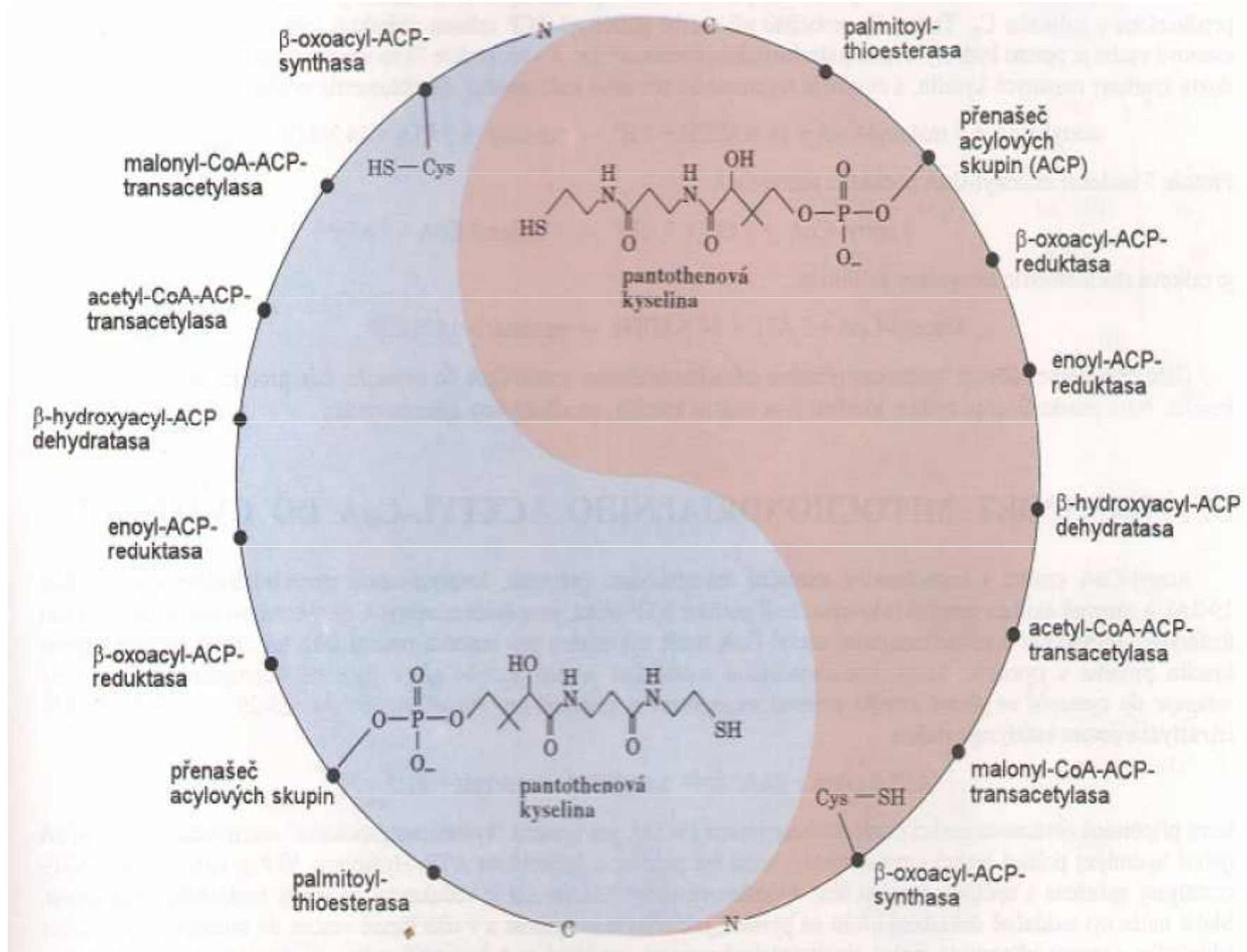

Kvarterní struktura

Podjednotkové složení - nekovalentní spojení - vodíkové můstky

- kovalentní spojení - bisulfidické můstky

Stanovení podjednotkového složení - SDS PAGE

Studium konformace bílkovin

RTG difrakce - studium krystalů - BRAGG 1913

NMR - dvoj- a trojrozměrné - studium roztoků - posledních 15 let

Rtg difrakce

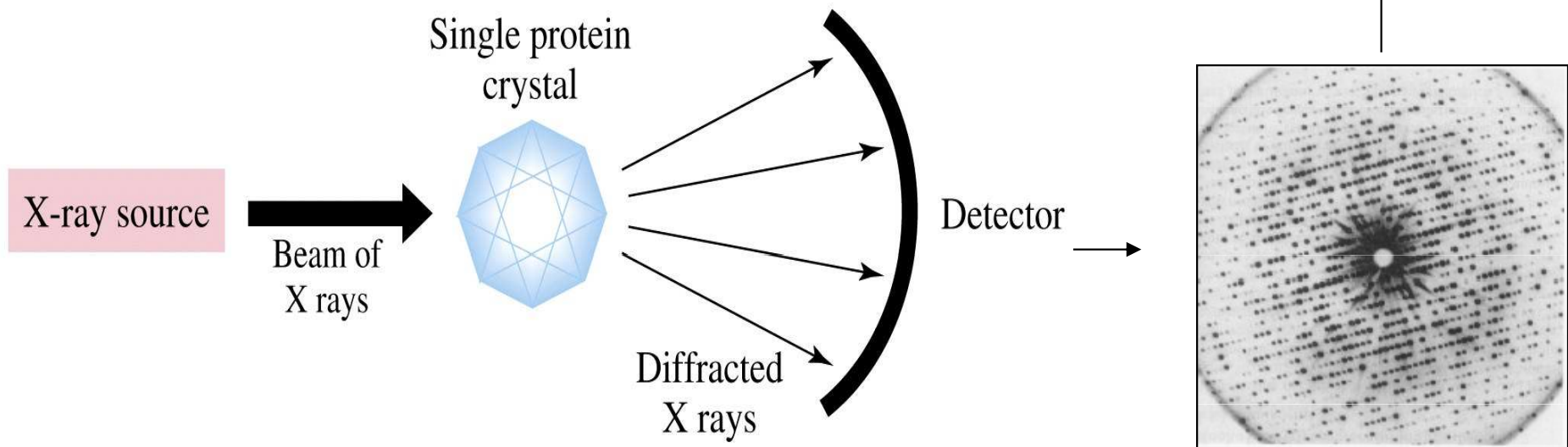
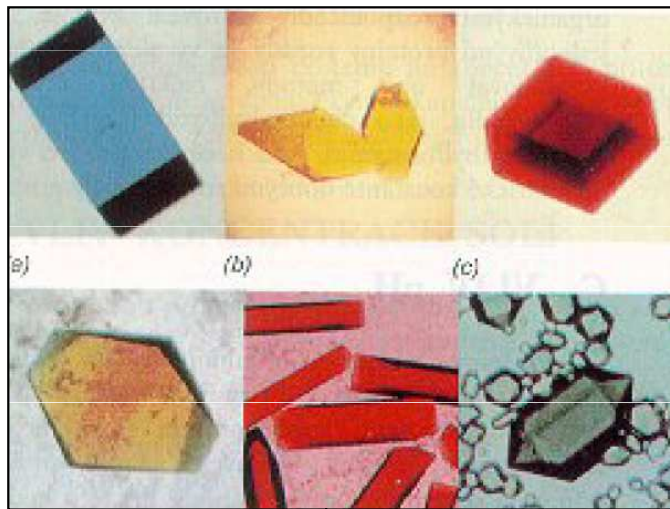
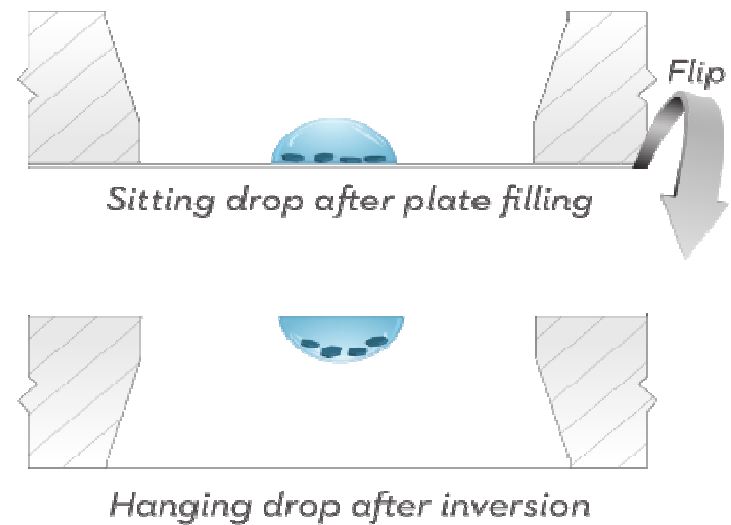
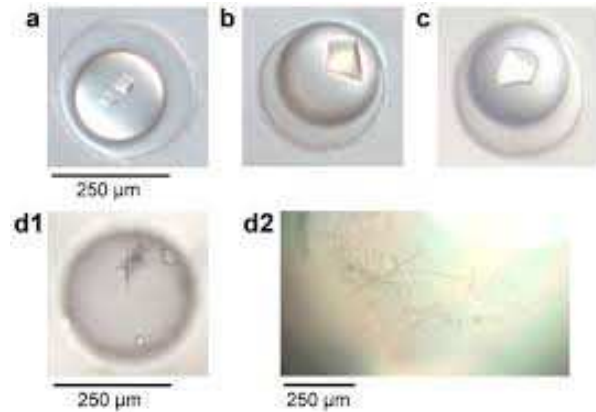
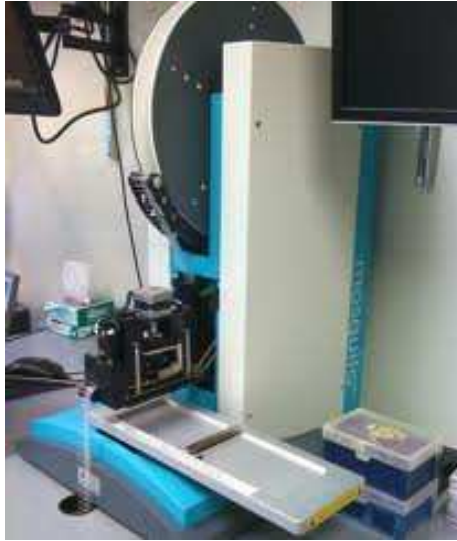
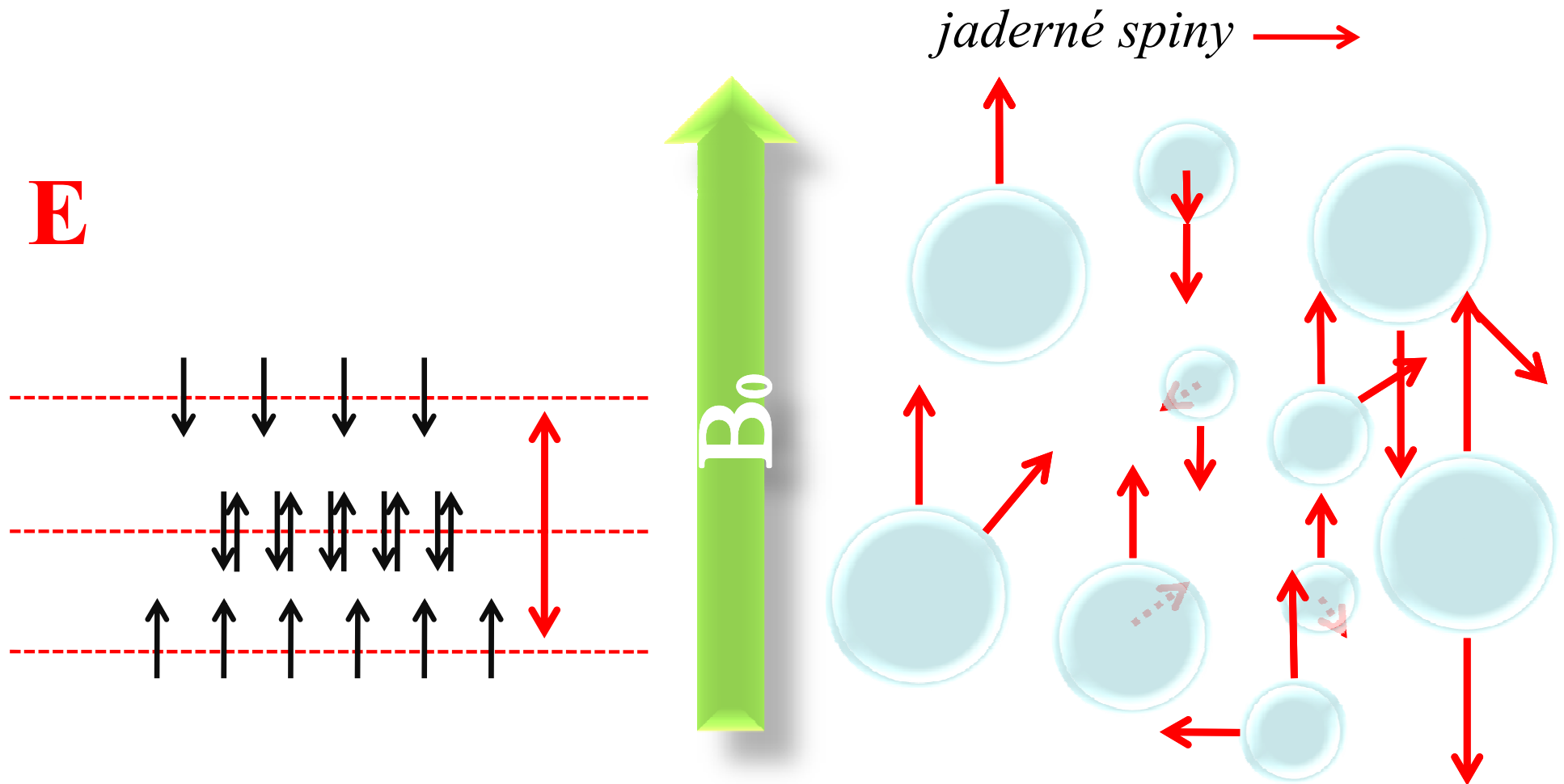

Figure 4-15 Concepts in Biochemistry, 3/e
© 2006 John Wiley & Sons

Rtg difrakce



NMR podstata



NMR

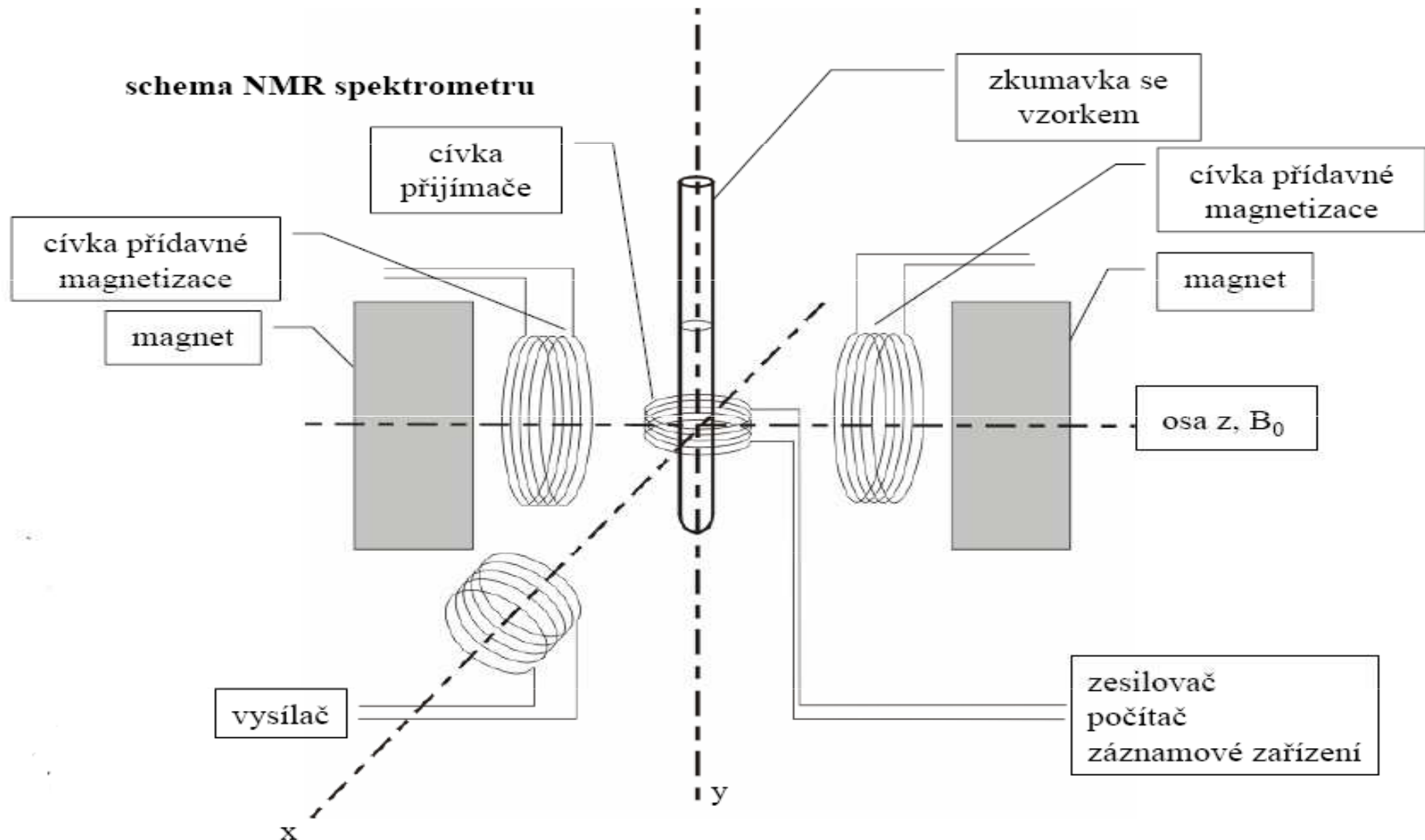

NMR spektrum

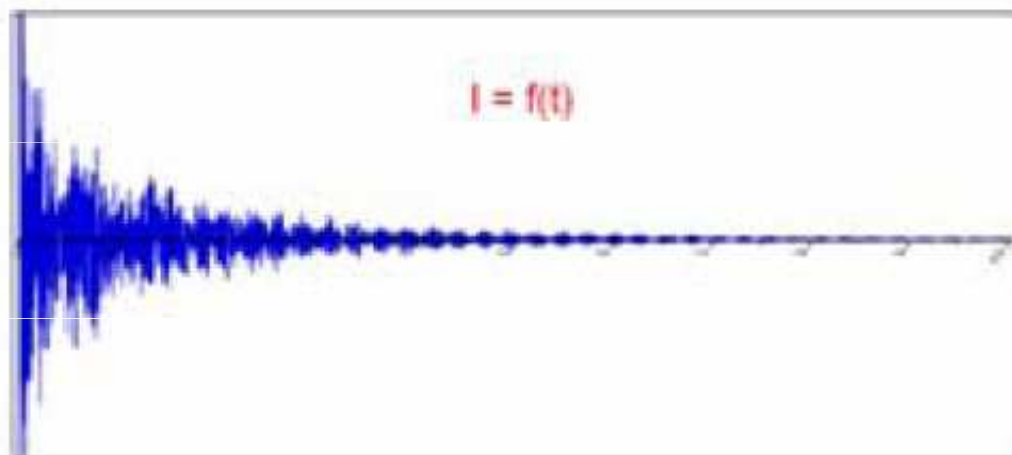

Po zpracování Fourierovou transformací dostaneme:

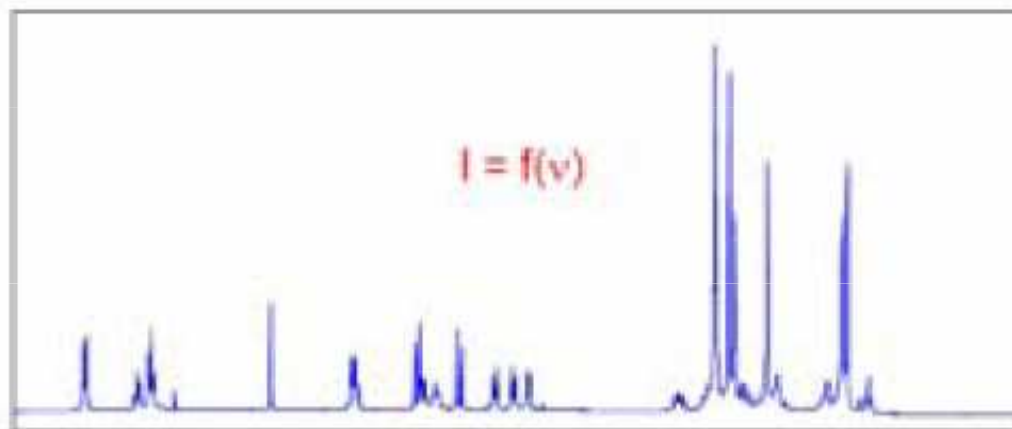

Blokové schéma

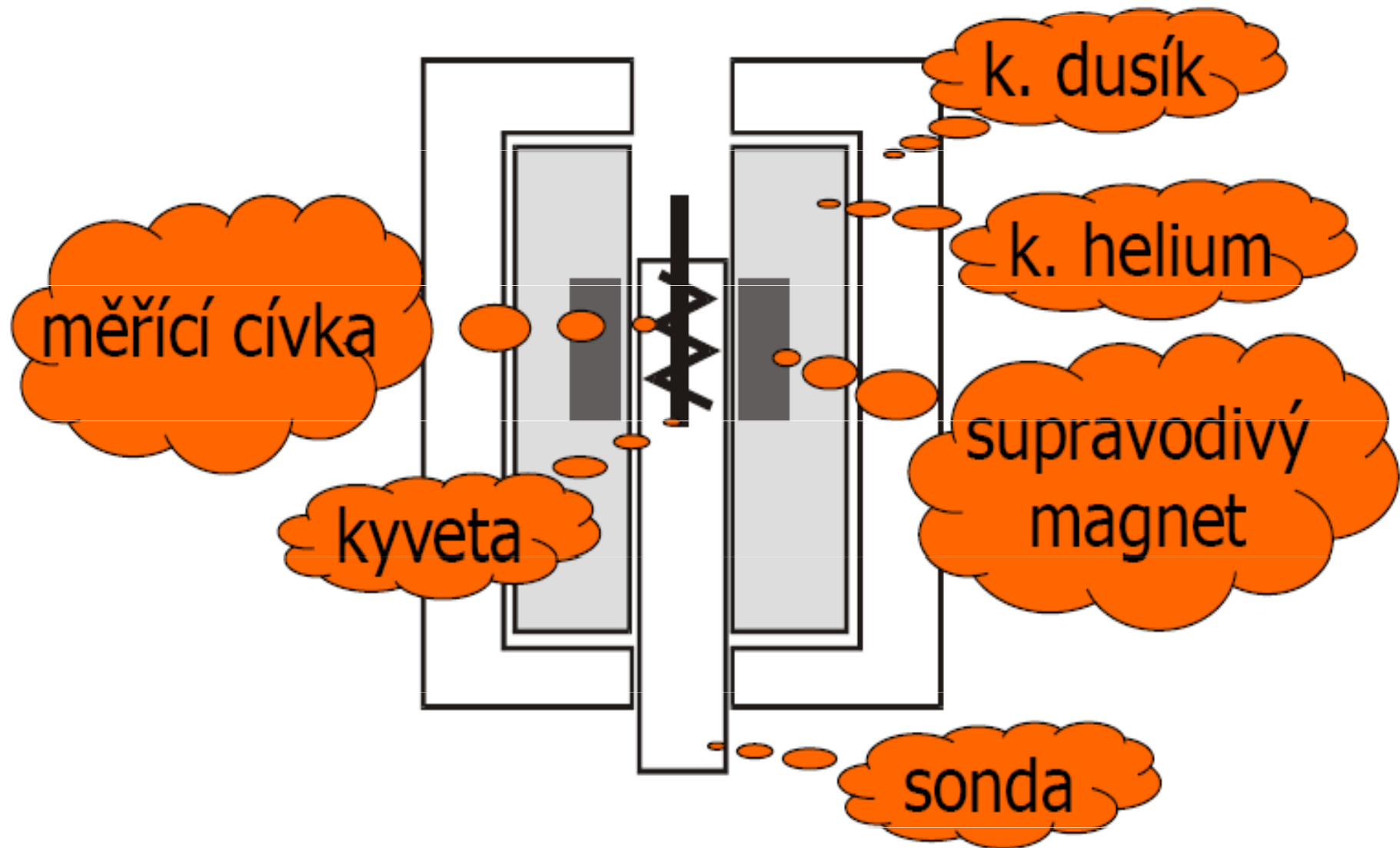

NMR

počítač

elektronika

supra-
vodivý
magnet



NMR spektrum

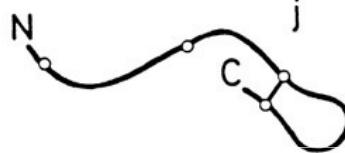
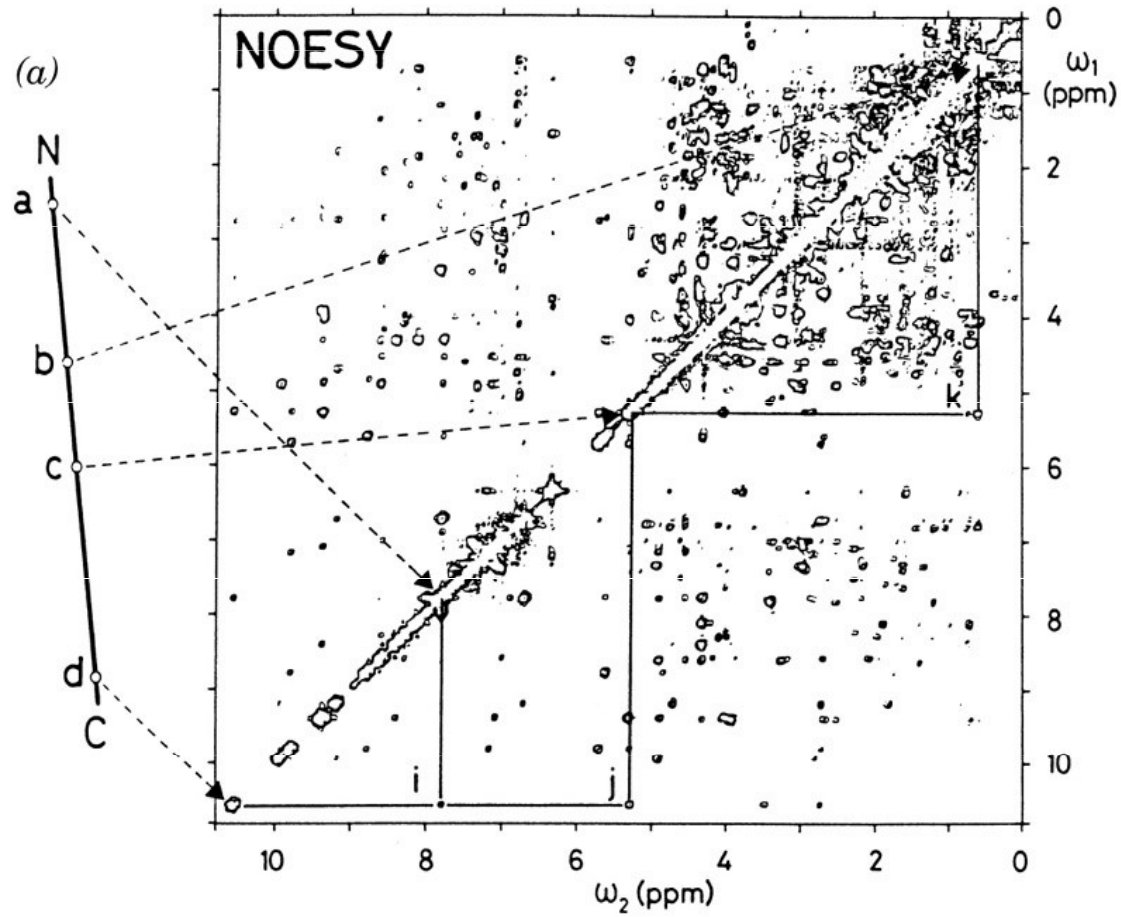

After Wuthrich, K. *Science* **243**, 45 (1983)

NMR

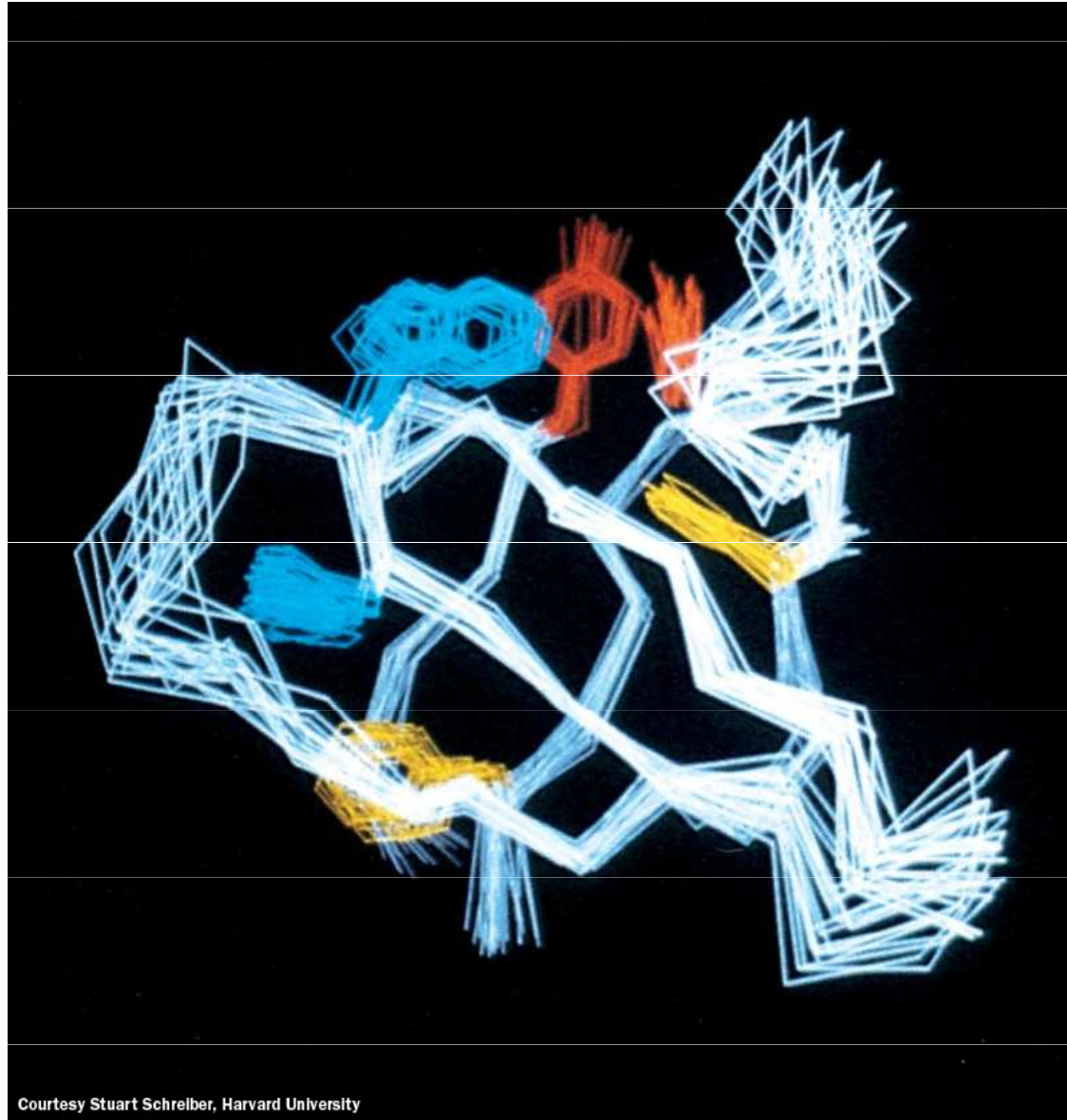

Courtesy Stuart Schreier, Harvard University

Stabilita konformace

Denaturace - fyzikální faktory - T, záření, tlak,
- chemické faktory - pH, organická rozpouštědla,
detergenty, těžké kovy, močovina,

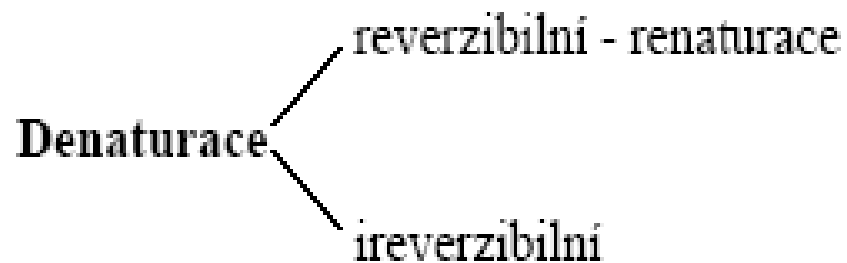
Denaturace 

```
graph LR; A[Denaturace] --- B[reverzibilní - renaturace]; A --- C[ireverzibilní]
```

Denaturace - renaturace

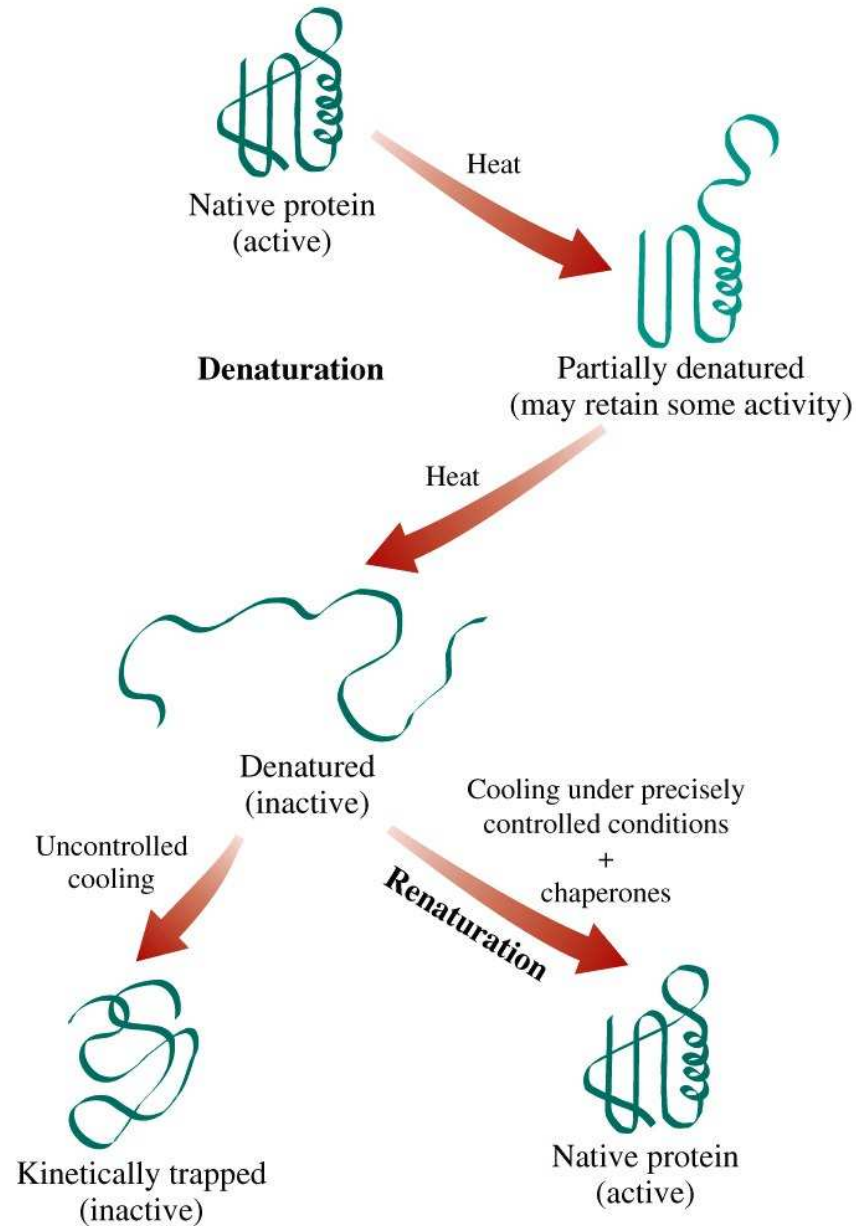
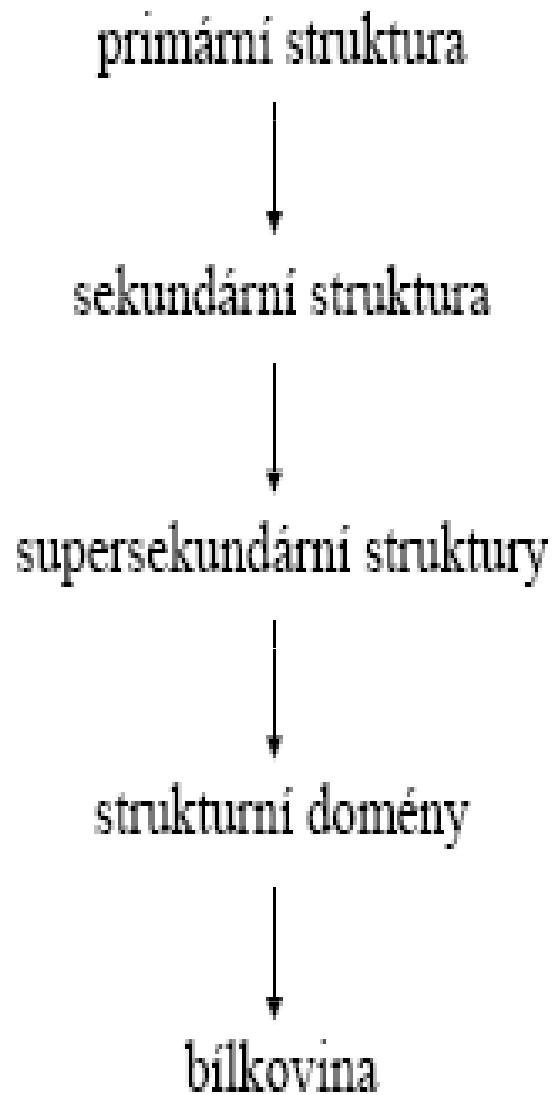

Figure 4-14 Concepts in Biochemistry, 3/e
© 2006 John Wiley & Sons

Vznik prostorové struktury - skládání, svinutí - „FOLDING“



Levinthal Paradox

- We assume that there are three conformations for each amino acid (ex. α -helix, β -sheet and random coil). If a protein is made up of 100 amino acid residues, a total number of conformations is :

$$3^{100} = 515377520732011331036461129765621272702107522001 \\ \cong 5 \times 10^{47}.$$

- If 100 psec (10^{-10} sec) were required to convert from a conformation to another one, a random search of all conformations would require

$$5 \times 10^{47} \times 10^{-10} \text{ sec} \cong 1.6 \times 10^{30} \text{ years}.$$

- However, folding of proteins takes place in msec to sec order. Therefore, proteins fold not via a random search but a more sophisticated search process.

Ideální

Landscape theory

Hledání

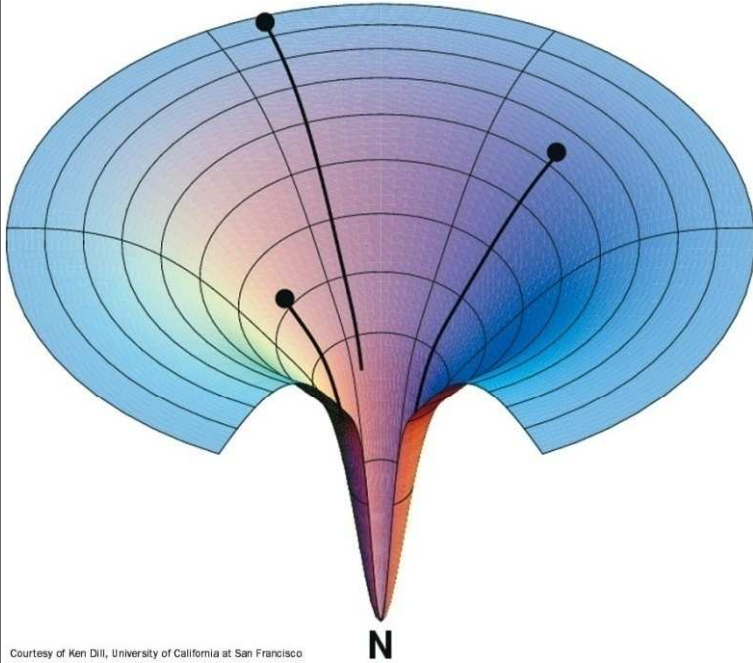

Courtesy of Ken Dill, University of California at San Francisco



Peter Wolynes

Přes intermediáty

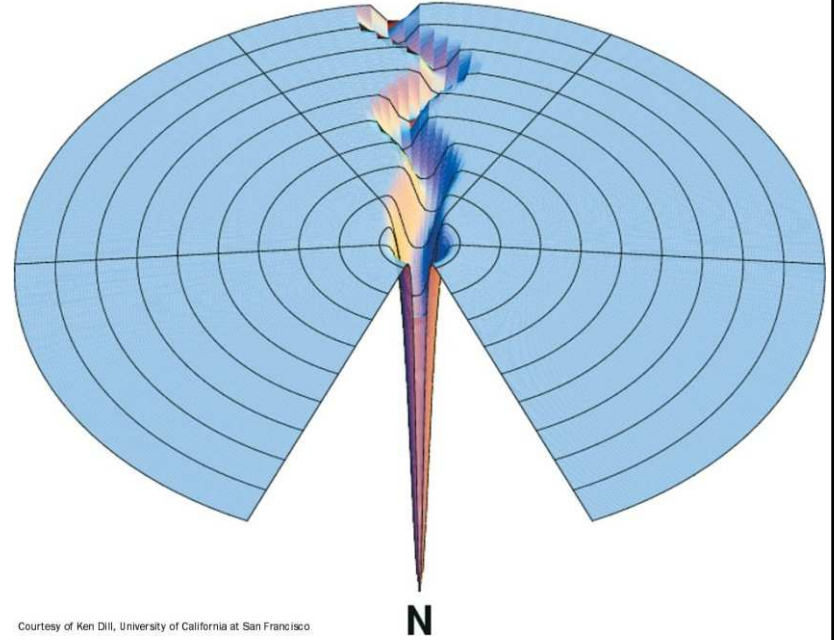

Courtesy of Ken Dill, University of California at San Francisco

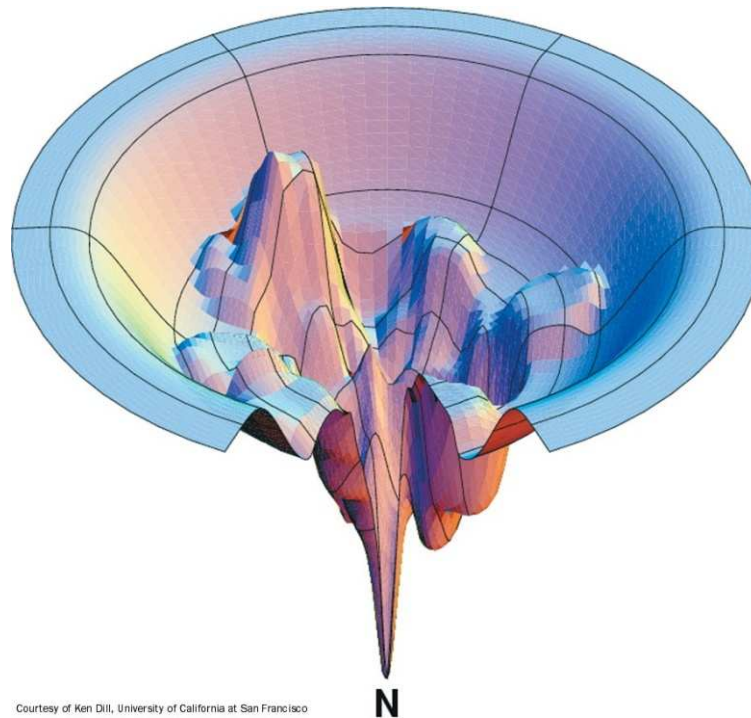

Courtesy of Ken Dill, University of California at San Francisco

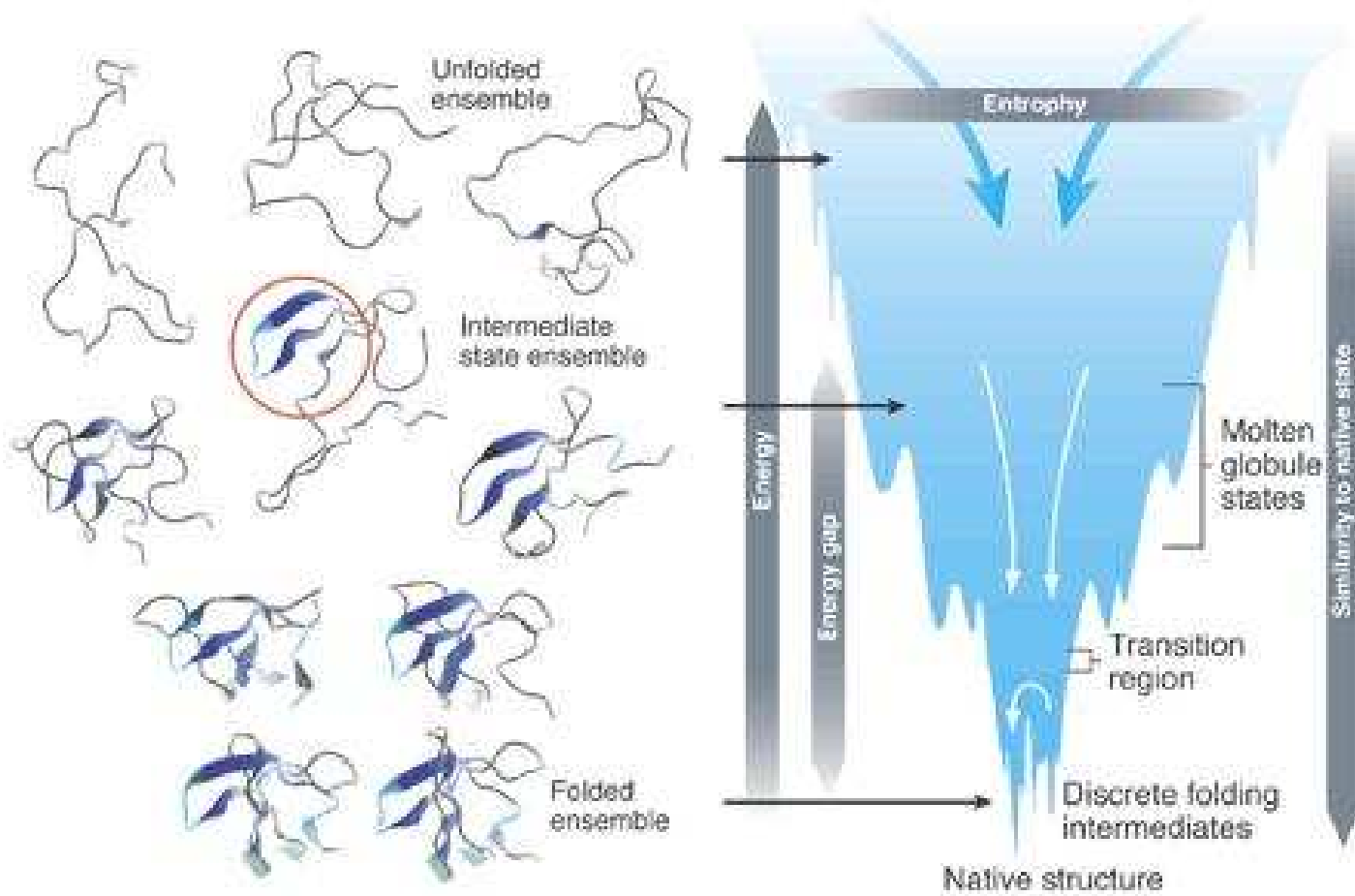

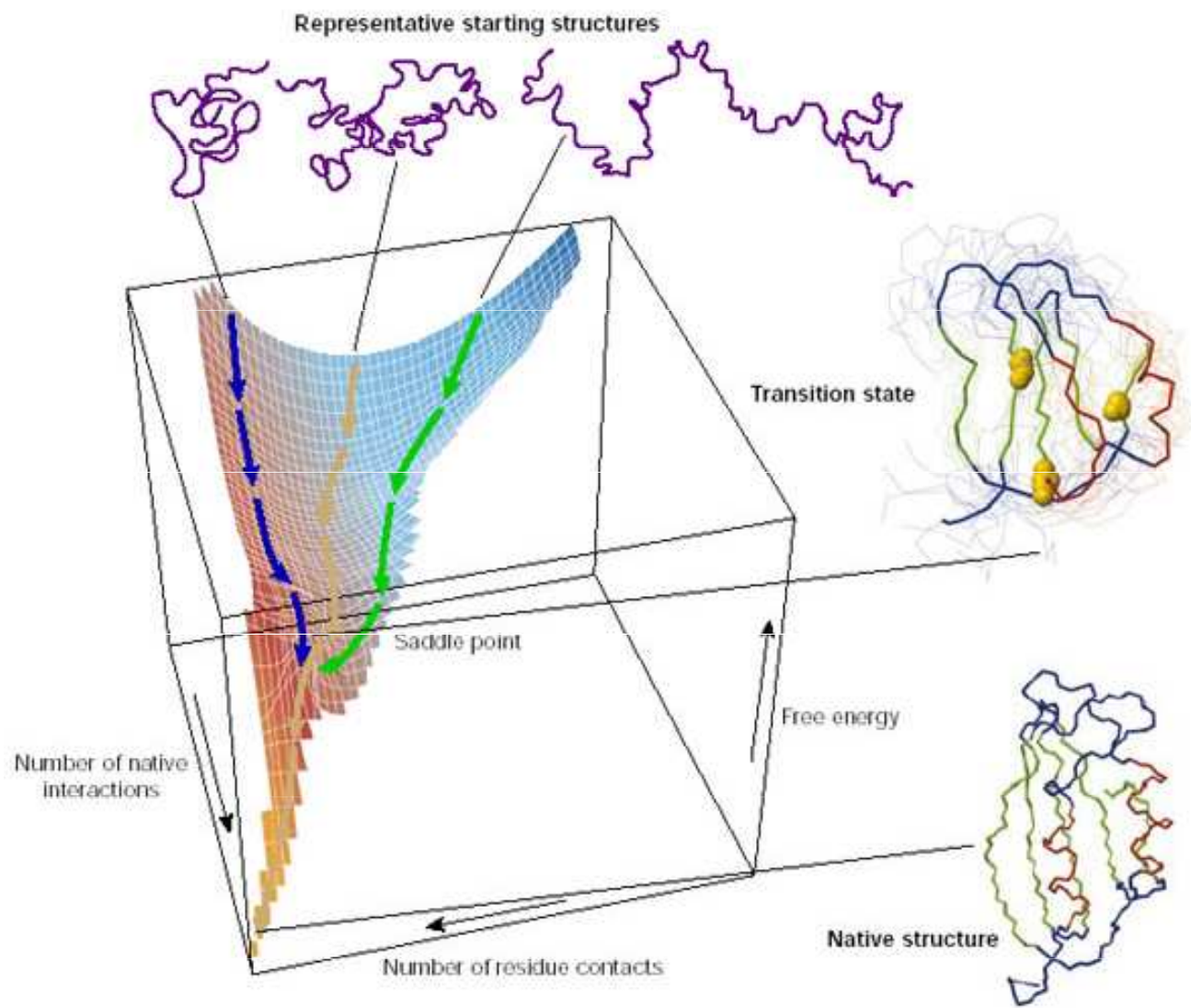

Skládání – folding bílkovin

- Neprobíhá náhodným způsobem
- Probíhá postupně:
 - a. malé dočasné periodické struktury
 - b. supersekundární struktury
 - c. strukturní domény a "roztavená" globule
 - d. závěrečné úpravy za účasti enzymů
- Potřebují bílkoviny ke svinování pomocníky?

POSTUP SKLÁDÁNÍ BÍLKOVIN

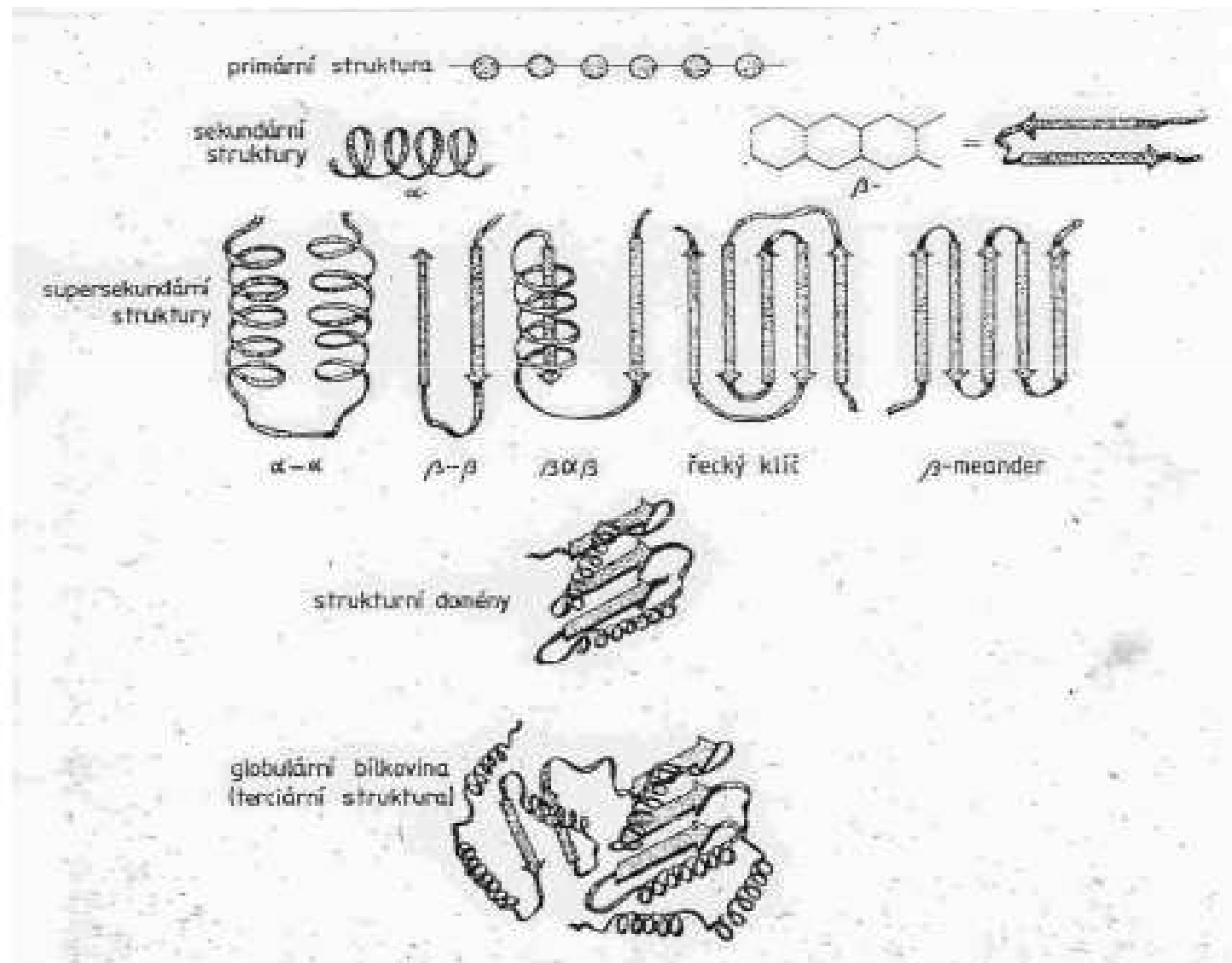

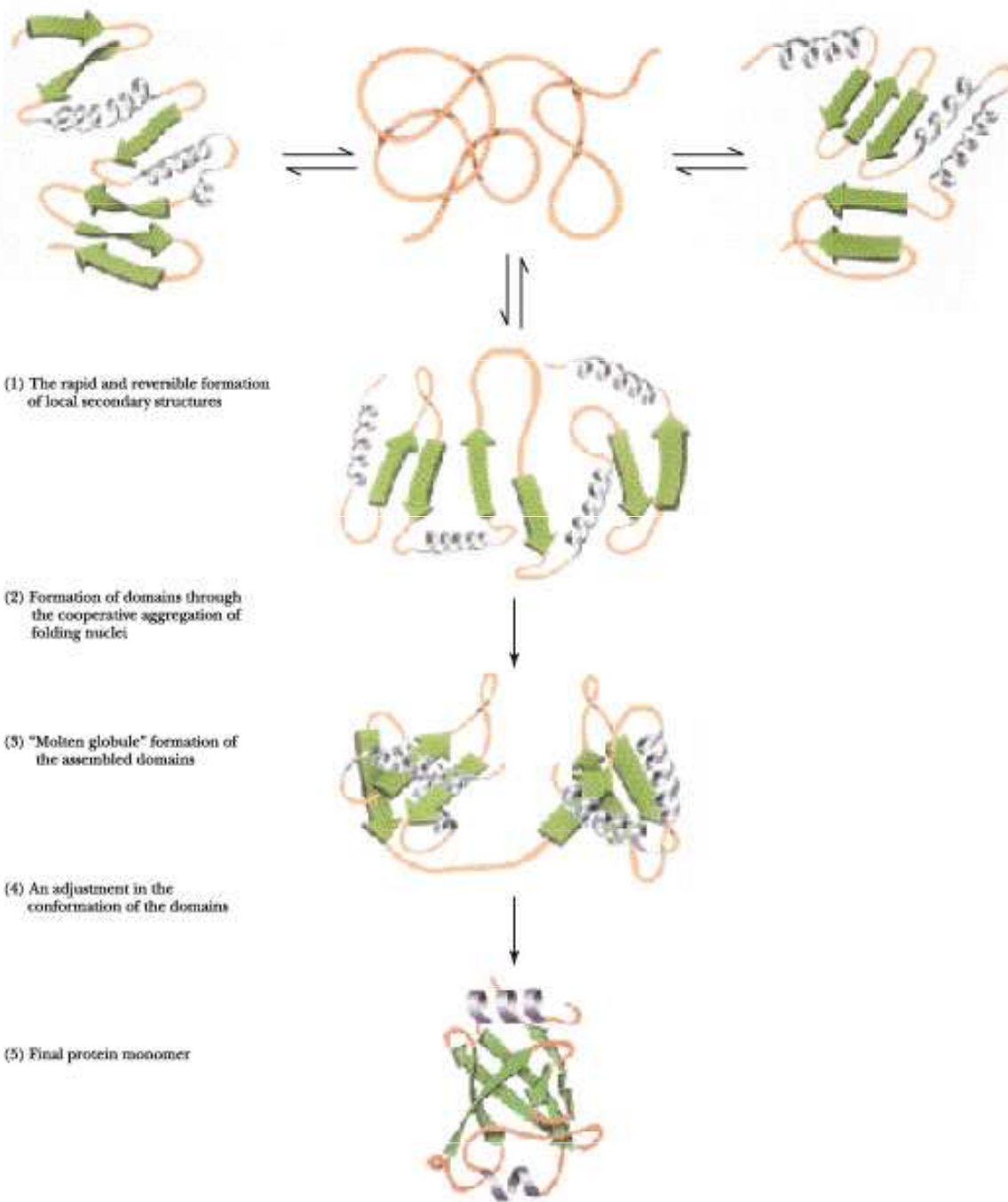

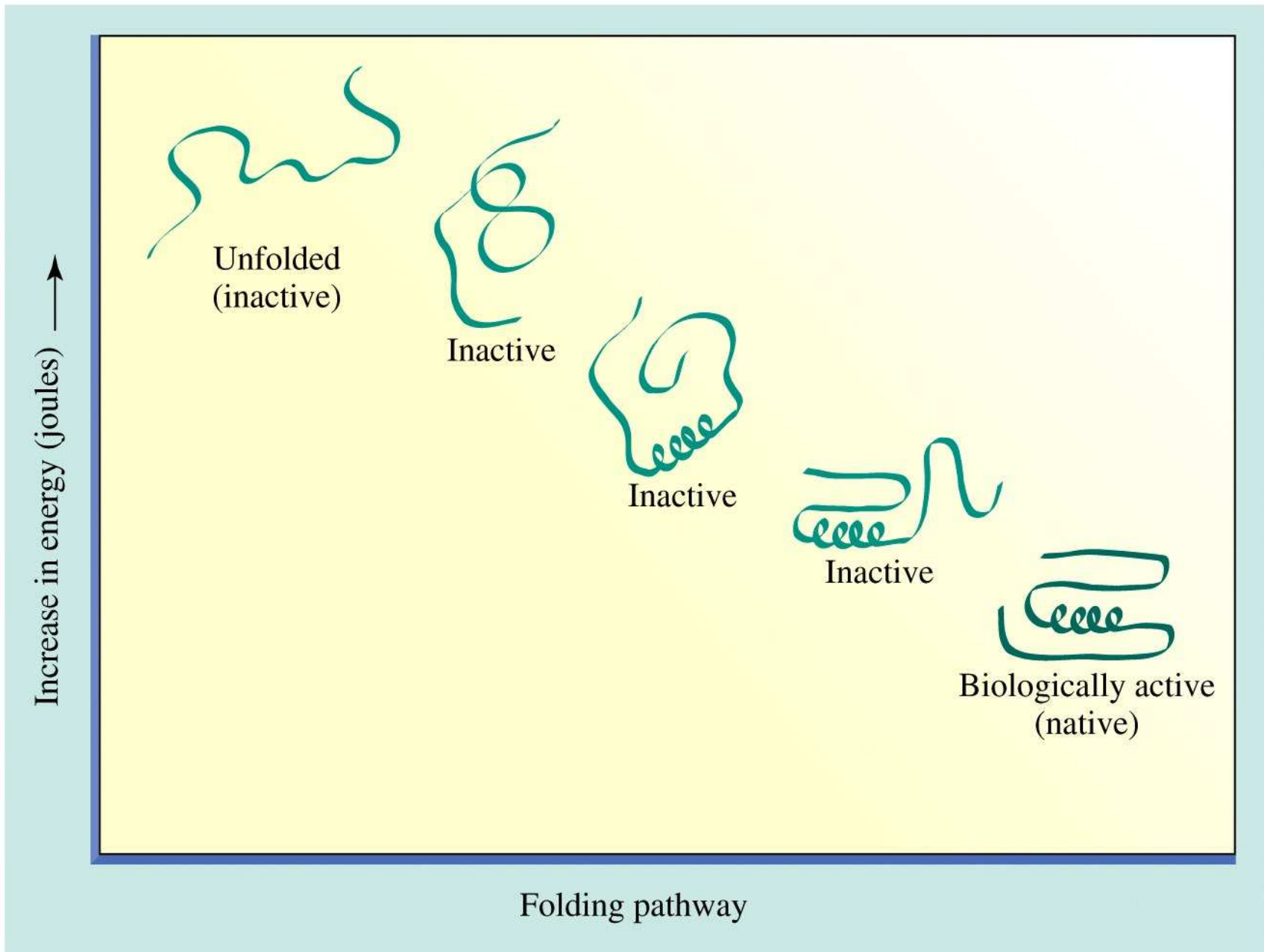
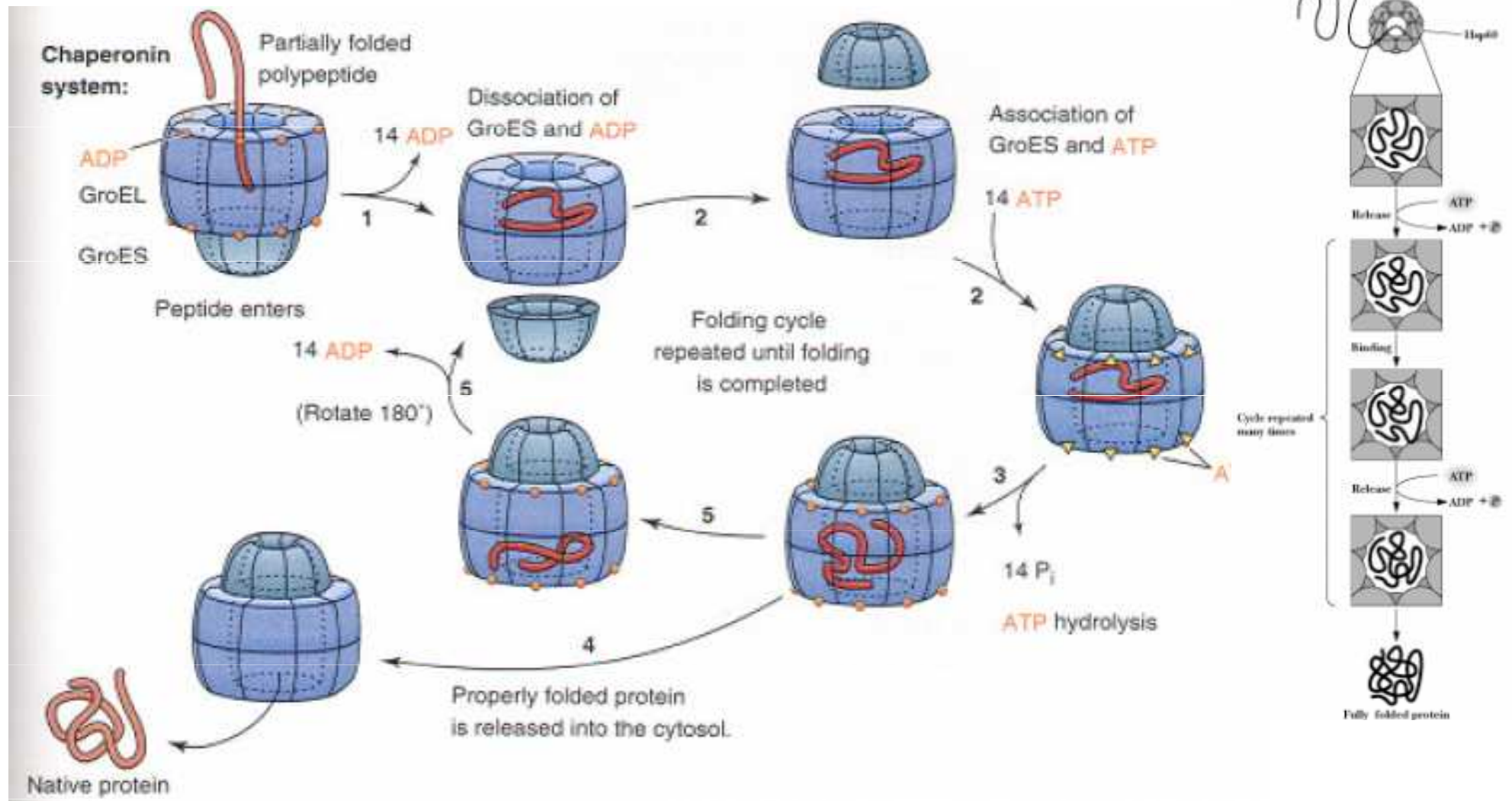

Figure 4-13 Concepts in Biochemistry, 3/e
© 2006 John Wiley & Sons

Chaperony

- Proteiny jsou skládány do aktivní formy molekulárními chaperony a chaperoniny
- Chaperony *E. coli* Hsp70, rozpoznává nesložené hydrofobní části peptidového řetězce
- Váže se na tyto části a ochraňuje je dokud nedojde ke správnému složení
- GroES-GroEL komplex – hlavní chaperonin u *E. coli* - GroEL 2 kruhy, každý 7 x 60 kDa podjednotek (Hsp60)
- Nesložený protein se váže dovnitř komplexu a jeho skládání je řízeno energií

Chaperony



ATPasa

Scrapie - BSE – CJD – Kuru

Priony

Stanley B. Prusiner
PT 1982 NC 1997

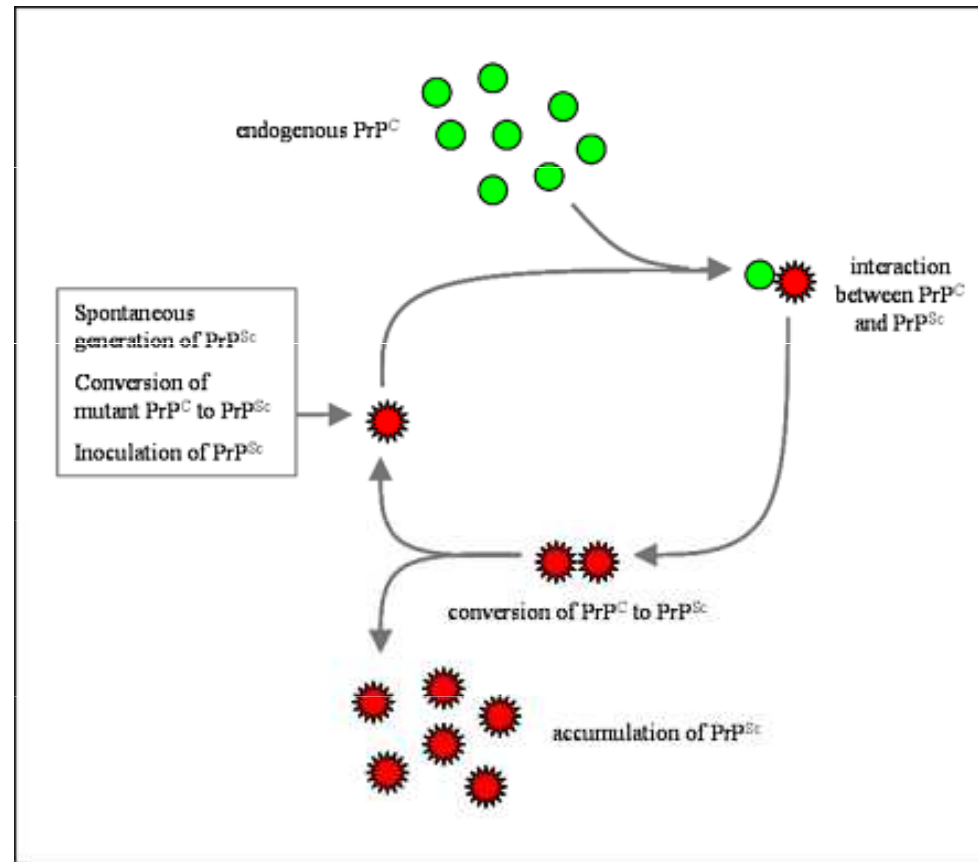
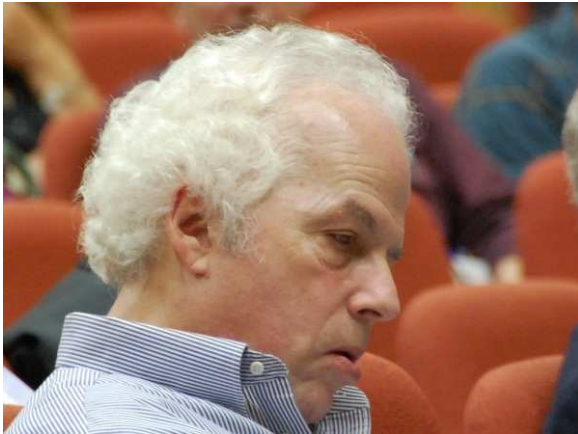

CJD

Brain shrinkage and deterioration occurs rapidly

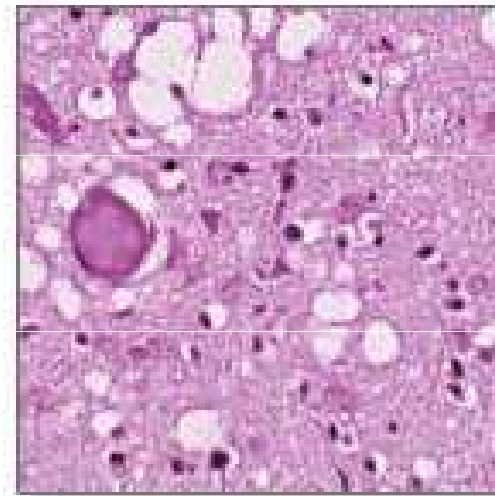

Brain section showing spongiform pathology characteristic of Creutzfeldt-Jakob

PrP^C - PrP^{Sc}

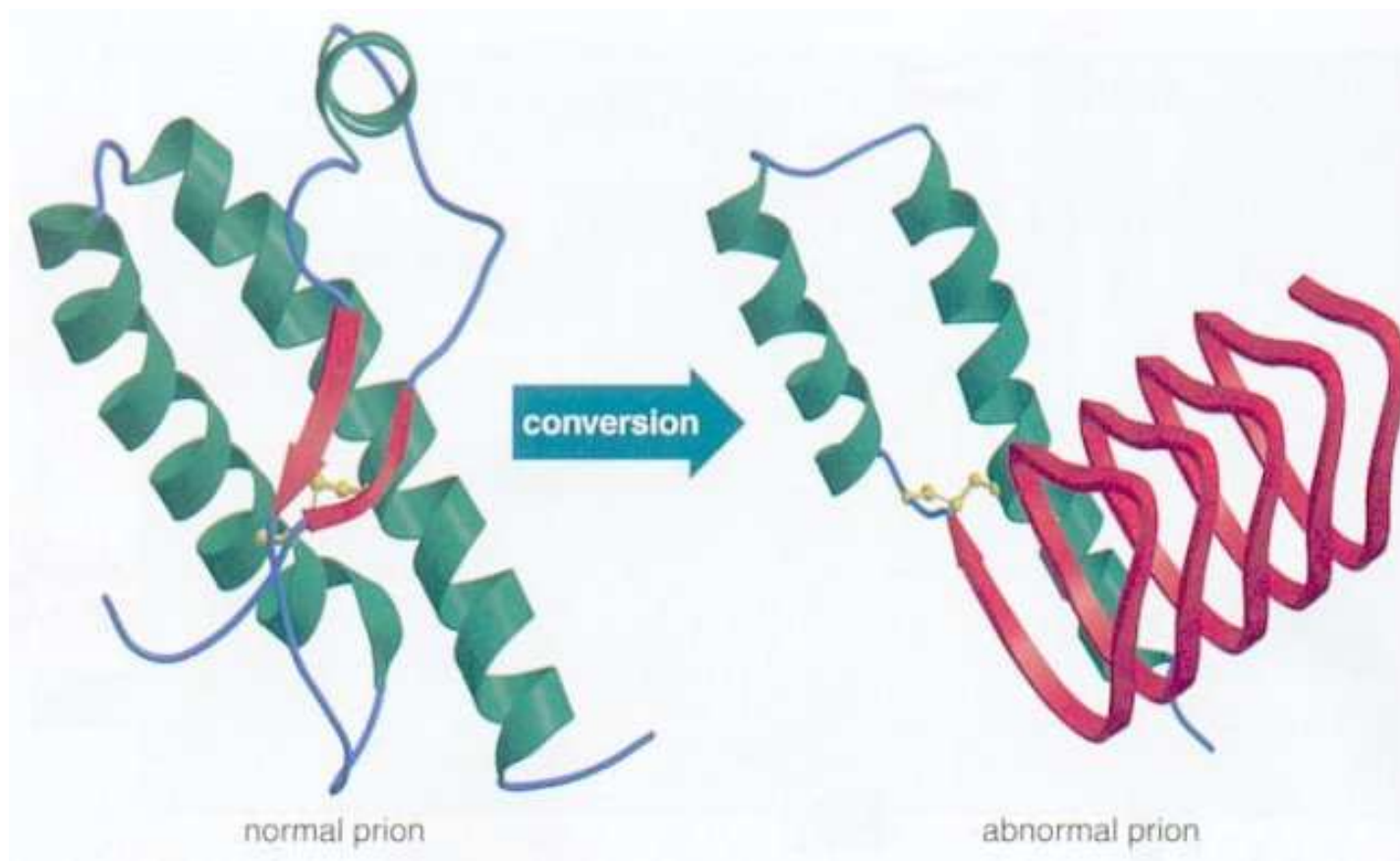

Odolný proteolýze

Alzheimer

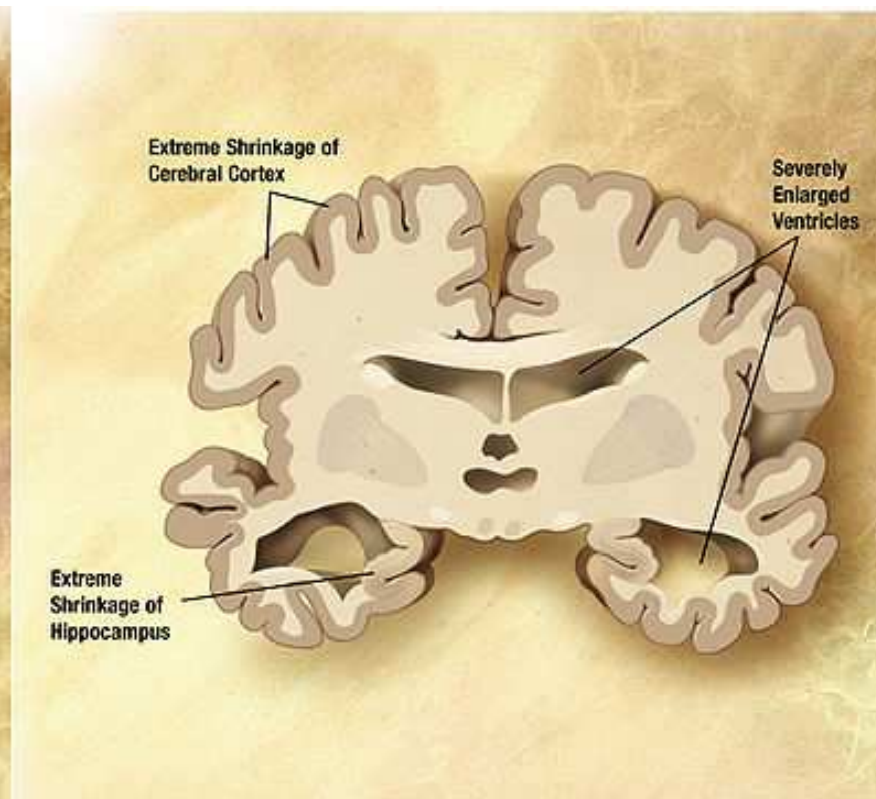
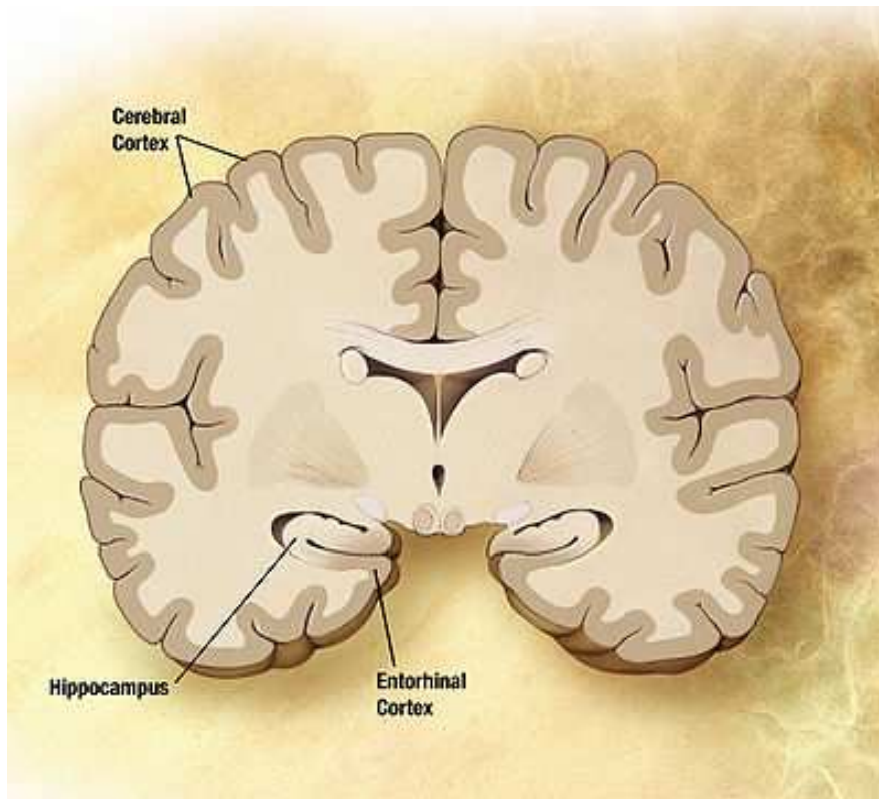

Alzheimer

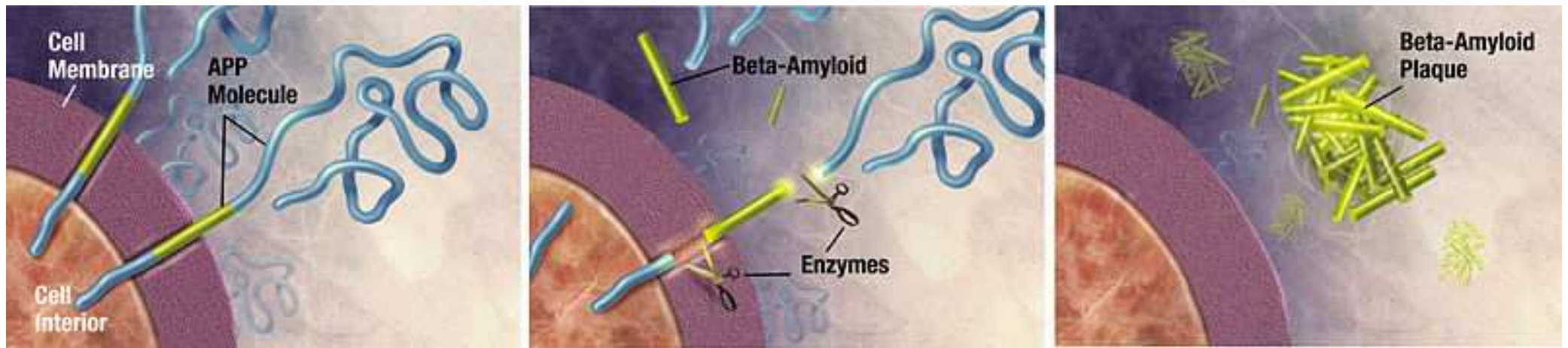

Alzheimer

Normální

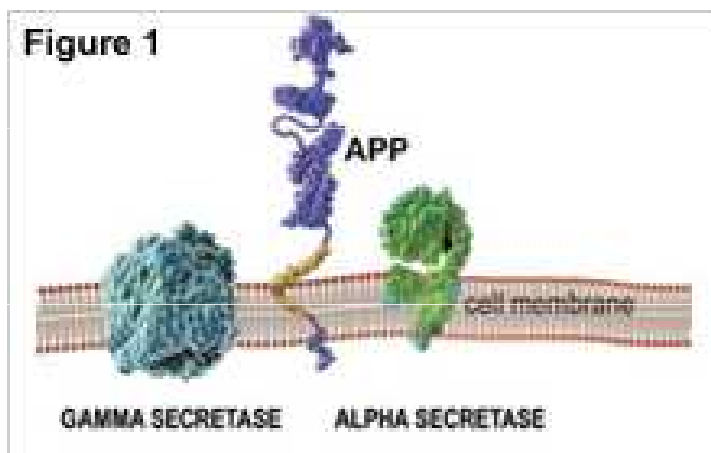
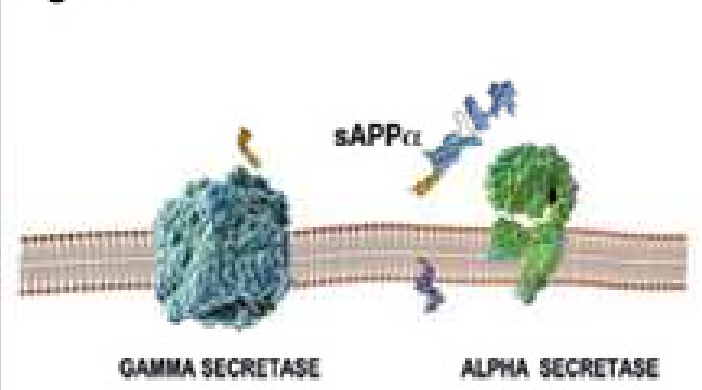

Figure 2



Patologický

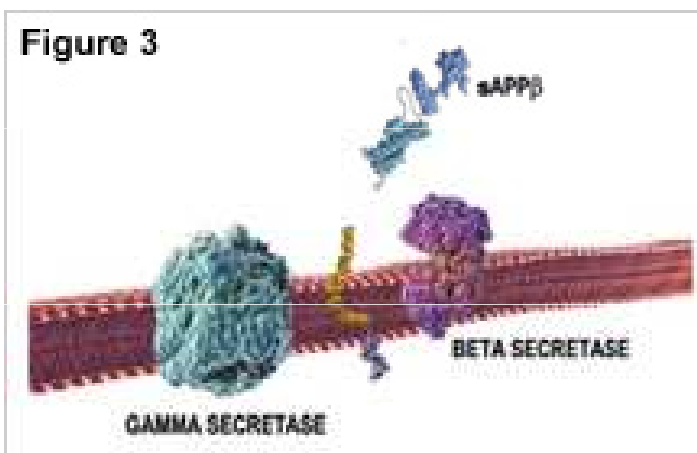
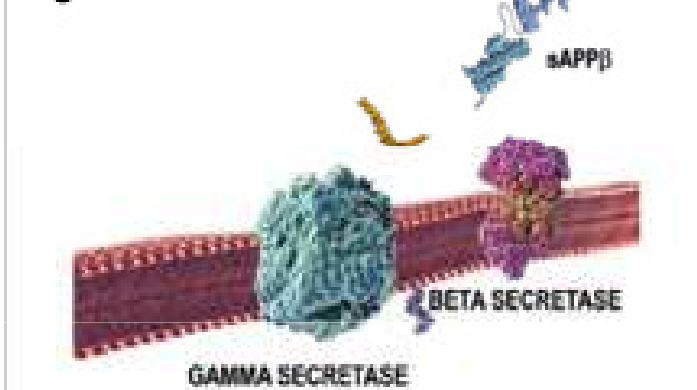
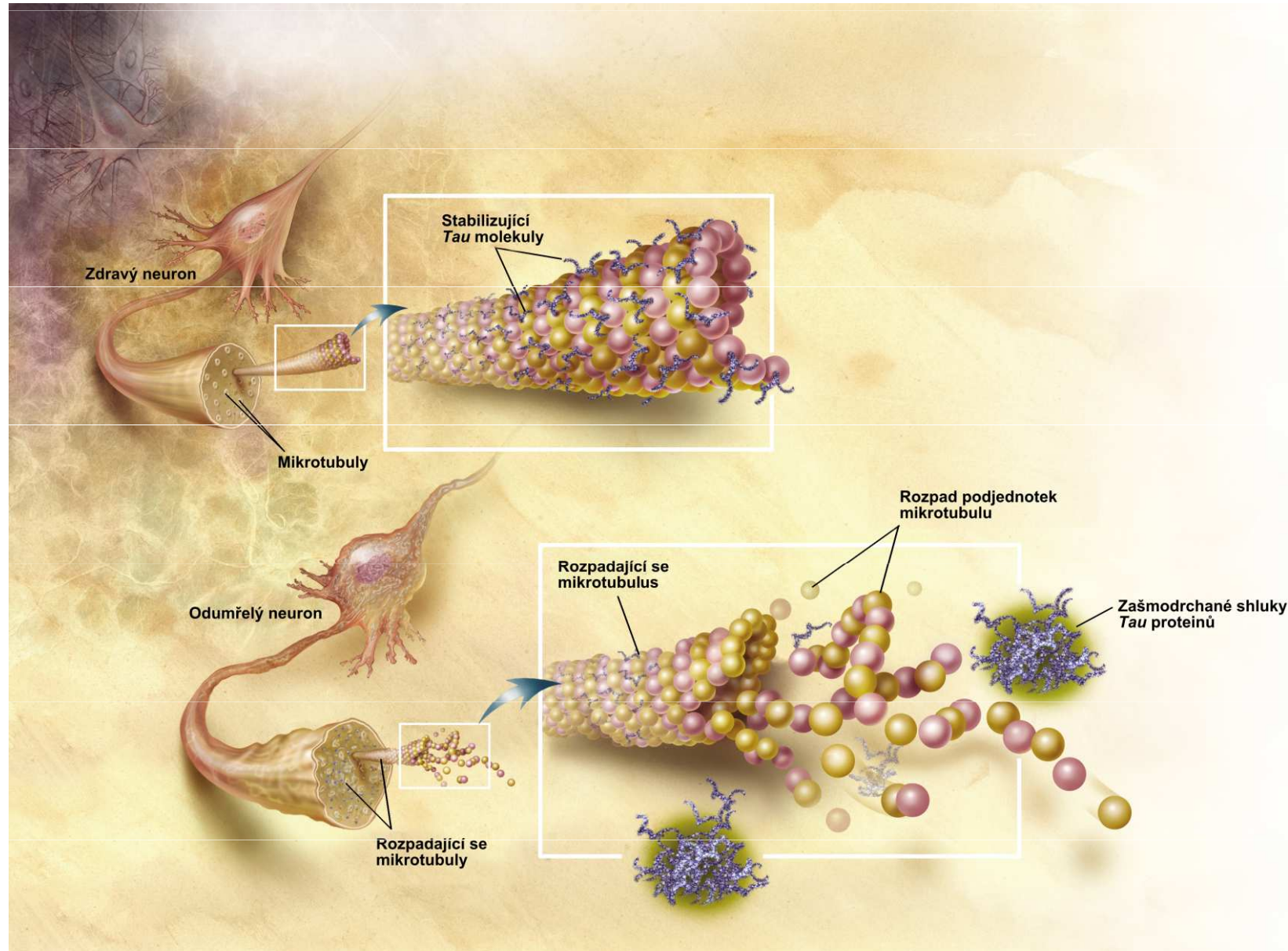

Figure 4



Alzheimer



Izolace bílkovin

1. Účel
 - výzkum - studium struktury, studium biologické aktivity
 - průmyslové použití - farmakologie, čisticí prostředky,

2. Volba vstupního materiálu

3. Extrakce

4. Purifikace

Srážecí metody - srážení neutrálními solemi $(\text{NH}_4)_2\text{SO}_4$

- srážení organickými rozpouštědly
- pH srážení

Chromatografie - ionexová

- hydrofobní
- gelová permeační
- afinitní

Elektromigrační metody - elektroforéza nativní nebo SDS

- izoelektrická fokusace

Izolace proteinů

Literatura

- *Scopes* : Protein Purification
- *Harris* : Protein Purification Methods – Practical Approach
- *Deutcher* : Guide to Protein Purification
- *Janson* : Protein Purification
- *Kastner* : Protein Liquid Chromatography

Literatura

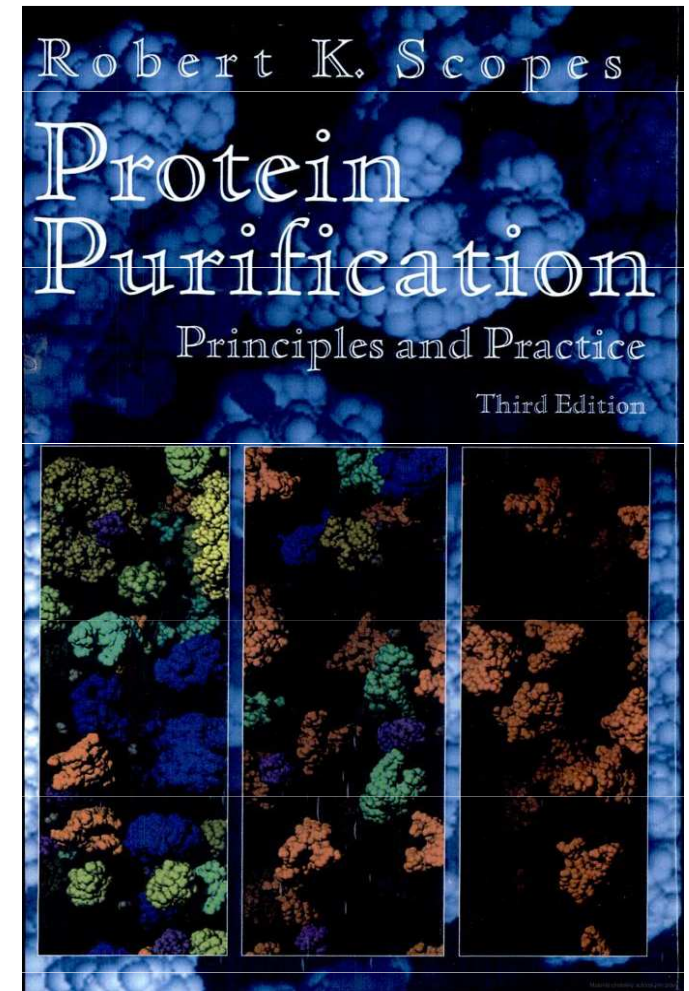
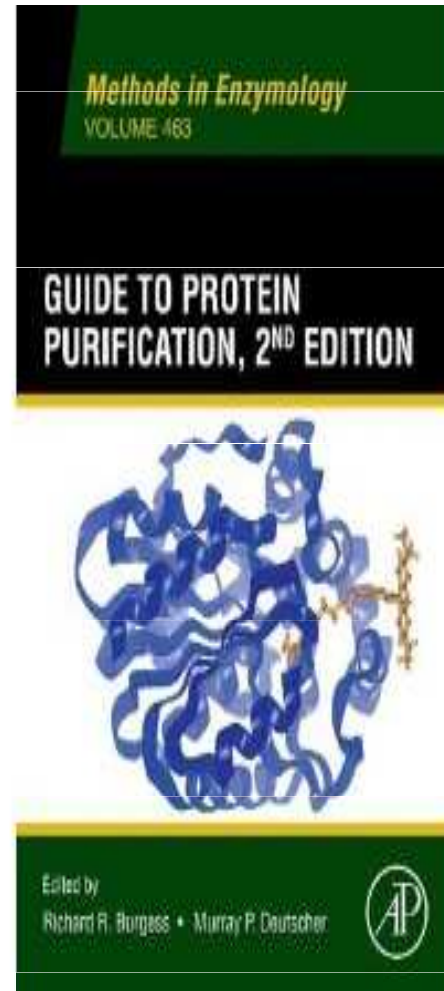
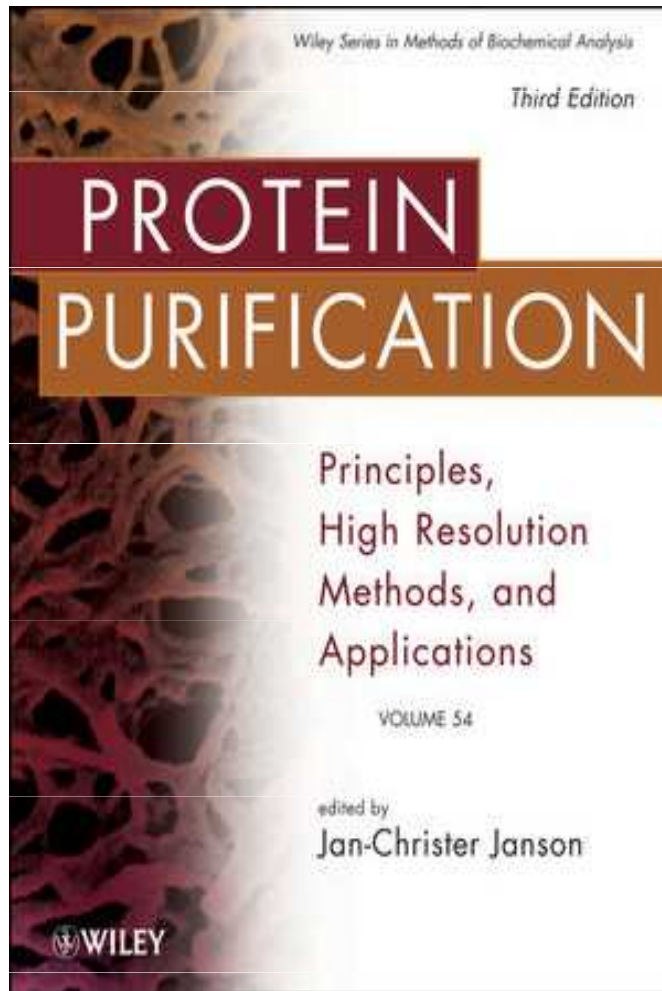

Metody separace proteinů

- Vychází z klasických metod chemické analýzy
- Uplatňují se zde i speciální metody

Problémy se vzorkem

- Komplexnost
- Malá množství
- Labilita

Plánování separace bílkovin

Cíl izolace

- Získání homogenní bílkoviny
- Zachování biologické aktivity
- Čistota

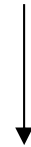

Závěr : získat vzorek o patřičné
čistotě s vynaložením
patřičného úsilí

Volba vstupního materiálu

- Preparát z daného organismu
- Preparát s největším obsahem dané bílkoviny
- Preparát s nejmenším obsahem nečistot

Sledování průběhu separace

Metoda	Celková bílkovina	Celková aktivita	Specifická aktivita	Přečištění	Výtěžek
extrakt	100	100	1	-	100 %
HIC	50	99	1.99	1.99	99 %
IEX	25	75	3	1.5	75 %

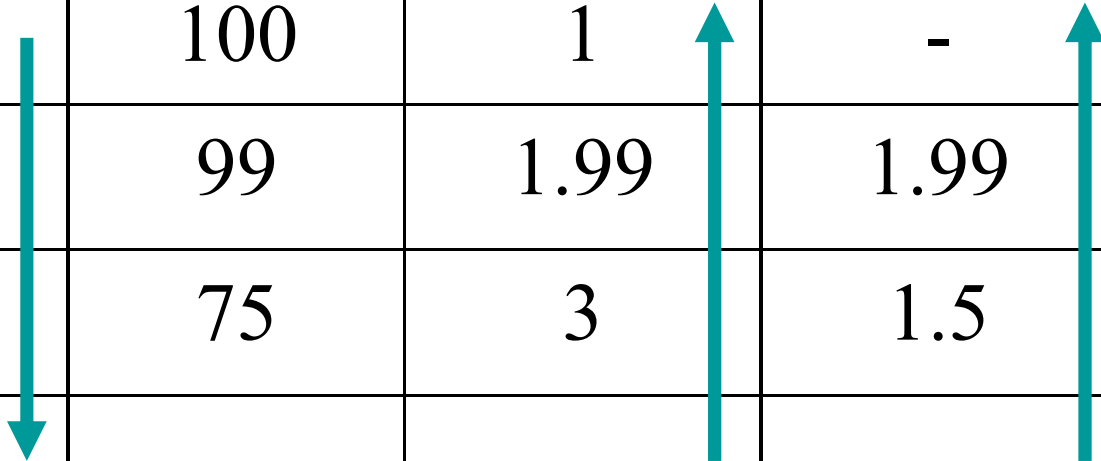

Stanovení koncentrace bílkoviny

Metoda založená

na stanovení
koncentrace dusíku

na základě
optických vlastností

na základě
elektrochemických vlastností

Kjeldahlova metoda – stanovení N_2

- Mineralizace vzorku – převedení organického N na NH_4^+
- Stanovení NH_4^+ - titrace, fotometrie, ionotvě selektivní elektrody

Kjeldahlova metoda – stanovení N_2

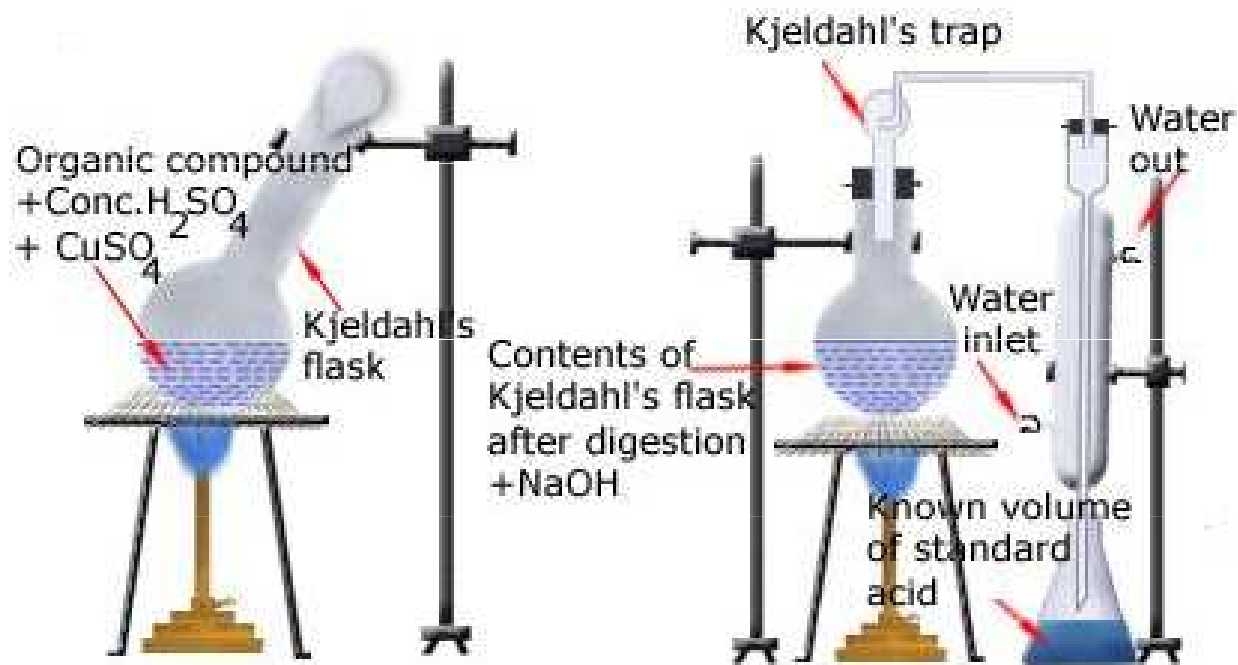

UV spektrofotometrie

- 280 nm – aromatické AMK
interference nukleotidů
- 180 - 230 nm – peptidická vazba

Výhody - nedestruktivní metoda
- není třeba kalibrace

UV spektrofotometrie

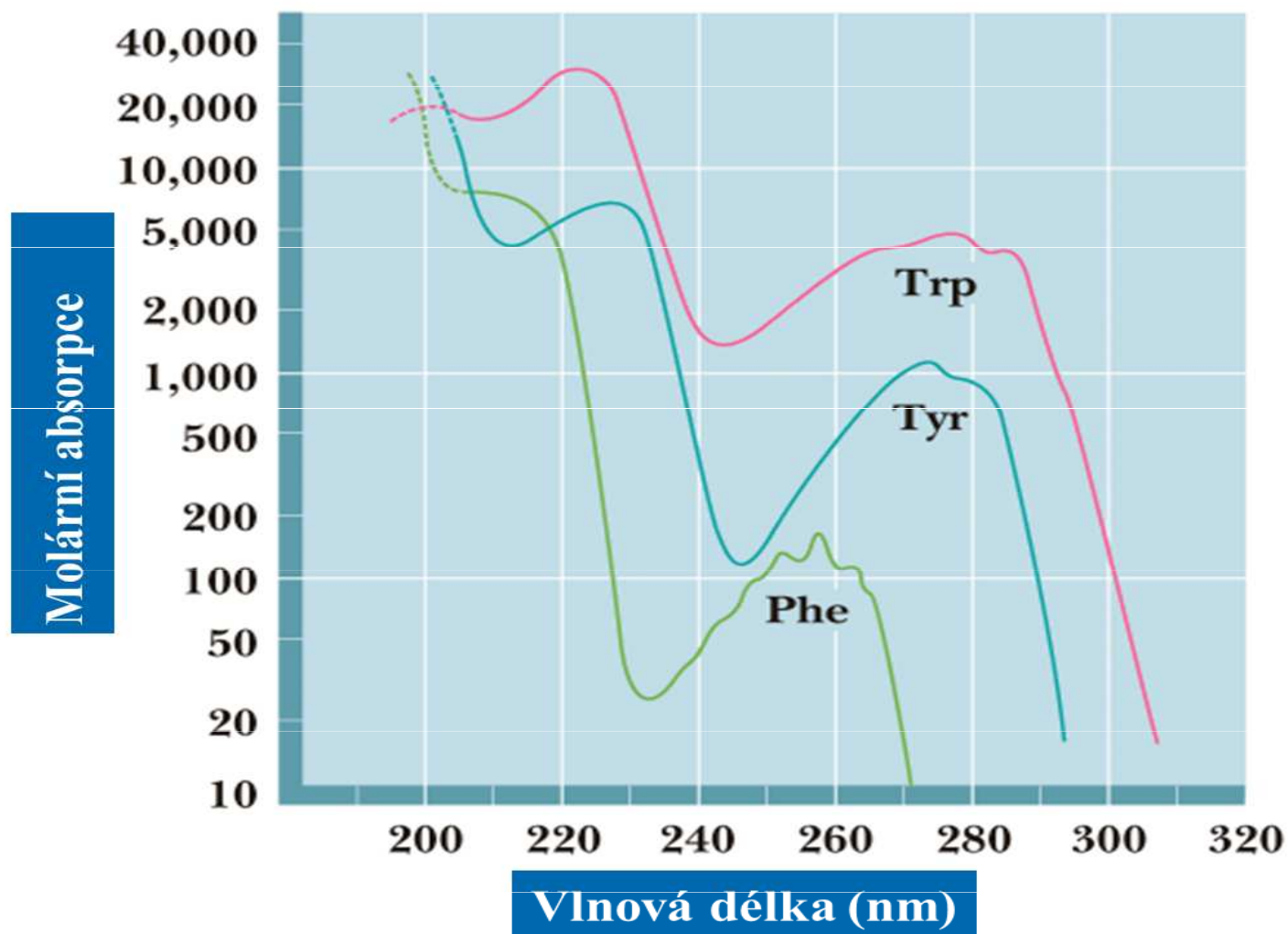

UV spektrofotometrie

Vzorce pro přímé UV stanovení:

$$c \text{ (mg/mL)} = 1.55 A_{280} - 0.76 A_{260}$$

$$c \text{ (mg/mL)} = (A_{235} - A_{280})/2.51$$

$$c \text{ (mg/mL)} = (A_{224} - A_{233})/5.01$$

$$c \text{ (mg/mL)} = A_{205} [27 + 120 (A_{280}/A_{205})]$$

UV spektrofotometrie

Edelchova metoda

při znalosti aminokyselinového složení je možné spočítat extinkční koeficient proteinu e_{280} . Podmínkou je přítomnost tryptofanu nebo tyrosinu v molekule.

$$e_{280} = n\text{Trp}.5500 + n\text{Tyr}.1490 + n\text{Cys}.125 \text{ (M}^{-1}\text{.cm}^{-1}\text{)}$$

VIS spektrofotometrie

- Přídavek činidla → barevný derivát
- Destruktivní metoda
- Nutná kalibrační závislost

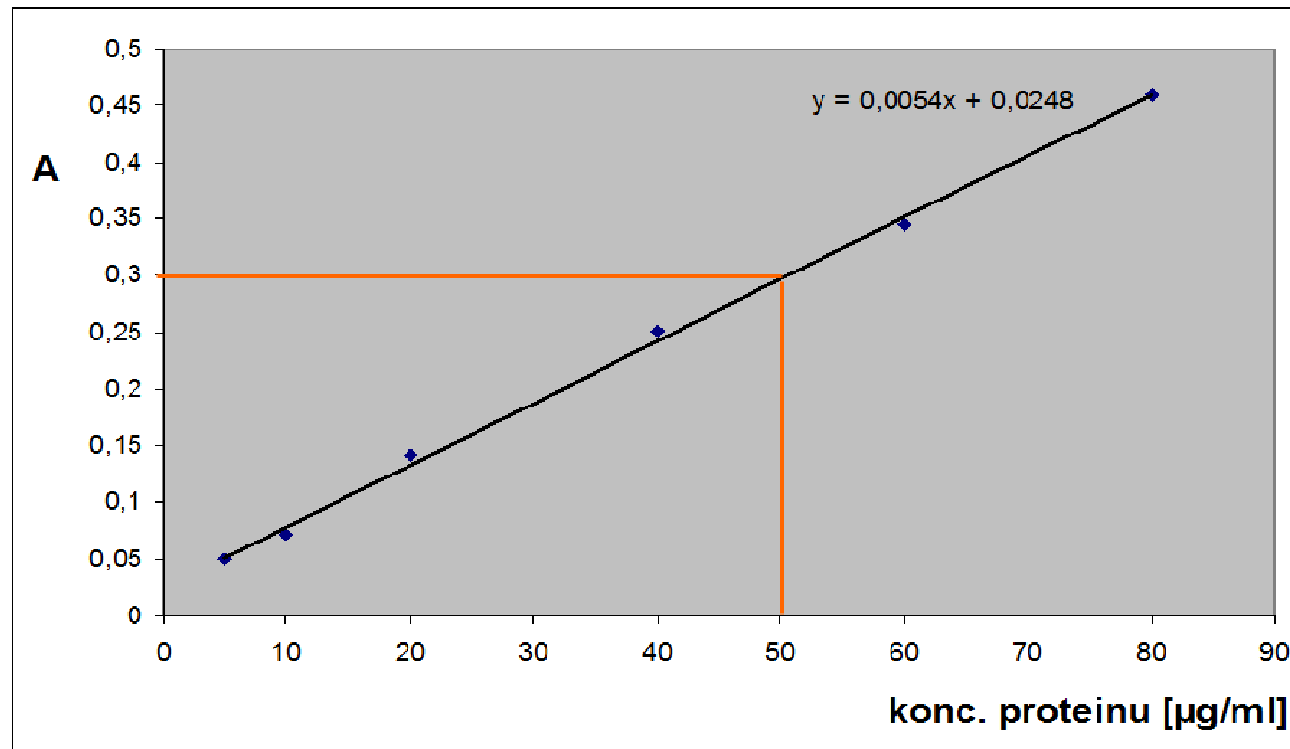

Biuretová metoda

Princip : Cu^{2+} vytváří v alkalickém prostředí komplex se 4 N peptidické vazby

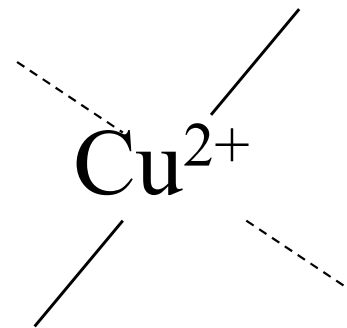

Měření : 540 – 560 nm
310 nm

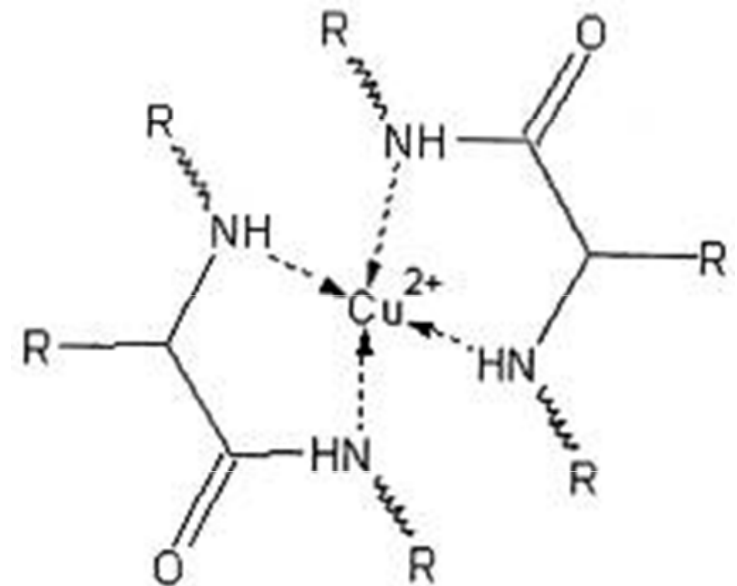

Folinova metoda

Princip : hydroxyfenolová skupina tyrosinu redukuje fosfomolybdenany (Folin Ciocalteovo reagens) na molybdenovou modř

Měření : 725 nm

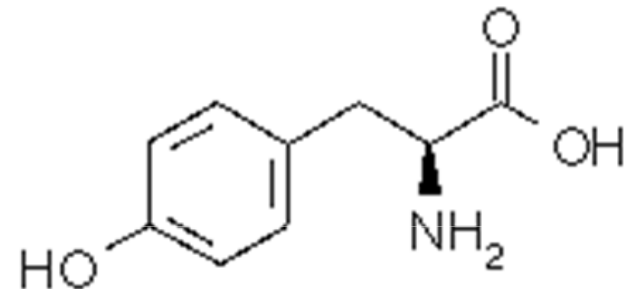

tyr y Tyrosin

Lowryho metoda

Princip : kombinace Folinovy a Biuretové metody

Měření : 600 nm

Lowryho metoda

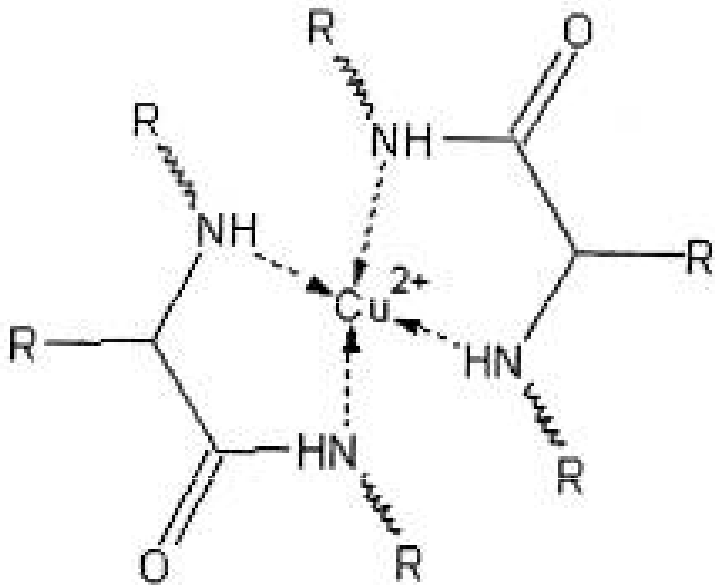

biuret ↑

Lowry ↓

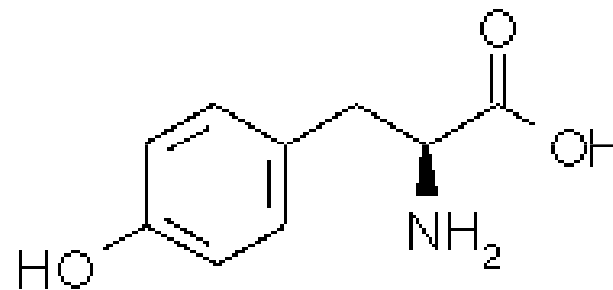
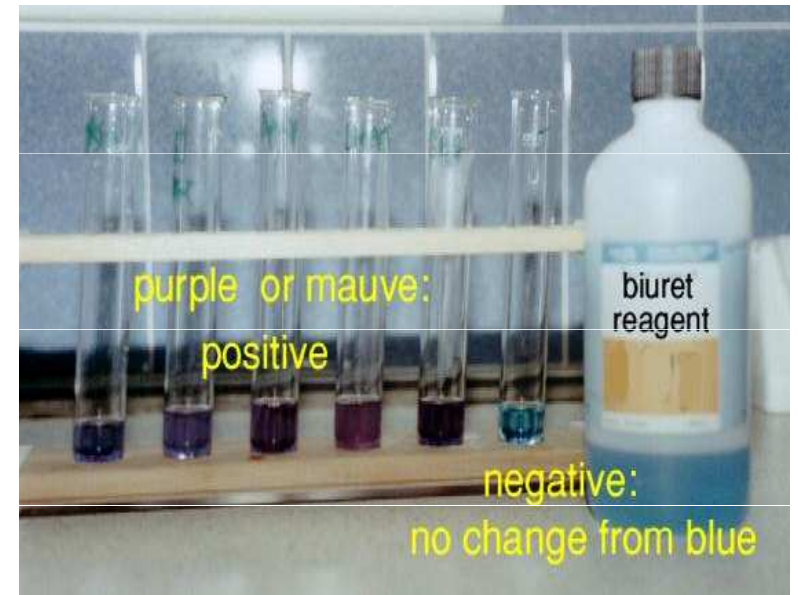

tyr y Tyrosin

Metoda dle Bradfordové

Princip : při vazbě Coomassie Brilliant Blue G 250 na bílkovinu dochází k posunu absorpčního maxima z 465 na 595 nm.

Meření : 595 nm

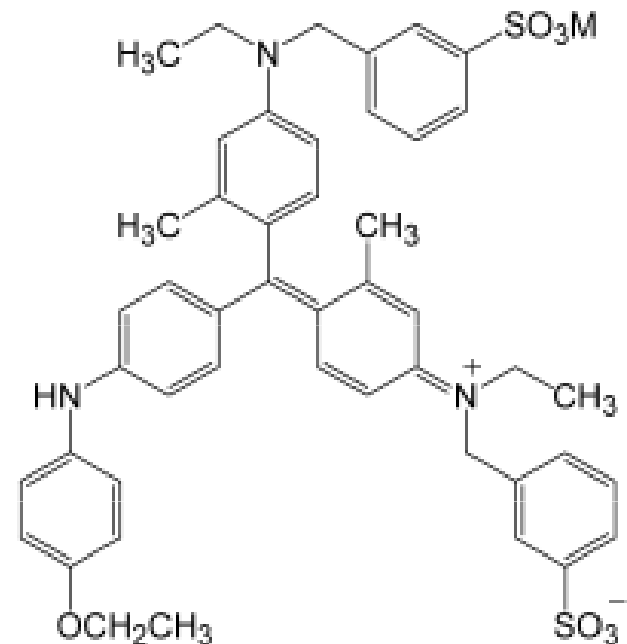

Metoda dle Bradfordové

PROTEIN
Basic and Aromatic
Side Chains

+

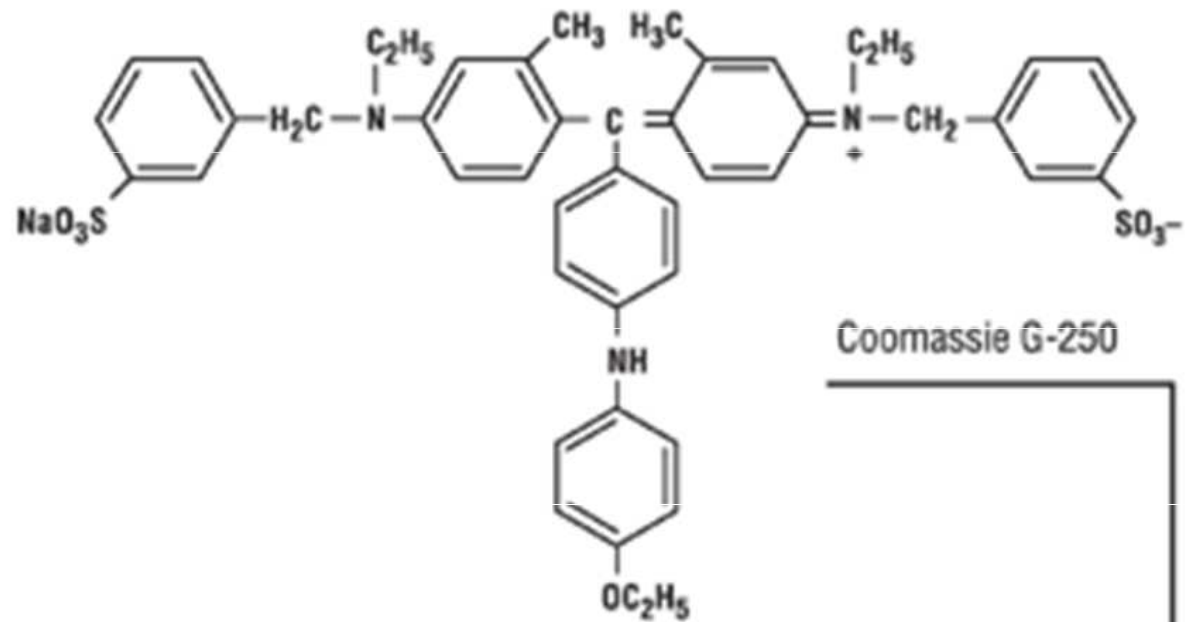

Coomassie G-250

465 nm



$A_{max} = 595 \text{ nm}$

Protein-Dye Complex

BCA metoda

Princip : Na^+ sůl k. bicinchoninové (BCA),
komplexuje Cu^+ tvořené reakcí peptidové
vazby s Cu^{2+}

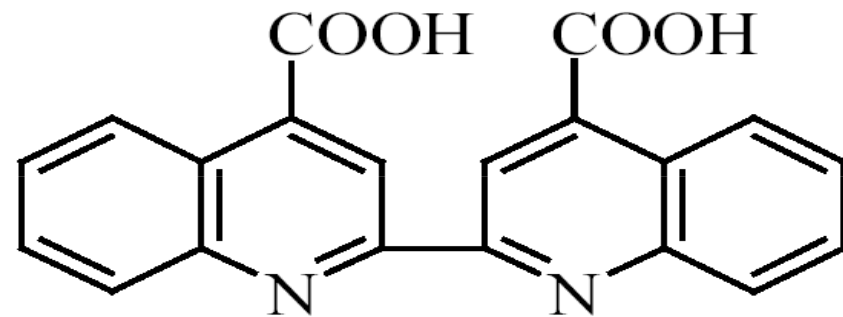

Měření : 562 nm

BCA metoda

STEP 1.

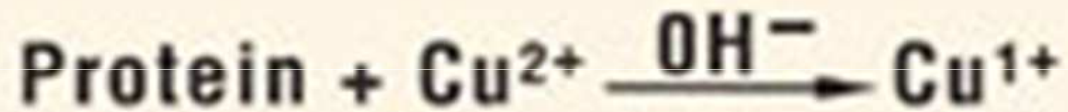

STEP 2.

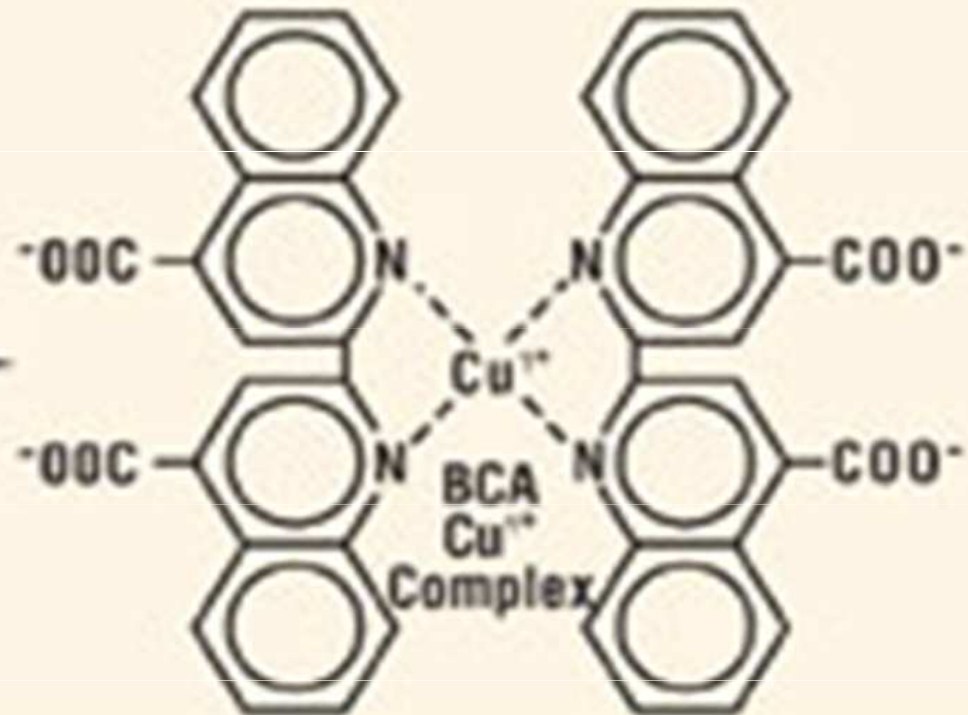
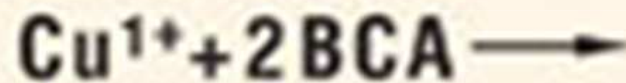

Fluorescence

Princip : - vazba fluoroforu na
bílkovinu → měření vzniklé
fluorescence (OPA)

Měření : exc.340 nm
em.440 nm

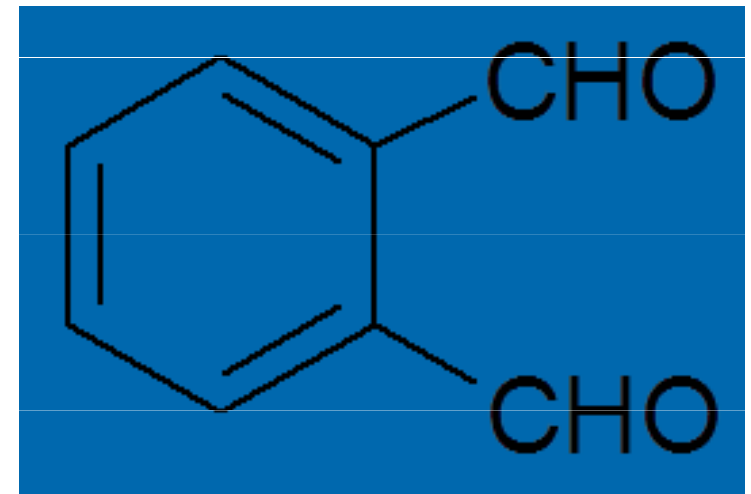

- zhášení fluorescence přidavkem
bílkoviny

Polarografie

Princip : Brdičkova reakce – SH skupiny bílkoviny vstupují v přítomnosti Co^{2+} katalytické reakce na Hg elektrodě \rightarrow proud

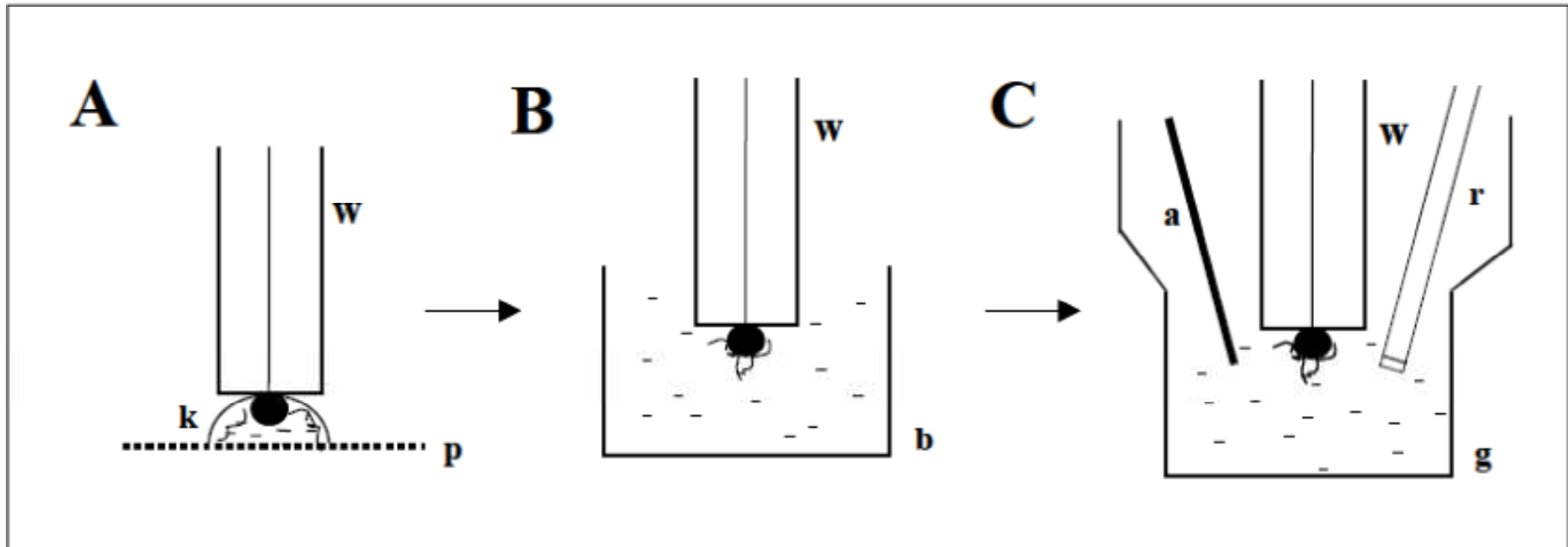

Nejčastěji používané metody

Metoda	Rozsah (ng)	Poznámka
Biuretová	0.5 - 5	okamžitý vývoj
Lowryho	0.05 - 0.5	pomalý vývoj
UV - 280 nm	0.05 - 2	interference
UV – 205 nm	0.01 - 0.05	interference
Bradfordové	0.01 - 0.05	sorpce barviva

Stanovení biologické aktivity

Enzymatické, imunologické, toxické,
hormonální receptorové atdf.

Vlastní separace

Obecné schéma

Získání vstupního materiálu

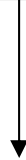

Rozrušení buněk

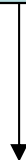

Separace

Vstupní materiál

Mikroorganismy

Bakterie, kvasinky, plísně, řasy

- Výhody - lze je snadno získat v dostatečné množství
- selekce mutantů o požadovaných vlastnostech
 - genetické inženýrství
 - termofilní organismy

Bezobratlí

Hmyz, plži, mlži

Nevýhody - málo se používá, nesnadno se získává

Živočišné tkáně

- Laboratorní zvířata – myši, krysy, králíci
- Jateční zvířata – orgány
- Člověk – tělní tekutiny

Rostlinné tkáně

Špenát, řepa, hrách

Nevýhoda – problematický růst za
definovaných podmínek

Rozbití a extrakce

Bakterie

- Záleží na lokalizaci
 - Extracelulární
 - Intracelulární
 - Cytoplasma
 - Periplazma

cytoplasma

periplasma

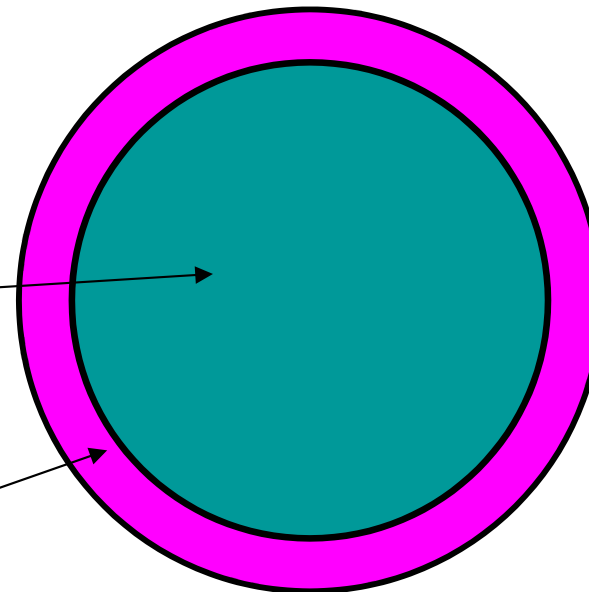

Balotina

Princip – jemné skleněné kuličky přidány do bakteriální suspenze a rychle třepány nebo míchány – nutno chladit

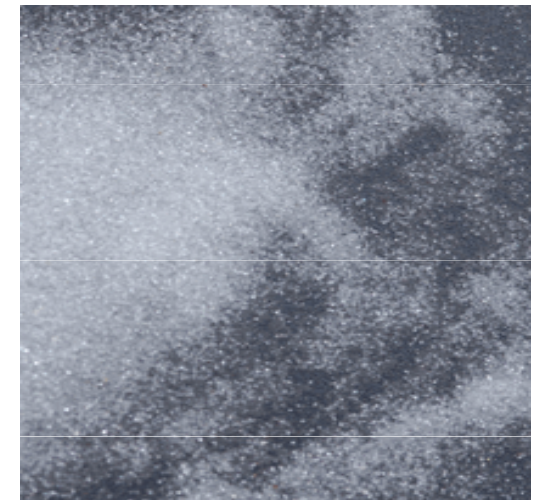

French (X) press

Princip – zmražená bakteriální suspenze
protlačována malým otvorem, přičemž
dochází k rekrystalizaci a rozrušení
buněk

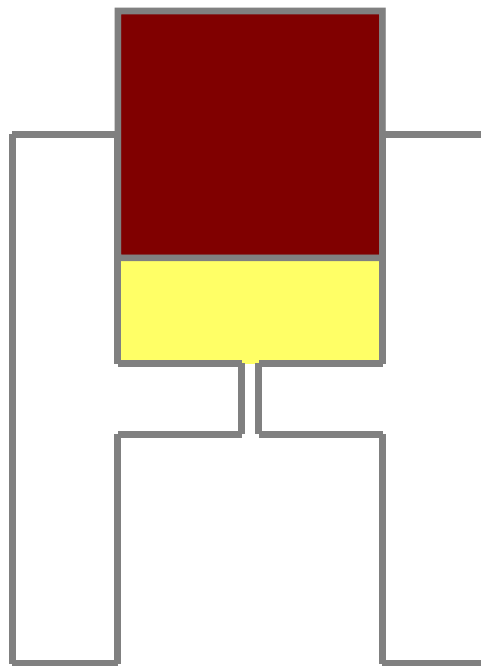

French (X) press

Pressure Cells



Mechanical Press



Ultrazvuk

Princip – ultrazvuk (> 20 kHz) v roztoku
vyvolává střižní síly – nutno chladit

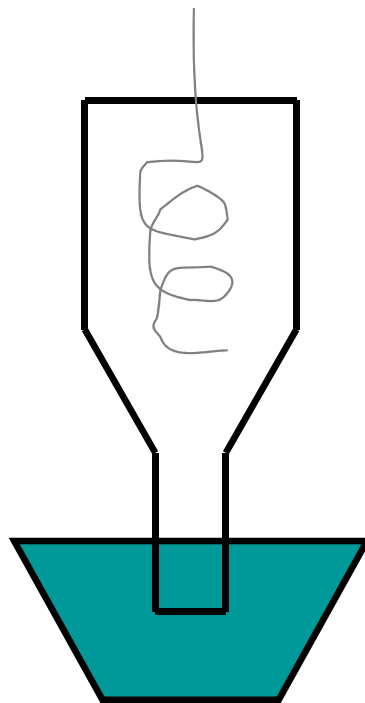

Lysozym + osmotický šok (mírný osmotický šok)

Princip – lysozym rozruší buněčnou stěnu,
následně je bakteriální suspenze zředěna
destilovanou H₂O – bakterie popraskají

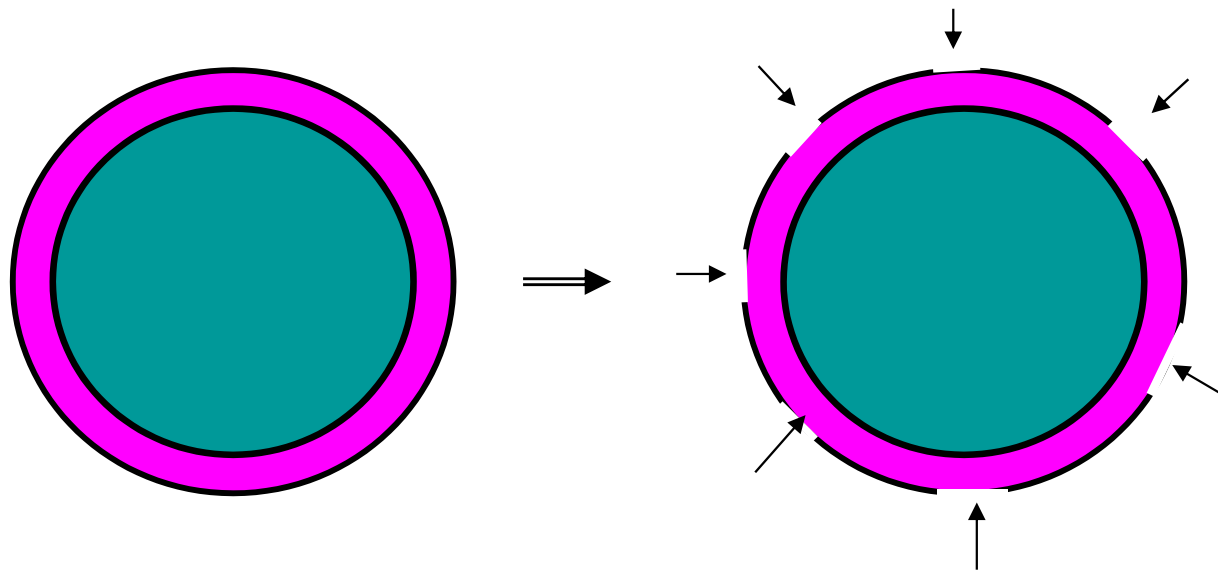

Další

- Alumina Al_2O_3 – roztírání v třecí misce
- Opakované zmrazování a rozmrazování

Kvasinky

Yeast Cell Wall

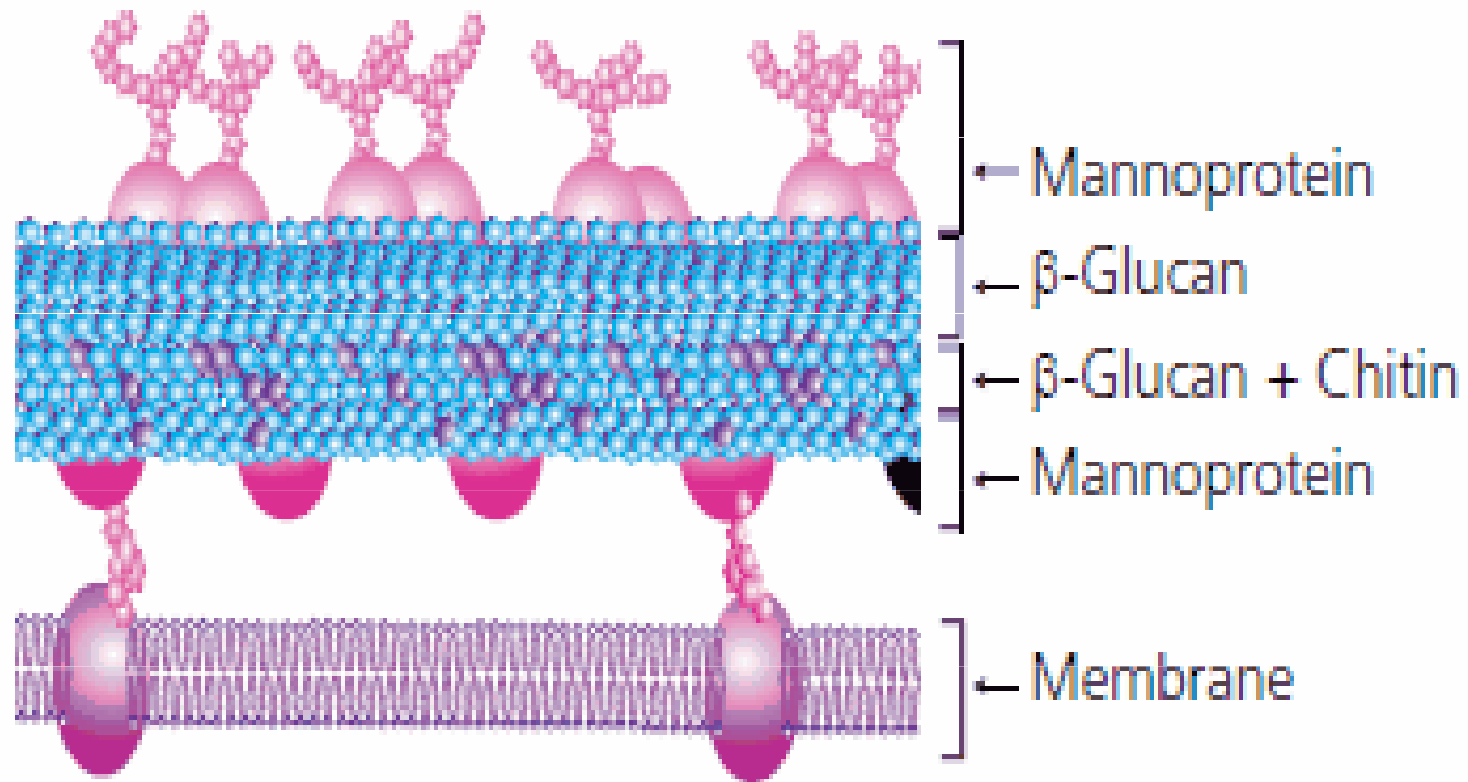

Kvasinky

Toluenová autolýza

Princip – toluen extrahuje při 35 –40 °C
fosfolipidy buněčné stěny →
osmotický šok → enzymová autolýza

Balotina, French press,

Živočišné tkáně

- Bez buněčné stěny
- Velmi křehké
- Tkáňové kultury

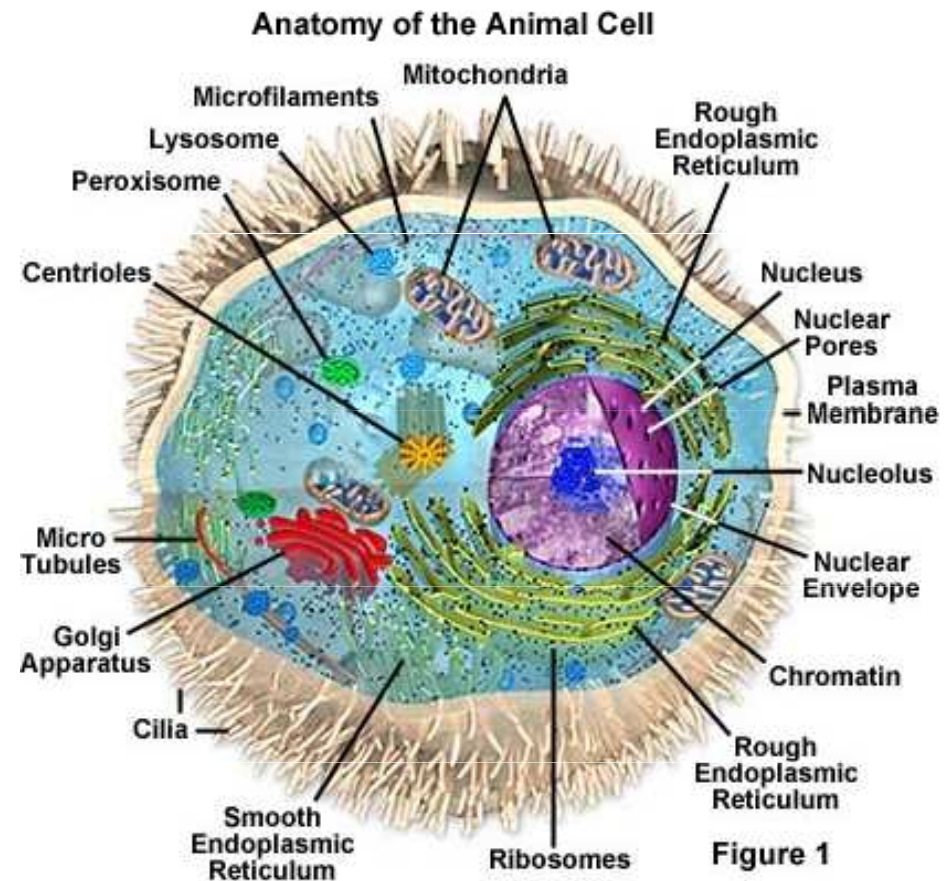

Živočišné tkáně

- Třecí miska s pískem



- Ruční homogenizatory – Potter –
Elvehjemův

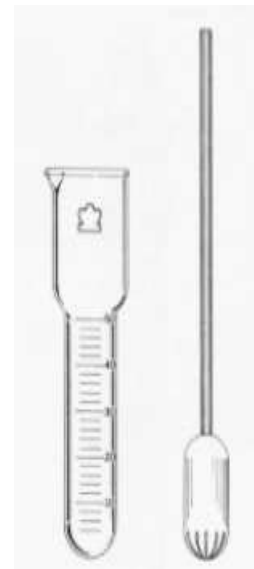

Živočišné tkáně

- Mixery



- Osmotická lyse - erythrocyty

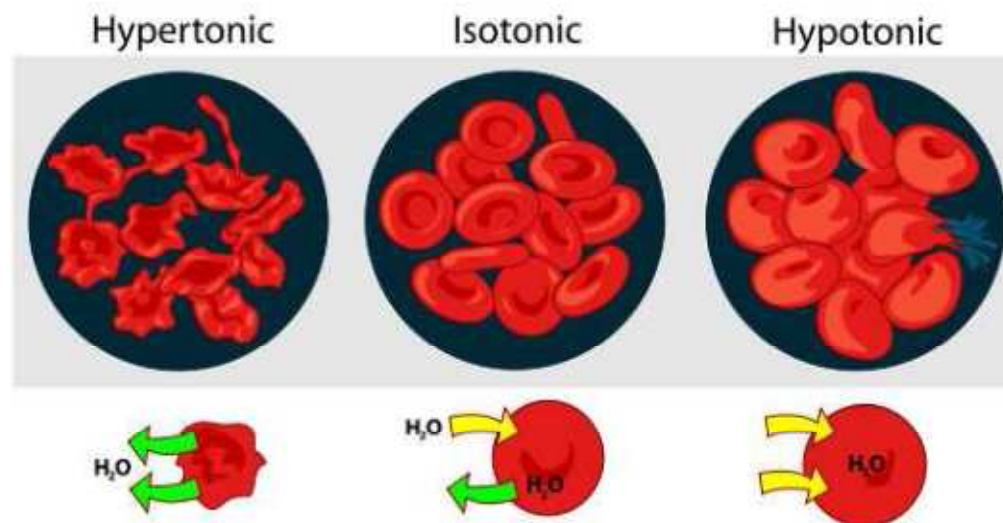

Rostlinné tkáně

- Silná buněčná stěna - celuloza
- Tkáňové kultury křehké

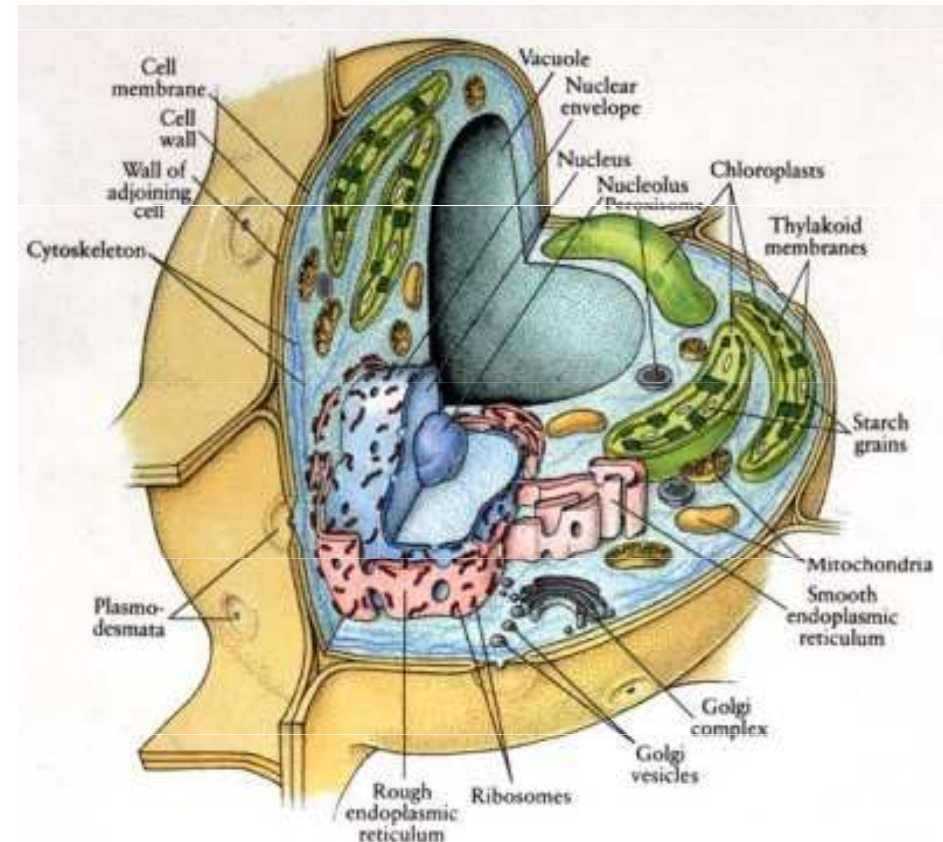

Rostlinné tkáně

- Rozrušení buněčné stěny pomocí celulas,
- Obsahují hodně fenolických látek, které mohou být oxidovány na chinony – melaniny, které mohou modifikovat bílkoviny

Optimalizace extrakce

- Teplota – 4 - 6 °C chlazení
- pH – optimální pro danou bílkovinu – práce v pufrech
- I – v prostředí o definované iontové síle
- Přídavky látek – EDTA, β -merkaptoethanol, kovové ionty, inhibitory proteas

Srážecí metody

Srážení

- Nezaměňovat s denaturací – bílkoviny zůstávají v nativním stavu
- První metody používané pro separaci bílkovin – EtOH, $(\text{NH}_4)_2\text{SO}_4$
- Filtrace nahrazena centrifugací

Rozpustnost bílkoviny

- Vlastnostmi bílkoviny – distribuce hydrofobních a hydrofilních skupin na povrchu bílkoviny

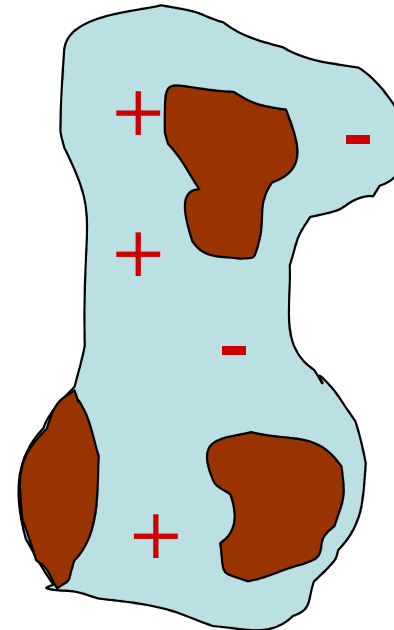
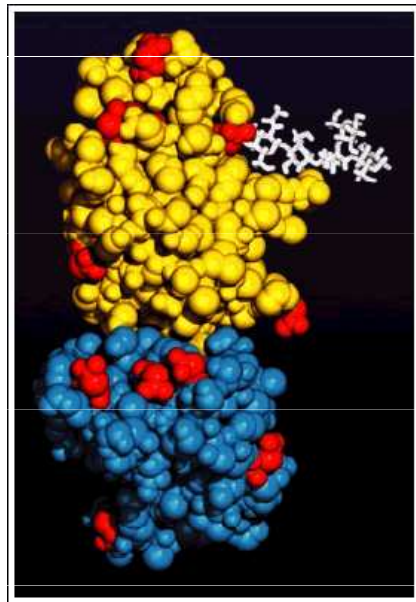

Rozpustnost bílkoviny

- Vlastnostmi roztoku – pH, iontová síla, org. rozpouštědla, org. polymery, teplota

Titrační křivka

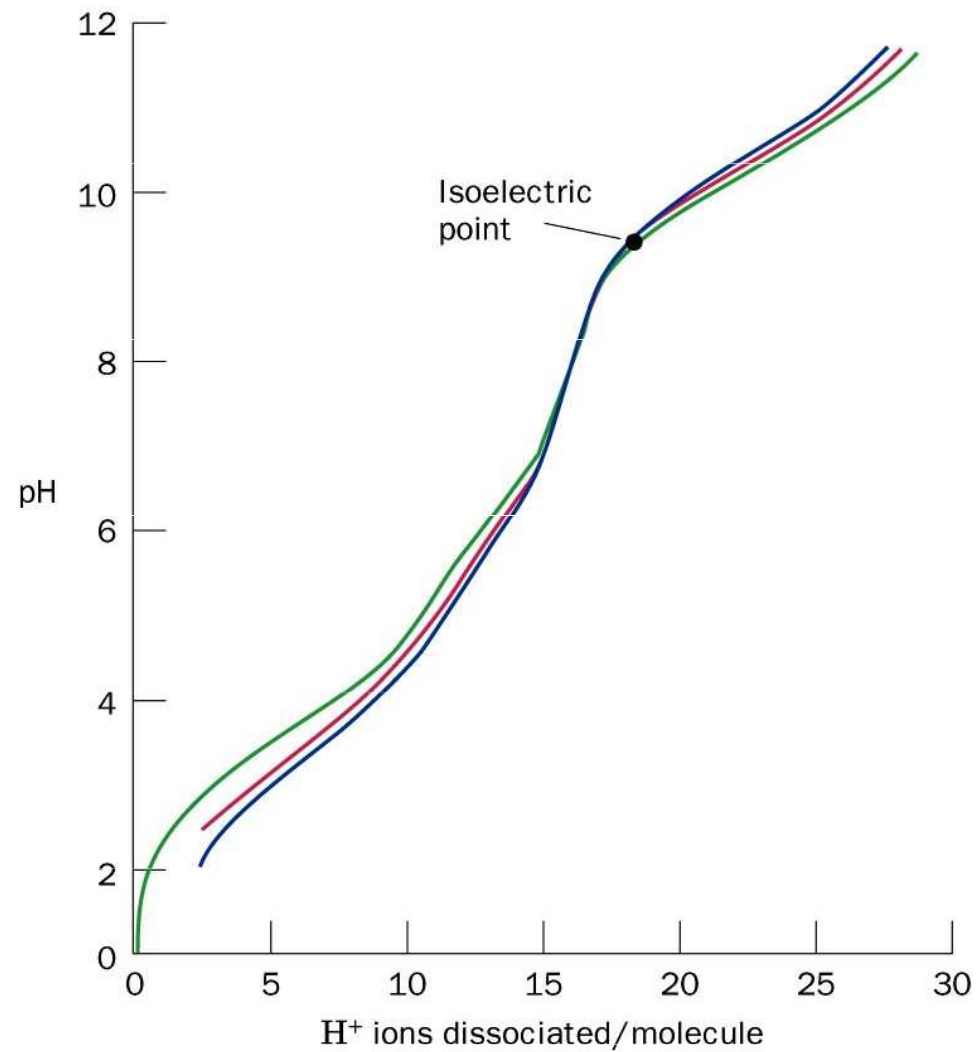

Izoelektrická precipitace

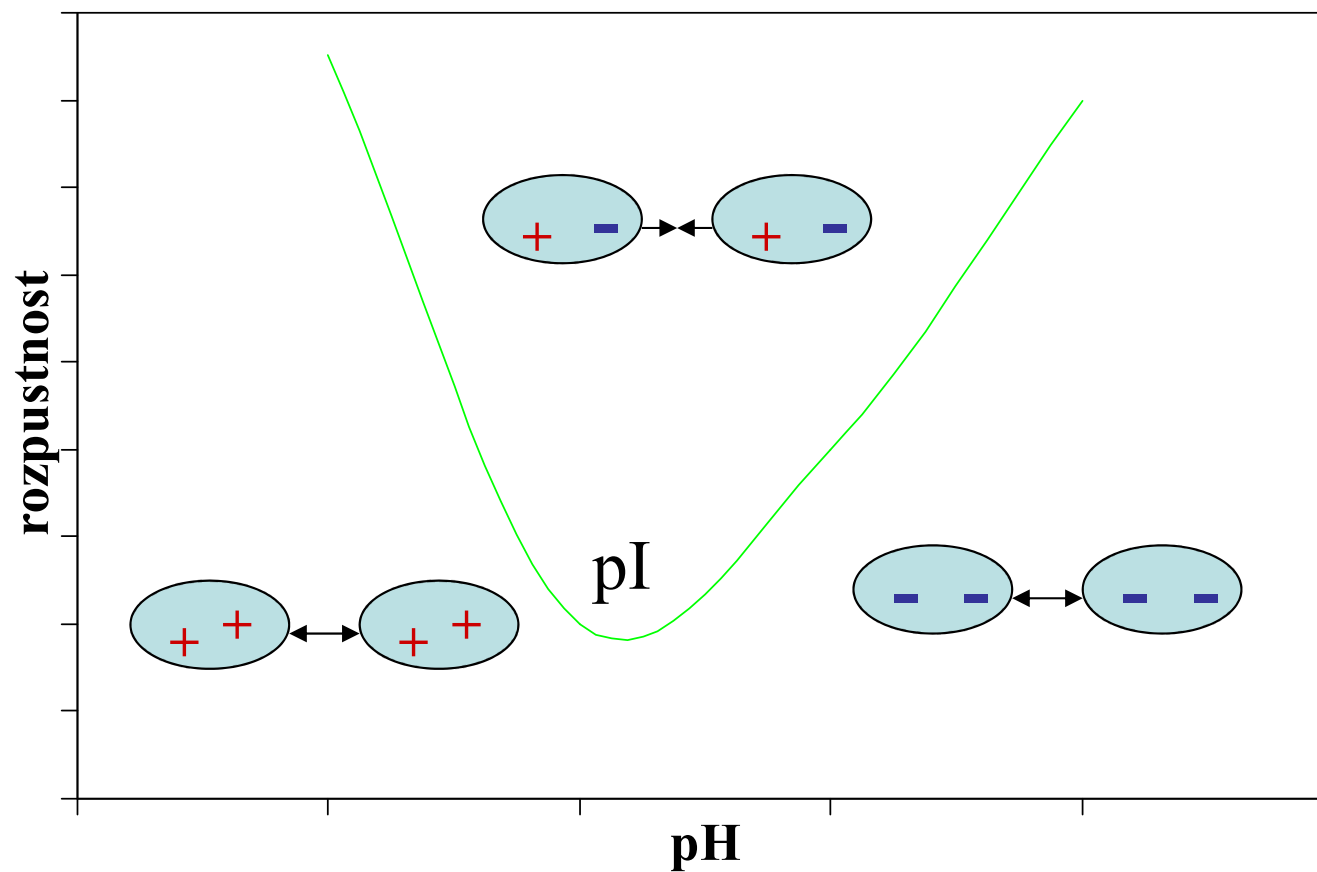

Srážení neutrálními solemi

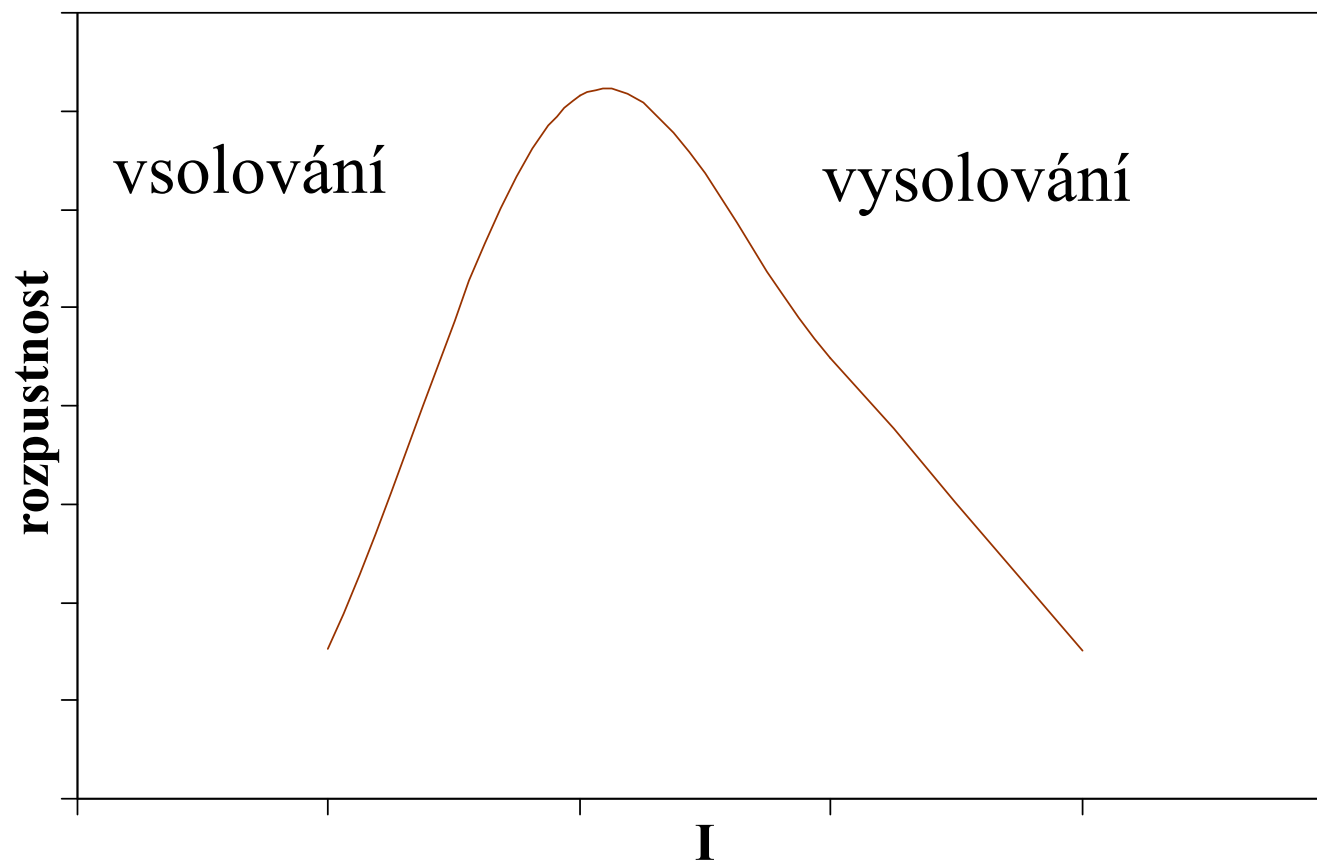

Vsolování

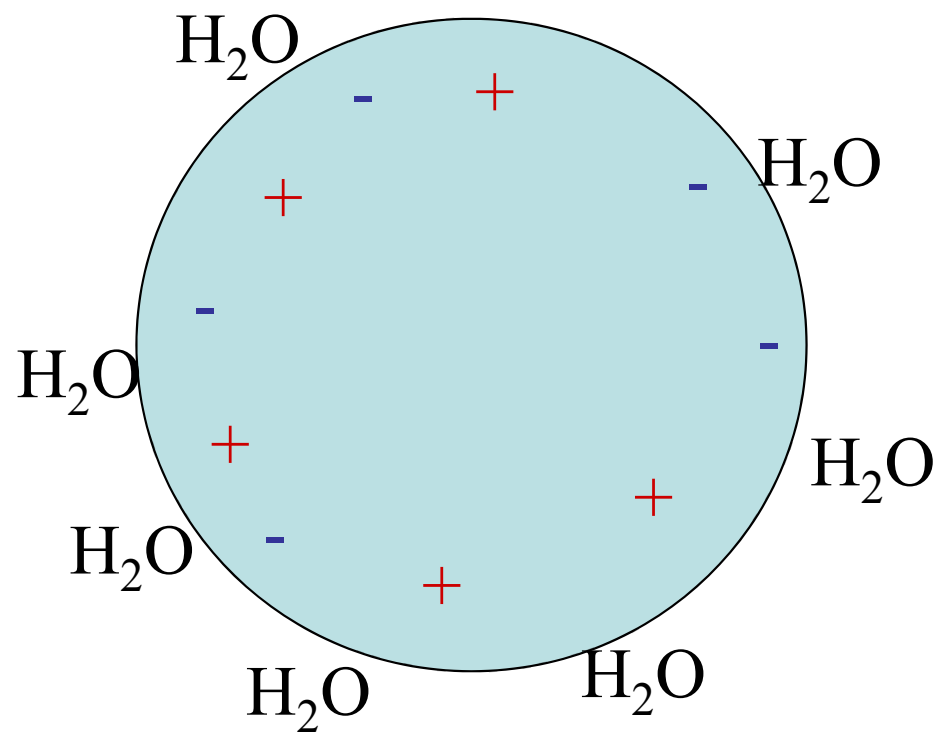

Vsolování

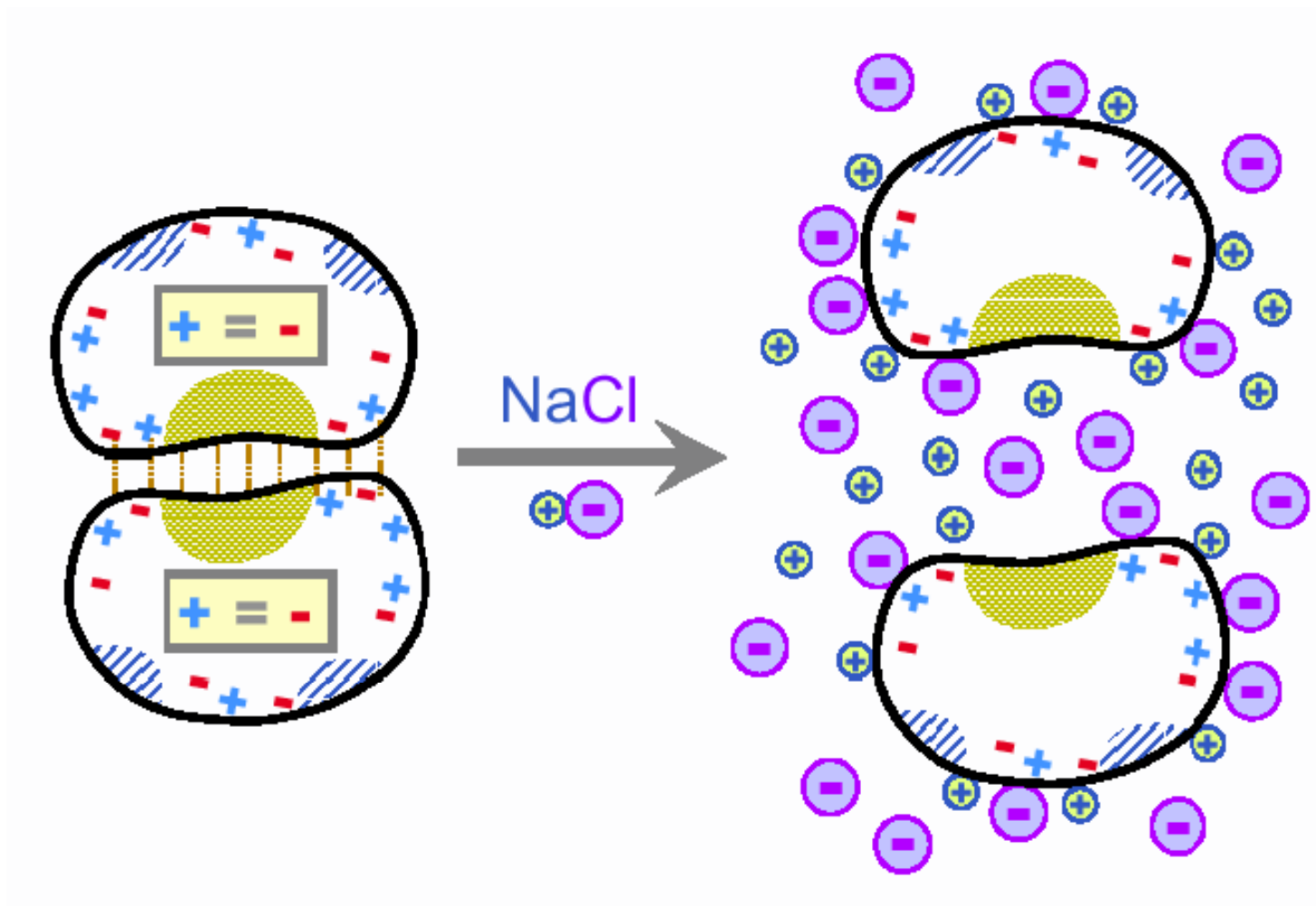

Vysolování

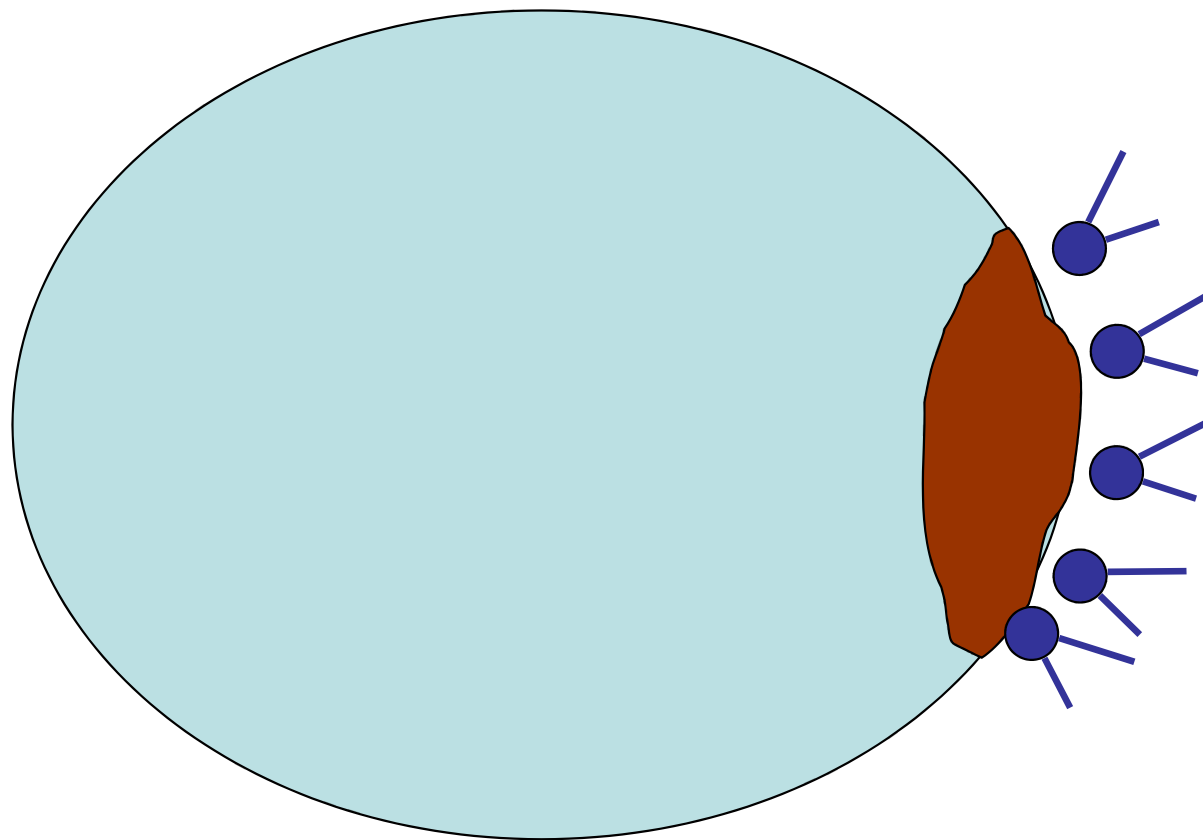

Vysolování

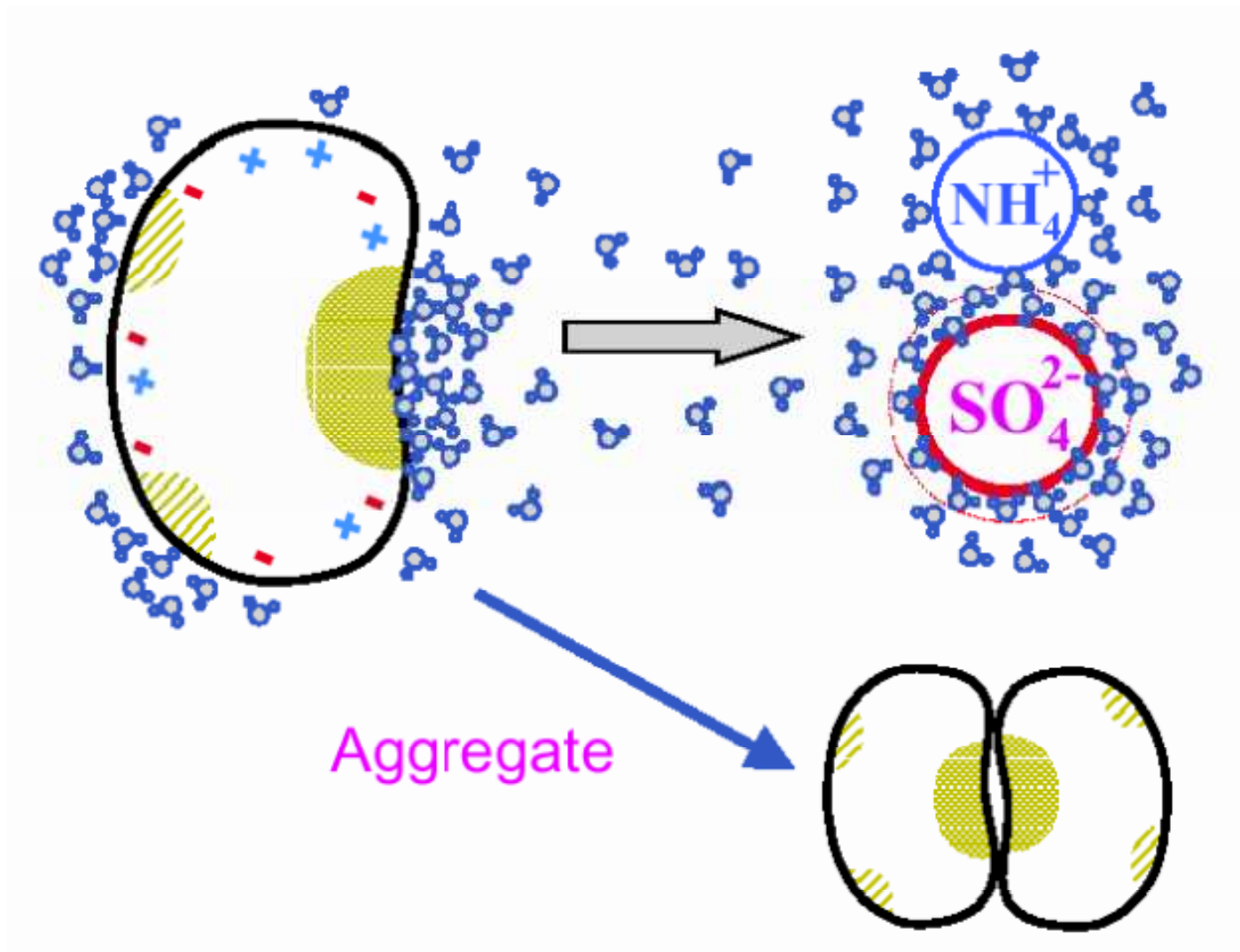

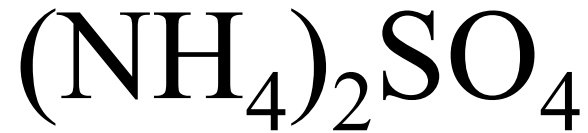

- Rozpustnost se málo mění s teplotou
- Saturevaný roztok 4 M - hustota $1,235\text{g/cm}^3$
umožňuje centrifugaci agregovaných bílkovin
(hustota $1,29\text{ g/cm}^3$)
- Levný
- Stabilizuje bílkoviny
- Relativně čistý

Srážecí křivka

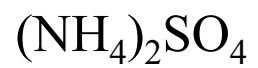

0 10 20 30 40 50 60 70 80 90 100 %

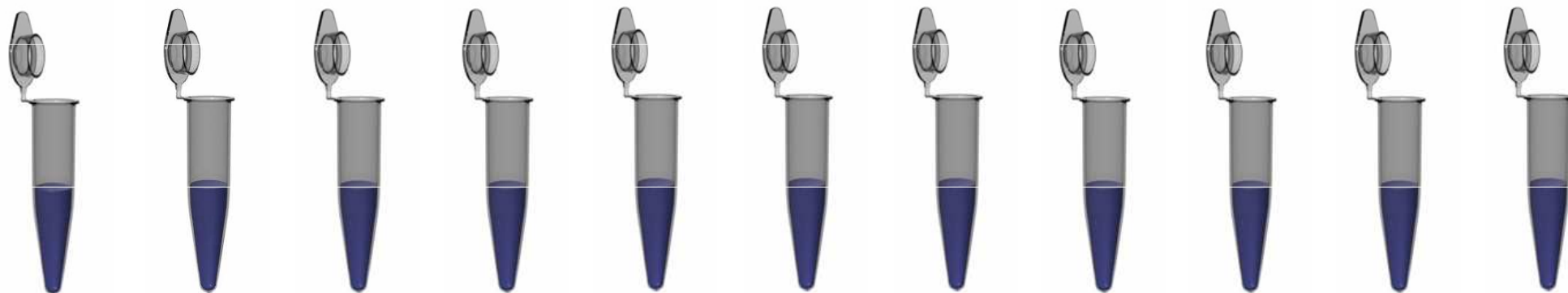

Srážecí křivka

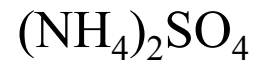

0 10 20 30 40 50 60 70 80 90 100 %

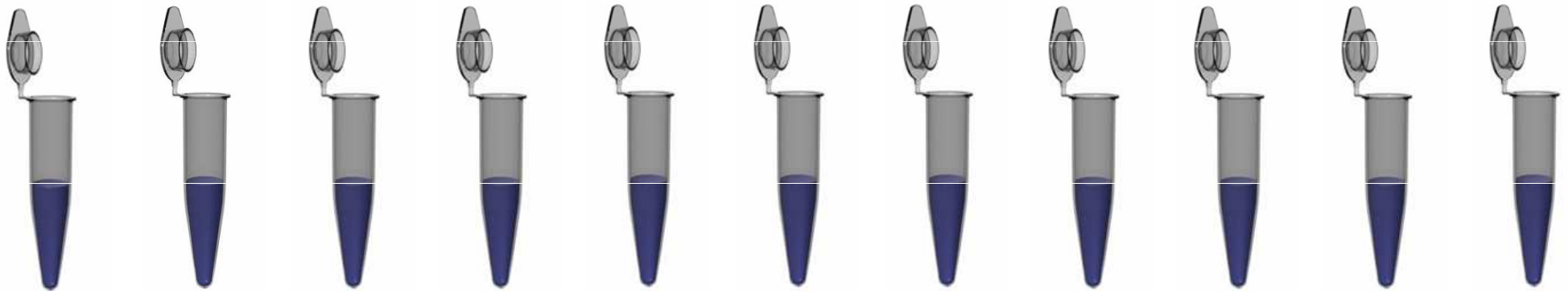

Koncentrace bílkoviny ←

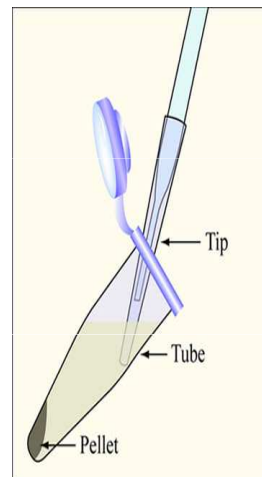

→ Aktivita bílkoviny

Srážení - dvojstupňově

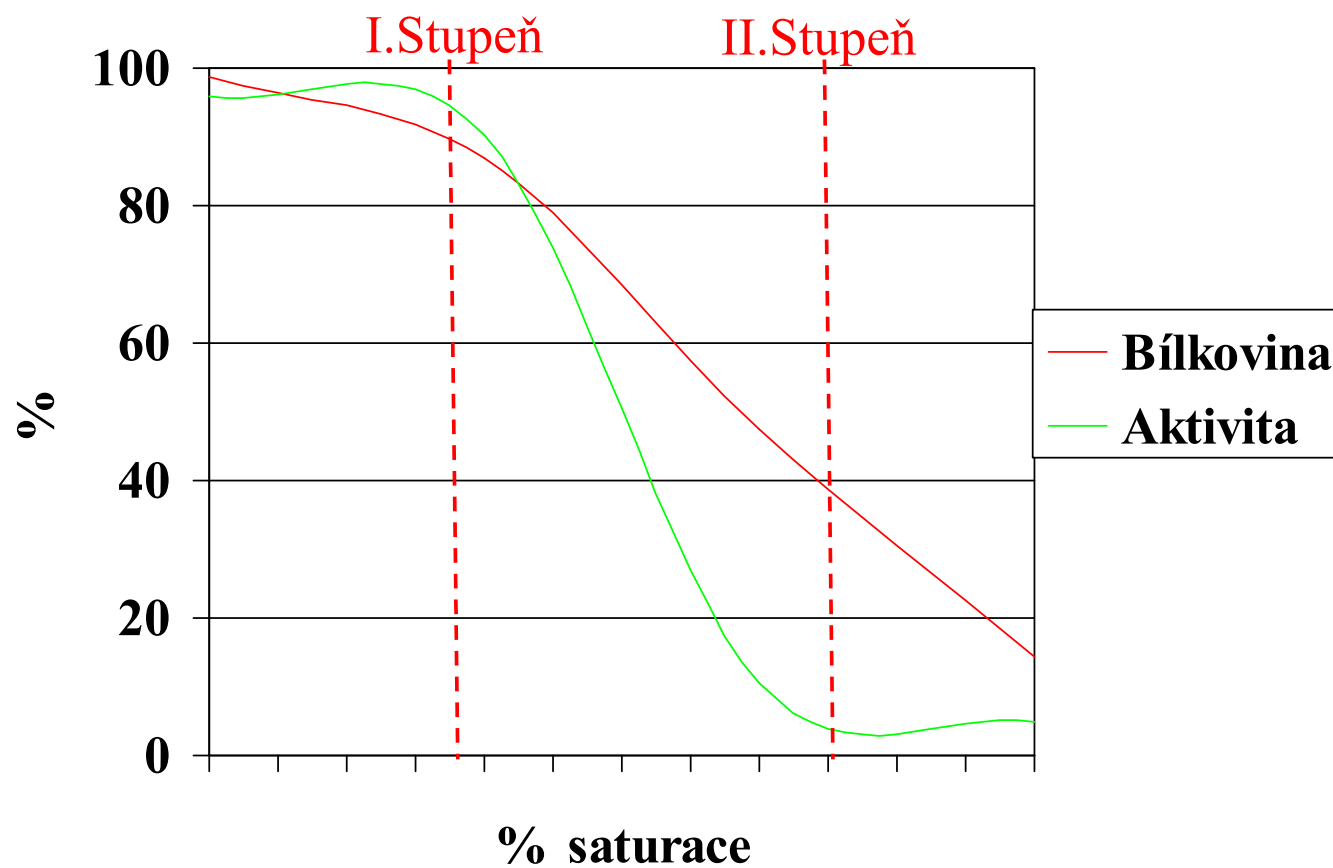

Srážení - dvojstupňově

I. Stupeň

II. Stupeň

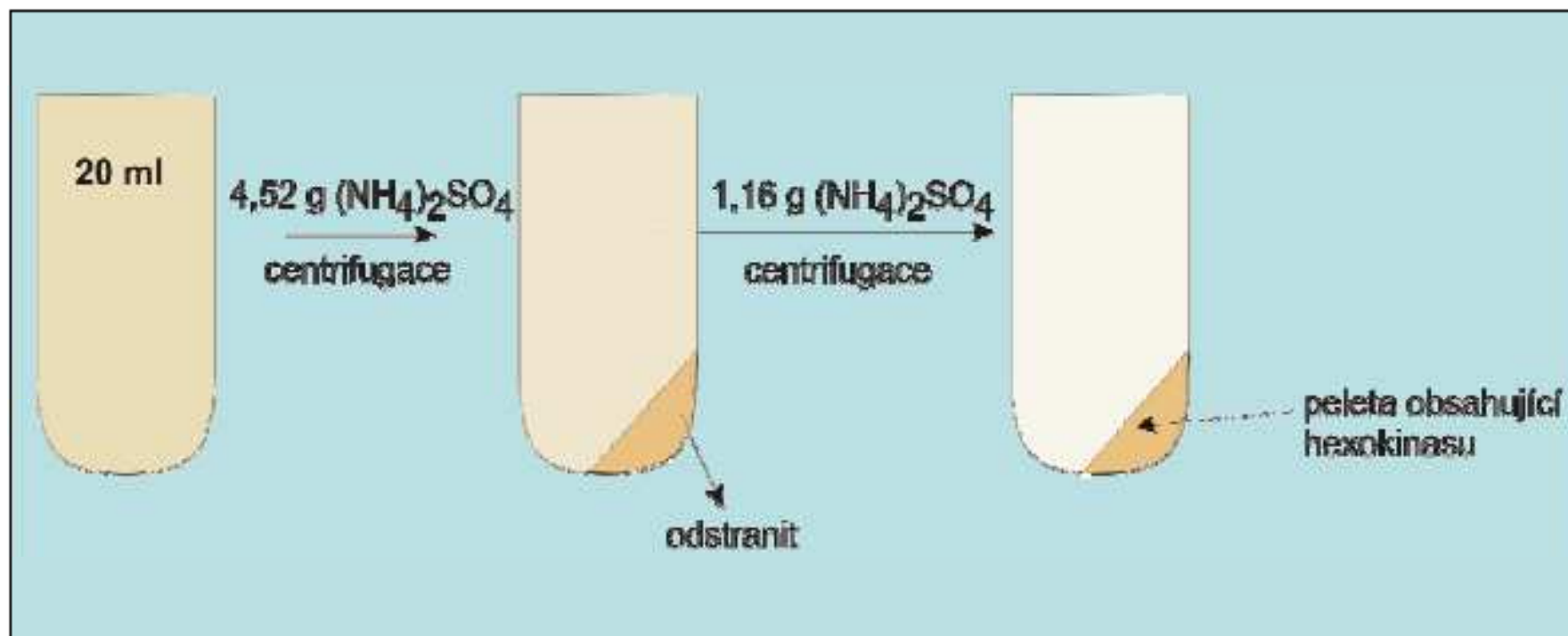

Přidané množství

- Tabulky
- Vzorce

$$g/l = \frac{533 \cdot (S_2 - S_1)}{100 - 0.3 \cdot S_2}$$

Provedení

Chlazení
Míchání 10-30'
Centrifugace

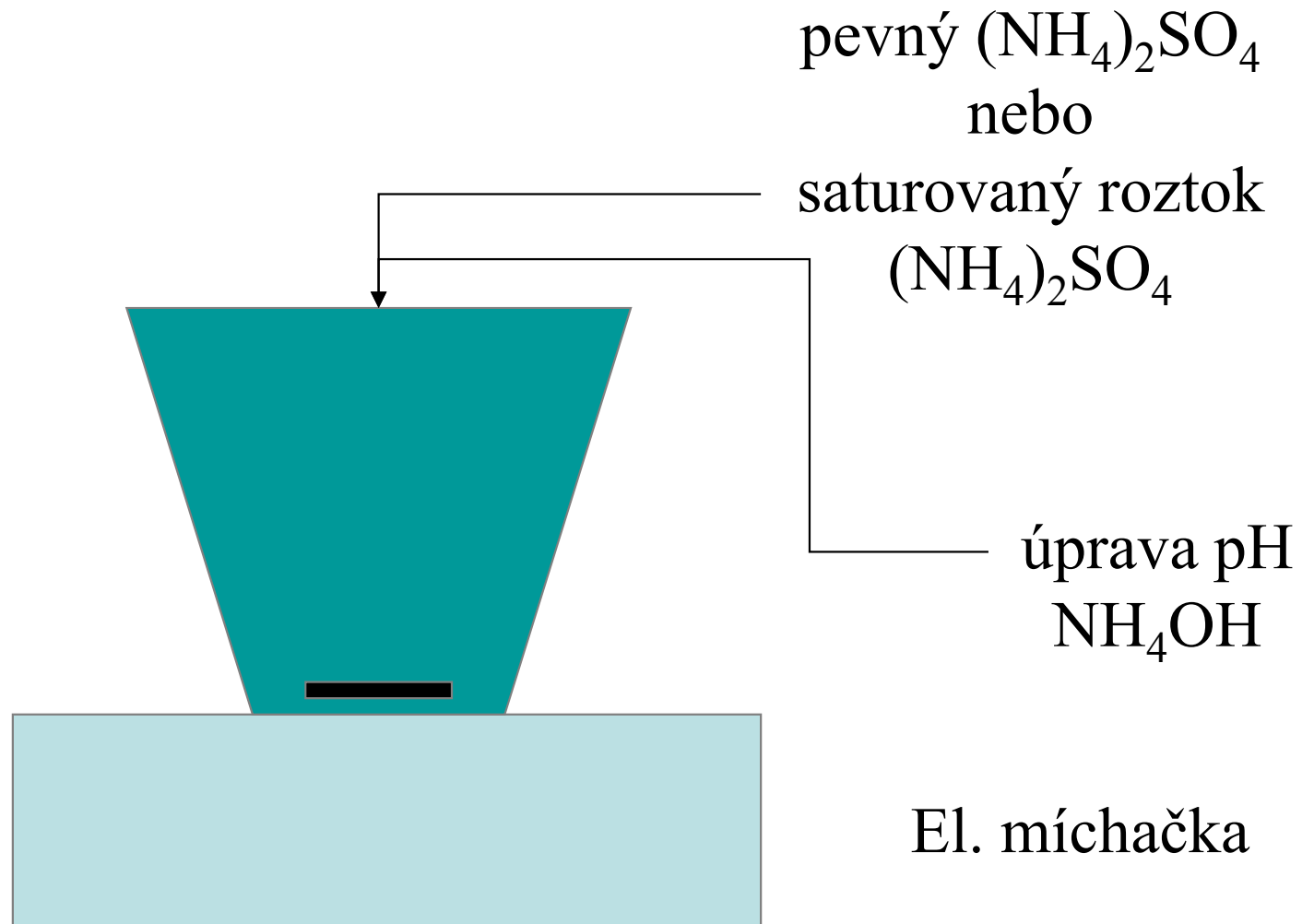

Srážení org.rozpouštědly mísitelnými s vodou

- Rozpouštědla ruší solvatační obal bílkoviny

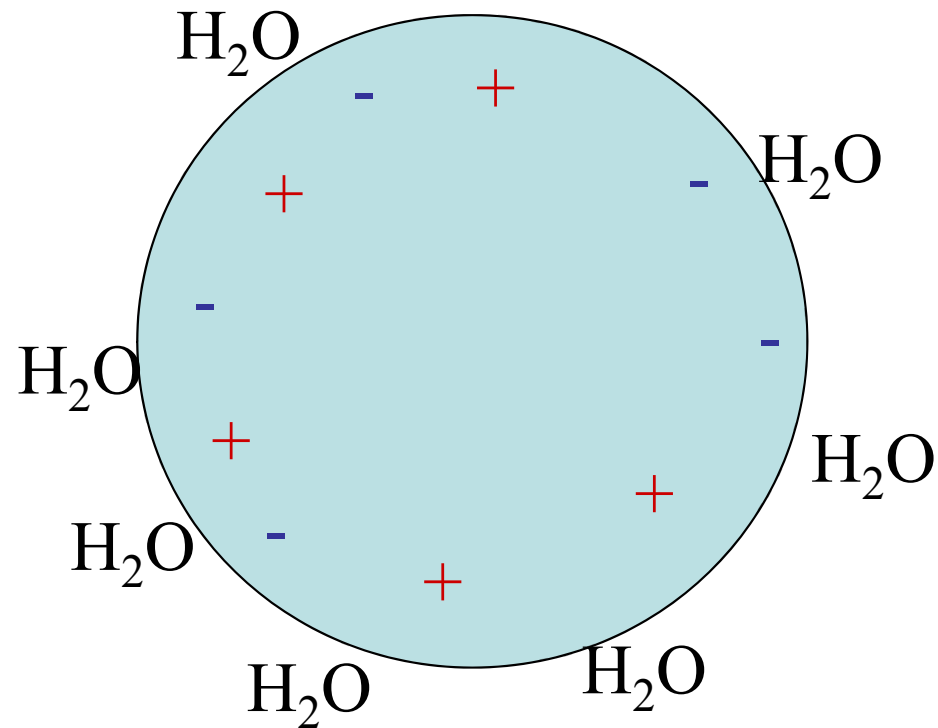

Srážení org.rozpouštědly mísitelnými s vodou

- COHN – separace plazmatických bílkovin
EtOH
- Nutno provádět při $T < 0$ °C, při větší teplotě dochází k denaturaci
- Dvojstupňově
- Přídavky z tabulky nebo podle vzorce

Srážení selektivní denaturací

- Při této metodě denaturujeme balastní bílkoviny, cílová bílkovina musí zůstat z 85 - 90 % v nativním stavu.
- Denaturační vlivy – T, pH, org. rozpouštědla
- Bílkovina musí nejen denaturovat i precipitovat

Tepelná denaturace

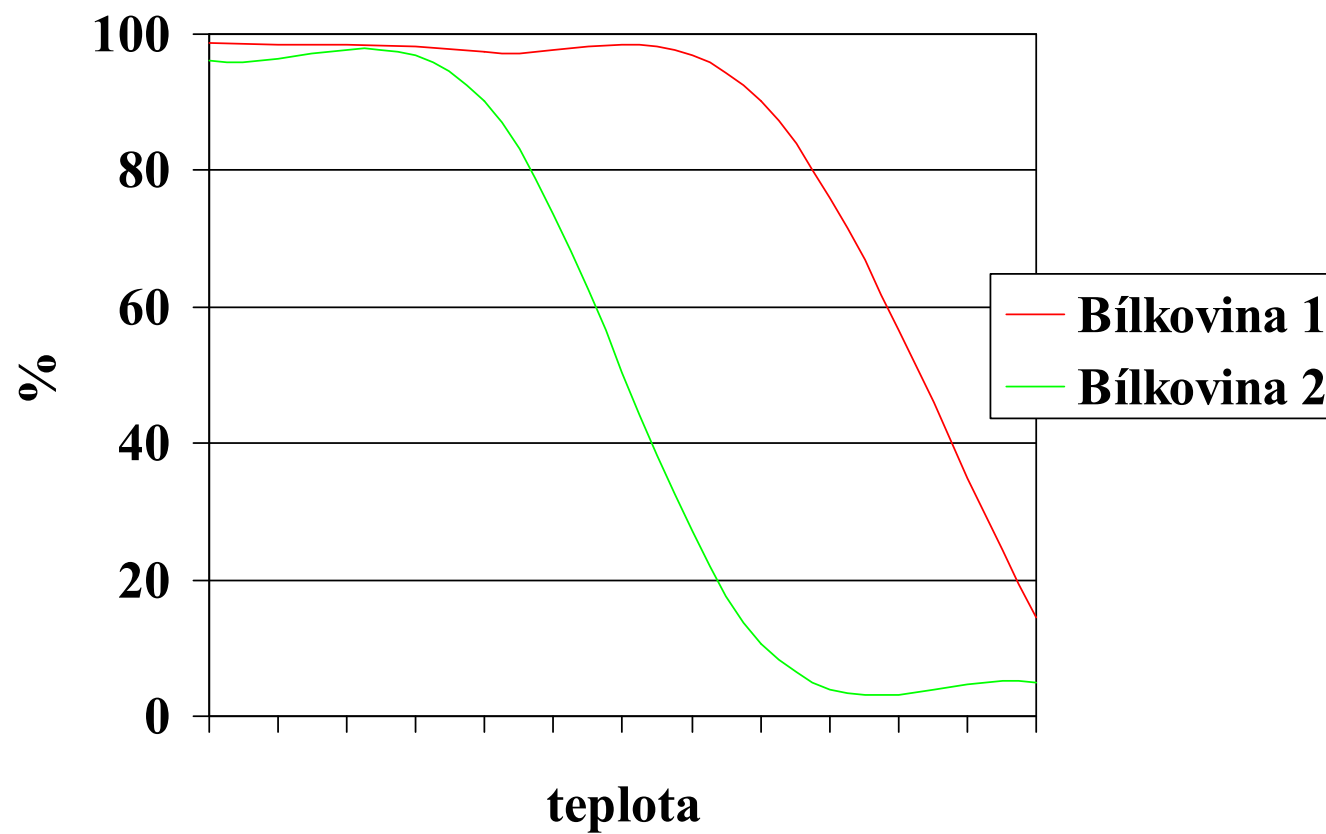

Chromatografické metody

Mikhail Semyonovich Tsvet

Chromatographia 1906

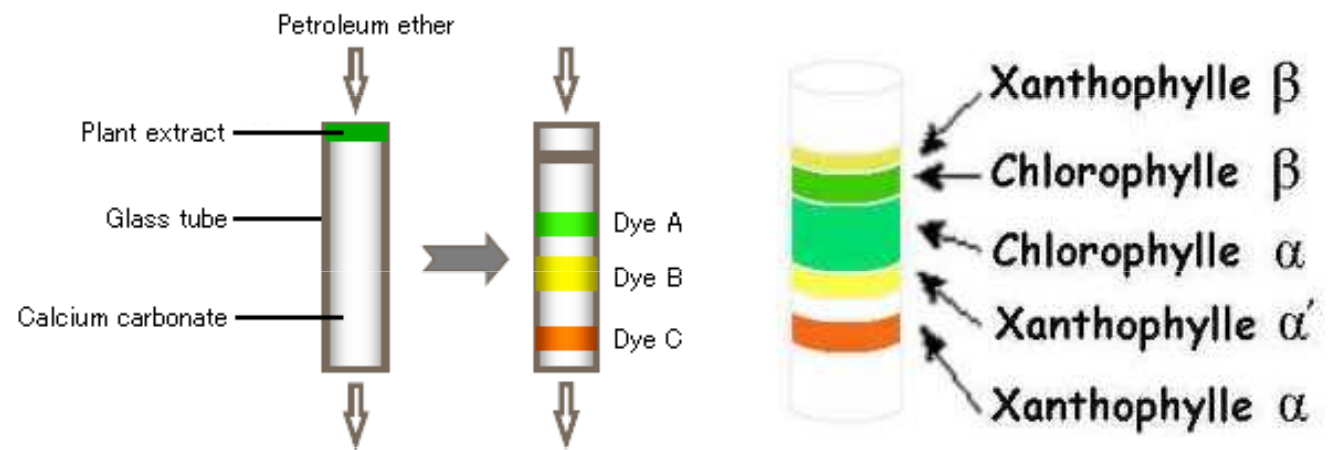
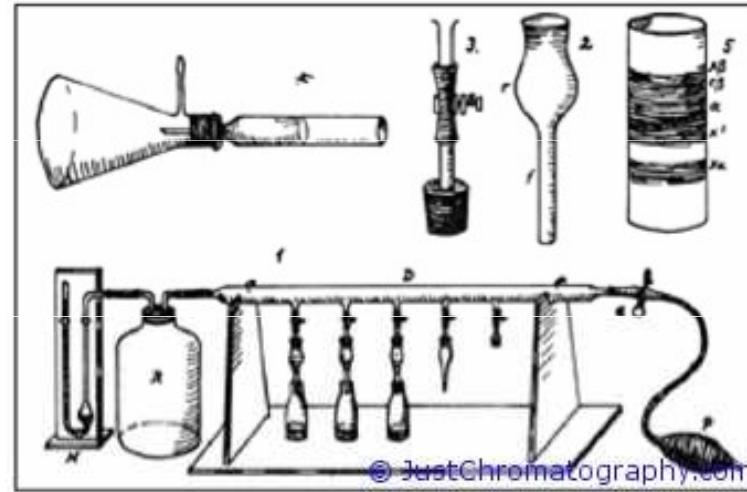

Chromatografie

Mobilní fáze ↙
↘ izokratická eluce
gradientová eluce

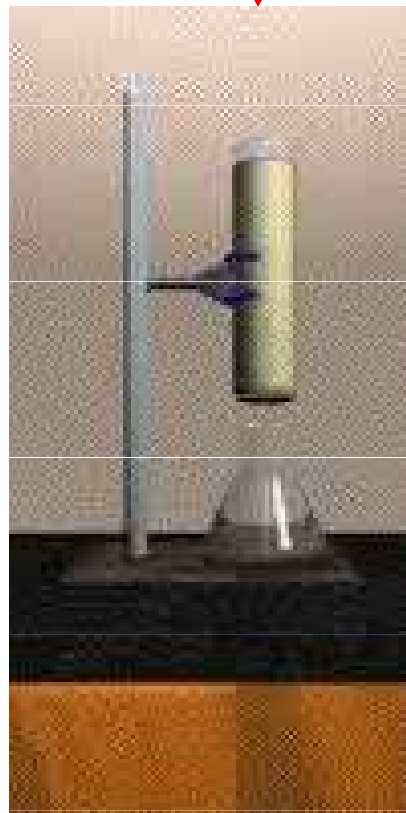

← Stacionární fáze

Zařízení pro LPC

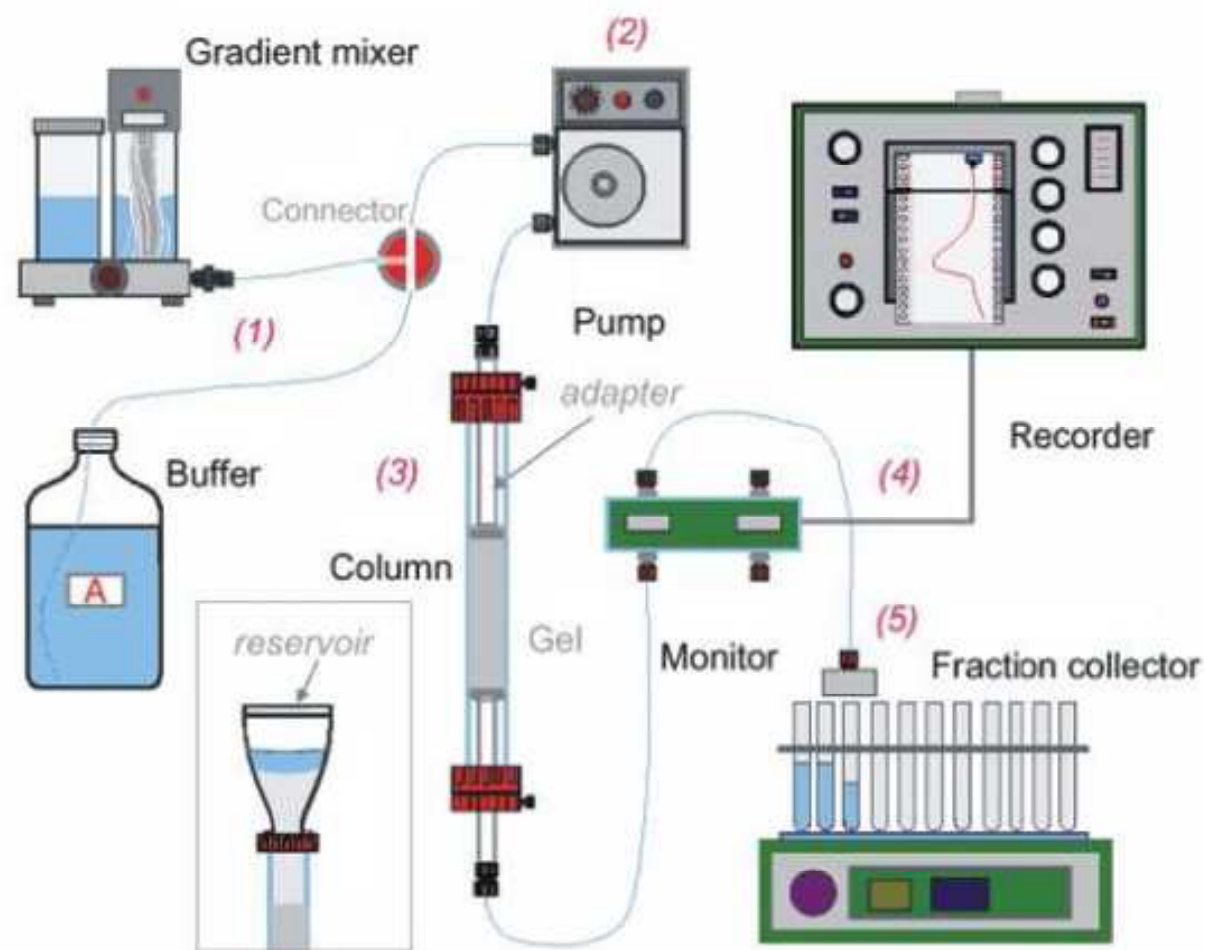

Zařízení pro LPC

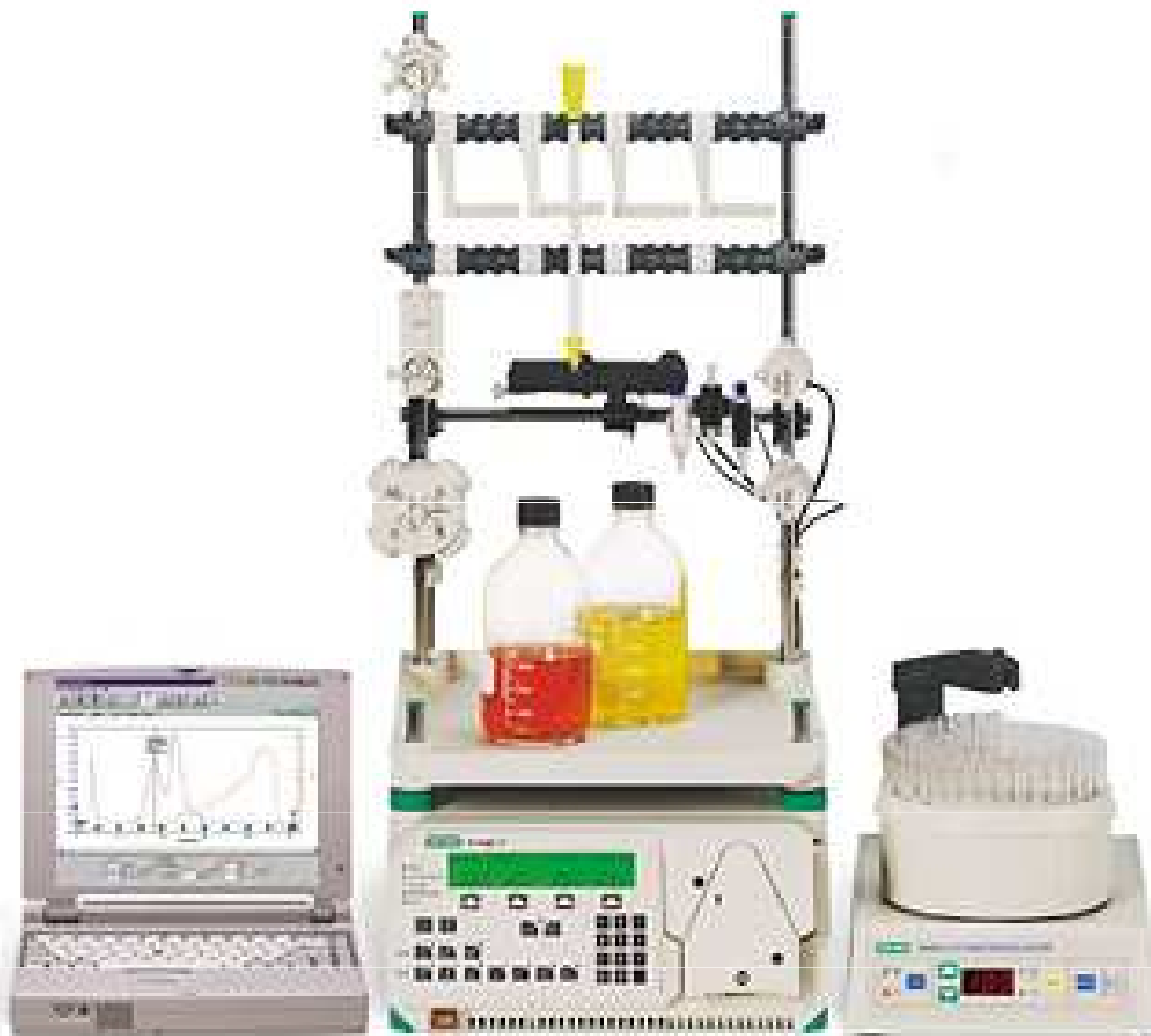

Ionexová chromatografie

elektrostatická interakce

Vazba

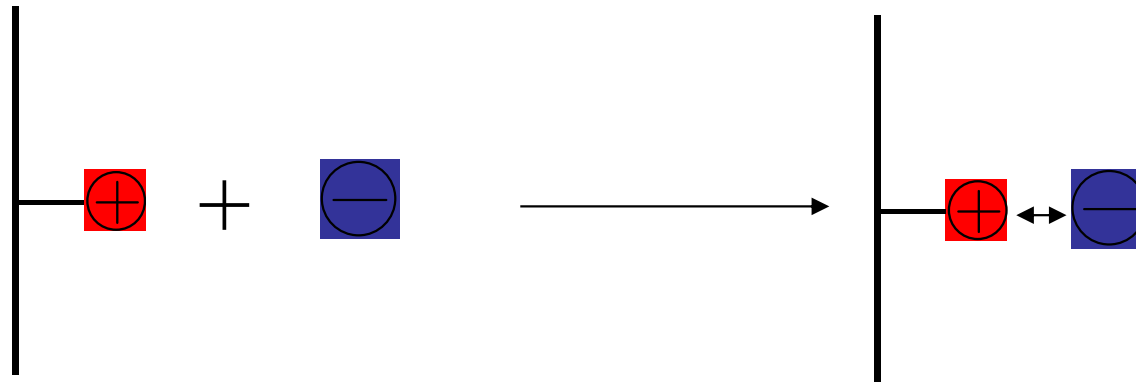

Eluce

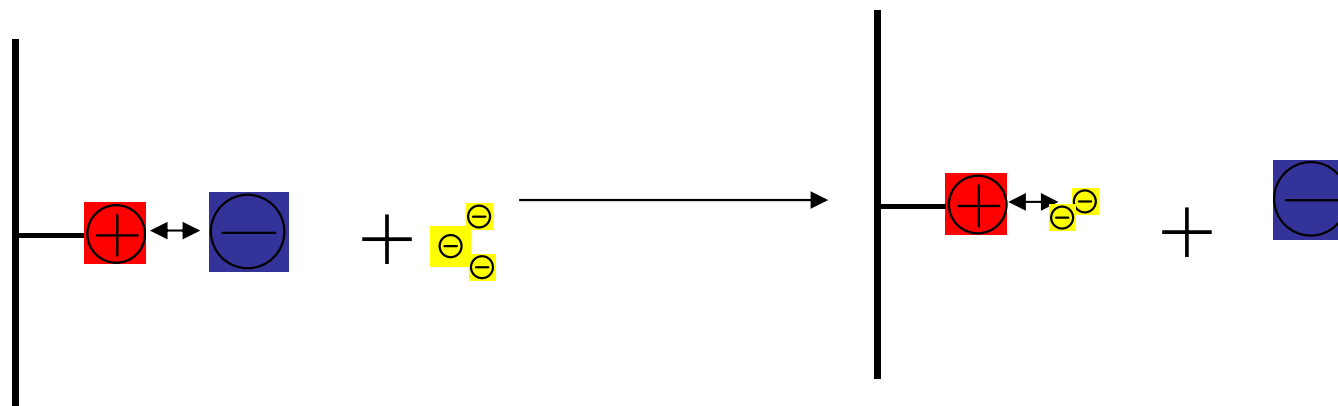

Ionexy

- Katexy - - vazba kationtů

silné - sulfo(S), sulfopropyl(SP) OSO_3^-

slabé - karboxy(C), karboxymetyl(CM) COO^-

- Anexy - + vazba aniontů

silné - dietylaminoetyl(DEAE)

slabé – trietylaminoetyl(TEAE)

Volba podmínek – pH + typ ionexu

pI bílkoviny je znám

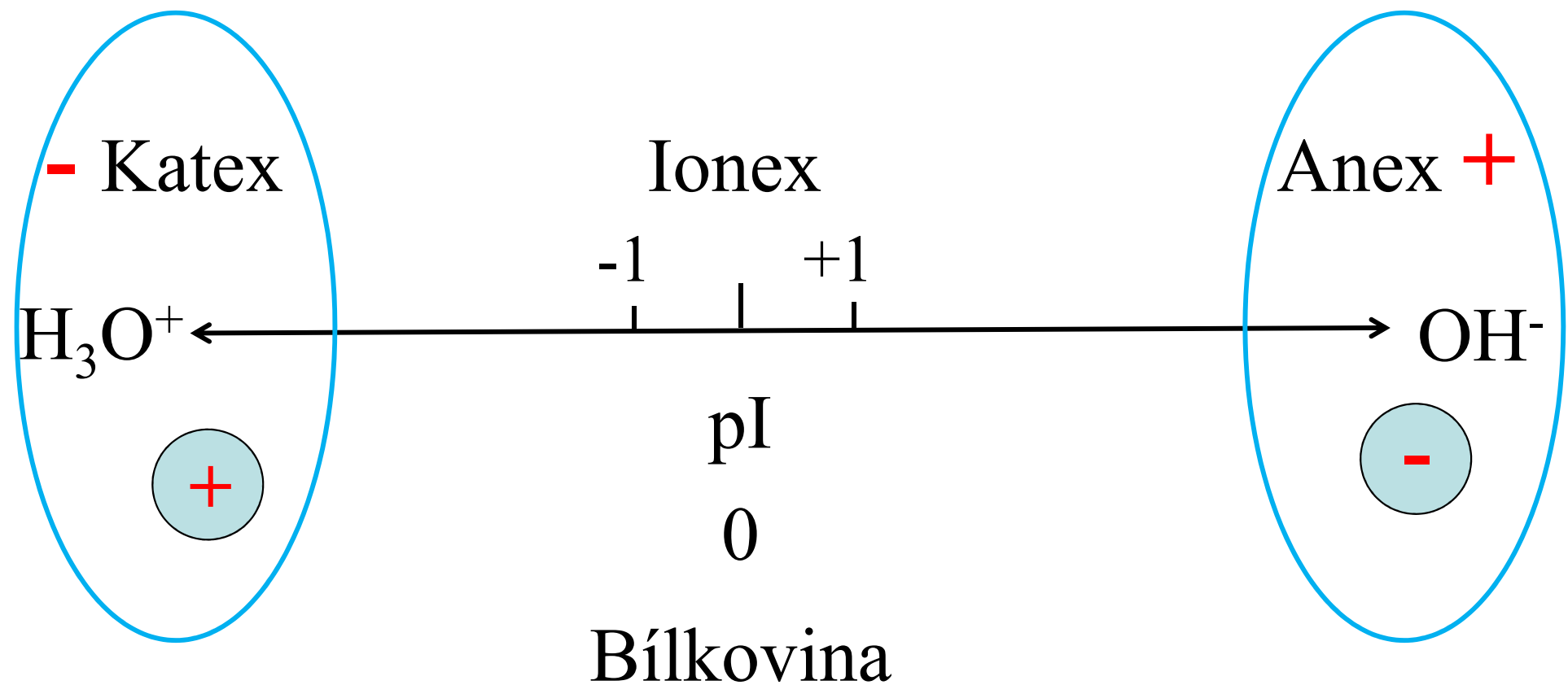

Volba podmínek – pH + typ ionexu

pI bílkoviny není znám

- Metoda pokusů a omylů

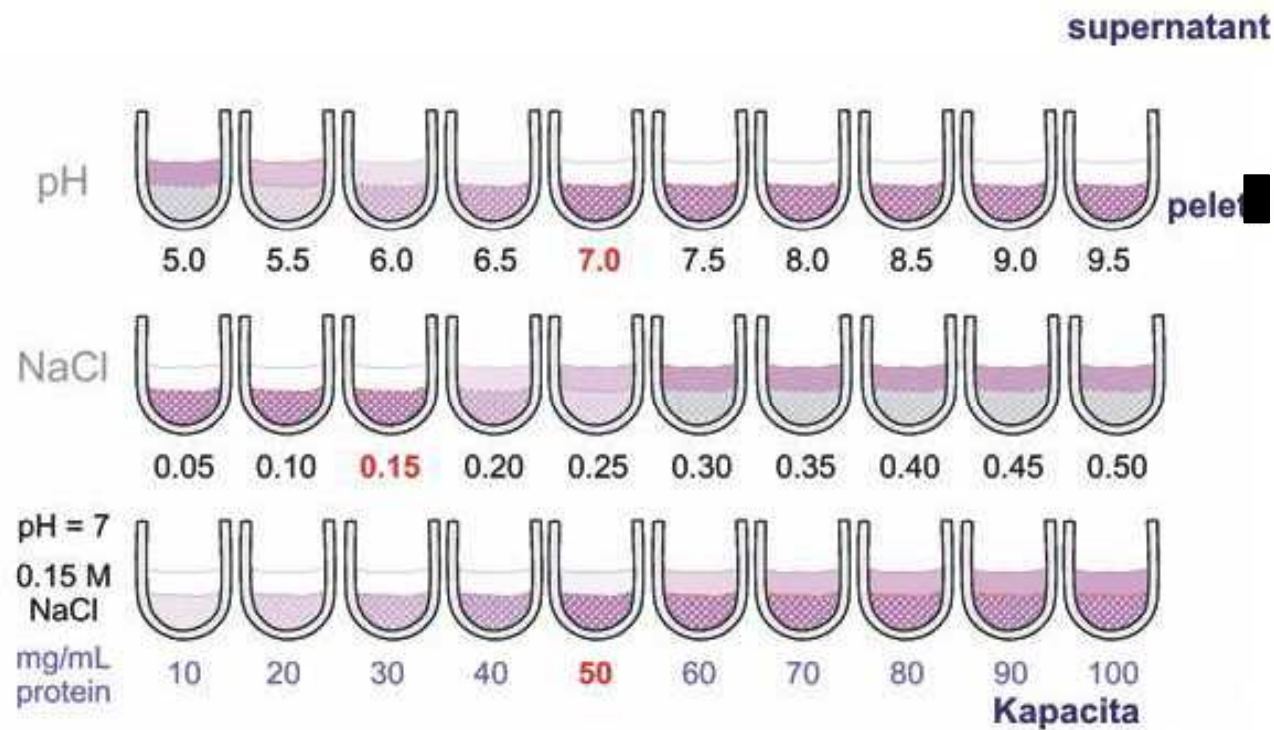

- Metoda titračních křivek

Ionexová chromatografie

- Nanášení vzorku – nízká iontová síla
- Eluce – gradientová
 - Zvyšováním iontové síly
 - Změnou pH
 - Afinitní eluce

Použití – purifikace, zakoncentrování, výměna pufu

Ionexová chromatografie

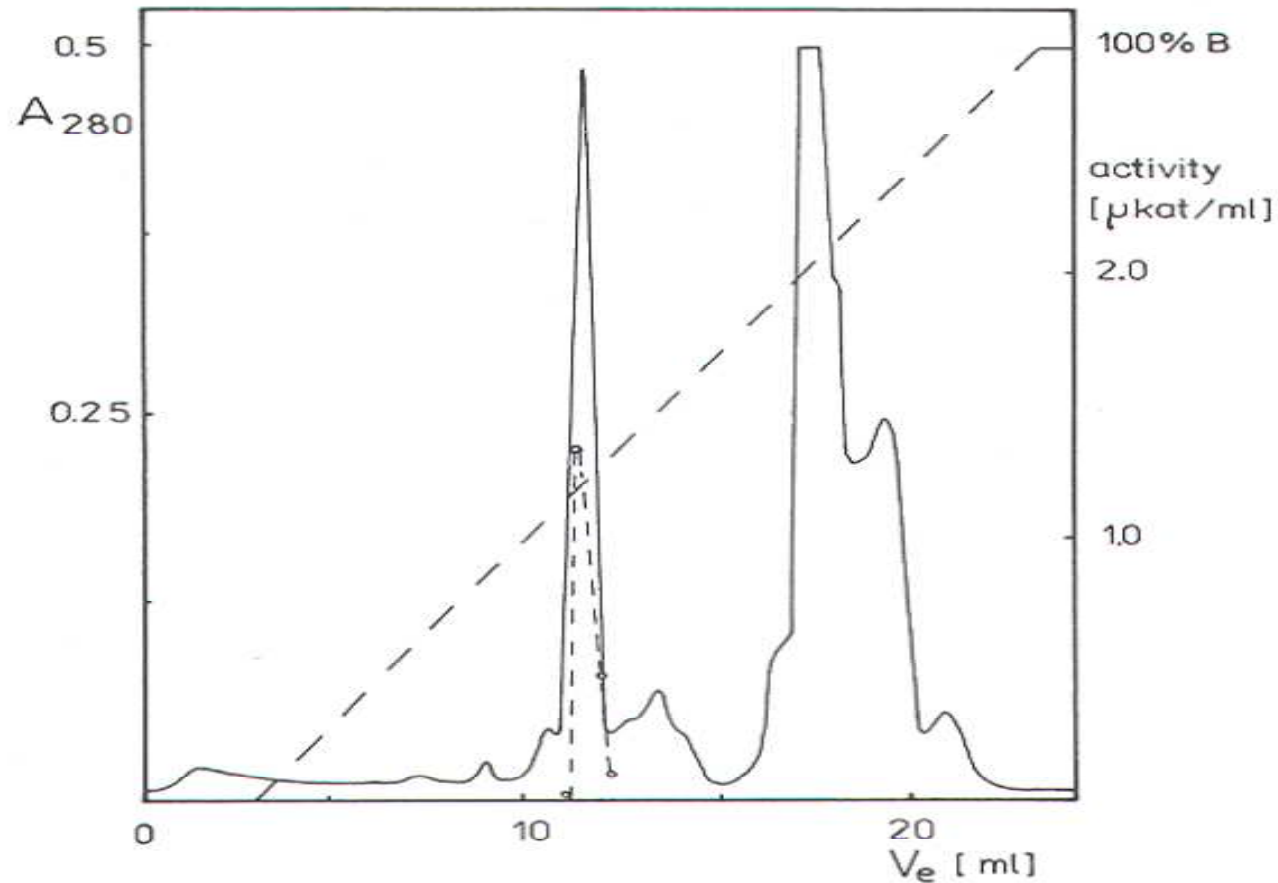

Fig. 2. Chromatography of partially purified G6P-DH on a Mono Q column. Buffers: (A) 0.05 M sodium phosphate (pH 7.4); (B) same as A but with 1 M sodium chloride; flow-rate, 1 ml/min. Lines symbol as in Fig. 1. Approximately 10 mg of protein were applied to the column.

Hydrofobní chromatografie

- Stacionární fáze – - C₈, -fenyl
- Mobilní fáze – vodné roztoky
1.7 M (NH₄)₂SO₄
- Eluce – snižováním iontové síly

Použití : purifikace bílkovin

Hydrofobní chromatografie

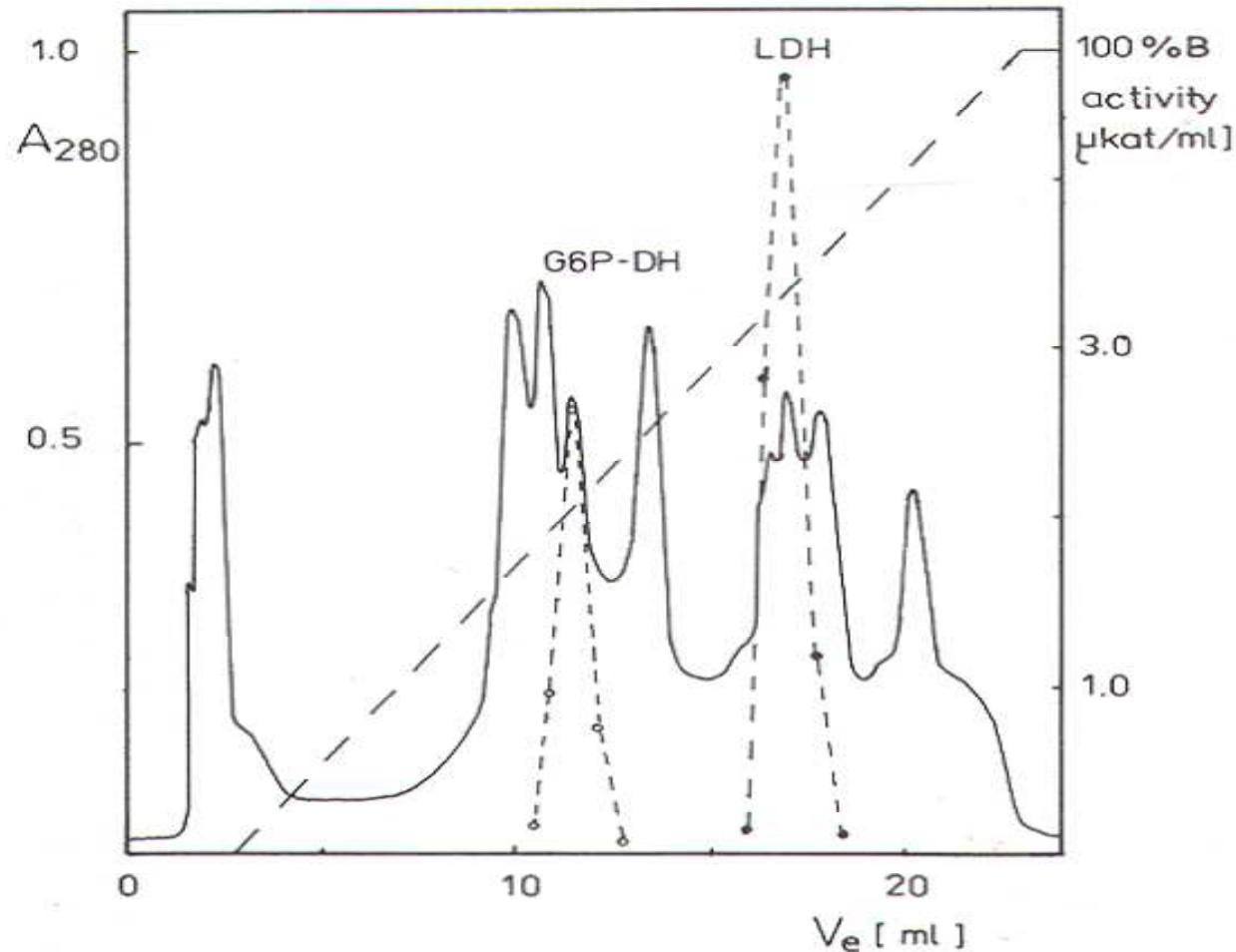
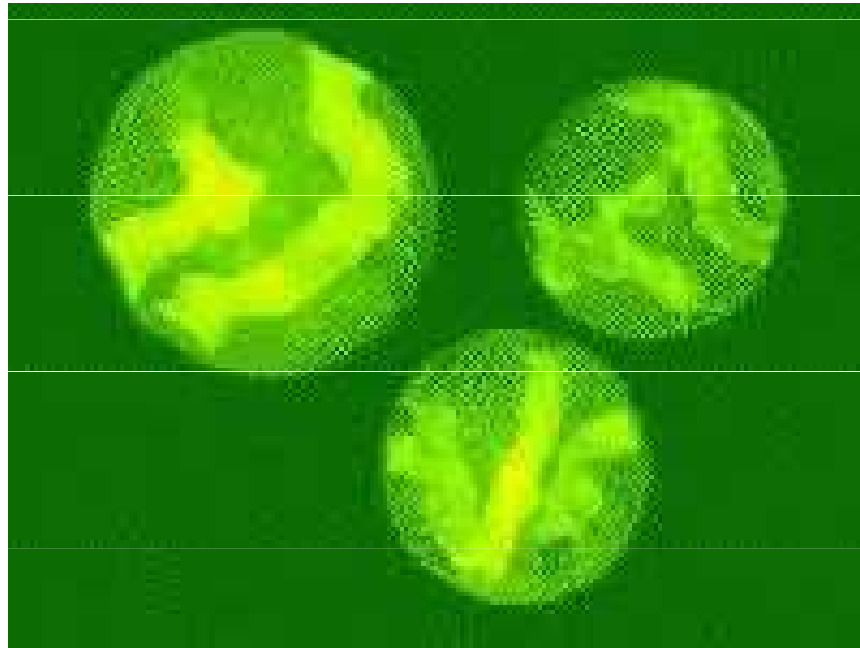

Fig. 1. Chromatography of crude enzyme preparation on a Phenyl-Superose column. Buffers: (A) 0.05 *M* sodium phosphate (pH 7.4) with 1.7 *M* sodium sulphate and 1 *mM* EDTA; (B) 0.05 *M* sodium phosphate (pH 7.4); flow-rate, 0.5 ml/min. V_e , elution volume; solid line, absorbance at 280 nm (A_{280}); dashed lines, gradient; (○) G6P-DH activity; (●) LDH activity. Approximately 10 mg of protein were applied to the column.

Gelová permeační chromatografie



Gelová permeační chromatografie

Princip - stérická exkluze
- omezená difuze

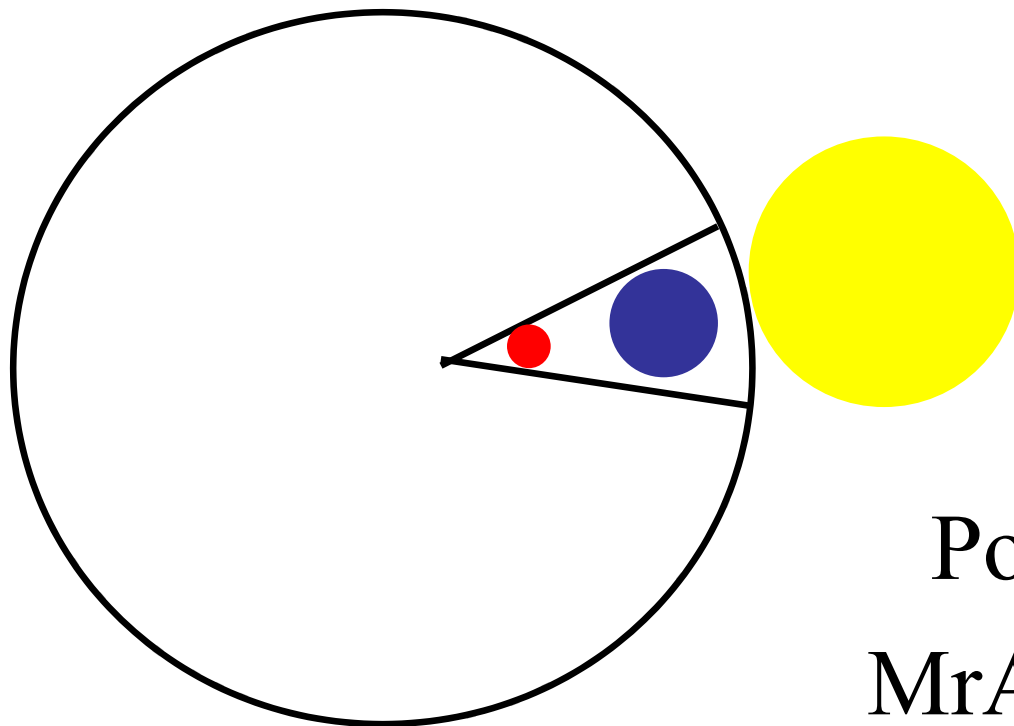

Pořadí eluce :

$MrA > MrB > MrC$

Gelová permeační chromatografie

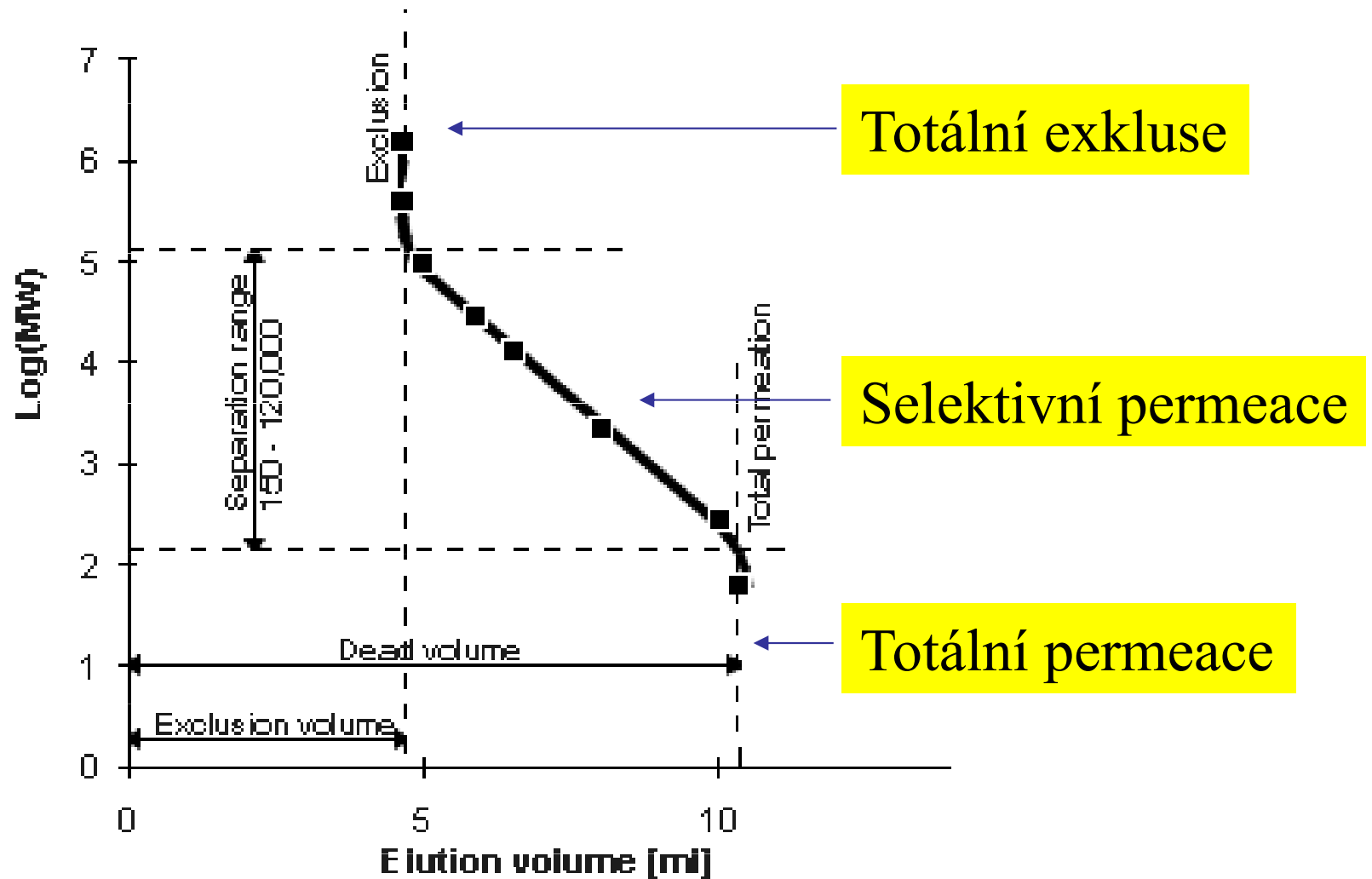

Gelová permeační chromatografie

- Nanášení vzorku – objem vzorku $< 2\%$
objemu kolony
- Eluce – izokratická

Použití : stanovení Mr, odsolování, purifikace

Gelová permeační chromatografie

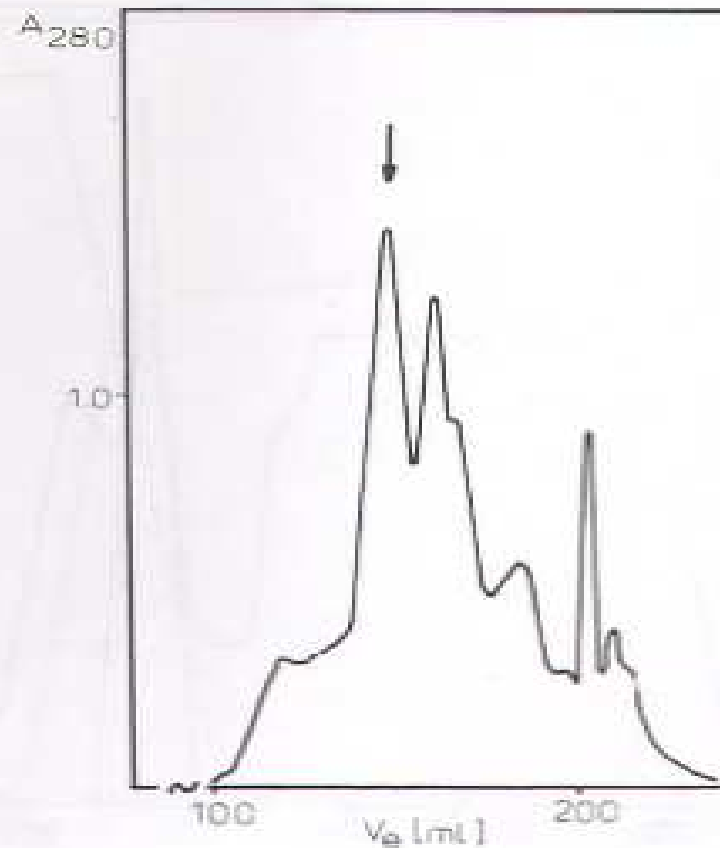

Figure 3

Chromatography of partially purified DAO on TSK 3000 SWG column. Buffer: 0.05 M potassium phosphate (pH 6.5) with 0.15 M sodium chloride; flow rate 5 ml/min. The symbols are as in Fig. 1. DAO activity is indicated by an arrow. Approximately 100 μ g of protein were applied to the column.

Gelová permeační chromatografie

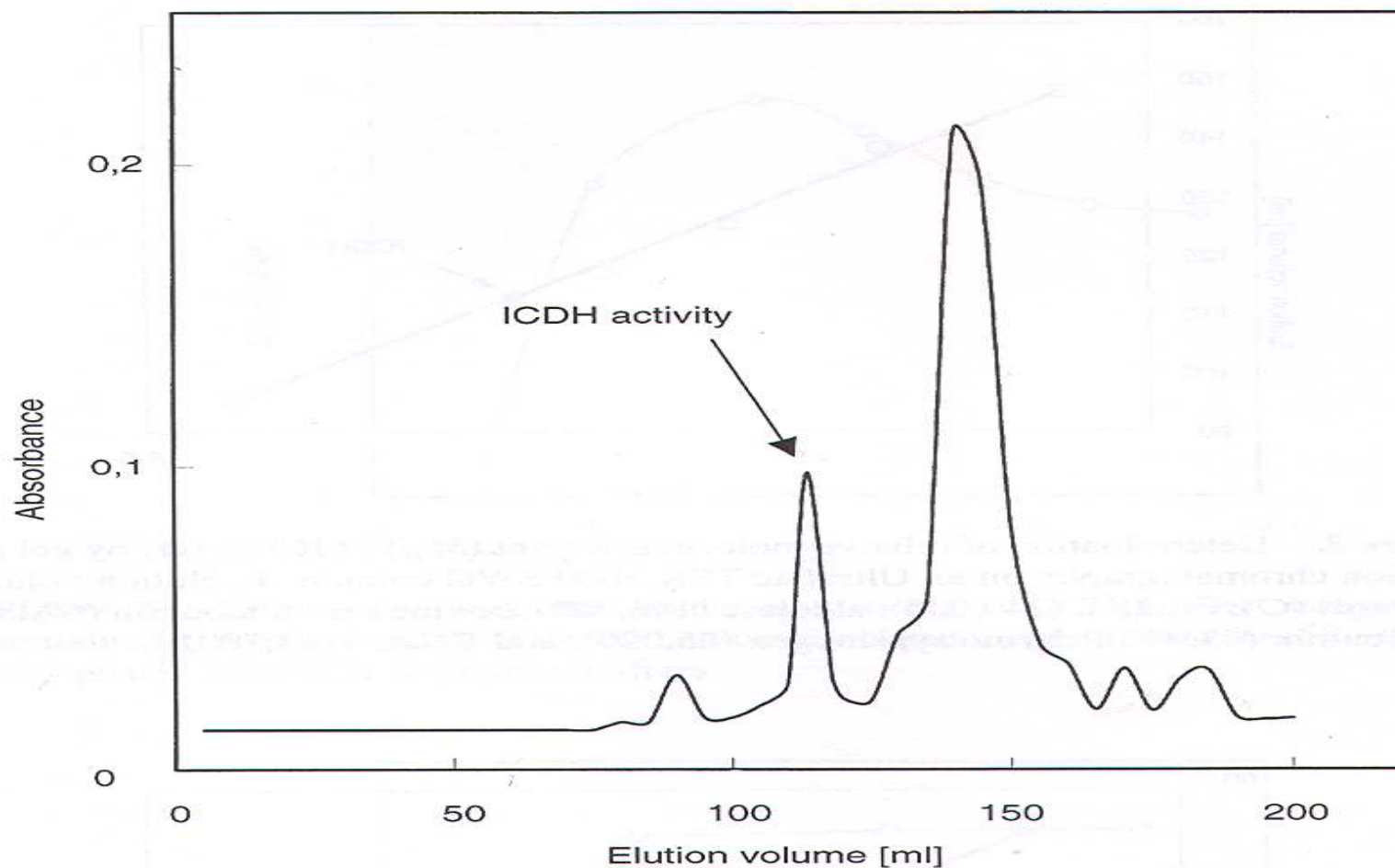

Figure 2. Chromatography of partially purified ICDH (after ammonium sulphate fractionation and ion exchange chromatography) on an UltraPac TSK G3000 SWG column. Buffer—20 mM sodium phosphate, pH 6.8; flow-rate 5 mL/min. (V_e) elution volume; (—) A_{280} ; (---) ICDH activity. Approximately 10 mg of protein was loaded onto the column.

Gelová permeační chromatografie

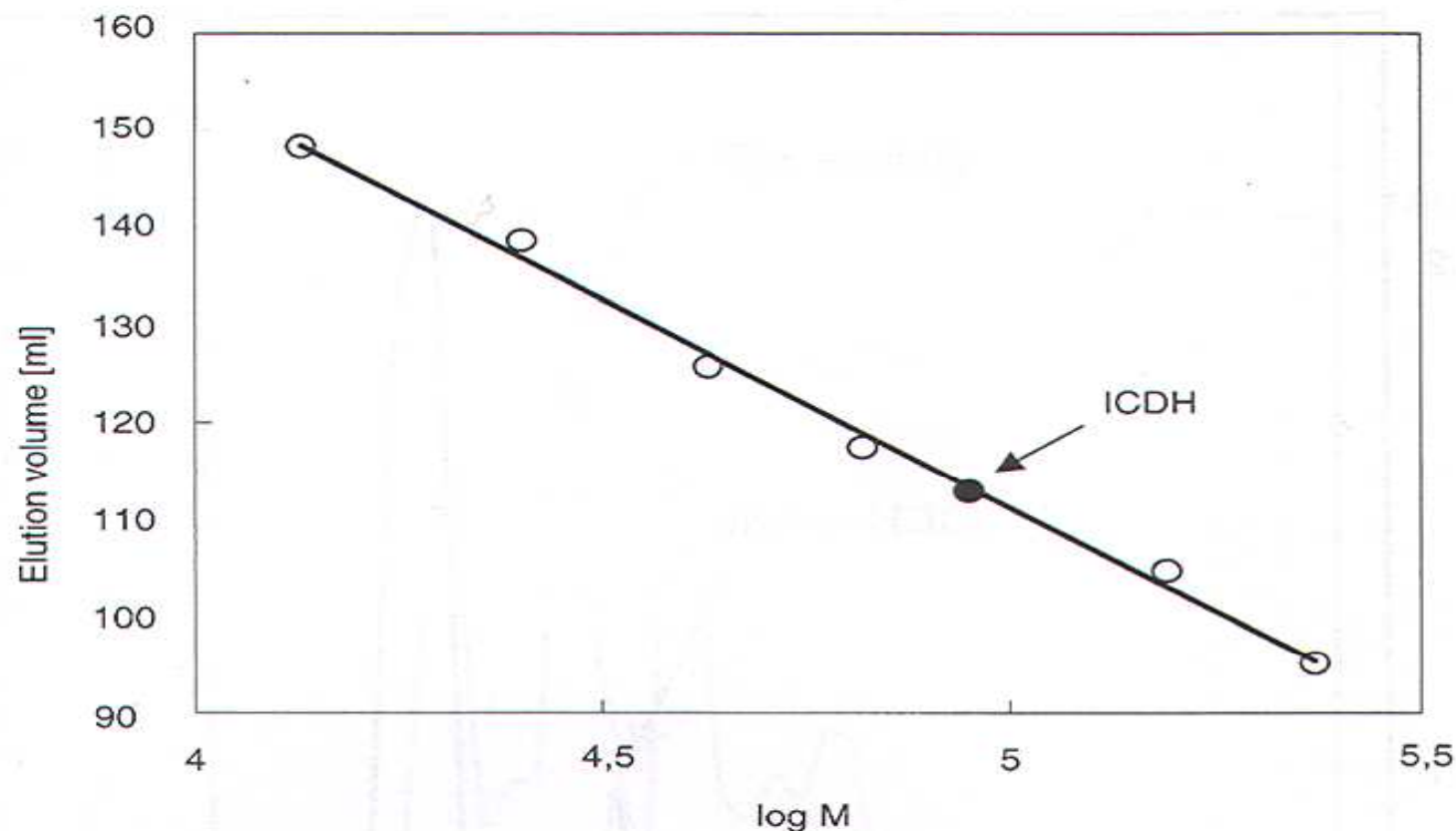
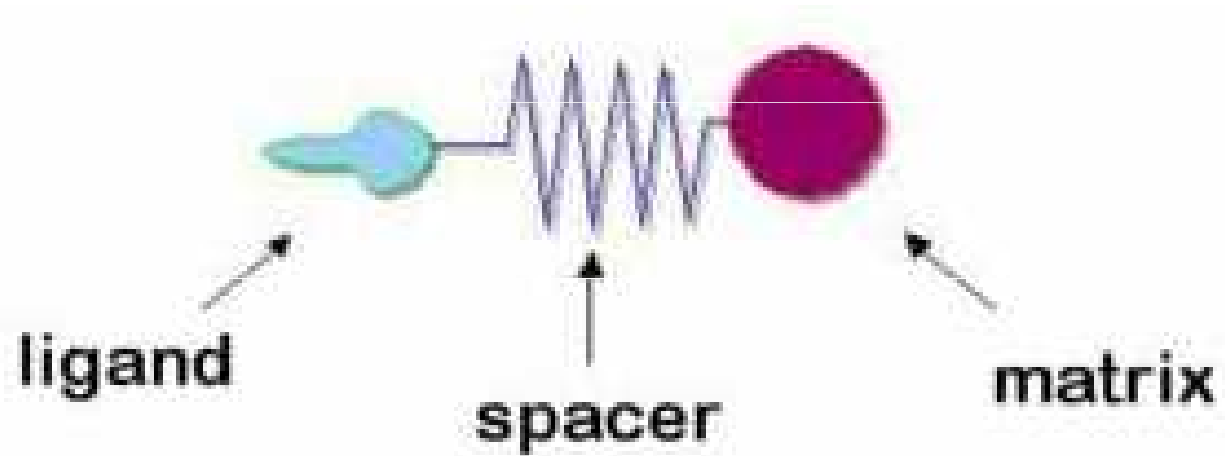
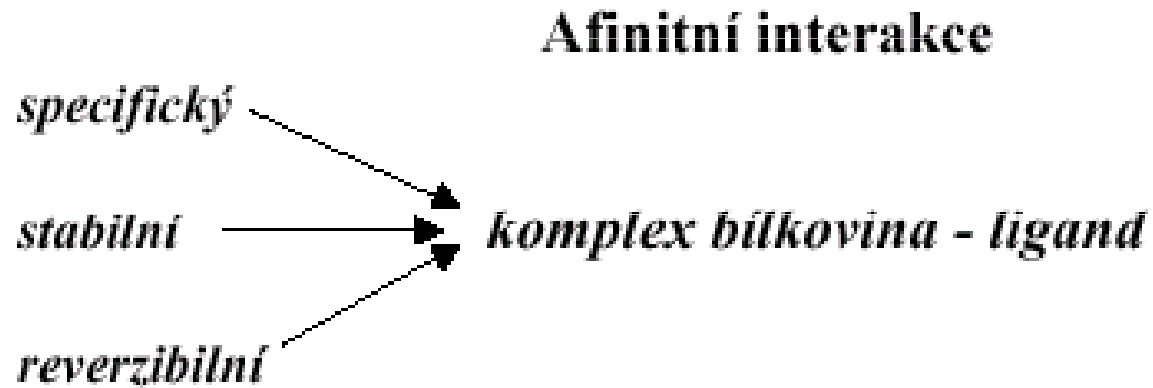

Figure 3. Determination of relative molecular weight (M_w) of ICDH (●) by gel permeation chromatography on an UltroPac TSK 3000 SWG column. V_e elution volume; standards (○): catalase (240,000), aldolase (146,000), bovine serum albumin (67,000), ovalbumin (43,000), chymotrypsinogen (25,000), and RNase (13,700).

Afinní chromatografie



Afinní interakce



Afinní chromatografie nanesení vzorku



Afinní chromatografie

vznik interakce

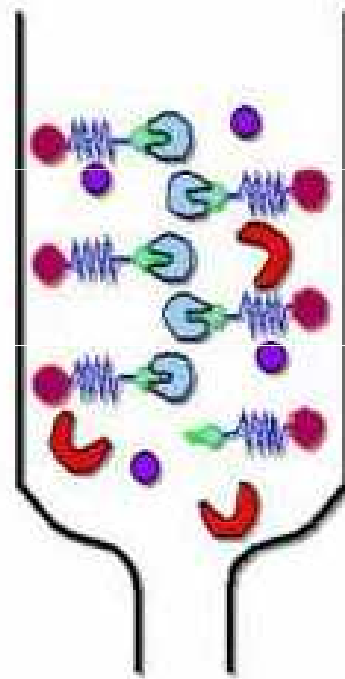

Afinní chromatografie vymytí balastů

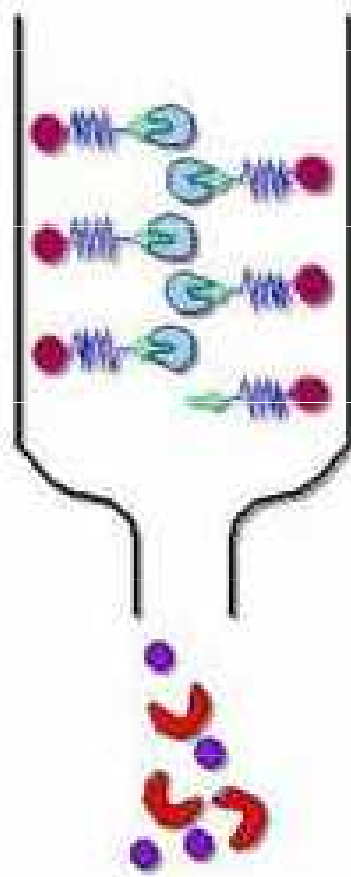

Afinní chromatografie eluce

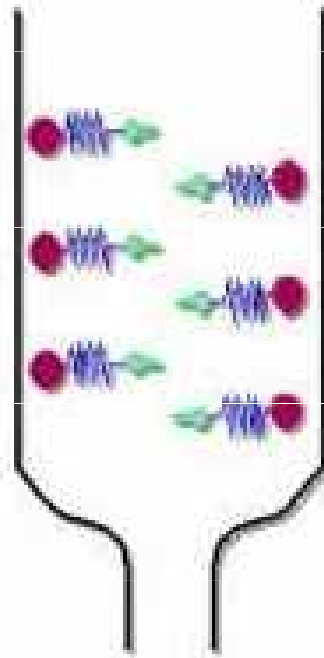

Afinitní páry

Ligand	Bílkovina	K_D (M)
antigen	polyklonální protilátka	$10^{-8} - 10^{-6}$
antigen	monoklonální protilátka	$10^{-12} - 10^{-8}$
biotin	avidin	10^{-15}
sacharid	lektin	$10^{-6} - 10^{-3}$
hormon, toxin	vazebný protein	$10^{-9} - 10^{-12}$
substrát	enzym	$10^{-7} - 10^{-3}$
inhibitor	enzym	$10^{-14} - 10^{-6}$

$$K_D = 10^{-8} - 10^{-6} \text{ M}$$

Afinní interakce

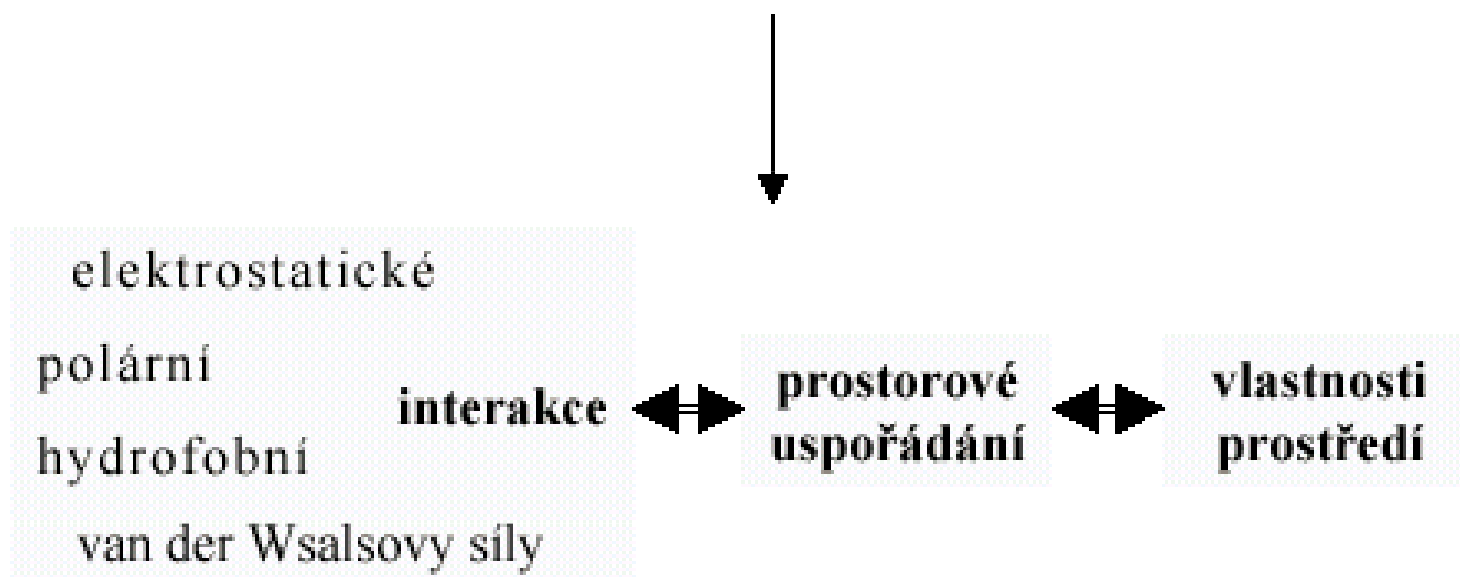

Předpoklady pro vznik komplexu

- Sterické – použití raménka (spacer)



- Optimální pH, iontová síla

Afinní chromatografie

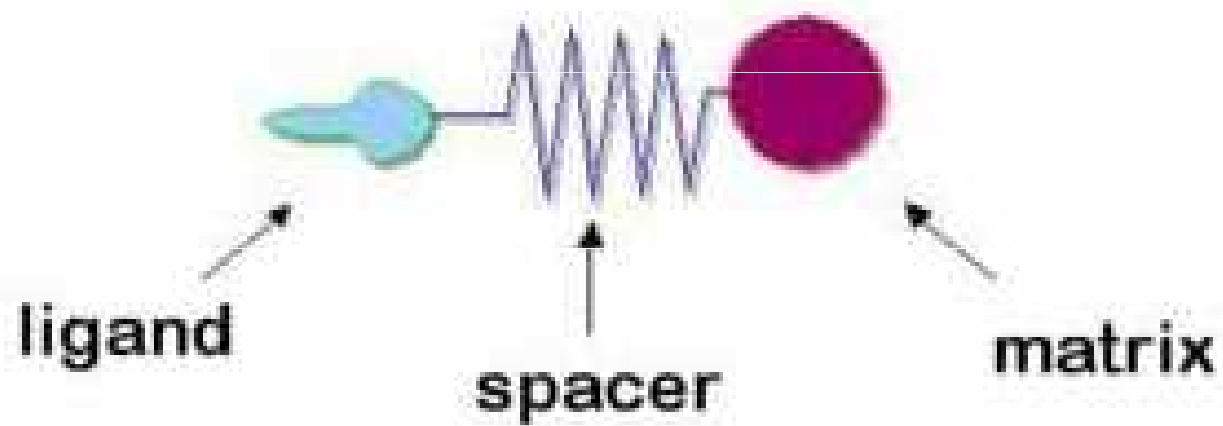

Předpoklady pro vznik komplexu

- Vazebné
- Konformační

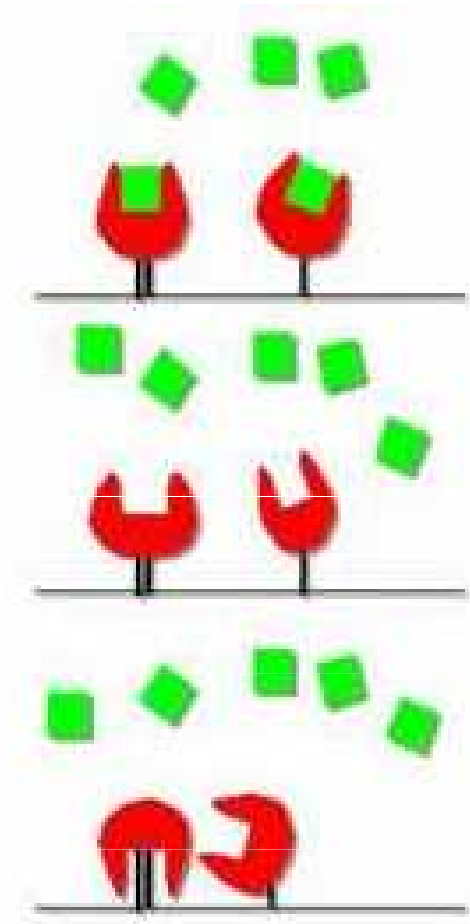

Ligandy

Monospecifické

- váží pouze jedinou biomakromolekulu
- nutné si připravovat individuálně

Skupinově specifické

- váží biomakromolekuly s podobnými vlastnostmi
- komerčně dostupné

Imobilizace ligandů

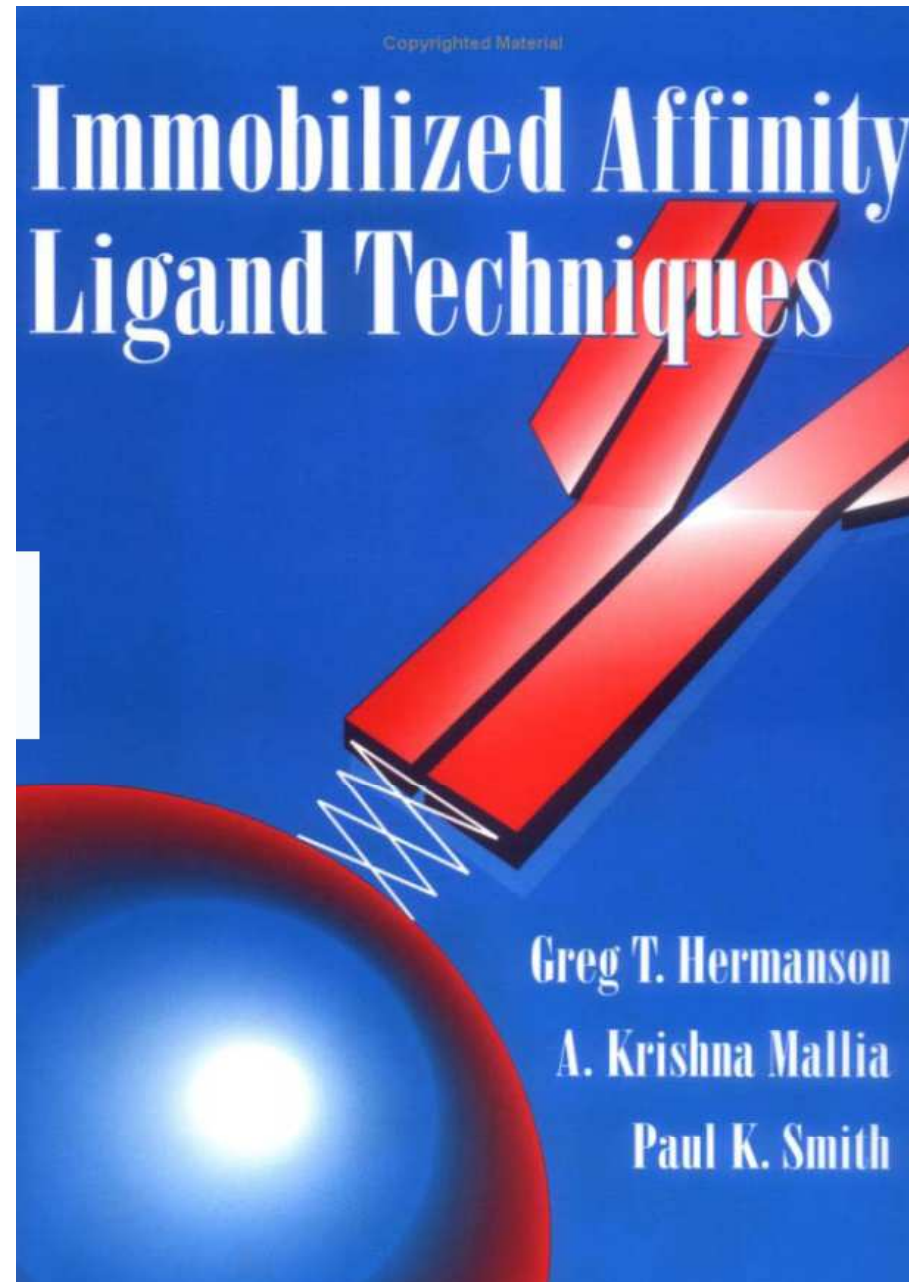

Skupinově specifické ligandy

skupinově specifický ligand	specifita
Protein A	Fc region IgG
Protein G	Fc region IgG
Lektiny	glukopyranosylové a mannopyranosylové skupiny
Cibacron Blue	široká skupina enzymů, NAD ⁺ dependentní enzymy, sérový albumin
Procion Red	NADP ⁺
Lysin	plasminogen, rRNA
Arginin	serinové proteasy
Benzamidin	serinové proteasy
Kalmodulin	proteiny regulované kalmodulinem
Heparin	kolagulační faktory, lipoproteiny, lipasy, hormony, steroidní receptory, nukleové kyseliny vázající enzymy
Streptavidin	Biotin a biotinylované látky
Oligo (dT, dA, ...)	mRNA, nukleasy
Kovové ionty	proteiny a peptidy obsahující dostupný His

Provedení

- Nanesení vzorku – nízká iontová síla
- Eluce – selektivní - volným ligandem
 - neselektivní - změna pH, iontové síly, polarity

Použití : analytické (stanovení K), purifikace

Eluce

- Eluce – selektivní - volným ligandem
nebo kompetičním činidlem

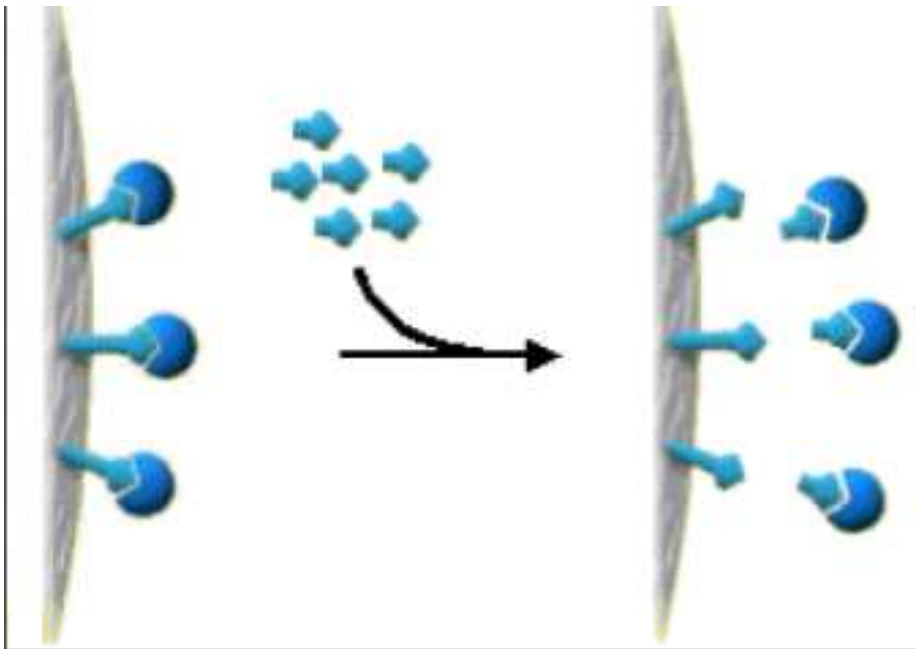

Eluce

- Eluce – neselektivní - změna pH,
iontové síly,
polarity

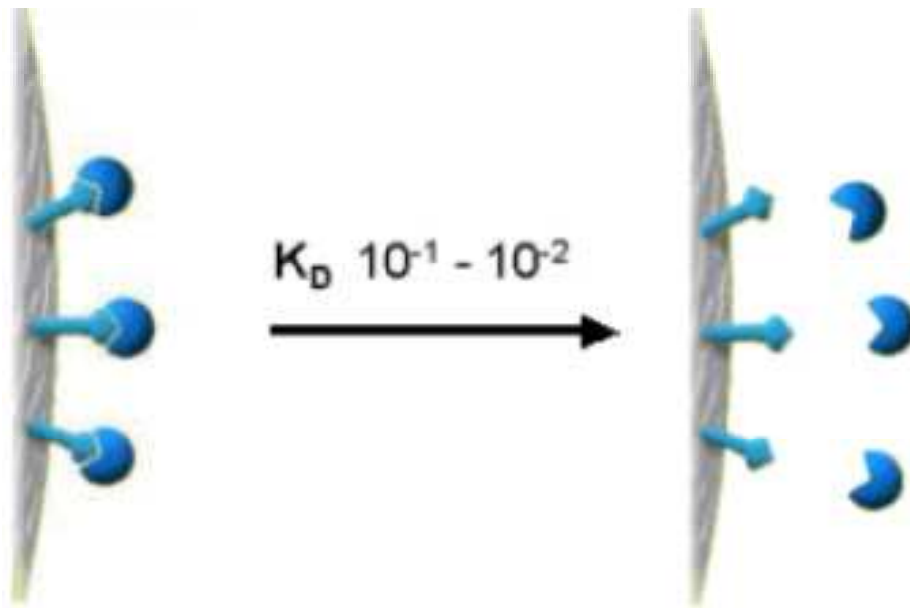

Skupinově specifické ligandy „dye ligand“

Cibacron™ Blue F3G-A
(Blue Sepharosa)

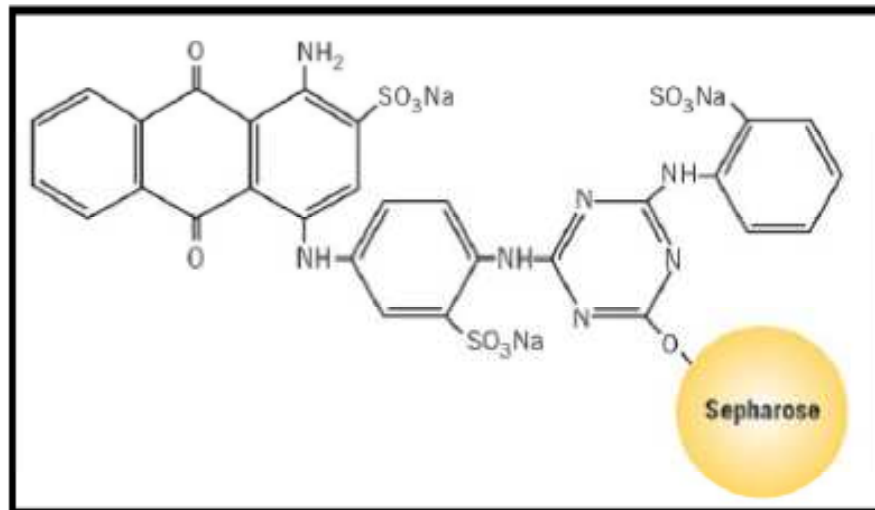

NAD^+

Dependentní dehydrogenasy

Procion™ Red
(Red Sepharosa)

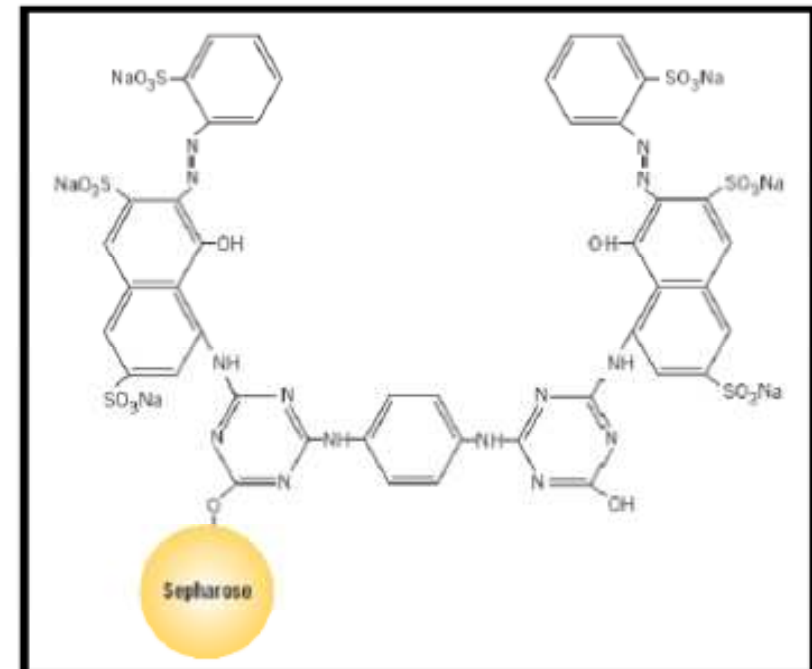

NADP^+

Skupinově specifické ligandy

Cibacron Blue F4G-A

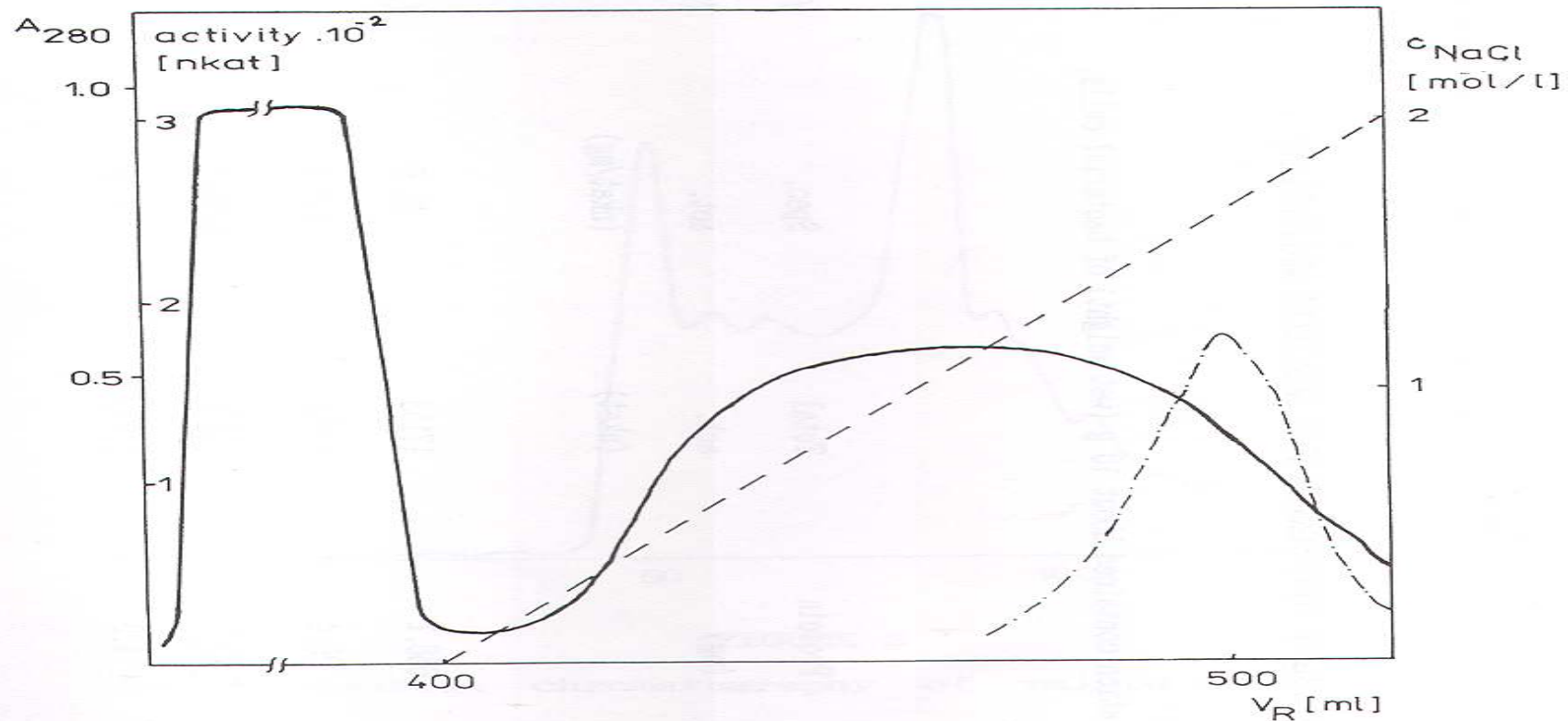
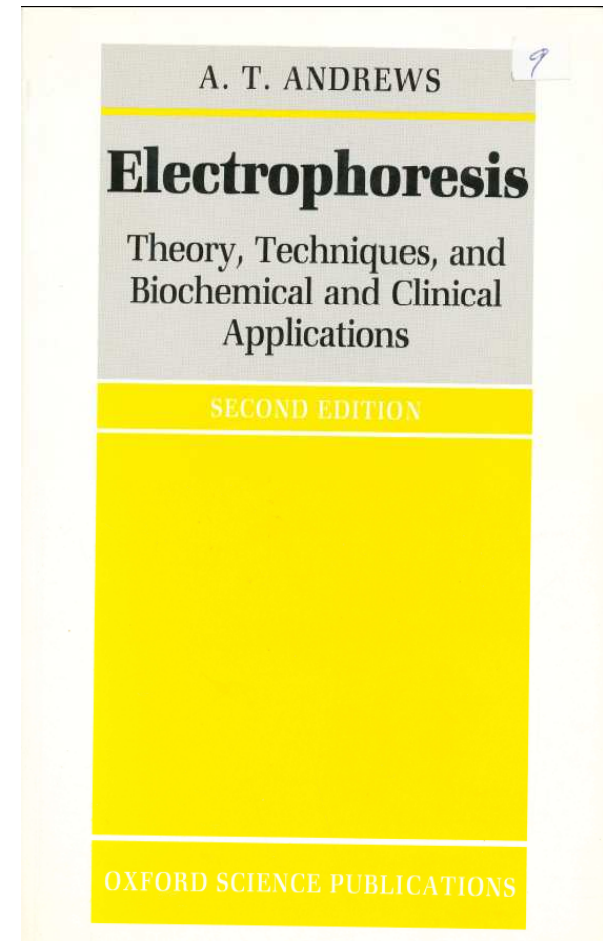
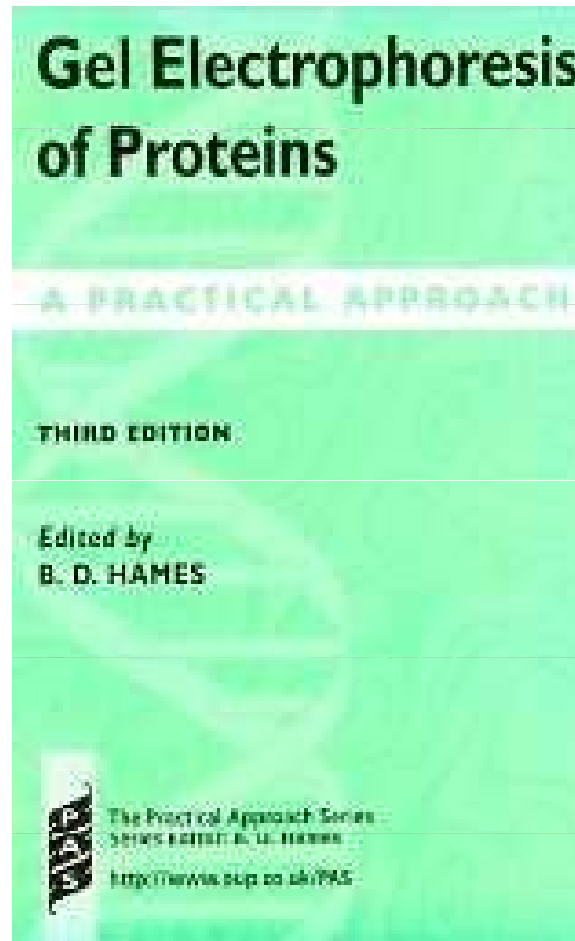
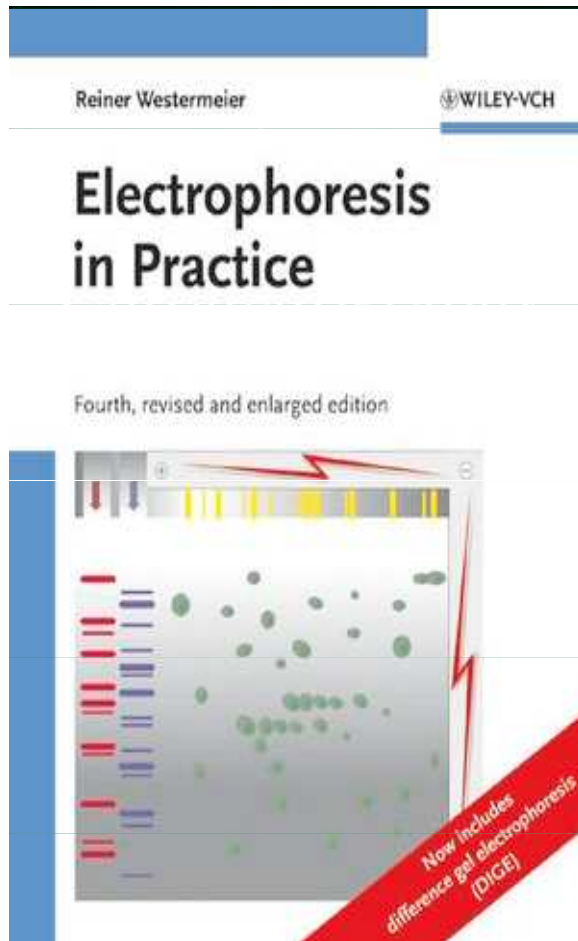

FIGURE 1

Affinity chromatography of malate dehydrogenase from *P.denitrificans* on Matrex Gel Blue A (step 2). V_e , elution volume; —, absorbance at 280 nm (A_{280}); -·-, enzyme activity; ----, NaCl gradient (buffer A, 0.02 mol/l sodium phosphate (pH 8.0); buffer B, the same as buffer A but with 1.8 mol/l NaCl and 5% ethylene glycol); flow rate, approx. 0.7 ml/min.

Elektromigrační metody

Literatura



Podstata

*„Pohyb elektricky nabitých částic
v elektrickém poli“*

Frederic Reuss

(1807)

Katoforéza

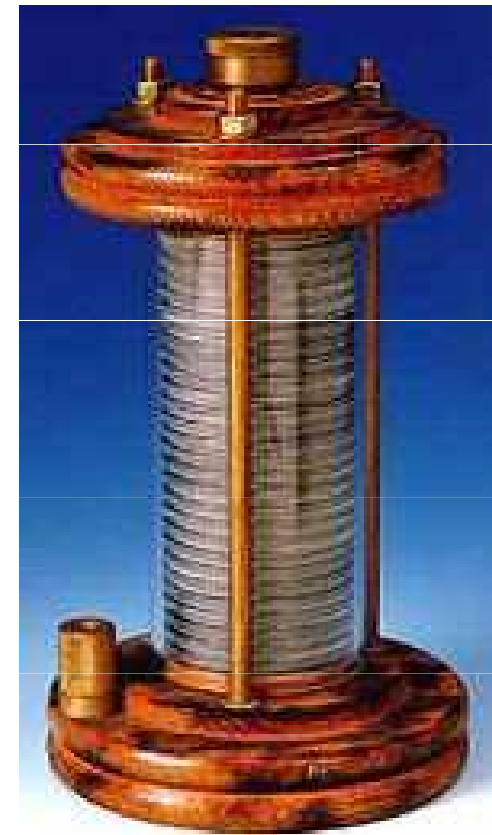
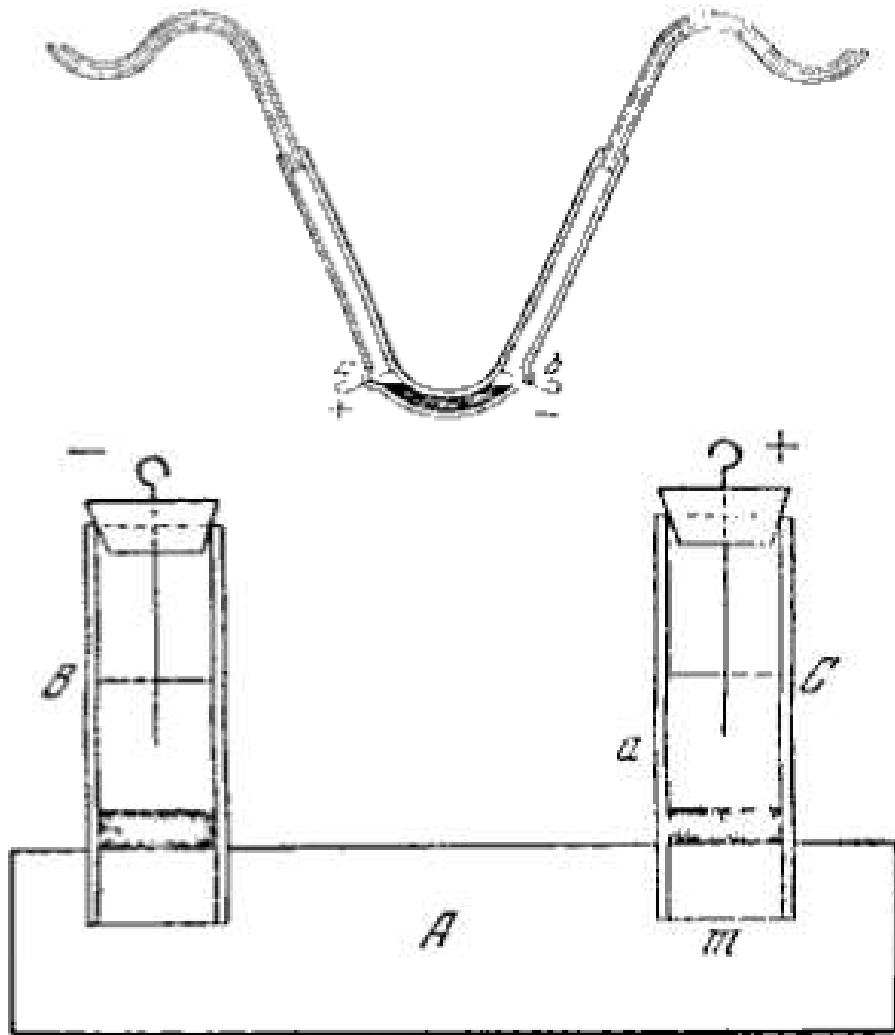

Elektroforéza

- Volná
- Zónová

Volná elektroforéza

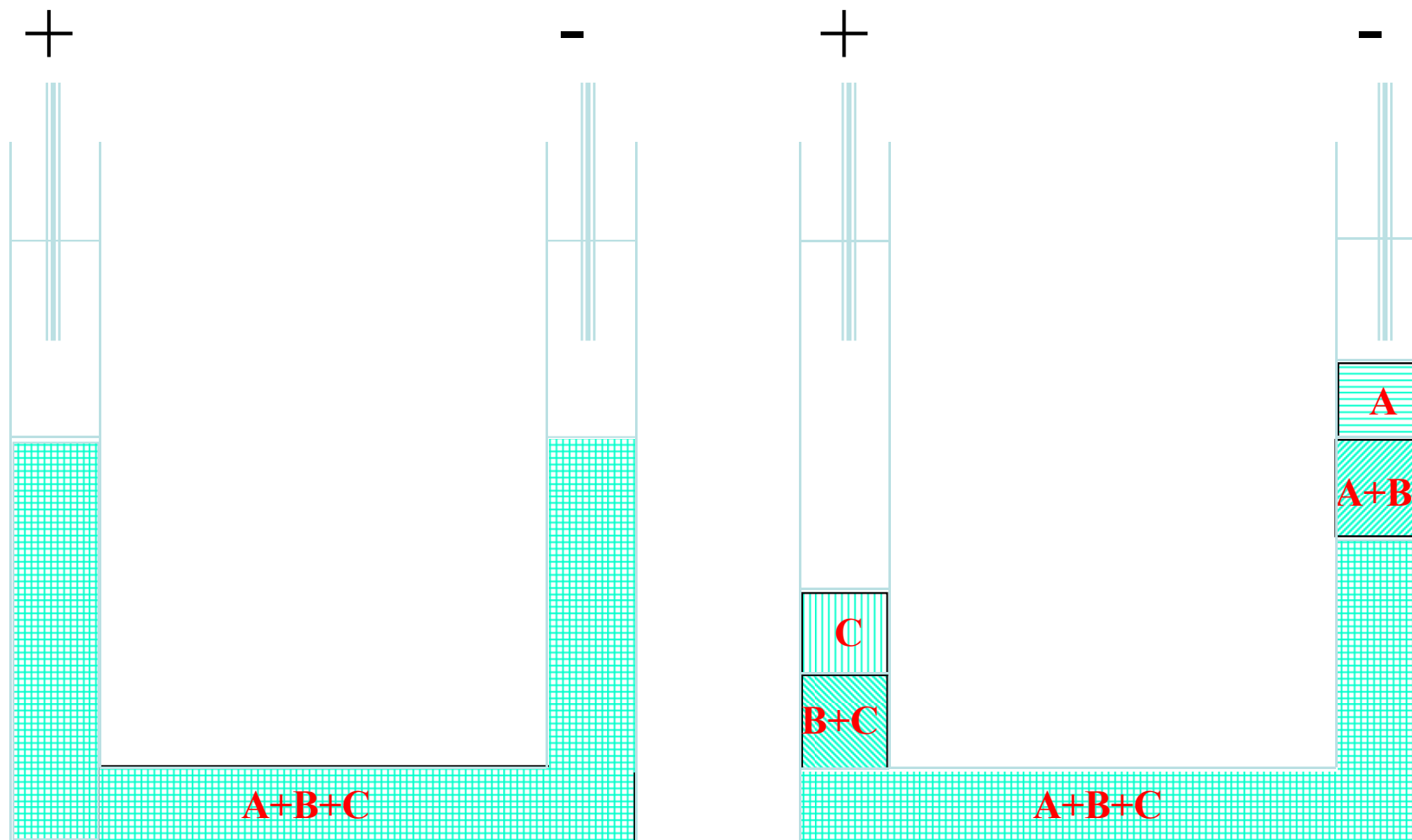

$$\mu_A > \mu_B > \mu_C$$

Volná elektroforéza

Arne Tiselius (1902 – 1971)

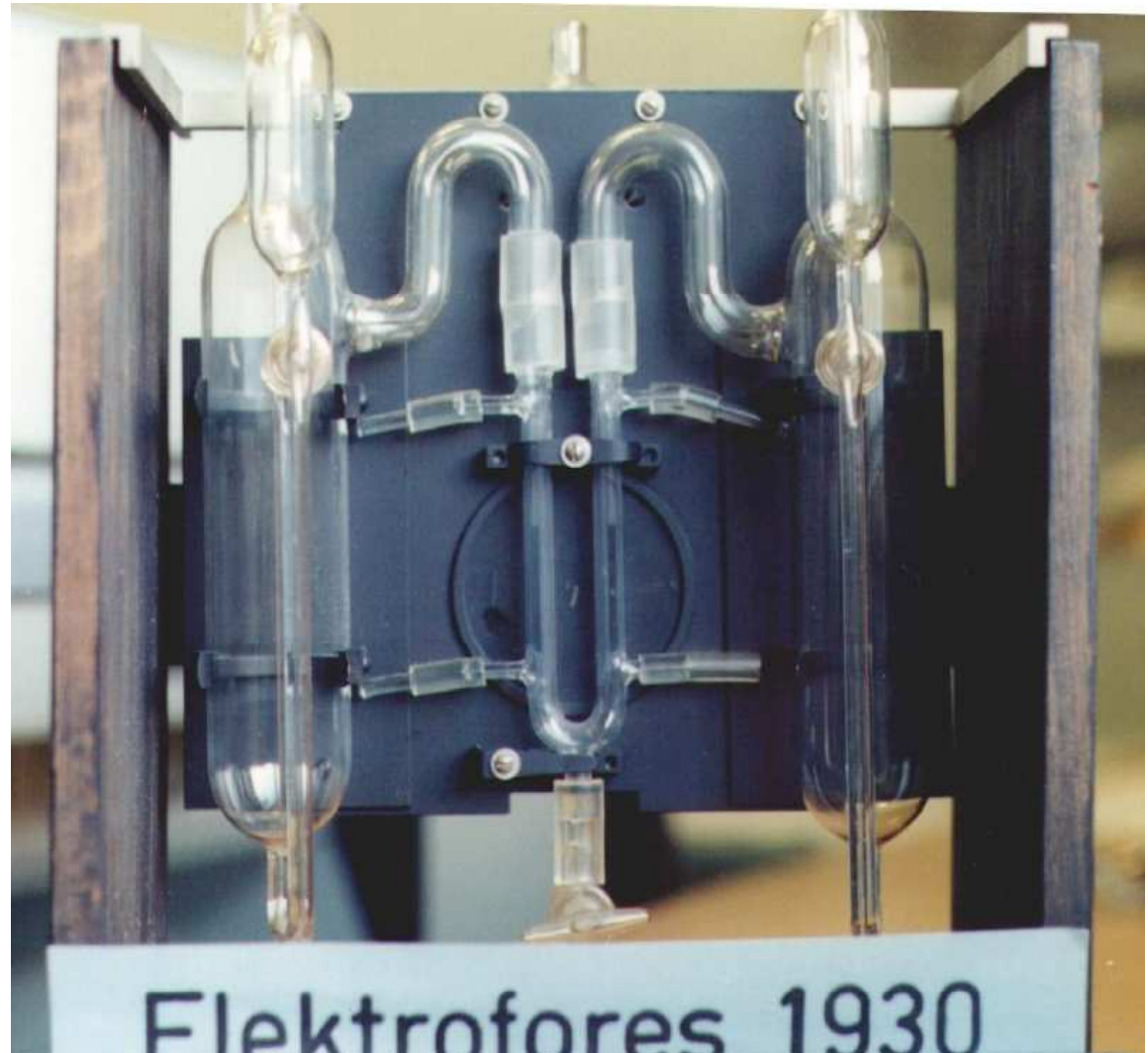

Volná elektroforéza

Arne Tiselius

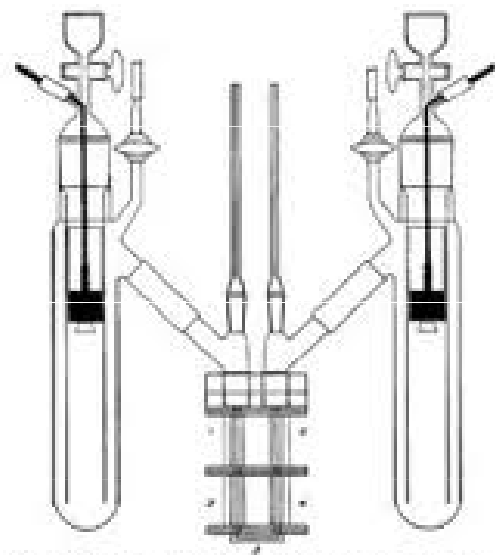
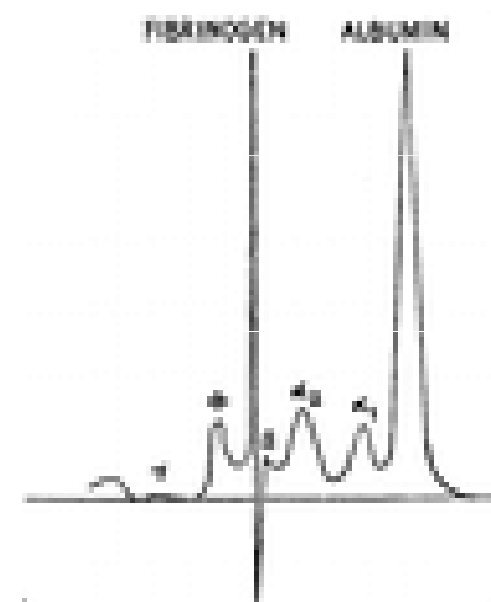

Fig. 3. Electrophoresis U-tube assembled with electrode containers for reversible electrodes.



Volná elektroforéza

Arne Tiselius (1902 – 1971)

Nobelova cena 1948



Zónová elektroforéza

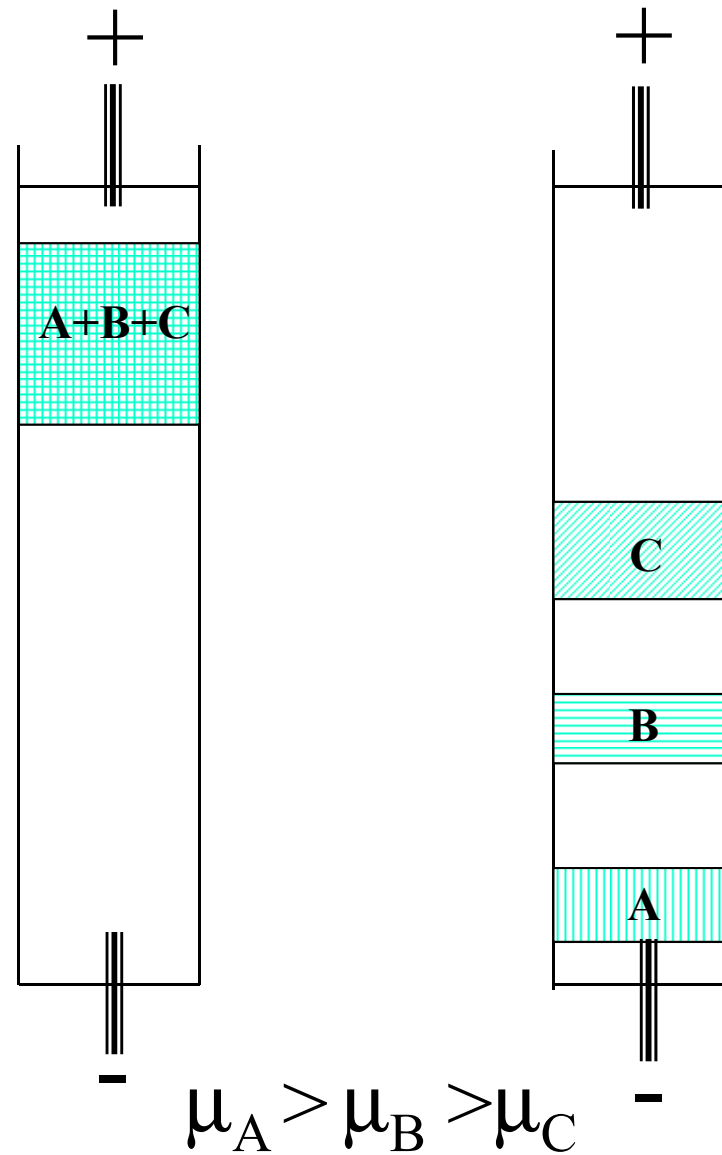

Upořádání

Horizontální



Upořádání

Vertikální

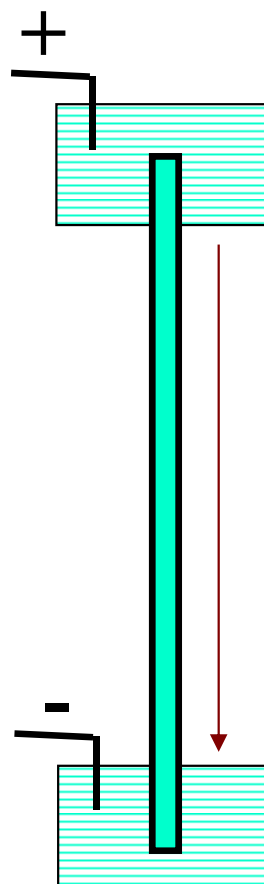

Skylab



Skylab

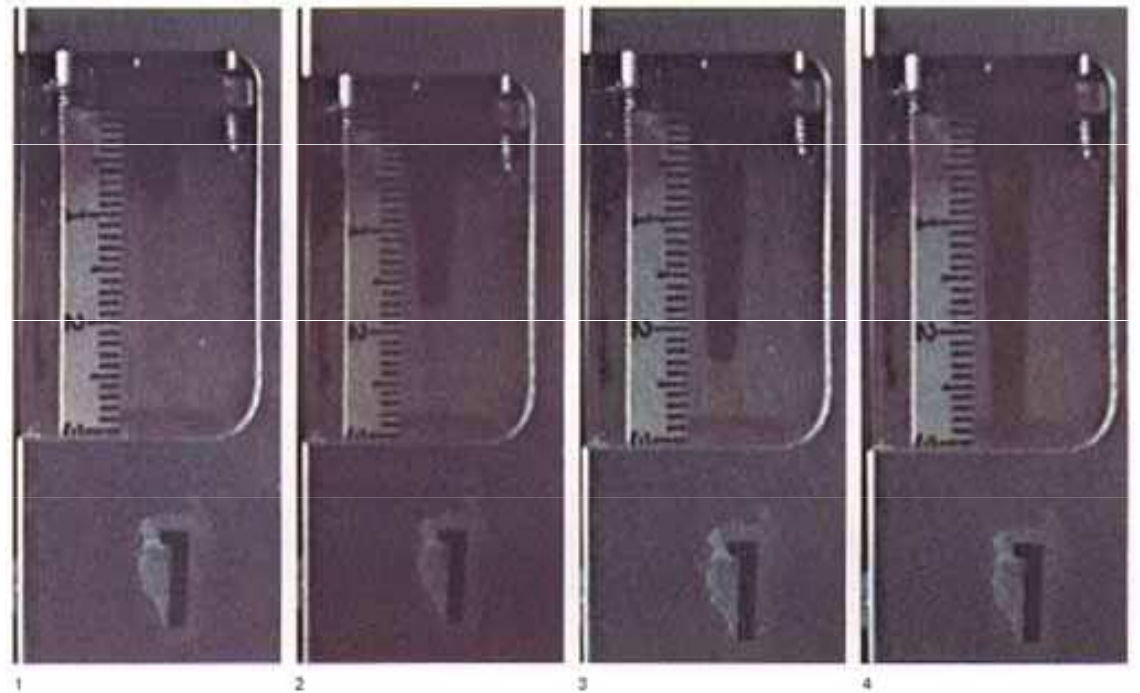
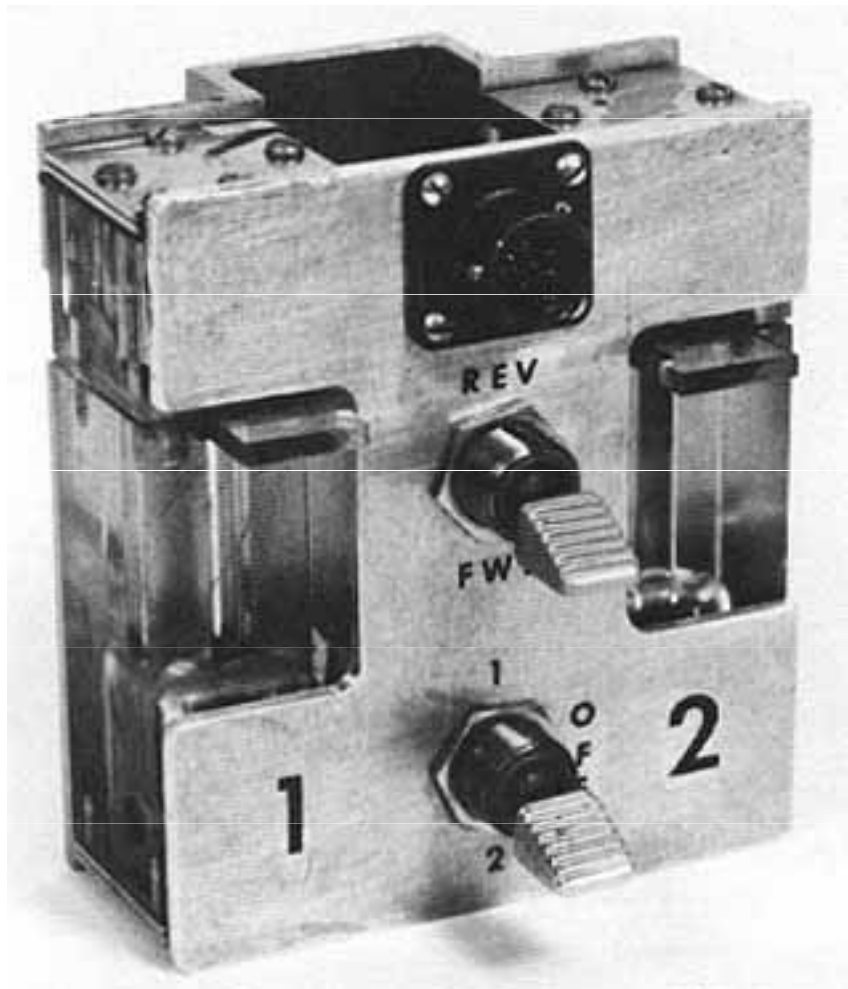

Stabilizace

- Rotací
- Gradienty hustoty
- Porézními medii
- Kapilárou

Porézní media

- 1939 *Papír*
- 1950 *Agarový gel*
- 1955 *Škrobový gel*
- 1957 *Acetát celulosy*
- 1959 *Polyacrylamidový gel*
- 1979 *Agarosový gel*

Polyakrylamid

Složení – kopolymer akrylamidu a
N,N,- methylenbisakrylamidu

+ plně splňuje požadavky

- **Monomery jsou neurotoxiny !!!!!!!**

Použití : analýza bílkovin

Polyakrylamid

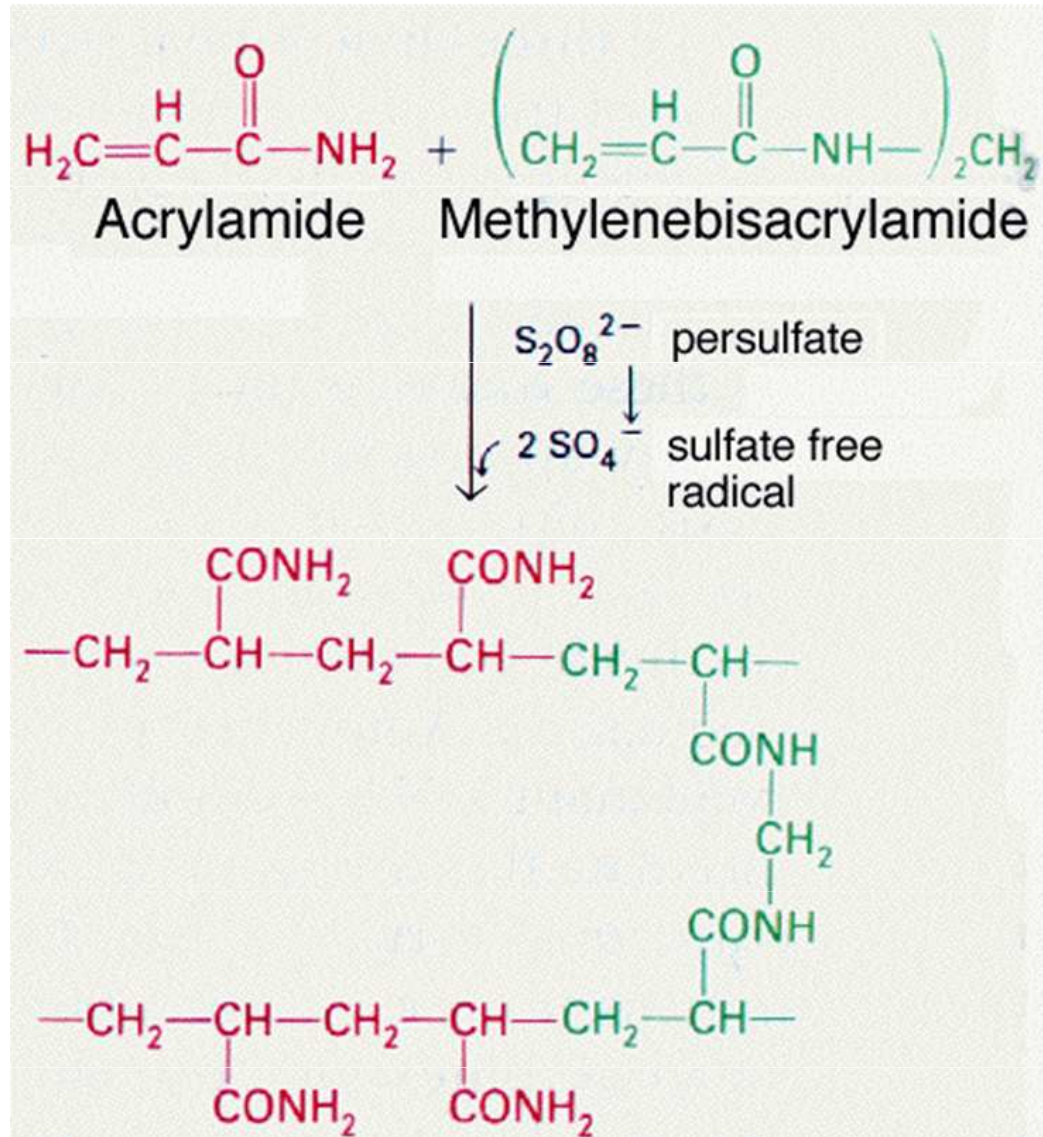

SDS PAGE

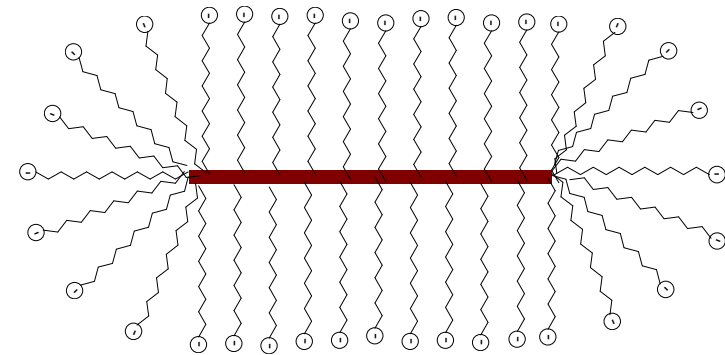
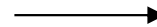
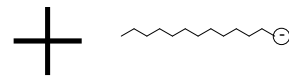
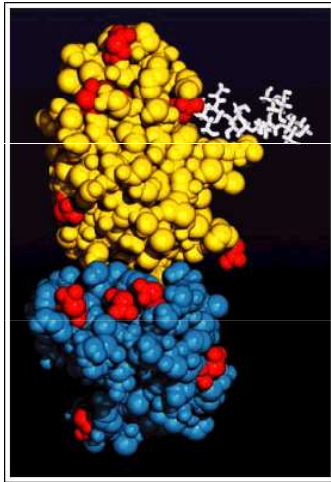
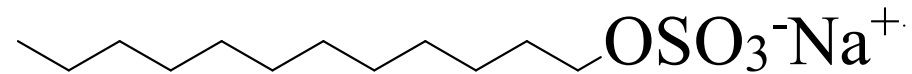

1 g bílkoviny váže 1.4 g SDS \Rightarrow
uniformní náboj na jednotku MW

SDS PAGE

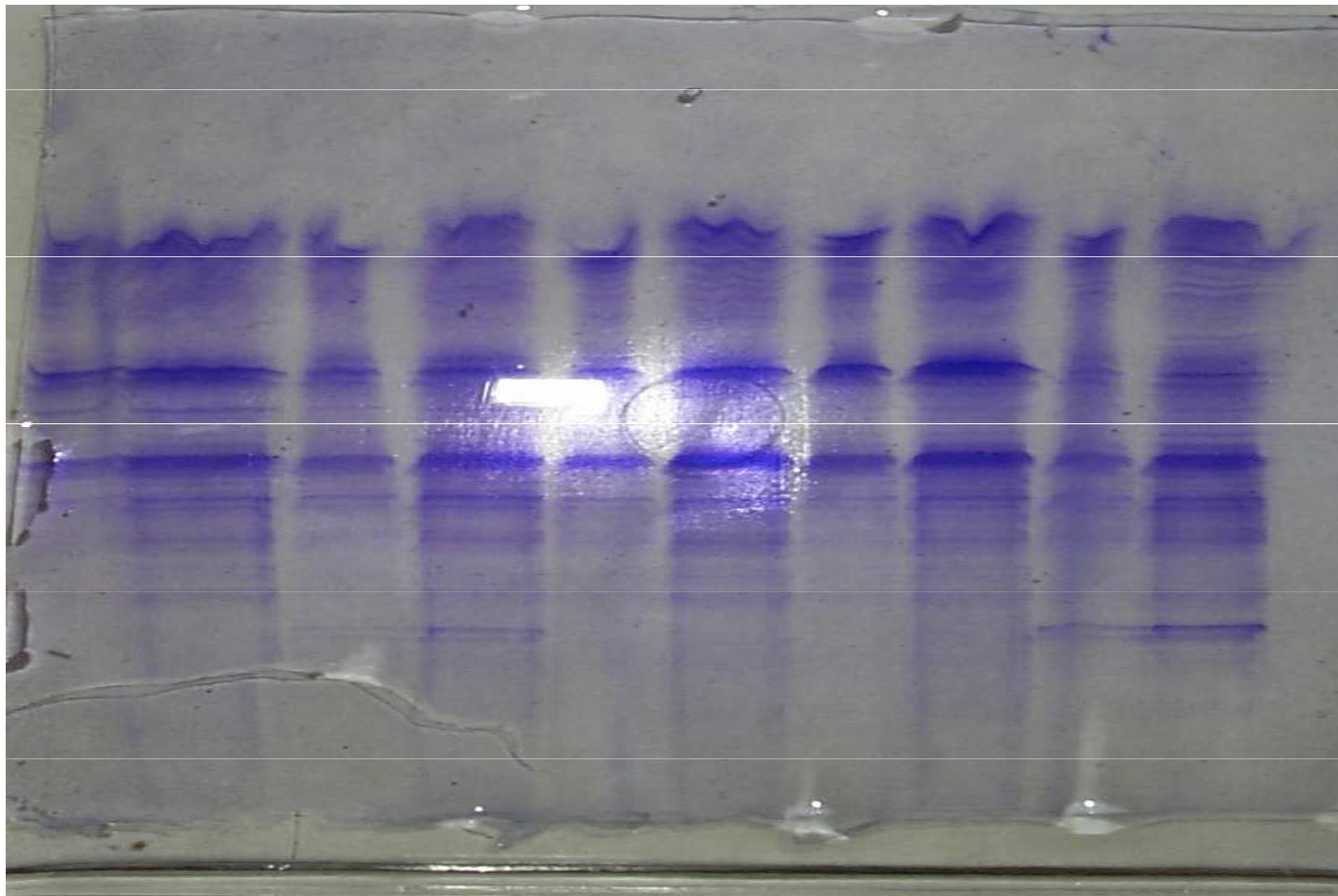

Použití SDS PAGE

- Stanovení Mr
- Analýza komplexních směsí
- Sledování purifikace bílkovin
- Stanovení podjednotkového složení

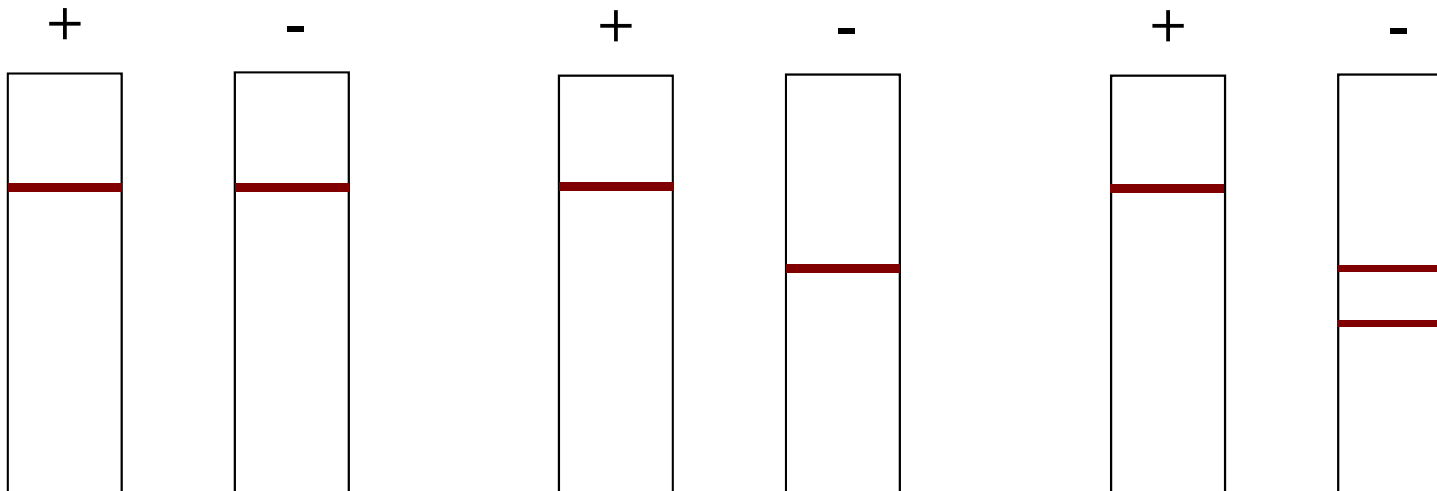

Stanovení Mr pomocí SDS PAGE

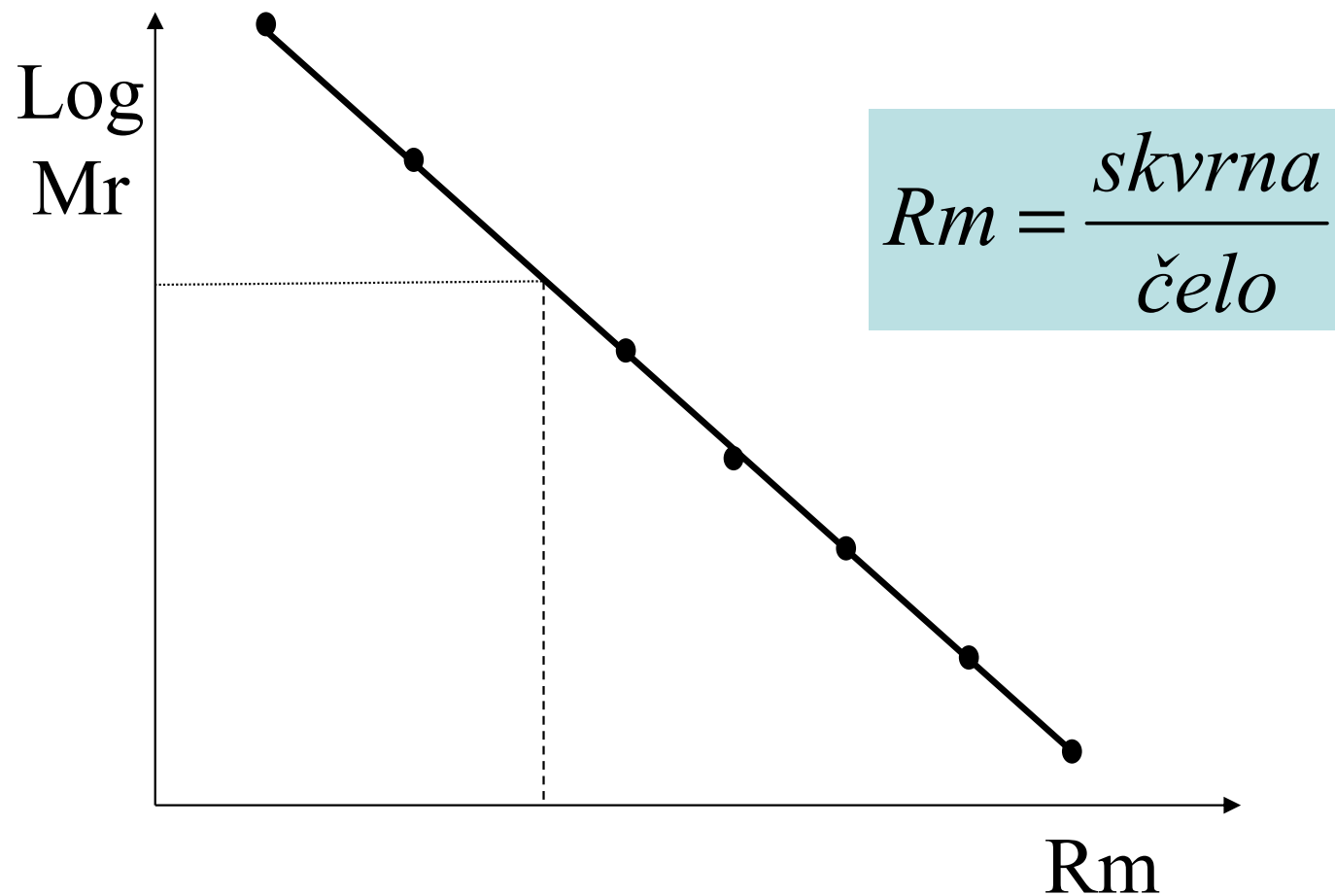

Stanovení Mr pomocí SDS PAGE - standardy

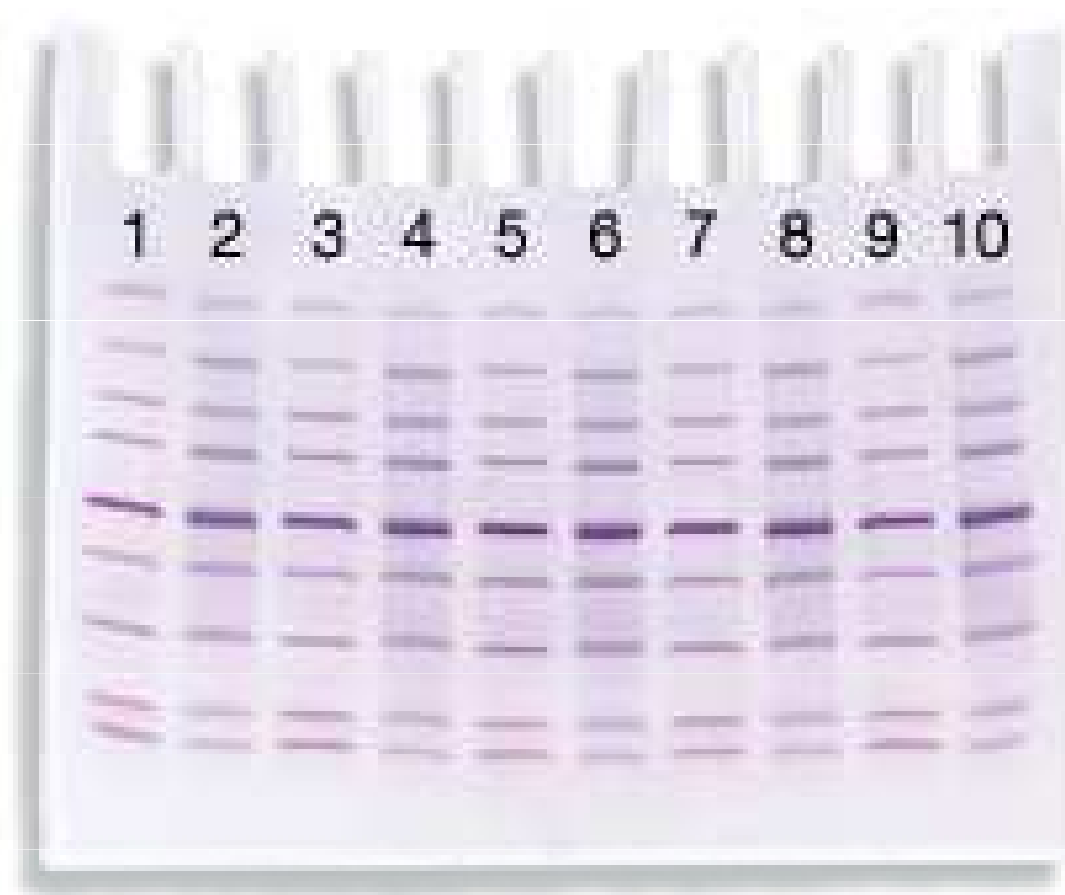

Izoelektrická fokusace

„Elektroforéza v gradientu pH, částice jsou separovány podle svých pI“

Izoelektrická fokusace

1961 Svensson – Rilbe (1968)



Izoelektrická fokusace

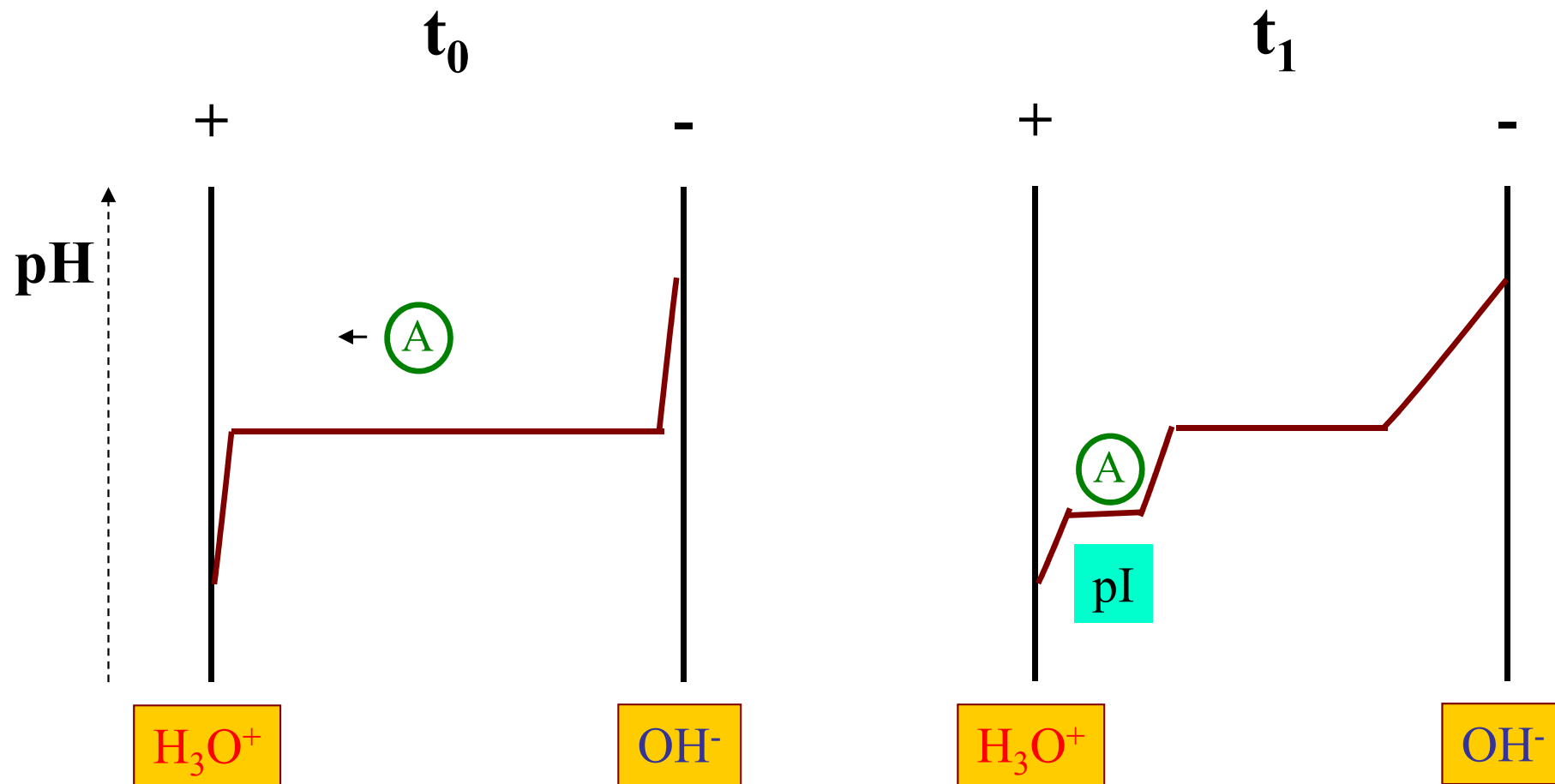

Izoelektrická fokusace

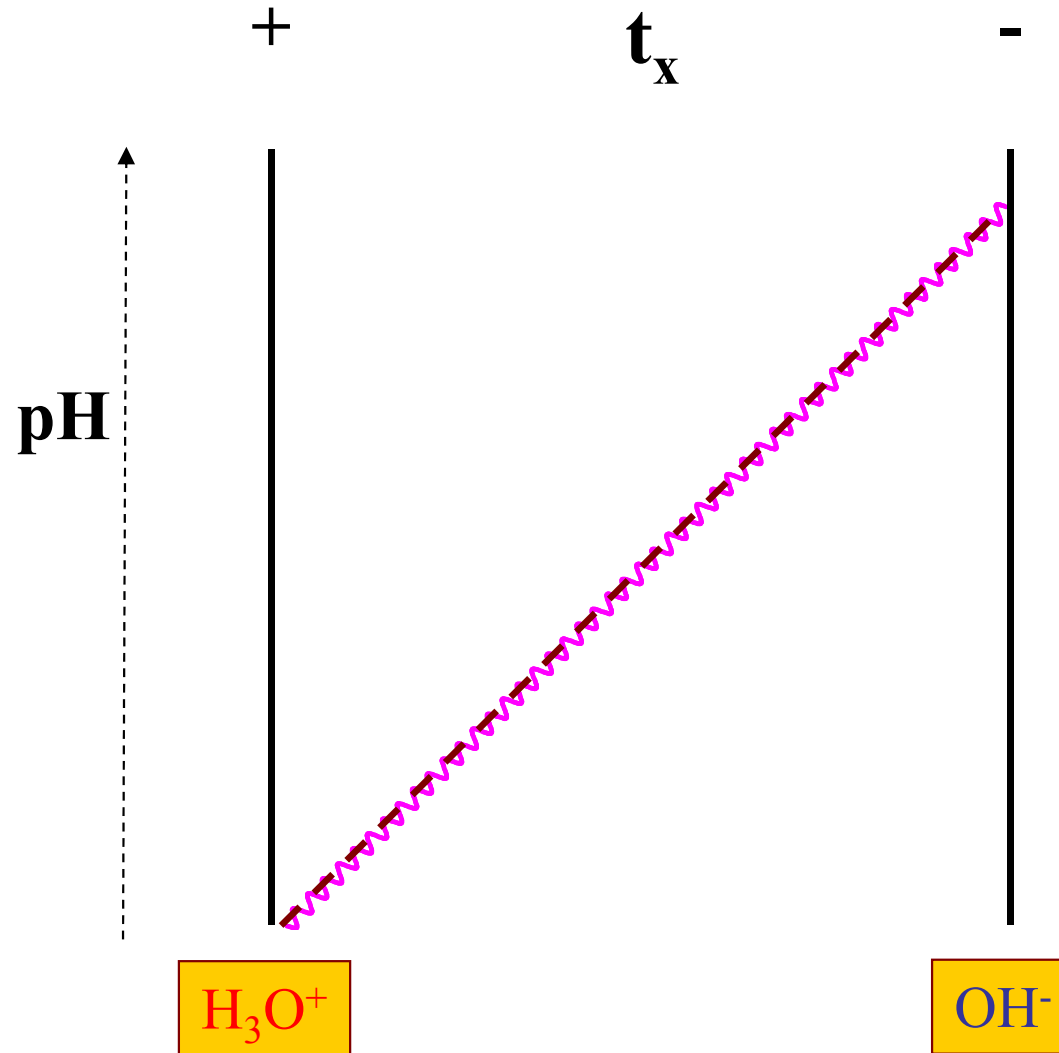

Izoelektrická fokusace analytická

- Provedení - v gelech – PAGE, agarosa
- Použití - sledování komplexních směsí
 - izoenzymové složení
 - stanovení pI – rozřezání a eluce
 - μpH elektrody
 - pI standardy

Izoelektrická fokusace analytická

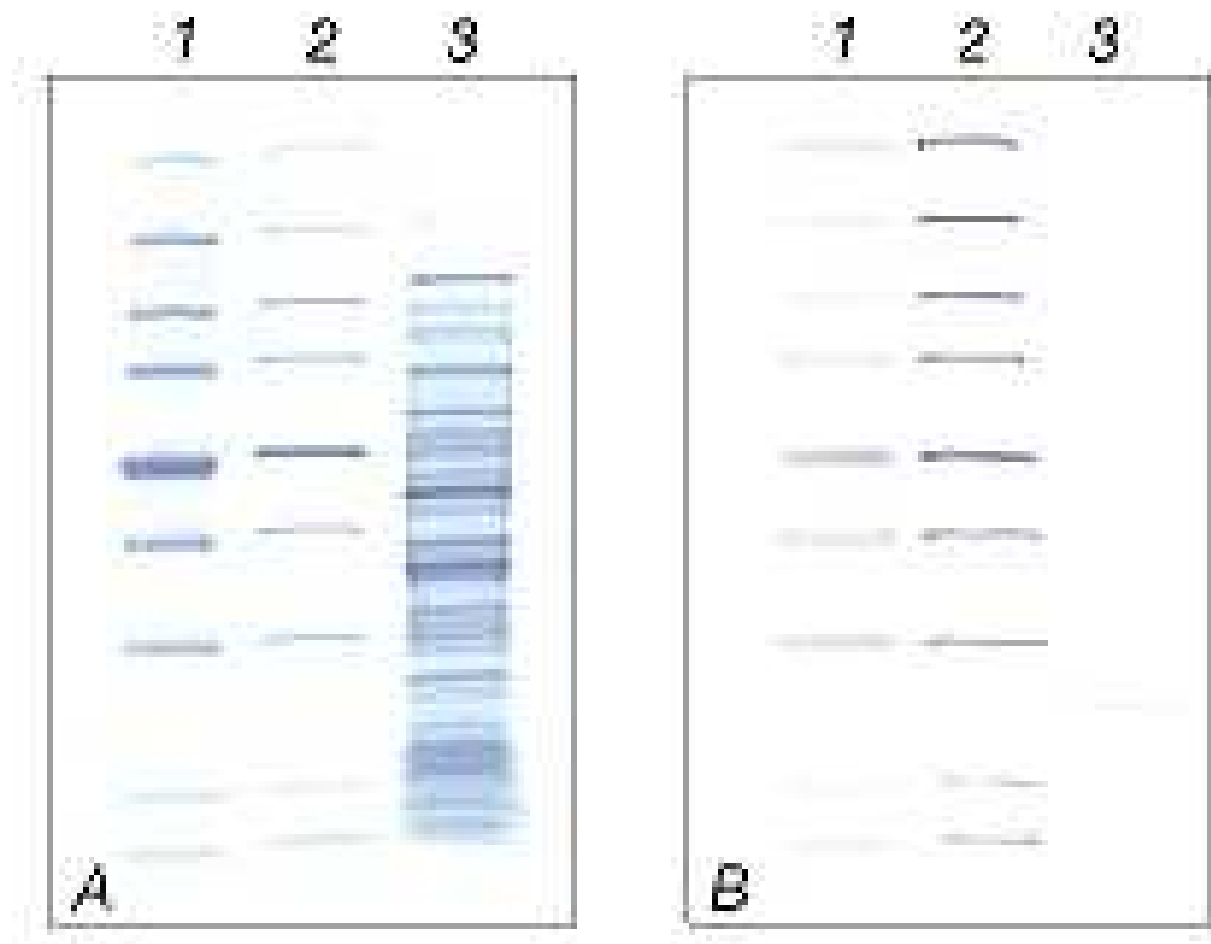

Dvojrozměrná elektroforéza

1975 O'Farrell

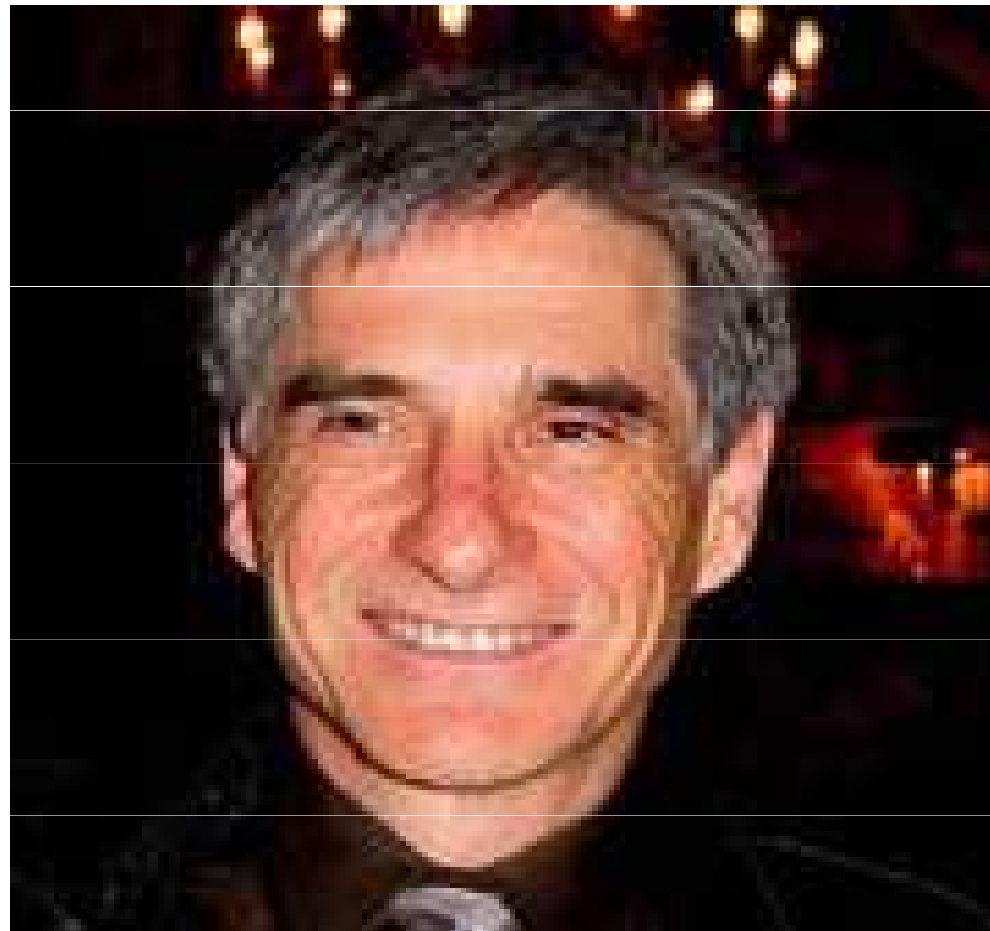

Dvojrozměrná elektroforéza

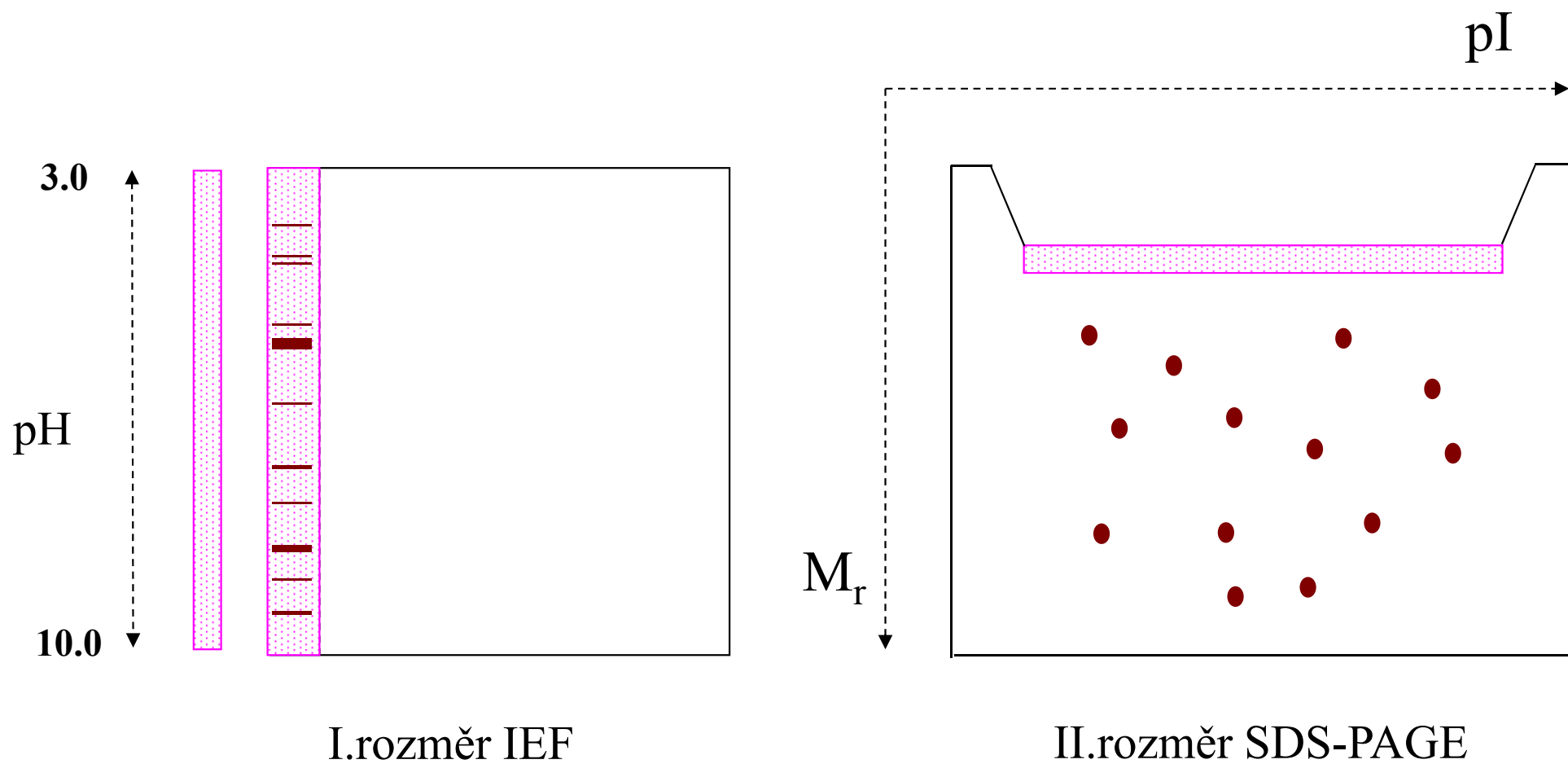

Studium procesů probíhajících v živých organismech

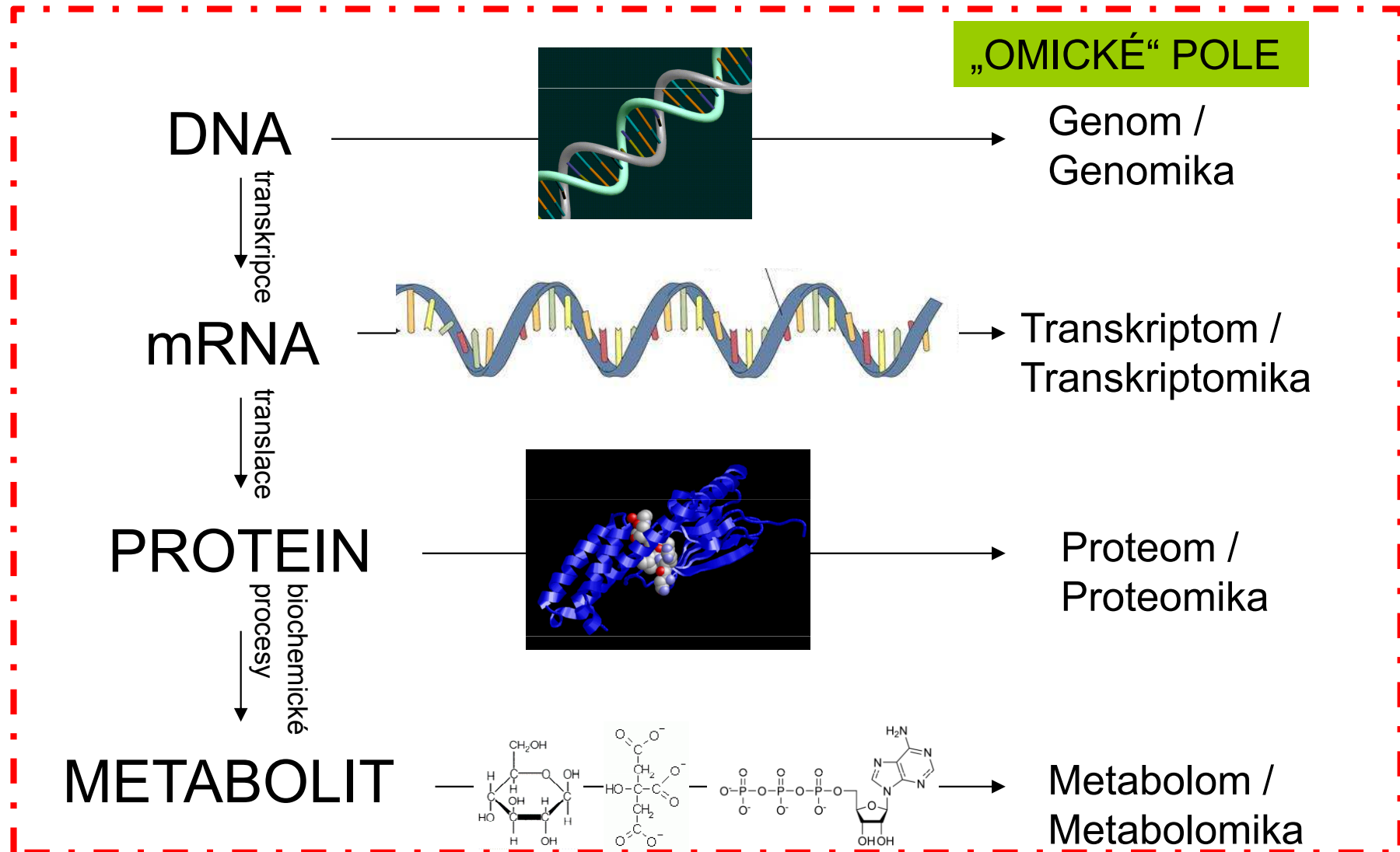

Systemová biologie

Systemová biologie

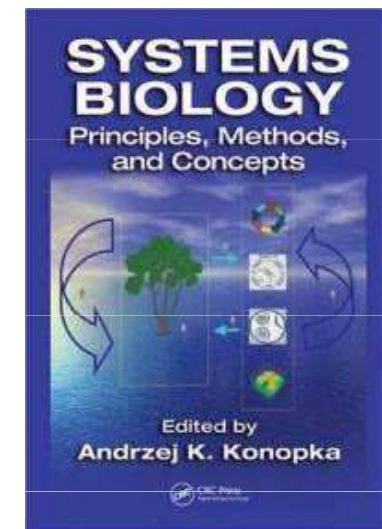
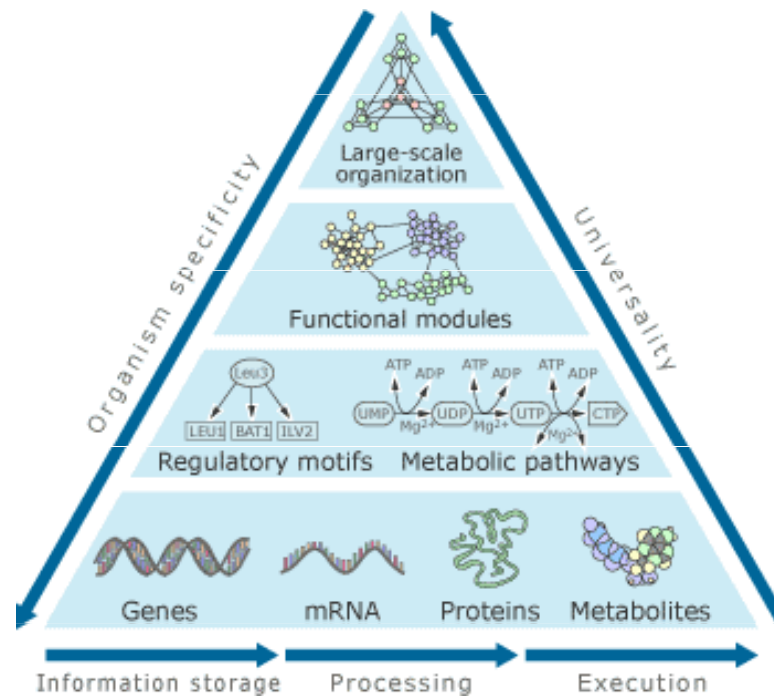

Systemová biologie

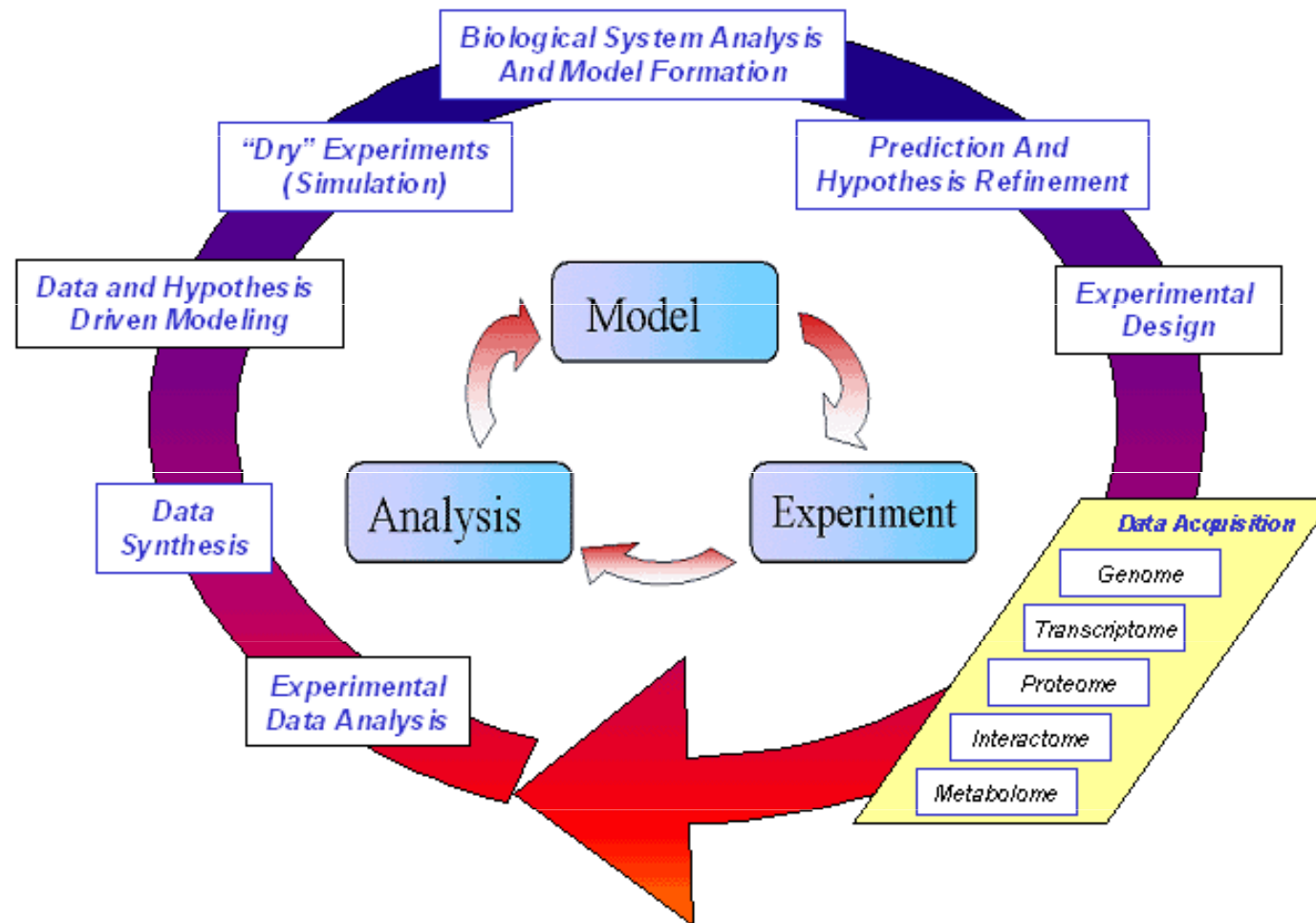



PROTEIN

J. J. Berzelius 1838

Proteios

PROTEOMIKA

Marc Wilkins 1994

PROTEOM

Kompletní sada bílkovin přítomných v daném okamžiku v buňce, nebo tkáni, zahrnující veškeré jejich modifikace, vzájemné interakce, lokalizaci a metabolický obrat.

PROTEOMIKA

- **kvantitativní a kvalitativní charakterizace úplné sady bílkovin organely, buněčné linie, tkáně nebo organismu**
- **kvantitativní a kvalitativní porovnání proteomů za různých podmínek**

Literatura

Click to **LOOK INSIDE!**

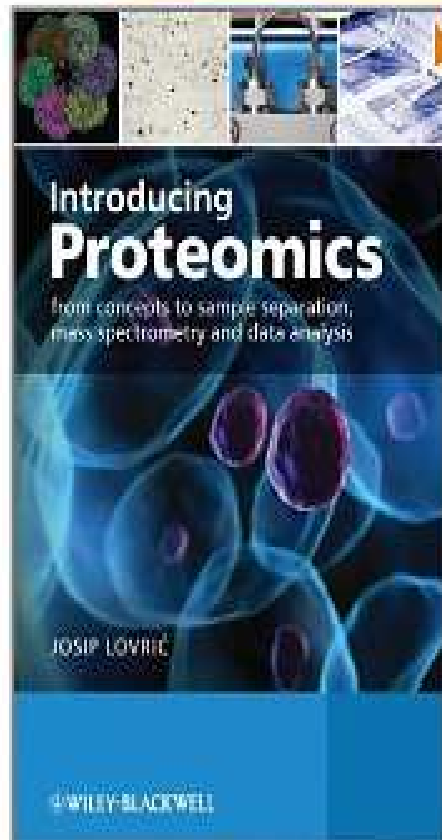

Click to **LOOK INSIDE!**

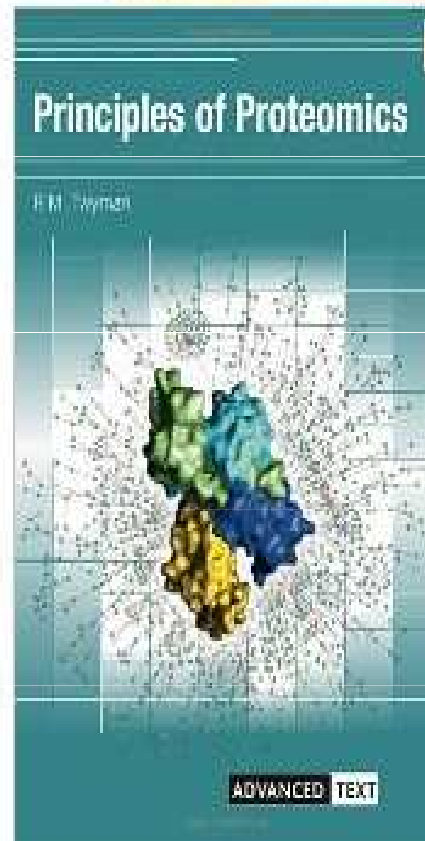

Click to **LOOK INSIDE!**

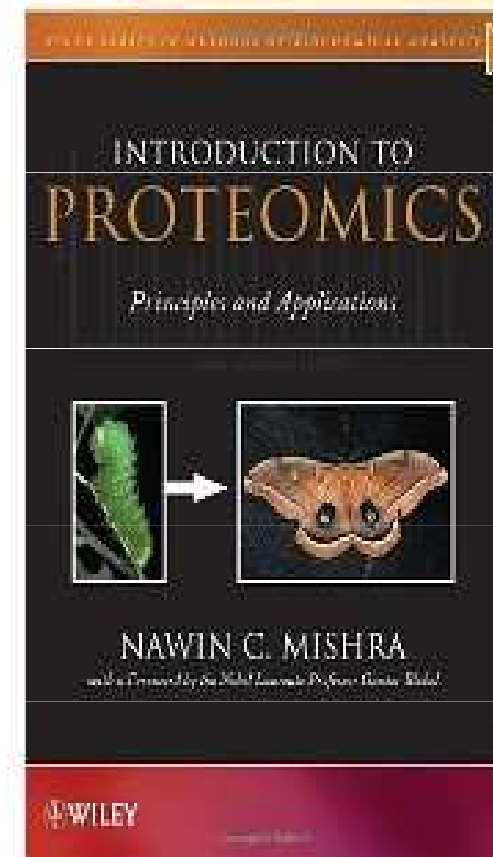

Cíl proteomiky

- Cílem je nejen identifikovat všechny bílkoviny, ale zároveň pochopit jejich funkci a strukturu a vytvořit 3D mapu buňky (určit lokalizaci jednotlivých bílkovin).

Proč proteomika když máme genomiku ?

- nelze určit funkci proteinu na základě sekvence DNA nebo mRNA
- nelze popsat molekulární mechanismy pomocí studia genomu
- 200 typu posttranslačních modifikací
- existuje alternativní translace
- !!!! špatná korelace hladin mRNA a skutečných hladin bílkovin !!!

PROTOŽE PROTEINY A NIKOLIV GENY VYTVÁREJÍ FENOTYP !



JEDEN GENOM
DVA PROTEOMY



JEDEN GEN, MNOHO BĚLKOVIN

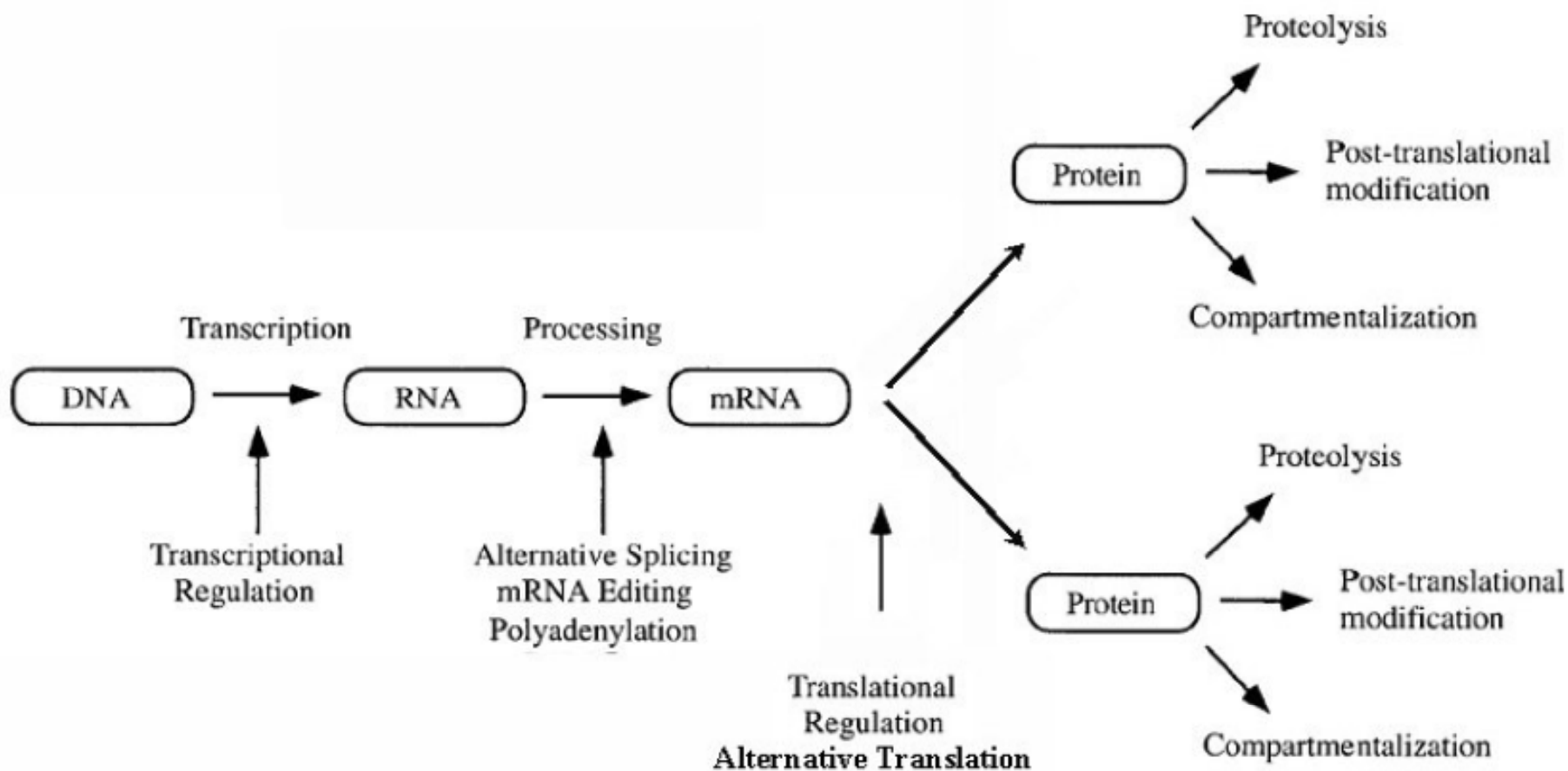

Cca 25-30 000 genů



Několik set tisíc bílkovin

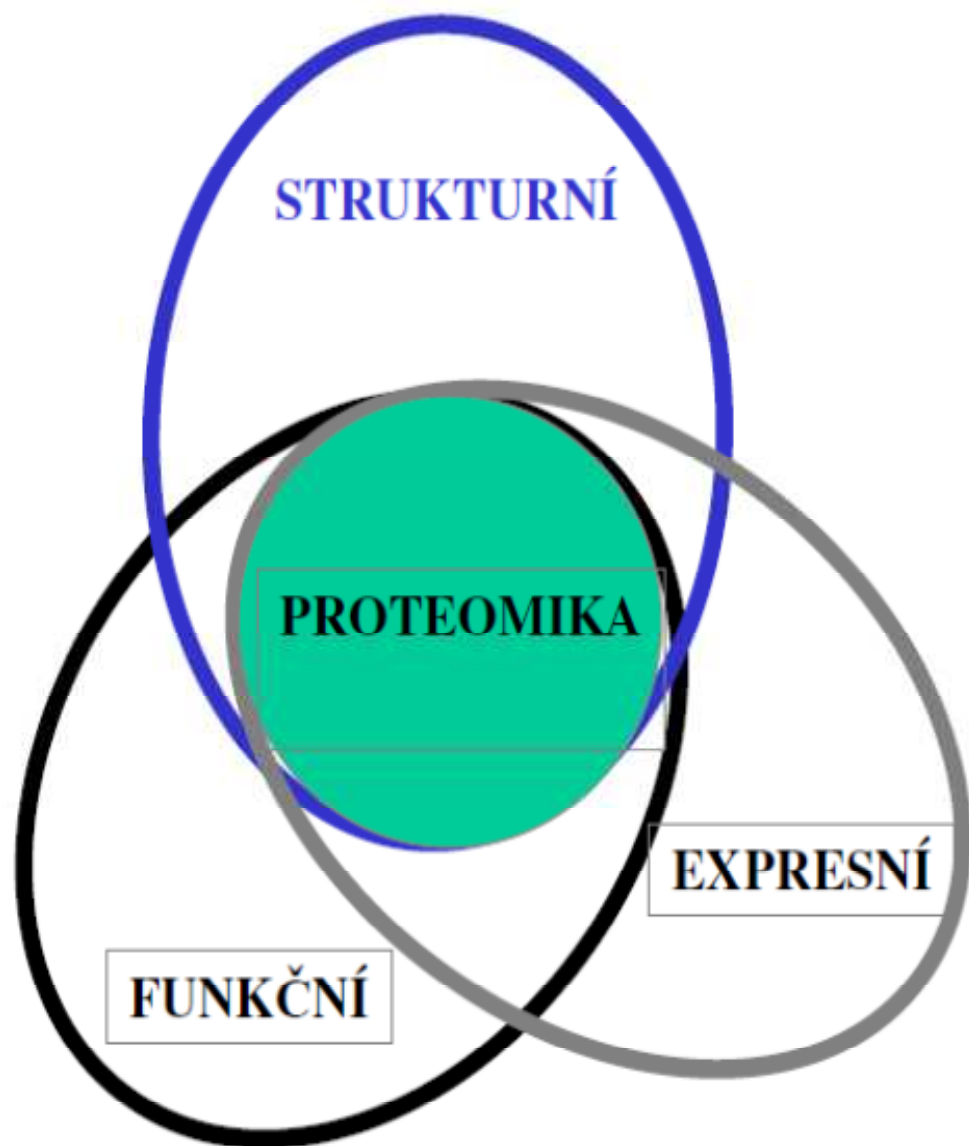

Aplikace proteomiky v medicíně (proteomika nemocí)

Úloha proteinů ve vzniku nemocí

Exprese proteinů u nemocí

Biomarkery nemocí

Detekce proteinů vznikajících během nemoci je využita k diagnóze

Alzheimerova choroba (amyloid β)

Srdeční onemocnění (interleukin-6 a 8, sérový amyloid A, fibrinogen, troponiny)

Renální buněčný karcinom (karbonanhydrasa IX)

Vývoj nových léků

Informace o proteinech způsobující onemocnění je využita pro vývoj nových léků

1. Známa 3D struktura proteinu-počítačová simulace-hledání léku, který inhibuje patologický protein (HIV-1 proteasa)

2. Genetické odlišnosti mezi lidmi-odlišný proteom-vývoj individuálních léků

Základní schéma analýzy užívané v proteomice

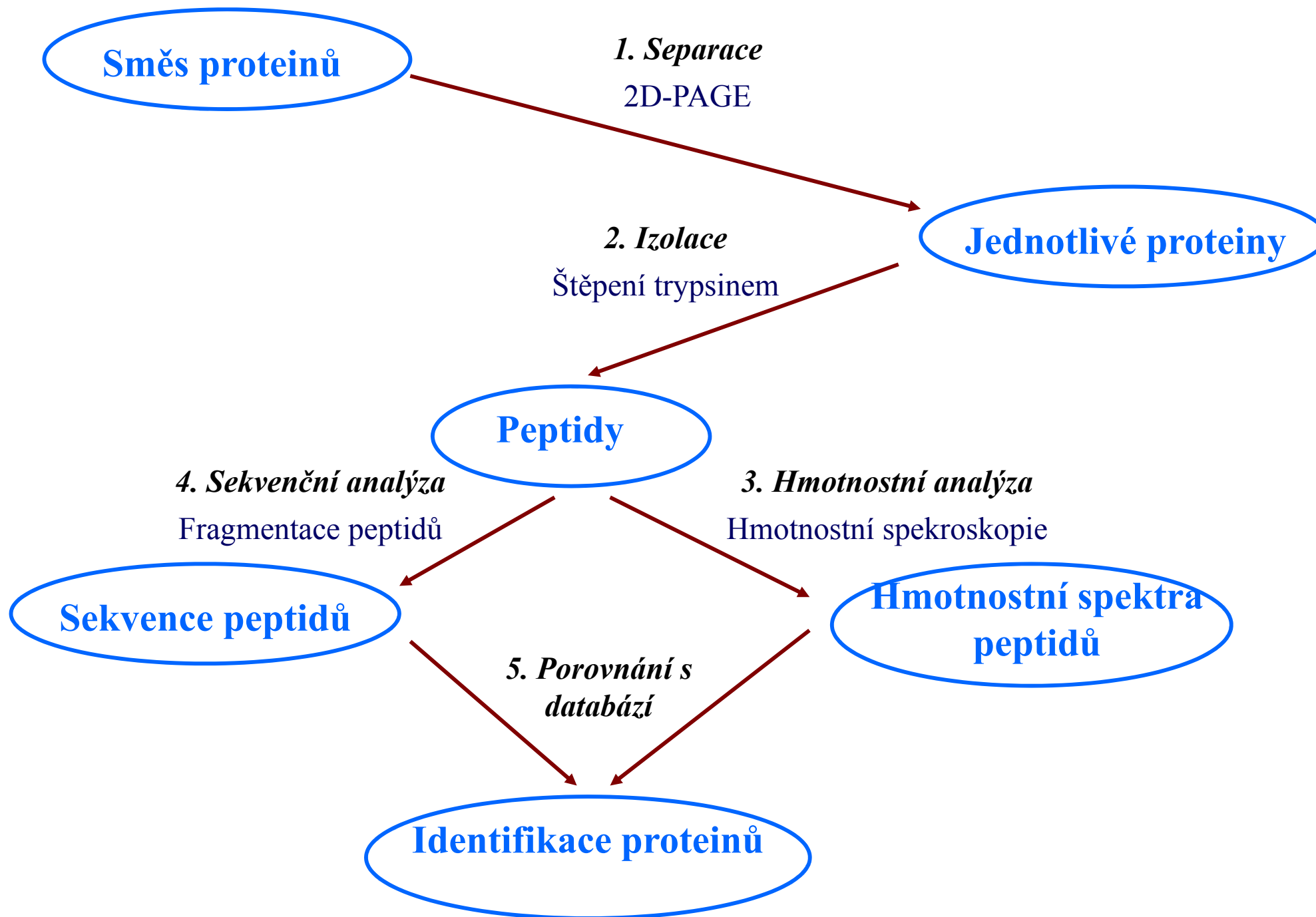

Dvojrozměrná elektroforéza

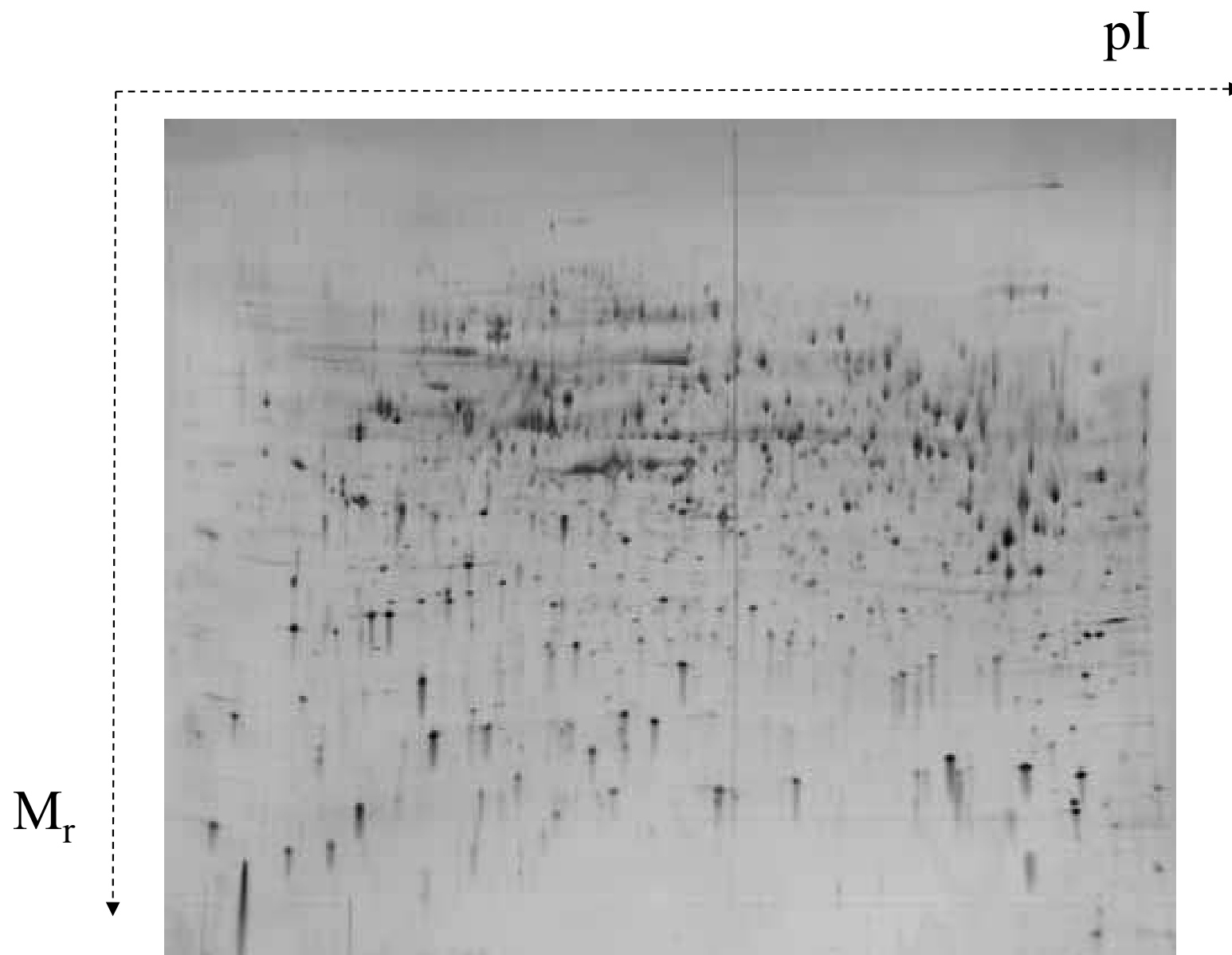

CompuGen Z3 DeskTop v.1.11.Beta

File Edit Image Spots Align View Analysis Window Log Help

[1st] 2small [2nd] 1small

Layered View: 2small vs. 1small

Matching Data Table

The gels in the table are enumerated as follows:

1. 2small
2. 1small

ID	X1	Y1	RE1	X2	Y2	RE2	std	baseline
1016	346	39	6031	337	43	11053	2511.0	0.508
1022	255	45	3712	250	51	3745	16.5	0.009
1023	242	48	2206	237	53	2921	357.5	0.279
1024	119	49	584	125	53	1076	246.0	0.593
1025	100	50	3290	108	54	4738	724.0	0.361
1027	183	50	2104	183	53	3515	705.5	0.502
1029				35	52	1150		
1030	221	52	5409	217	56	4496	456.5	-0.184
1032				264	52	4886		
1033				275	52	1422		
1034	147	53	3078	151	59	1281	898.5	-0.625
1038	290	56	1992					
1040				35	57	1006		

[142, 129] -> [1st: 127 2nd: 184]

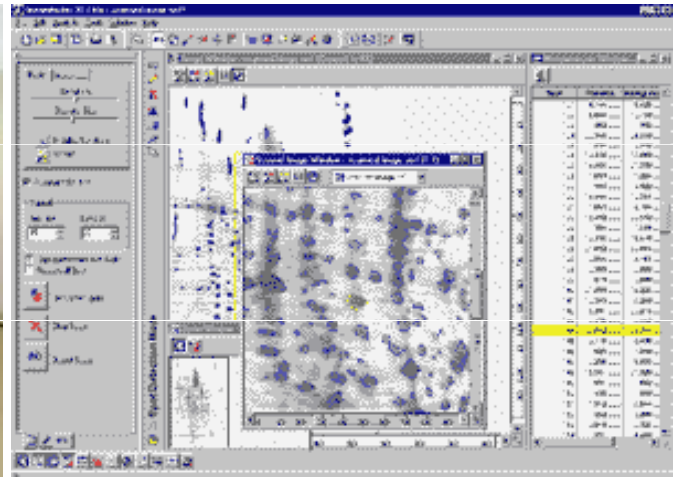

PEPTIDOVÉ MAPOVÁNÍ (PEPTIDE MASS FINGERPRINT)

Identifikace proteinů peptidovým mapováním (MALDI TOF)

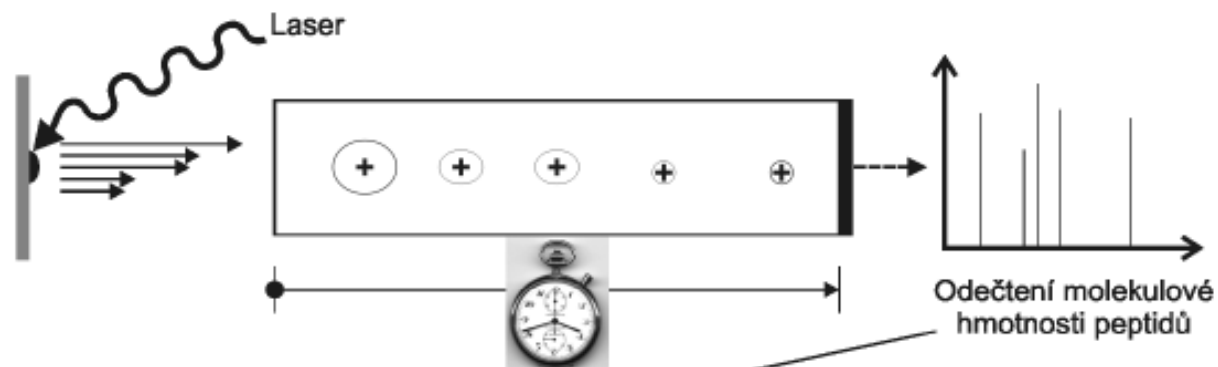

1059.5	Vyhledání v databázích	1059.5111 (K)KPAEDEWGK (T)	➔	Ferritin (lehká podjednotka)
1491.7		1491.7232 (R)DDVALEGVSHFFR (E)		
1591.8		1607.8069 (R)LGGPEAGLGEYLFER (L)		
1607.8		2359.0916 (R)TDPHLCDFLETHFLDEEVK (L)		
2359.0				

SSQIRQNYSTDVEAAVNSLVNLYLQASYTYLSLGFYFDRDDVALEGVSHFFRELAEKREG
YERLLKMQNQRRGGRALFQDIKKPAEDEWGTKTPDAMKAAMALEKKLNQALLDLHAL
GSARTDPHLCDFLETHFLDEEVKLIKKMGDHLTNLHRLGGPEAGLGEYLFERLTLKHD

FRAGMENTACE PEPTIDU

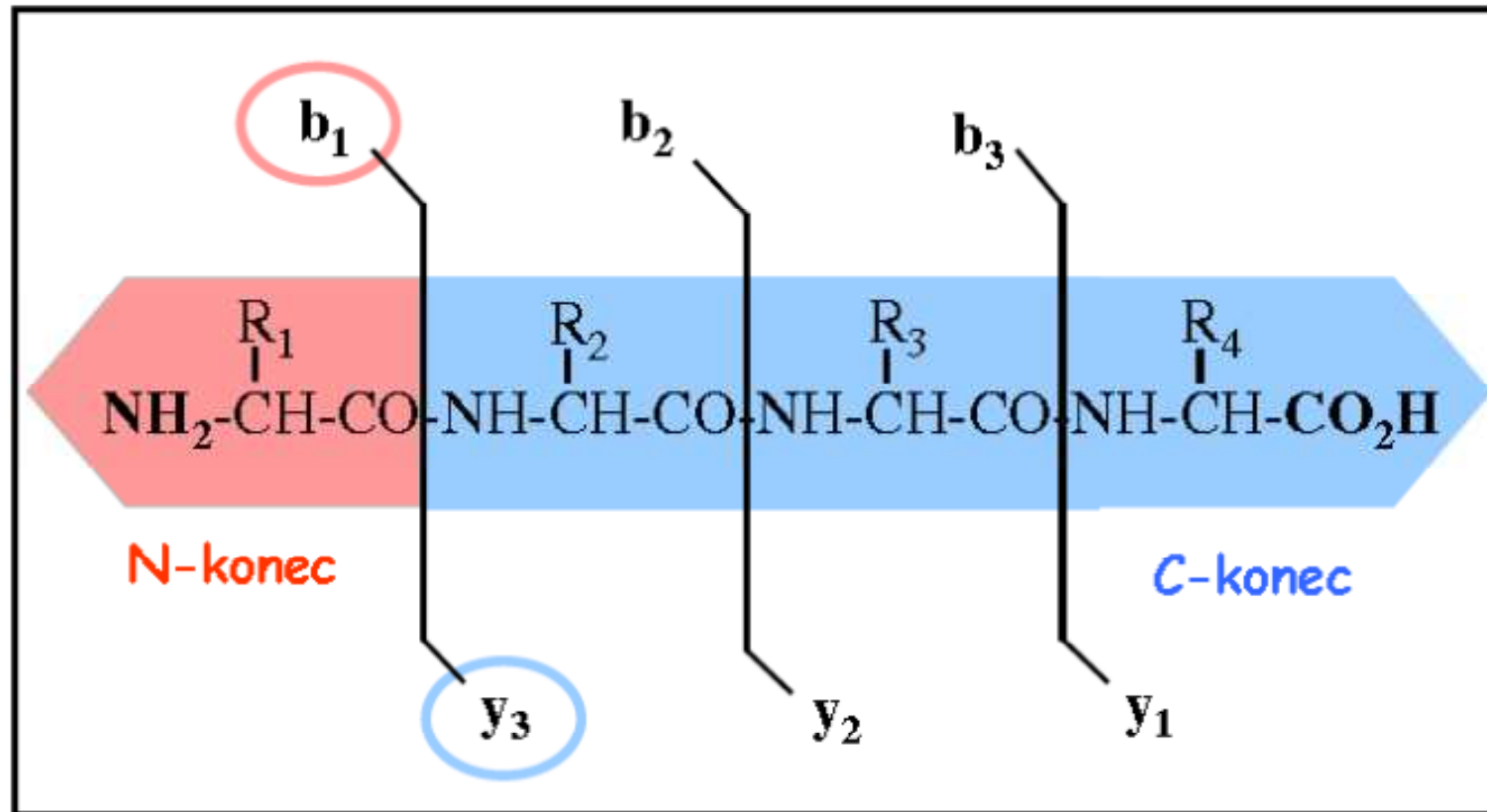

Databáze

- <http://www.expasy.org/>

DIGE – DIFERENČNÍ GELOVÁ ELEKTROFORESA

Cy2

Cy3

Cy5

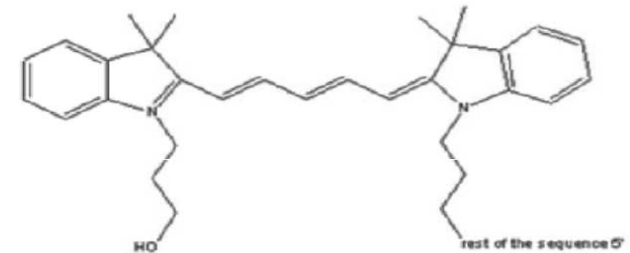
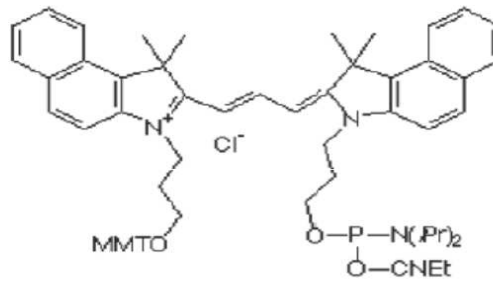

excitace 488 nm
emise 520 nm

excitace 532 nm
emise 580 nm

excitace 633 nm
emise 670 nm

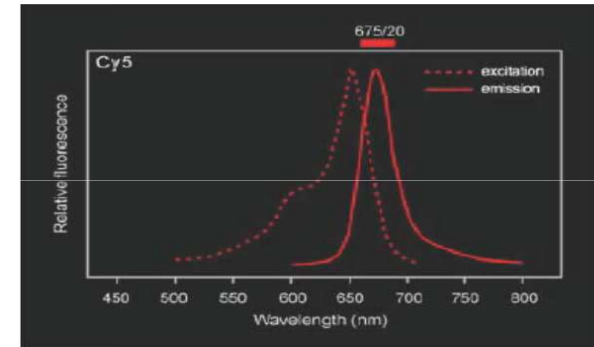
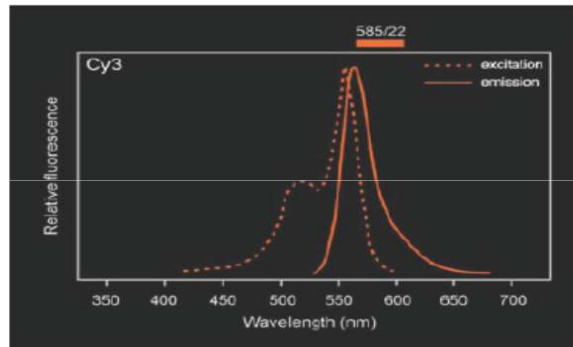
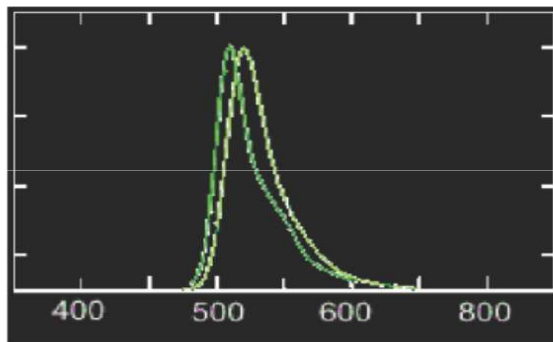

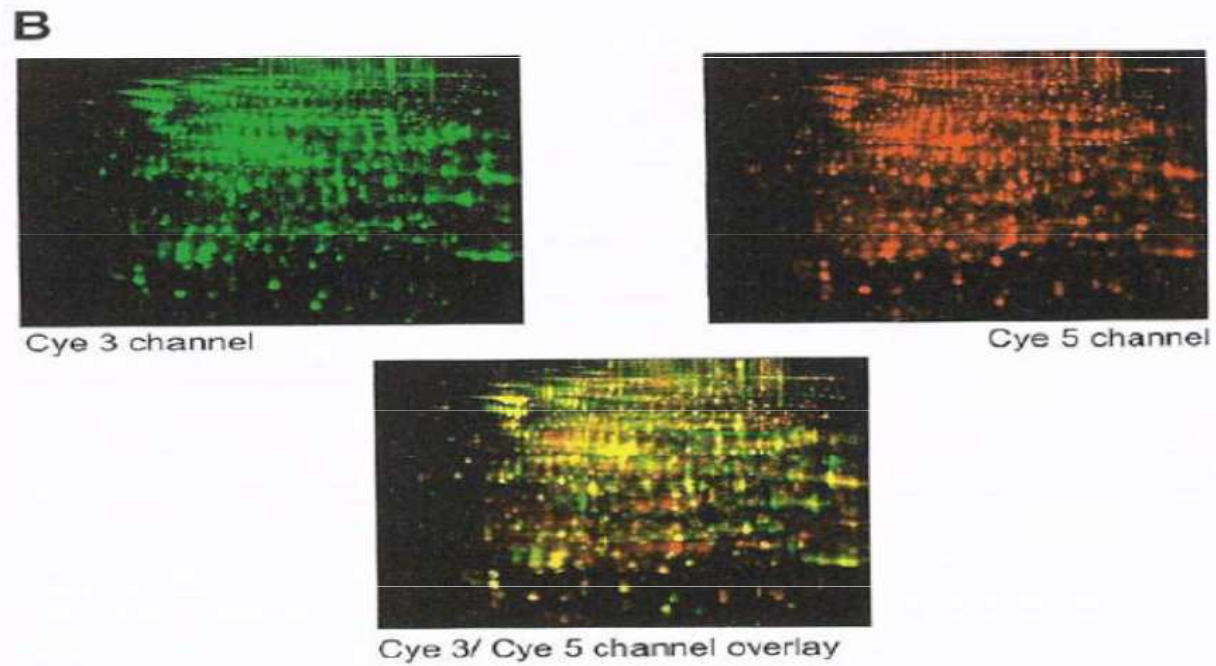
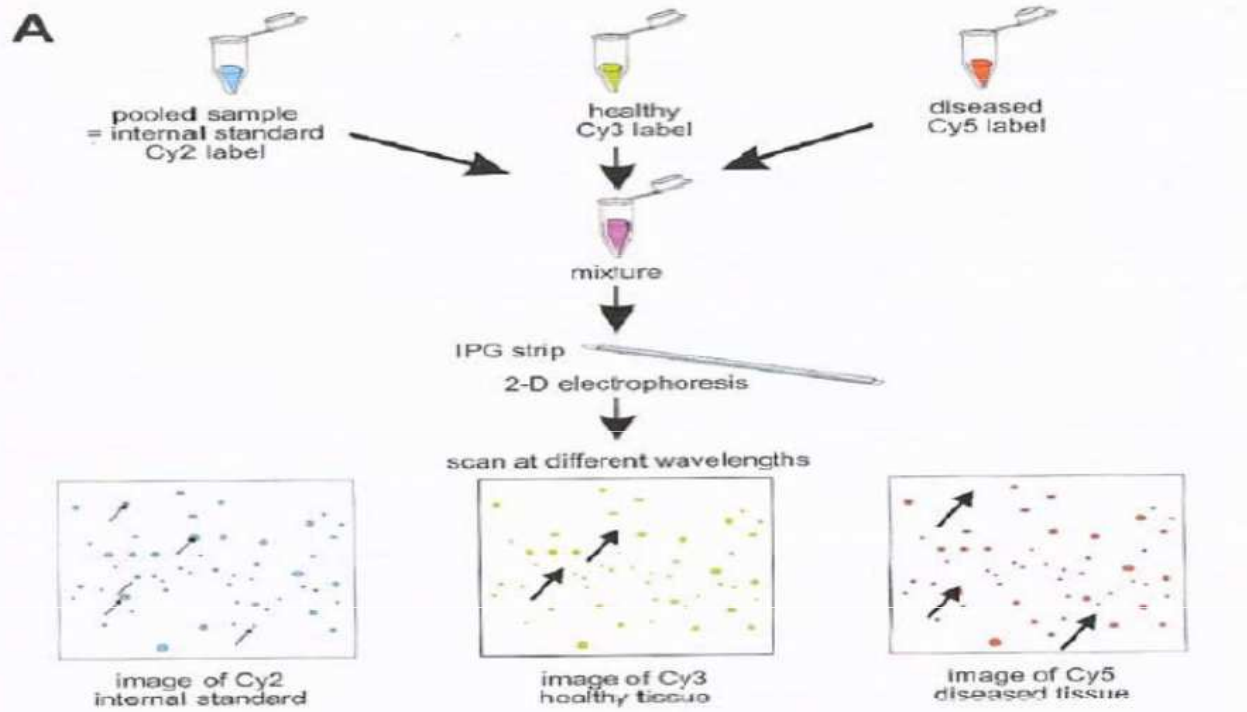

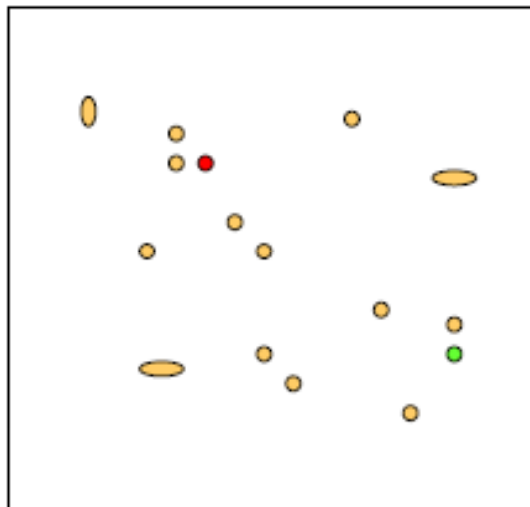
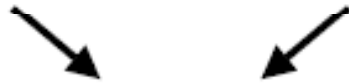
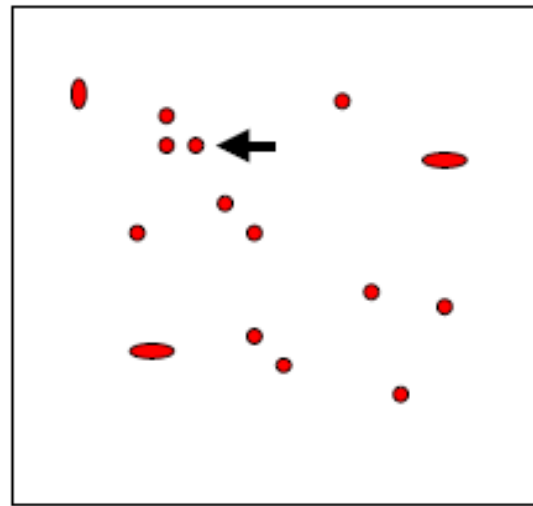
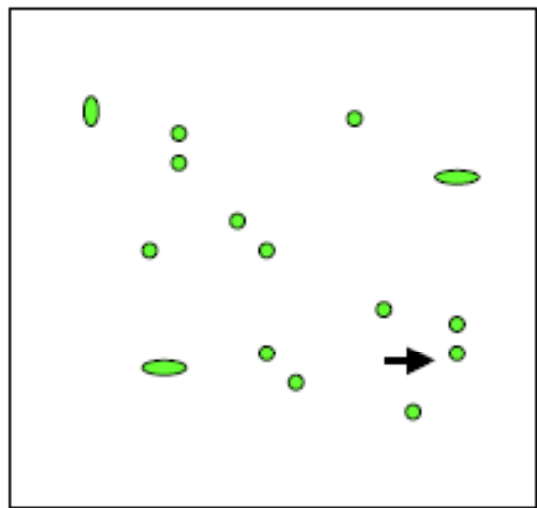

5. Charakterizace - stanovení pI, MW, UV VIS spektra, CD spektra,
fluorescenční spektra, AMK analýza a sekvenace, krystalizace -
RTG analýza, NMR spektra

Podle chemického složení

A. Jednoduché

B. Složené ⇒ prosthetická skupina + apoprotein

Kvantitativní poměr mezi oběma složkami může být různý !!

Fosfoproteiny - H_3PO_4

Glykoproteiny - cukry

Metaloproteiny - kovy

Lipoproteiny - lipidy

Nukleoproteiny - nukleové kyseliny

Rozdělení bílkovin

Podle celkového tvaru molekuly

A. Vláknité - fibrilární bílkoviny - SKLEROPROTEINY

kolagen, $\alpha + \beta$ keratin, elastin

B. Kulovité - globulární bílkoviny - SFEROPROTEINY

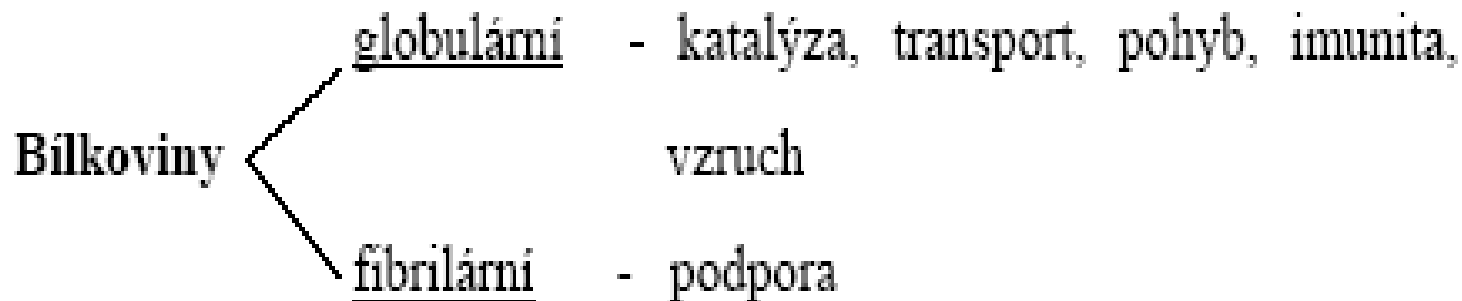

Kolagen

<i>Typ</i>	<i>Molekulární složení</i>	<i>Lokalizace</i>
I	$[\alpha 1(\text{I})_2\alpha 2(\text{I})]$	kost, kůže, šlacha, ligamenta rohovka, cévy
II	$[\alpha 1(\text{II})]_3$	chrupavka, sklivec, nukleus pulposus
III	$[\alpha 1(\text{III})]_3$	kůže, cévy, retikulární vlákna v mnoha tkáních (plíce, játra, slezina, atd.)
V	$\alpha 1(\text{V})\alpha 2(\text{V})\alpha 3(\text{V})$	plíce, rohovka, kost, fetální membrány, doprovází kolagen I
XI	$\alpha 1(\text{XI})\alpha 2(\text{XI})\alpha 3(\text{XI})$	chrupavka, sklivec

Délka molekuly je 300 nm, α -řetězec obsahuje 1000 aminokyselin.

Collagen α -chain primary structure

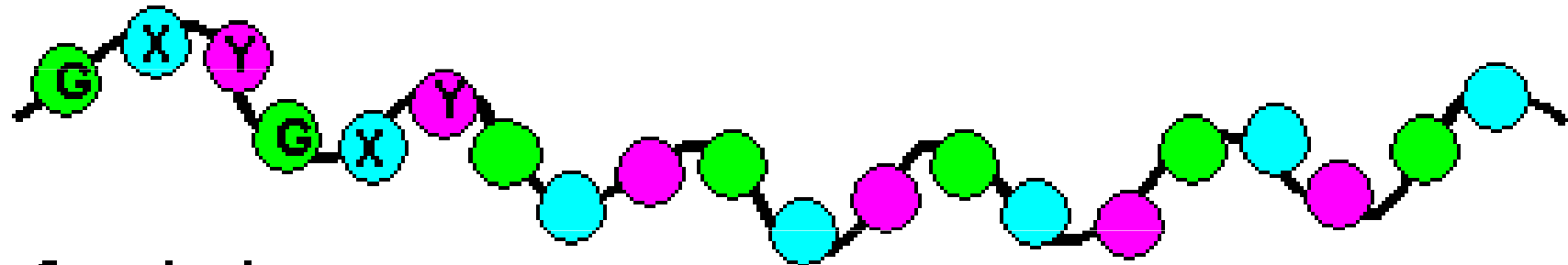

G - glycine

X - proline or other amino acid

Y - hydroxyproline or other amino acid

-Gly-X-Y- triplet repeats

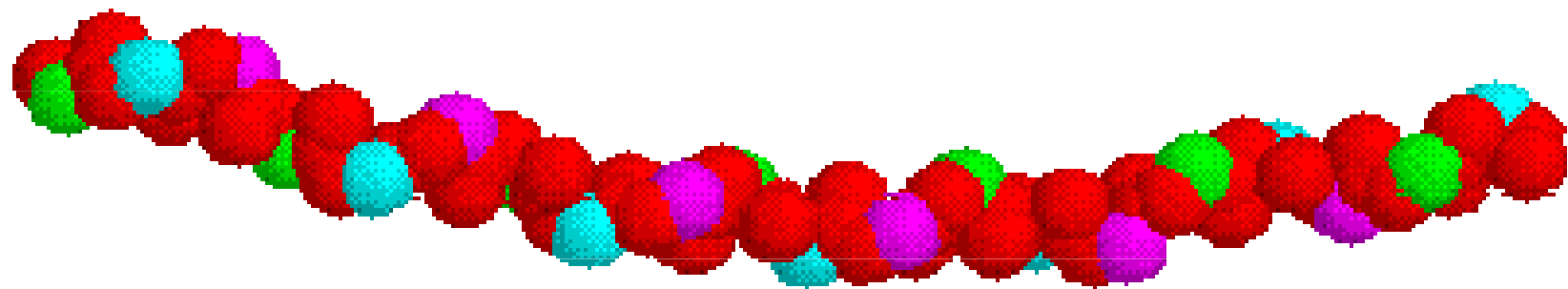

Molekulární struktura fibrilárních kolagenů

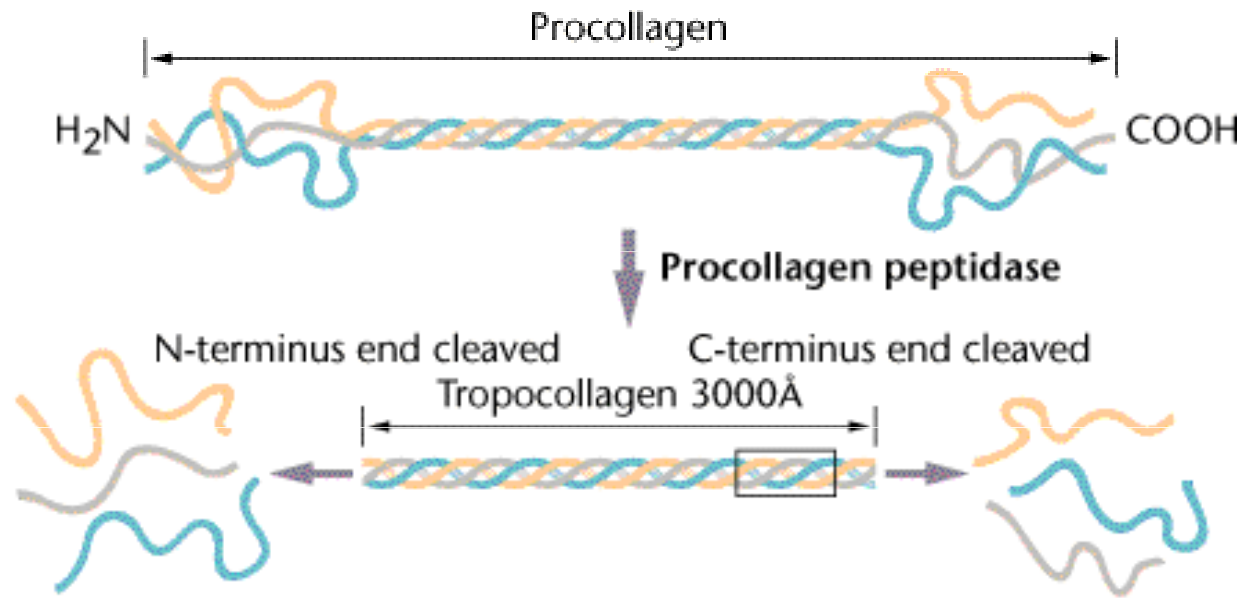

- pravotočivá trojitá šroubovice - 3 α -řetězce (levotočivá šroubovice s odstupem 18 aminokyselin na jednu otáčku)

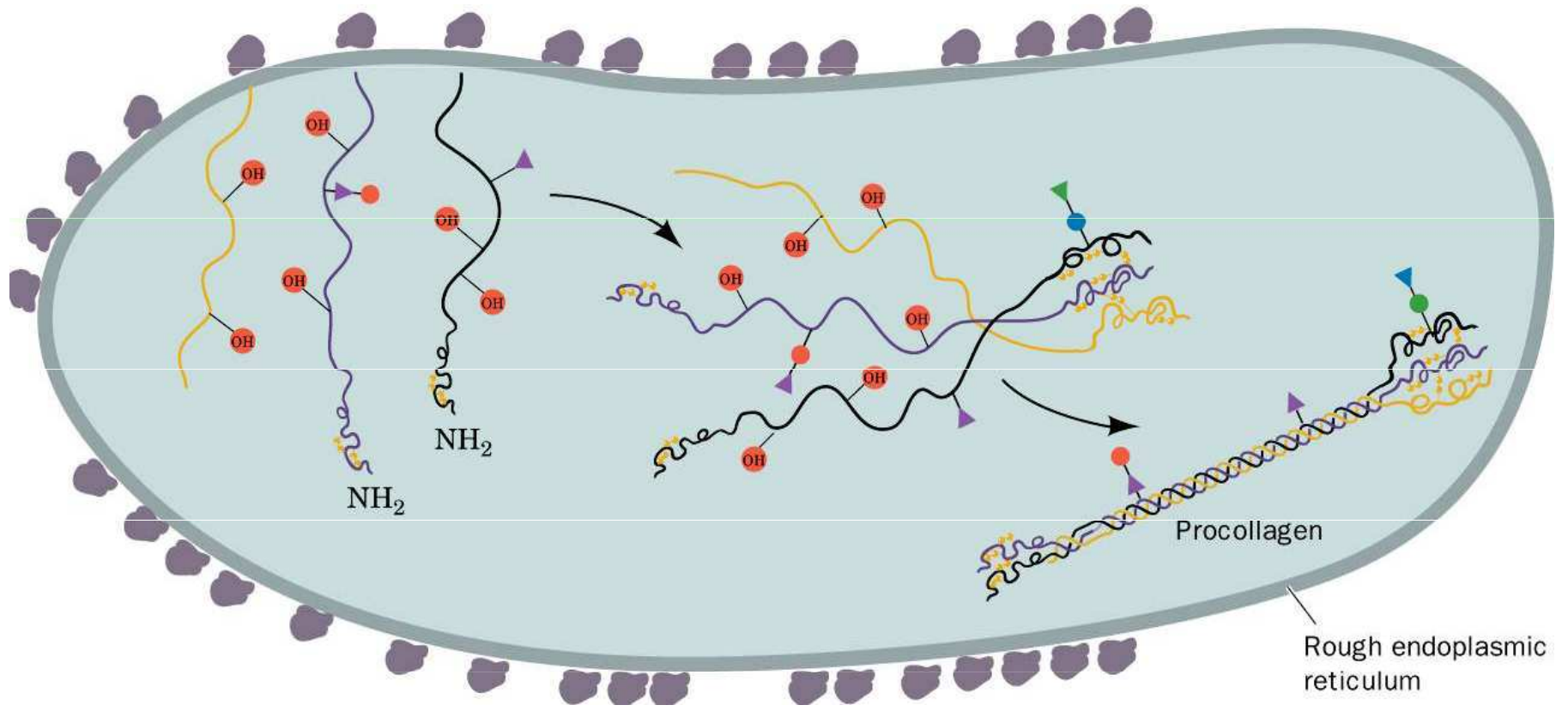

Formation of collagen: intracellular processing

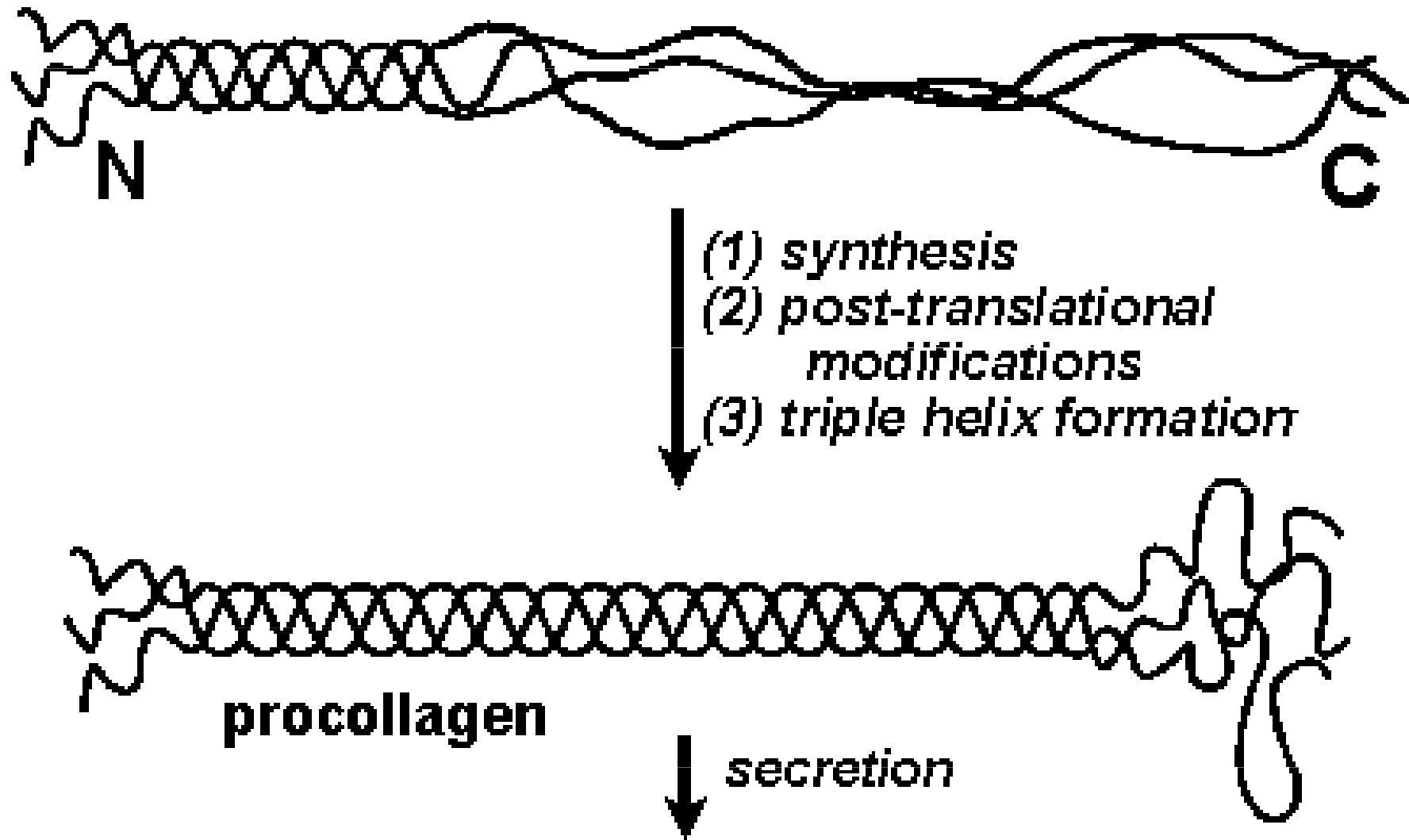

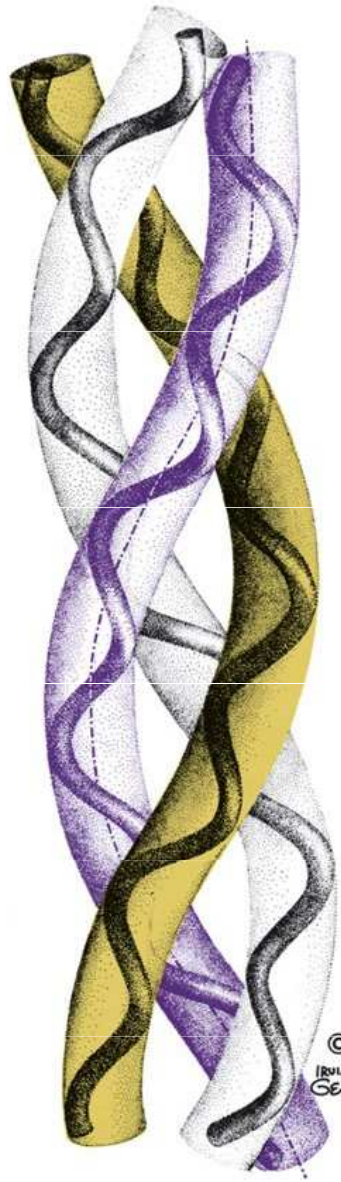

© IRVING
Geis
Irving Geis/Geis Archives Trust. Copyright Howard Hughes Medical Institute. Reproduced with permission.

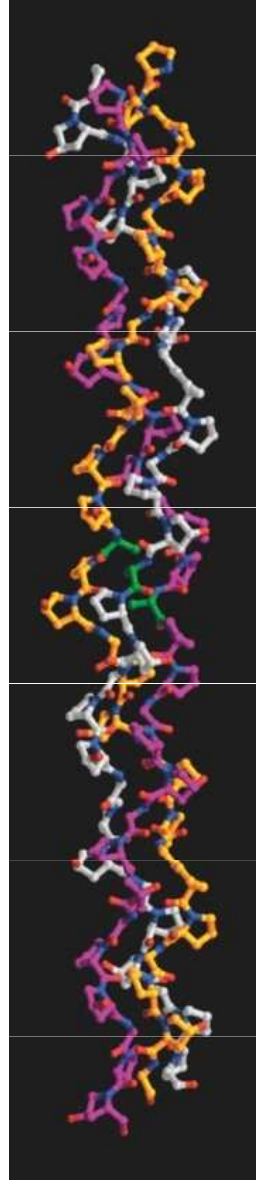

Formation of collagen: extracellular processing

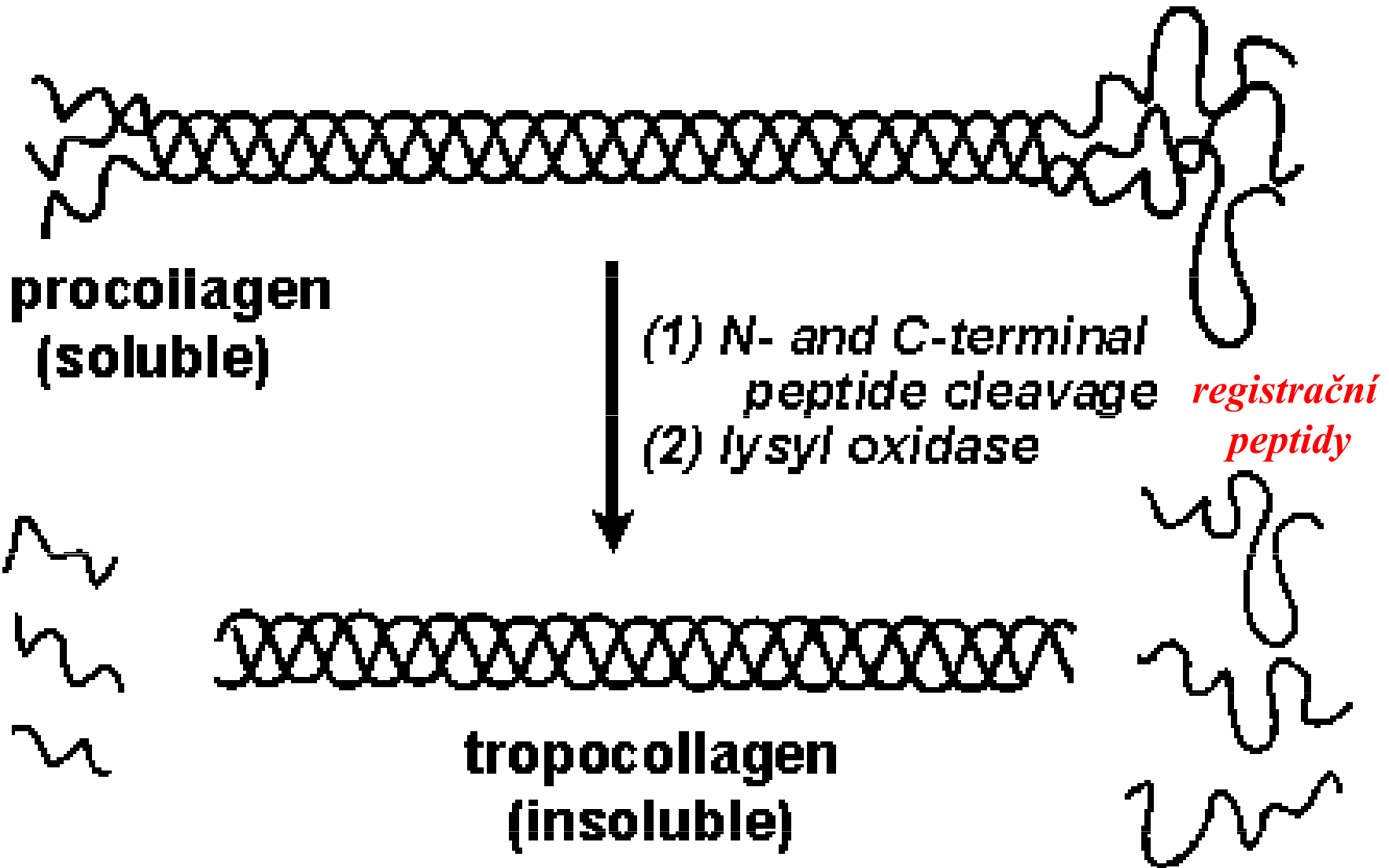

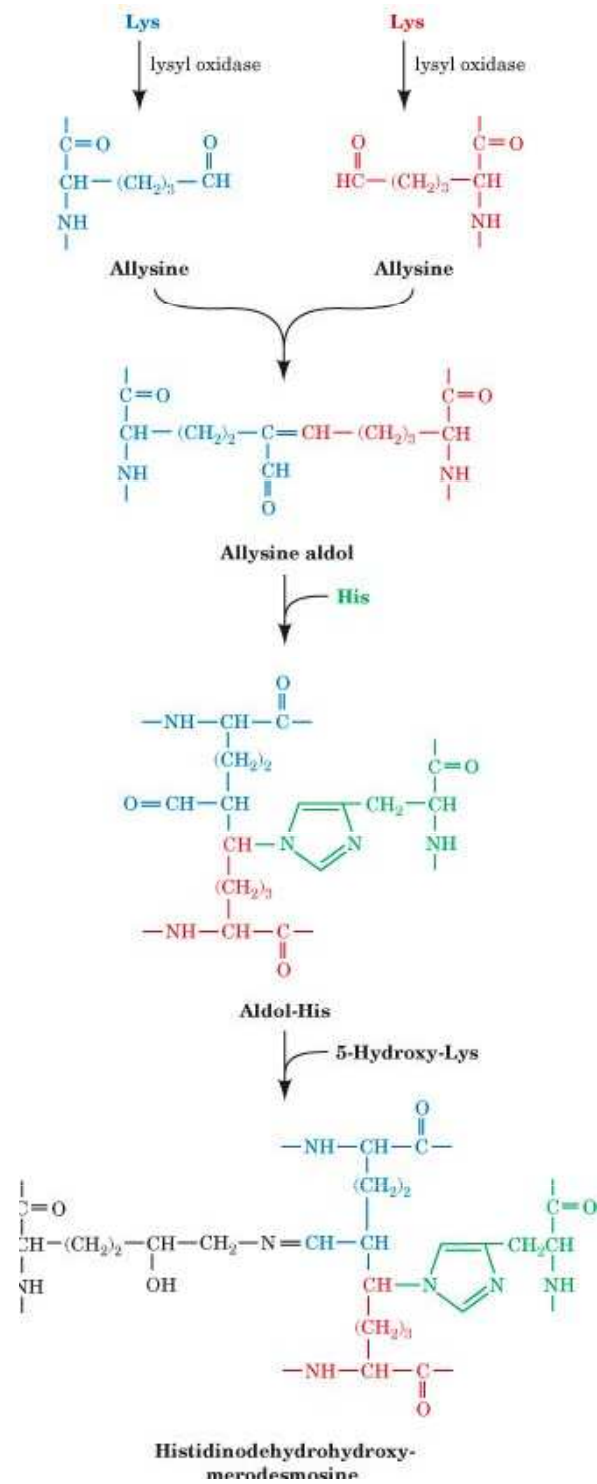

Formation of collagen: extracellular processing

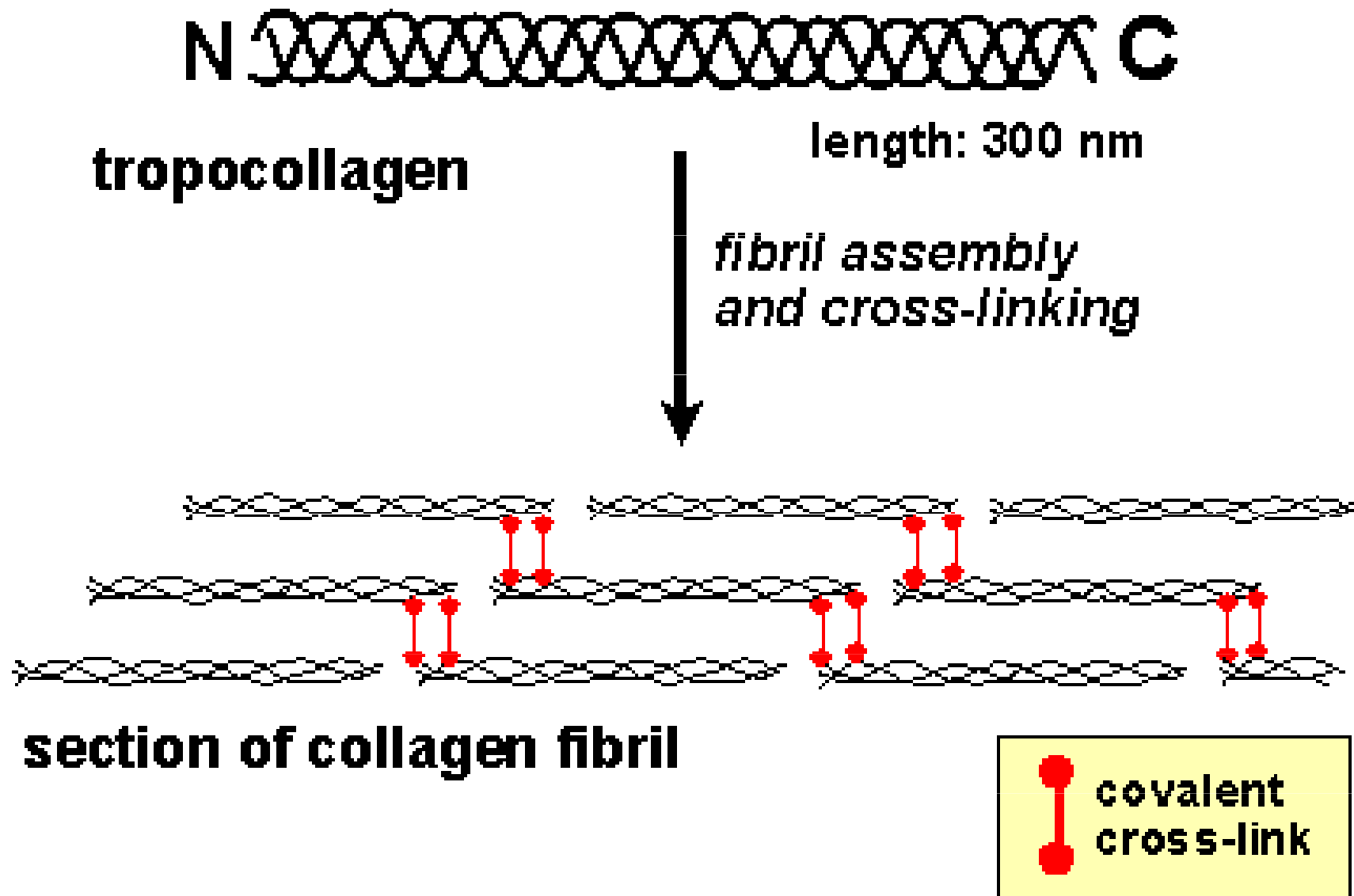

Formation of collagen: extracellular processing

fibril assembly
and cross-linking

section of collagen fibril

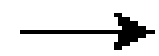
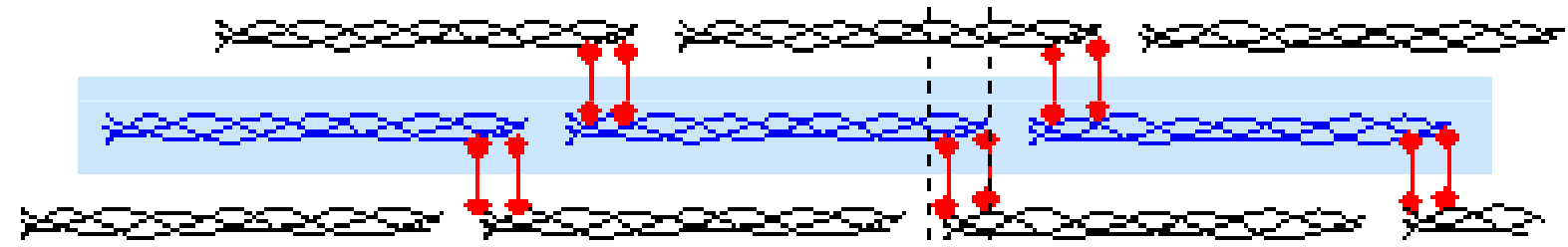

64-67 nm
"quarter-staggered array"

collagen fibril

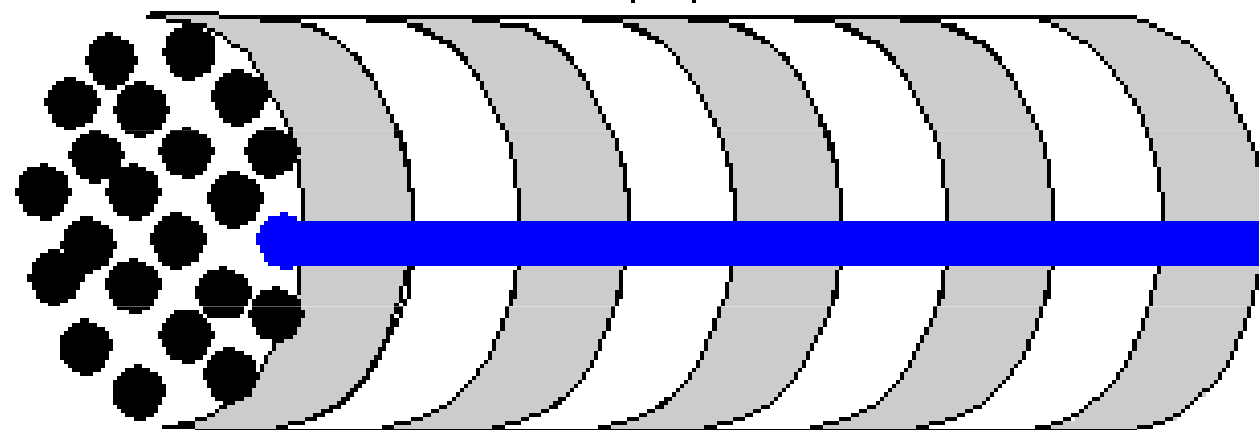

Formation of collagen: extracellular processing

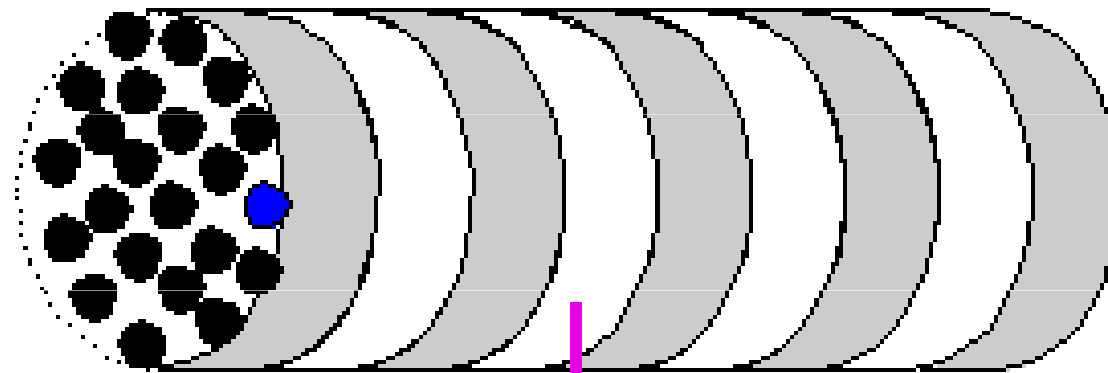

collagen fibril

aggregation

collagen fiber

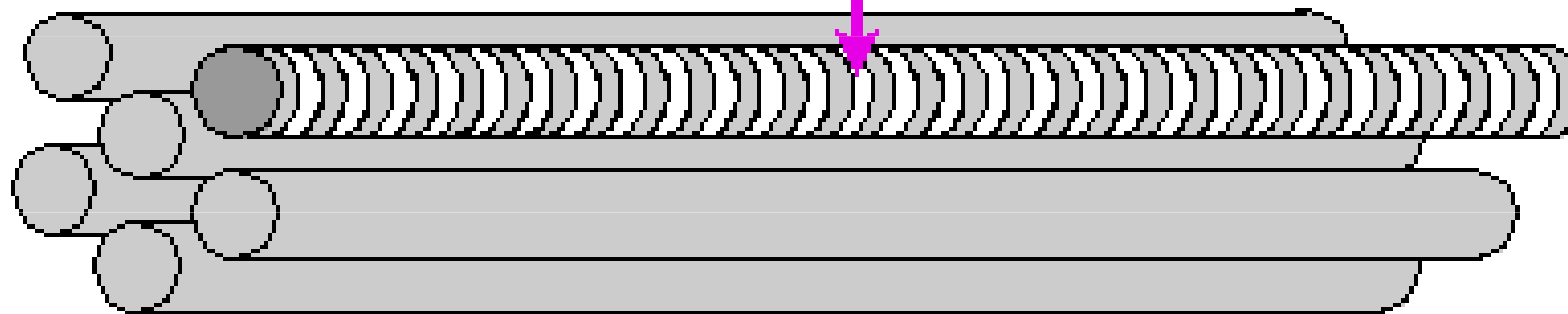

Collagen molecule 

Packing of molecules

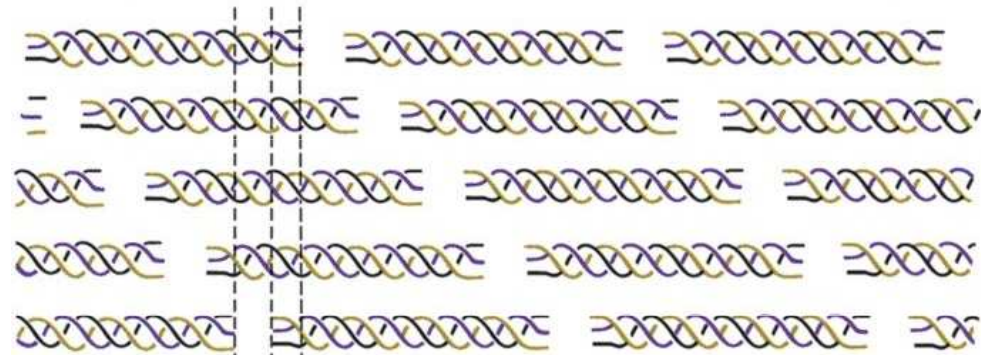

Hole zone ———— 0.6D
Overlap zone ———— 0.4D

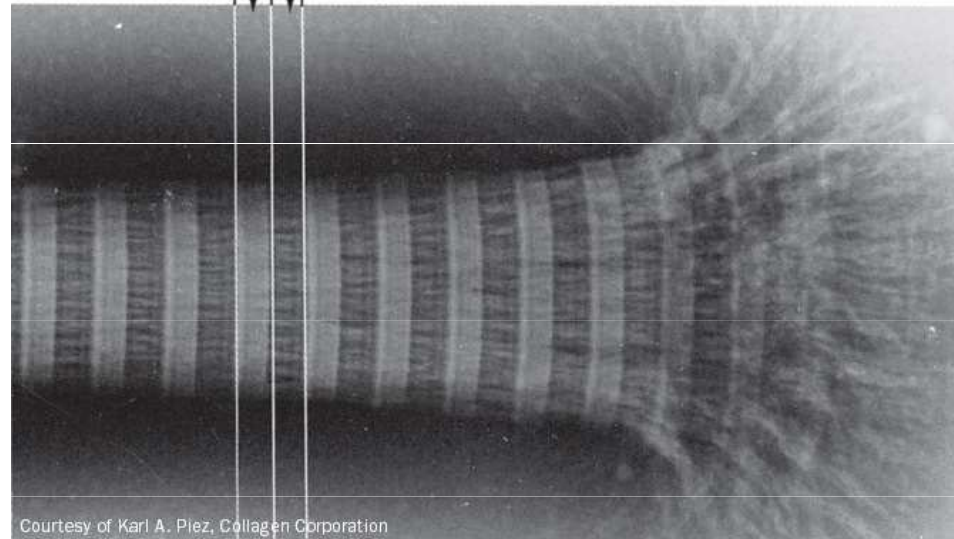

Courtesy of Karl A. Piez, Collagen Corporation

Kolagen v kůži

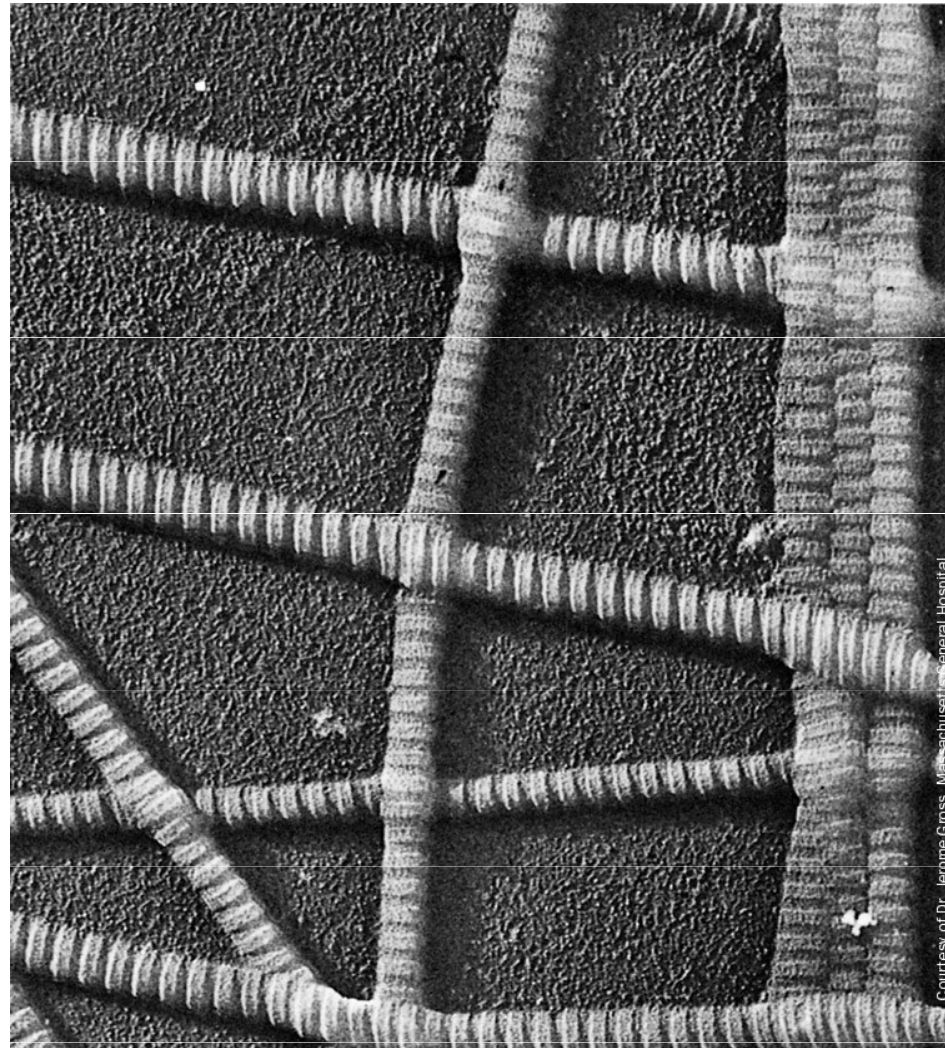

Courtesy of Dr. Jerome Gross, Massachusetts General Hospital

Ehlers–Danlos syndrom (EDS)



α - keratin

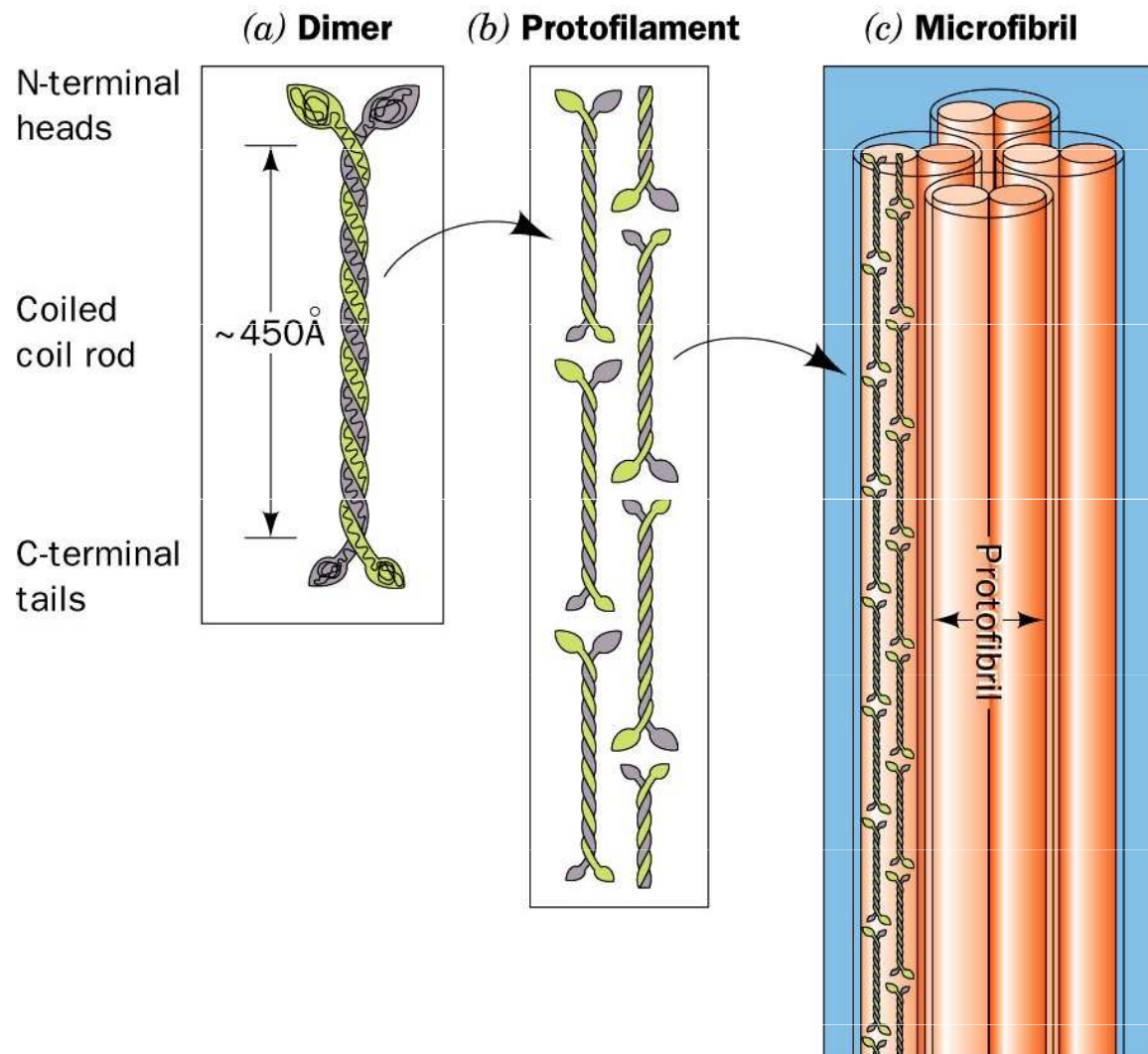

(Four α -keratins twisted into a left-handed superhelix
each α -keratin is coiled into a right-handed α -helix)

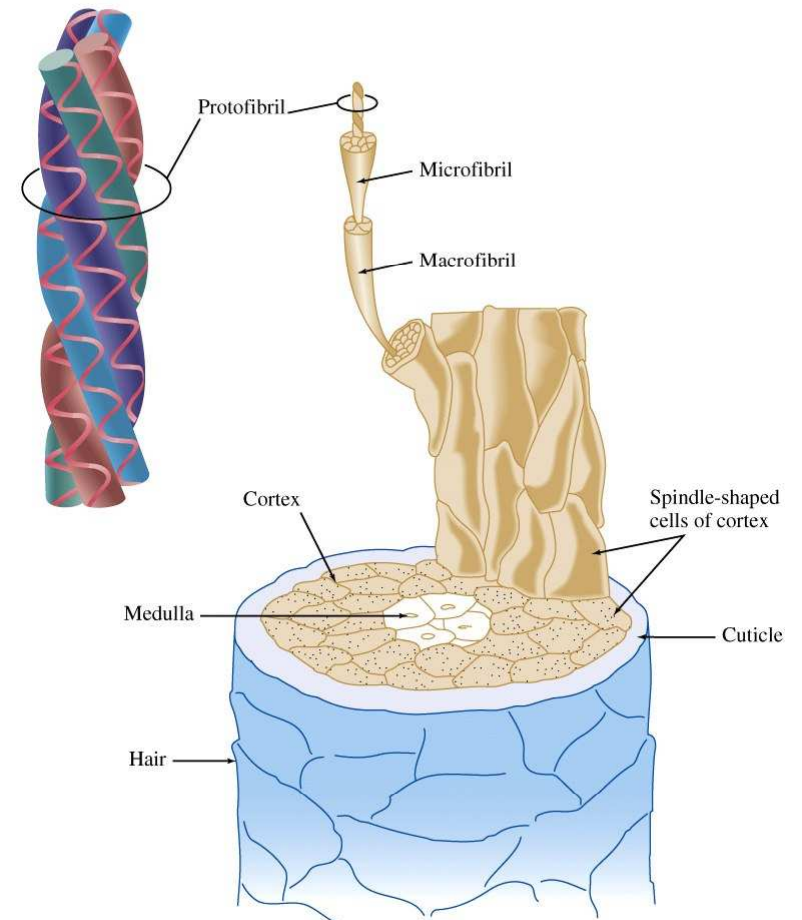
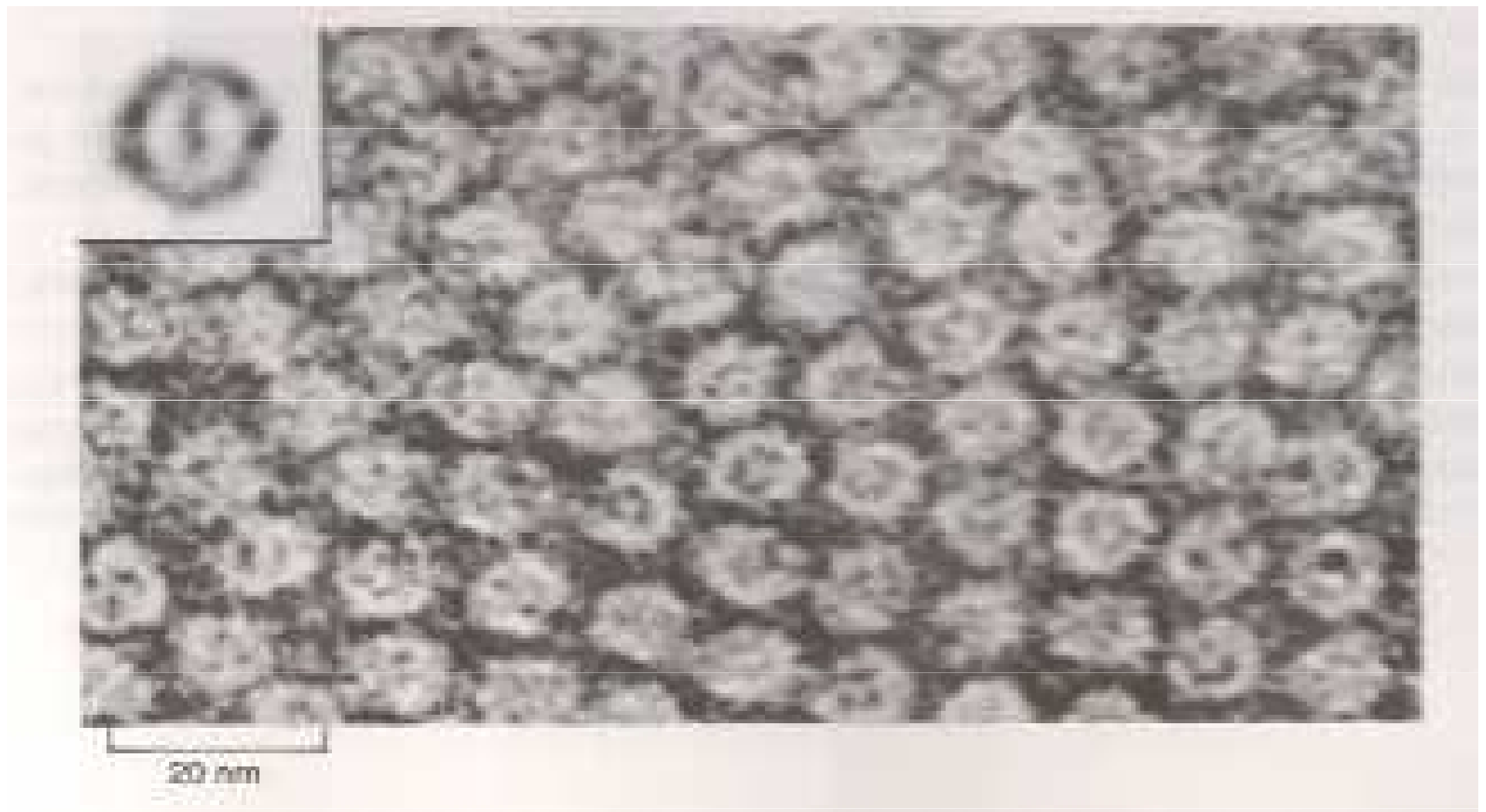
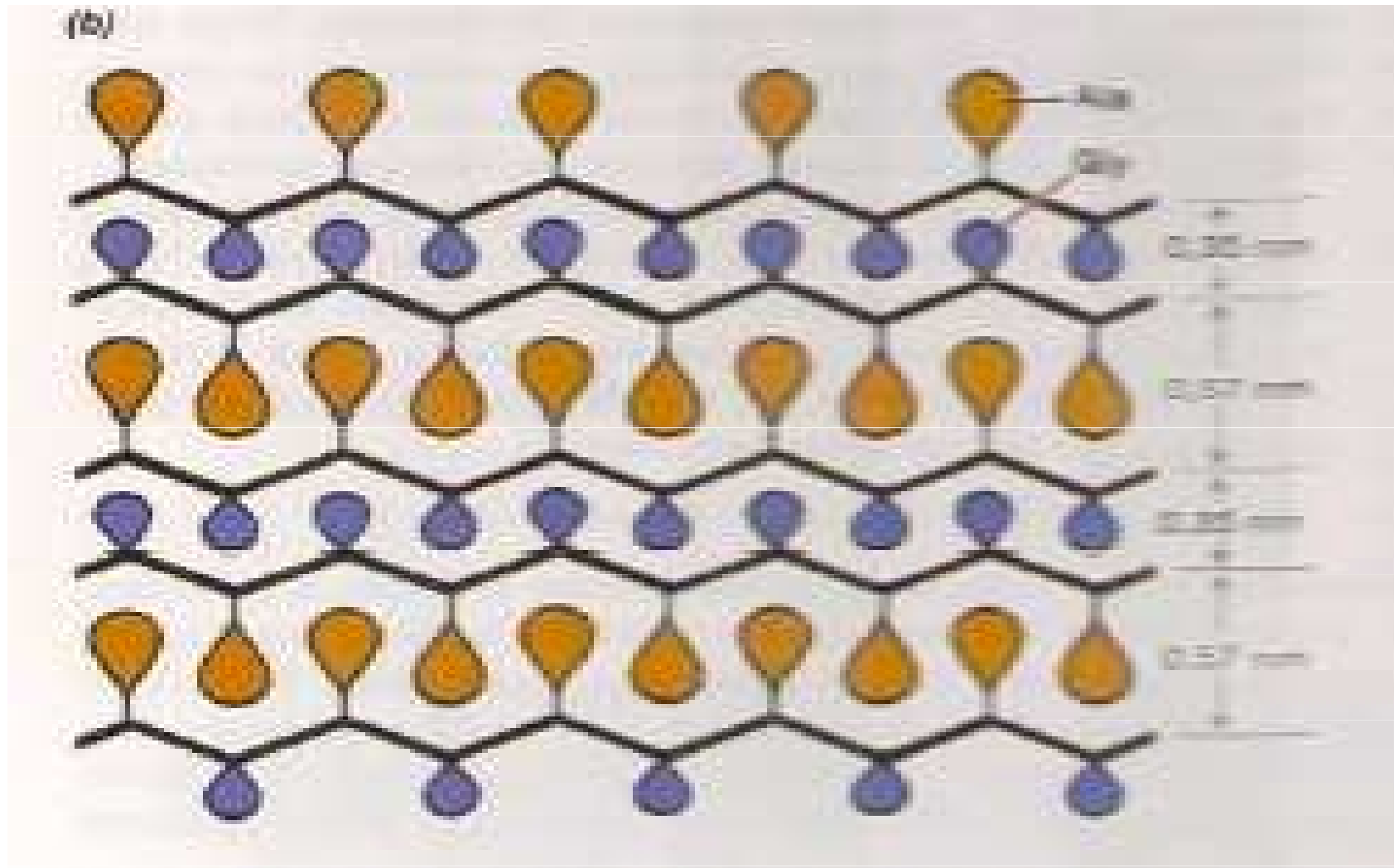

Figure 4-25 Concepts in Biochemistry, 3/e
© 2006 John Wiley & Sons

α – keratin - vlas



β - keratin



β - keratin

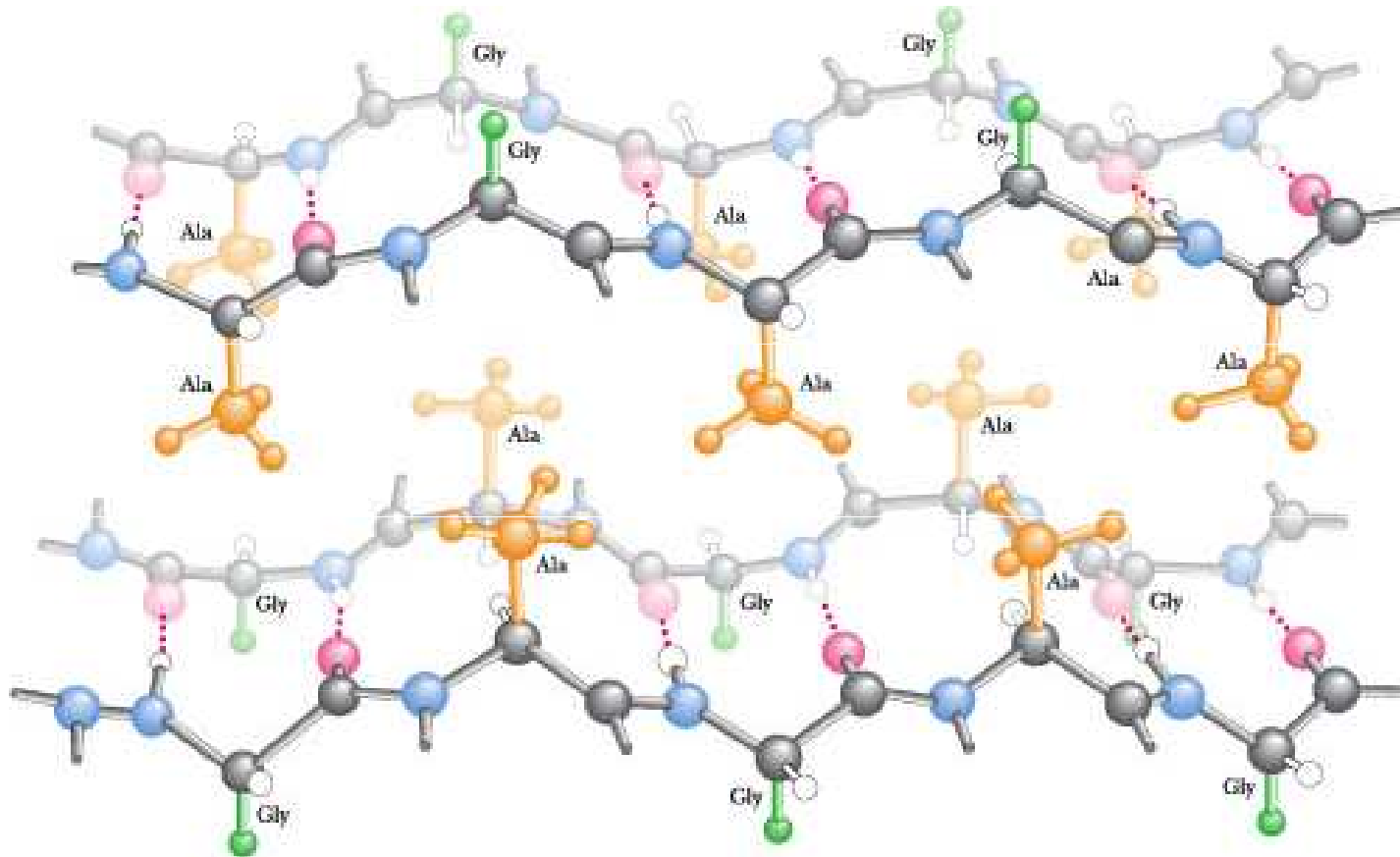

Elastin

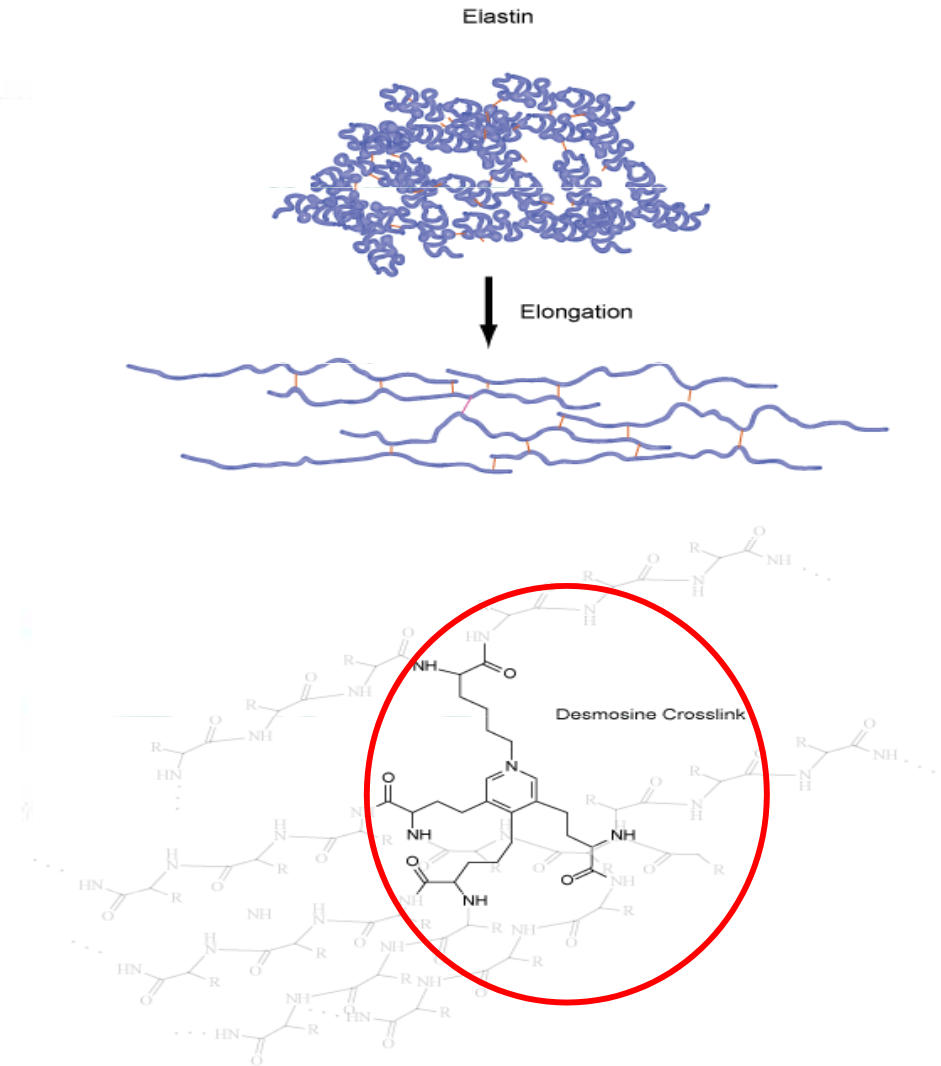
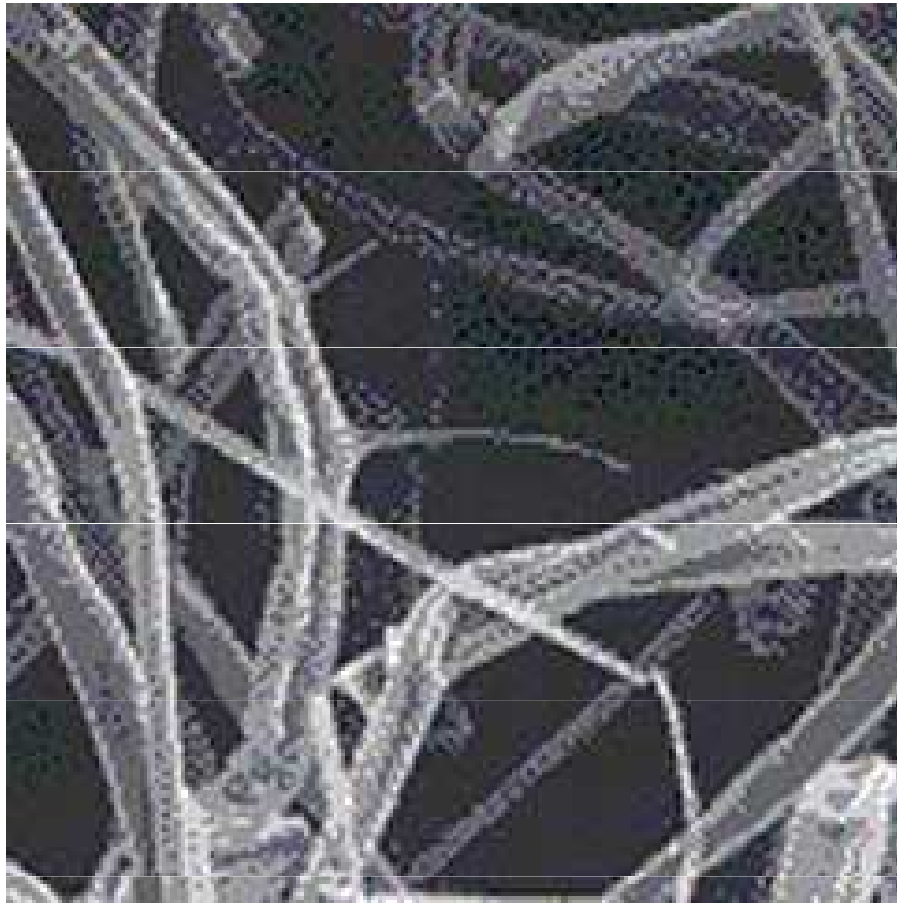

Figure 4-28 Essential Cell Biology, 2/e. (© 2004 Garland Science)