

SACHARIDY

Sacharidy - *saccharum* - *cukr*

Synonyma : cukry - glycidy - uhlohydráty *carbohydrates* - $(\text{CH}_2\text{O})_n$

Funkce - zdroj energie **glukosa**
zásobní látky **glykogen, škrob**
stavební a podpůrná funkce **celulosa, chitin**
složky nukleotidů, koenzymů, glyko-proteinů, -lipidů
prekurzory aminokyselin, lipidů
antigenní determinanty buněk

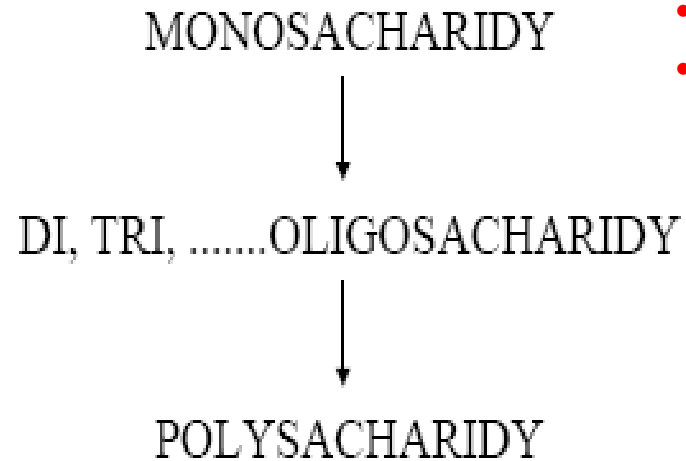

- Fotosyntéza
- Glukoneogenese

Monosacharidy : → Nemohou být rozloženy na menší jednotky

chemicky - polyhydroxyaldehydy
- polyhydroxyketony

Rozdělení

A. podle povahy karbonylové skupiny

- ALDOSY
- KETOSY

B. podle počtu uhlíkových atomů - TRIOSY, TETROSY,
PENTOSY, HEXOSY, HEPTOSY,

ALDOHEXOSA



Číslování

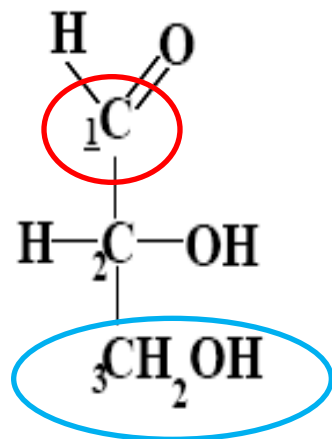

D - glyceraldehyd

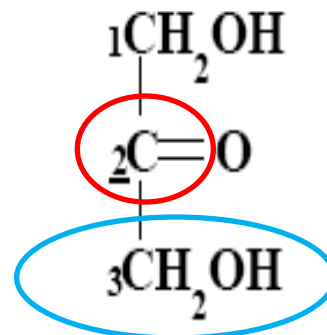

dihydroxyacetol

PRIMÁRNÍ HYDROXYLOVÁ SKUPINA

Názvosloví : triviální

aldosa -OSA

ketosa -ULOSA

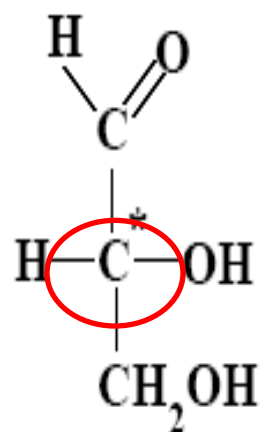

D - glyceraldehyd

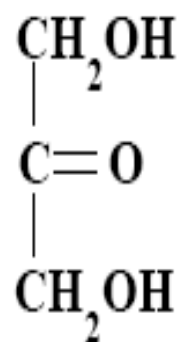

dihydroxyaceton

počet stereoizomerů = 2^x (x = počet C^*)

aldosy - $x = n - 2$

ketosy - $x = n - 3$

n = počet C atomů

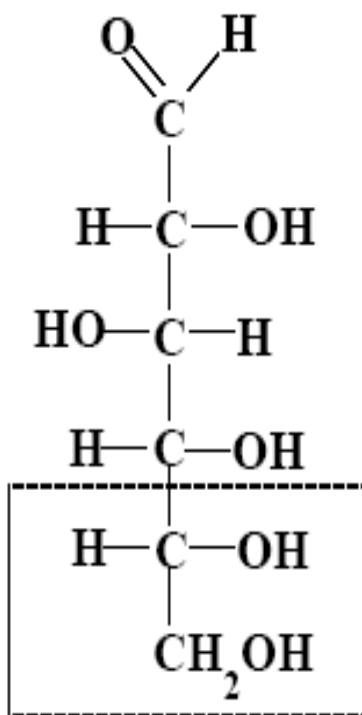

D - glukosa

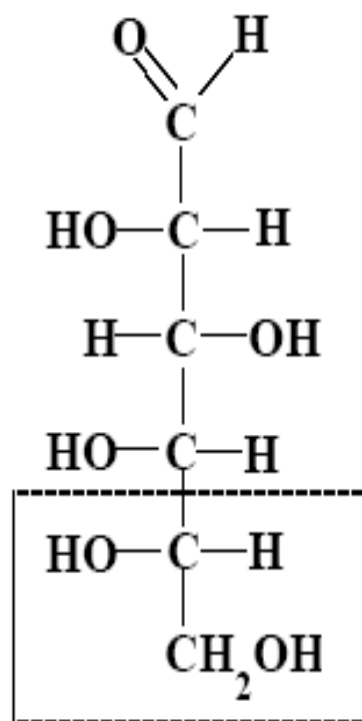

L - glukosa

Aldosy – 2^{n-2}

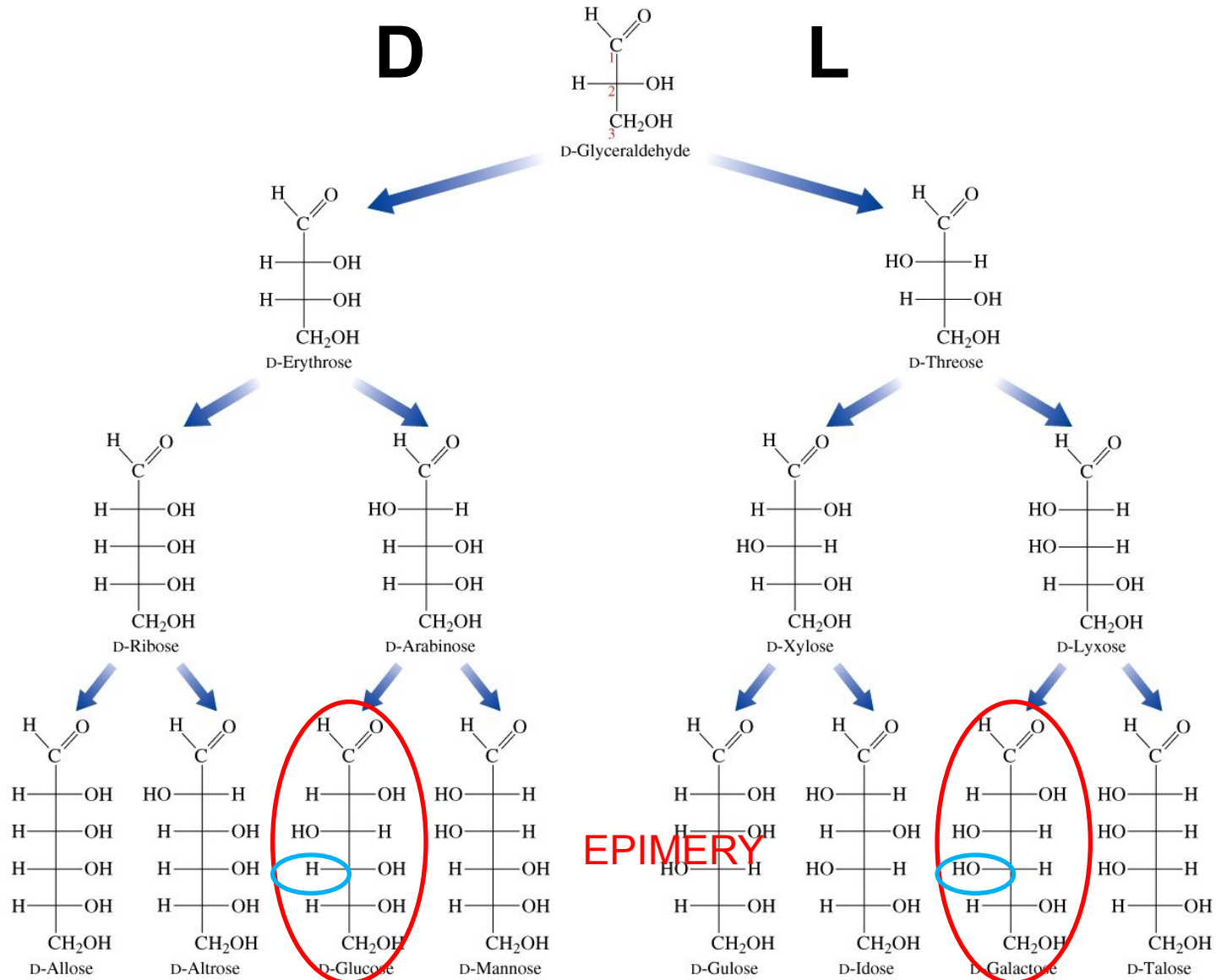

Figure 7-5 Concepts in Biochemistry, 3/e

Ketoses – 2^{n-3}

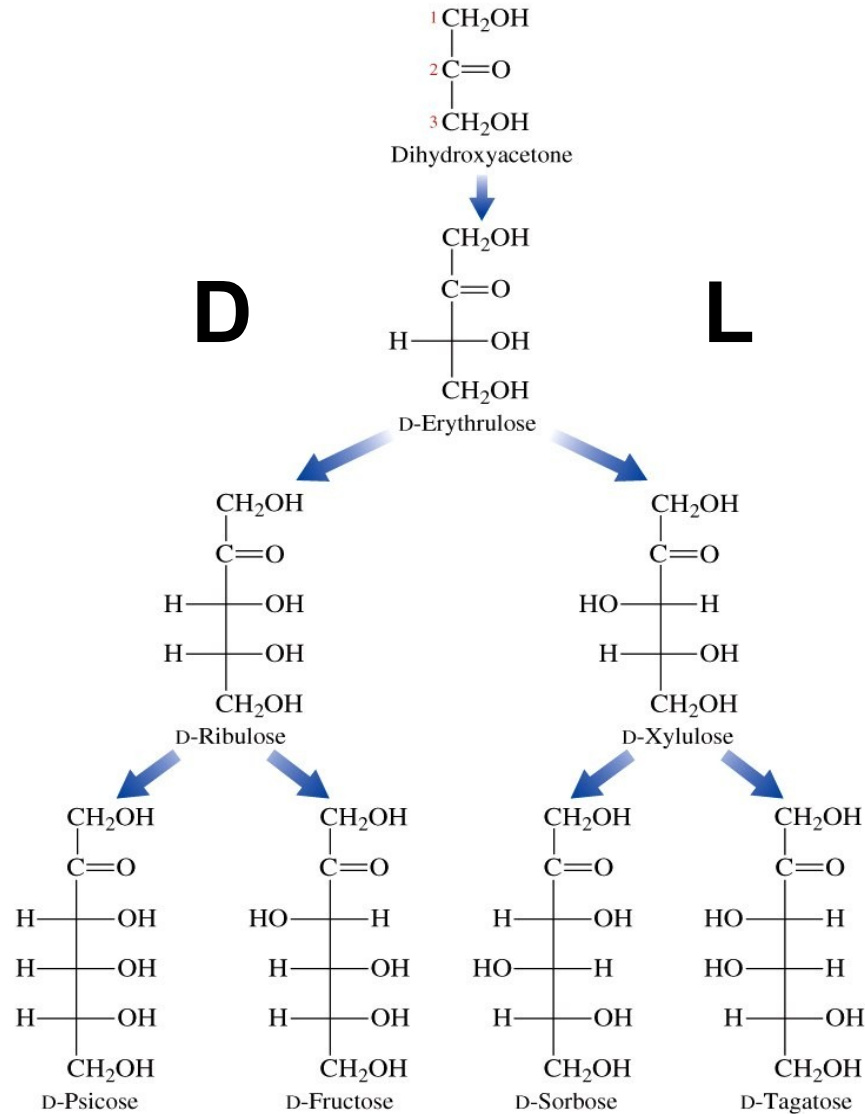
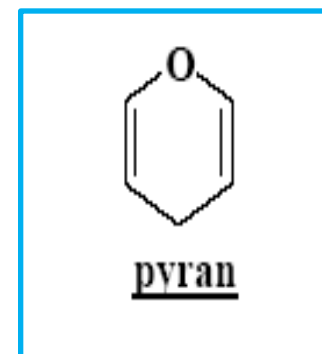
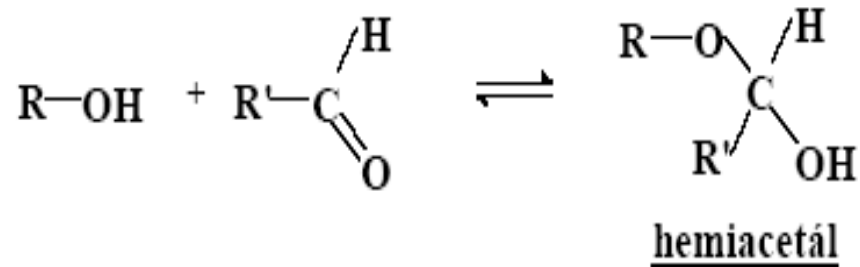
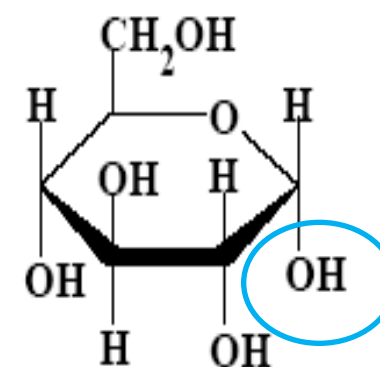
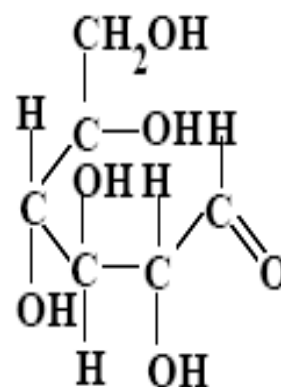
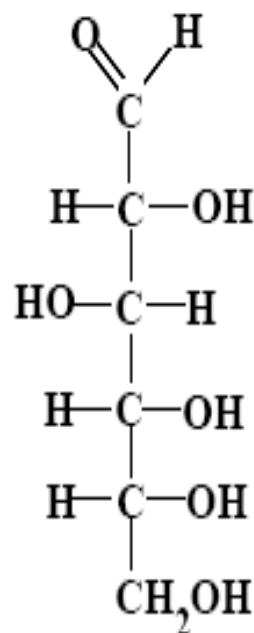

Figure 7-6a Concepts in Biochemistry, 3/e
© 2006 John Wiley & Sons



Fischerovy vzorce



D-glukopyranosa

POLOACETÁLOVÝ HYDROXYL - 1



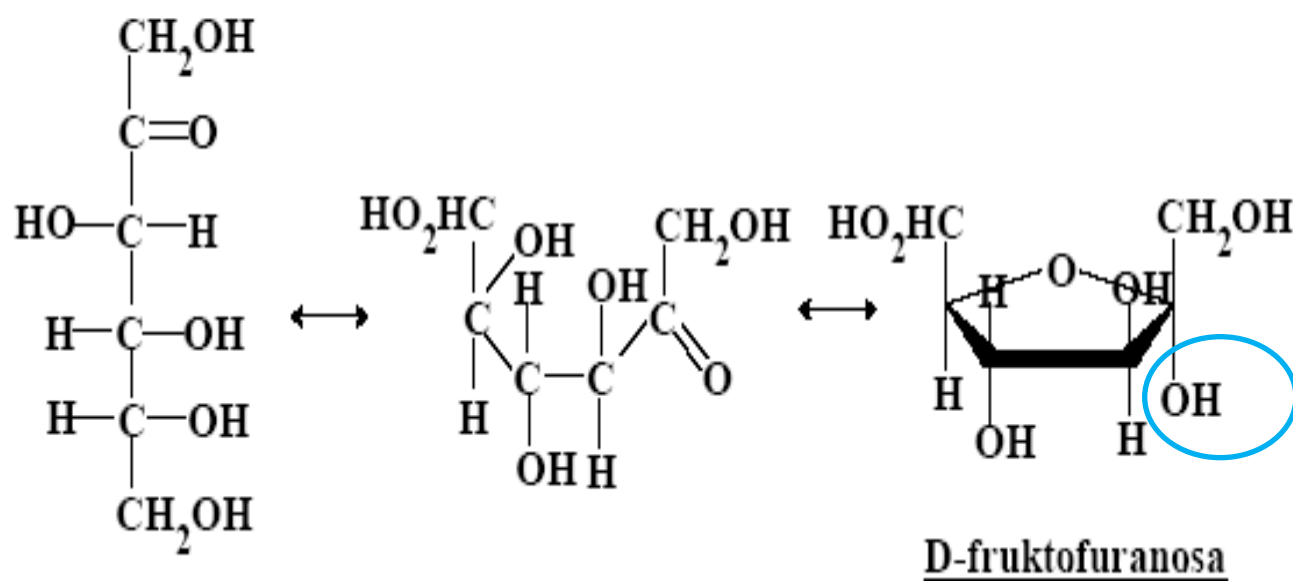
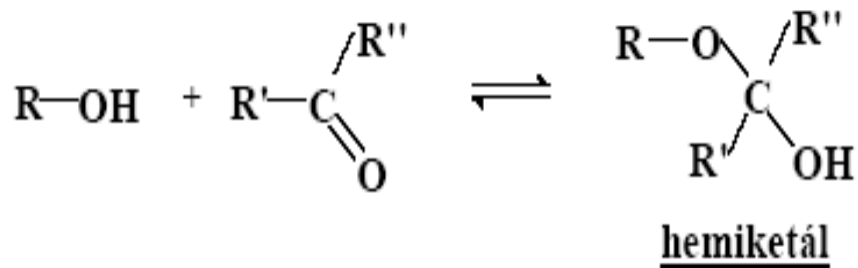

POLOACETÁLOVÝ HYDROXYL - 2

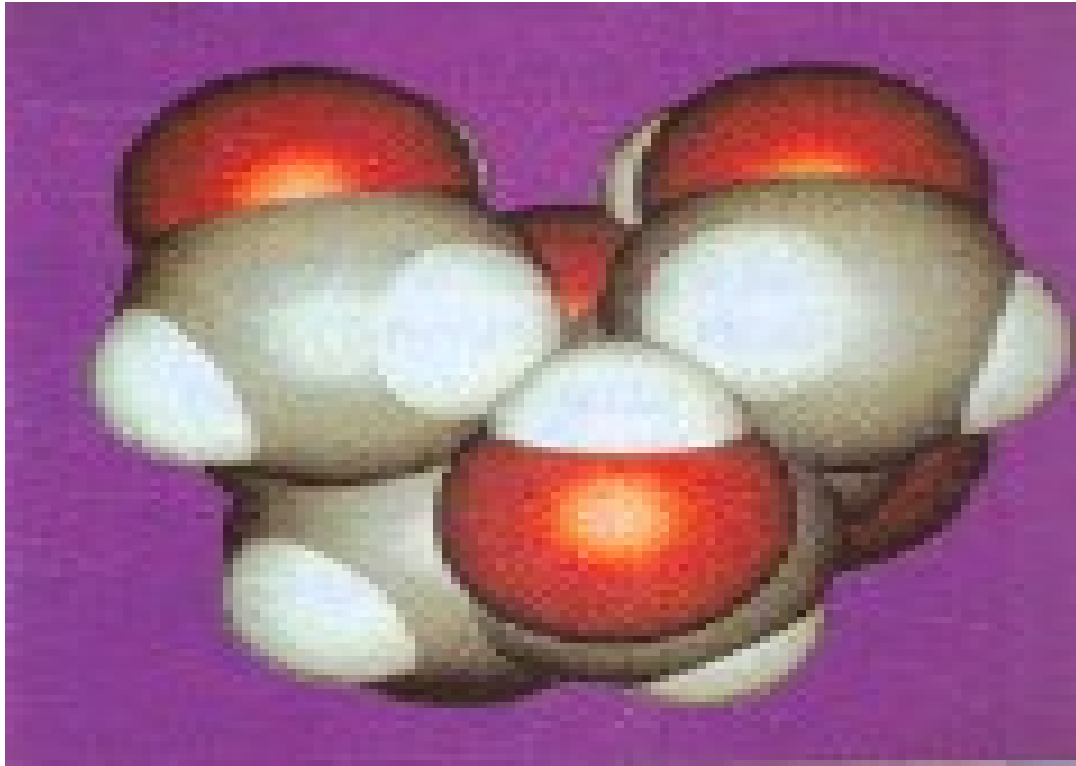

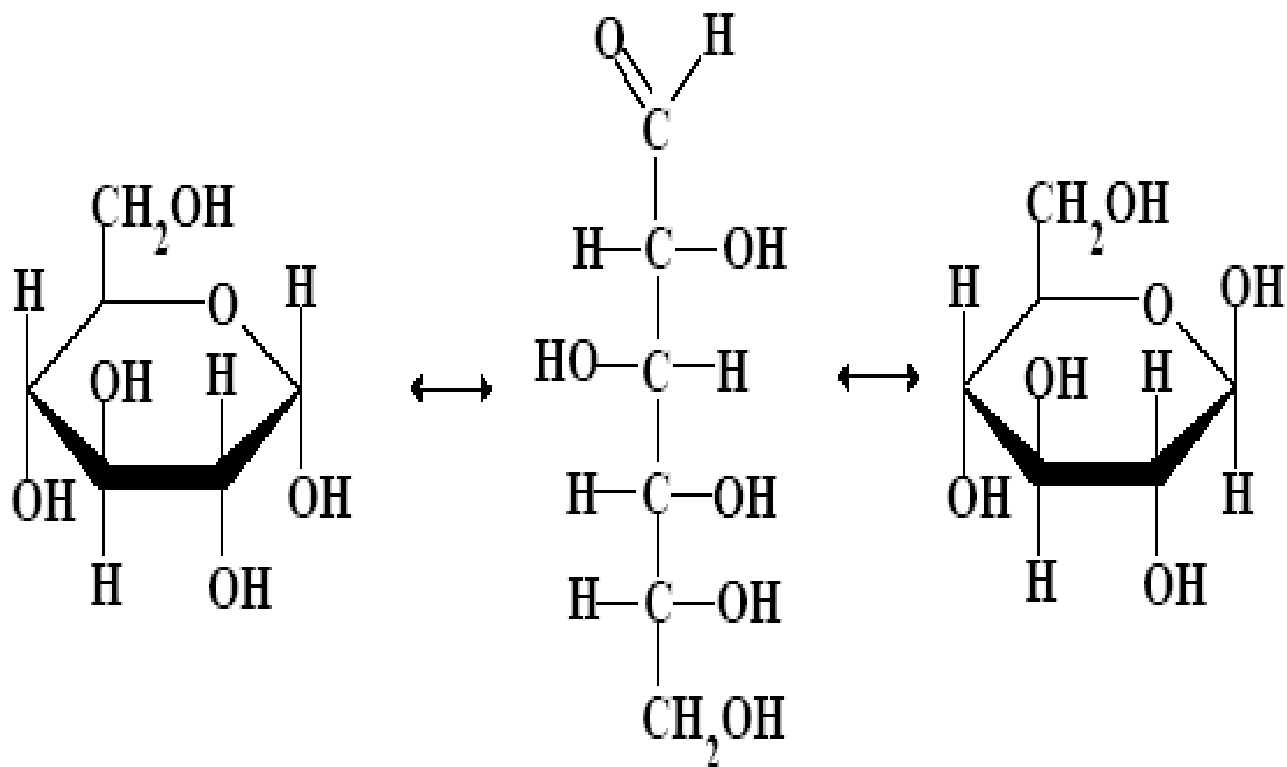

α -anomer (63 %) \longleftrightarrow MUTAROTACE \longleftrightarrow β -anomer (36 %)

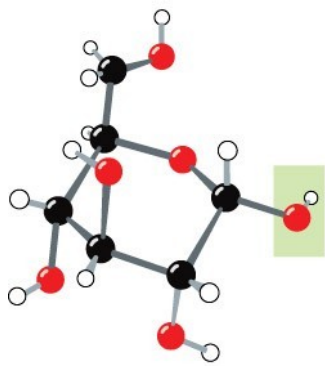

α -D-Glucopyranose

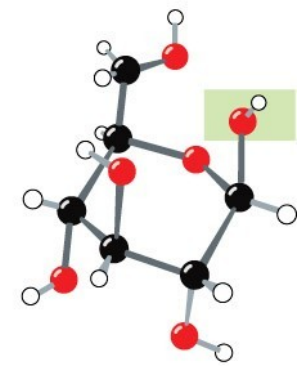
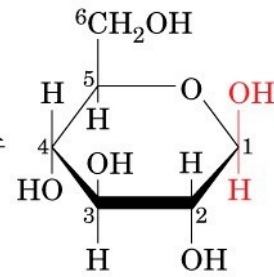
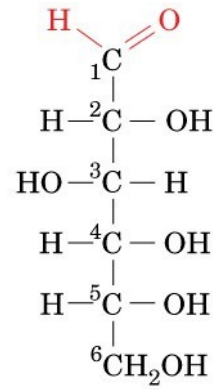
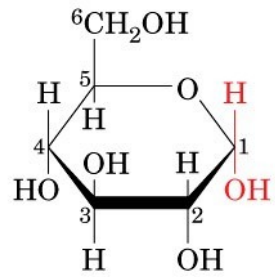

β -D-Glucopyranose

**D-Glucose
(linear form)**

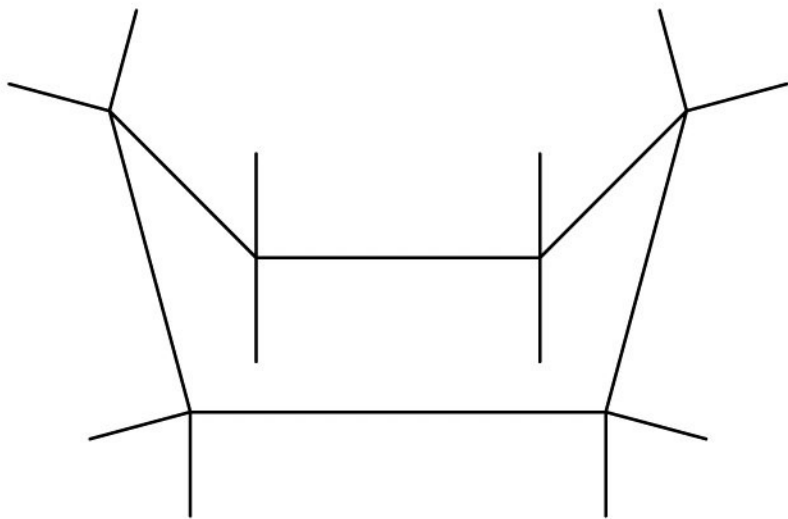

VANIČKA

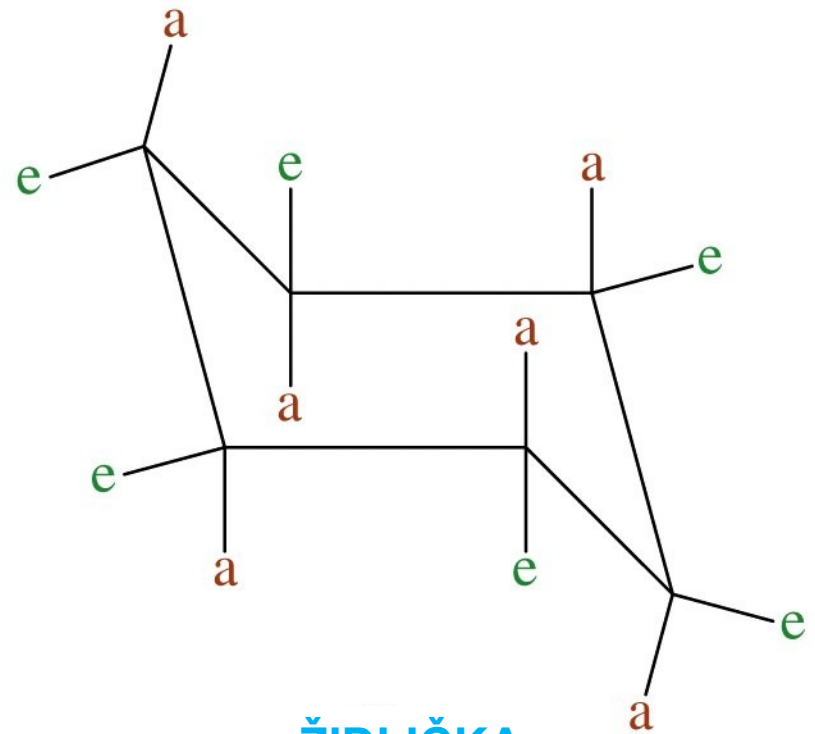

ŽIDLIČKA

Figure 7-10a Concepts in Biochemistry, 3/e
 © 2006 John Wiley & Sons

Fischerova projekce:

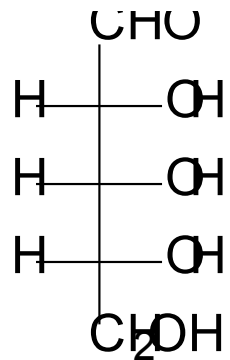

D-ribosa

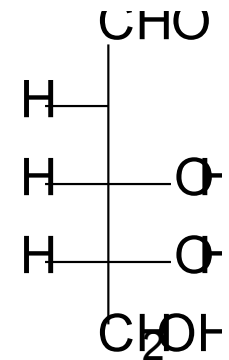

2-deoxy-D-ribosa

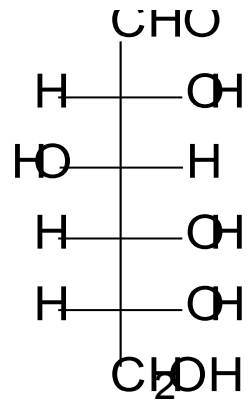

D-glukosa

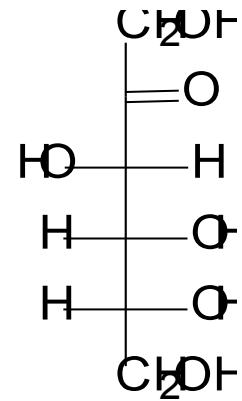

D-fruktosa

Tollensovy vzorce *D*-glukosy:

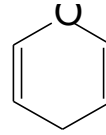
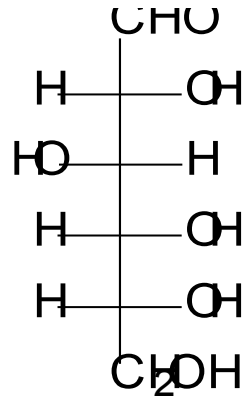

Pyran

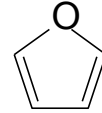

Furan

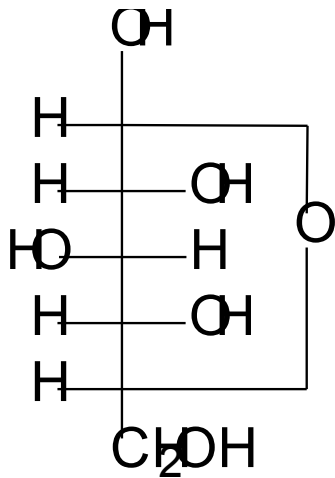

α-*D*-glukopyranosa

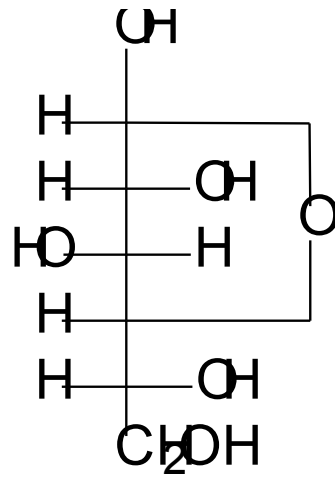

α-*D*-glukofuranosa

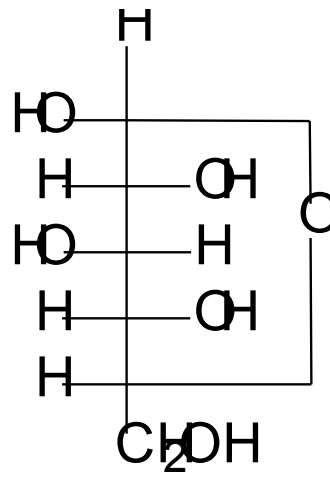

β-*D*-glukopyranosa

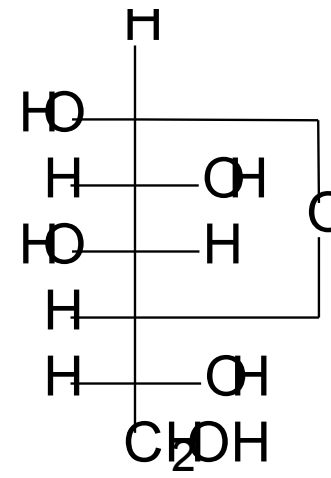

β-*D*-glukofuranosa

Haworthovy vzorce *D*-glukosy:

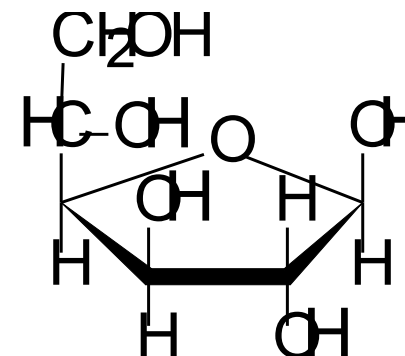
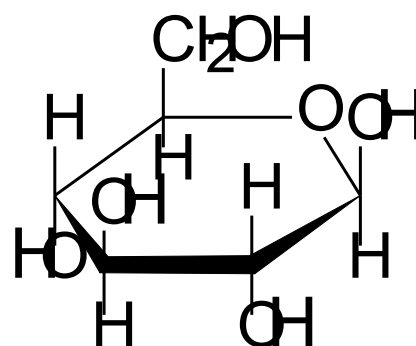
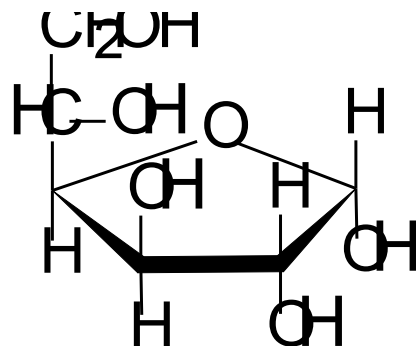
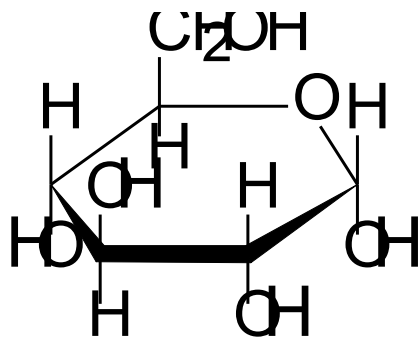
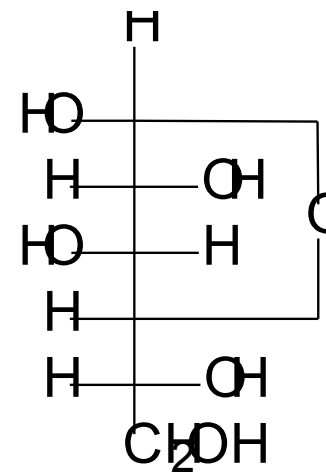
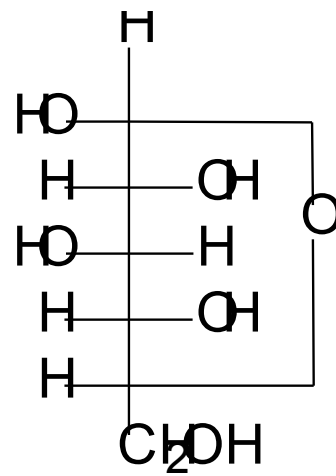
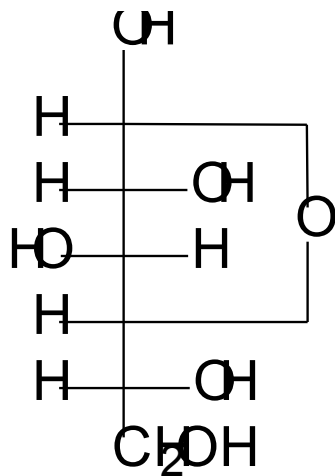
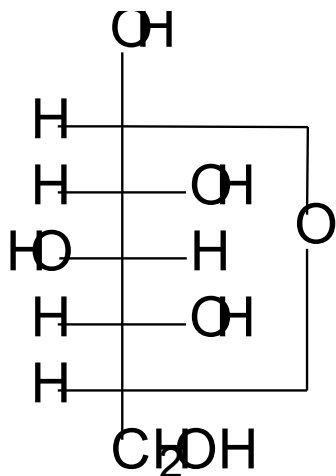

α -D-glukopyranosa

α -D-glukofuranosa

β -D-glukopyranosa

β -D-glukofuranosa

Vlevo – nad

Vpravo - pod

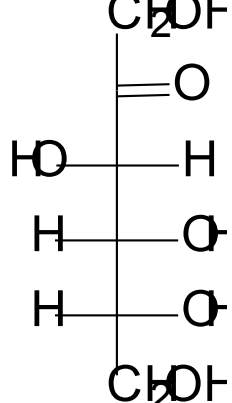

Tollensovy vzorce fruktofuranosy:

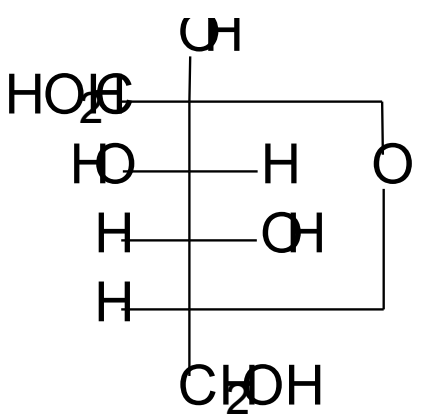

α-D-fruktofuranosa

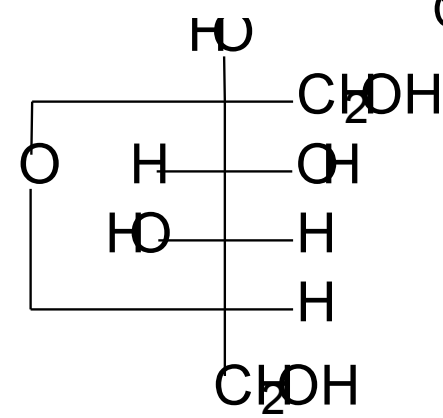

α-L-fruktofuranosa

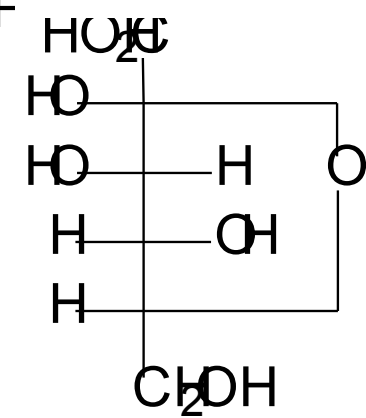

β-D-fruktofuranosa

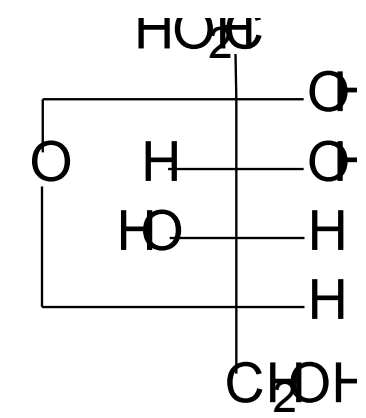

β-L-fruktofuranosa

Haworthovy vzorce fruktofuranosy:

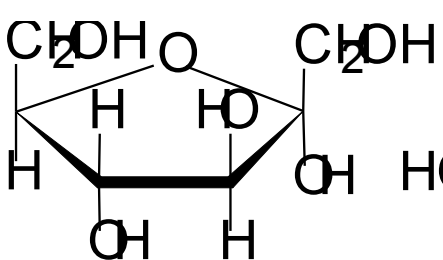

α-D-fruktofuranosa

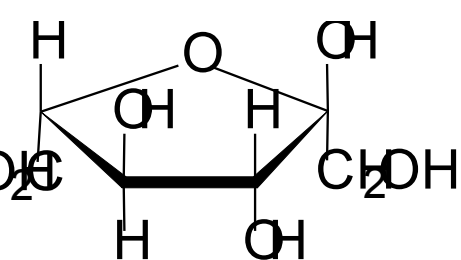

α-L-fruktofuranosa

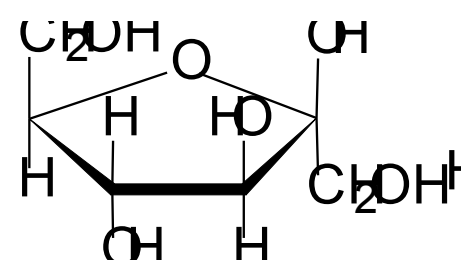

β-D-fruktofuranosa

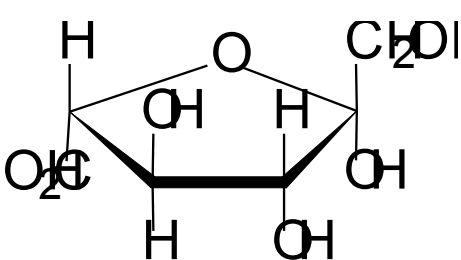

β-L-fruktofuranosa

Přehled

Triosy - glycerinaldehyd, dihydroxyaceton

Tetrosy - threosa, erythrosa

Pentosy - ribosa, deoxyribosa

Hexosy - glukosa, manosa, galaktosa

fruktosa

Heptosa - sedoheptulosa

Aldosy

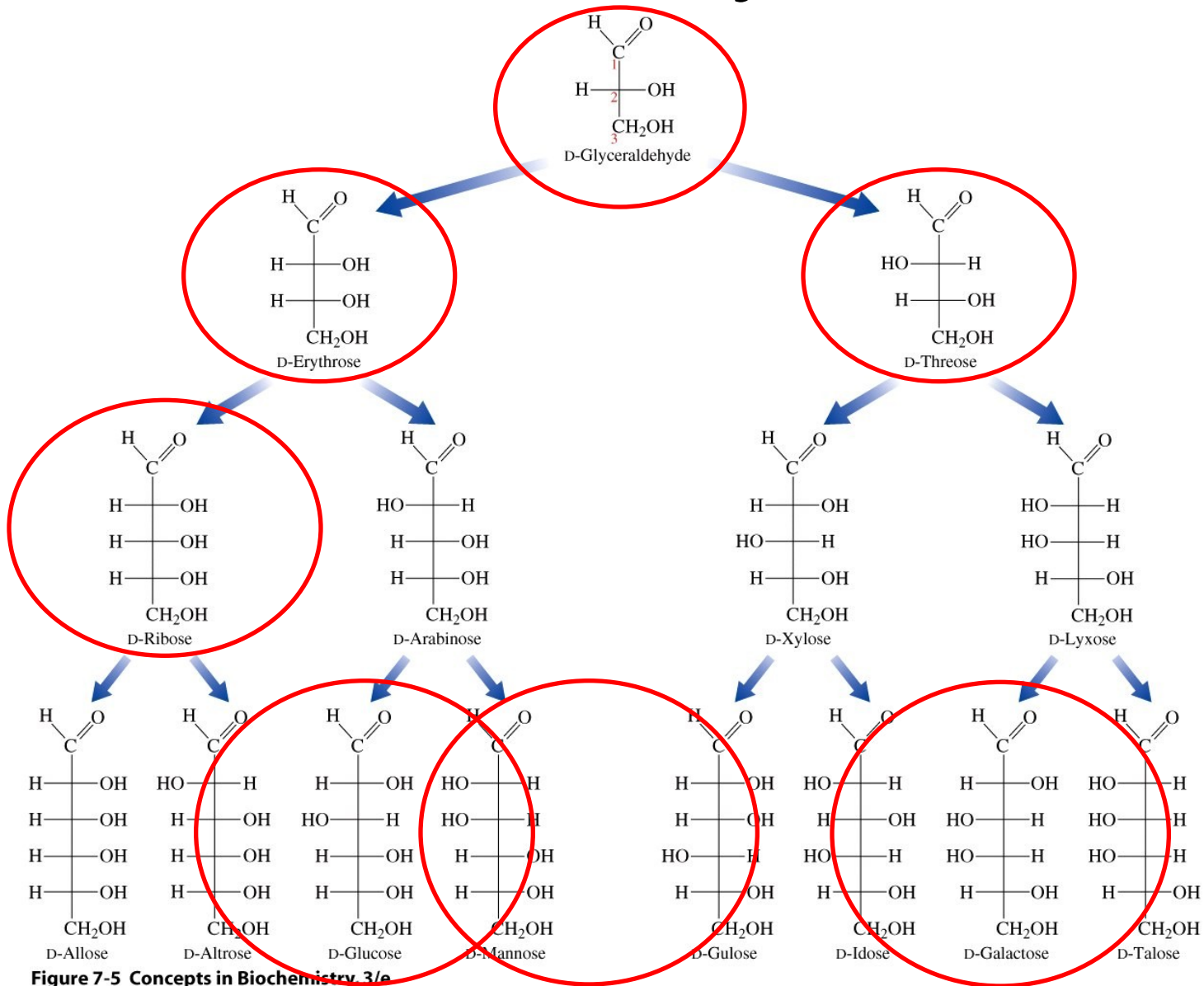

Figure 7-5 Concepts in Biochemistry, 3/e

Ketose

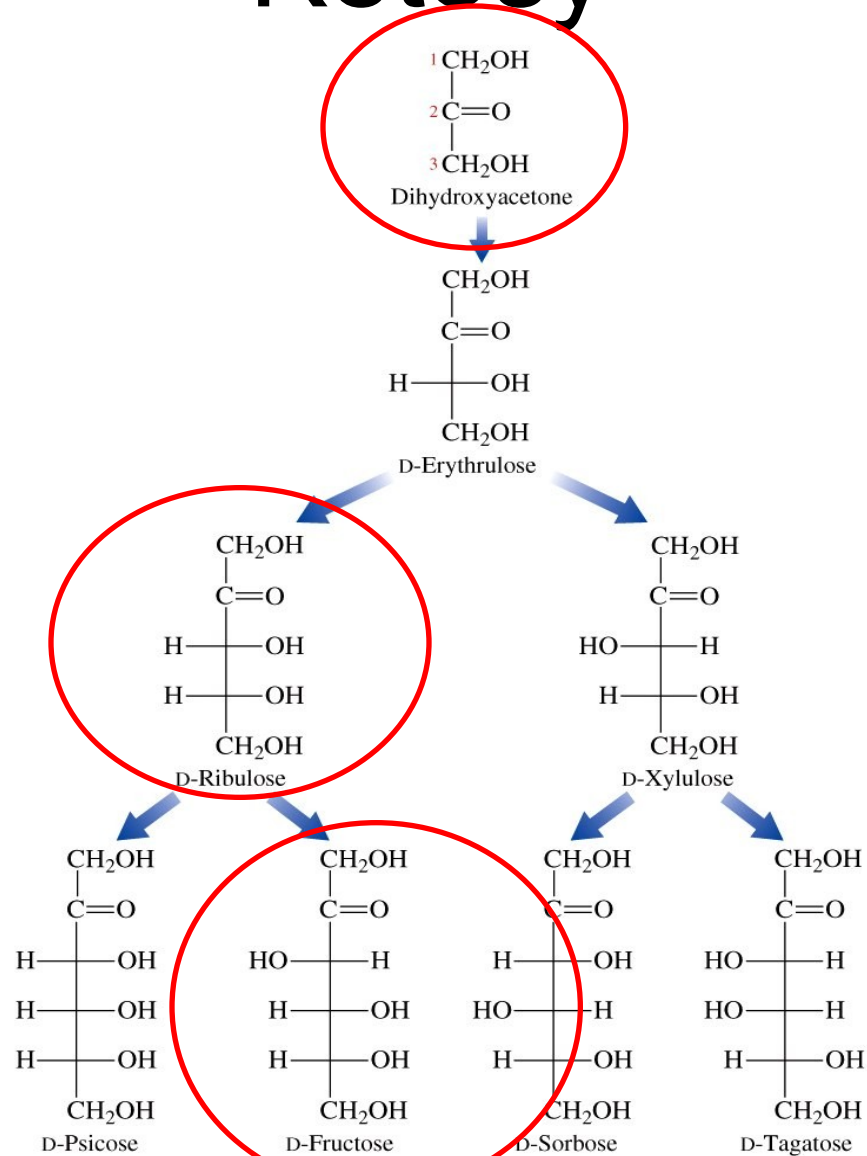
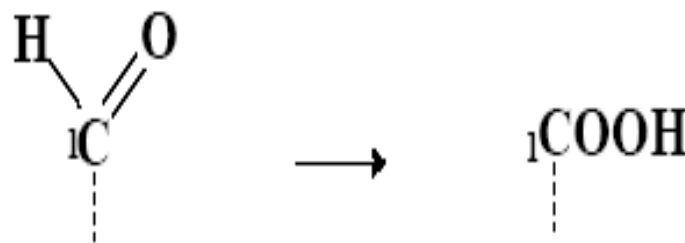

Figure 7-6a Concepts in Biochemistry, 3/e
© 2006 John Wiley & Sons

Deriváty monosacharidů

Oxidace :

A. Mírná \Rightarrow aldehydická skupina \rightarrow karboxylovou skupinu



ALDONOVÉ KYSELINY - glukosa \rightarrow k. glukonová

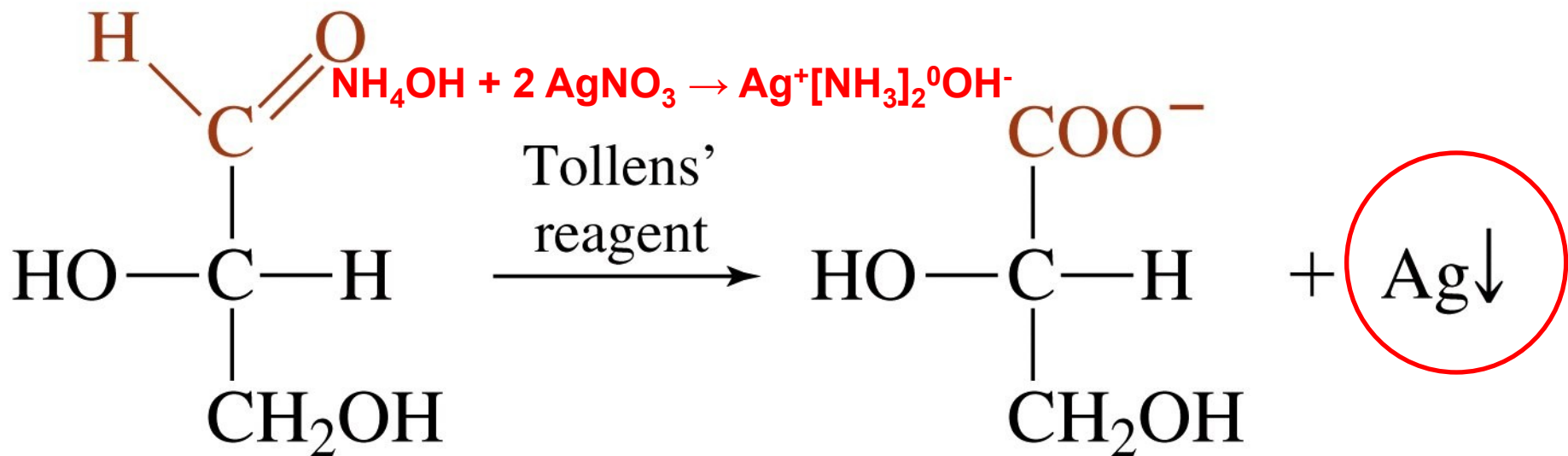

Figure 7-11a Concepts in Biochemistry, 3/e
© 2006 John Wiley & Sons

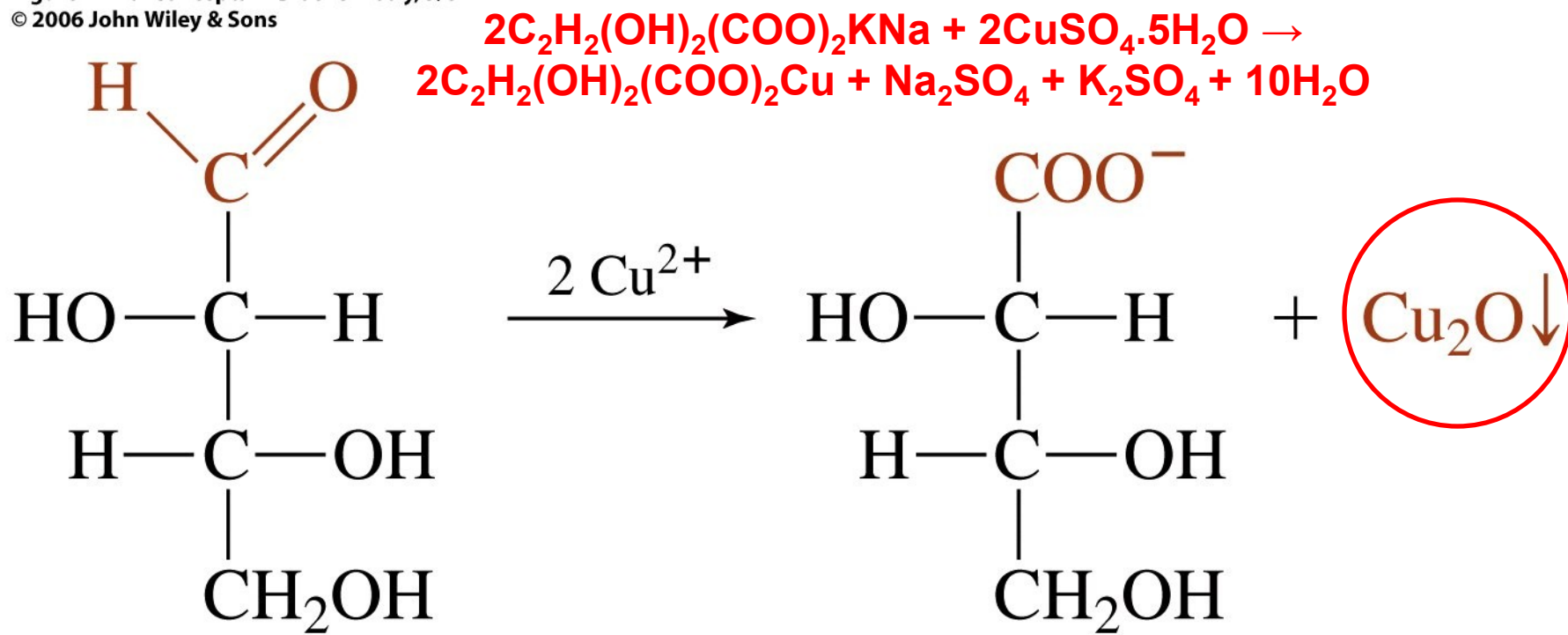

Figure 7-11b Concepts in Biochemistry, 3/e
© 2006 John Wiley & Sons

B. Specifická \Rightarrow primární OH skupina \rightarrow karboxylovou skupinu



URONOVÉ KYSELINY - glukosa \rightarrow k. glukuronová

C. Silná \Rightarrow aldehydická skupina + primární OH skupina

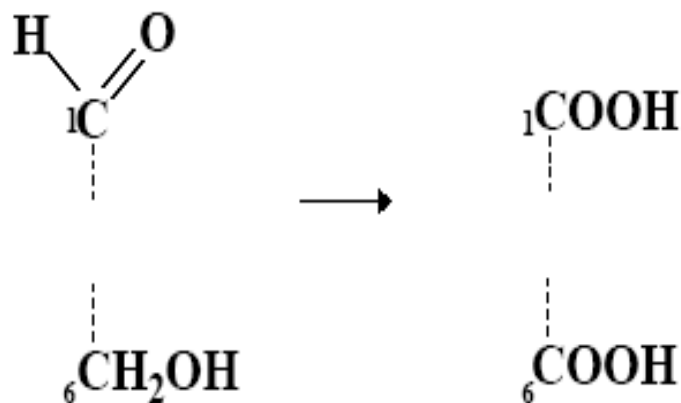

ALDAROVÉ KYSELINY - glukosa \rightarrow k. glukarová

Tvorba laktonů u aldonových a uronových kyselin

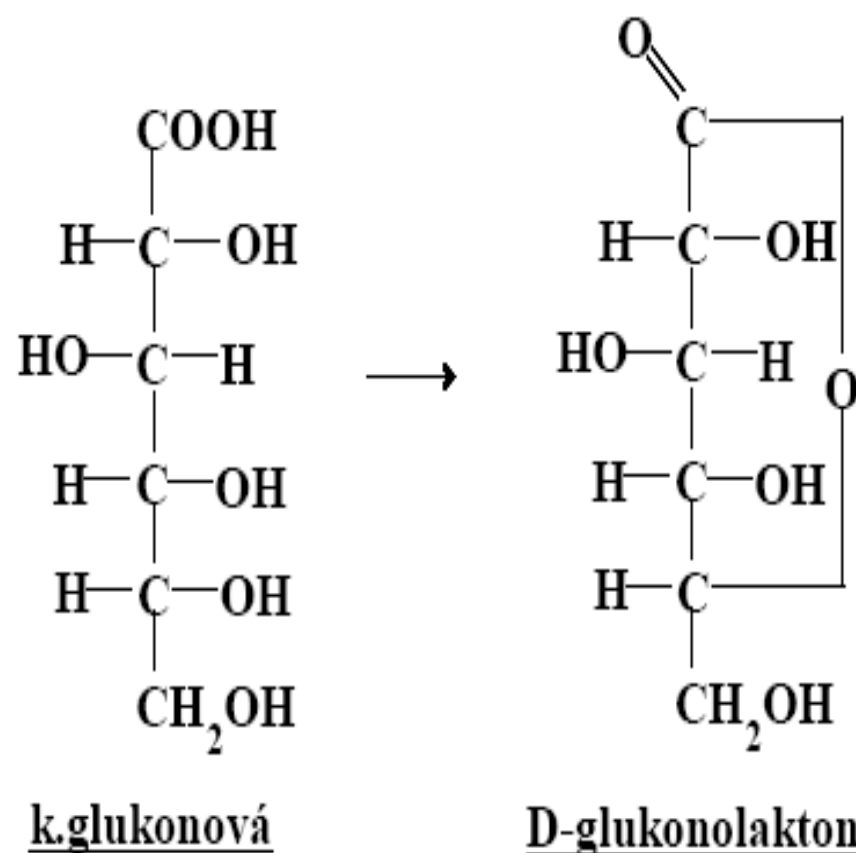

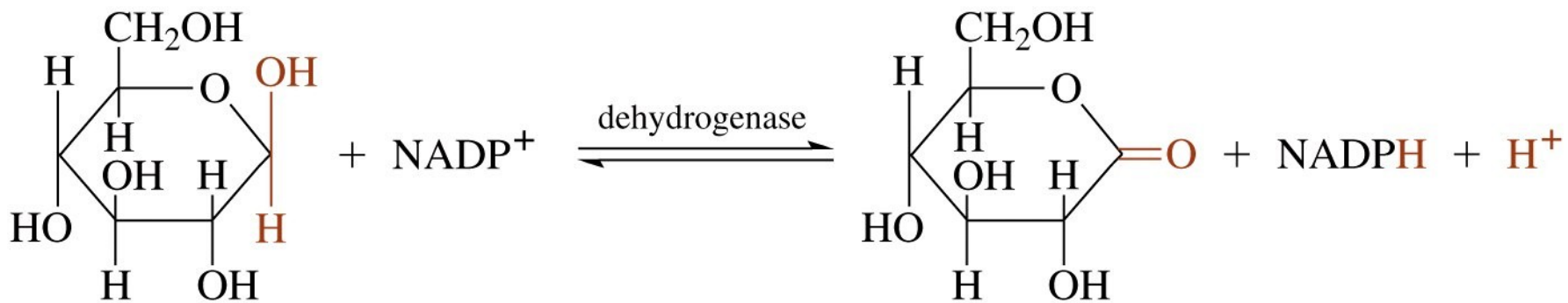
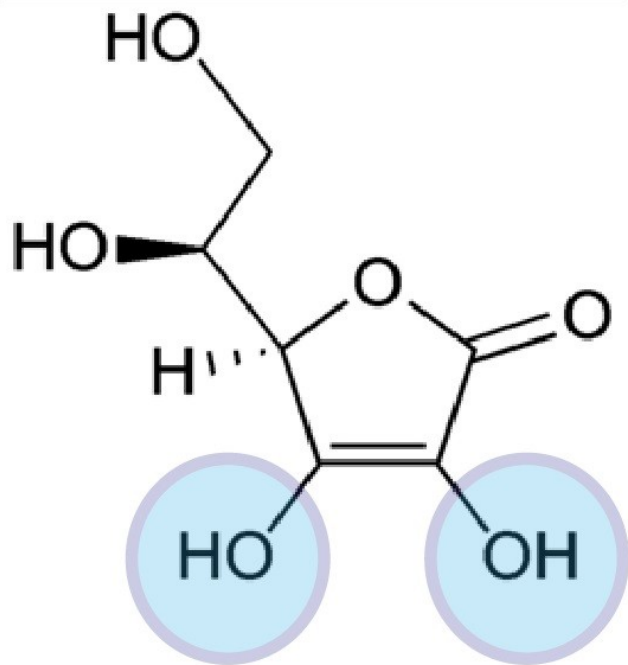
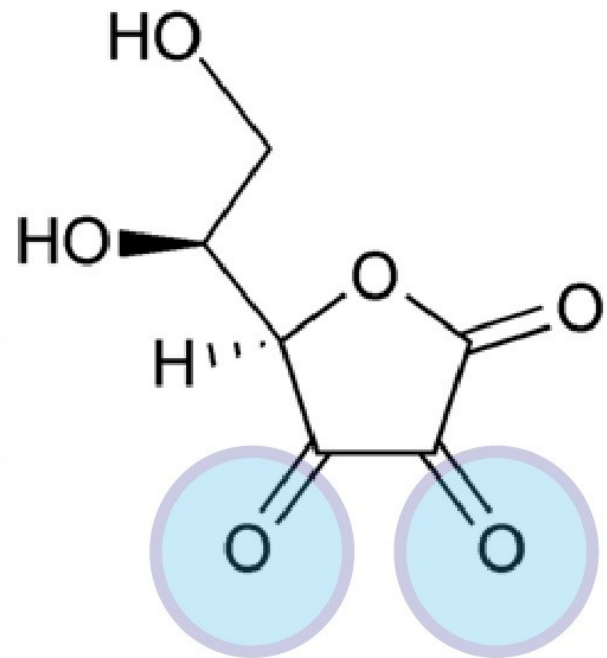
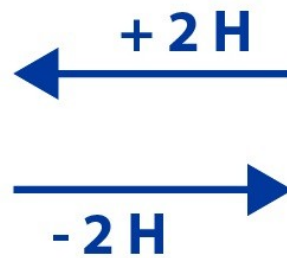

Figure 7-11c Concepts in Biochemistry, 3/e
© 2006 John Wiley & Sons



L-askorbová kyselina



L-dehydroaskorbová kyselina

Redukce :

mírná \Rightarrow karbonylová skupina \rightarrow hydroxy skupinu

POLYHYDROXYALKOHOLY - ALDITOLY -itol

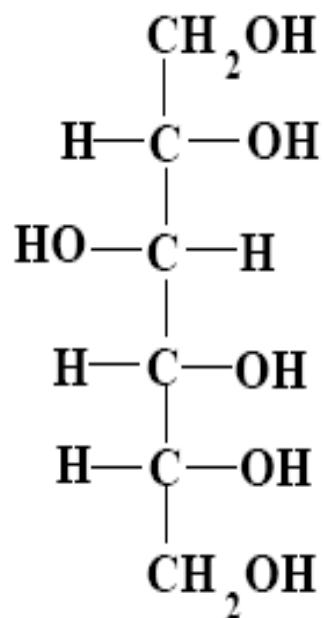

GLUCITOL - SORBITOL

Deoxycukry - OH skupina nahrazena H

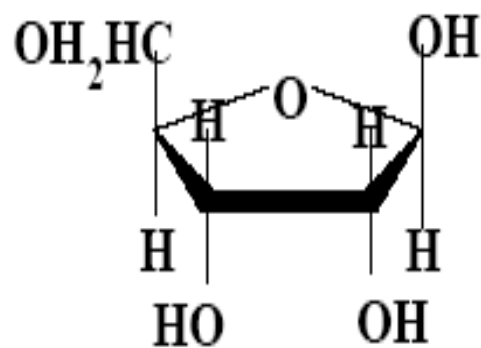

RIBOSA

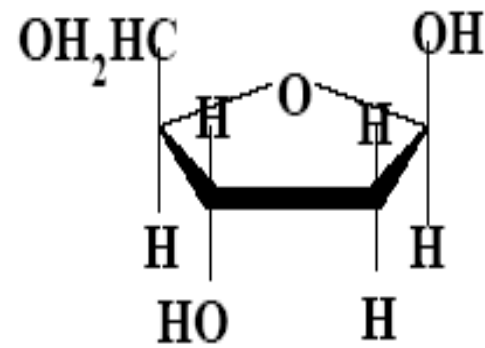

DEOXYRIBOSA

Aminocukry - OH skupina nahrazena NH₂ skupinou

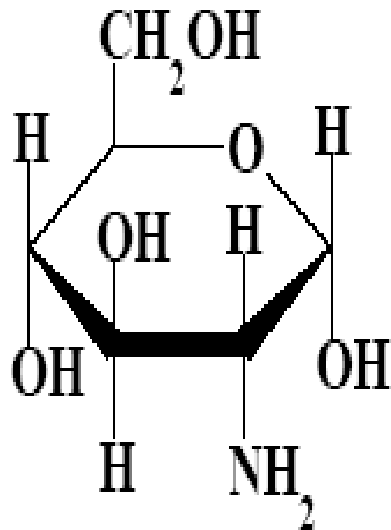

GLUKOSAMIN

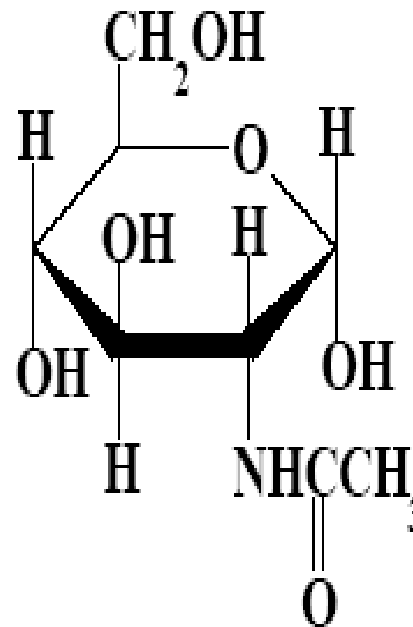

N-ACETYLGLUKOSAMIN

N-acetylglucosamin – chitin

N-acetylgalaktosamin – chondrotinisulfát

Sialové kyseliny - kondenzace N-acetylmanosaminu + pyruvátu

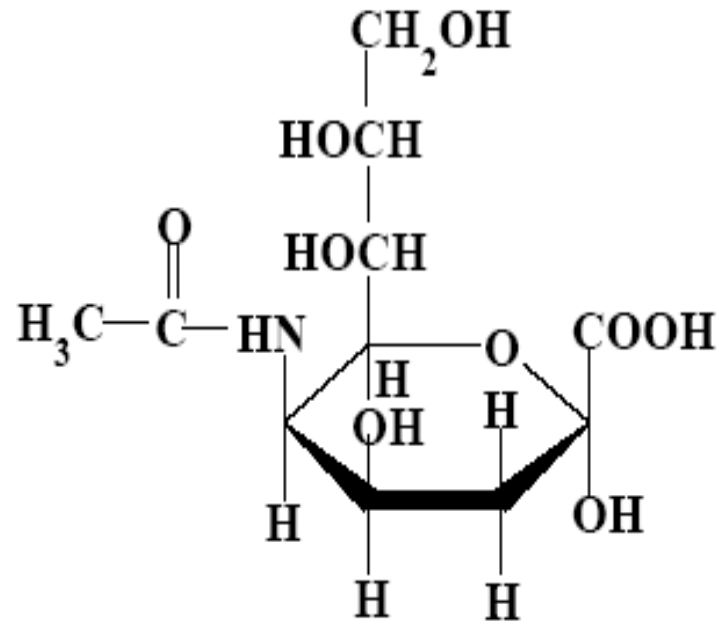

K. SIALOVÁ

Glykosidy :

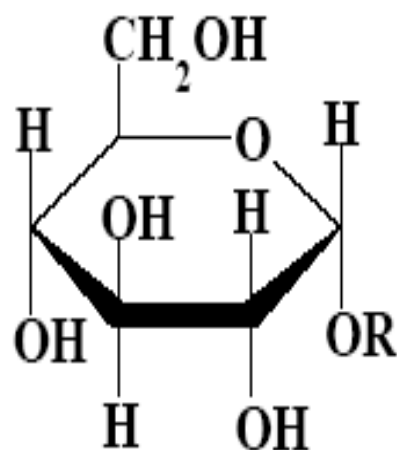

O-glukosid

glykosidická vazba - OR, SR, NR - specificky štěpí glykosidasy

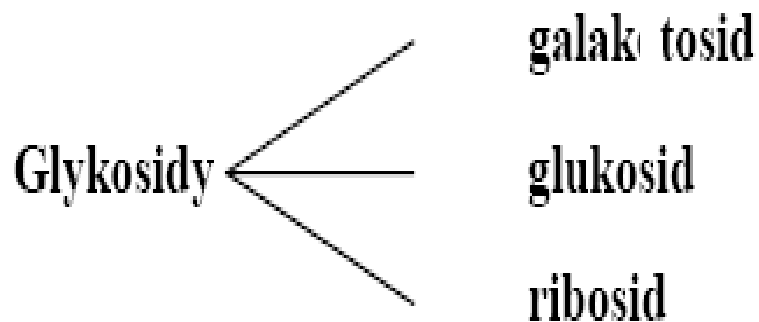
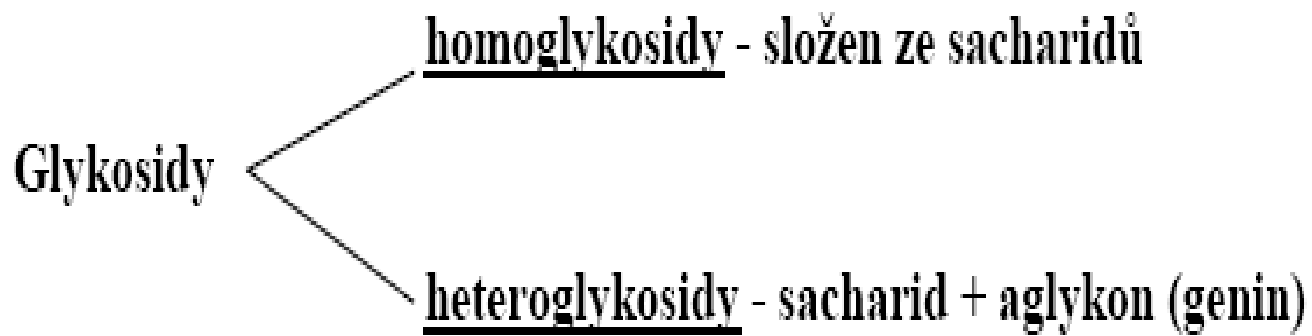

Disacharidy :

A. Neredukující - trehalosový typ - yl - id

O - α - D - glukopyranosyl (1 \rightarrow 1) - α - D - glukopyranosid

B. Redukující - maltosový typ - yl - osa

O - α - D - glukopyranosyl (1 \rightarrow 4) - α - D - glukopyranosa

Neredukující disacharidy

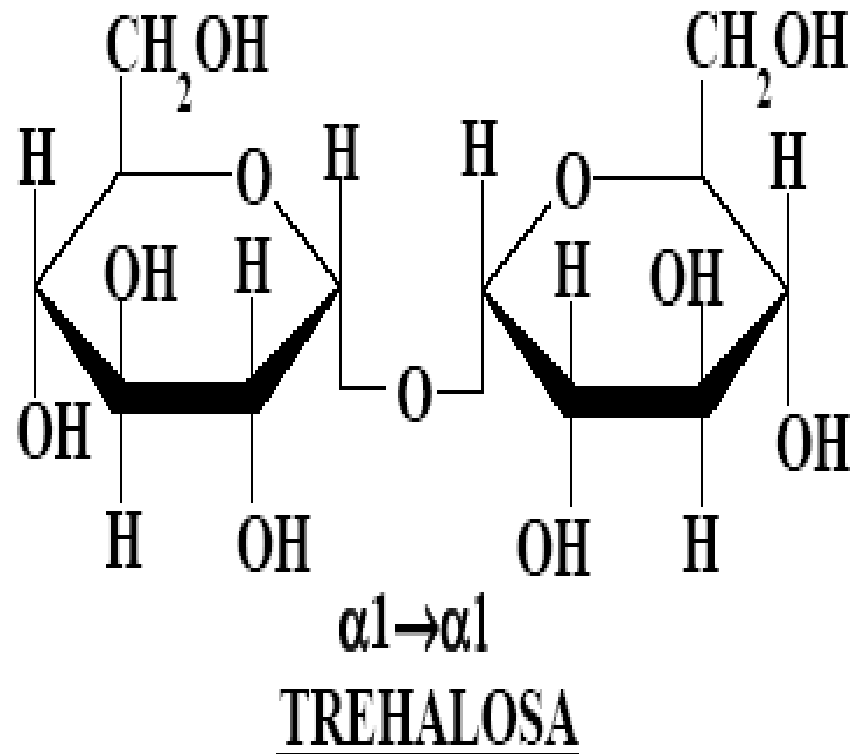

O - α - D - glukopyranosyl (1 \rightarrow 1) - α - D - glukopyranosid

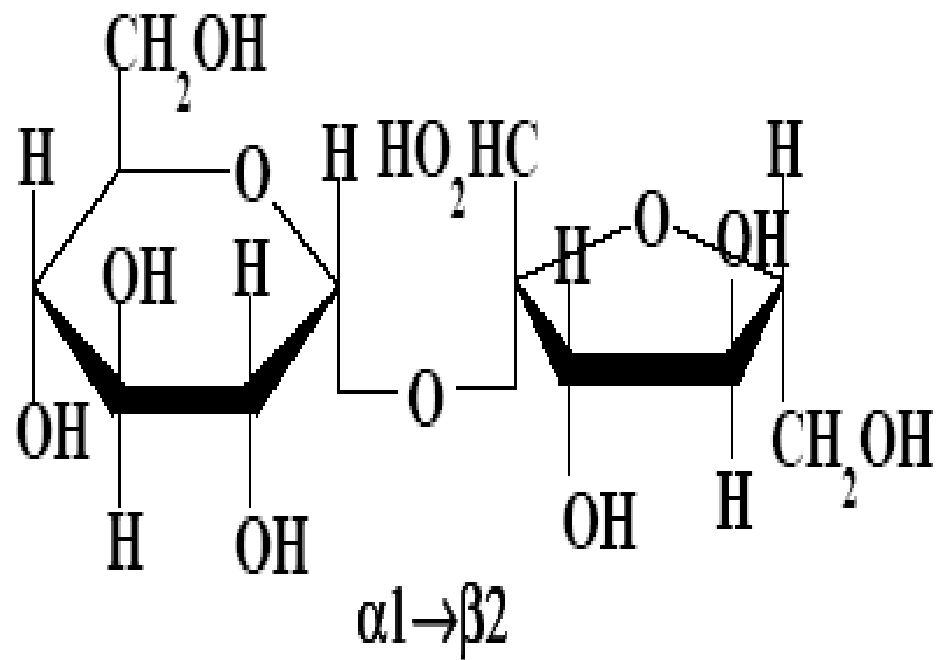

SACHAROSA

O - α - D - glukopyranosyl (1→2) - β - D - fruktofuranosid

Redukující disacharidy

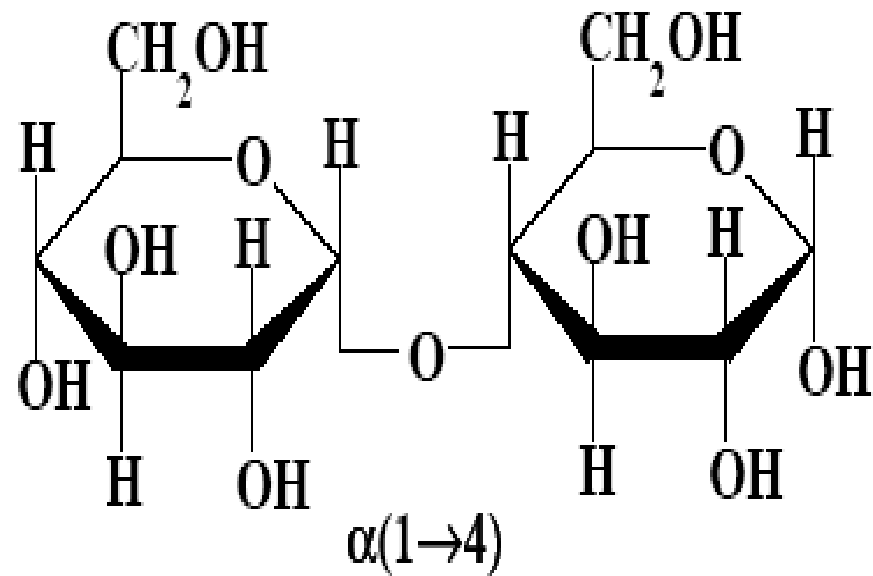

MALTOSA

O - α - D - glukopyranosyl (1 \rightarrow 4) - α - D - glukopyranosa

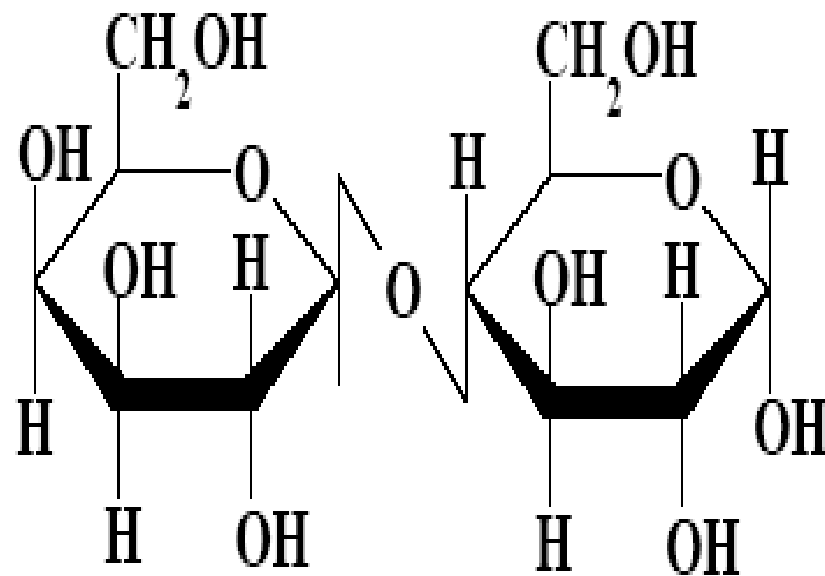

$\beta(1\rightarrow4)$

LAKTOSA

O - β - D - galaktopyranosyl (1 \rightarrow 4) - β - D - glukopyranosa

Intolerance na laktosu

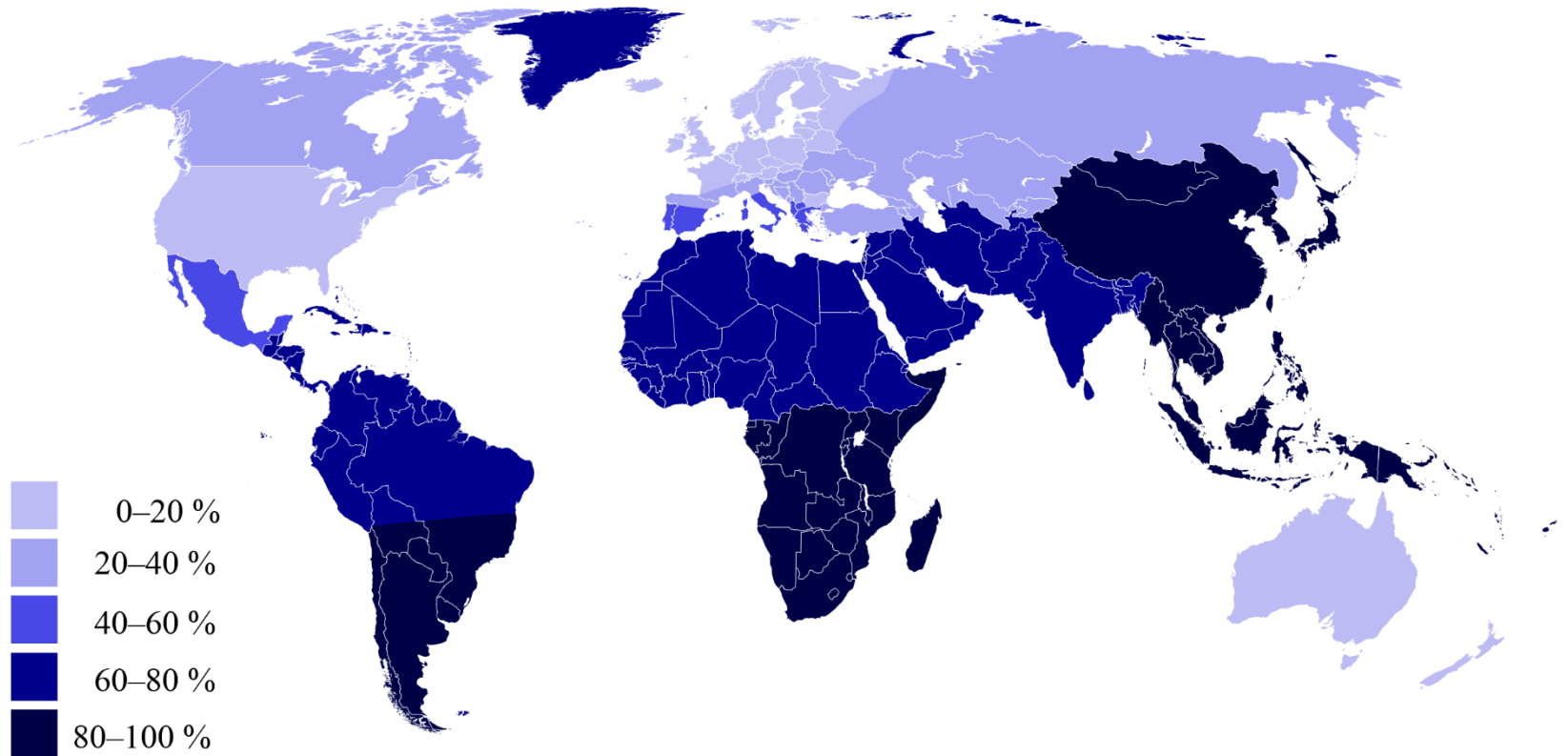

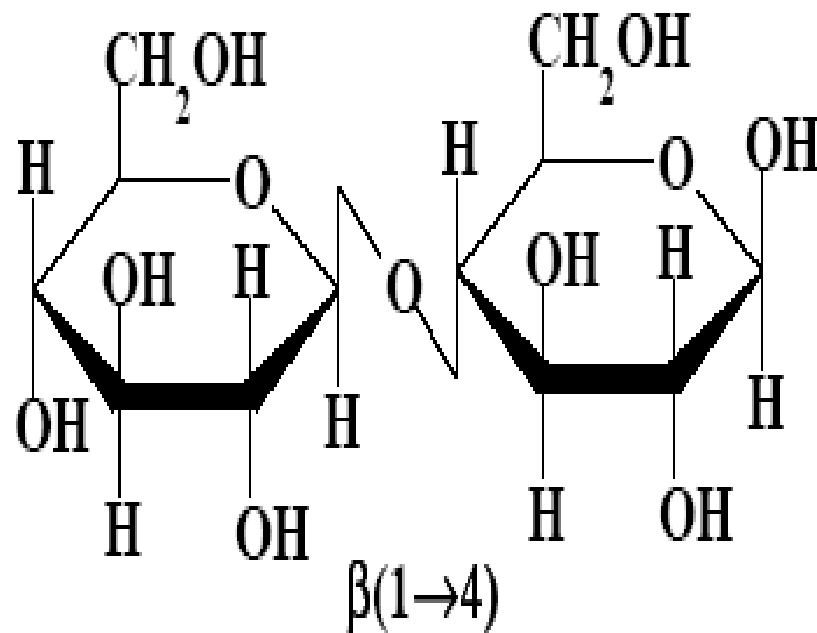

CELLOBIOSA

O - β -D - glukopyranosyl (1 \rightarrow 4) - β -D - glukopyranosa

Polysacharidy :

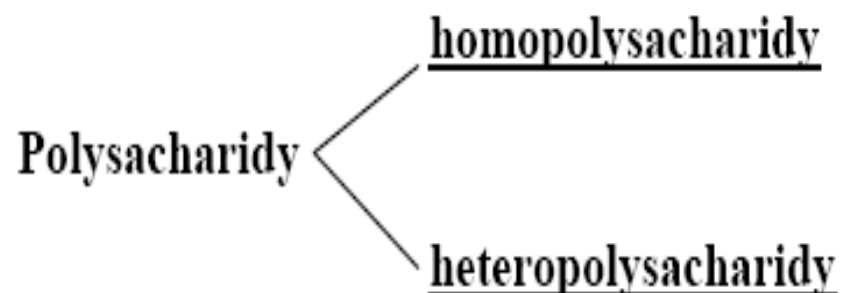

- Funkce - stavební
- zásobní

Metylační analýza

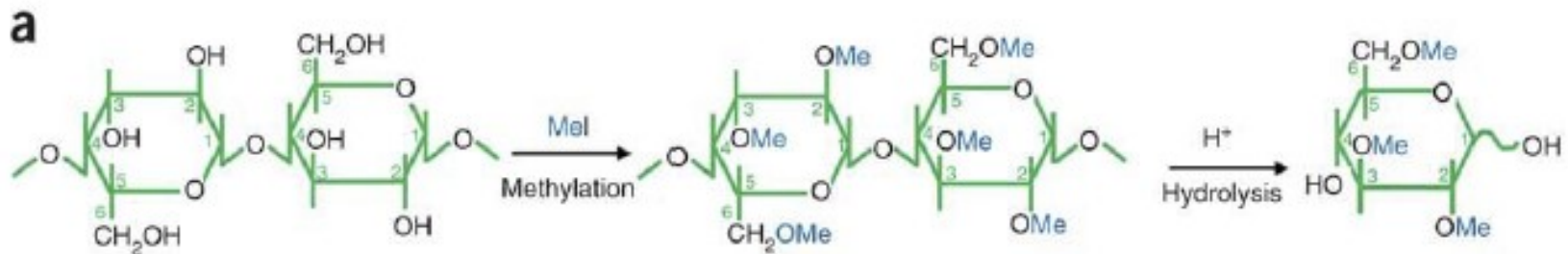

HOMOPOLYSACHARIDY

Stavební homopolysacharidy :

CELULOZA - glukosa (celobiosa)

CHITIN - N-acetylglukosamin

AGAROSA - galaktosa + 3, 6 - anhydrogalaktosa

PEKTINY - galakturonová kyselina

Celulosa

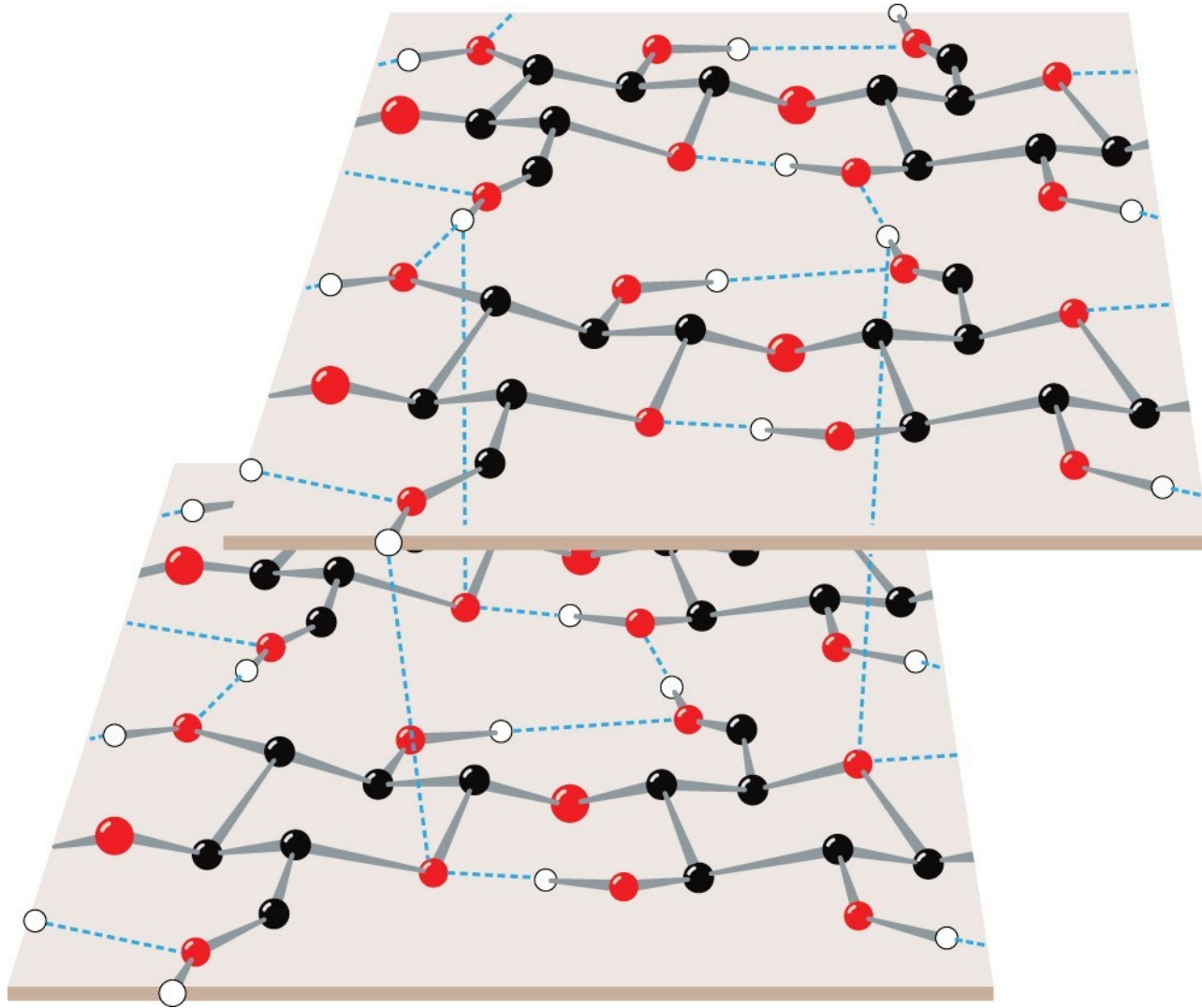

Hemicelulosa

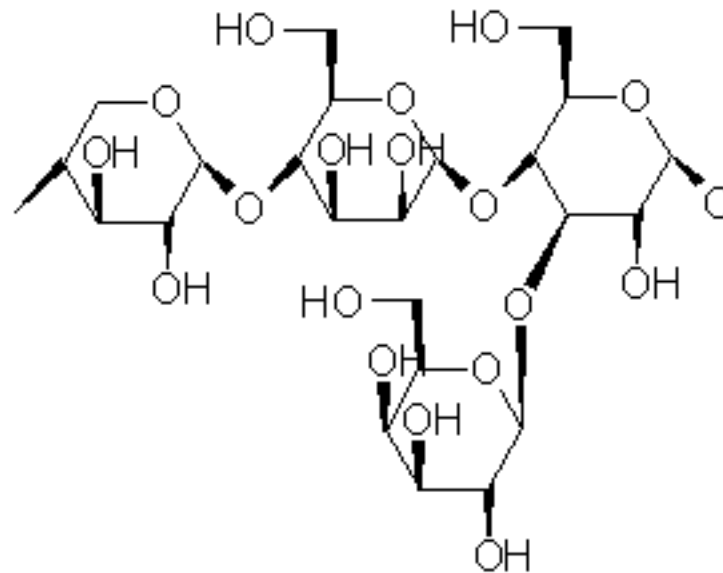

- Xylose - $\beta(1,4)$ - Mannose - $\beta(1,4)$ - Glucose -
- $\alpha(1,3)$ - Galactose

Hemicellulose

Pektiny

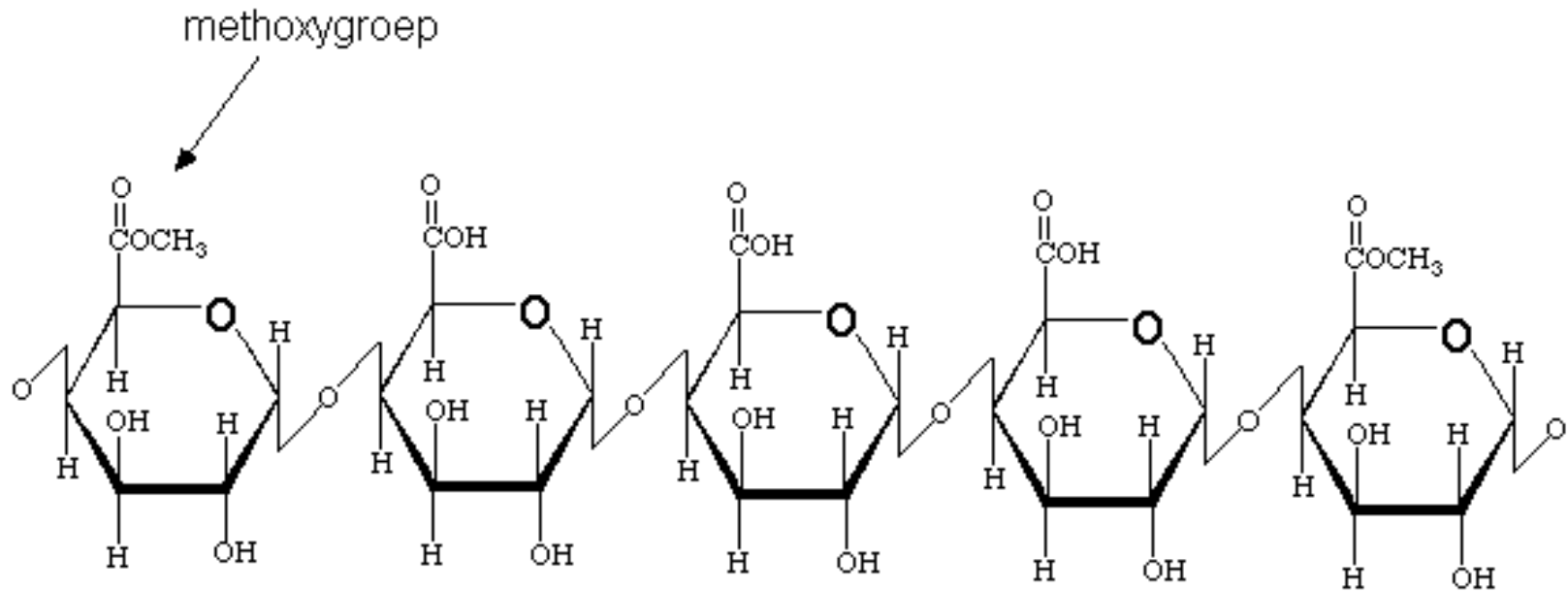

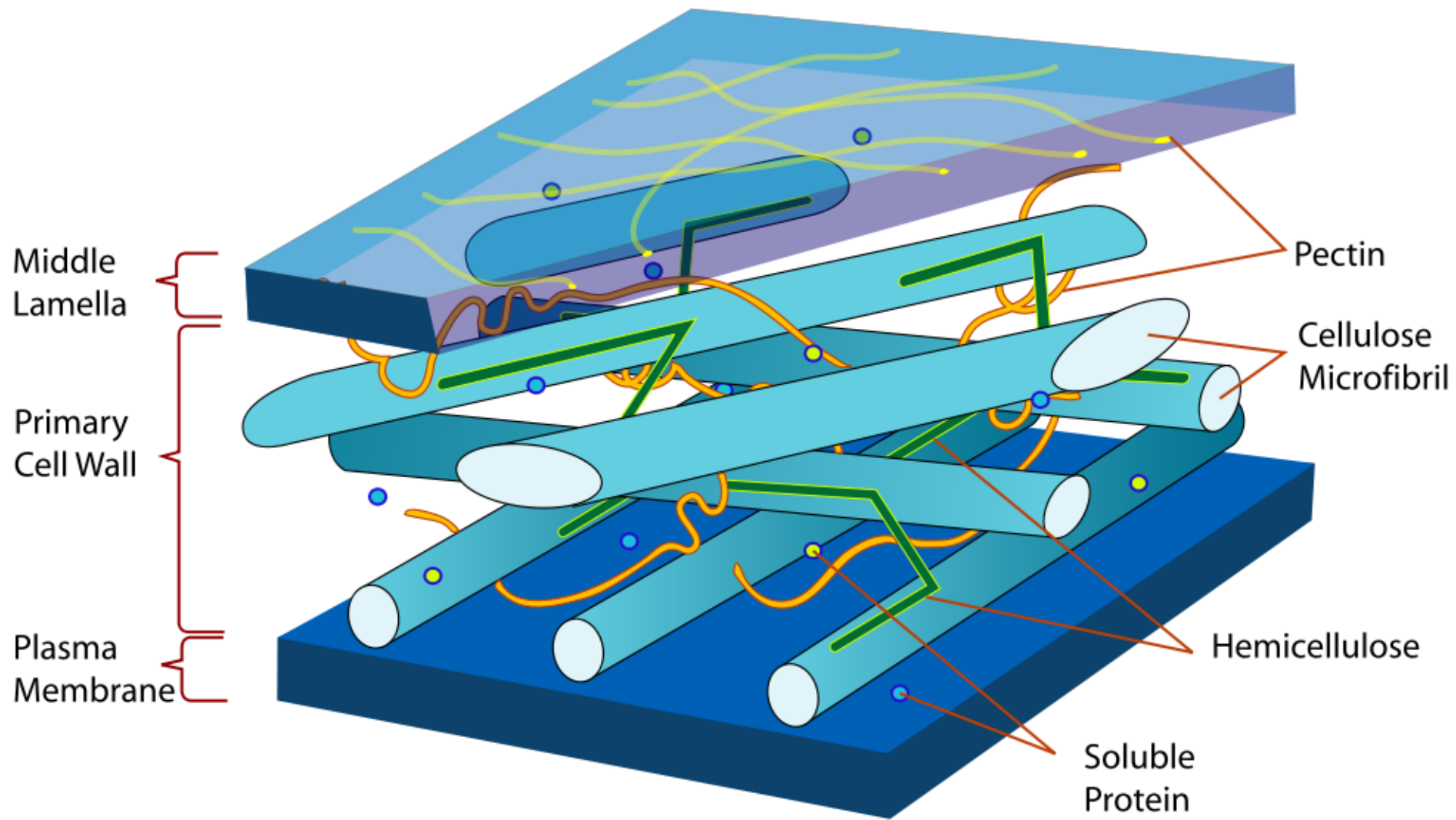



Lignin

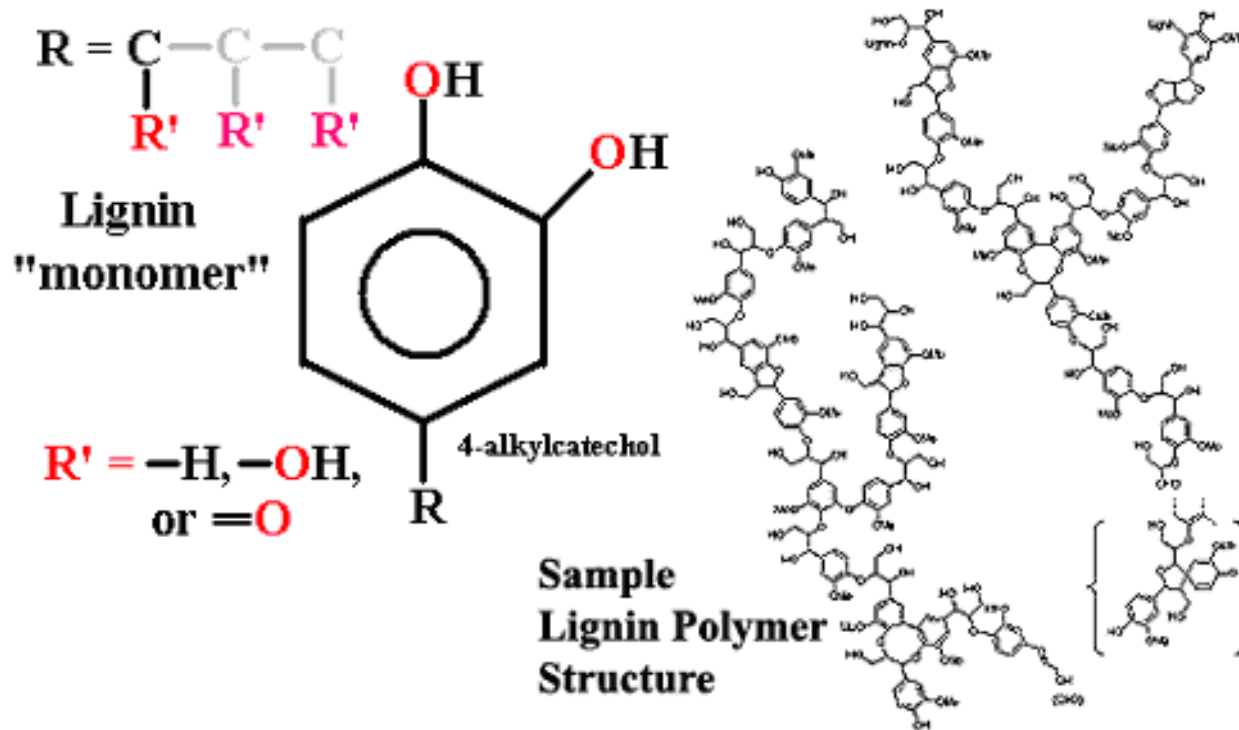

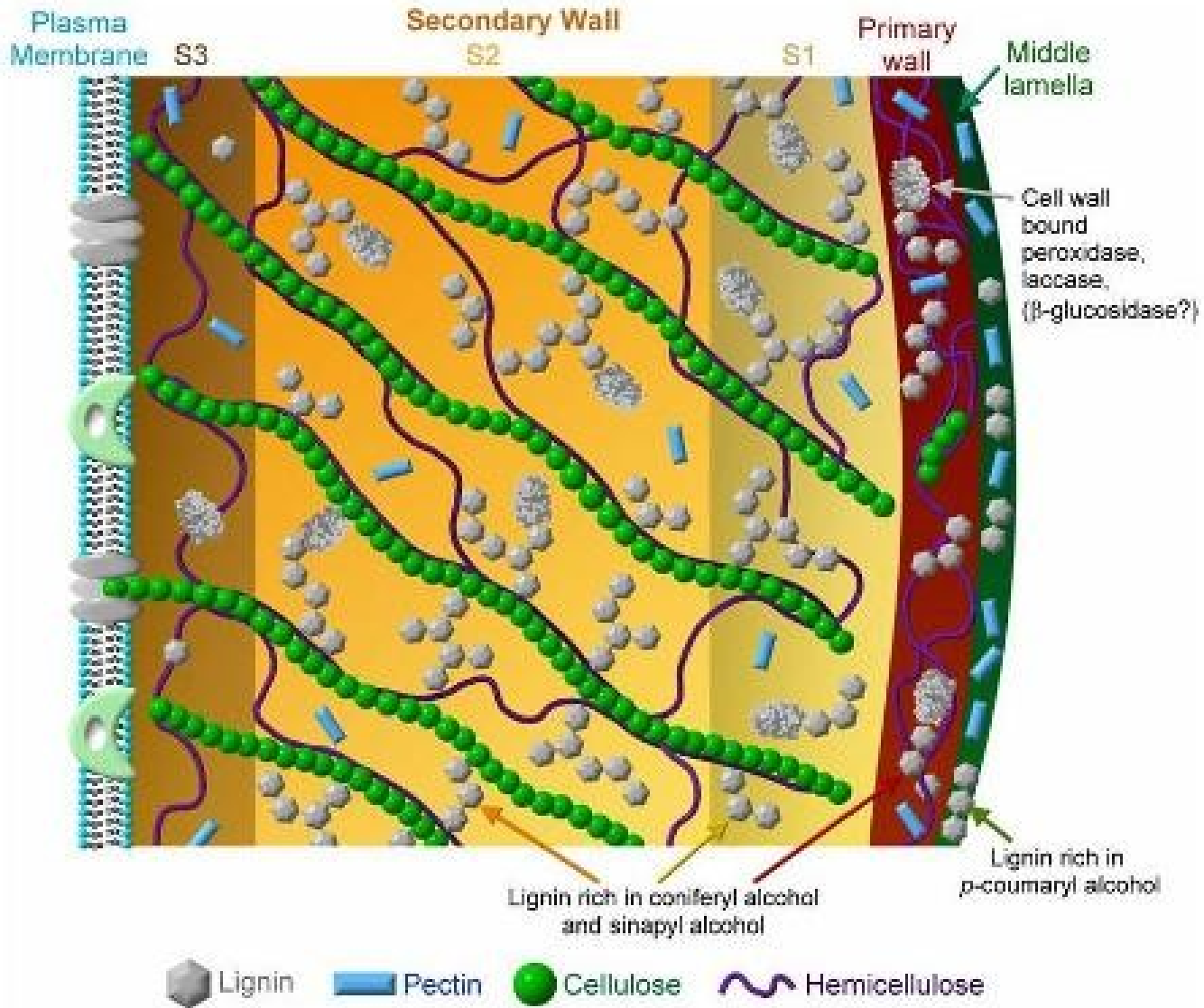

Chitin

(c) Chitin

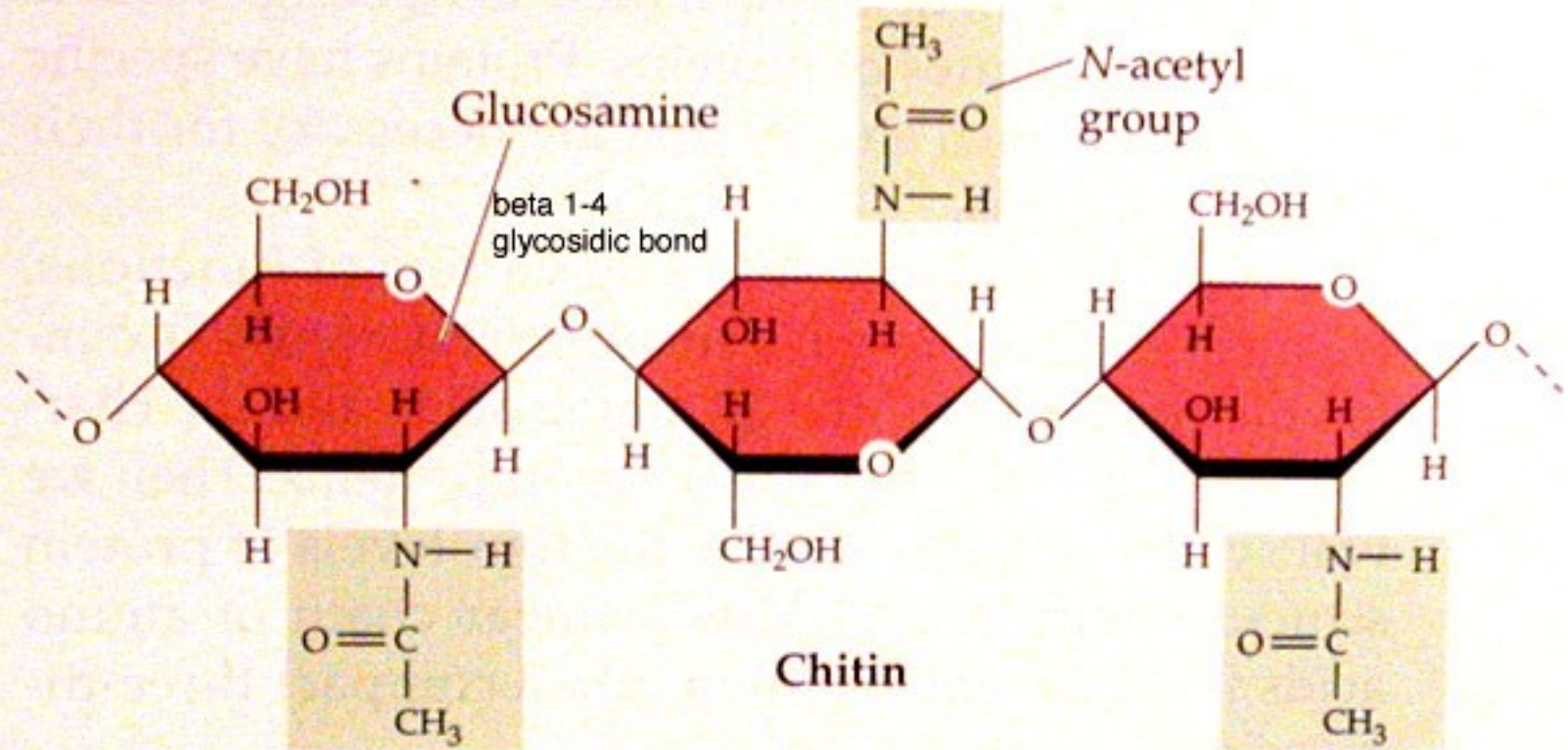

CELLULOSE



CHITIN



Agarosa

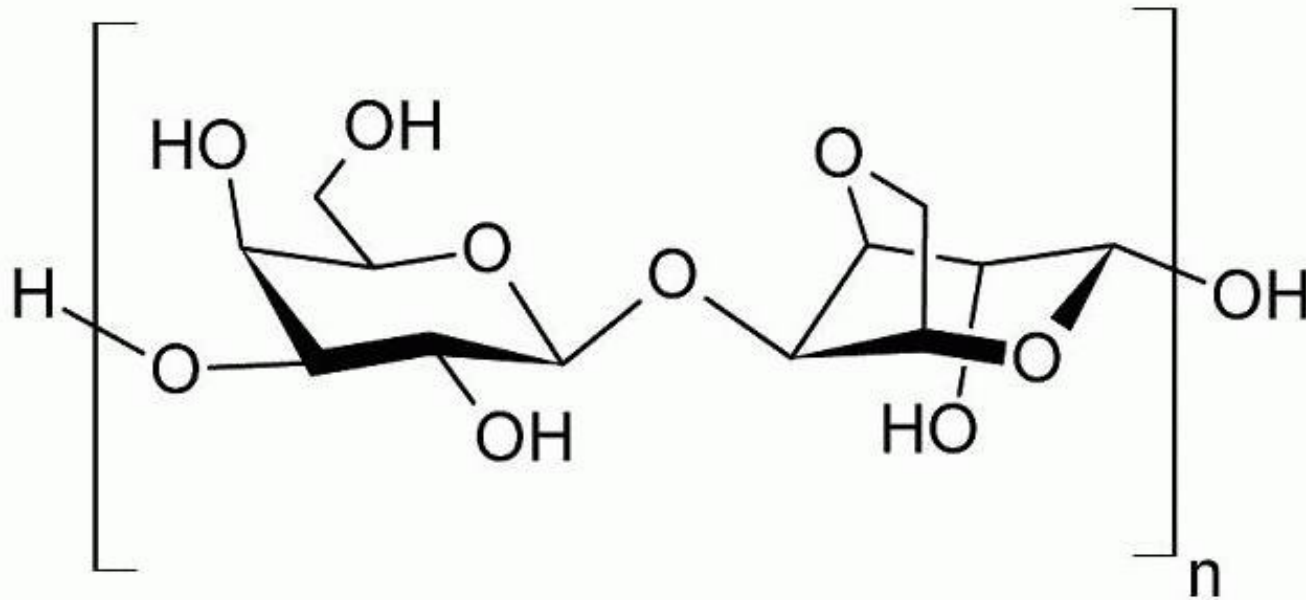

Zásobní homopolysacharidy :

ŠKROB - amylosa - glukosa - α (1→4) - 20 %

(40 - 150 000 MW)

amylopektin - glukosa - α (1→4) + α (1→6) - 80 %

(50 000 MW)

GLYKOGEN - glukosa - α (1→4) + α (1→6)

DEXTRAN - glukosa - α (1→6) + α (1→4) + α (1→3)

INULIN - fruktosa β (1→)

Amylose

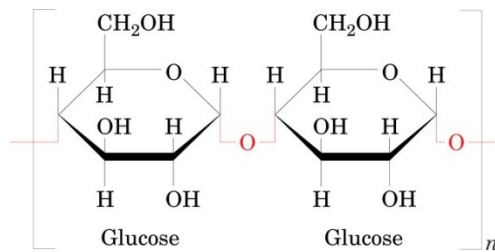

α -Amylose

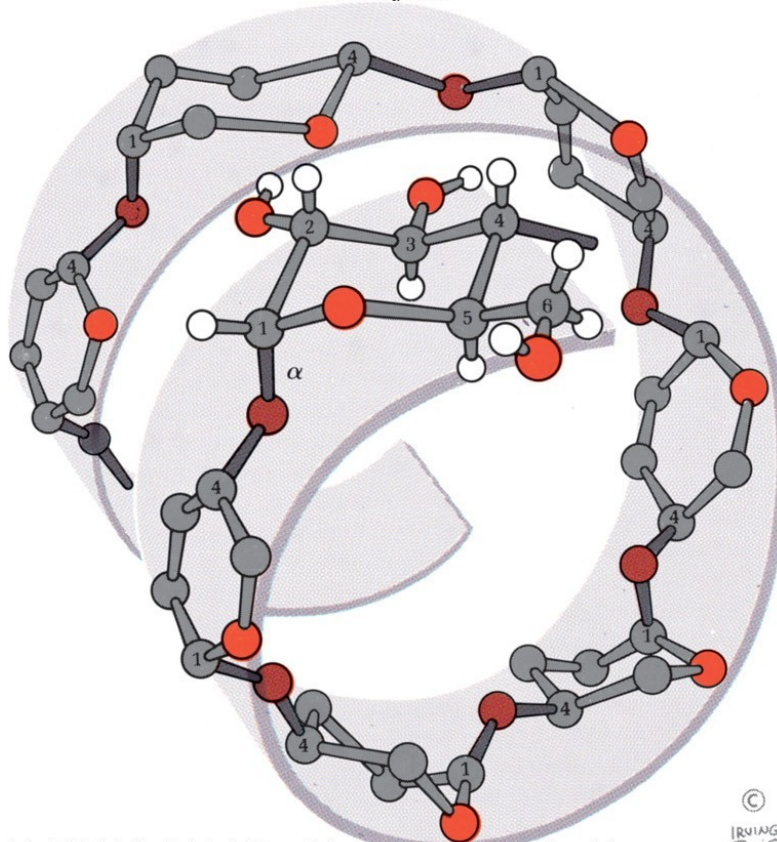

Amylopektin

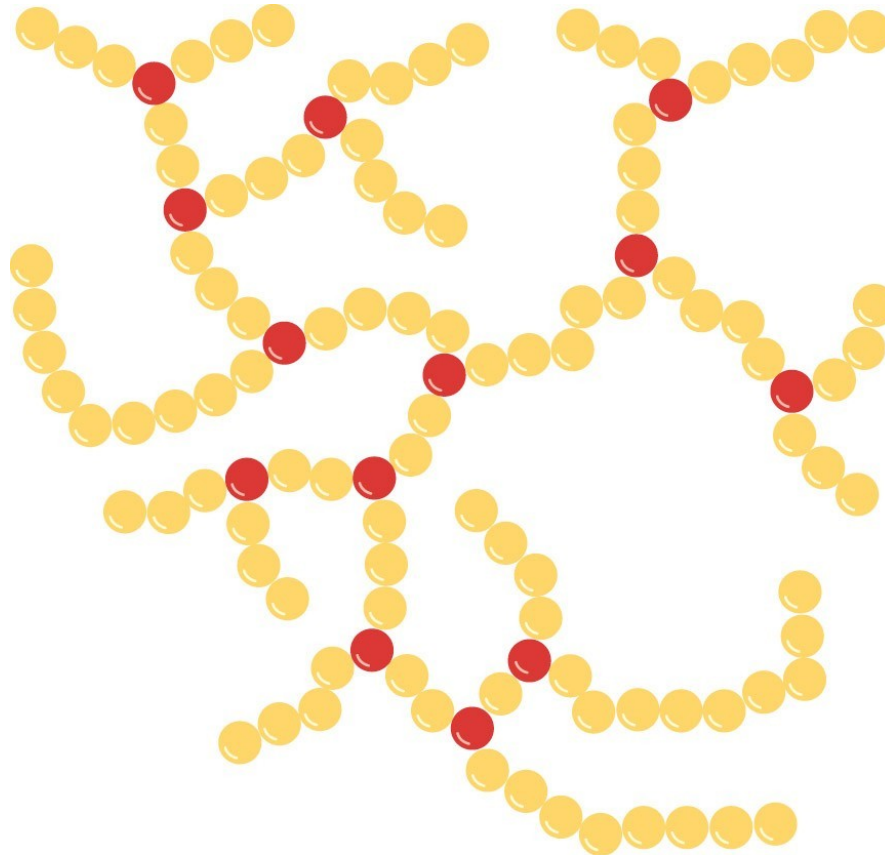
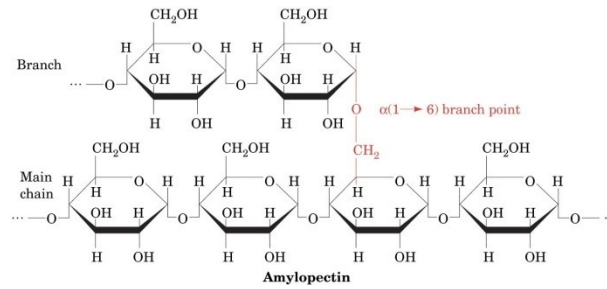

Glykogen

glykolysa

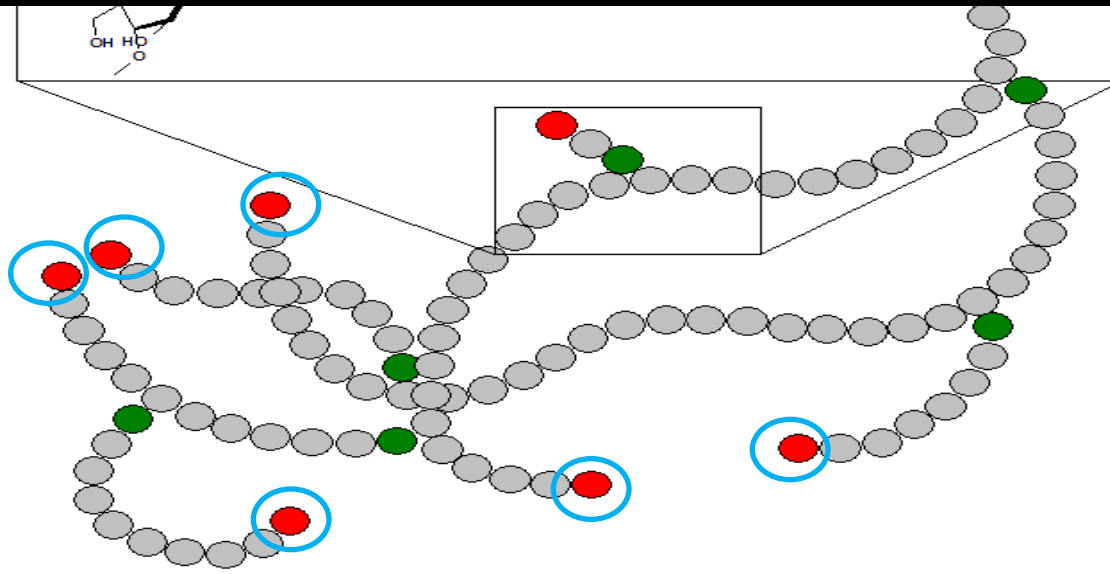
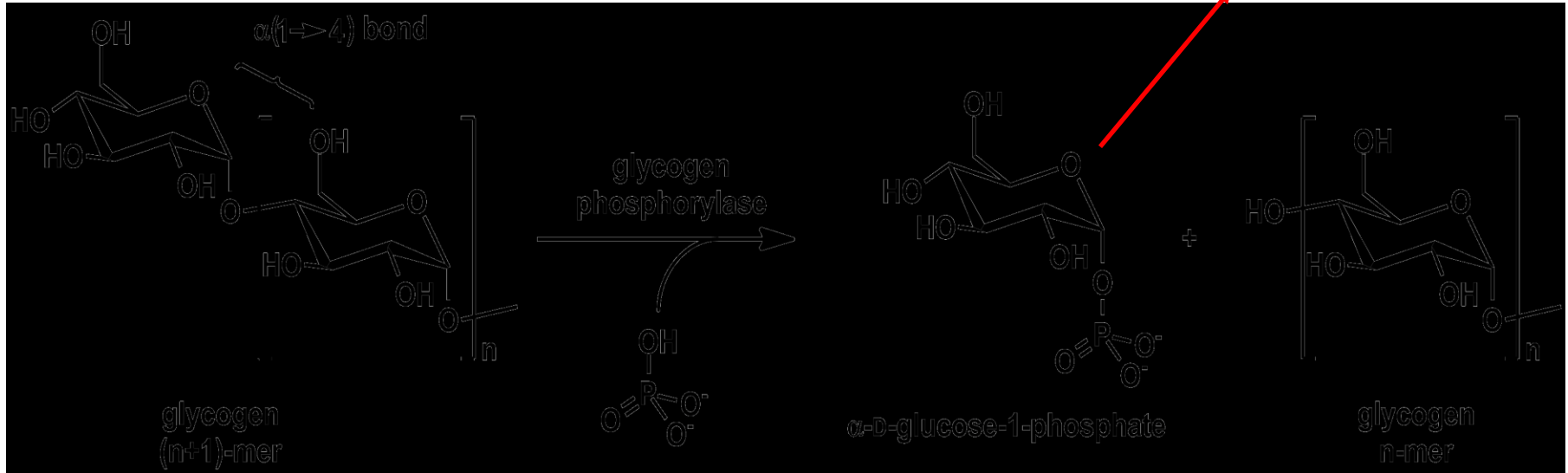

Škrob (a) a glykogen (b)

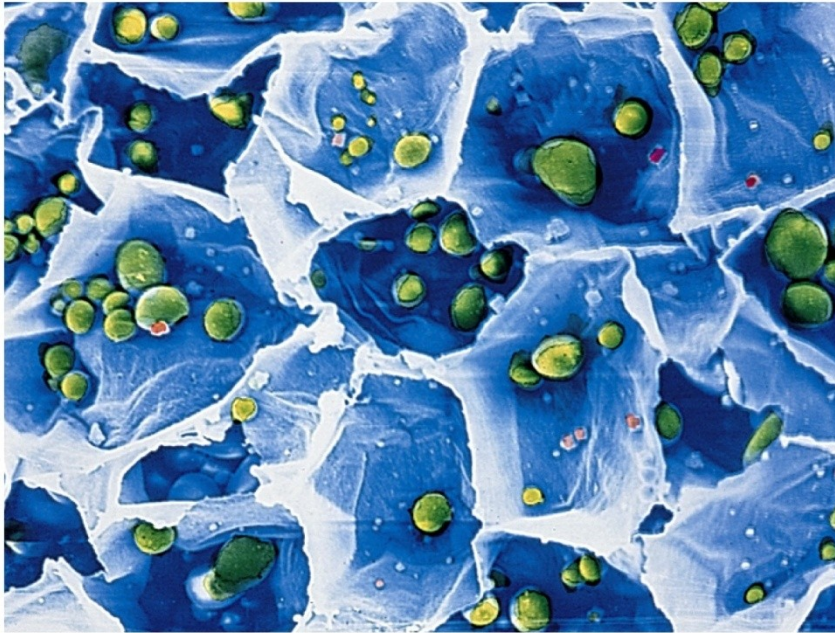

Figure 7-19a Concepts in Biochemistry, 3/e

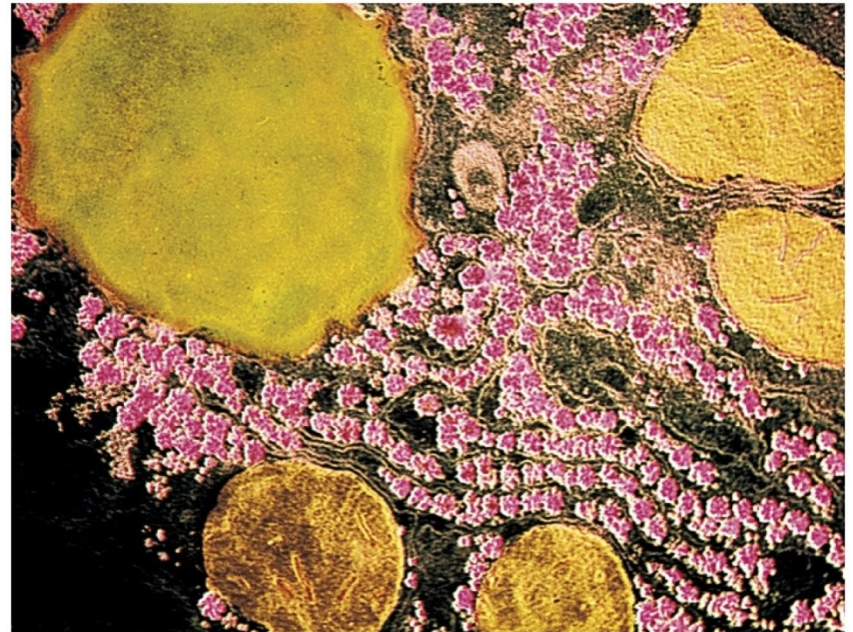
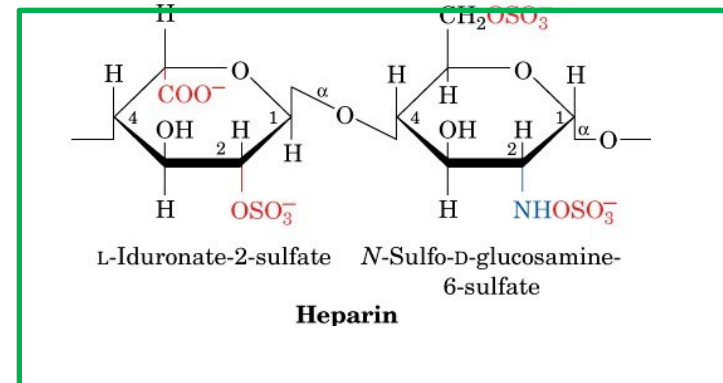
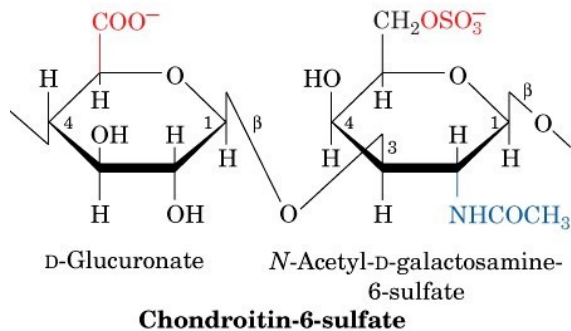
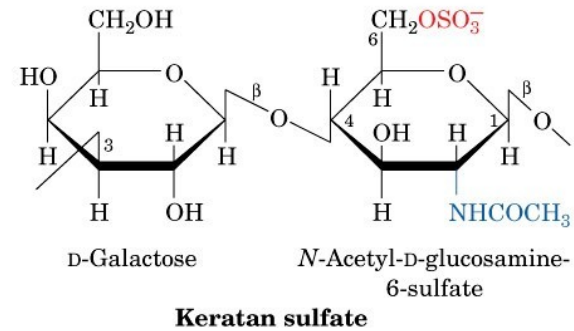
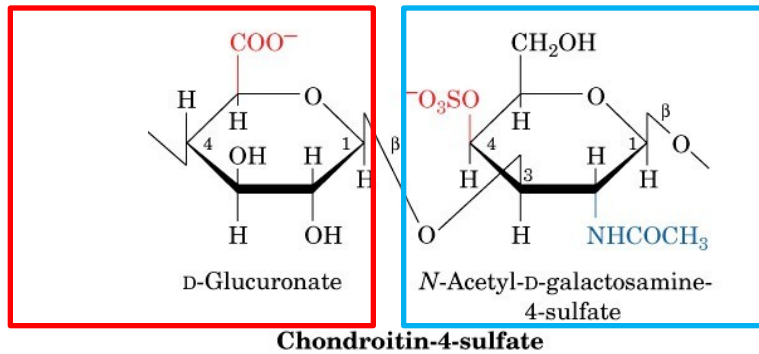
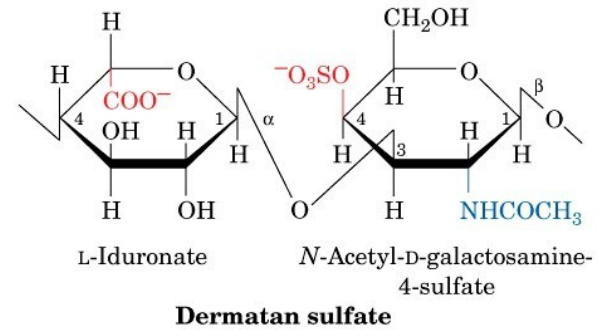
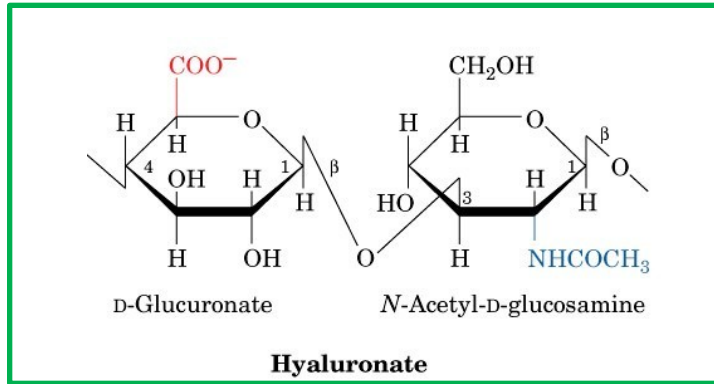

Figure 7-19b Concepts in Biochemistry, 3/e

Heteropolysacharidy



Heparin

Antikoagulancia - Nepřímé inhibitory trombinu / faktoru Xa

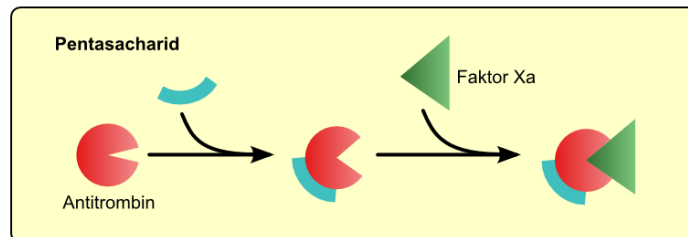
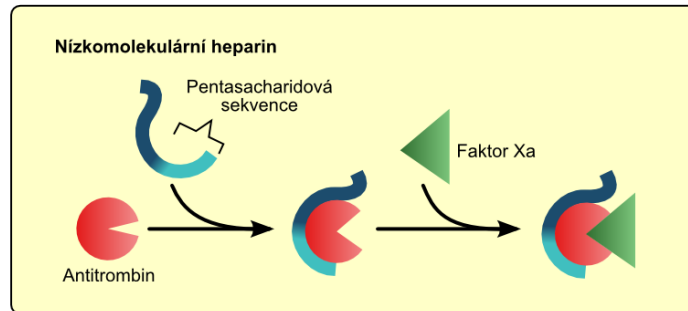
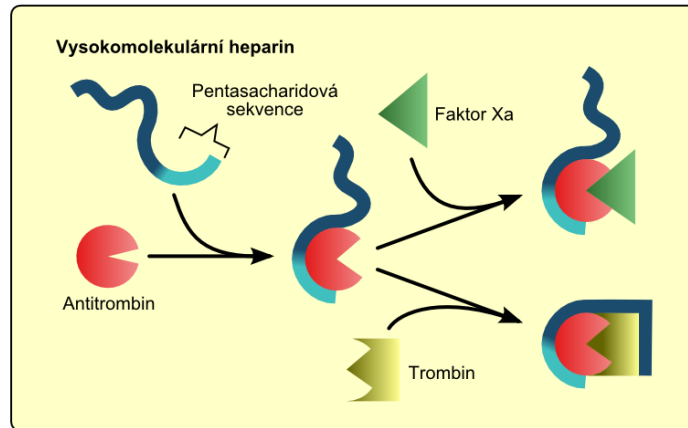

Složené sacharidy

- Glykolipidy

- Glykoproteiny

- Proteoglykany

LIŠÍ SE POMĚREM SLOŽEK

Glykoproteiny – N-linked

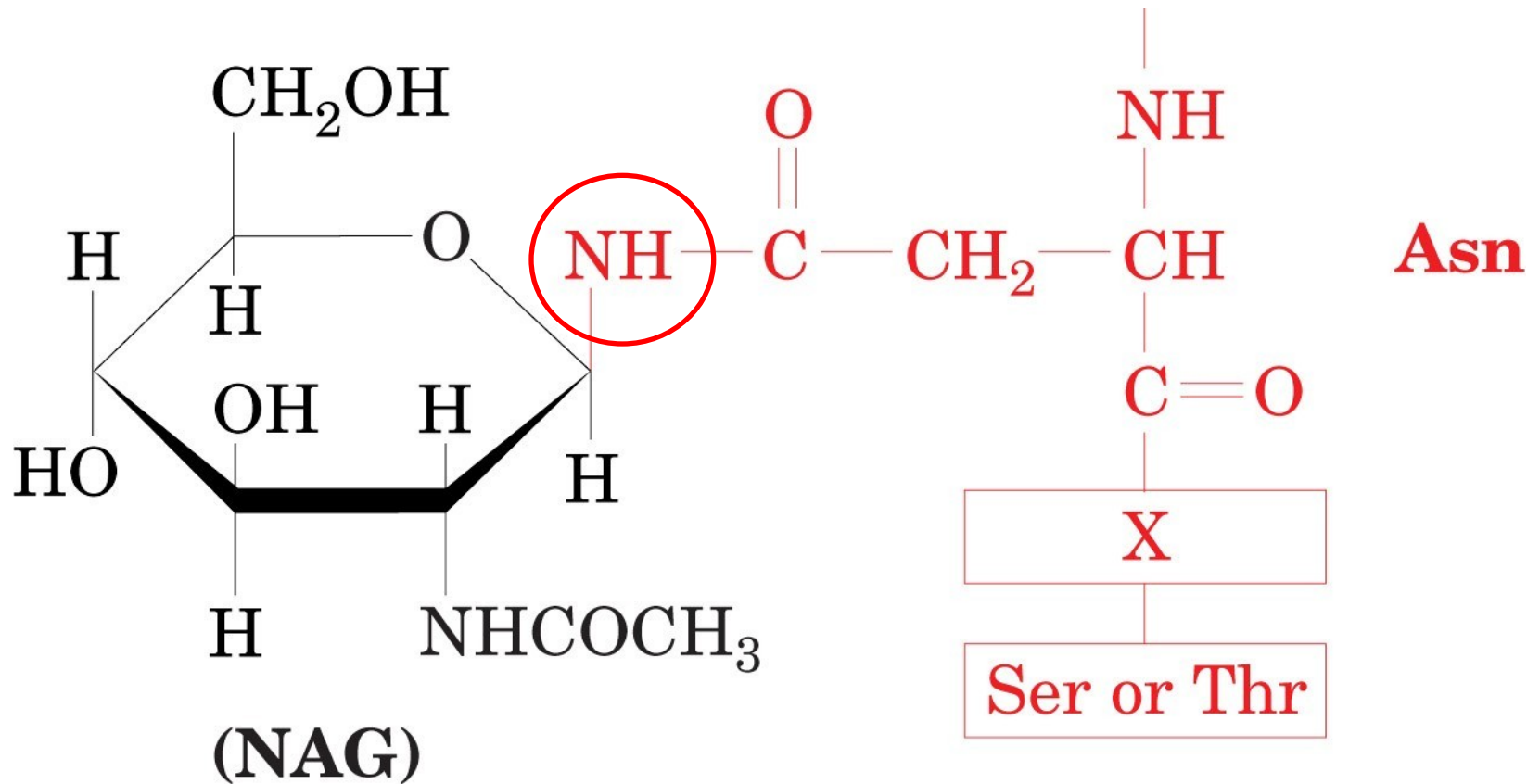

Glykoproteiny – O-linked

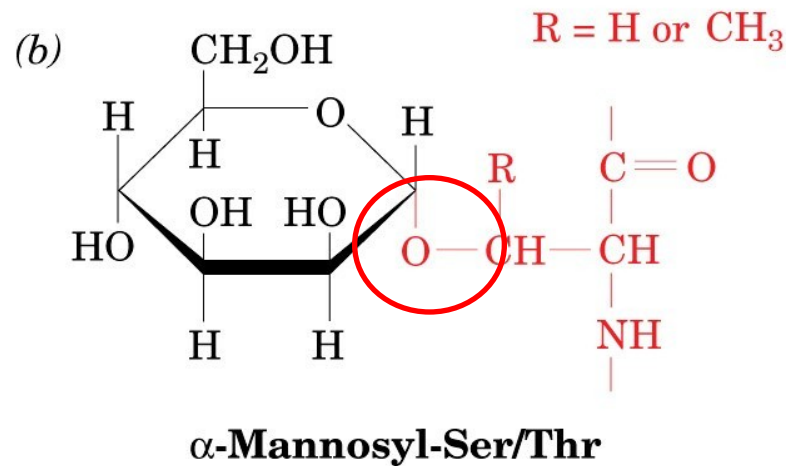
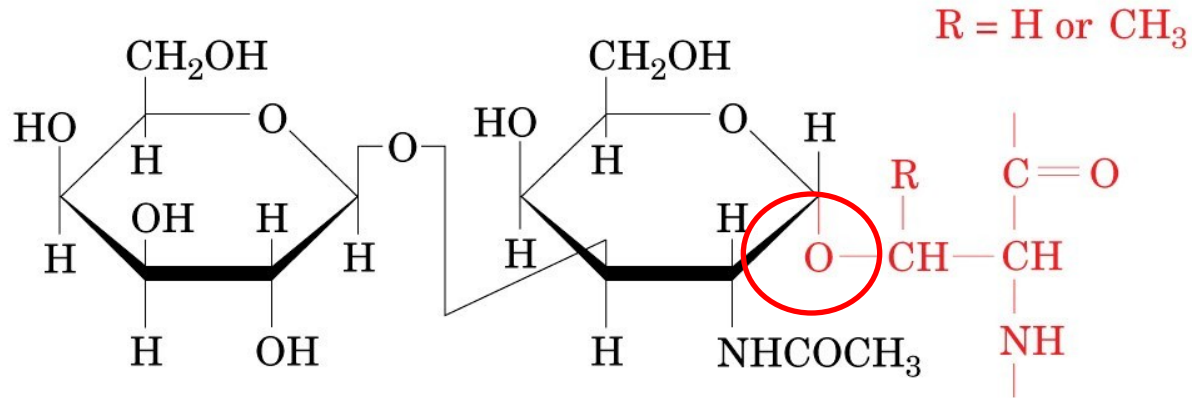

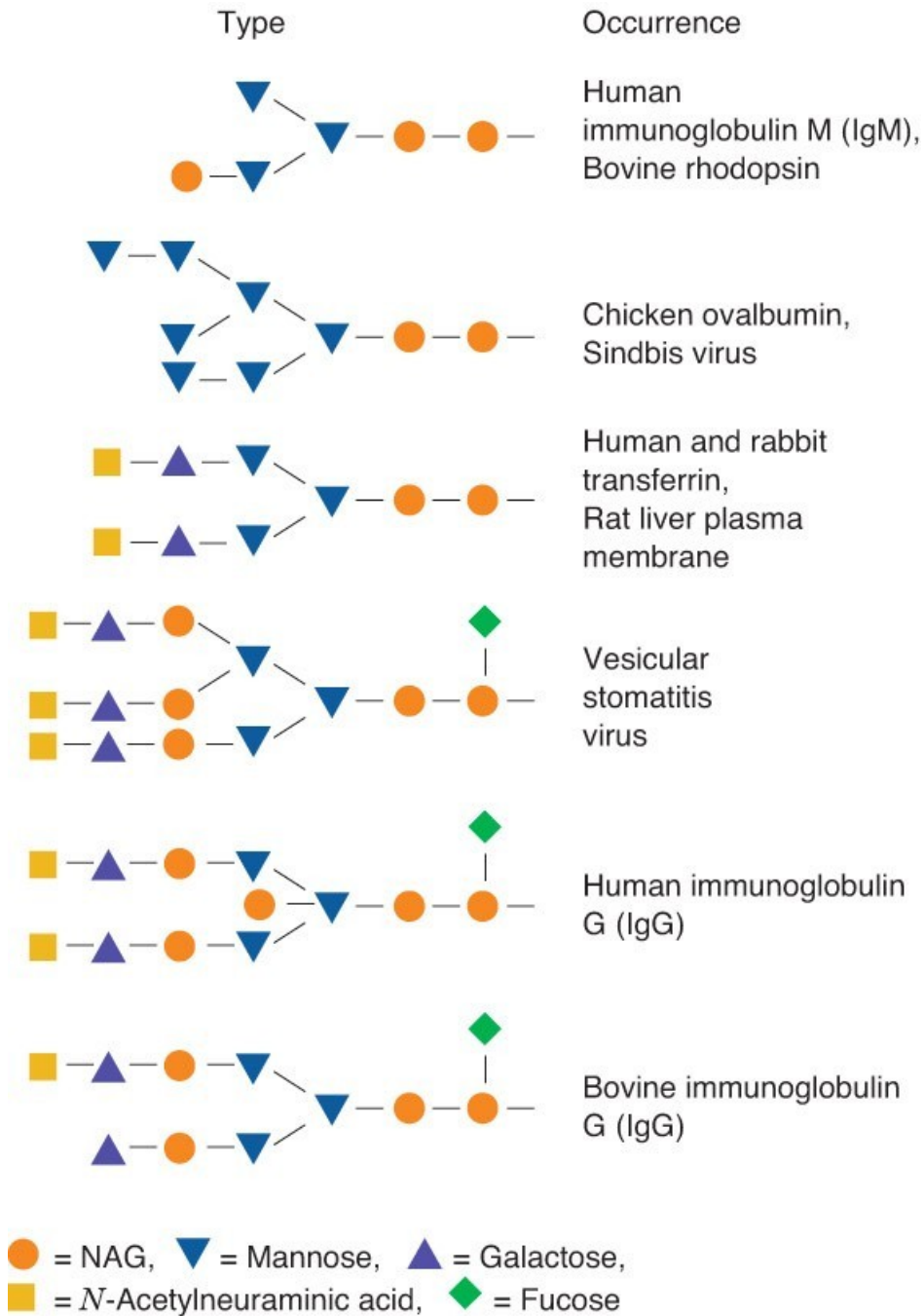

Glykoproteiny

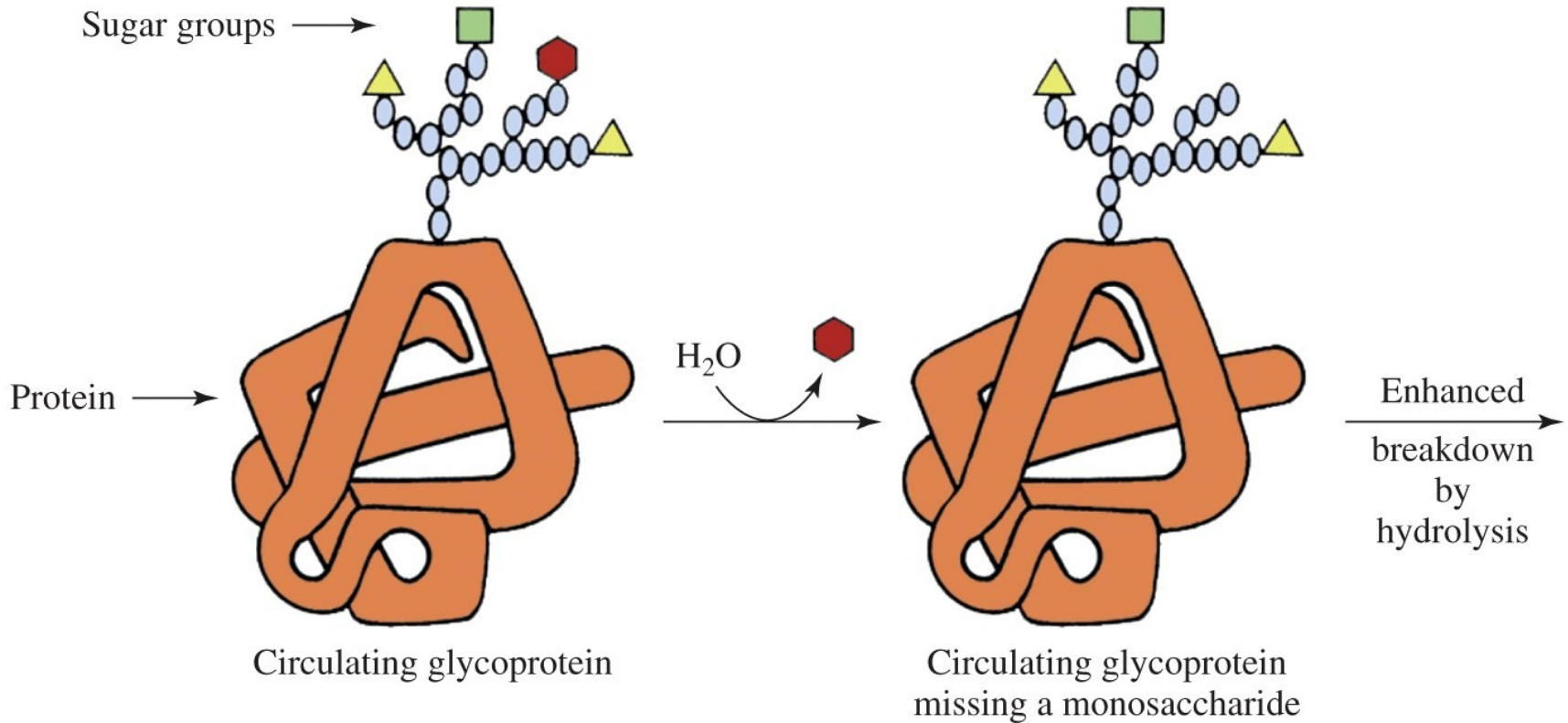

Figure 7-32 Concepts in Biochemistry, 3/e
© 2006 John Wiley & Sons

Antimrazové glykoproteiny



Krevní skupiny

- V současné době nejméně 21 systémů lidských krevních skupin (AB0, Rh, MNS,)
- Definovaný systém antigenů přítomných na červených krvinkách
- Krevní typ (antigenní fenotyp) je určován pomocí vhodných protilátek



Krevní skupiny AB0

- **Karl Landsteiner 1900**
(1930 NC)

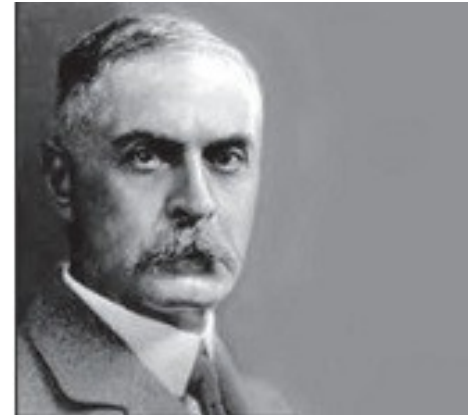

- **Jan Jánský 1907**



Chemická podstata aglutinogenů a aglutininů AB0

- **Aglutinogeny** – antigenní struktury na membránovém povrchu ERY
Základní jednotka – oligosacharid vzniklý kombinací 4 monosacharidů

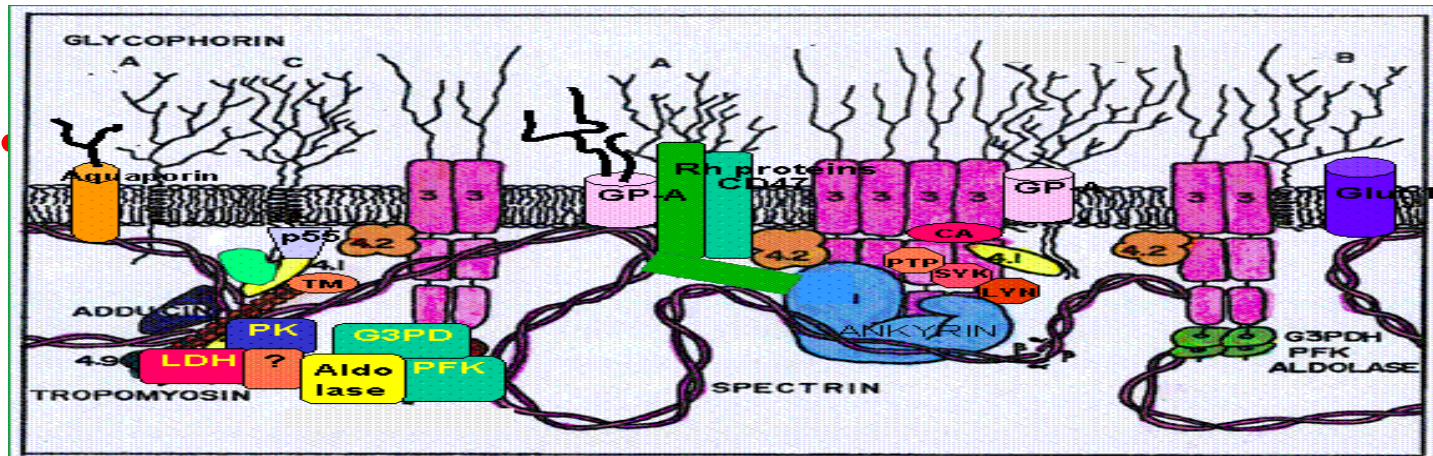

Krevní skupiny

Type A

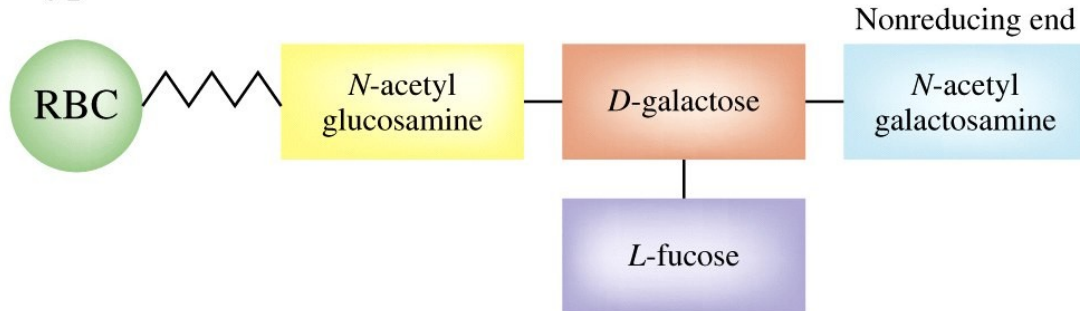

Type B

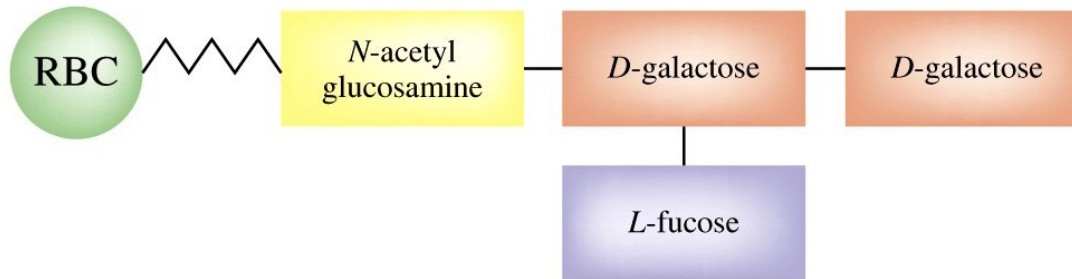

Type O

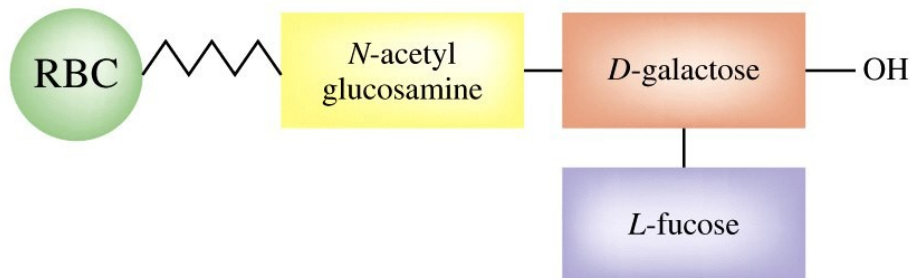

AB0(H) systém

- 4 základní krevní skupiny – A, B, AB a 0(H) podle přítomnosti aglutinogenů (antigenů) A a B na povrchu membrány ERY
- Protilátky v plazmě (aglutininy) se vytvářejí v 1.roce života, proti těm antigenům, které neobsahují vlastní ERY

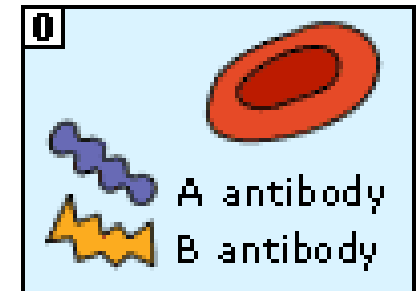
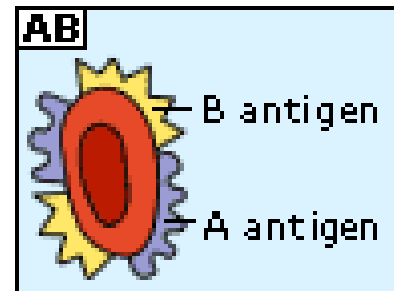
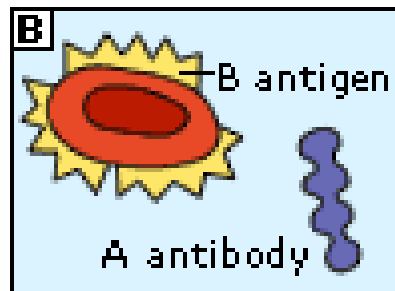
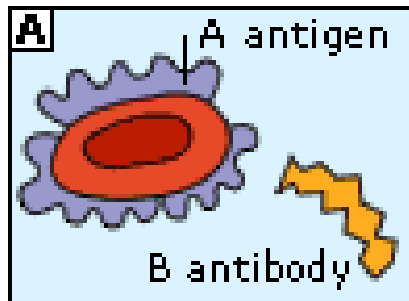

GEN H

fucosyl transferase

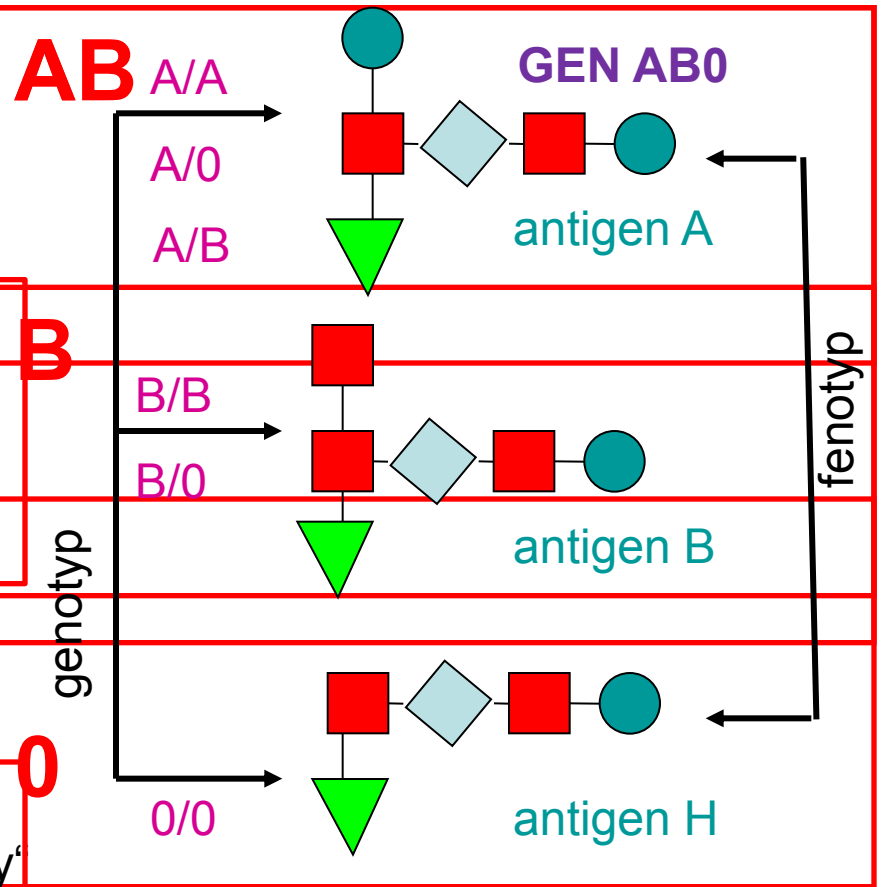
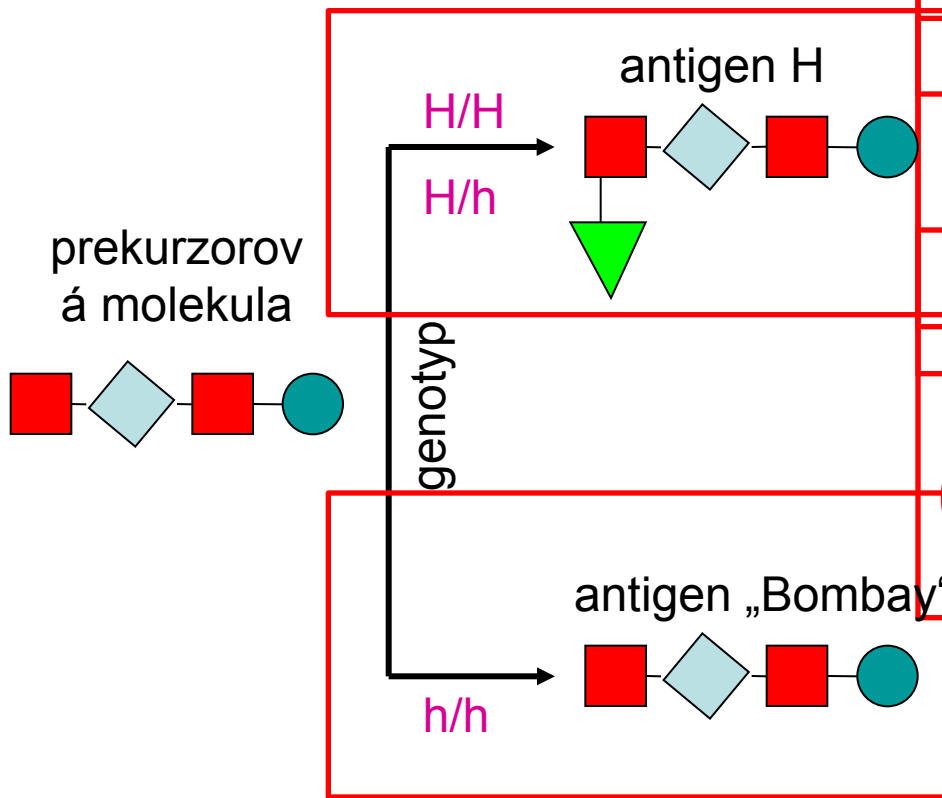

D-galaktosa



N-acetylgalaktozamin









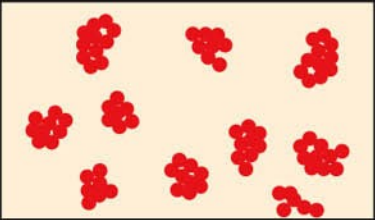
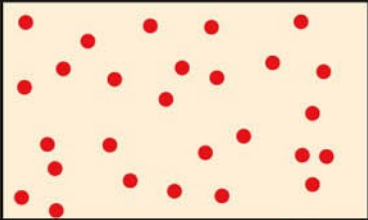
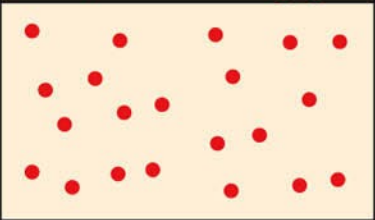
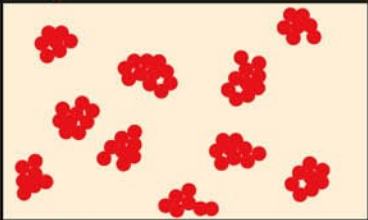
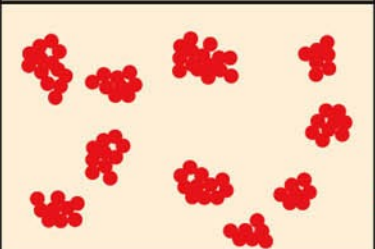
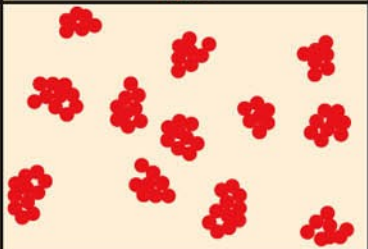
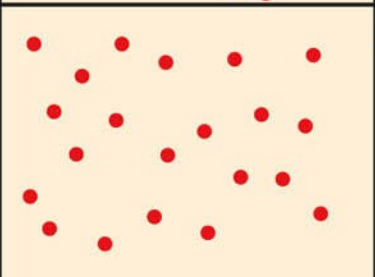
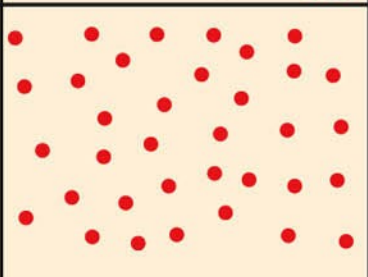

N-acetylglukosamin

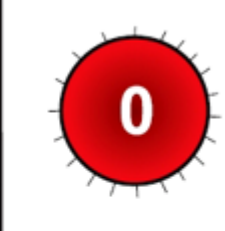

L-fukosa

Blood type of cells	Genotype	Antibodies made by body	Reaction to added antibodies	
			Anti-A	Anti-B
A	$I^A I^A$ or $I^A i^O$	Anti-B	 Agglutination (clumping) of red blood cells.	 No agglutination (uniformly distributed red blood cells).
B	$I^B I^B$ or $I^B i^O$	Anti-A	 No agglutination (uniformly distributed red blood cells).	 Agglutination (clumping) of red blood cells.
AB	$I^A I^B$	Neither anti-A nor anti-B	 Agglutination (clumping) of red blood cells.	 Agglutination (clumping) of red blood cells.
O	$i^O i^O$	Both anti-A and anti-B	 No agglutination (uniformly distributed red blood cells).	 No agglutination (uniformly distributed red blood cells).

	SKUPINA A	SKUPINA B	SKUPINA AB	SKUPINA 0
erytrocyty				
protilátky	 Anti-B	 Anti-A	žádné	 Anti-A Anti-B
antigeny	 A antigen	 B antigen	 A a B antigeny	žádné

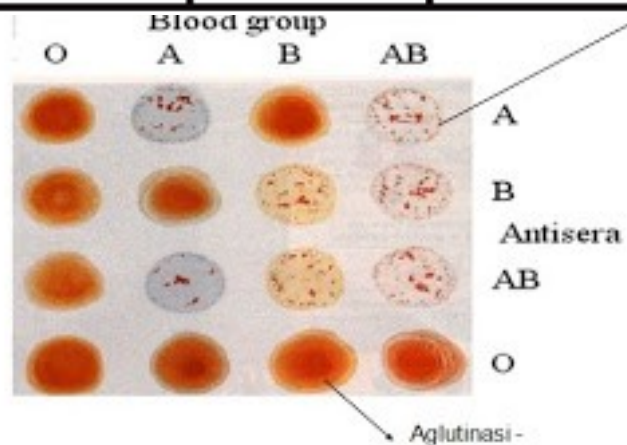

Dědičnost krevních skupin

Matka\Otec	0	A	B	AB
0	0	0, A	0, B	A, B
A	0, A	0, A	0, A, B, AB	A, B, AB
B	0, B	0, A, B, AB	0, B	A, B, AB
AB	A, B	A, B, AB	A, B, AB	A, B, AB

System Rh Landstein Wiener

- Antigenní systém Rh je vysoce komplexní
- Antigeny C, **D**, E, c, d, e

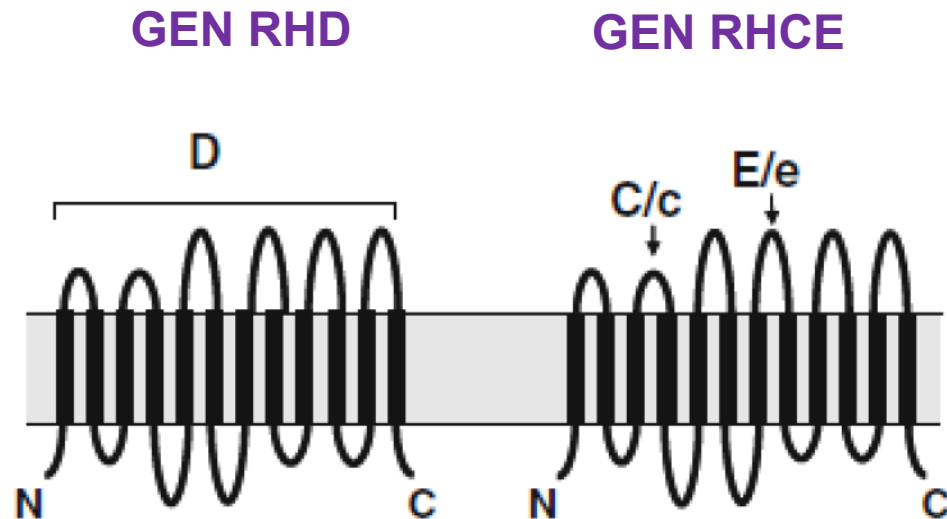

System Rh

- Je-li přítomen antigen D, **Rh-pozitivní jedinec**
- Chybí-li antigen D, **Rh-negativní jedinec**
- Protilátky anti-D vznikají pouze při imunizaci Rh⁻ příjemce krvinkami Rh⁺ dárce
- Protilátky jsou imunoglobuliny typu IgG

Hemolytická nemoc novorozenců

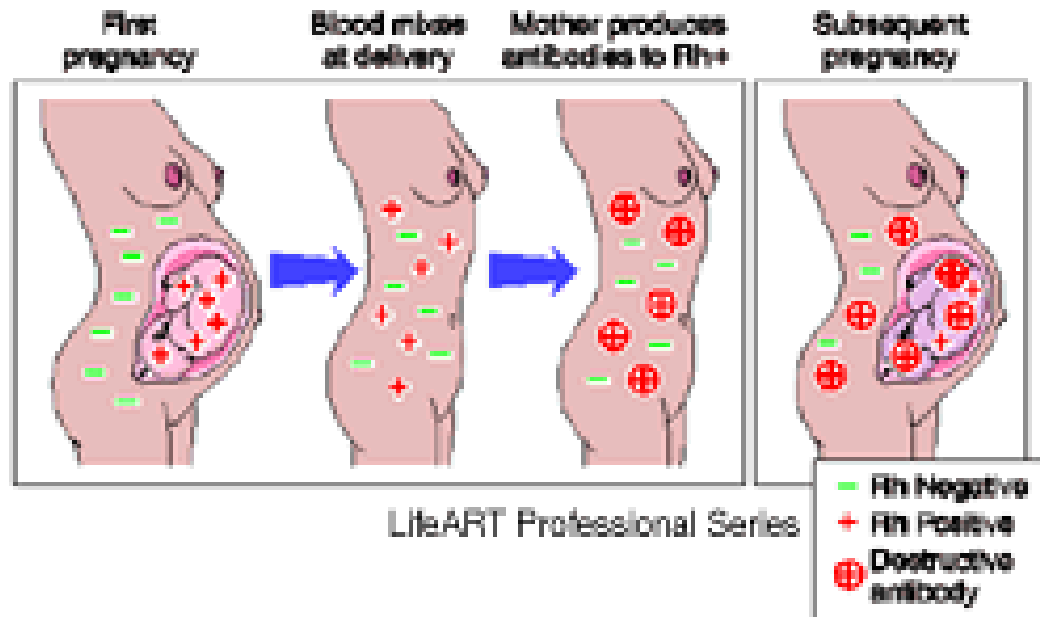
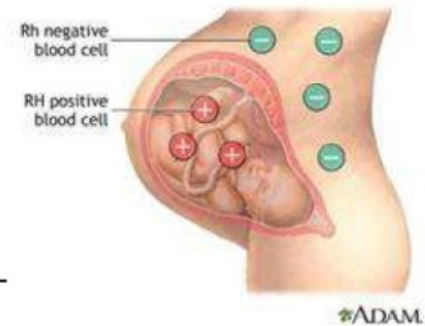

Proteoglykany – 95 % sacharid

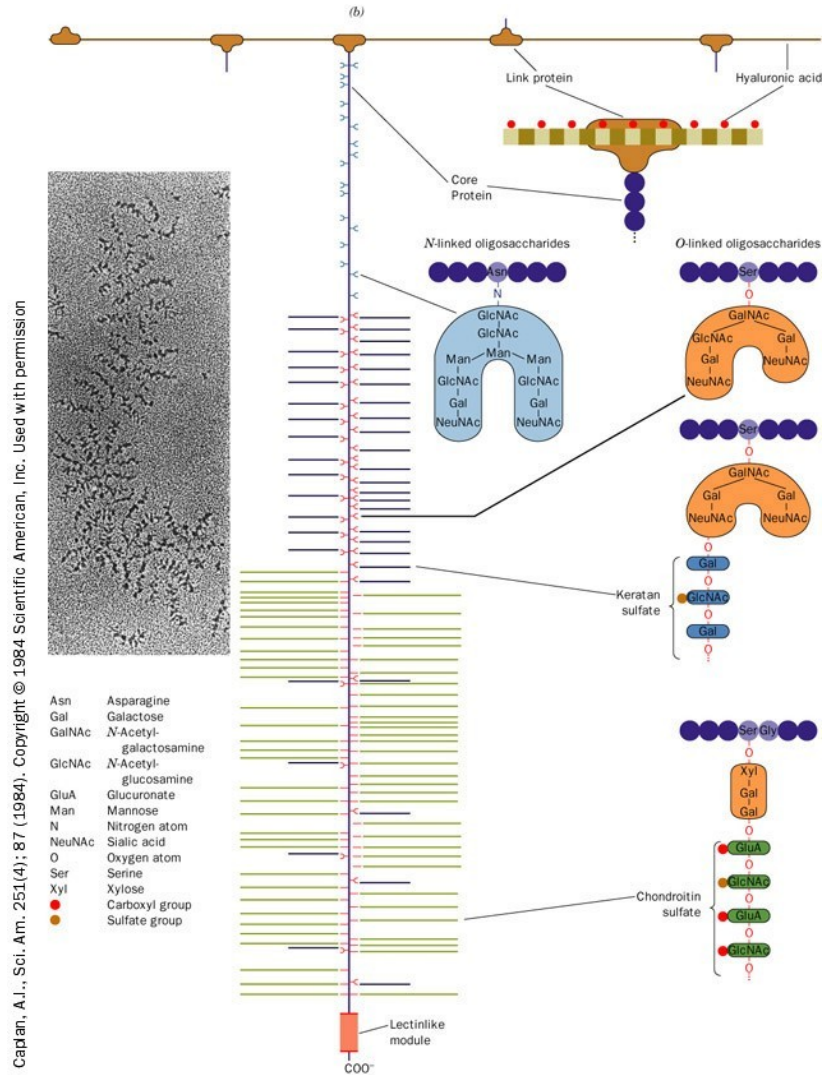

Caplan, A.L., Sci. Am. 251(4): 87 (1984). Copyright © 1984 Scientific American, Inc. Used with permission

Buněčná stěna bakterií

grampozitivní(a) a gramnegativní(b)

1. NEOBARVENÝ
PREPARÁT

Gram +

Gram -

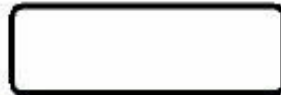

G+

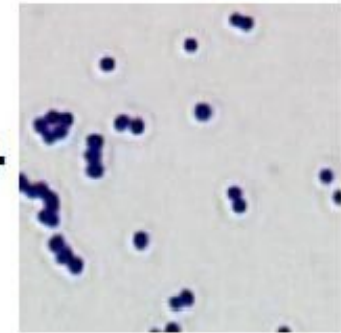

G-

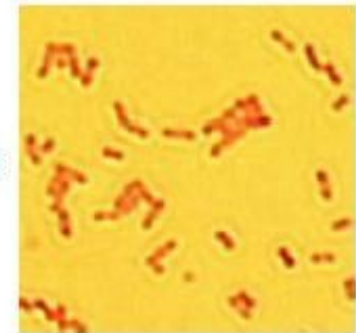

Buněčná stěna bakterií

grampozitivní(a) a gramnegativní(b)

(a) Gram-positive bacteria

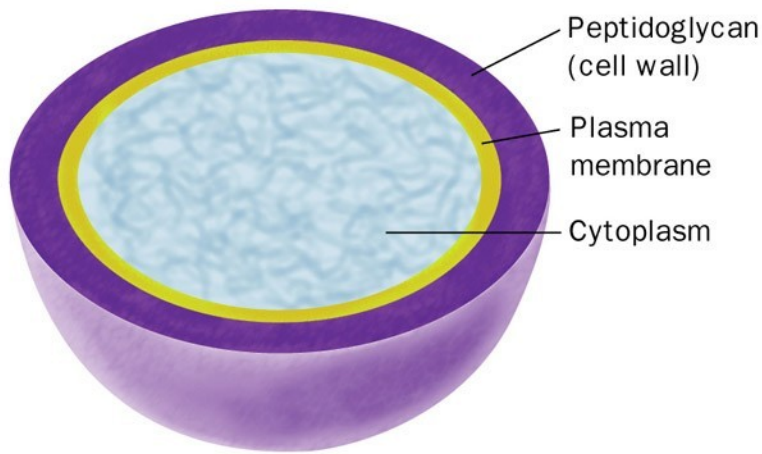

(b) Gram-negative bacteria

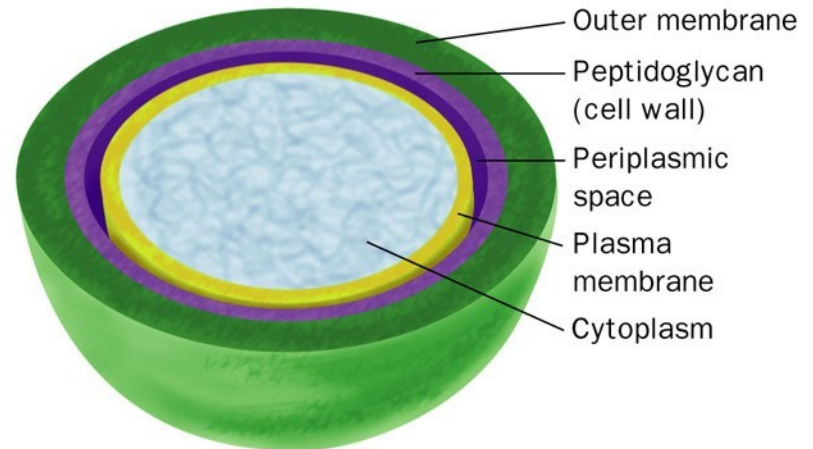

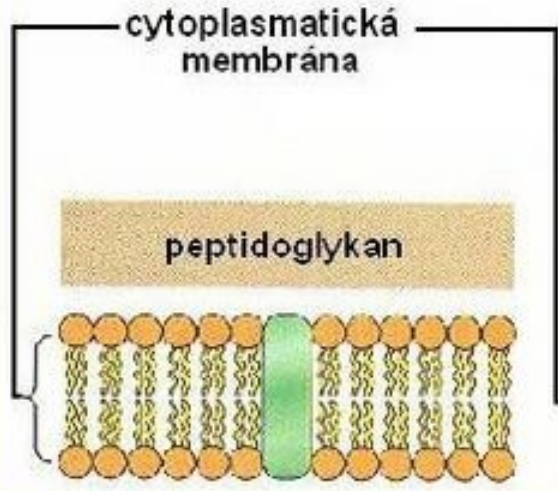

Buněčná stěna je poměrně silná, obsahuje kromě peptidoglykanu proteiny, polysacharidy a kyselinu teichoovou.

G+ bakterie

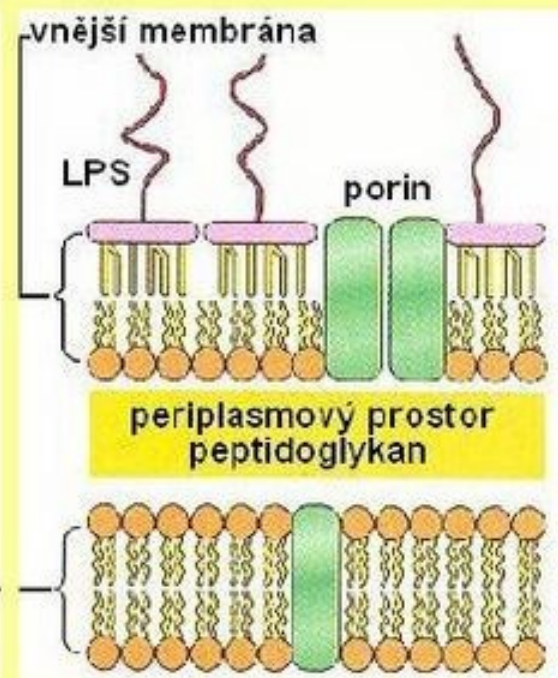

Vrstva peptidoglykanu (PG) je tenčí. Nad ní je vnější membrána (VM) – fosfolipidová dvojitá vrstva - spojená s PG molekulami lipoproteinu. Mezi PG a VM je periplasmový prostor. Zevní strana VM obsahuje lipopolysacharid (LPS). LPS se skládá z toxického lipidu A (endotoxin), základního polysacharidu a specifického polysacharidu, který vyčnívá z buňky (O antigen).

G- bakterie

Nebezpečnější

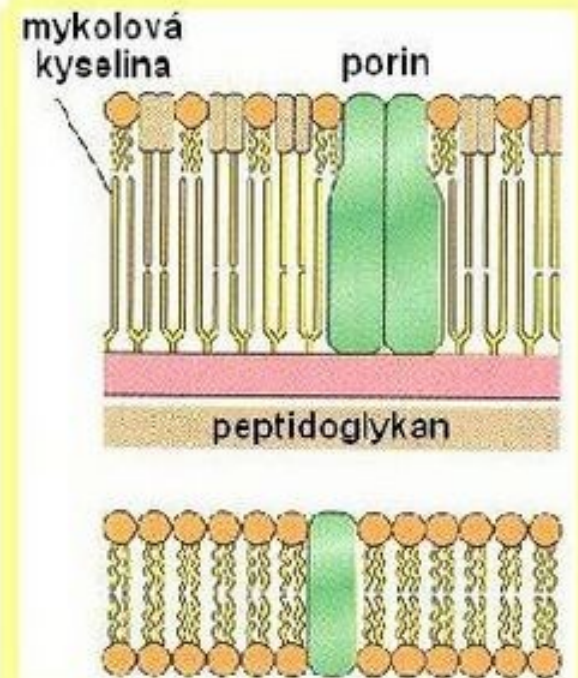

Odlíšné složení buněčné stěny
U kyseliny muramové v PG je místo N-acetylmu N-glykol
Ve stěně je velké množství volných i vázaných lipidových komponent obsahujících mykolové kyseliny.
Povrch je hydrofobní, chrání proti vyschnutí, detergentům, kyselinám a alkoholu - acidorezistence.
Nebarví se Gramovým barvením.

mykobakterie

LIPIDY

Lipos - tuk

Funkce : zdroj a reserva energie	Jednoduché - neutrální
strukturní funkce	Složené - polární, izoprenoidní - steroidní
ochranná a izolační funkce	Jednoduché - neutrální
různé biologické funkce	Izoprenoidní - steroidní

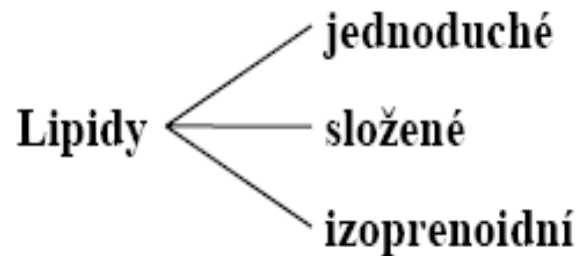

Neutrální

Triacylglycerols

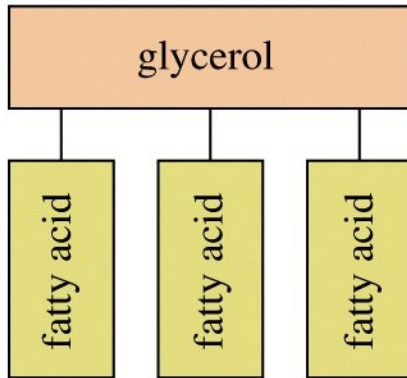

Storage lipids (nonpolar)

(a)

Polární

Glycerophospholipids

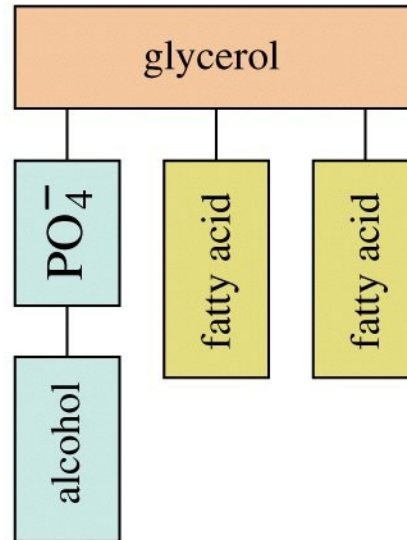

Membrane lipids (polar)

(b)

Sphingolipids

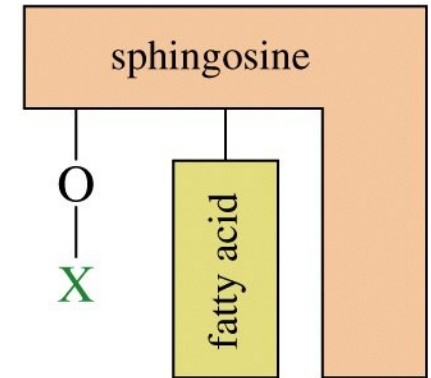

Jednoduché lipidy :

chemicky - estery mastných kyselin a alkoholů

ACYLGLYCEROLY - triglyceridy - estery mastných kyselin a glycerolu

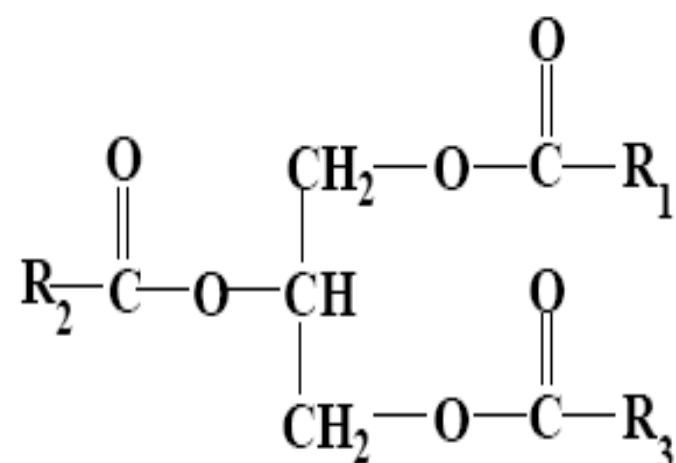

Adipocyty

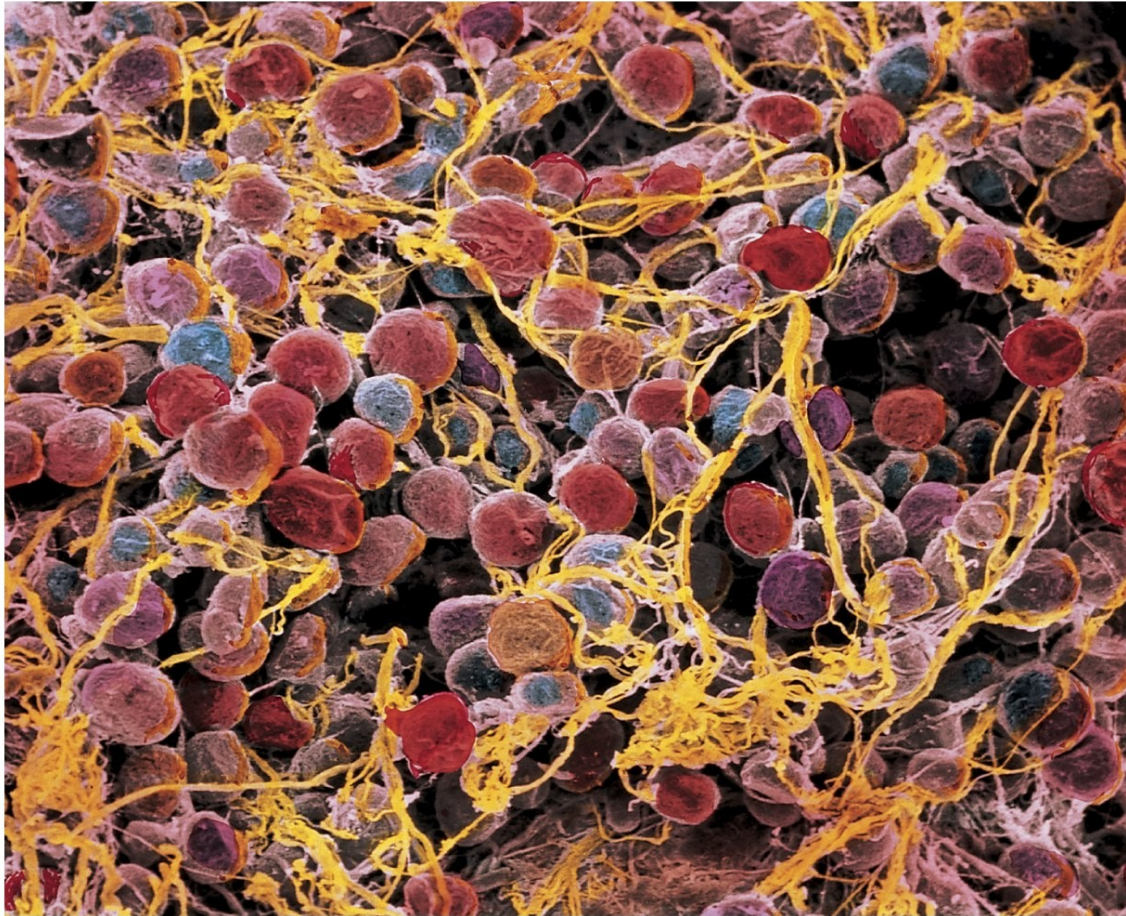
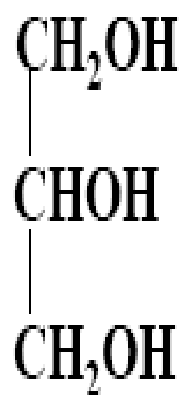
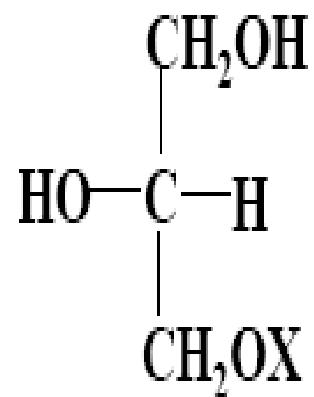

Figure 8-4 Concepts in Biochemistry, 3/e

Alkohol



glycerol



derivát sn-glycerol
(L-glycerol)

Mastné kyseliny - nasycené

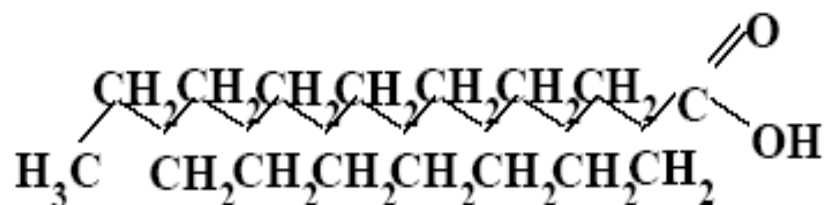

K. PALMITOVÁ

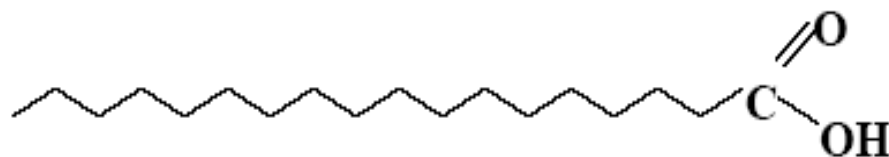
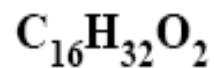

K. STEAROVÁ

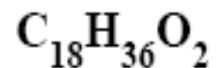

Mastné kyseliny - nenasycené

Vitamín F

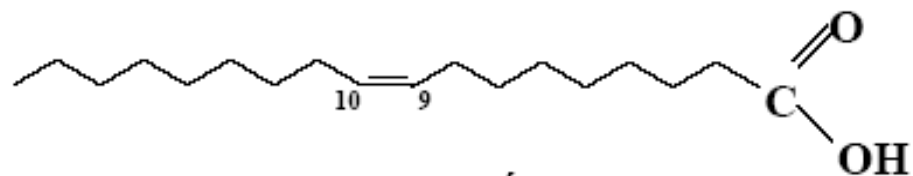

K. OLEJOVÁ

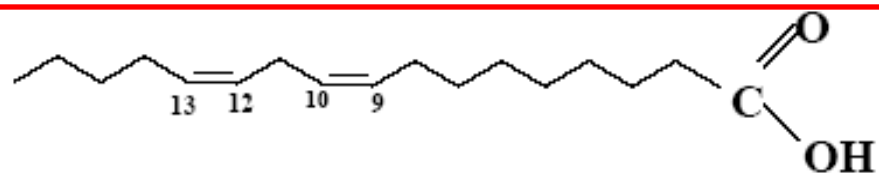
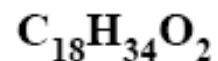

K. LINOLOVÁ

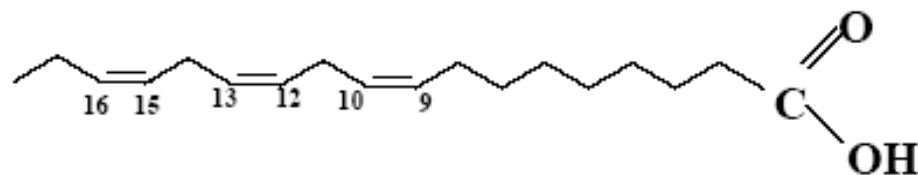
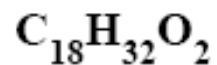

K. LINOLENOVÁ

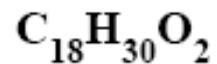



**Saturated
chain**



***trans*
Double bond**



***cis*
Double bond**

Carboxyl group

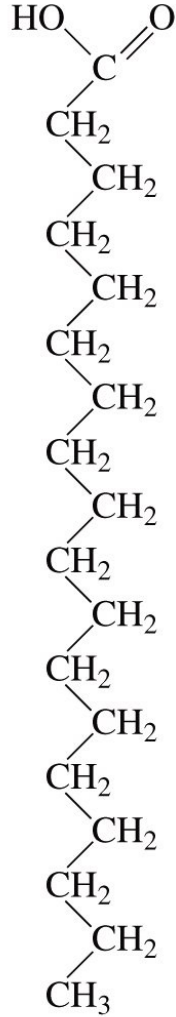

Hydrocarbon chain

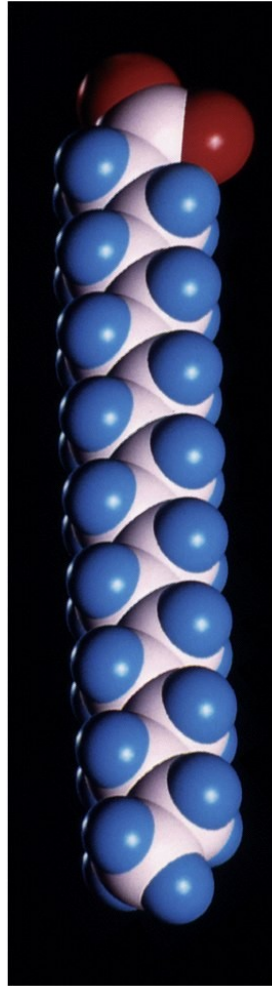

Figure 8-1a Concepts in Biochemistry, 3/e

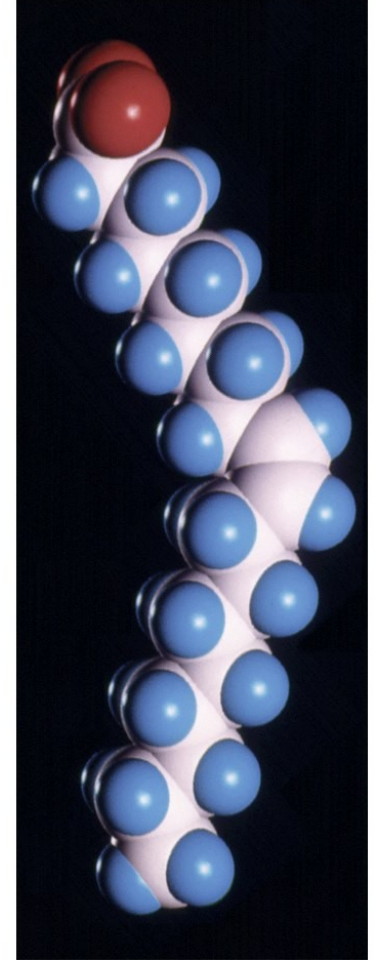
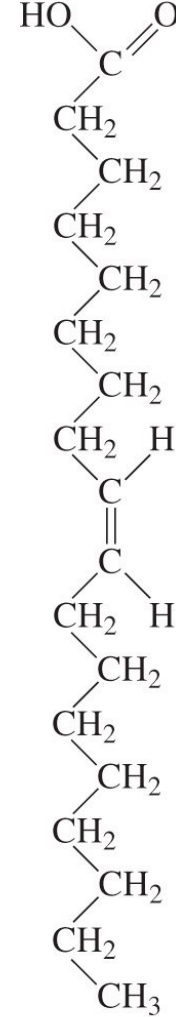
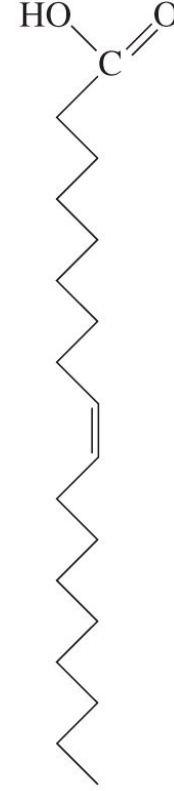
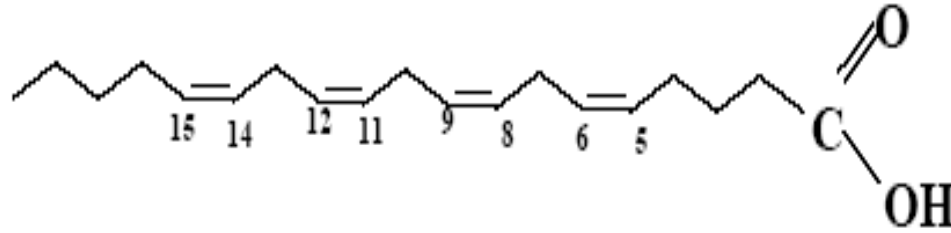
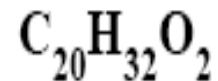

Figure 8-1b Concepts in Biochemistry, 3/e



K. ARACHIDONOVÁ



- Srdeční systém
- Respirační systém
- Reprodukční systém
- Gastrointestinální trakt

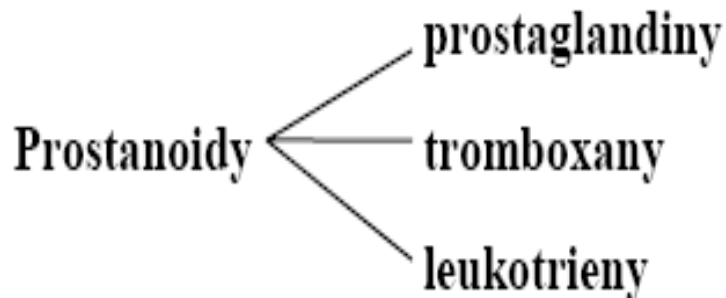

- Pocity bolesti
- Horečka
- Regulace krevního tlaku
- Indukci srážení krve
- Reprodukční funkce
- Regulace cyklu spánku

Arachidonic acid residue

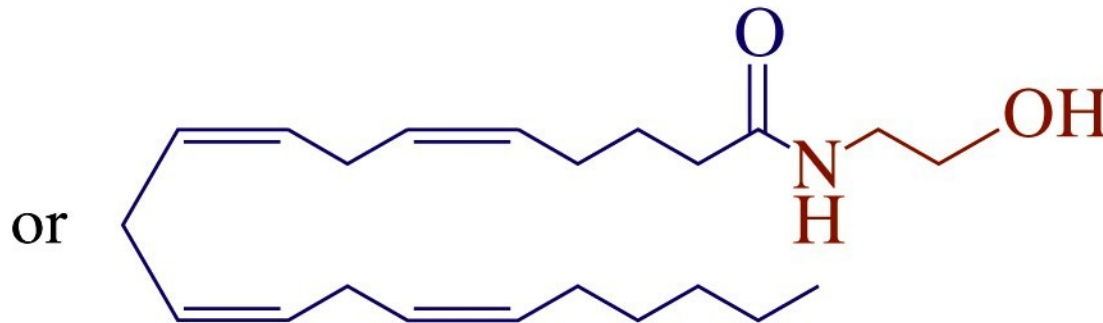
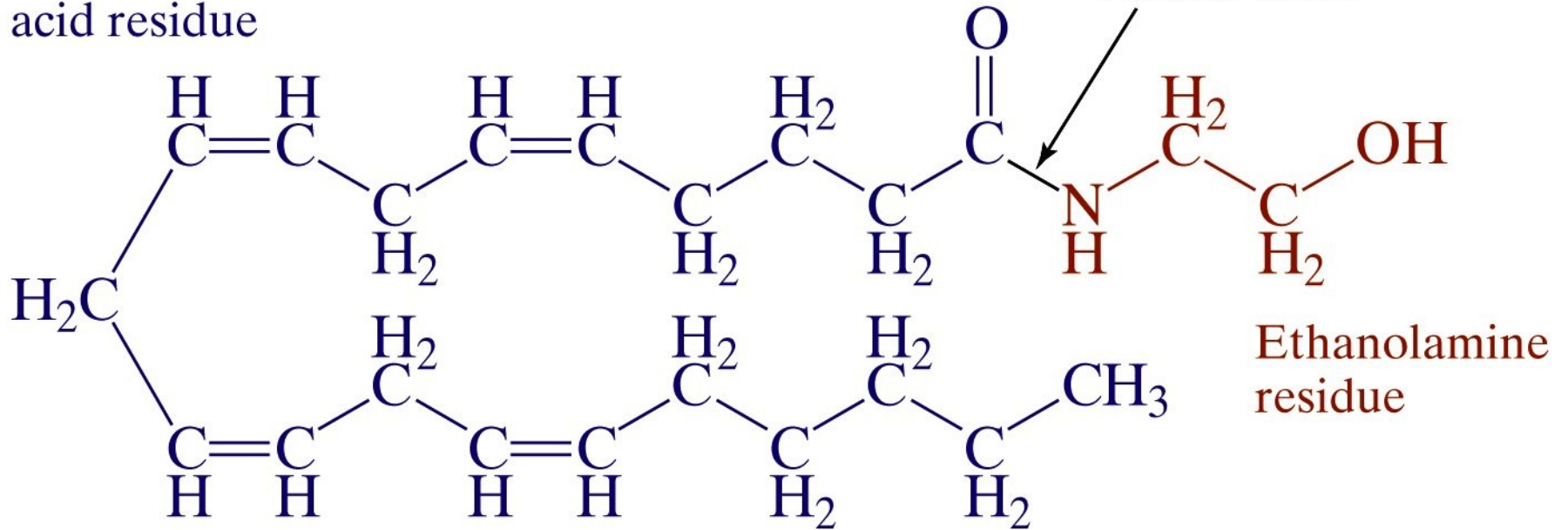

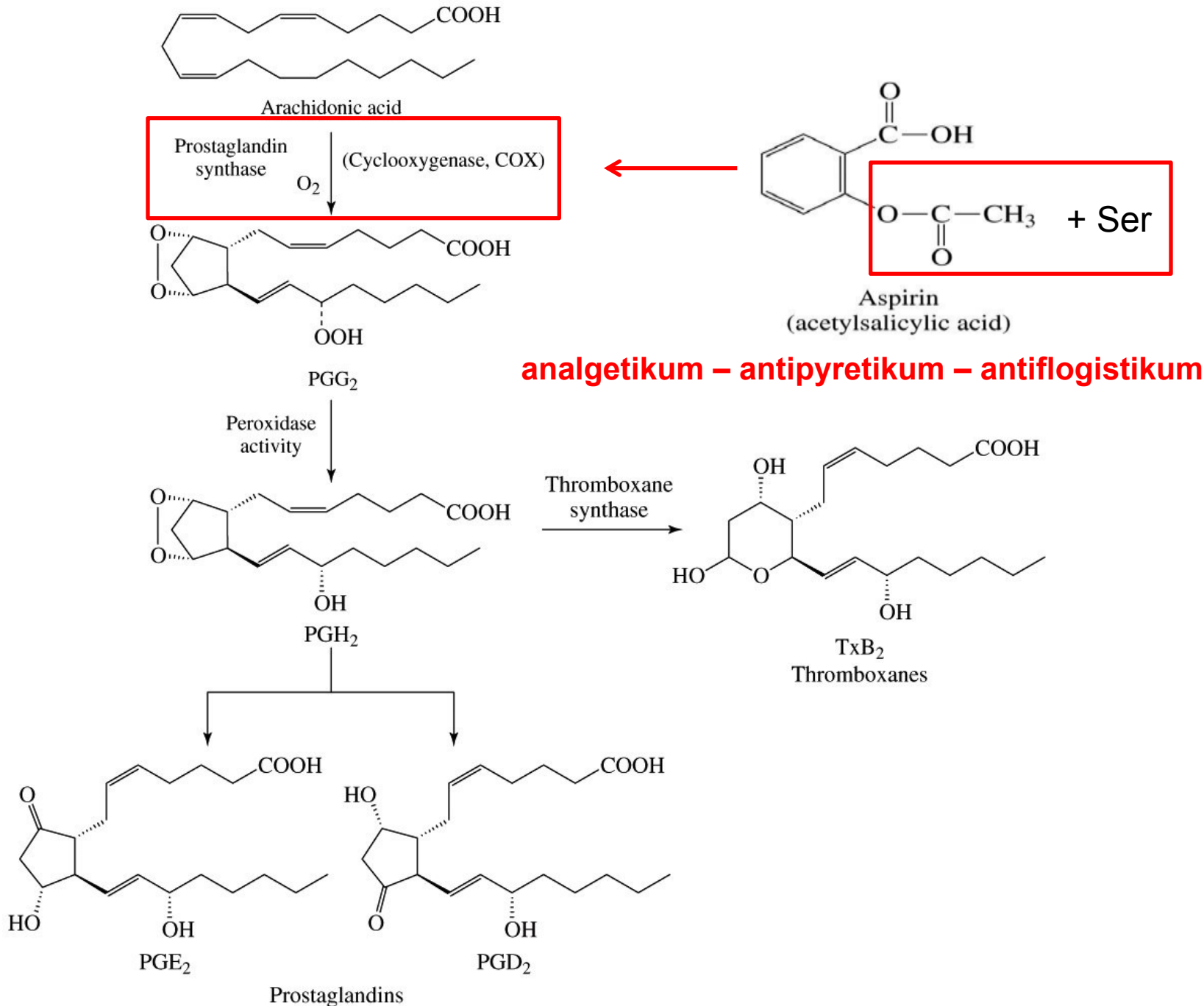
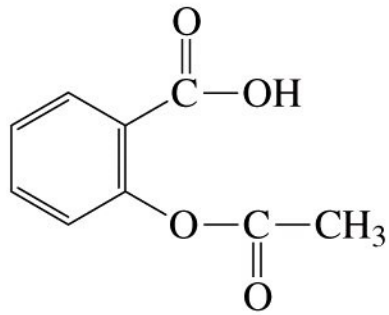
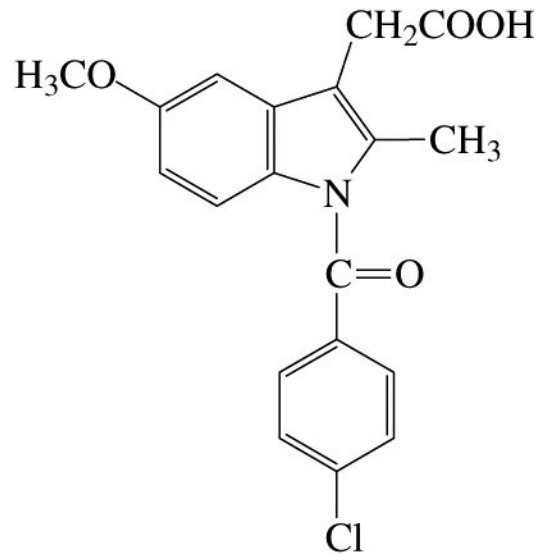

Figure 8-14 Concepts in Biochemistry, 3/e



Aspirin
(acetylsalicylic acid)



Indomethacin

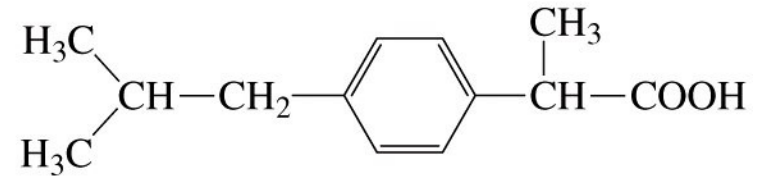

Ibuprofen

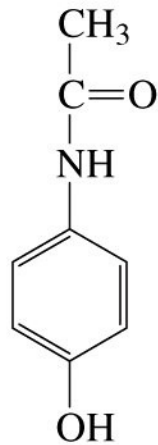

Acetaminophen

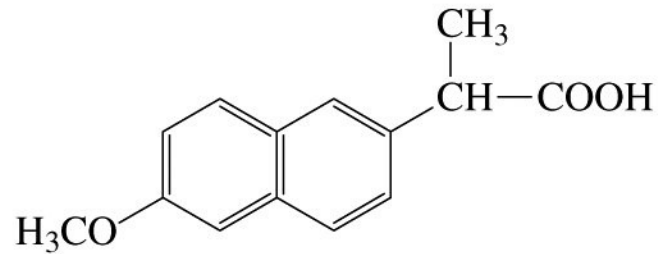

Naproxen (Aleve)

Důležité reakce tuků - zmydlování - NaOH

- ztužování - H₂

- žluknutí - O₂

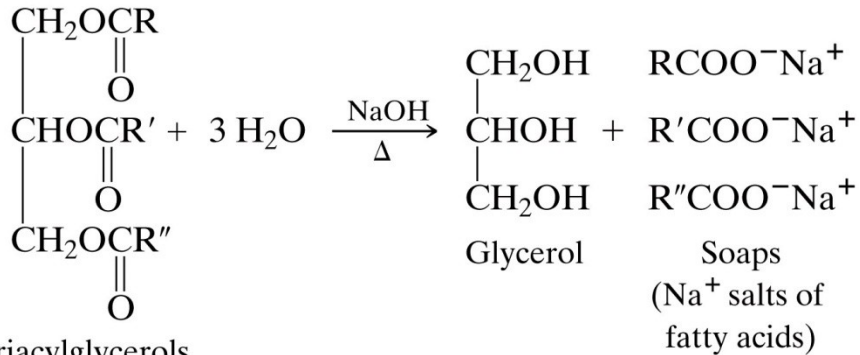

Triacylglycerols

Unnumbered figure pg238b Concepts in Biochemistry, 3/e
© 2006 John Wiley & Sons

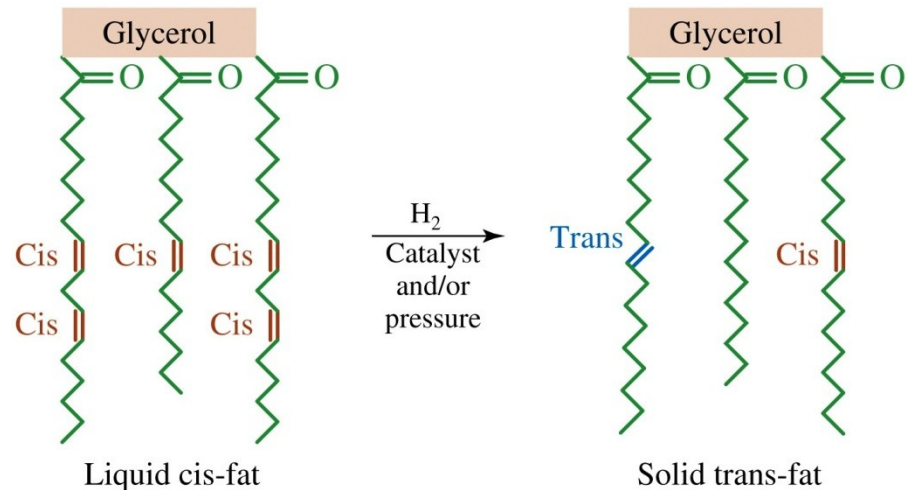
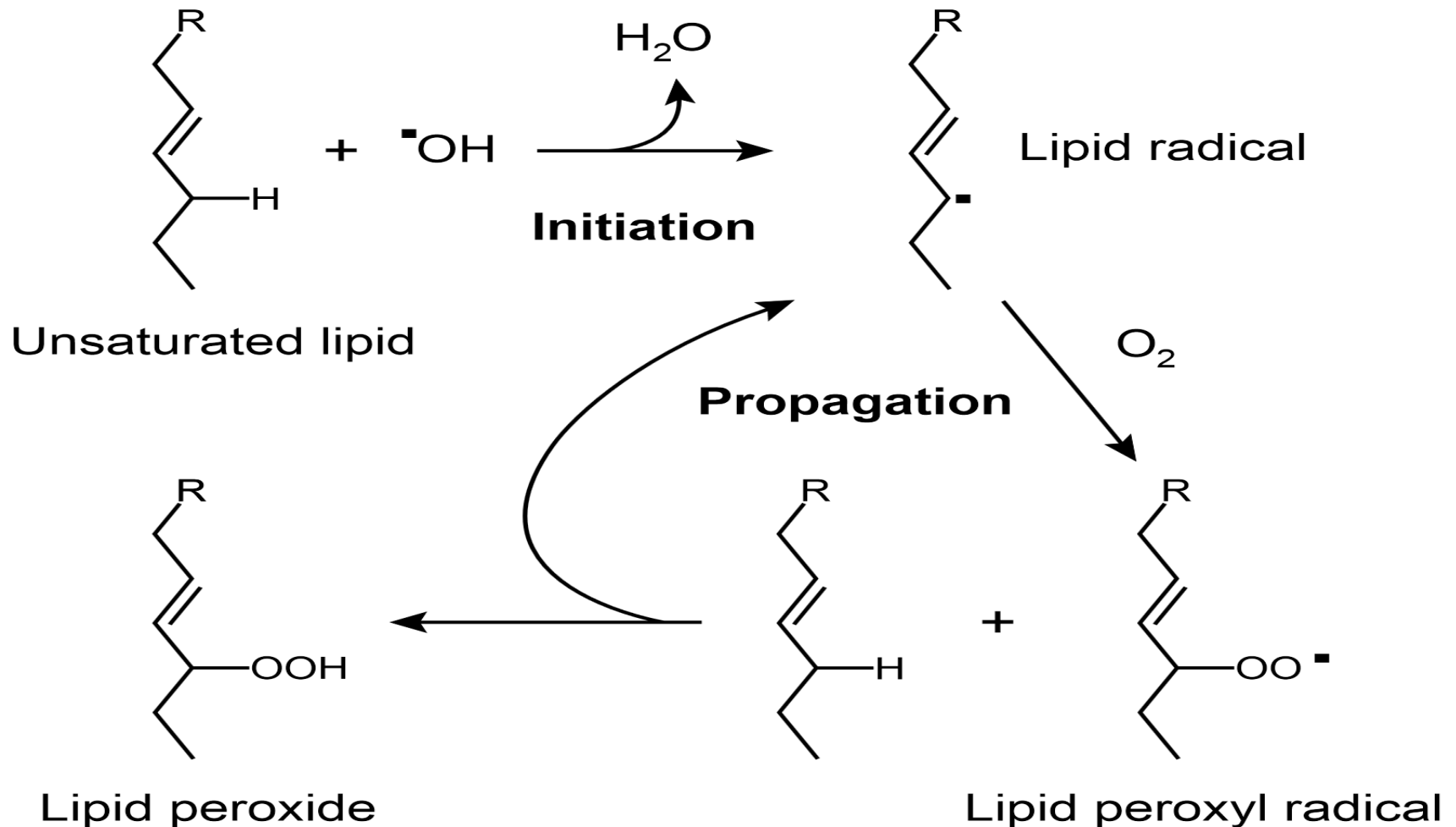

Figure 8-3 Concepts in Biochemistry, 3/e
© 2006 John Wiley & Sons

Lipoperoxidace

reaktivní formy kyslíku (ROS)



VOSKY - estery mastných kyselin a alifatických alkoholů

včelí vosk - palmitan myricylnatý ($C_{30}H_{61}OH$)

vorvaňovina - palmitan cetylnatý ($C_{16}H_{33}OH$)

lanolin

karnaubský vosk

Složené lipidy :

FOSFOLIPIDY

A. Fosfoacylglyceroly - fosfatidy

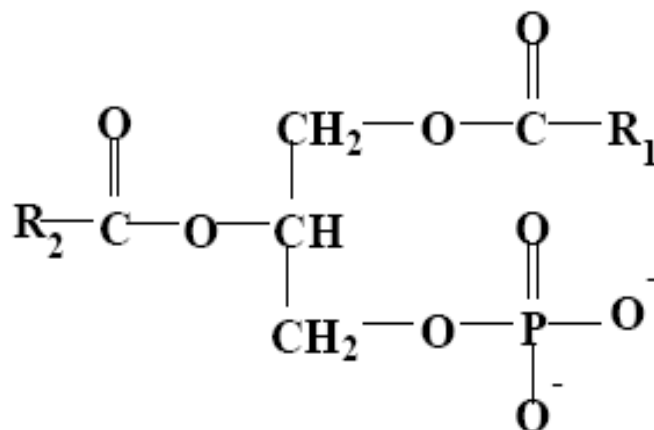

K. FOSFATIDOVÁ

1,2-diacyl-glycerol-3-fosforečná k.

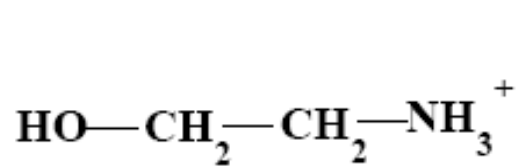

ETHANOLAMIN

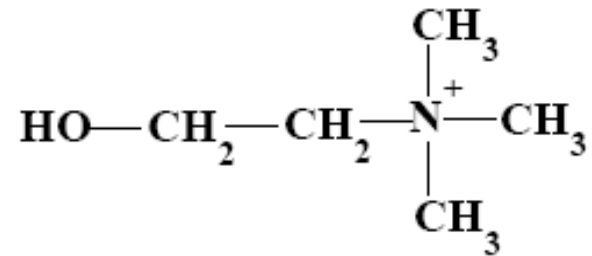

CHOLIN

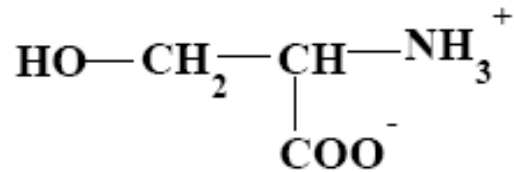

SERIN

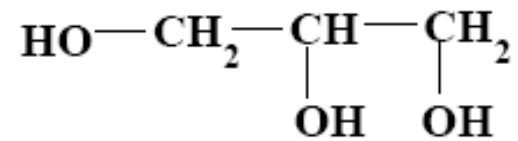

GLYCEROL

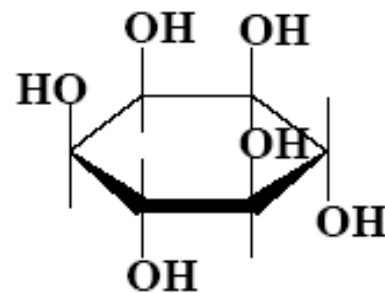

INOSITOL

Fosfatidylcholin - lecitiny

Fosfatidylethanolamin - kefaliny

Bisfosfatidylglycerol - kardiolipin

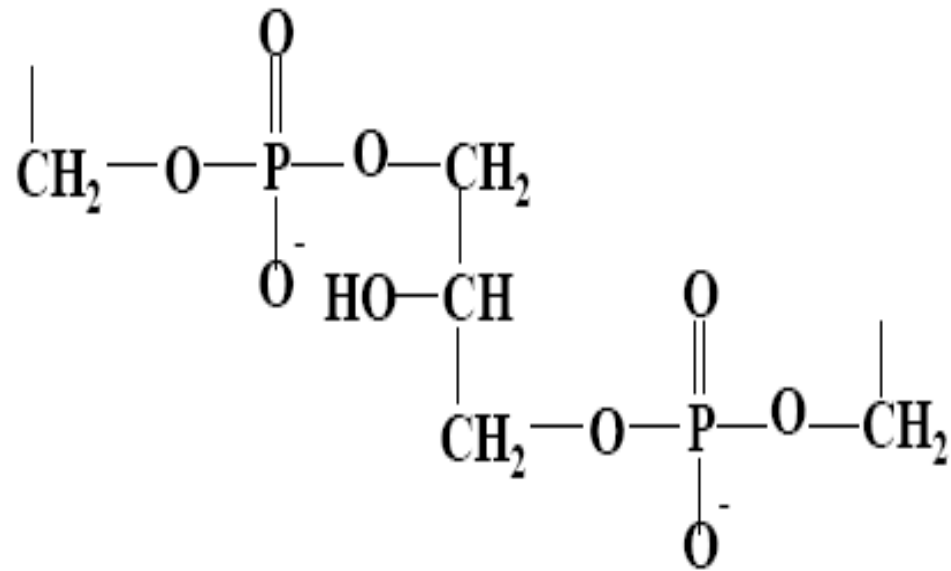

Fosfatidylinositol

Plazmalogeny

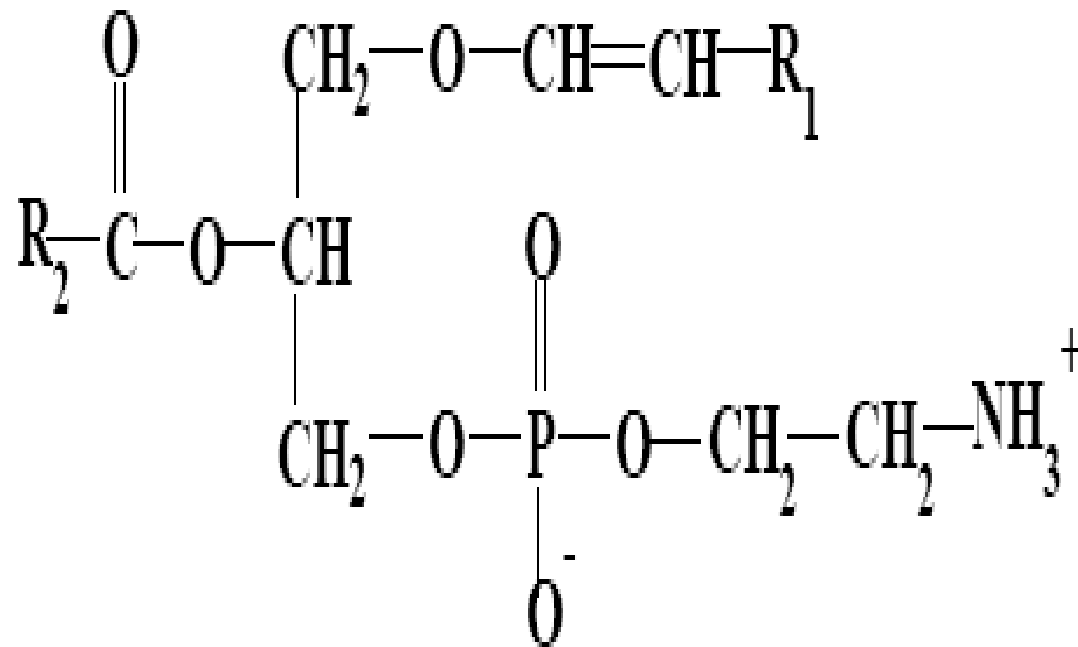

Name of X	Structure of X	Name of Glycerophospholipids
(a) Hydrogen	—H	Phosphatidic acid
(b) Ethanolamine	—CH ₂ —CH ₂ — $\overset{+}{\text{N}}\text{H}_3$	Phosphatidylethanolamine
(c) Choline	—CH ₂ —CH ₂ — $\overset{+}{\text{N}}(\text{CH}_3)_3$	Phosphatidylcholine
(d) Serine	$\begin{array}{c} \text{—CH}_2\text{—CH—}\overset{+}{\text{N}}\text{H}_3 \\ \\ \text{COO}^- \end{array}$	Phosphatidylserine
(e) Inositol		Phosphatidylinositol

Figure 8-7 part 2 Concepts in Biochemistry, 3/e
 © 2006 John Wiley & Sons

B. Sfingomyeliny - sfingofosfolipidy



SFINGOSIN

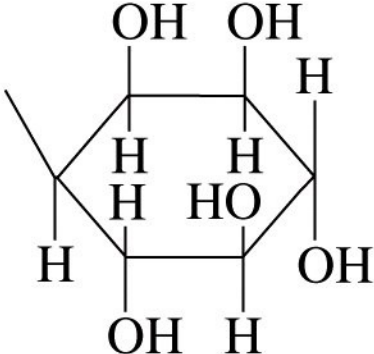
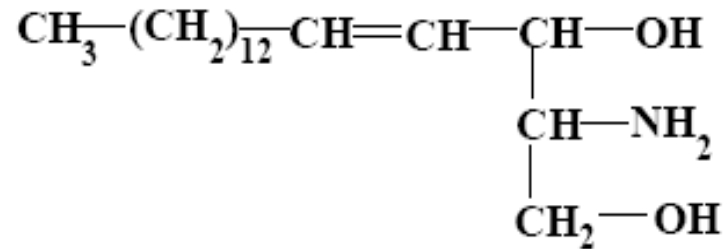
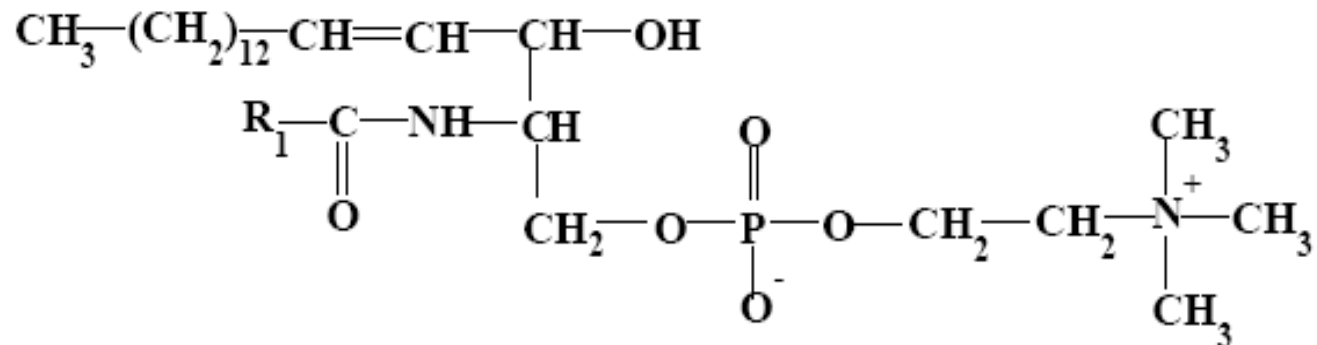

SFINGOMYELIN

Name of X	Structure of X	Name of Sphingolipid
(b) Hydrogen	—H	Ceramide
(c) Phosphocholine	$\begin{array}{c} \text{O} \\ \parallel \\ \text{—P—O—CH}_2\text{CH}_2\text{N}^+(\text{CH}_3)_3 \\ \\ \text{O}^- \end{array}$	Sphingomyelin
(d) Glucose		Glucosylcerebroside
(e) Complex oligosaccharide		Ganglioside

Figure 8-8 part 2 Concepts in Biochemistry, 3/e
 © 2006 John Wiley & Sons

GLYKOLIPIDY

A. Glycerolglykolipidy

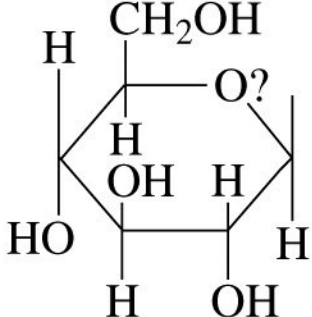
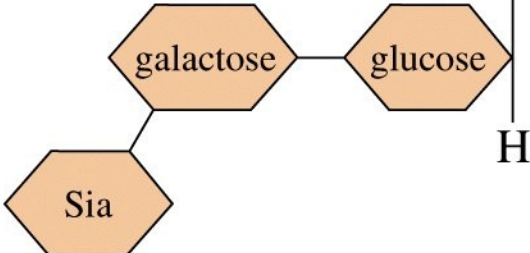
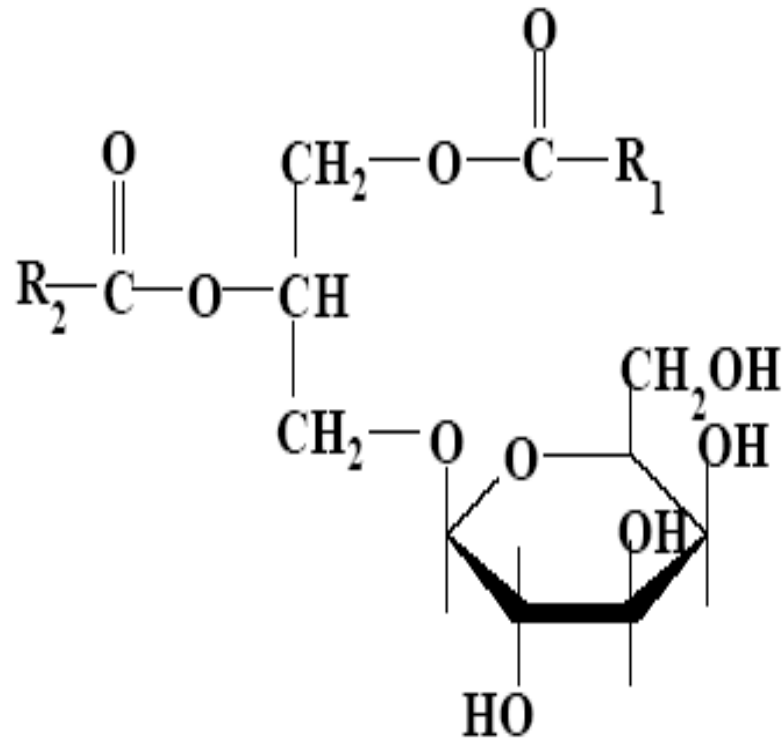

B. Cerebrosidy

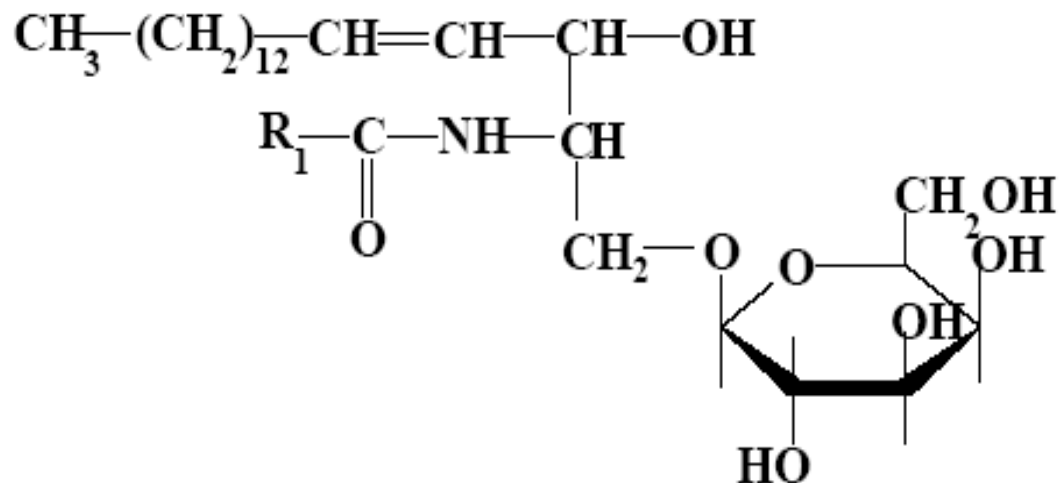

galaktocerebrosidy - mozek

sulfatidy

glukocerebrosidy - ostatní tkáně

C. Glykosfingolipidy

gangliosidy - sialová kyselina - ganglie nervových buněk

Izoprenoidní lipidy :

Základní strukturální jednotka - izopren 2-methyl-1,3-butadien

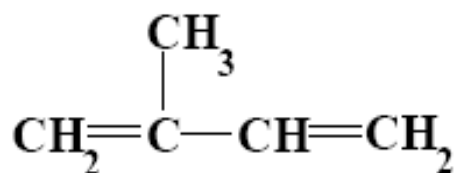

izopren

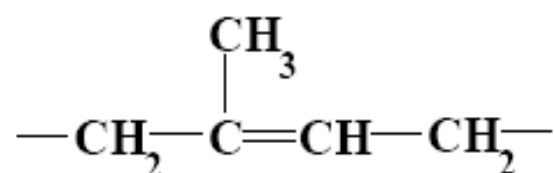

izopentenyl

Izoprenoidy

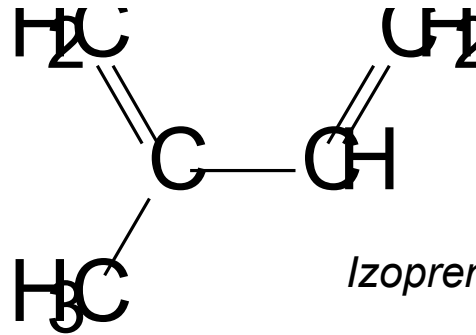

Izopren (2-methylbuta-1,3-dien)

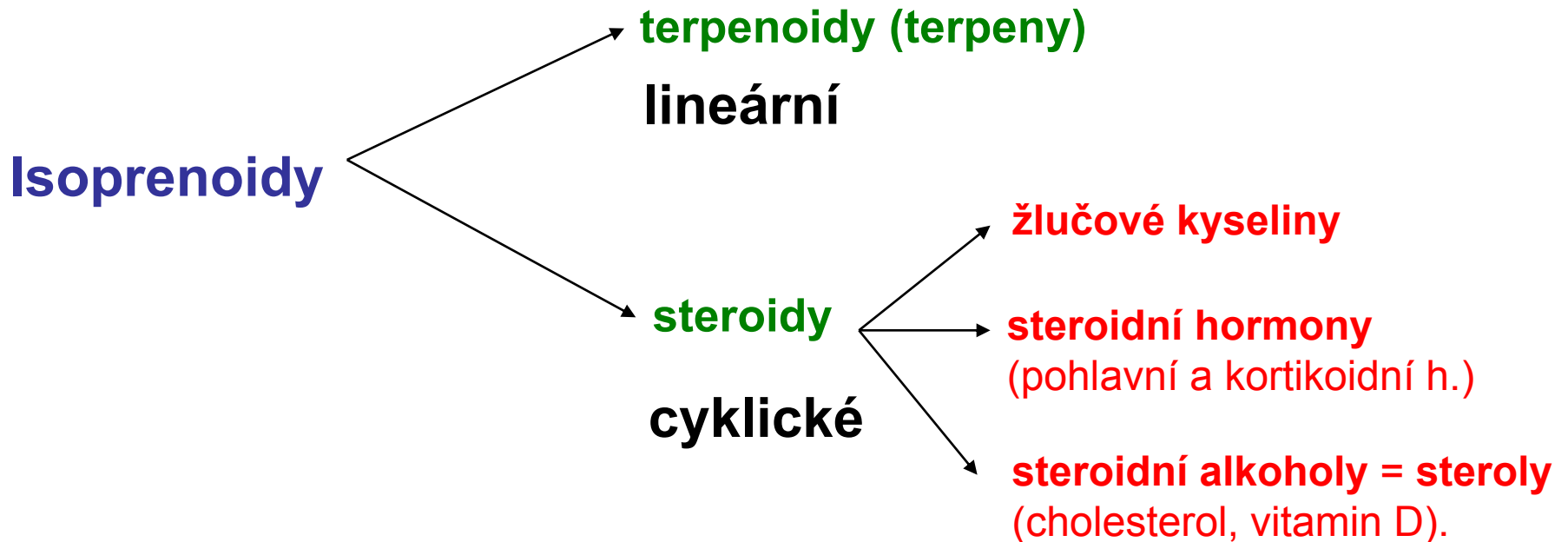

a) Terpenoidy = terpeny

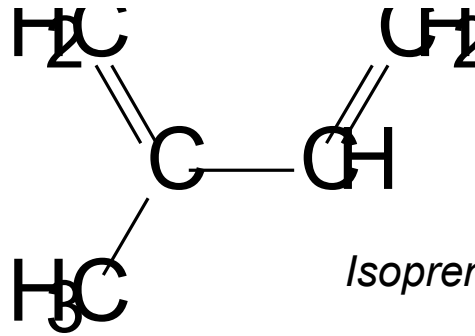

Isopren (2-methylbuta-1,3-dien)

Monoterpeny	C10, 2 isopreny	Limonen, menthol, kafr, pinen
Seskviterpeny	C15, 3 isopreny	
Diterpeny	C20, 4 isopreny	Vitamin A (retinol), fytol
Triterpeny	C30, 6 isoprenů	
Tetraterpeny	C40, 8 isoprenů	Karotenoidy, skvalen
Polyterpeny	C5n, n isoprenů	Přírodní kaučuk

Izoprenoidy

zdroje: *silice* (éterické oleje) – vonící těkavé kapaliny
(hlavně květy a plody rostlin)



nerozpustné ve vodě, vznikají oxidací silic v místech
porušení kůry jehličnanů, specifická vůně
balzámy – polotekuté směsi silic a pryskyřic

Silice:

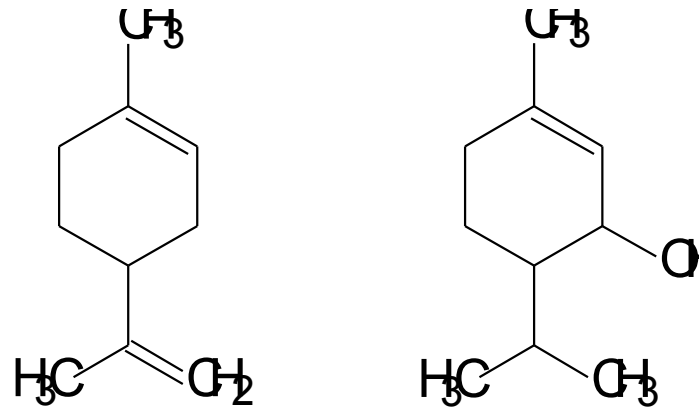

Vitamin A a karotenoidy:

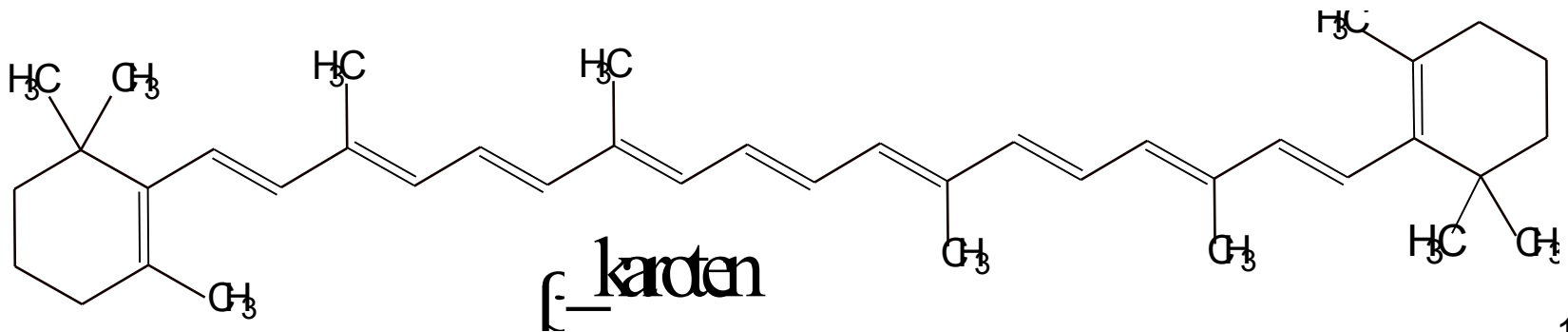
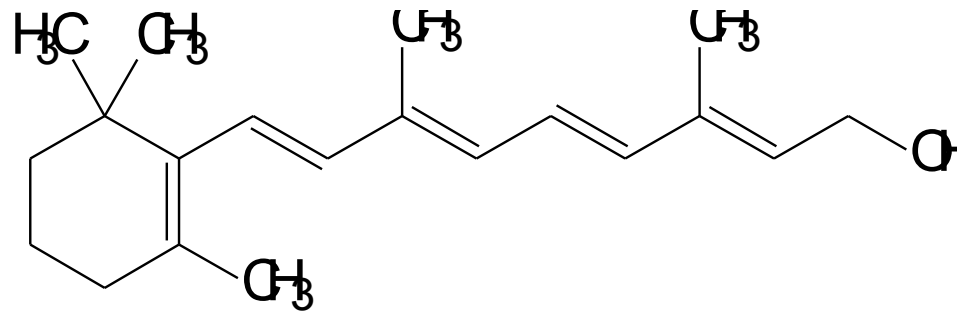

Terpeny (Terpenoidy, Isoprenoidy)

Monoterpenes

C₁₀

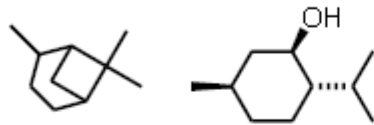

pinane

menthol

silice v terpentýnu silice v máčě

Sesquiterpenes

C₁₅

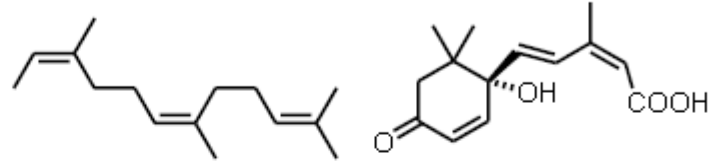

farnesane

abscisic acid

vůně zralých jablek rostlinný hormon

Diterpenes

C₂₀

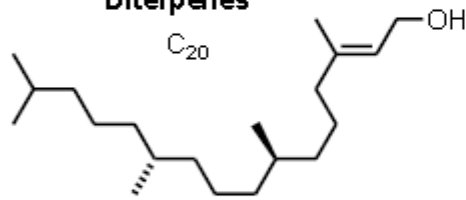

součást chlorofylu

phytol

Sesterterpenes

C₂₅

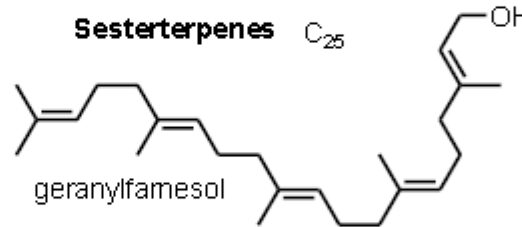

geranyl

farnesyl

Triterpenes

C₃₀

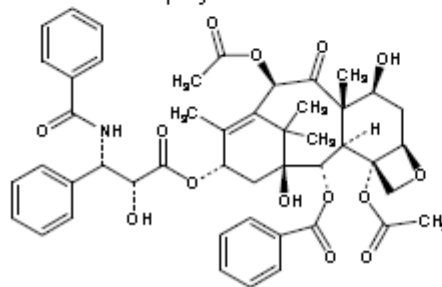

Taxol

alkaloid z tisú

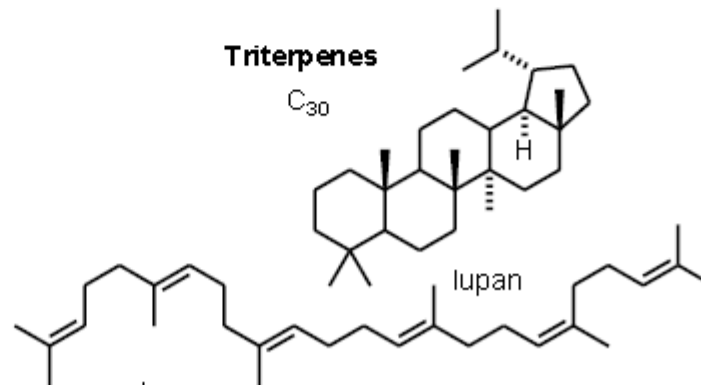

squalene

lupan

játra žraloka

STEROIDY

STERAN - cyklopentanoperhydrofenantren

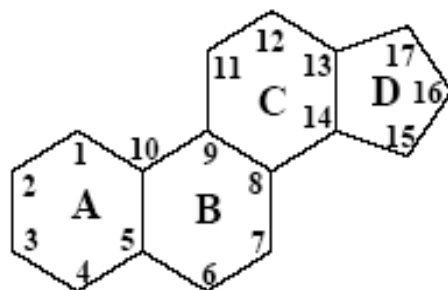

A. Steroly

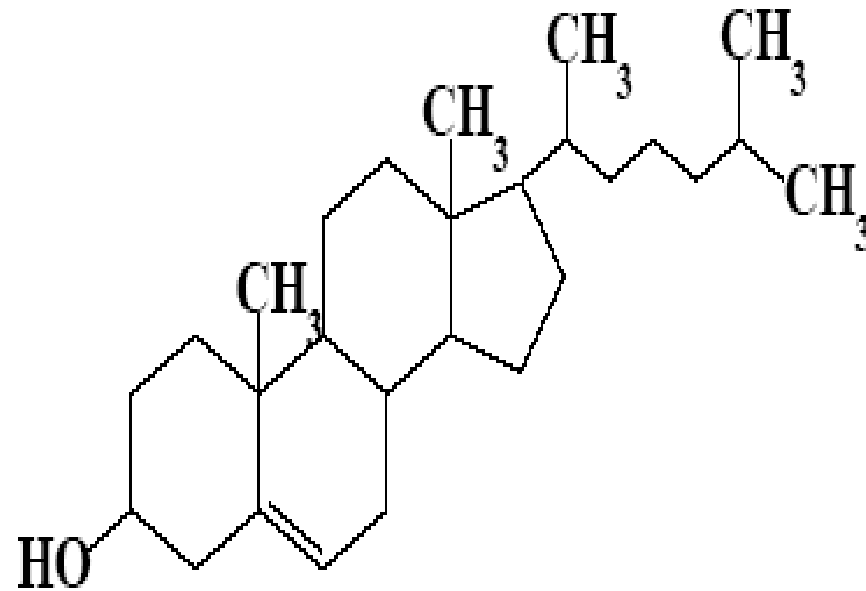

CHOLESTEROL

Steroidní hormony

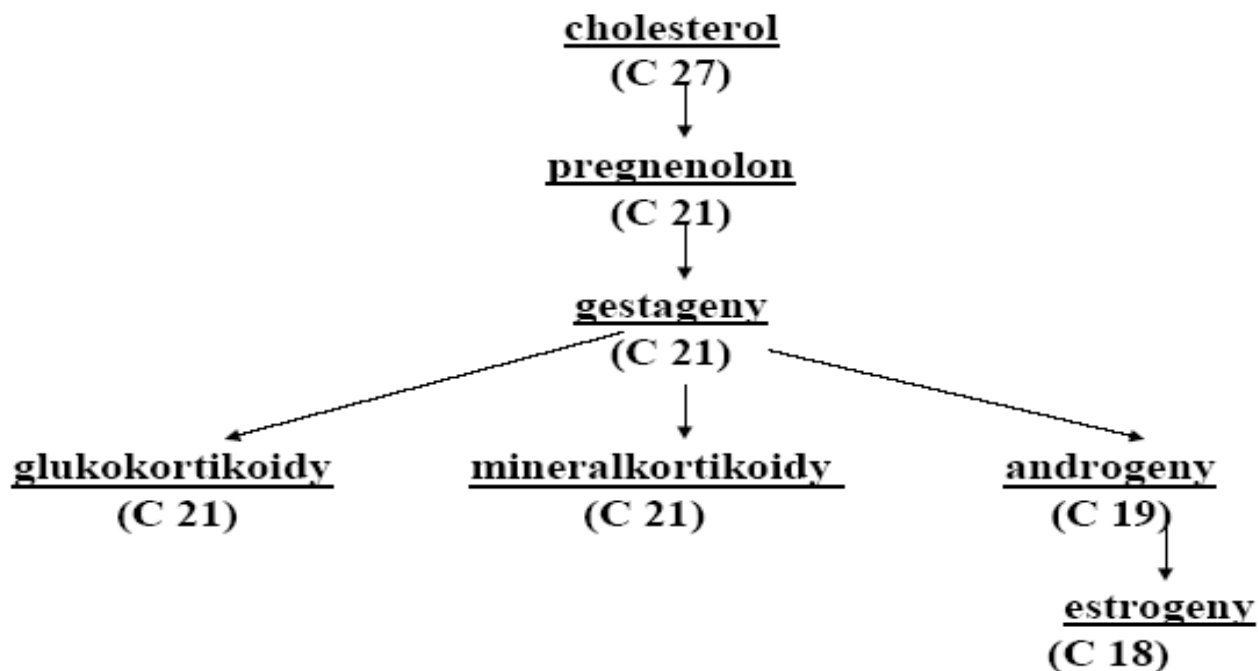

Glukokortikoidy - kortisol, kortikosteron - kůra nadledvinek

Mineralkortikoidy - aldosteron - kůra nadledvinek

Androgeny - testosteron - varlata

Estrogeny - estron, estradiol, estratriol - vaječníky

Gestageny - progesteron - vaječníky

+biosyntesa glykogenu
- proteosyntesa

zadržování Na^+ , Cl^- , HCO_3^-
vyučování K^+

cholesterol \rightleftharpoons ester cholesterolu
(5-cholesten-3 β -ol)

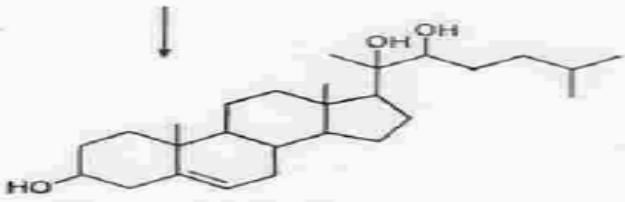

20,22-dihydroxycholesterol
(20,22-dihydroxy-5-cholesten-3 β -ol)

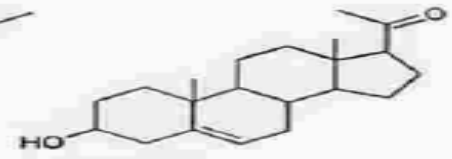

pregnenolon
(3 β -hydroxy-5-pregnen-20-on)

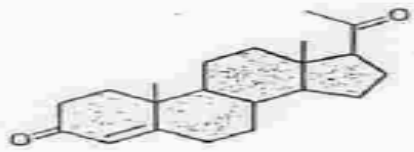

progesteron
(4-pregnen-3,20-dion)

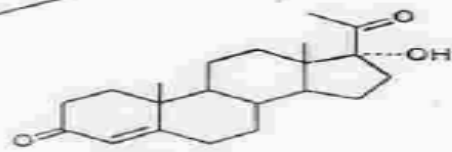

17-hydroxyprogesteron
(17-hydroxy-4-pregnen-3,20-dion)

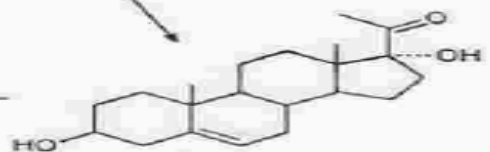

17-hydroxypregnenolon
(3 β ,17-dihydroxy-5-pregnen-20-on)

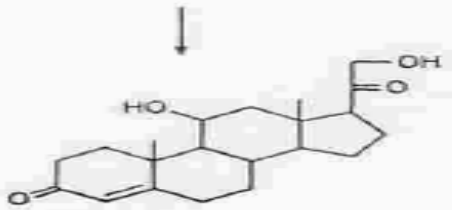

kortikosteron
(11 β ,21-dihydroxy-4-pregnen-3,20-dion)

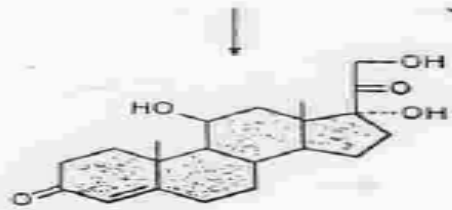

kortisol
(11 β ,17,21-trihydroxy-4-pregnen-3,20-dion)

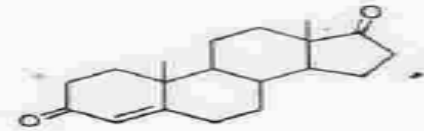

androstendion
(4-androsten-3,17-dion)

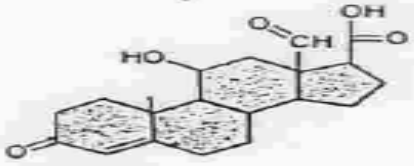

aldosteron
(11 β ,21-dihydroxy-3,20-dioxo-4-pregnen-18-al)

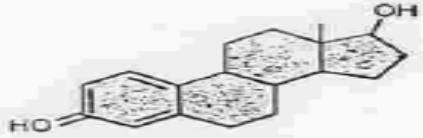

17 β -estradiol
(1,3,5(10)-estratrien-3,17 β -diol)

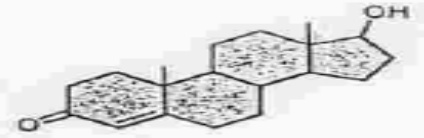

testosteron
(17 β -hydroxy-4-androsten-3-on)

játra → žlučník

B. Žlučové kyseliny - k. cholová, k. glykocholová, k. taurocholová

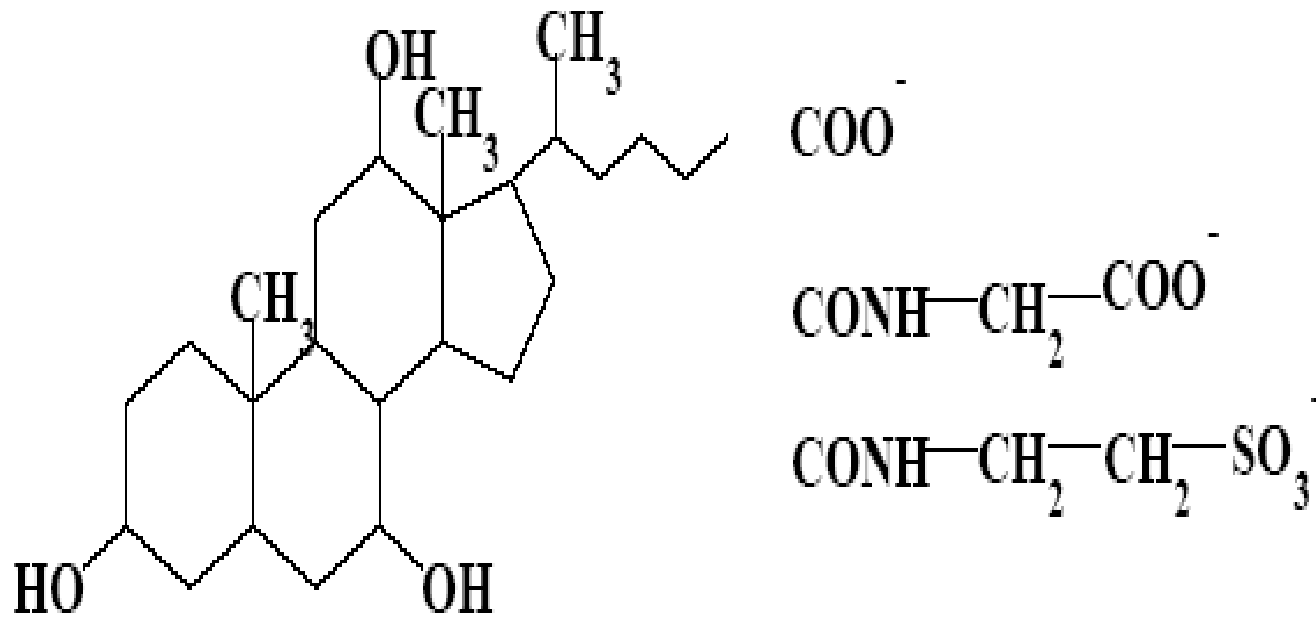

C. Kalciferoly - vitaminy - D₃ - cholekalciferol, D₂ - ergokalciferol

provitamin D

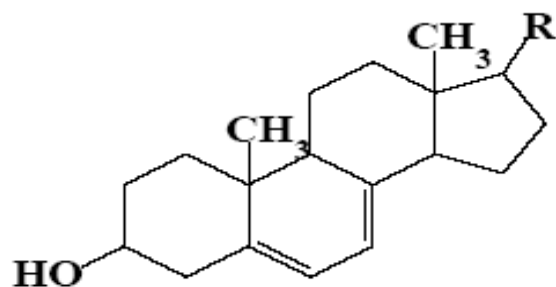

kůže

prekalciferol

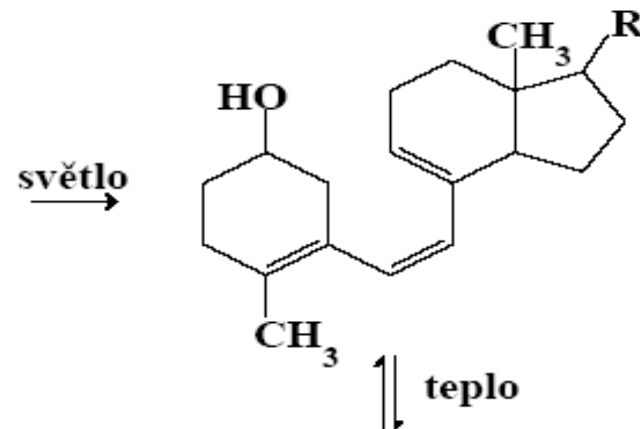

teplo

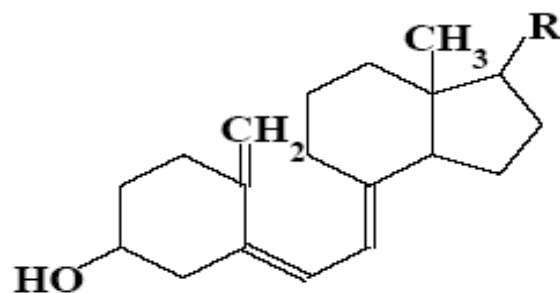

↔

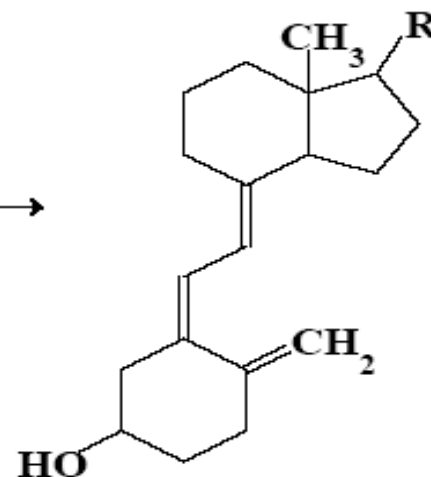

kalciferol

Membrány

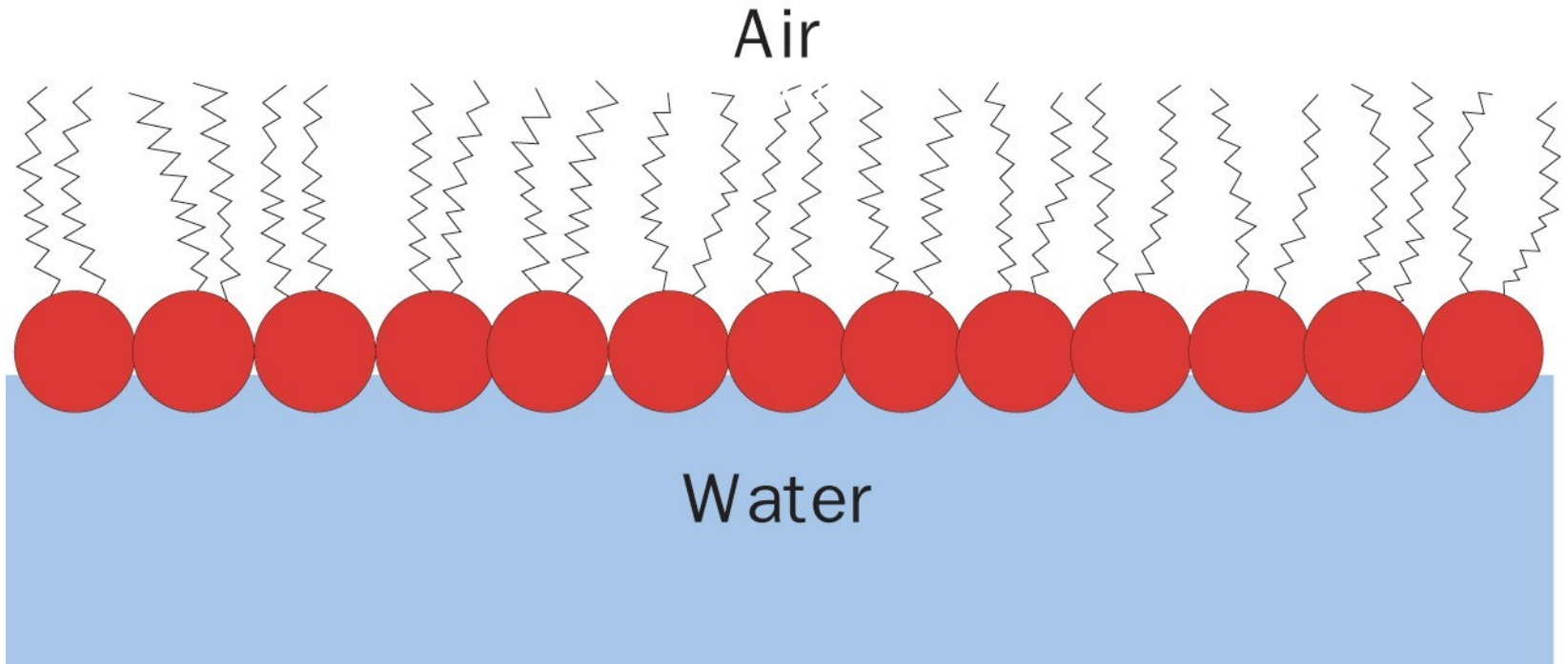

Membrány

detergenty, tenzidy,

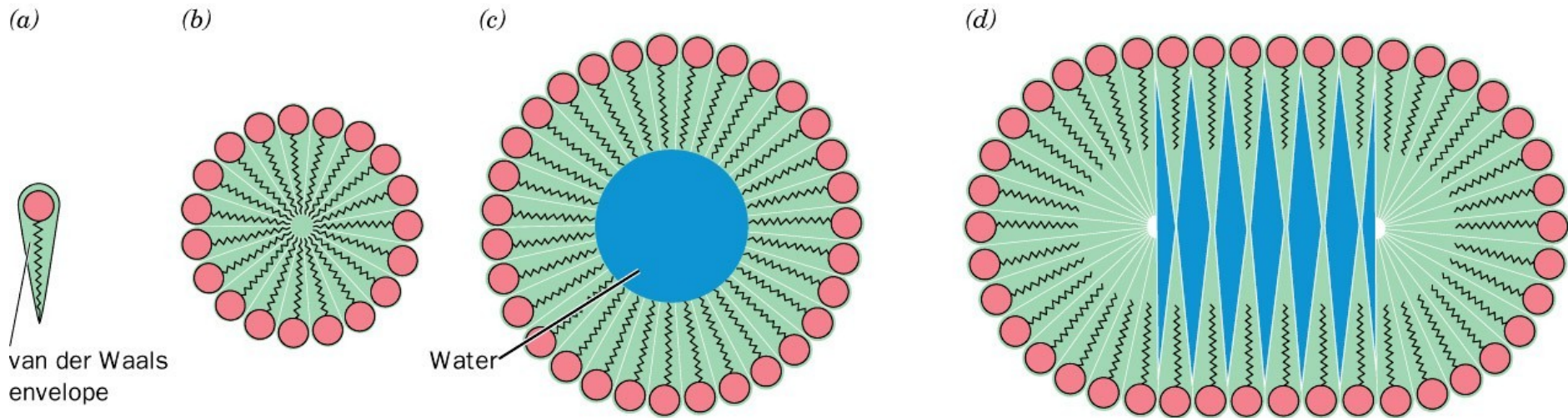

Membrány

fosfolipidy

(a)

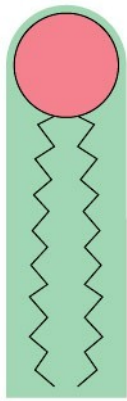

(b)

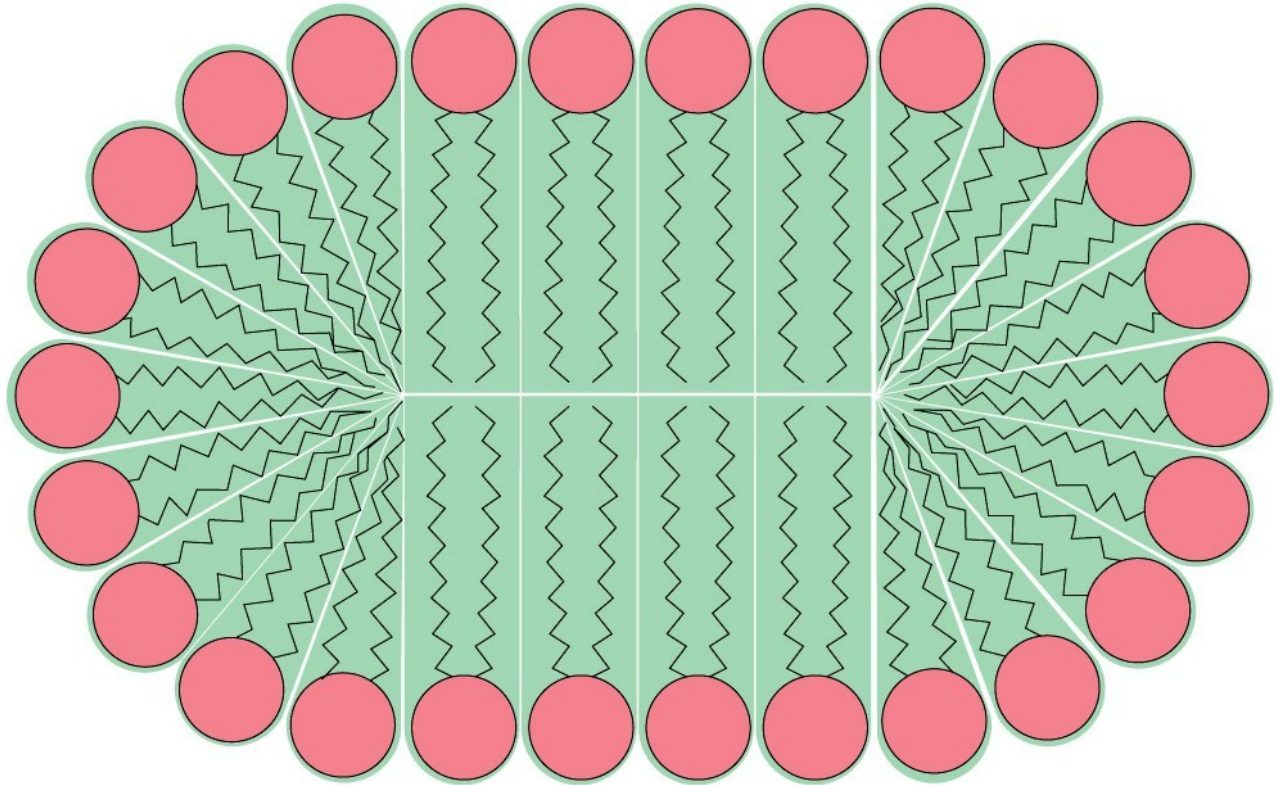

Membrány

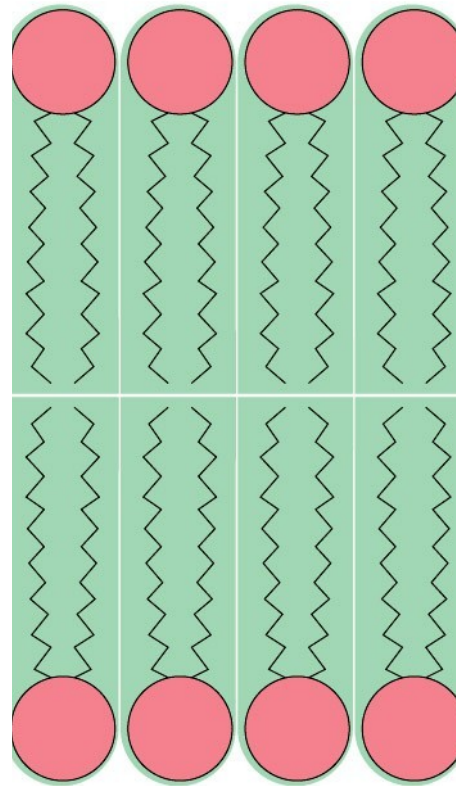

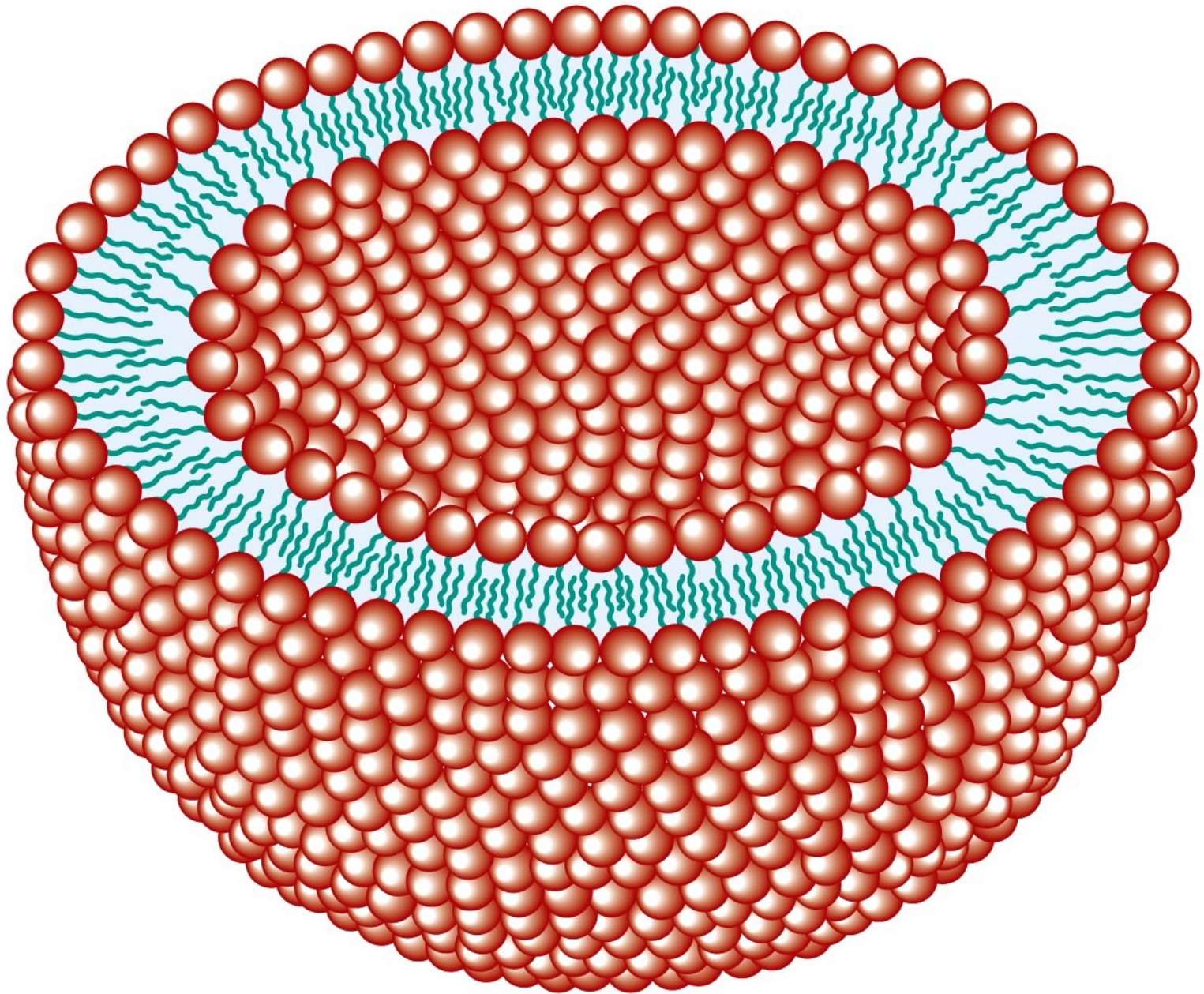

Figure 9-1b Concepts in Biochemistry, 3/e
© 2006 John Wiley & Sons

Biomembrány : agregované formy biolipidů

Význam biomembrán - transport

- kompartmentace

- komunikace

Biomembrány : agregované formy biolipidů

Molekulové složení membrán

Membrána	proteiny %	lipidy %	sacharidy %
cytoplazmatická	49	43	8
jaderná	59	35	2
mitochondriální vnější	52	46	2
mitochondriální vnitřní	76	23	1
myelinová	18	79	3

- *Lipidy* - fosfolipidy, cholesterol

funkce - strukturní

Lipid (%)	erythrocyt	myelin	mitochondrie	E.coli
fosfatidylcholin	19	10	39	0
fosfatidylethanolamin	18	20	27	65
fosfatidylglycerol	0	0	0	18
kardiolipin	0	0	23	12
sfingomyelin	18	9	0	0
glykolipidy	10	26	0	0
cholesterol	25	26	3	0

Fosfolipid, sfingomyelin, gangliosid, cholesterol

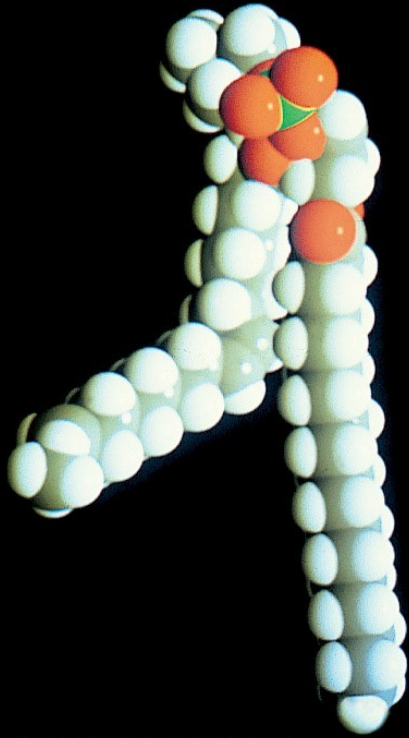

Courtesy of Richard Pastor, FDA, Bethesda, Maryland

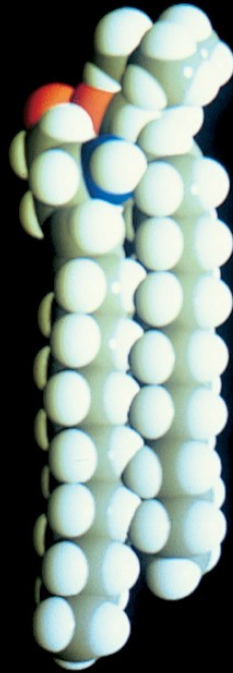

Courtesy of Richard Pastor, FDA, Bethesda, Maryland



Courtesy of Richard Venable, FDA, Bethesda, Maryland



Courtesy of Richard Pastor, FDA, Bethesda, Maryland

- *Bílkoviny* - integrální, periferní

funkce - enzymy

přenašeče

receptory

strukturní

- *Sacharidy* - glykolipidy, glykoproteiny

funkce - kotvení glykolipidů a glykoproteinů

v membránách

- rozpoznávací

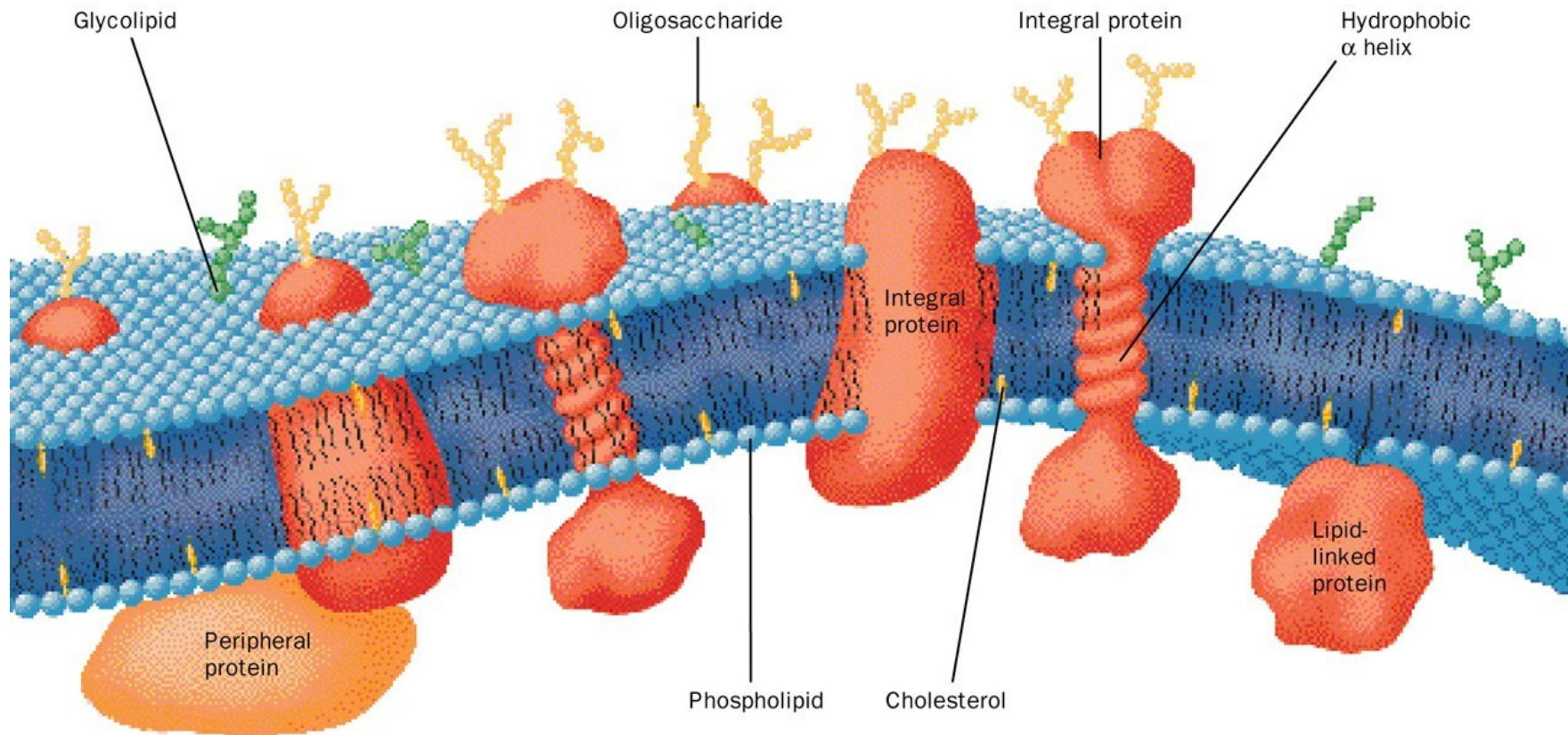

Membránově vázané bílkoviny

Membránové bílkoviny

interagují

integrální

elektrostaticky

hydrofobně

zaměřené

transmembránové

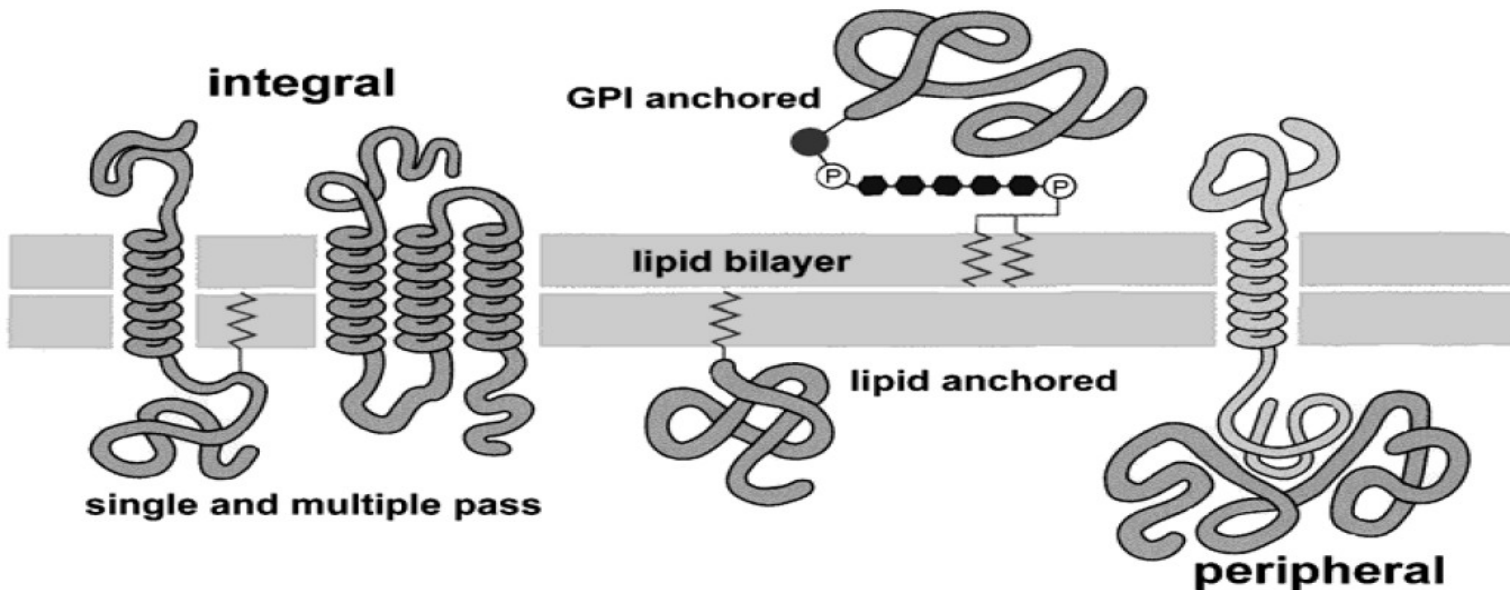

Bakteriorhodopsin

(a)



(b)

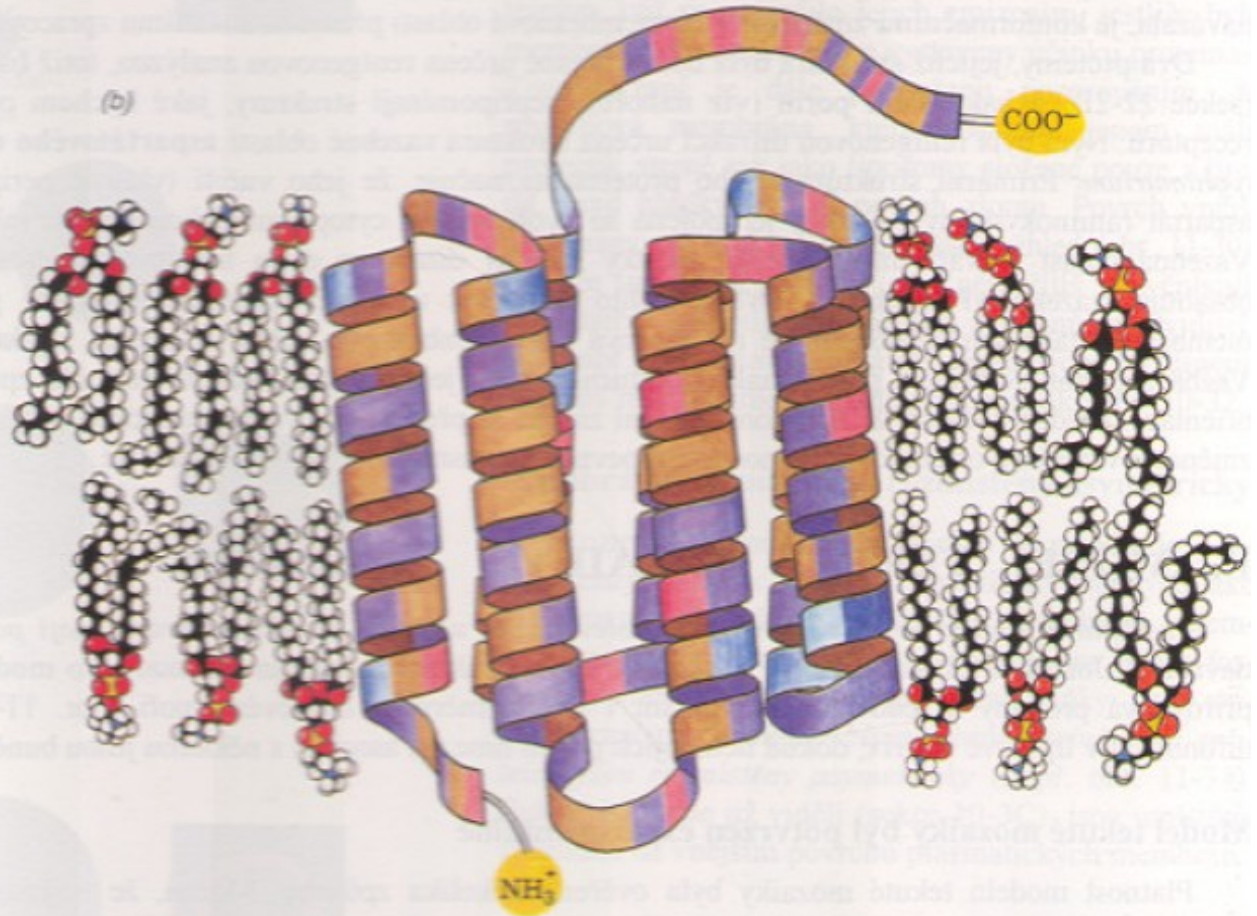

Modely membrán :

GORTER a GRENDL (1925) - Lipidová dvojvrstva

SINGER a NICHOLSON (1972) - Model tekuté mozaiky

Lipidická dvojvrstva

5 – 7.5 nm

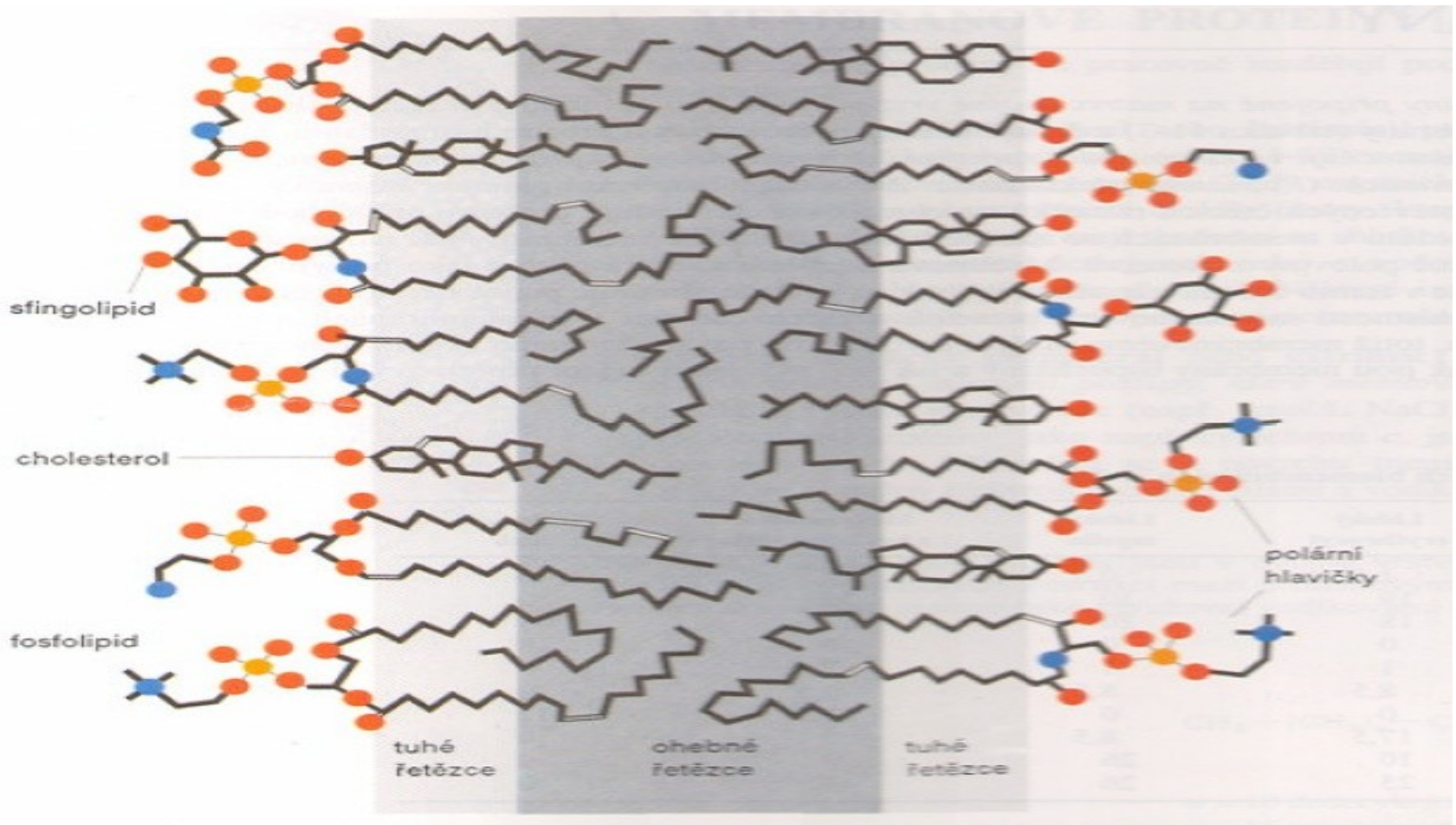

Model tekuté mozaiky

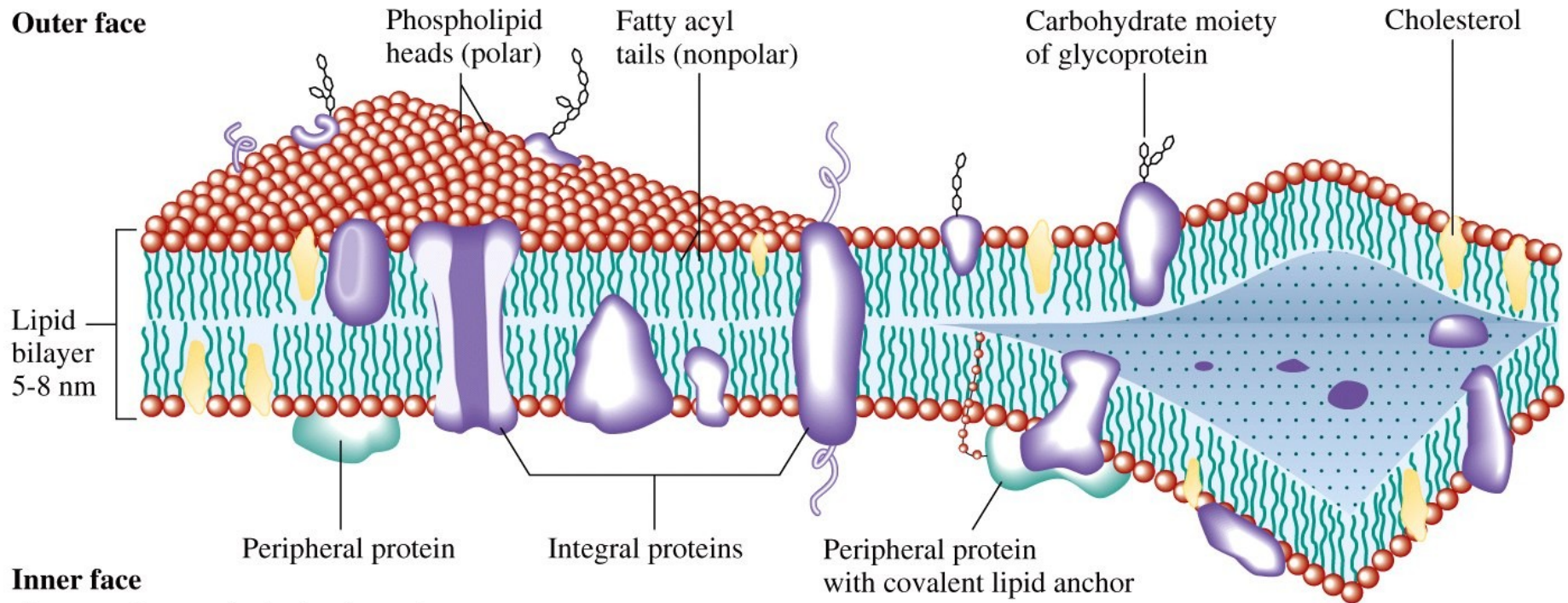
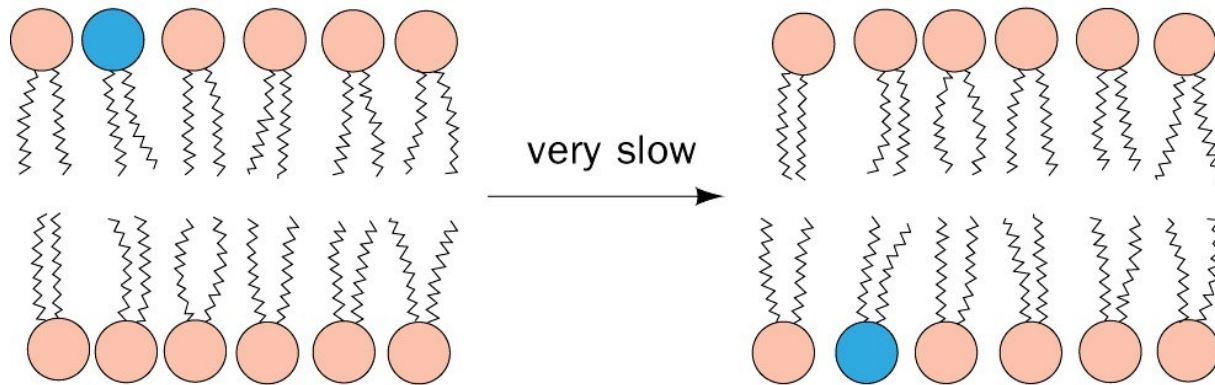

Figure 9-6 Concepts in Biochemistry, 3/e
© 2006 John Wiley & Sons

Difuze lipidů v membráně

(a) Transverse diffusion (flip-flop)



(b) Lateral diffusion

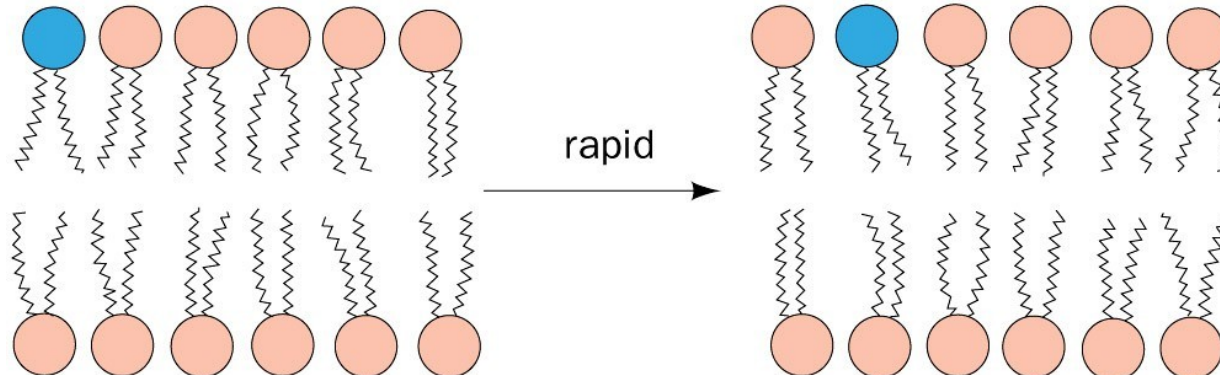

Difuze lipidů v membráně

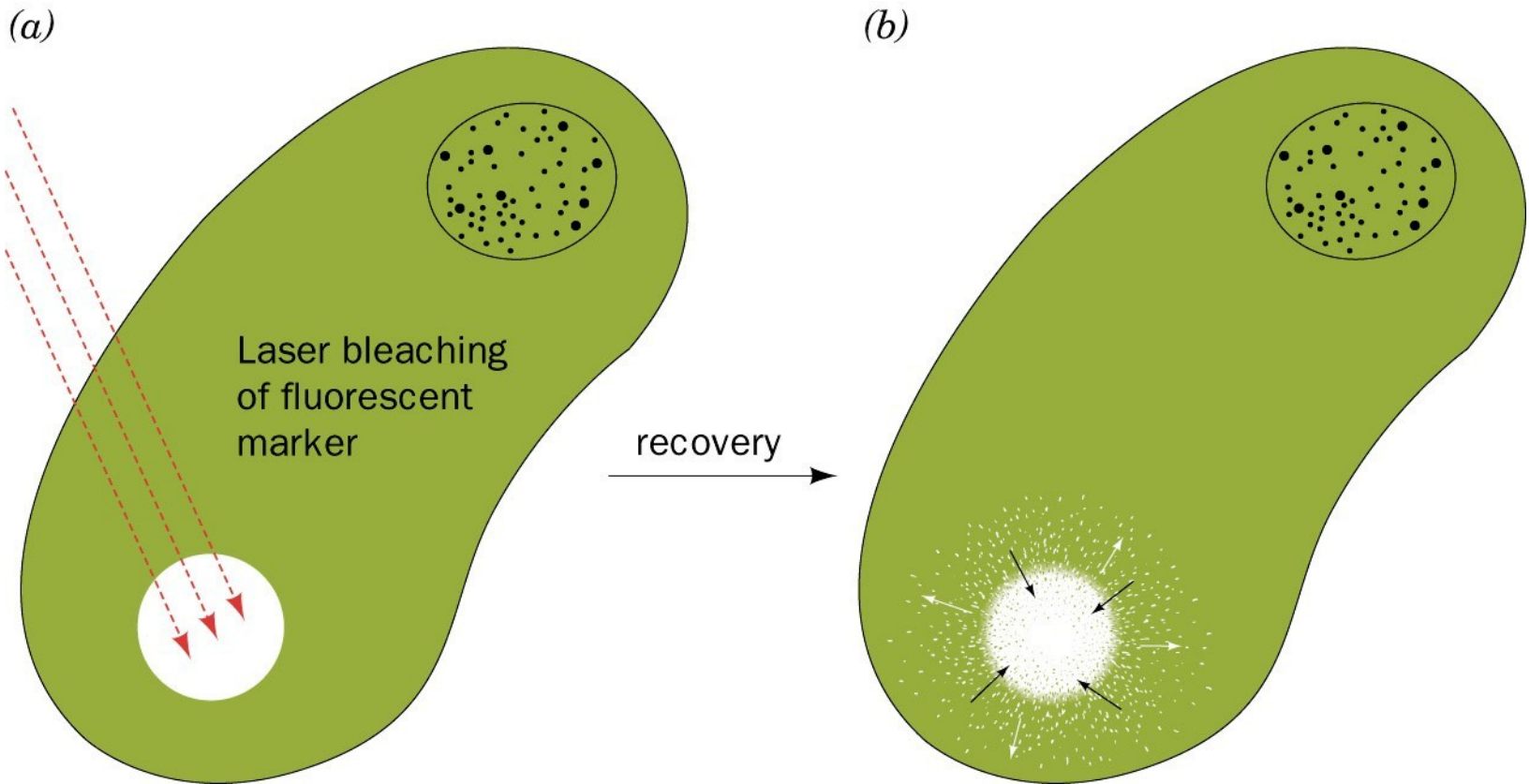

Liposomy

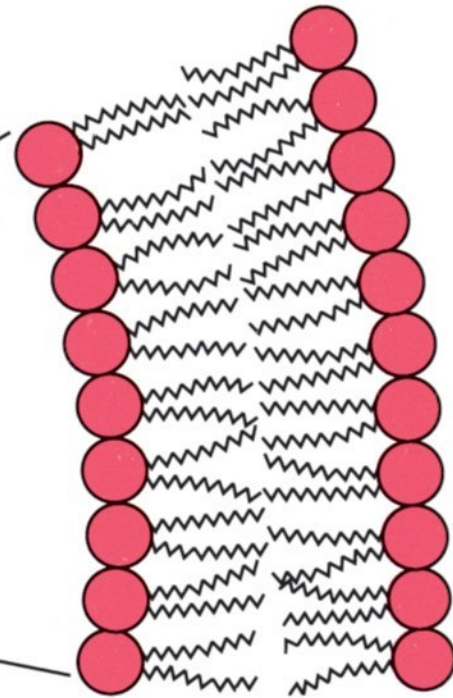
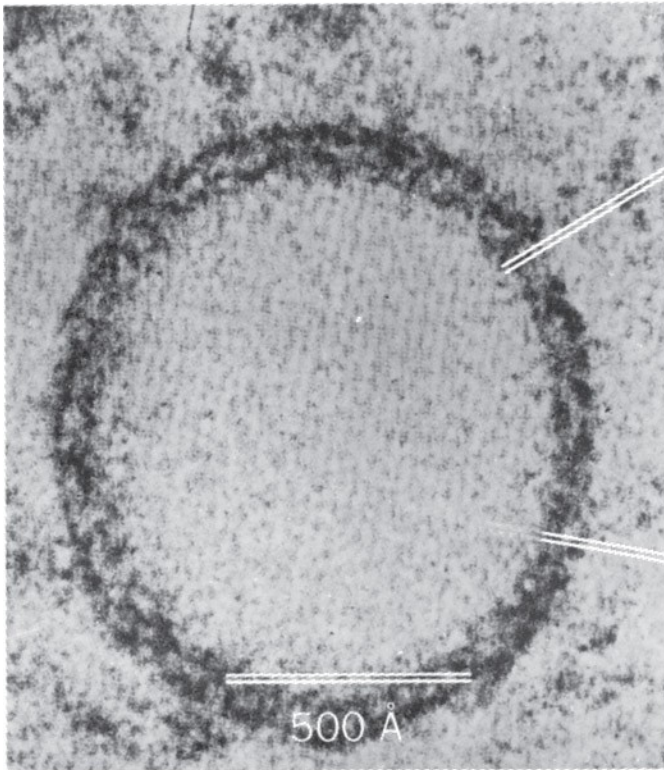

Courtesy of Walter Stoeckenius, University of California at San Francisco

Liposomy

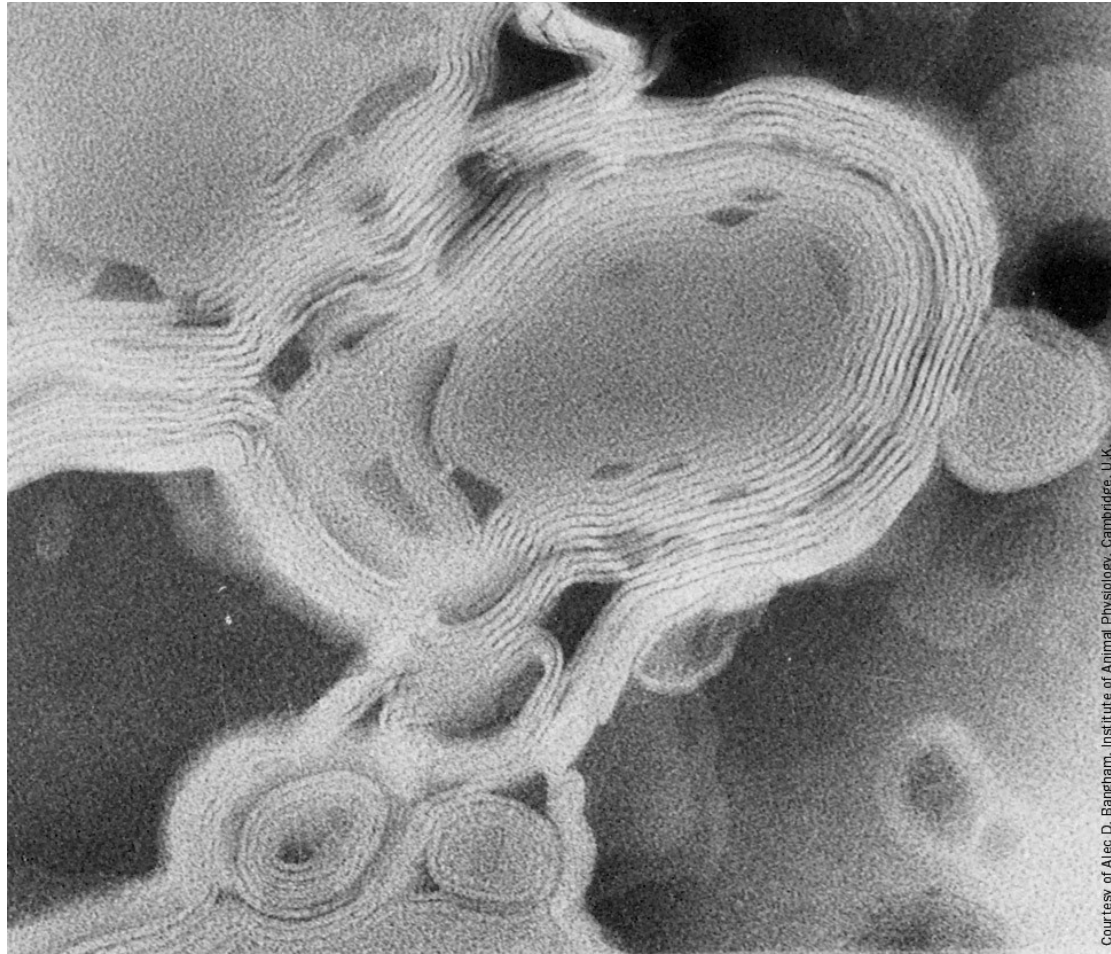

Transport

- Přísun živin
- Odstraňování odpadních látek
- Udržení osmotické rovnováhy
- Udržování potřebných chemických a elektrochemických rovnováh

Transport látek membránami :

- Nespecifická permeace **Bez přenašeče**
- Specifický přenašečový systém - pasivní transport - usnadněná
S přenašečem - bílkovina a výměnná
difuze
- aktivní transport
- Pinocytóza - **Endocytóza**
- **Exocytóza**

Prostá difuze

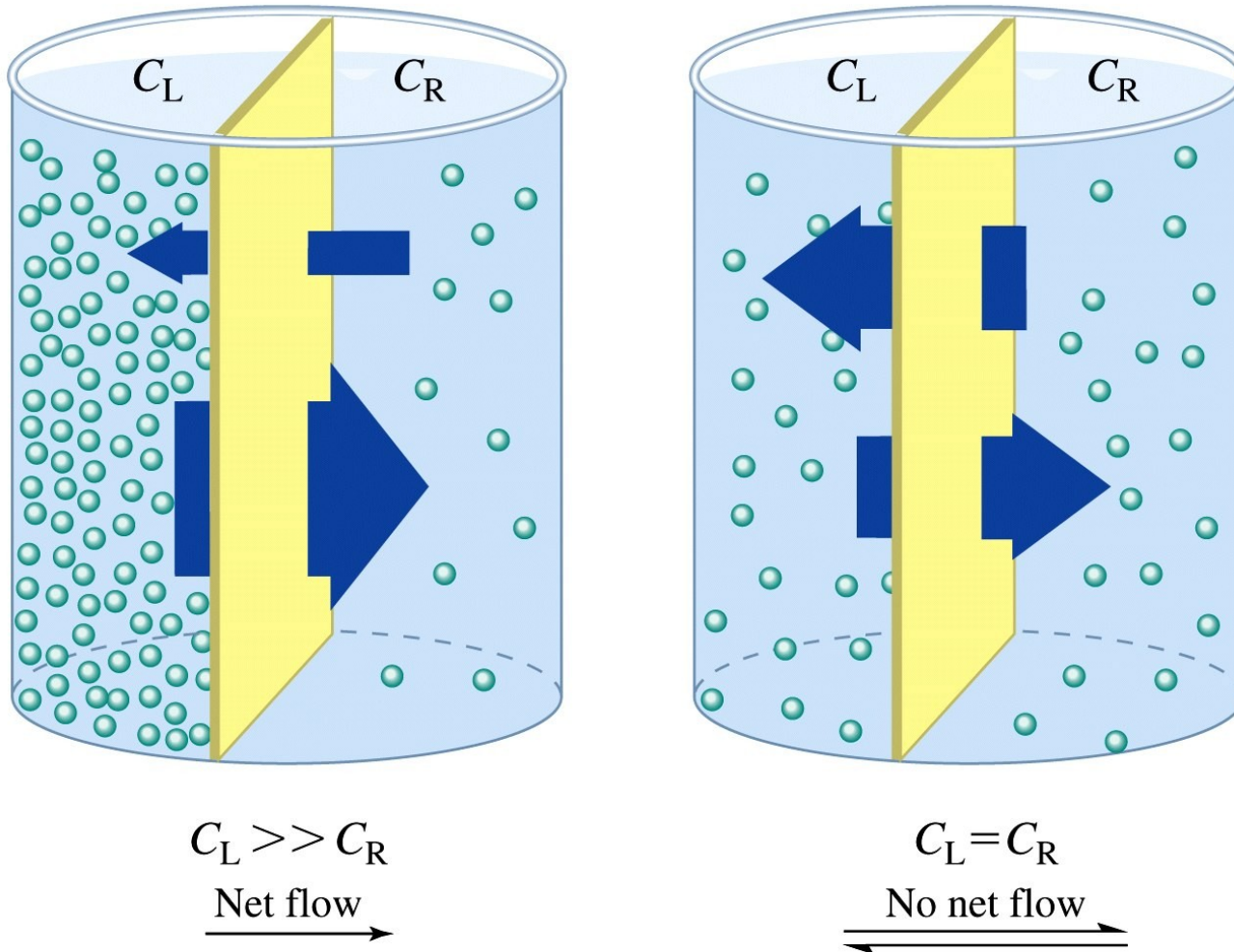

Osmóza

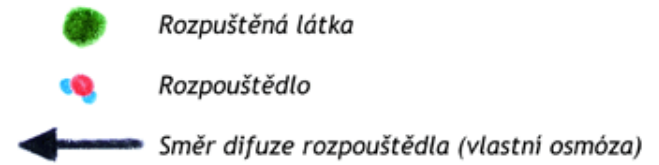

STAV 1

Polopropustná
membrána

Koncentrovanější roztok

Méně koncentrovaný roztok

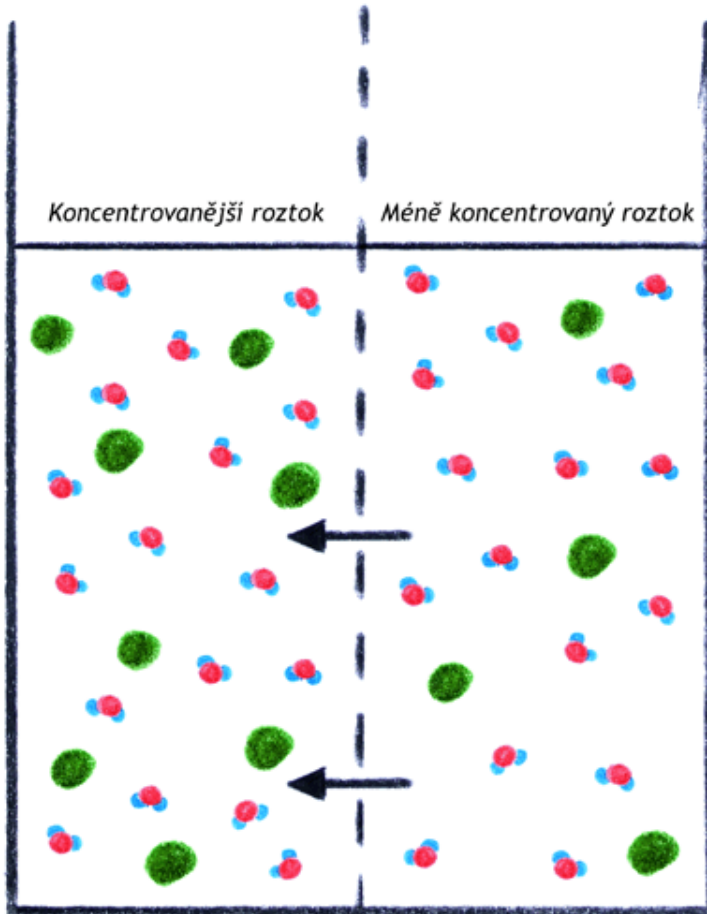

STAV 2

Oba roztoky
o stejné
koncentraci

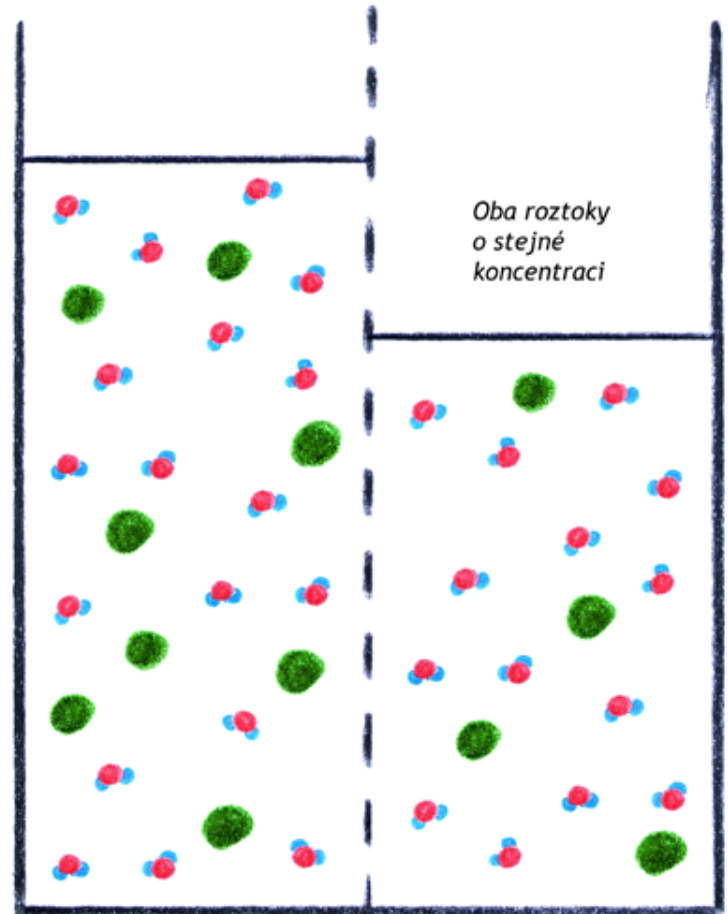

Nespecifický transport

- Rozpuštěním v membránových lipidech – plyny, organické látky
- Nepravidelnostmi v uspořádání lipidů – H_2O
- Póry

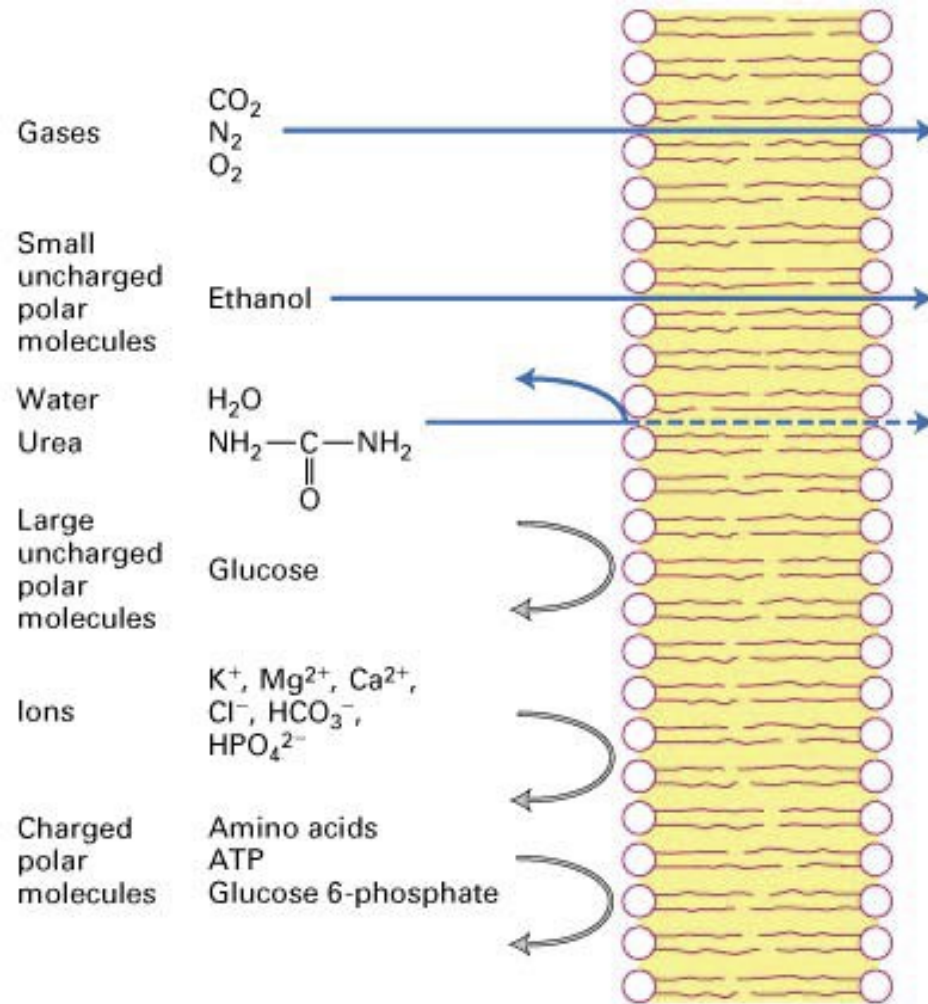

Prostá difuze - pory

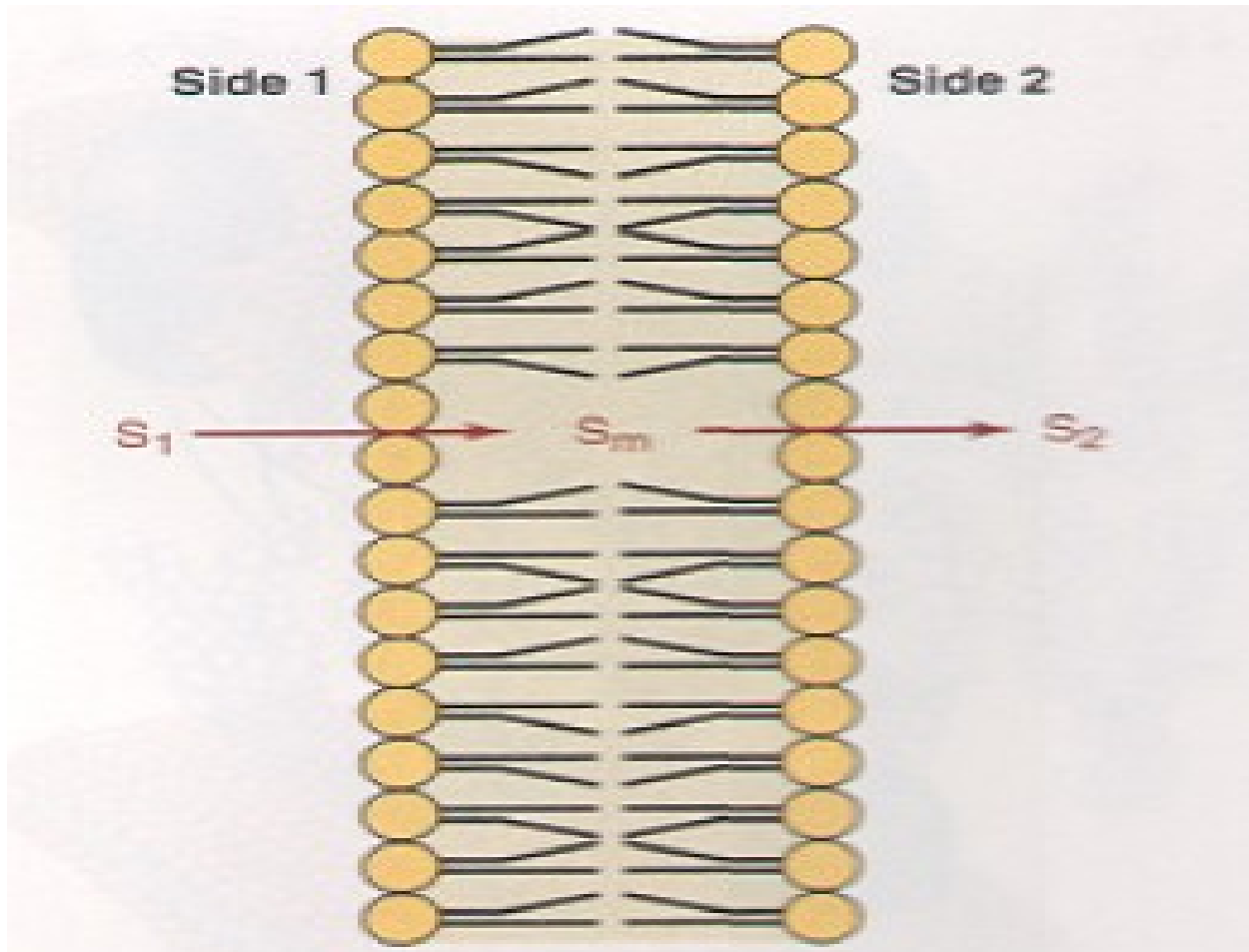

- Rozpuštěním v membránových lipidech – plyny, organické látky
- Nepravidelnostmi v uspořádání lipidů – H_2O
- Póry
- Hydrofilními kanálky

Mezerový spoj - konexin

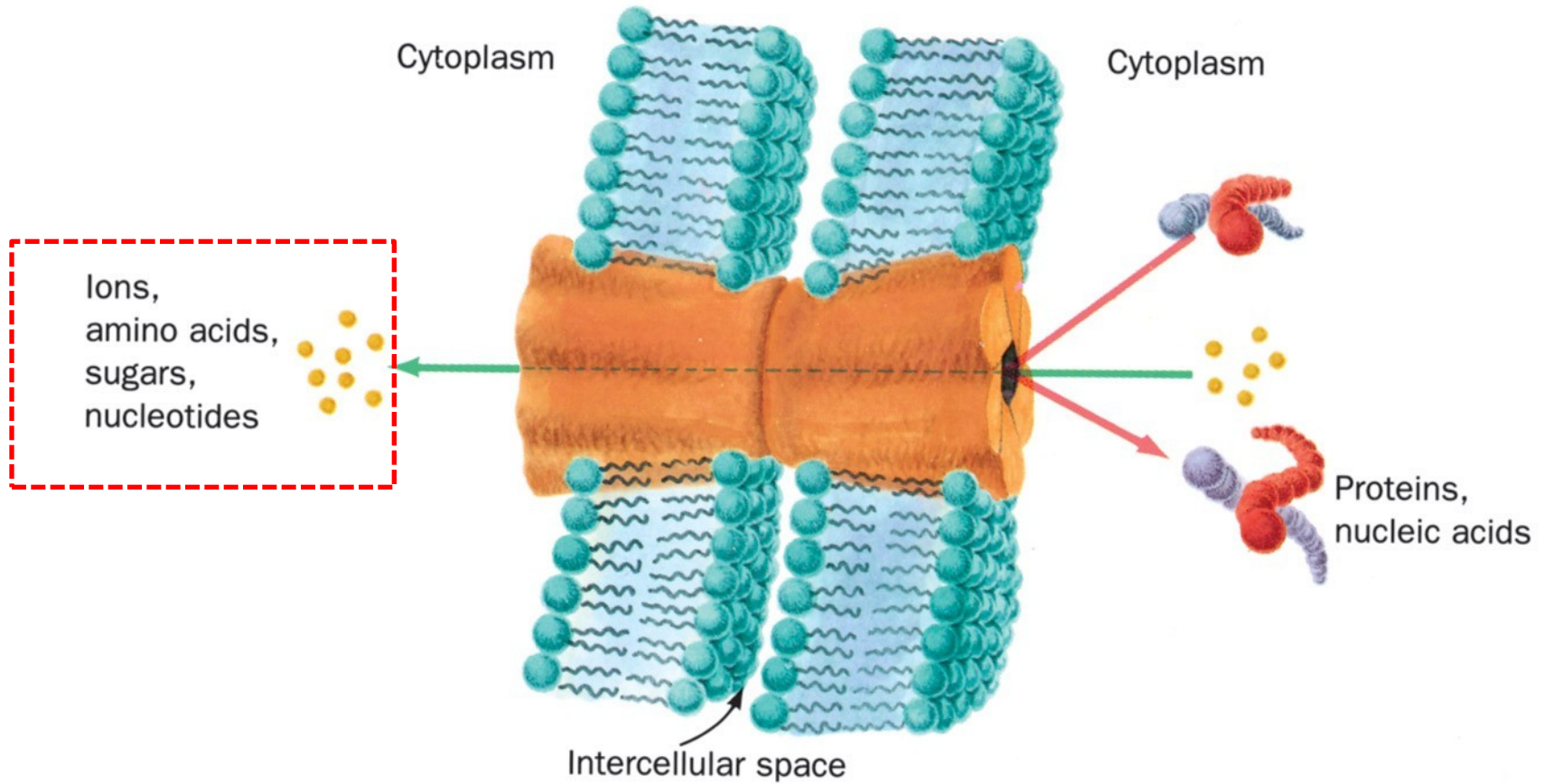

Difuze prostá versus usnadněná

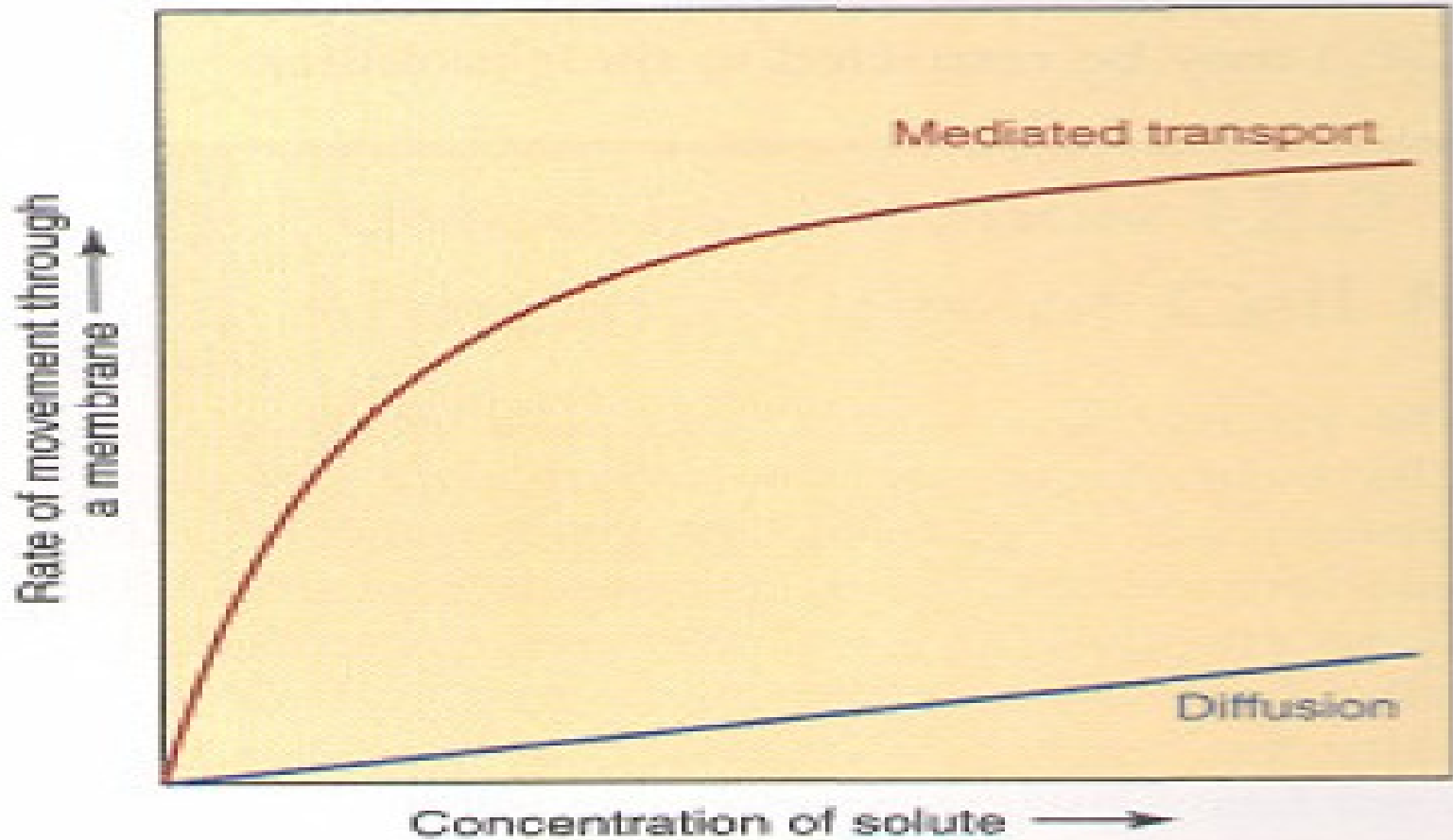

Typy transportu

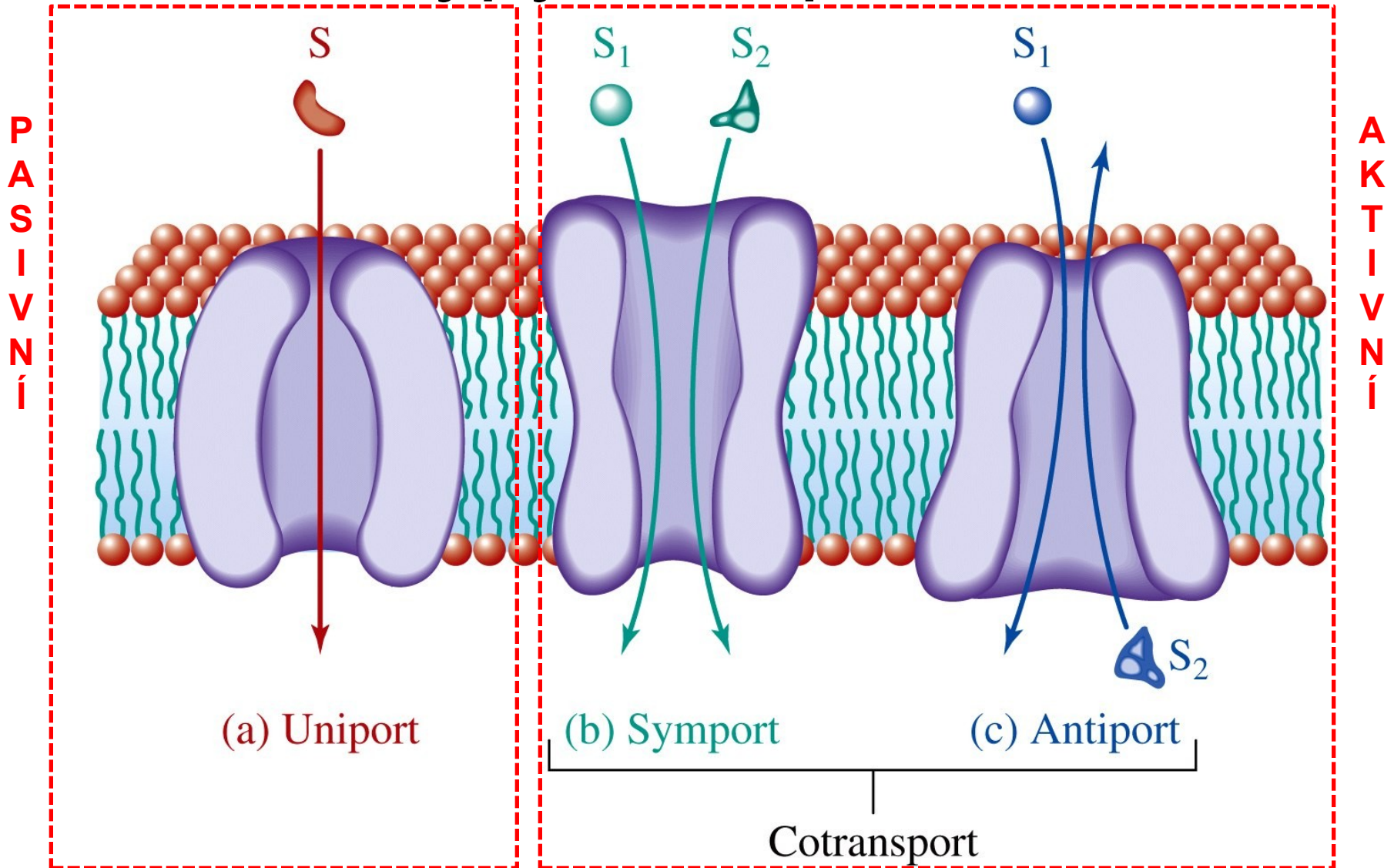

Pasivní transport – usnadněná difuze

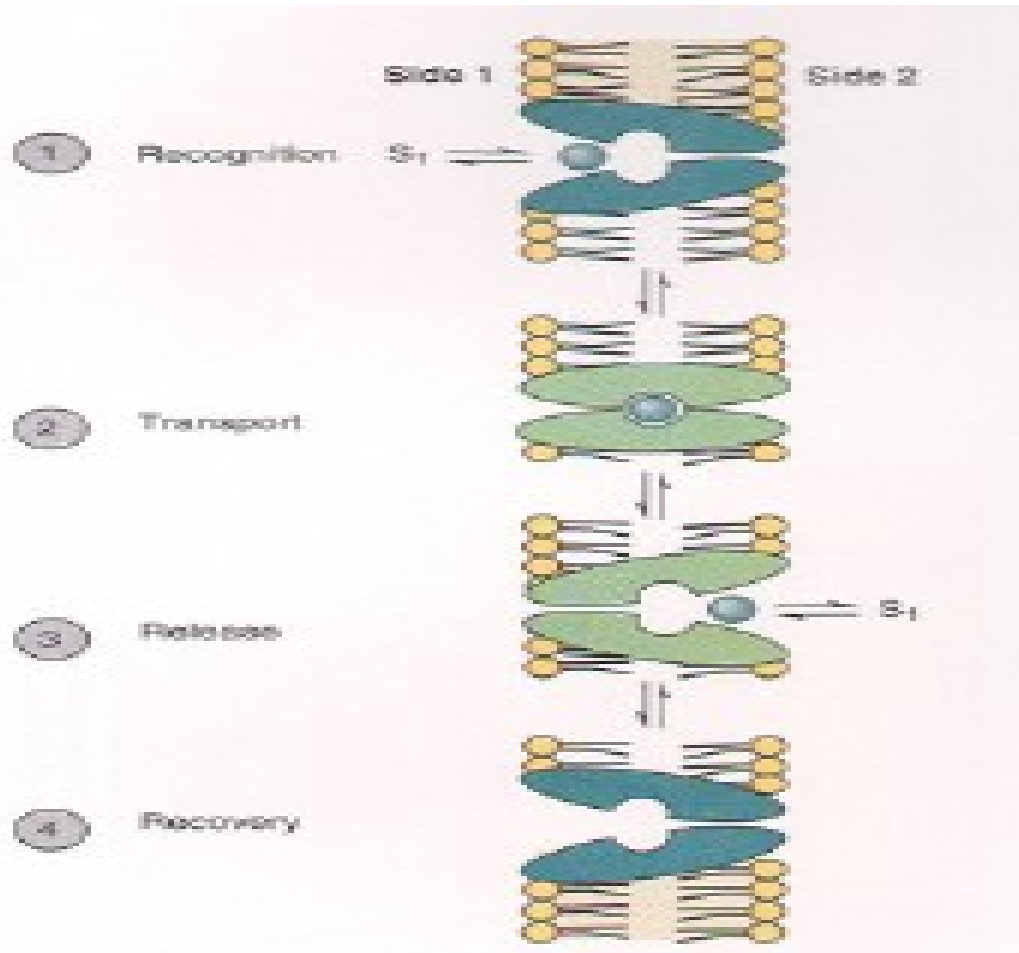

Usnadněná difuze

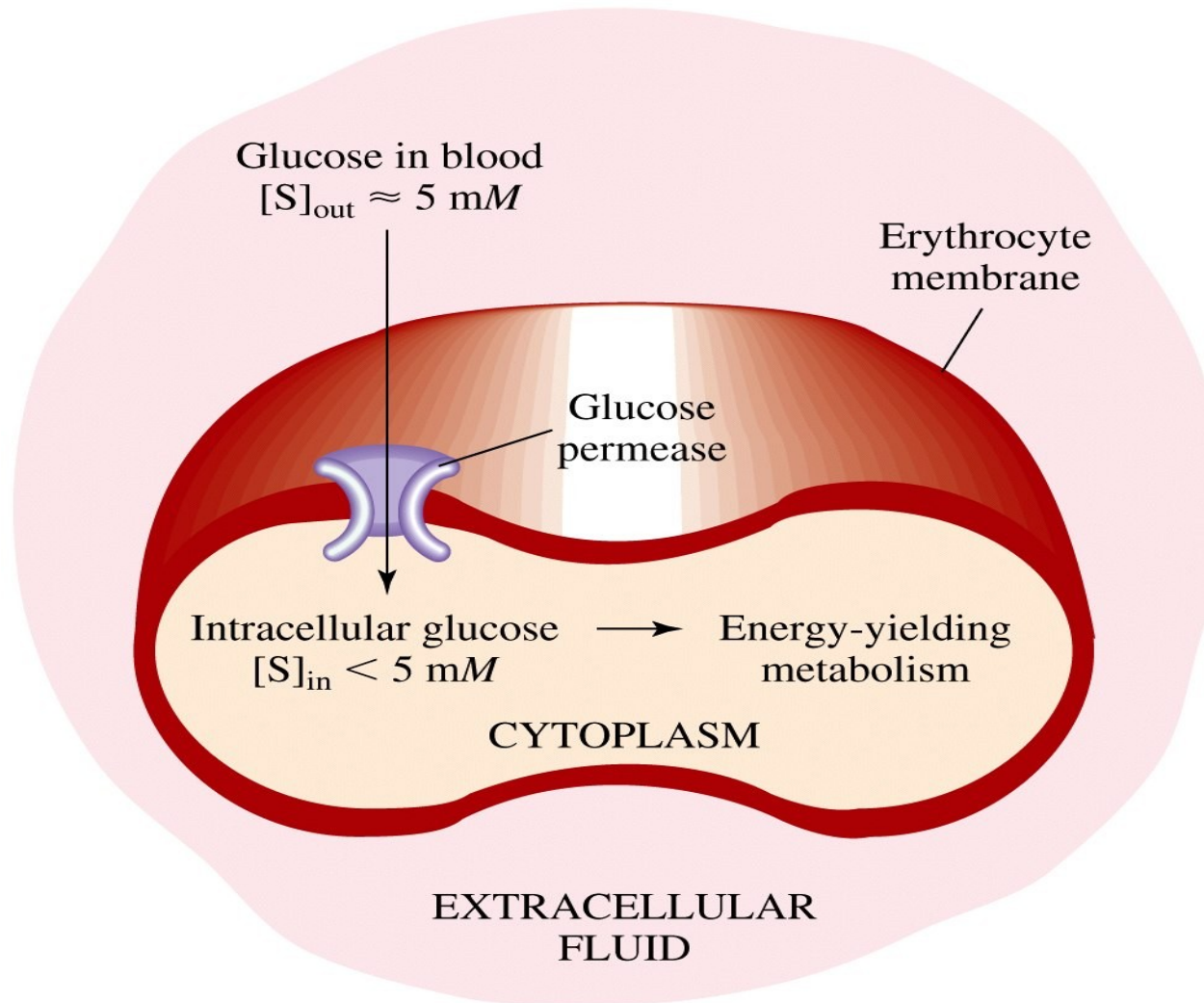

Aktivní transport

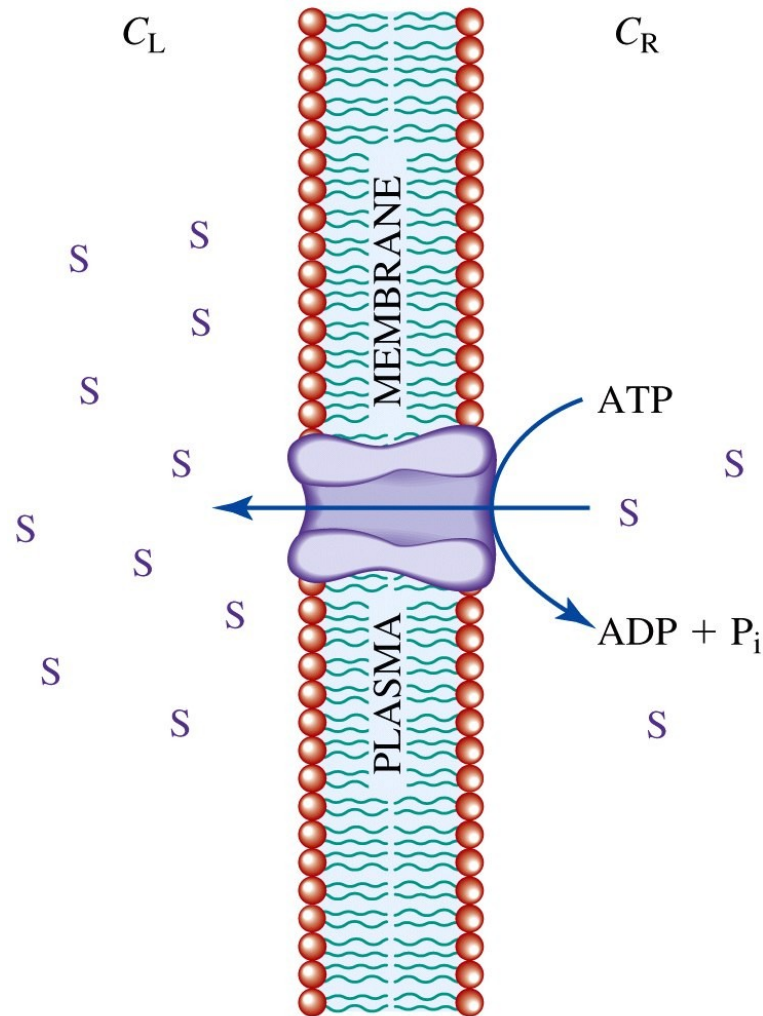
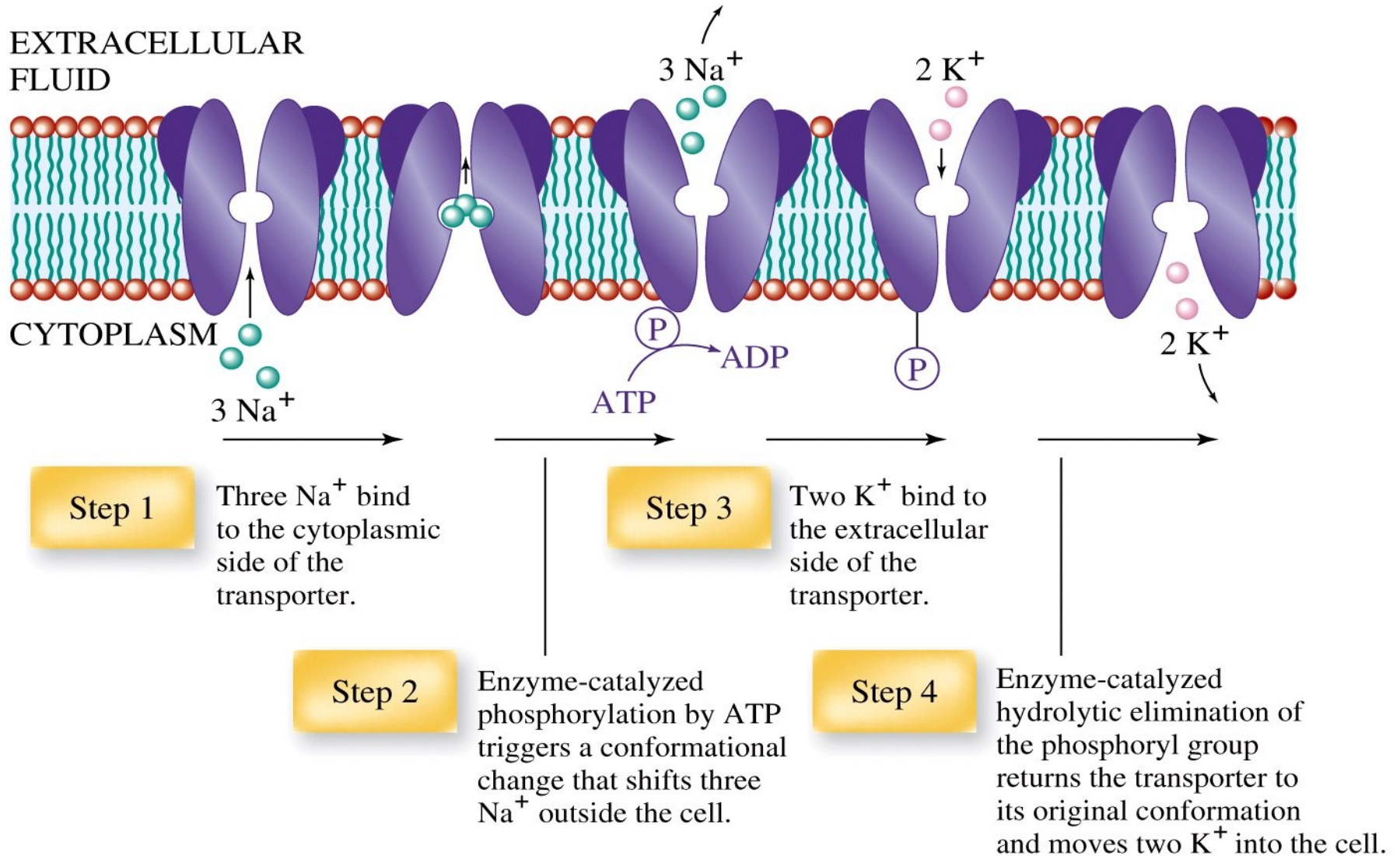
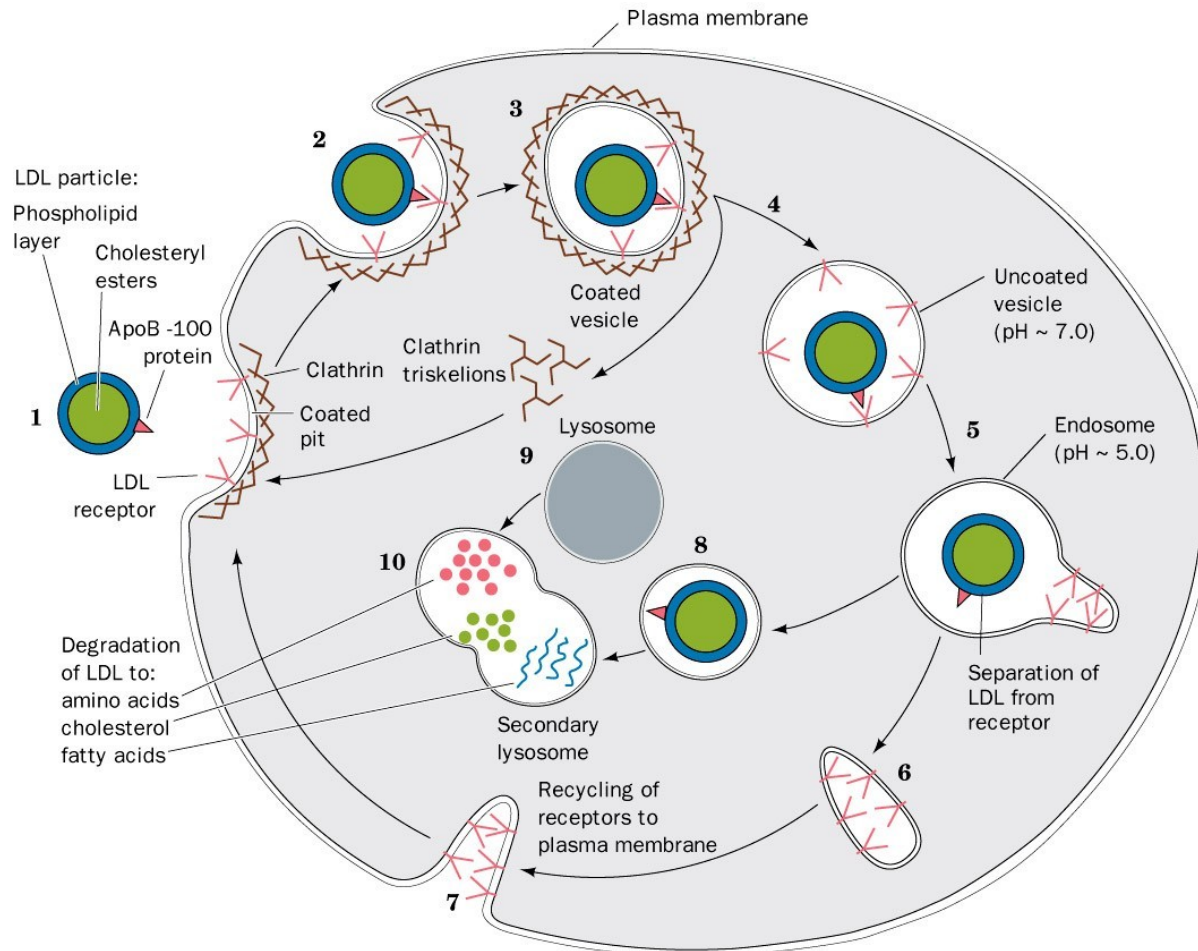

Figure 9-9 Concepts in Biochemistry, 3/e
© 2006 John Wiley & Sons

Na⁺ ATPase



Pinocytoza - endocytoza



Pinocytoza - exocytoza

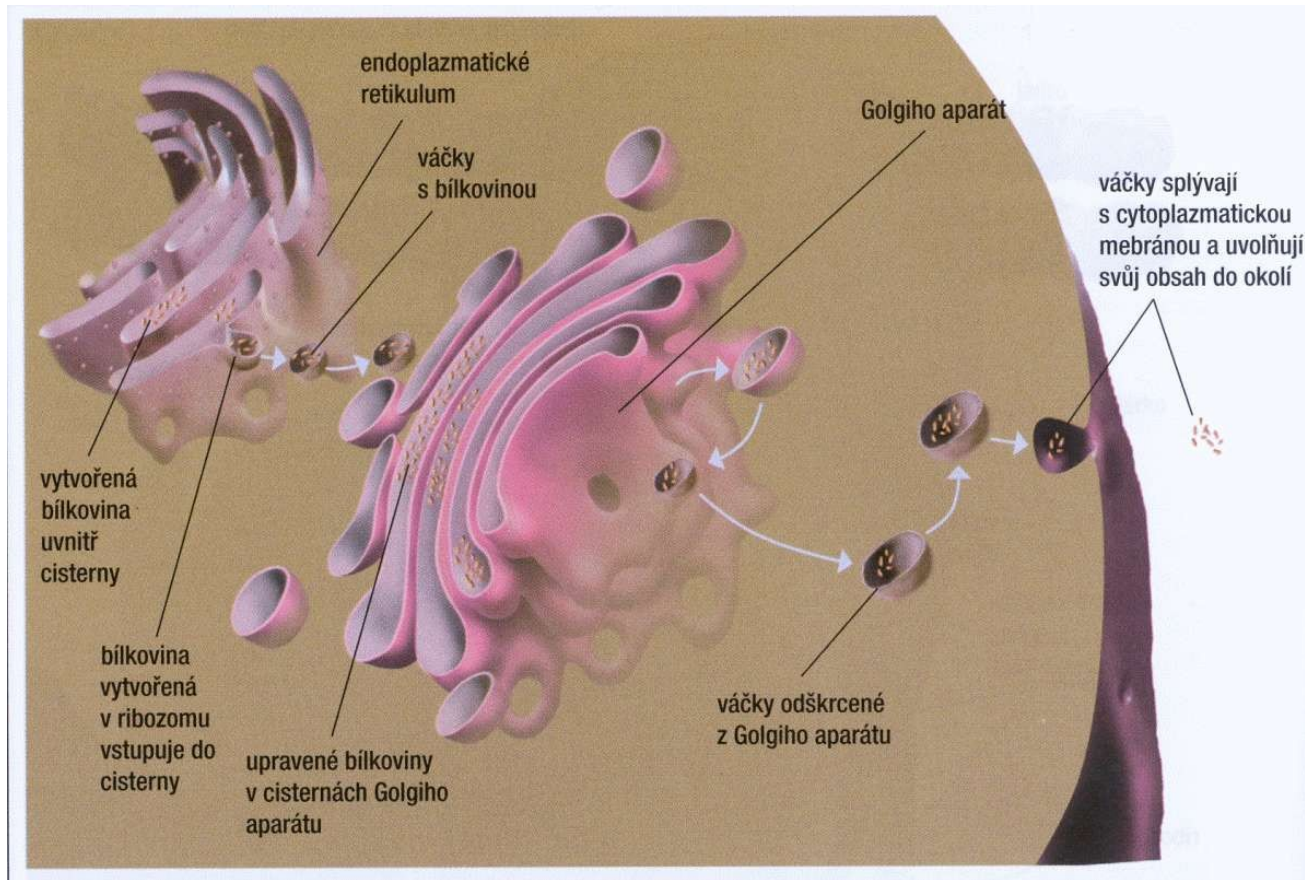

Plazmatické lipoproteiny

Charakteristiky hlavních tříd lipoproteinů v lidské plasmě

Třída lipoproteinů	Hlavní lipidy ^a	Apoproteiny	Hustota g / mL	Průměr částice nm
Chylomikrony a zbytky	triacylglyceroly v dietě	A-I,A-II,B-48, C-I,C-II,C-III, E	<0,95	80–500
	Transport triacylglycerolů do jater			
VLDL	endogenní triacylglyceroly, estery cholesterolu, cholesterol	B-100,C-I,C-II	0,95–1,006	30–80
	Transport triacylglycerolů do tkání			
IDL	estery cholesterolu, triacylglyceroly, cholesterol	B-100,C-III,E	1,006–1,019	25–35
LDL	estery cholesterolu, cholesterol, triacylglyceroly,	B-100	1,019–1,063	18–28
	Transport cholesterolu do tkání - špatný			
HDL	estery cholesterolu, cholesterol	A-I,A-II,C-I,	1,063–1,210	5–12
	Transport cholesterolu do jater - dobrý			

Plazmatické lipoproteiny

