



# Optical spectroscopic methods

Daniel Renčiuk  
IBP AS CR

S1001 / 2016 - CEITEC



# Contents

1. Brief background
2. Absorption spectroscopy (AS)
  1. Electronic (UV/Vis)
  2. Vibrational (IR)
3. Raman scattering
4. Emission spectroscopy
  1. Fluorescence
  2. FRET
  3. Fluorescence polarisation / anisotropy
5. Chiroptical methods
  1. Linear dichroism
  2. Circular dichroism

# Interaction of mass with EM radiation

Theory

QUANTUM  
MECHANICS

Wavefunction describes  
states of the molecule.

Experiment

SPECTROSCOPY

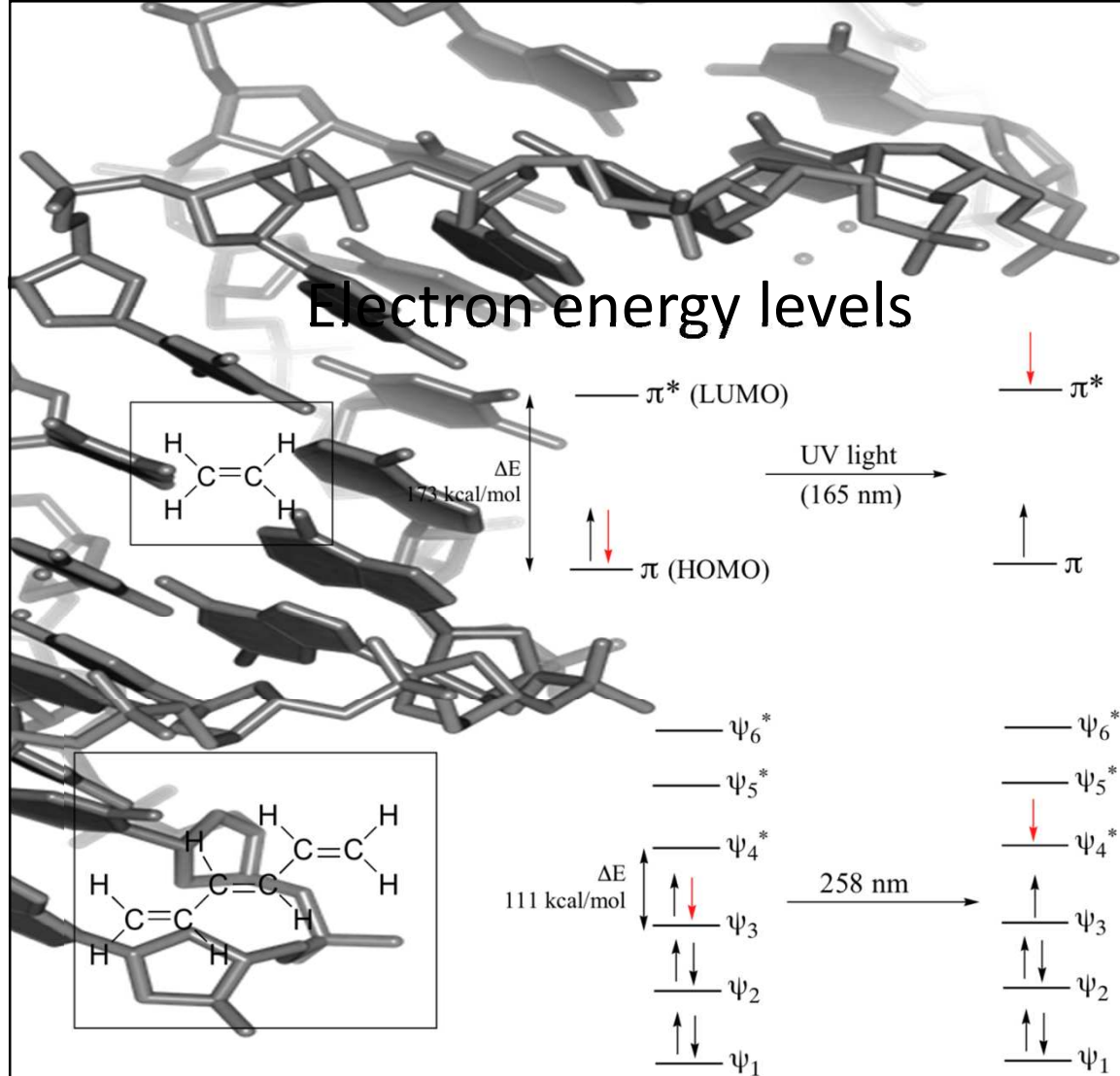
Position of absorption and  
emission peaks correspond  
to differences in  $E$  between  
states.

# Phenomena X EM spectral regions

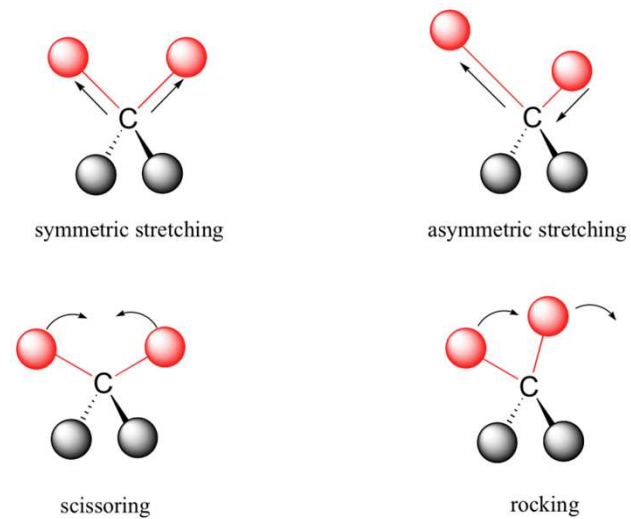
Phenomenon	Spectral region	Wavelength
Nuclear spin orientation in mag. fields	Gamma	0.1 nm
Inner electron transitions	X-ray	0.01 - 1.0 nm
Ionisation	UV	0 - 200 nm
Valency electrons	near UV / VIS	200 - 800 nm
Molecular vibrations	near IR / IR	0.8 - 25 $\mu\text{m}$
Rotation and electron spin orientation in mag. fields	Microwaves	400 $\mu\text{m}$ – 30 cm
Nuclear spin orientation in mag. fields	Radiowaves	> 100 cm

## OPTICAL SPECTROSCOPY

# Electron energy levels

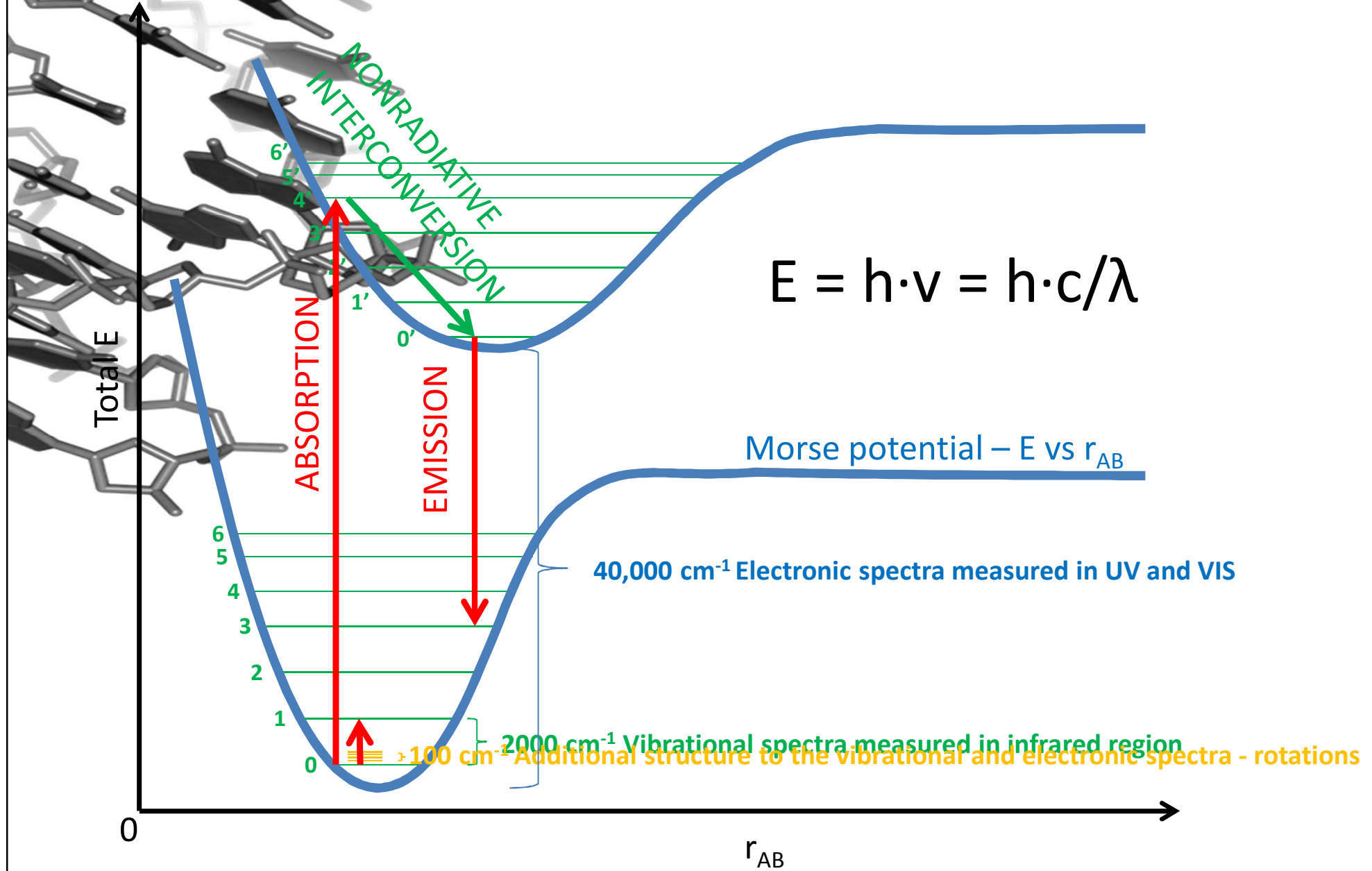


# Molecular vibrations



# Transitions

SPECTROSCOPY MEASURES TRANSITION BETWEEN ENERGY STATES OF THE MOLECULE



# Background – Franck-Condon principle

- Transition to an excited electronic state can be to any of the vibrational level
- Vibrational transitions are very slow, compared to electronic transitions
- Certain vertical transitions corresponding to no nuclear displacement during an electronic transition have the highest probability (**Franck-Condon principle**)
- Absorption band has the vibronic structure - one E0-E1 transition is a superposition of several transitions  $v_0$ - $v_n'$  characterized by different energy and probability (intensity of the peak)

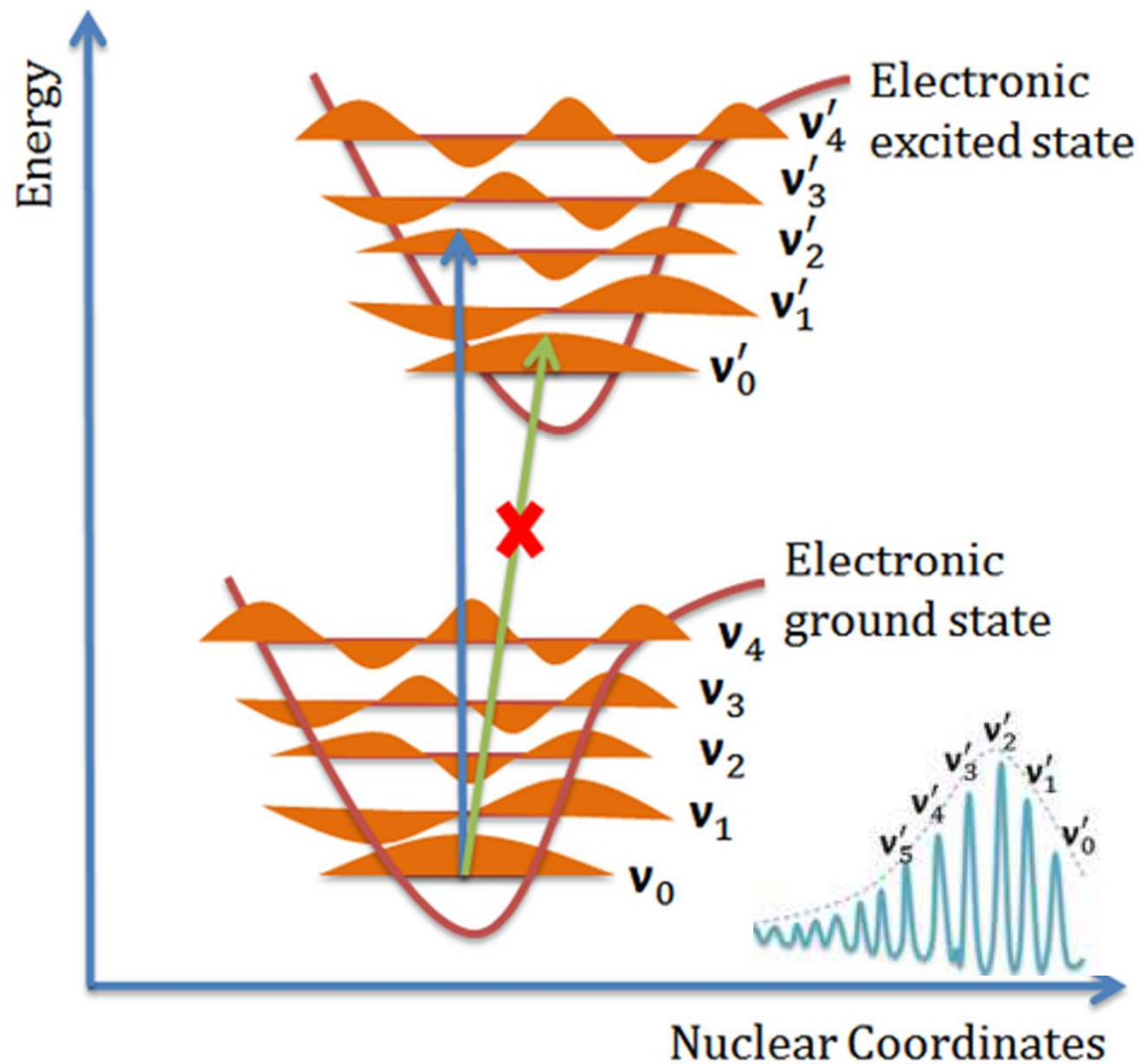
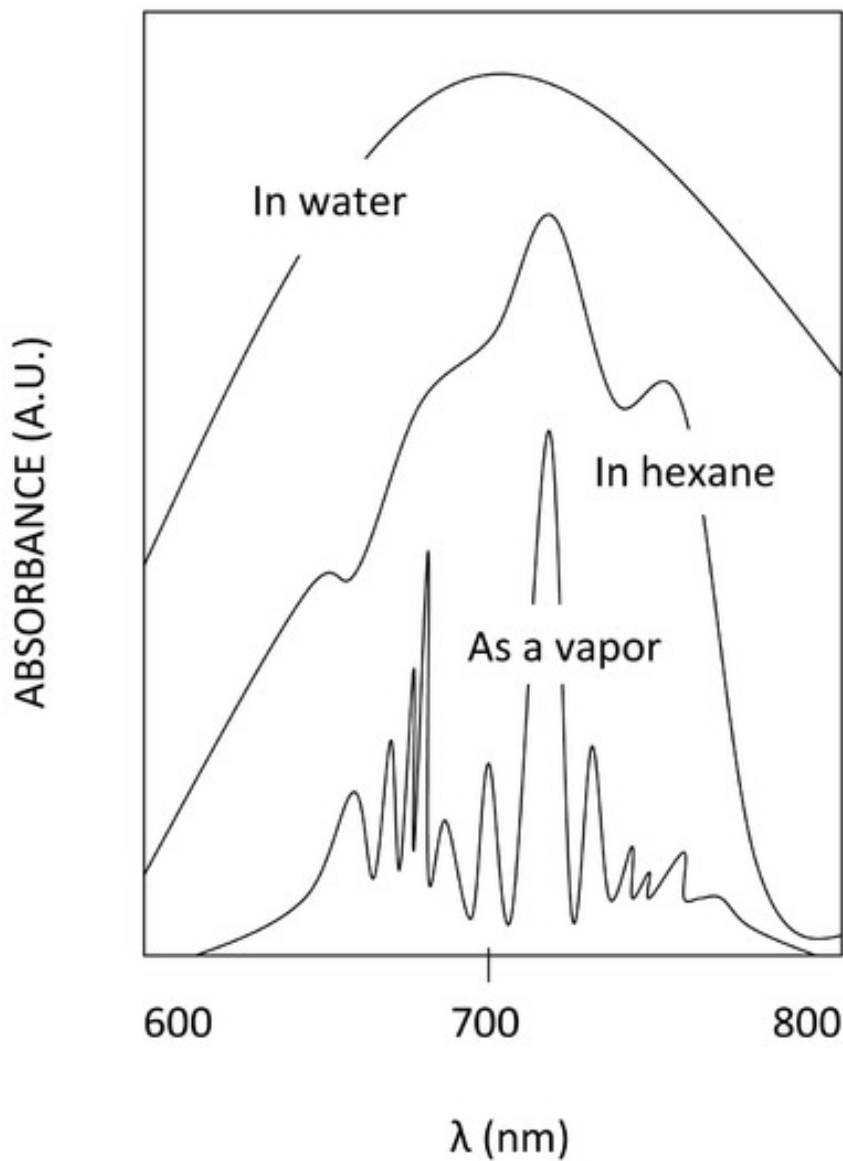
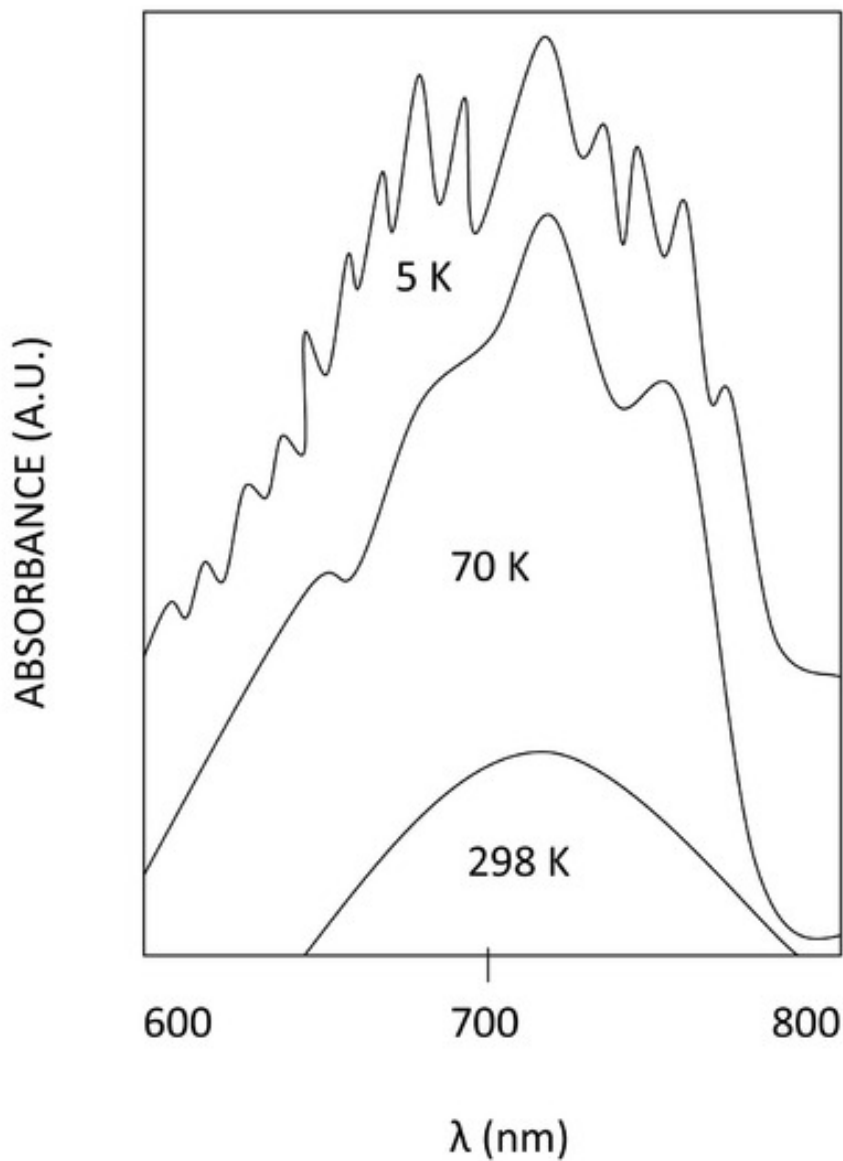


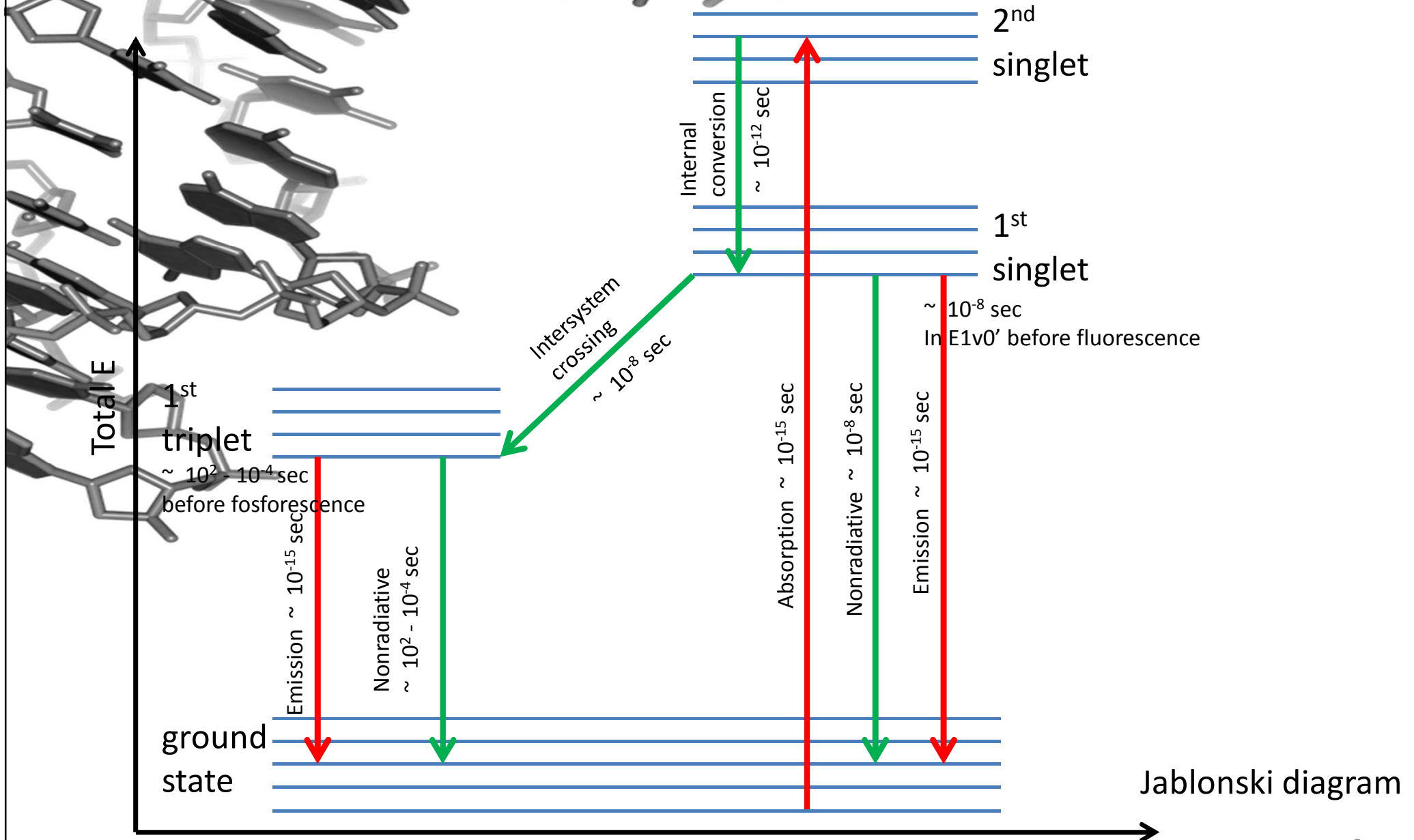
Fig. 2 Franck-Condon energy diagram

# Vibronic structure of absorption spectra





# Transition times



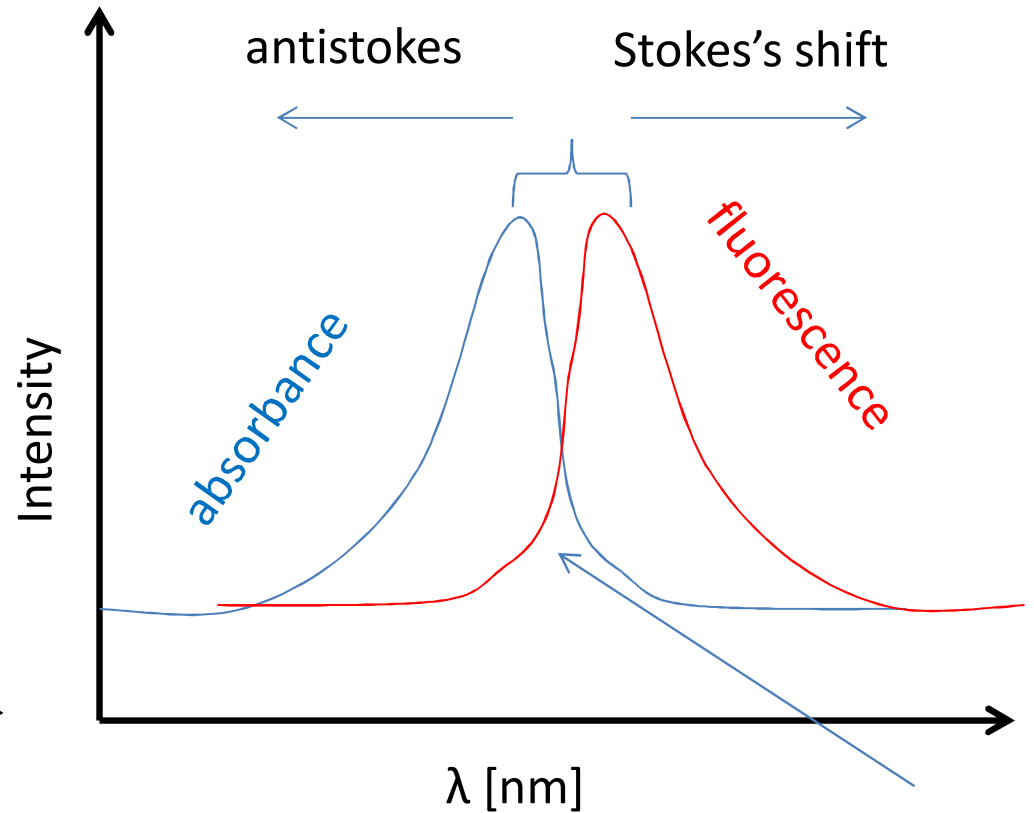
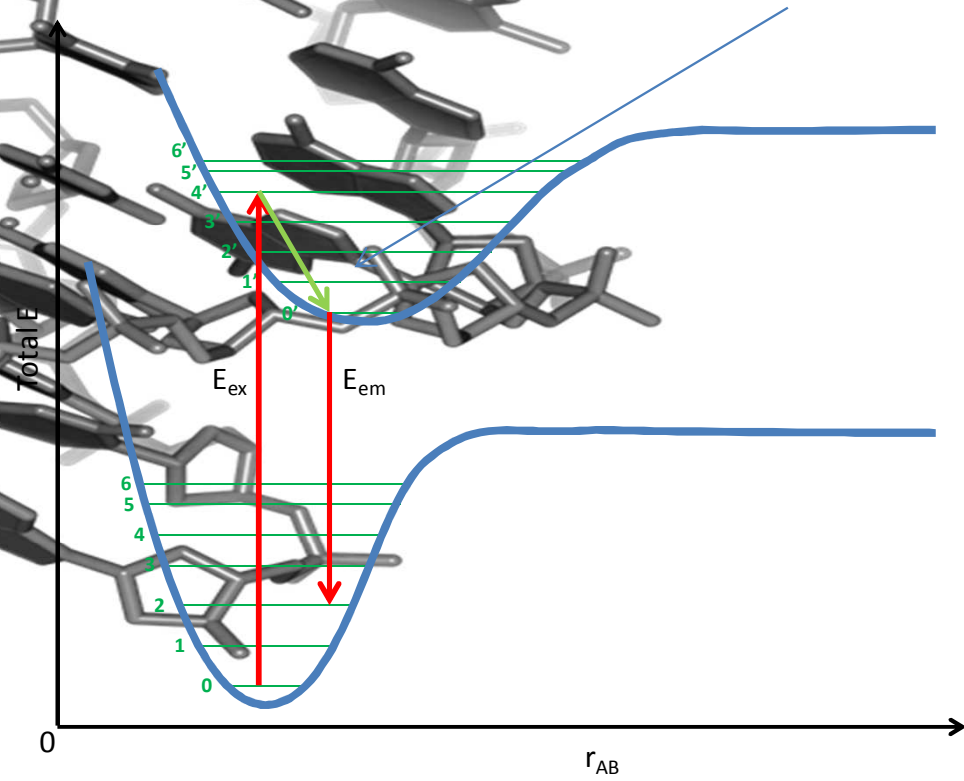


## Background – Kasha's rule

- Kasha's rule: photon emission occurs only from the lowest excited level
- As a consequence, the emission wavelength is independent of the excitation wavelength
- Few exceptions from Kasha's rule
- Kasha's rule + Franck-Condon principle stands behind the symmetry of absorption and fluorescence spectra ( $E_0v_0$  to  $E_1v_n = E_1v_0$ , to  $E_0v_{n'}$ )

# Background - Stokes and antistokes shift

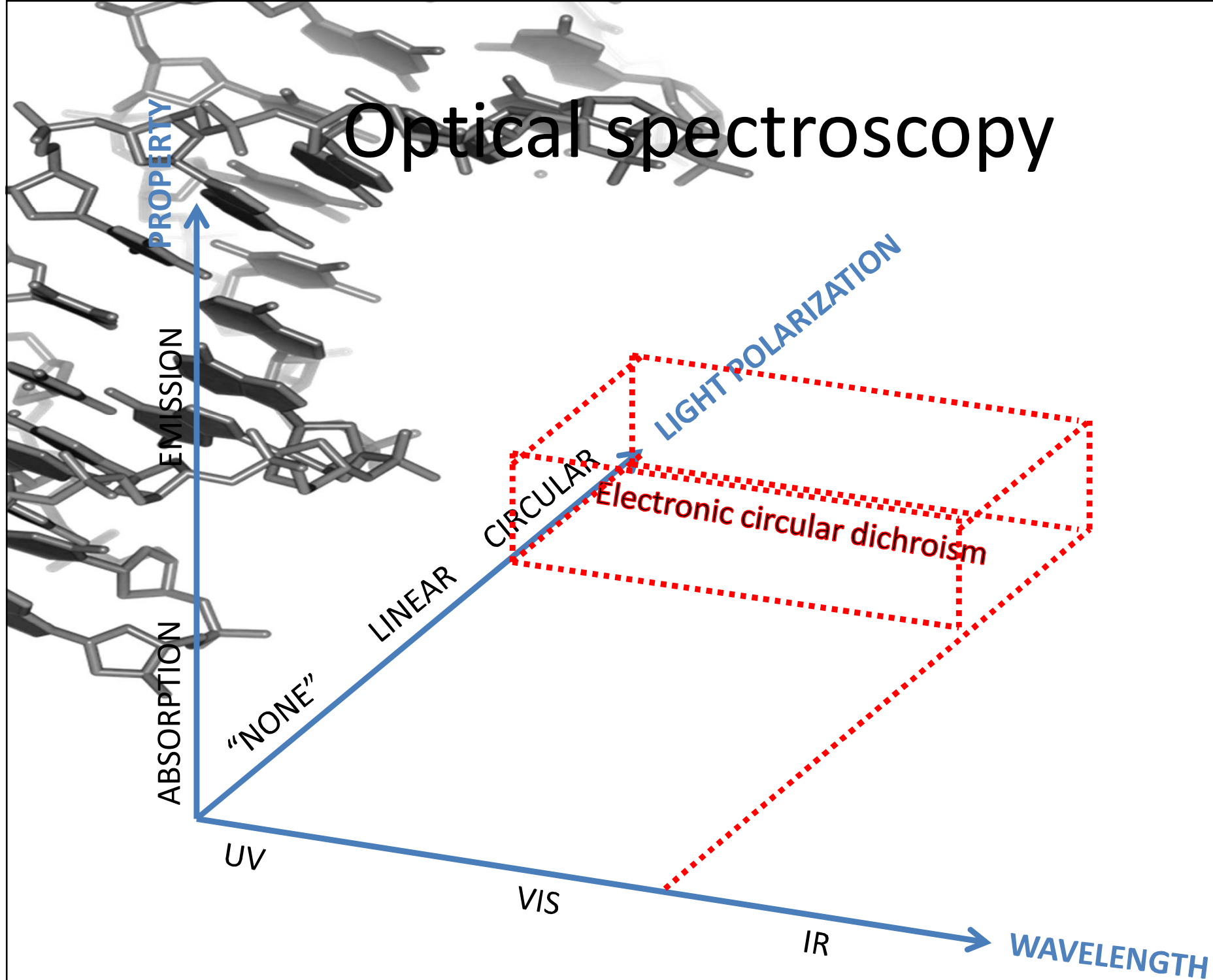
KASHA'S RULE



SYMETRY

$$E_{ex} > E_{em} \Rightarrow \nu_{ex} > \nu_{em} \Rightarrow \lambda_{ex} < \lambda_{em}$$

# Optical spectroscopy





# Type of spectroscopy

These types require different instrumentation and are used for different purposes.

## Steady-state

- continuous excitation
- weak intensities of excitation light
- highly populated ground state

## Time-resolved experiment

- short excitation pulse (fs,ps)
- higher intensities of excitation light (laser)
- significantly populated excited states

“pump” – light for excitation

“probe” – light for measurement

Either the same source or different.



# UV absorption spectroscopy

- All molecules absorb in UV – all atoms have electrons + UV has enough E to excite outer-shell electrons to higher energy orbitals
- bottom  $\lambda$  limit – buffer absorption x O<sub>2</sub> (<160 nm) absorption  
– vacuum UV – synchrotron up to 100 nm
- Absorption bands are broad – vibronic structure + solution effects
- **Chromophore** – part of the molecule that strongly absorbs in the desired region (UV/Vis)



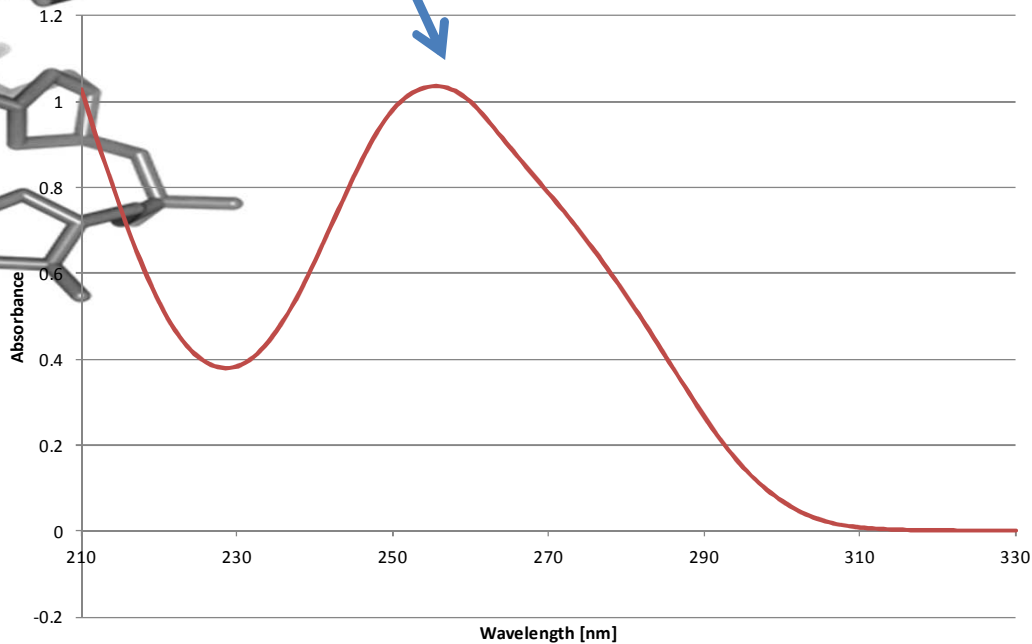
# UV absorption spectroscopy

- Determination of concentration of nucleic acids – Beer-Lambert law
- Determination of conformation of DNA – Thermal (TDS) and Isothermal (IDS) Differential Spectra
- Measurement of renaturation and denaturation processes – determining of thermodynamic parameters using van't Hoff equation
- Following interactions of nucleic acids with ligands
- Protonation of bases

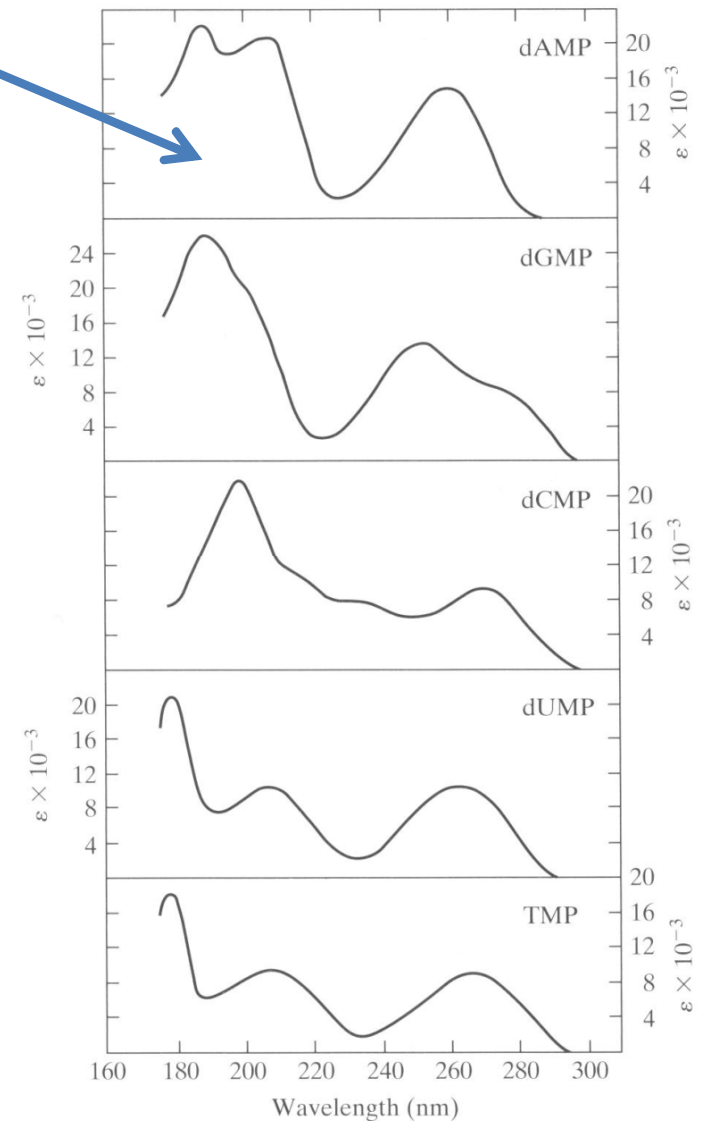
# DNA absorption spectrum

Spectra of particular nucleotides depend on transition dipole moments of the bases.

Peak around 260 nm due to a conjugated  $\pi$ -bonding system (bases).



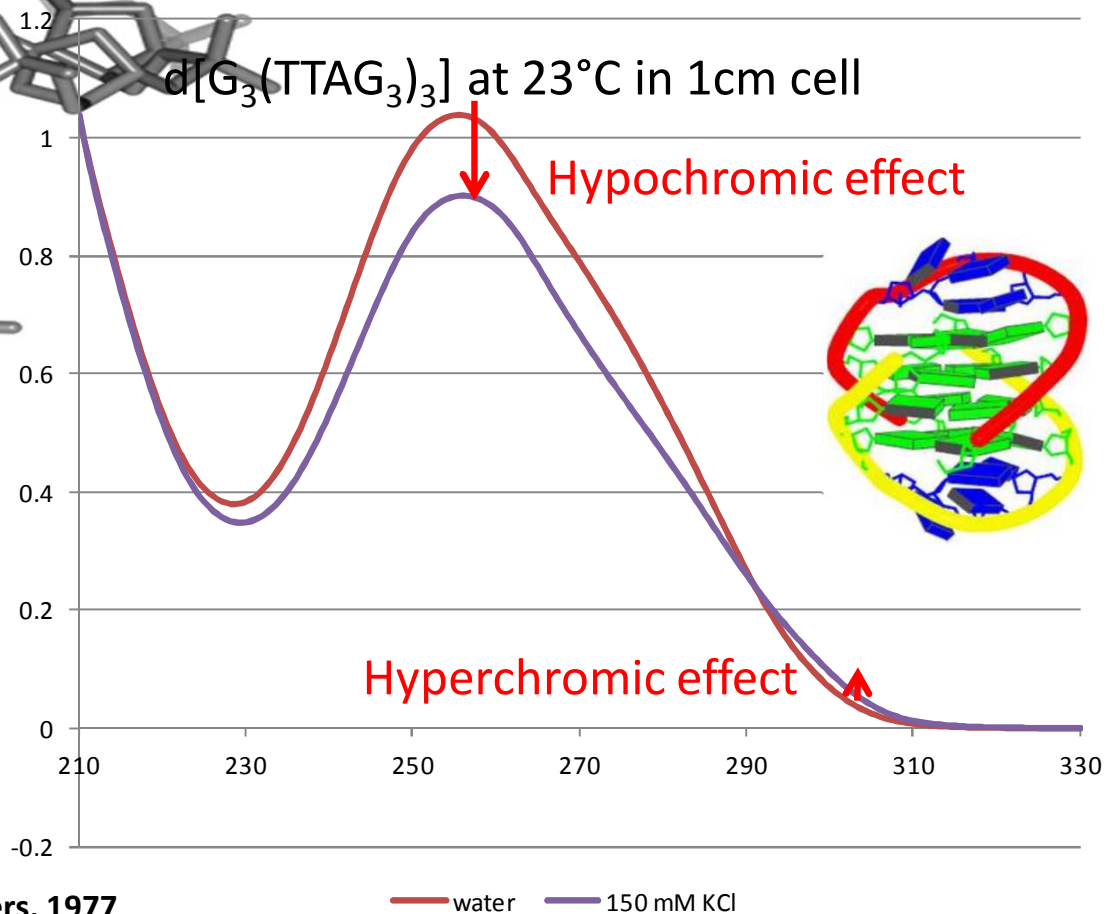
Final spectrum of unstructured DNA depends on primary sequence.





# Effect of structure

- final NA spectrum is based on contributions of individual monomers in primary sequence + contributions of their interactions
- spectrum different for structured and non-structured NA (hypochromism around 260 nm after folding)



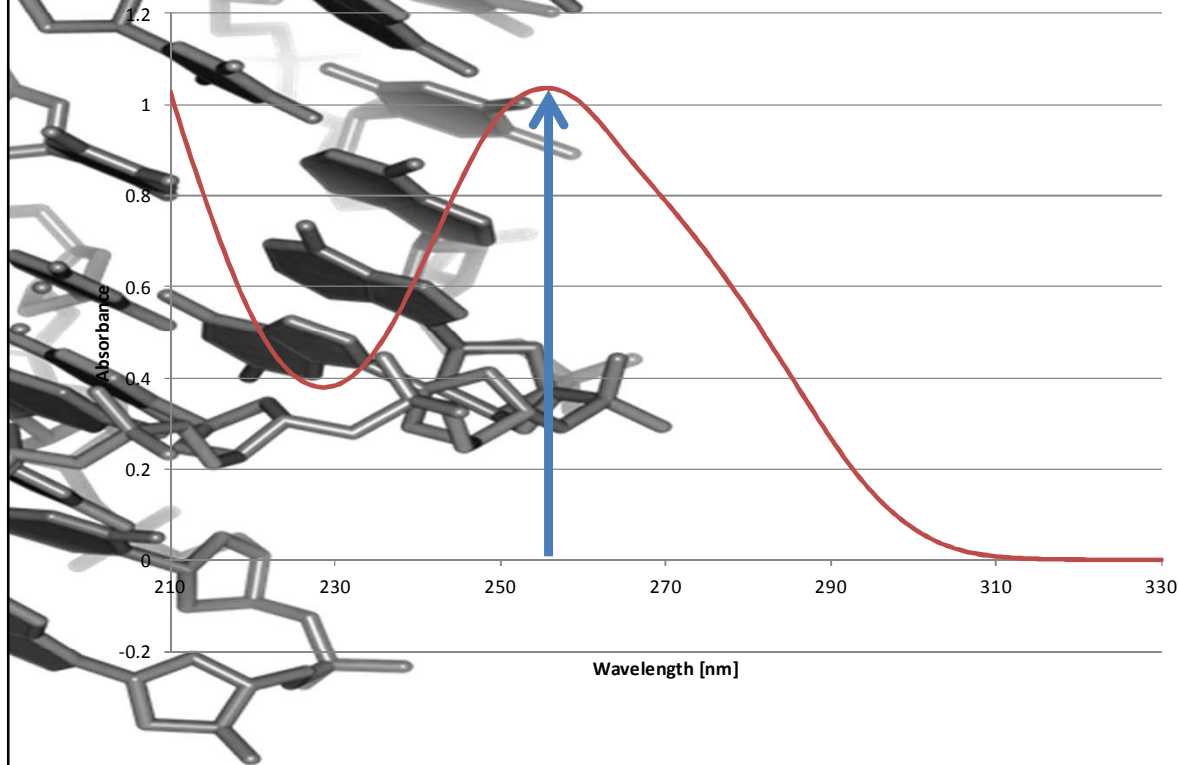
# UV absorption – NA concentration

Beer-Lambert law  
 $A = c \cdot \epsilon \cdot l = \log_{10} I_0 / I$

$$I = I_0 \cdot 10^{-c \cdot \epsilon \cdot l}$$

$I_0$  – incident light

$I$  – output light



Light intensity decreases exponentially when passing through sample thus absorbance (as log) increases linearly – 2x sample concentration or pathlength = 2x absorbance but 10x less light  
Optimal absorbance 0.6-0.8

# Molar absorption coefficient - $\epsilon$

$$A = c \cdot \epsilon \cdot l$$

$\epsilon$  – molar absorption coefficient [ $M^{-1} \cdot cm^{-1}$ ]

- specific for each NA primary sequence
- can be either:
  - calculated – 2\*sum of  $\epsilon$  of dimers minus sum of  $\epsilon$  of monomers except the two terminal ones (Gray et al., 1995, Methods Enzymol)

$$\epsilon = \left( \sum_1^{n-1} 2 * \epsilon_{dinucl.} - \sum_2^{n-1} \epsilon_{mononucl.} \right)$$

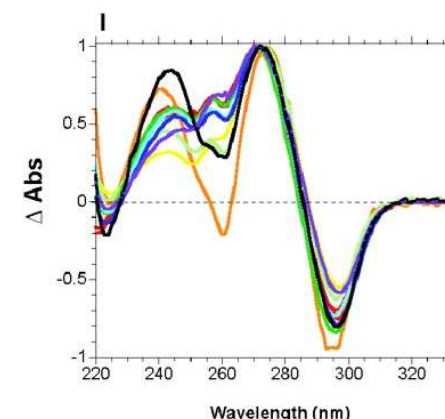
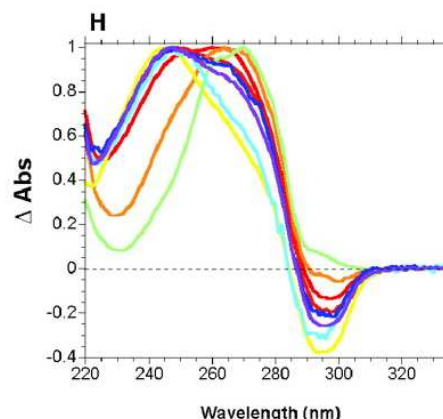
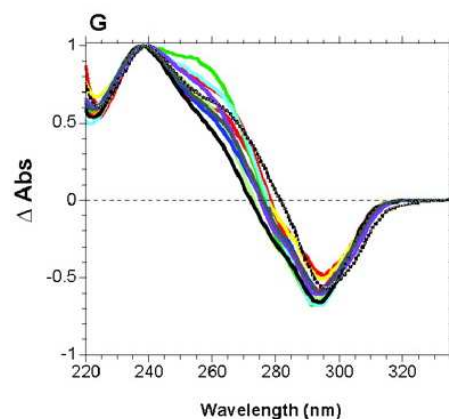
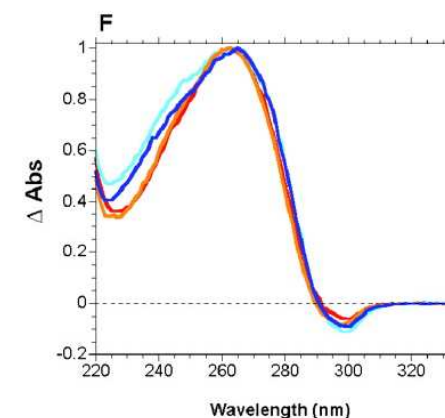
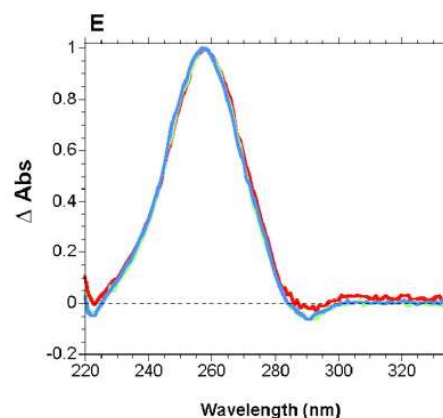
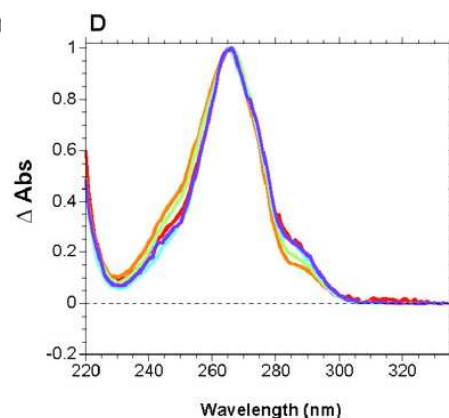
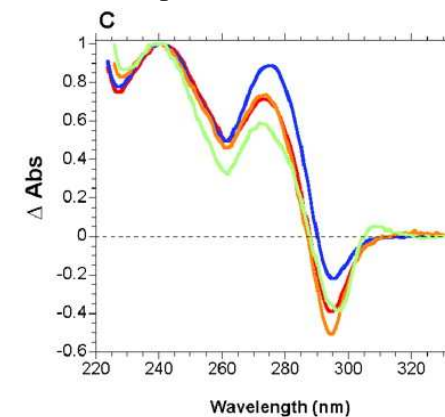
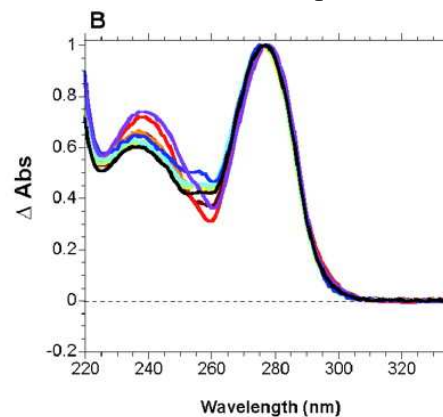
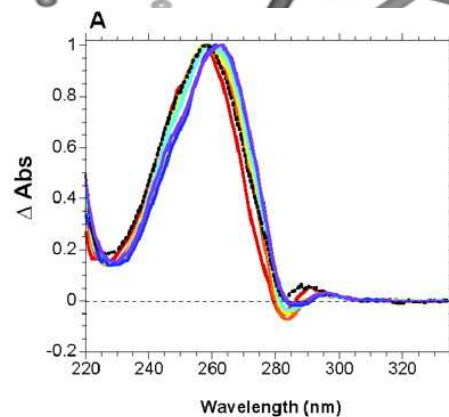
- analytically determined – amount of phosphorus vs absorbance
- usually calculated by DNA provider
- <http://eu.idtdna.com/calc/analyzer>

TABLE I  
MOLAR EXTINCTION COEFFICIENTS OF NUCLEOTIDES AND  
DINUCLEOSIDE PHOSPHATES<sup>a,b,c</sup>

Phosphates	$\epsilon$ (260), $M^{-1} cm^{-1}$	
	RNA	DNA
Monomer		
Ap	15,340	15,340
Cp	7,600	7,600
Gp	12,160	12,160
Up (dT)	10,210	8,700
Dimer		
ApA	13,650	13,650
ApC	10,670	10,670
ApG	12,790	12,790
ApU (ApT)	12,140	11,420
CpA	10,670	10,670
CpC	7,520	7,520
CpG	9,390	9,390
CpU (CpT)	8,370	7,660
GpA	12,920	12,920
GpC	9,190	9,190
GpG	11,430	11,430
GpU (GpT)	10,960	10,220
UpA (TpA)	12,520	11,780
UpC (TpC)	8,900	8,150
UpG (TpG)	10,400	9,700
UpU (TpT)	10,110	8,610

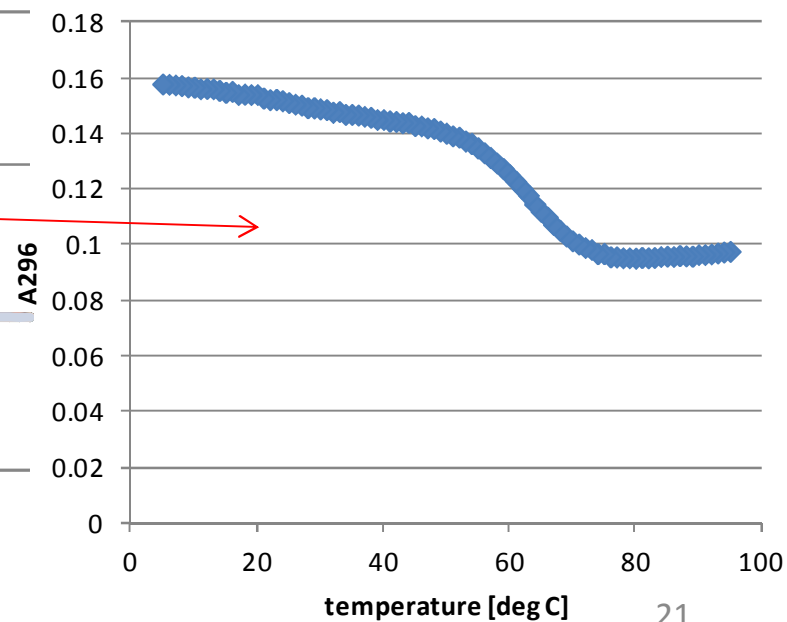
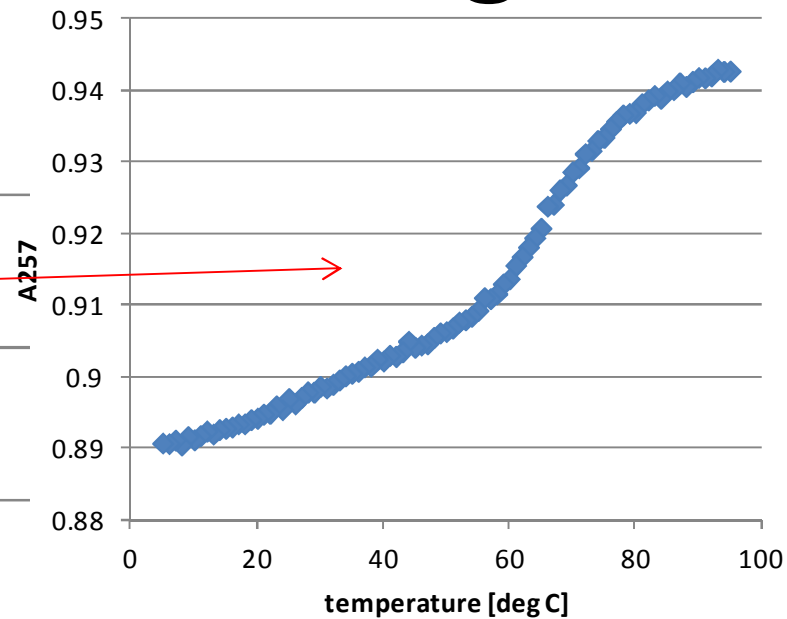
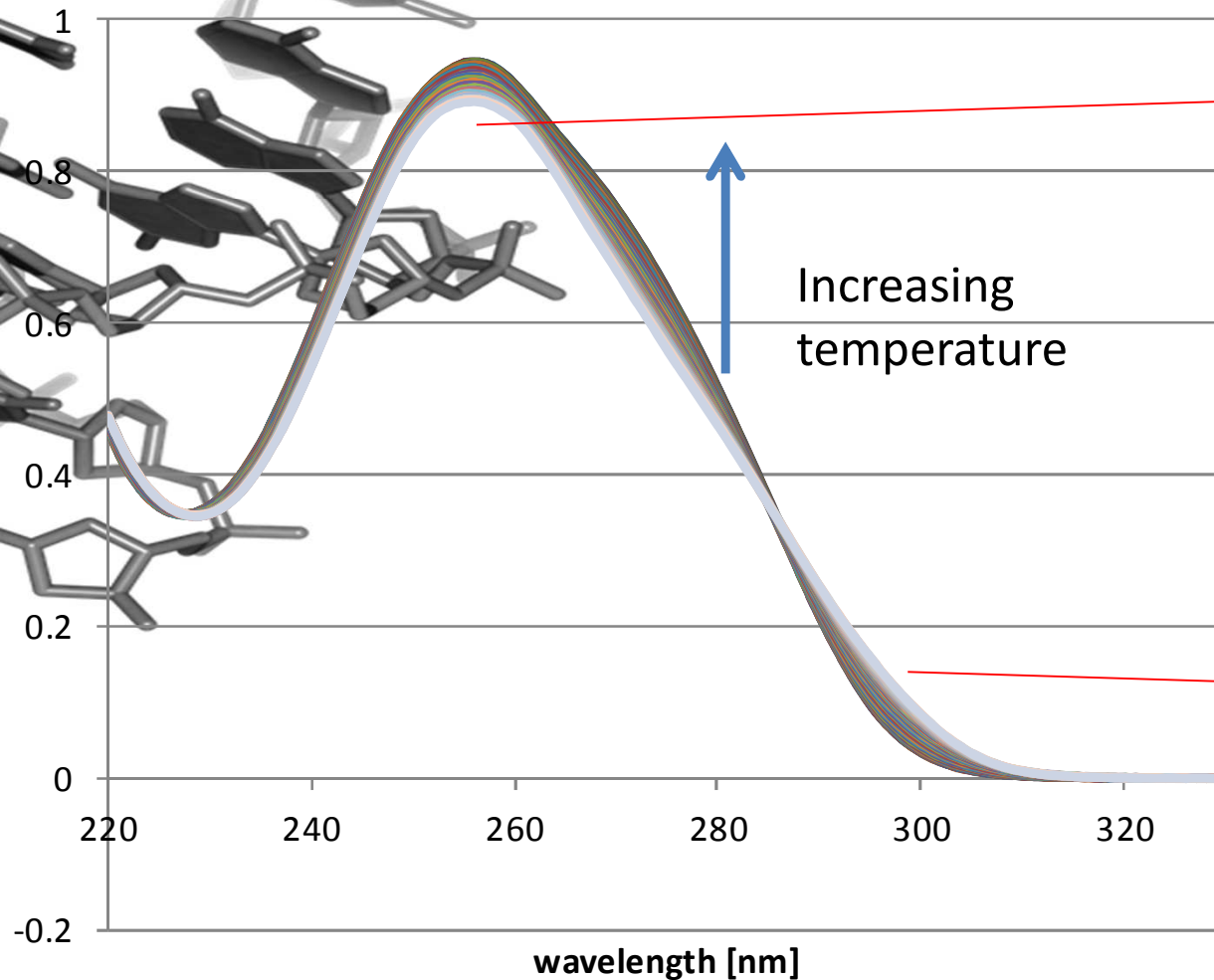
# UV Absorbance – TDS (or IDS)

Normalized differential absorbance signatures: (A) DNA self-complementary duplexes, 100% AT; (B) DNA self-complementary duplexes 100% GC; (C) Z-DNA; (D) Parallel-stranded DNA; (E) GA DNA duplexes; (F) Hoogsteen DNA duplexes; (G) i-DNA; (H) Pyrimidine triplexes; (I) DNA G-quadruplexes in Na<sup>+</sup>.



# UV Absorbance – NA melting

Guanine quadruplex  $G_3(TTAG_3)_3$  in 150 mM Na



# Thermodynamic parameters - Van't Hoff

$$\Delta G^\circ = \Delta H^\circ - T\Delta S^\circ.$$

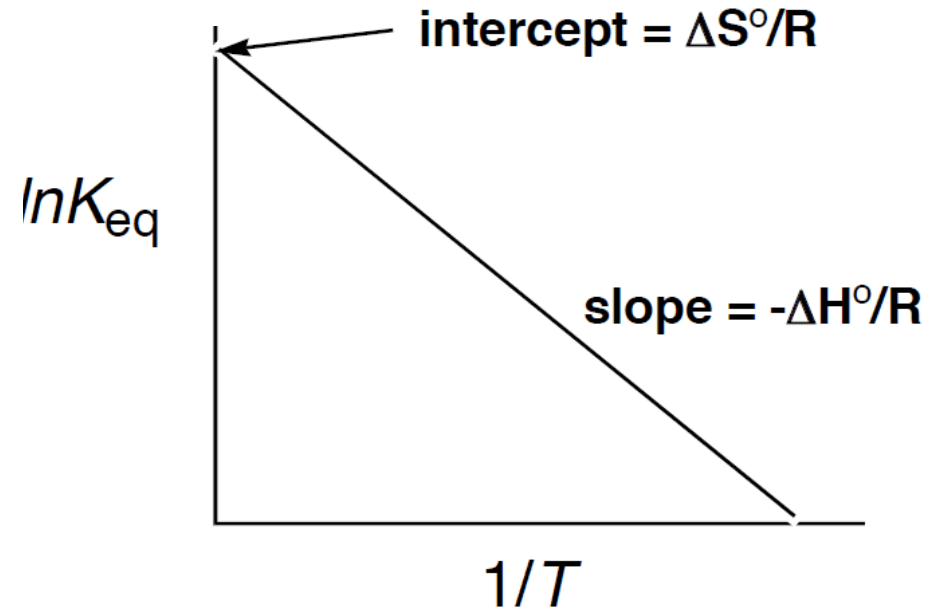
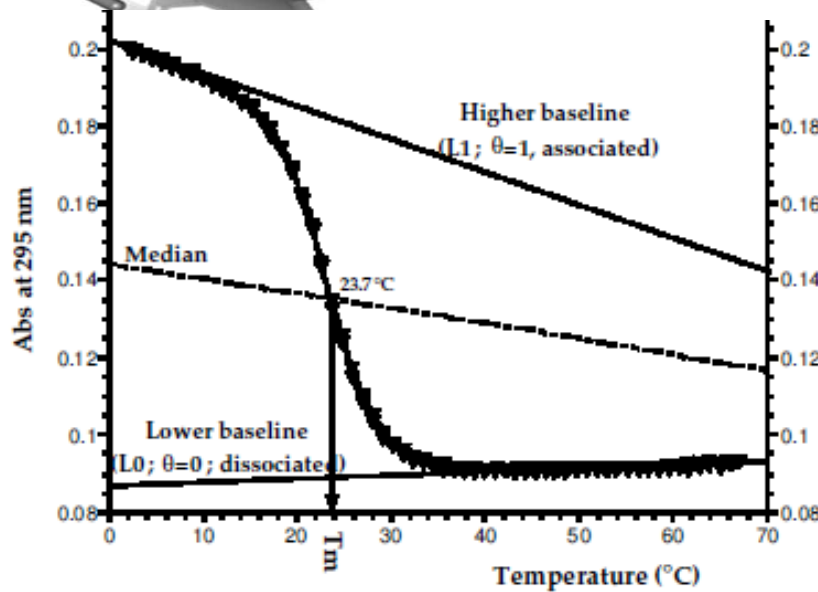
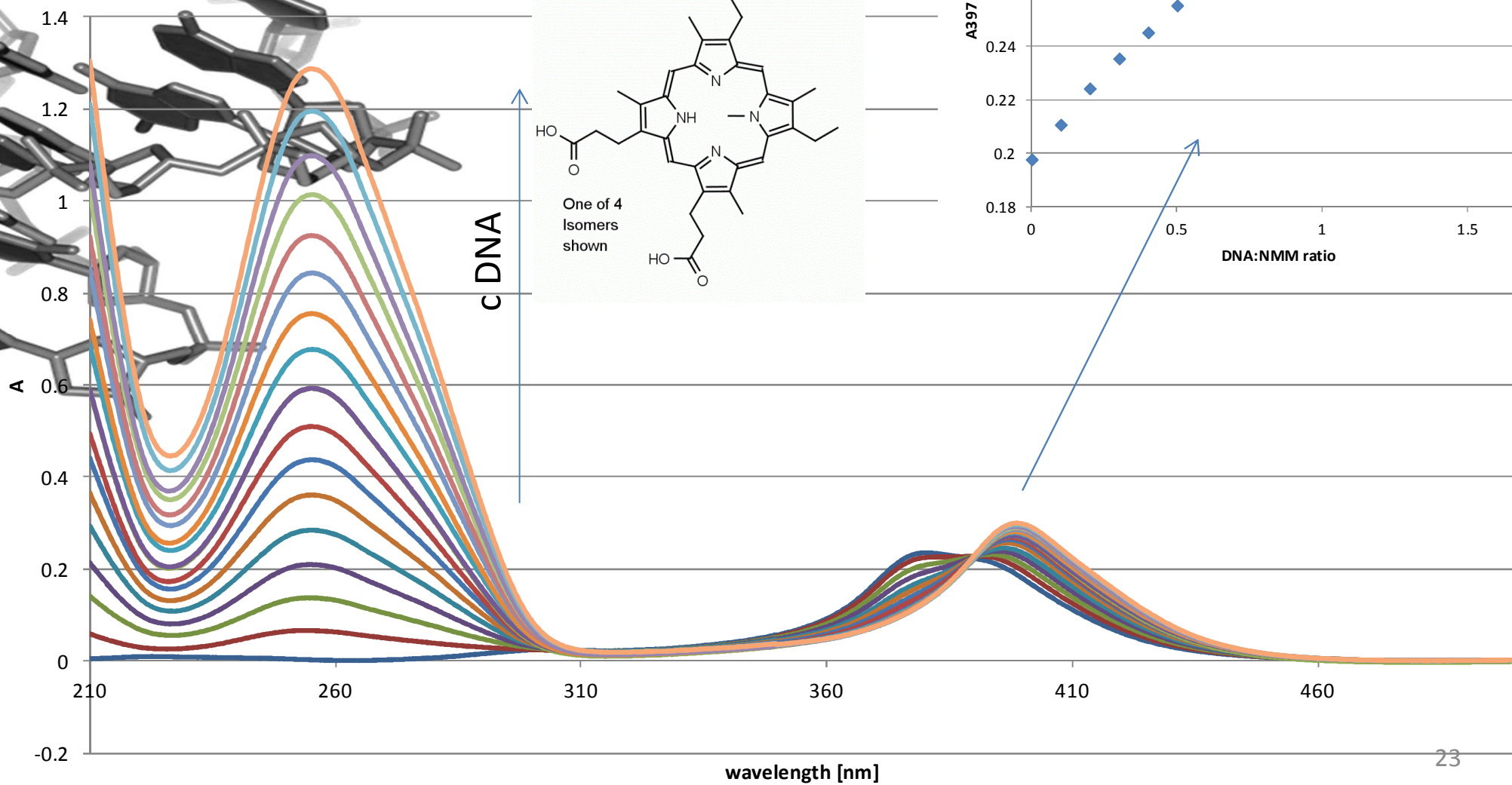


TABLE 2. EXAMPLES OF EQUILIBRIA

Equilibrium	$A \rightleftharpoons C$	$2A \rightleftharpoons C$	$A + B \rightleftharpoons C^{a,b}$
Type	Intramolecular	Bimolecular	Bimolecular
Example	Hairpin	Oligo autocomplementary	2 complementary oligos
Concentration effect	Independent	Dependent	Dependent
Affinity constant $K_a$	$\theta/(1 - \theta)$	$\theta/2 \cdot C_o \cdot (1 - \theta)^2$	$\theta/C_o \cdot (1 - \theta)^2$
$\Delta G^\circ$ at $T_m$	0	$+RT_m \ln(C_o)$	$+RT_m \ln(C_o/2)$
$1/T_m^c$	$\Delta S^\circ/\Delta H^\circ$	$\Delta S^\circ/\Delta H^\circ + R/\Delta H^\circ \cdot \ln C_o$	$(\Delta S^\circ - R \cdot \ln 2)/\Delta H^\circ + R/\Delta H^\circ \cdot \ln C_o$
$\text{Max}^d. d\theta/dT^{-1}$ for $\theta=$	0.5	$\sqrt{2} - 1^c$	$\sqrt{2} - 1^c$

# UV Absorbance – ligand interaction

NMM ligand titrated by guanine quadruplex

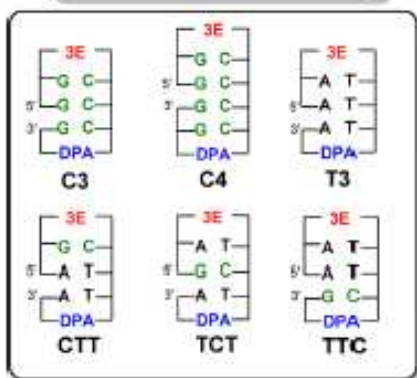
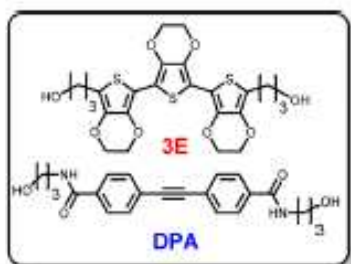
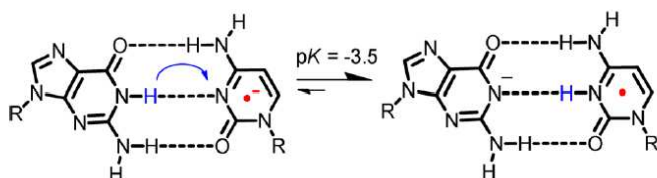


# Time-resolved absorption

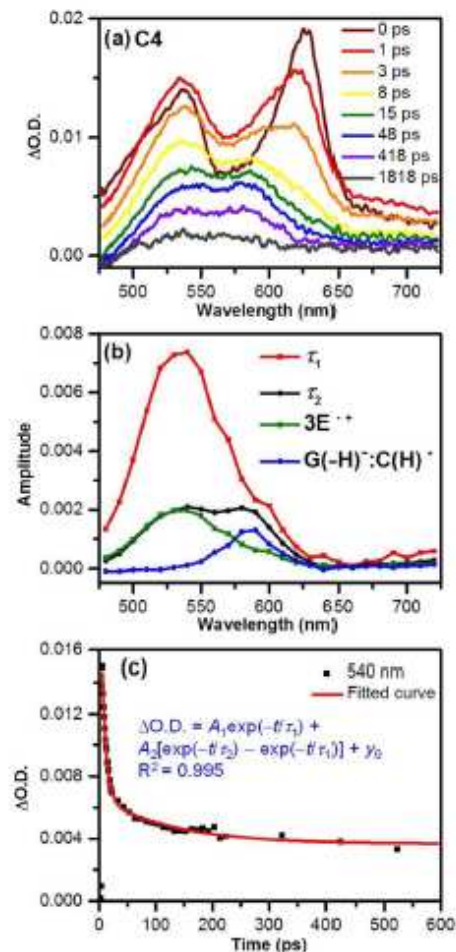
## How Does Guanine–Cytosine Base Pair Affect Excess-Electron Transfer in DNA?

Shih-Hsun Lin, Mamoru Fujitsuka,\* and Tetsuro Majima\*

### Scheme 1. Proposed Proton-Transfer Reaction Pathway for G:C<sup>•-</sup> Base Pair<sup>27</sup>



**Figure 1.** Structures of 3E, DPA, and DNA oligomers (C3, C4, T3, CTT, TCT, and TTC). The gap between the 5' and 3' indicates a missing phosphate linker between two nucleobases in nicked dumbbell structure.

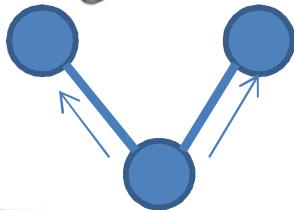


**Figure 4.** (a) Transient absorption spectra during the laser flash photolysis of C4 upon excitation with 400 nm femtosecond laser pulse. (b) Species-associated spectra obtained by global fitting using a double exponential function for C4 (red:  $\tau_1$  ( $3E^{\bullet+} - G:C^{\bullet-}$ ), black:  $\tau_2$  ( $3E^{\bullet+} - G(-H)^{\bullet-}:C(H)^{\bullet-}$ ) and normalized by intensity at 540 nm (green:  $3E^{\bullet+}$ , blue:  $G(-H)^{\bullet-}:C(H)^{\bullet-}$ ). (c) The kinetic traces of global fitting for C4 at 540 nm.  $\tau_1$  and  $\tau_2$  correspond to  $(k_{CR1} + k_{PT})^{-1}$  and  $k_{CR2}^{-1}$ , respectively. Red curve is fitted curve.

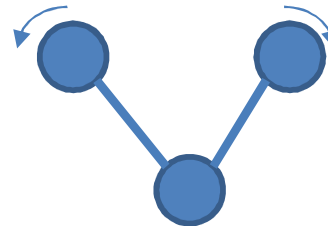


# IR absorption

- Measures the energies of vibration of atomic nuclei in the molecule
- Each molecule has  $3n-6$  internal degrees of freedom ( $n$ =number of atoms in molecule)
- specific absorption bands for various chemical groups



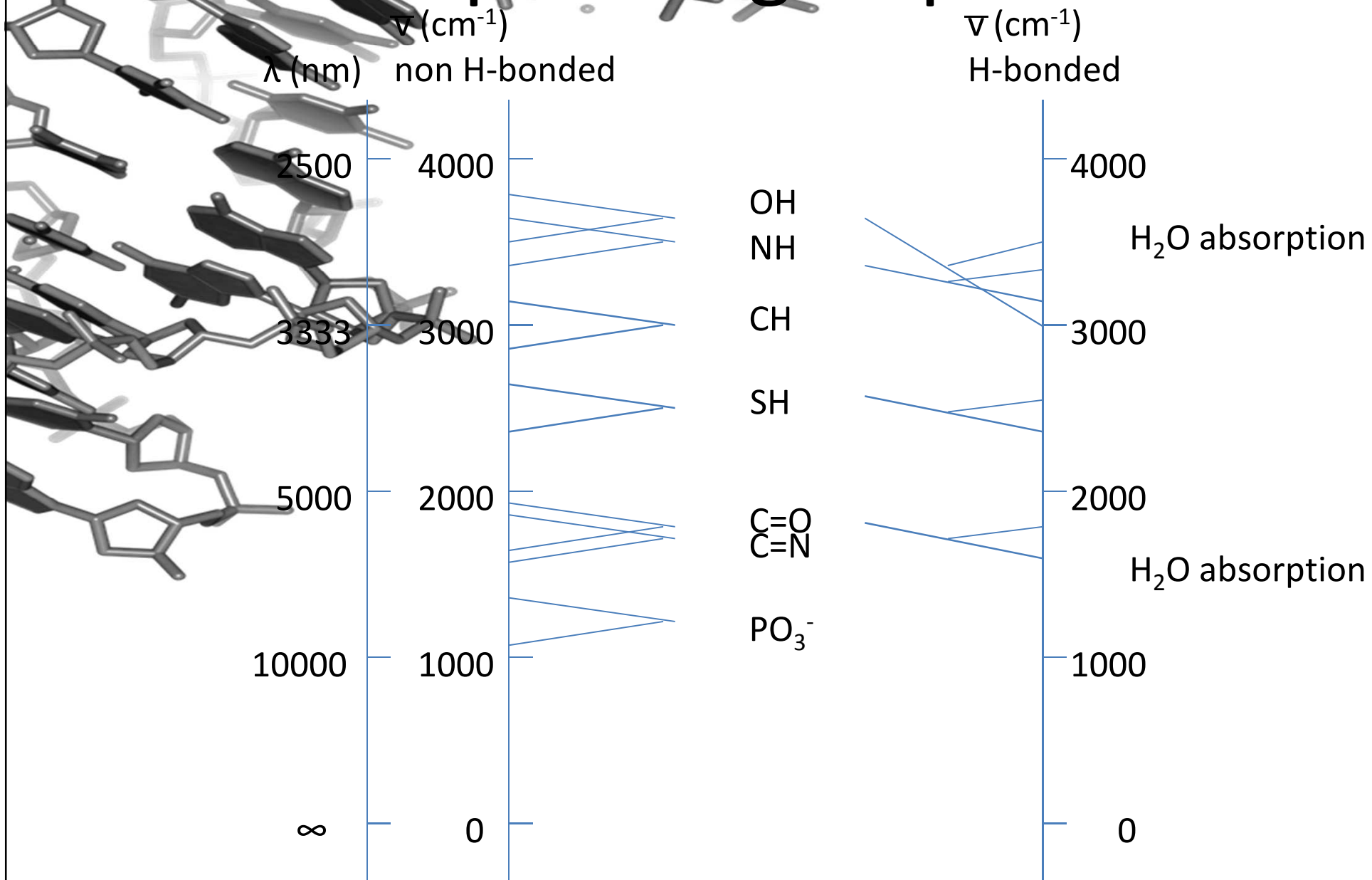
stretching



In-plane bending

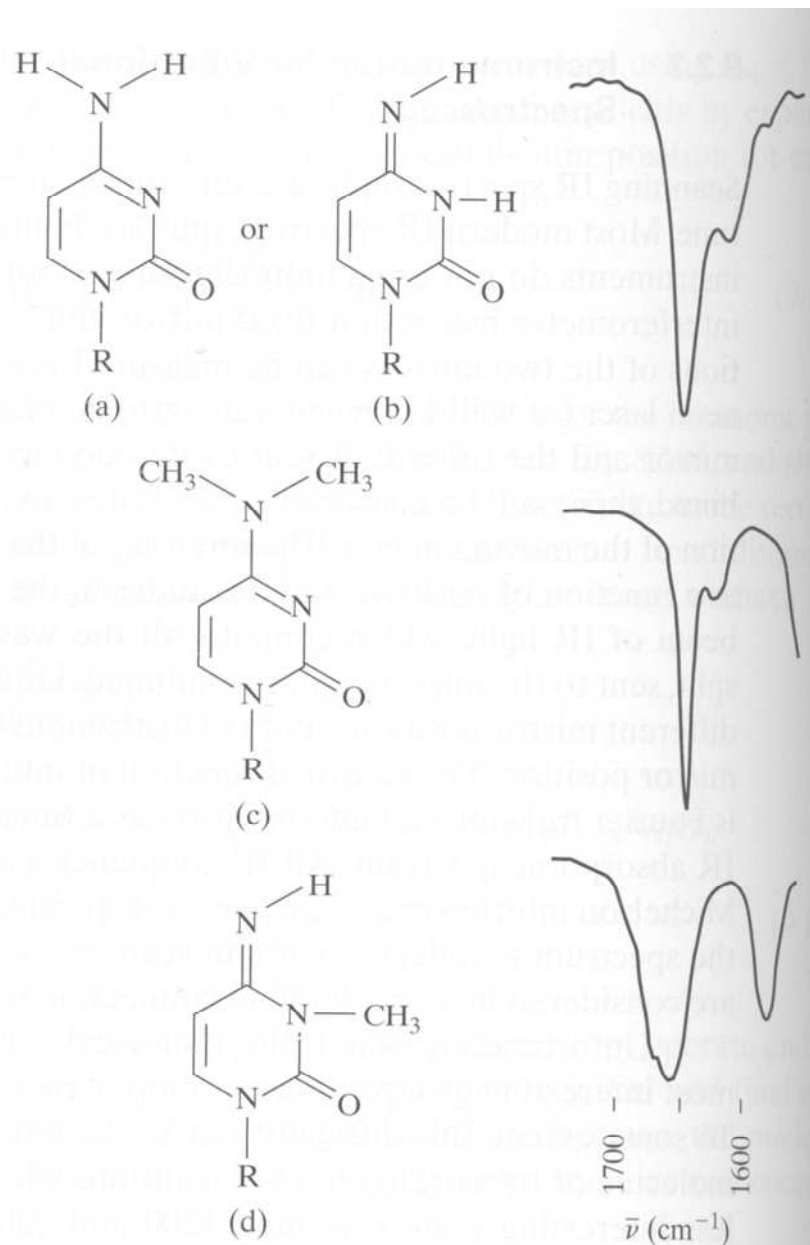
- modern IR spectrophotometers are Fourier transform instruments – Michelson interferometer + FT transformation of intensity to frequency – all frequencies taken simultaneously
- water absorption in interesting IR regions –  $D_2O$  (peak in other regions, films)

# IR absorption – group vibrations



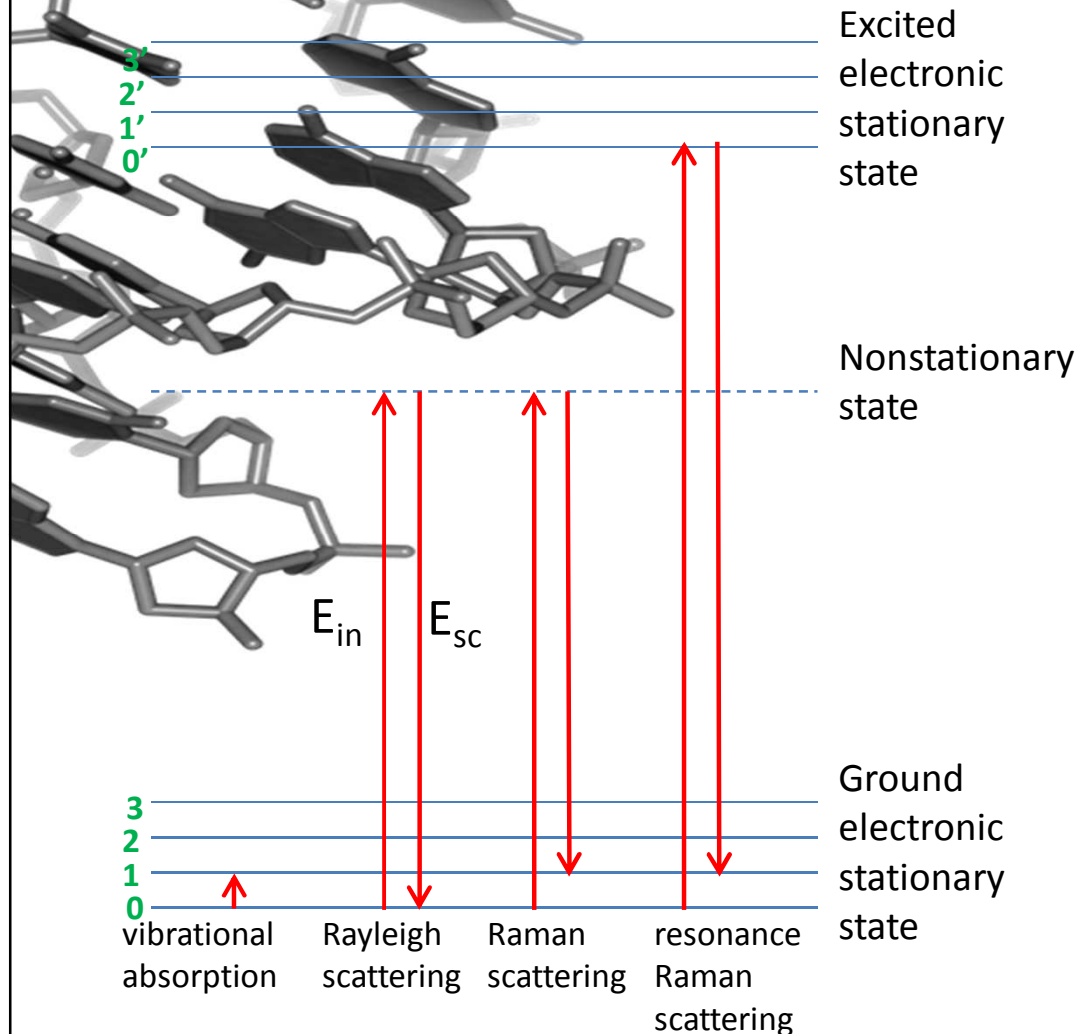
# IR absorption – Miles experiment

IR spectra in the  $1750$  to  $1550\text{ cm}^{-1}$  region for two nontautomerizing methyl derivatives (c) and (d), and cytidine, now known to be in the first tautomeric form shown (a).



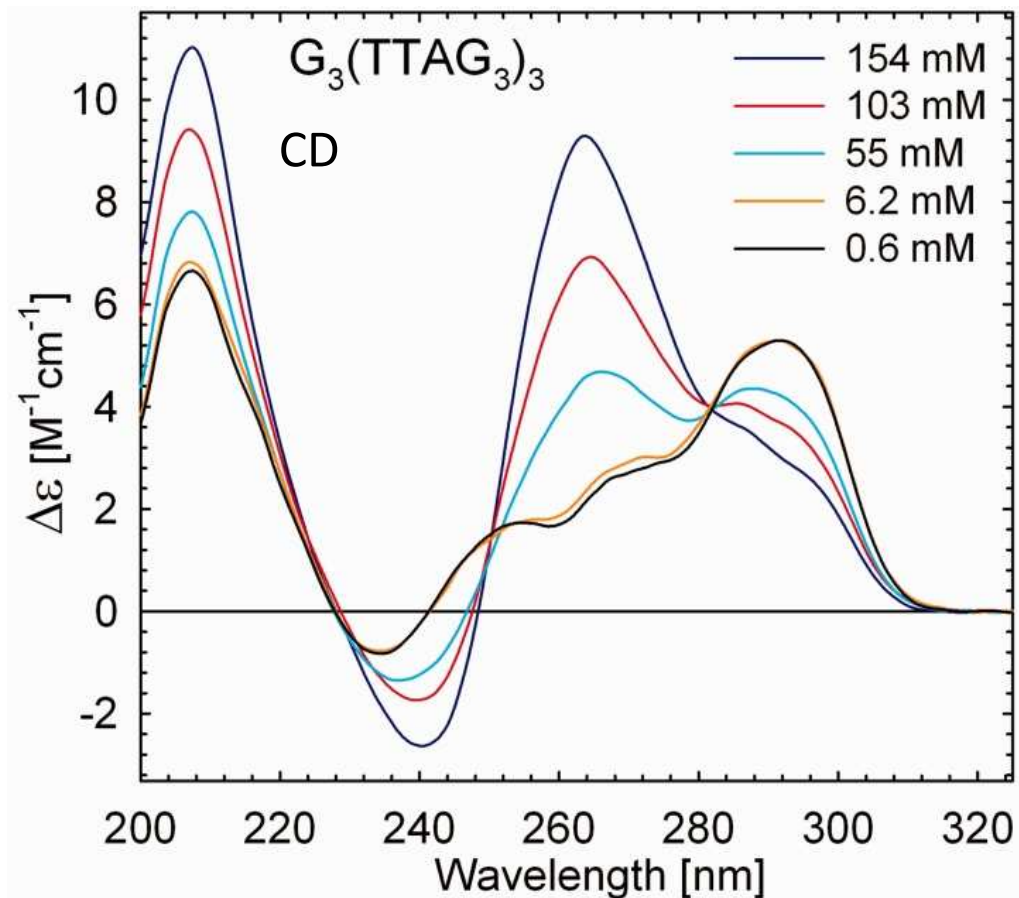
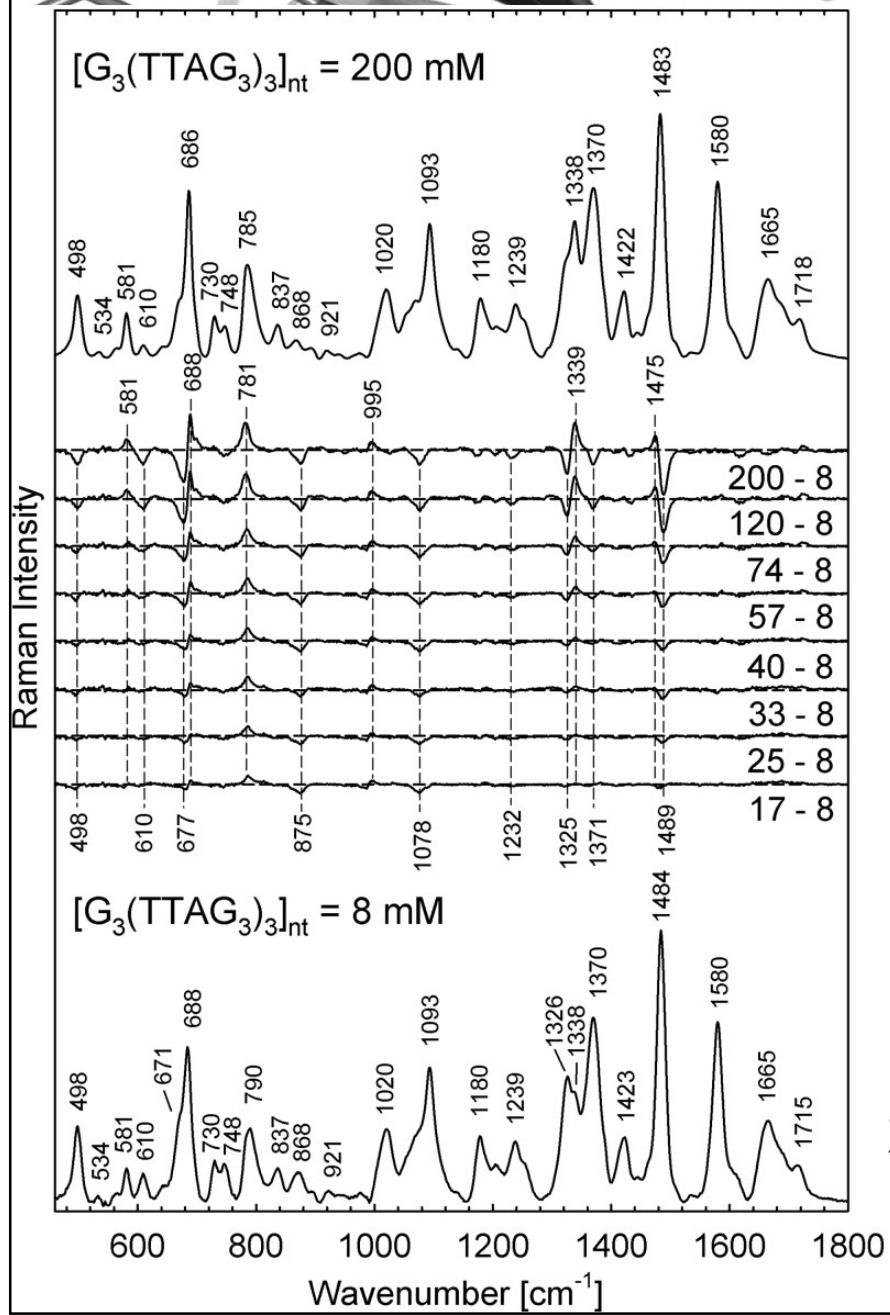
# Raman spectroscopy

Band position:  $\nu_{01} = (E_{in} - E_{sc})/hc$



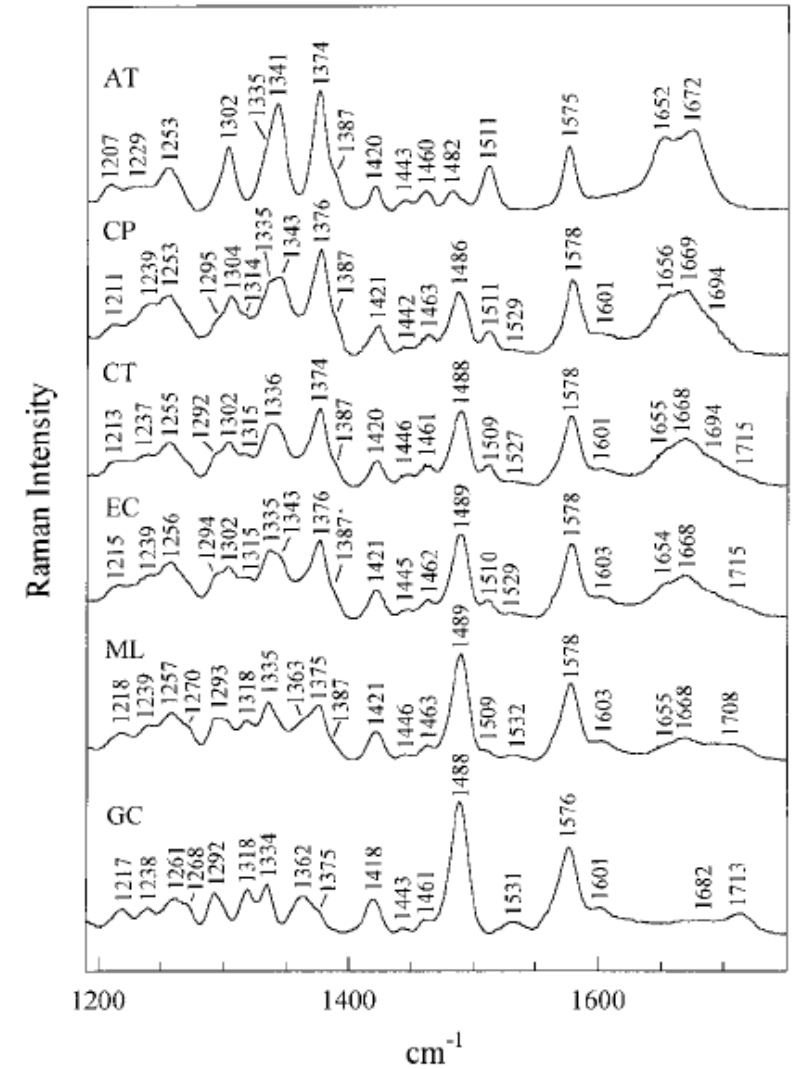
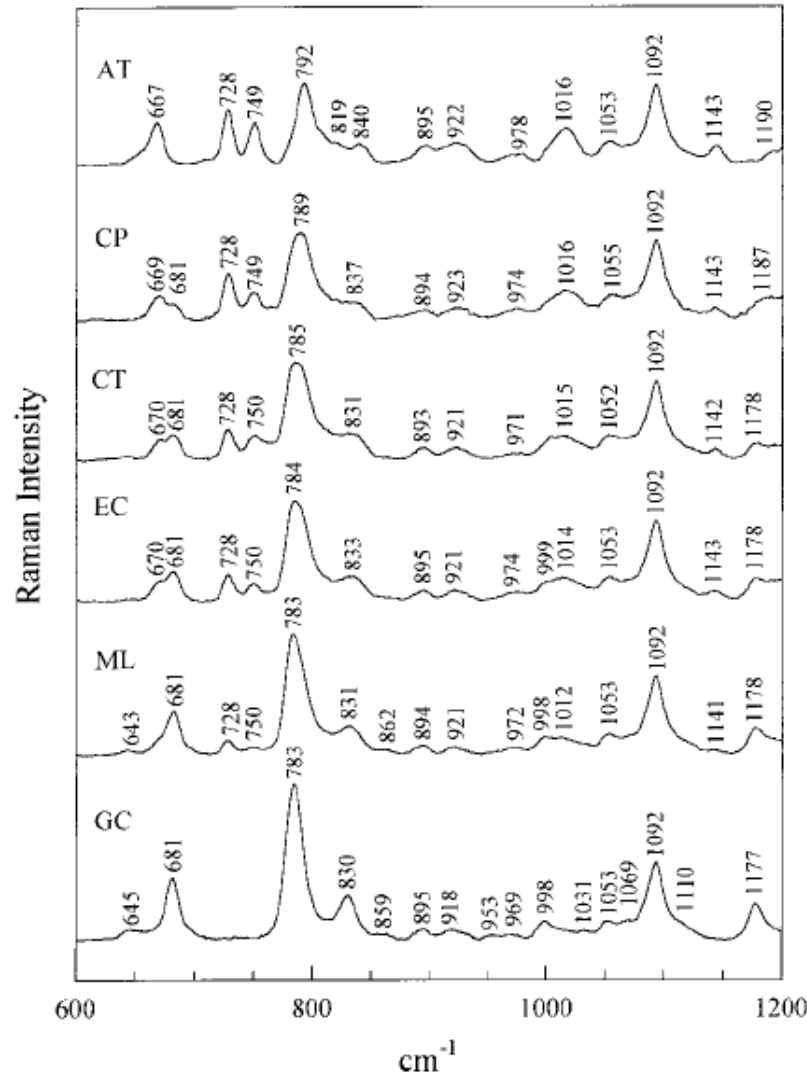
- when used light with  $E < E_0 - E_1$  – scattering
- in most cases  $E_{in} = E_{sc}$  – Rayleigh scattering
- sometimes  $E_{in} \neq E_{sc}$  – Raman scattering
  - $E_{in} > E_{sc}$  – Stokes
  - $E_{in} < E_{sc}$  – antistokes
- Raman photon incidence around  $10^{-8}$
- Raman band position:  $\nu_{01} = (E_{in} - E_{sc})/hc$
- complementary to vibrational absorption – the same transition (0-1)
  - Raman – visible photon
  - vibrational – IR photon
  - some vib. transitions detected differently
- nonstationary states are not quantized => any UV/Vis source may be used
- practically lasers – intense monochromatic light
- scattered light split by monochromator

# Raman spectroscopy



Raman spectra of  $G_3(TTAG_3)_3$  in 200 mM  $\text{K}^+$  (30 mM of PBS, pH 6.8,  $t = 5^\circ\text{C}$ ) at the nucleoside concentrations of 8 mM (bottom trace) and 200 mM (top trace). Intermediate traces show the differences between the spectra at indicated concentration and that of the lowest one

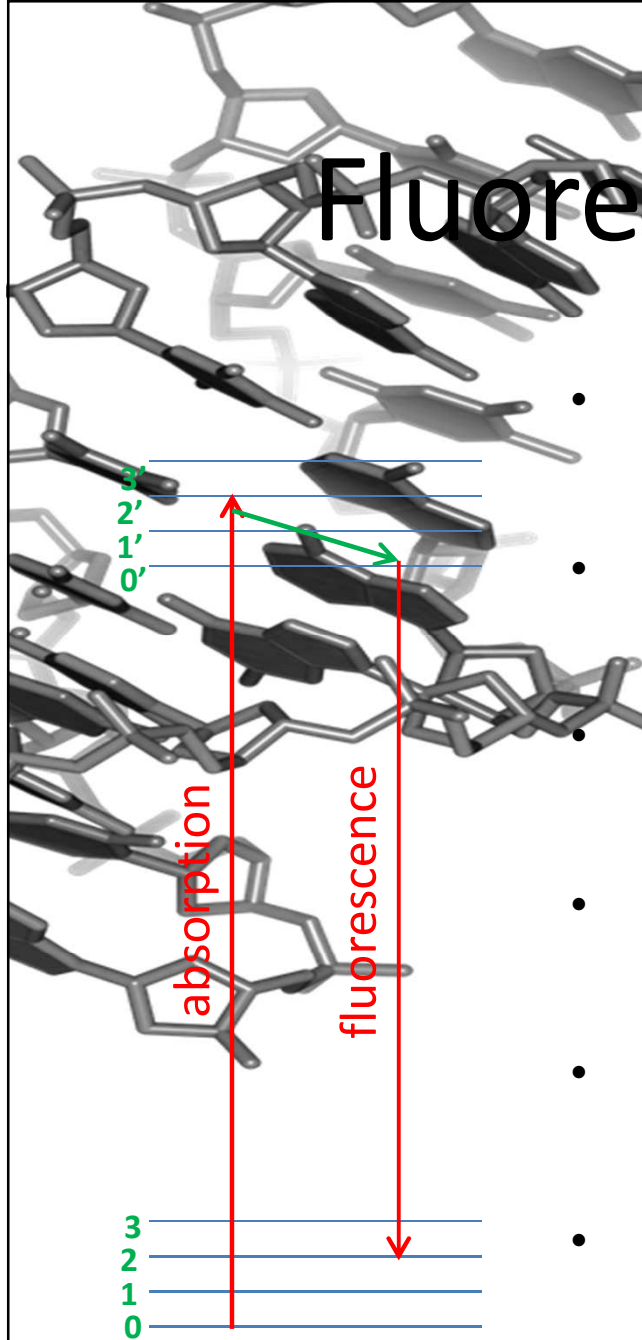
# Raman spectroscopy



poly(dA-dT) · poly(dA-dT) (0% G+C), *C. perfringens* DNA (27% G+C), *calif thymus* DNA (42% G+C), *E. coli* DNA (50% G+C), *M. luteus* DNA (72% G+C), and poly(dG-dC) · poly(dG-dC) (100% G+C).

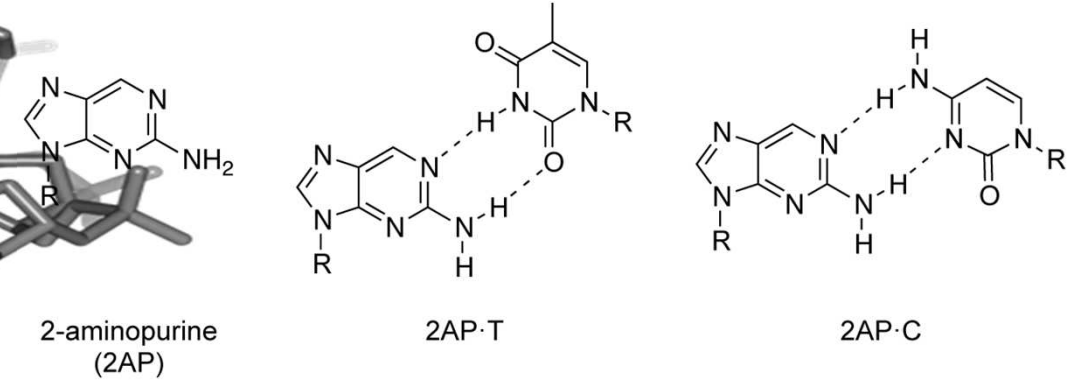
# Fluorescence in nucleic acids

- Spontaneous emission of the photon followed by transition to electronic ground state (any vibrational state – Franck-Condon)
- Emission always from the vibrational ground state of the electronic excited state (Kasha's rule)
- fluorescence itself very fast ( $10^{-15}$  s), but some time takes nonradiative conversion to  $v_0'$
- **Fluorophores** – molecules/parts of the molecule that exhibit fluorescence
- **Fluorescence lifetime** –  $\tau$  – average time from excitation of the molecule to emission of light [ns]
- **Quantum yield** – ratio between emitted and absorbed photons – “efficiency” of the fluorescence - max = 1, but usually lower (non-radiative transitions)

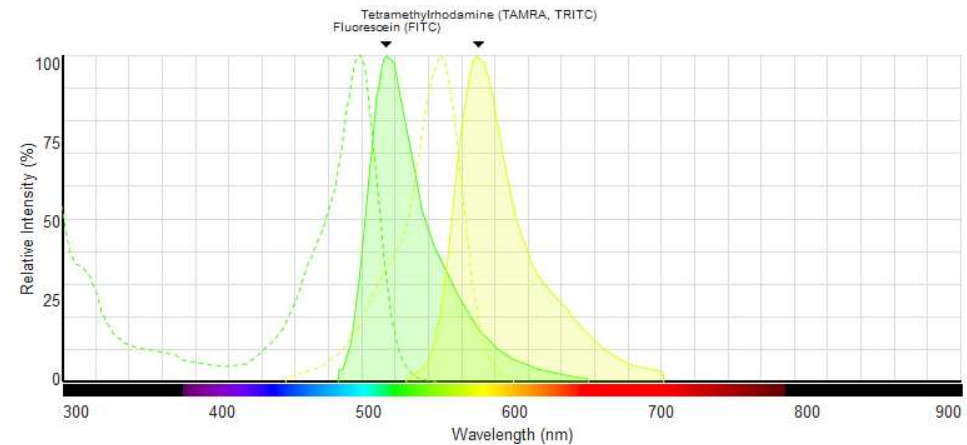


# Fluorescence in nucleic acids

- Very low intrinsic fluorescence, thus:
  1. Fluorescent base – 2-aminopurine



2. Fluorescent labels – FITC, TAMRA, ...

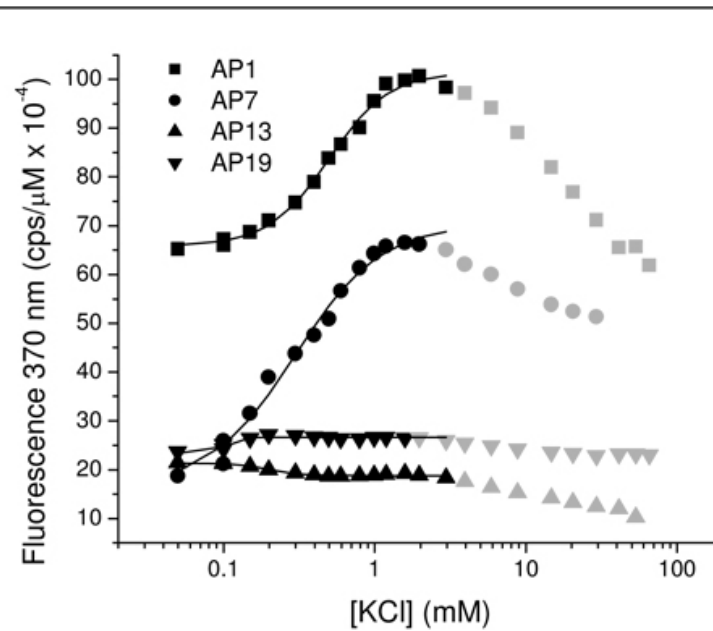
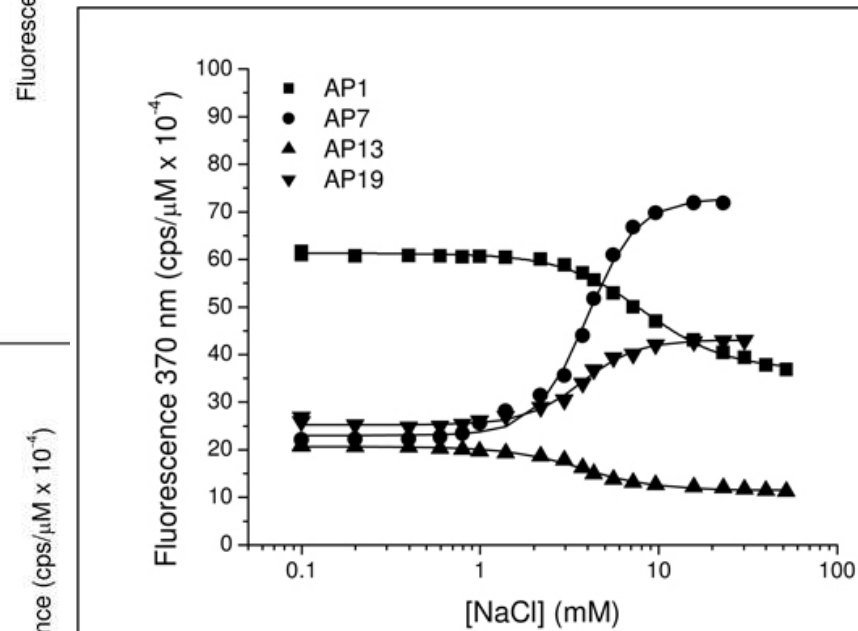
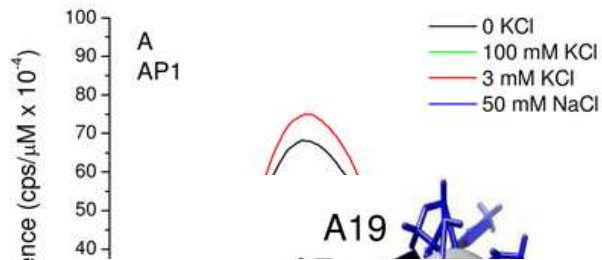


ThermoFisher Scientific  
Fluorescence spectra viewer

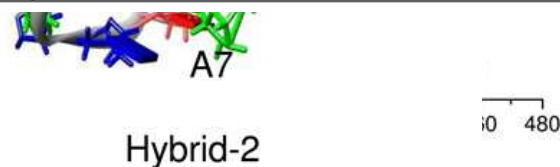
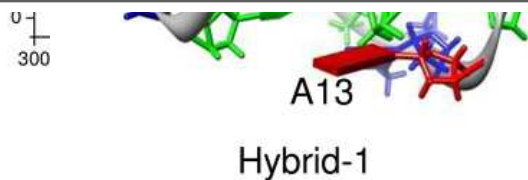
3. Fluorescent ligand – EtBr, porphyrins, ...



# Fluorescence – guanine quadruplex



K<sup>+</sup>-  
sensitive  
fluorescence  
in spectra  
derivatives  
as a  
function of cation  
concentration.



# Time-resolved fluorescence

THE JOURNAL OF  
PHYSICAL CHEMISTRY  
LETTERS

9585

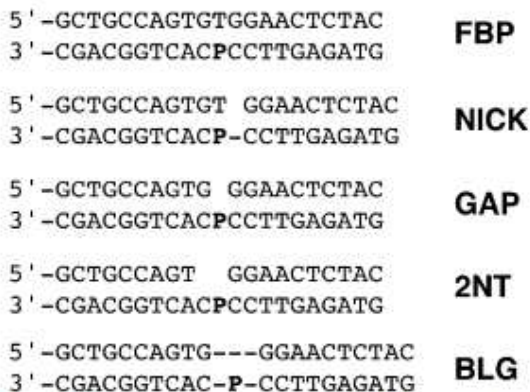
2009, 113, 9585-9587  
Published on Web 08/12/2009

## Conformational Analysis of DNA Repair Intermediates by Time-Resolved Fluorescence Spectroscopy

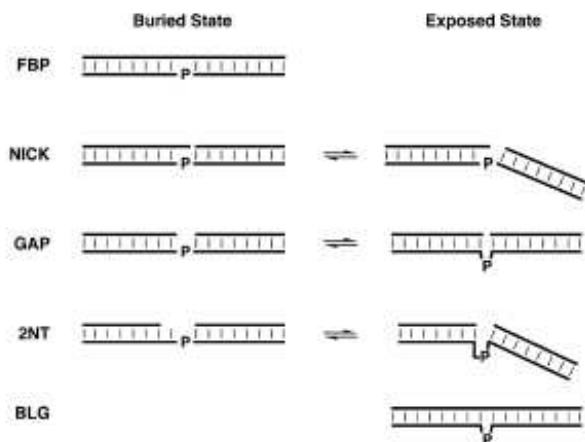
Su Lin,<sup>†</sup> David P. Horning,<sup>‡§</sup> Jack W. Szostak,<sup>‡</sup> and John C. Chaput<sup>6,†</sup>

Center for Biooptical Nanotechnology, The Biodesign Institute, and Department of Chemistry and Biochemistry, Arizona State University, Tempe, Arizona 85287-5201, and Howard Hughes Medical Institute and Department of Molecular Biology, Massachusetts General Hospital, Boston, Massachusetts 02114

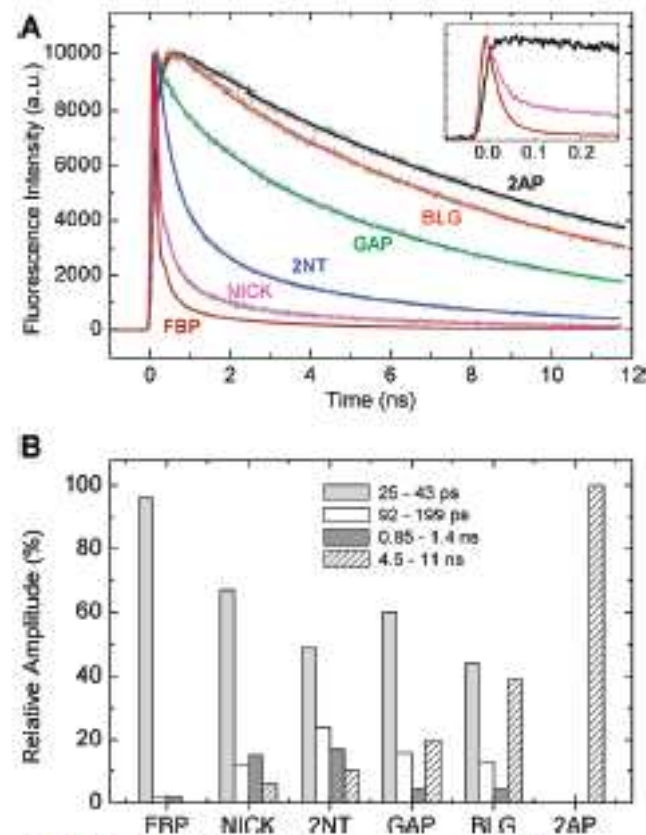
Received: July 16, 2009



**Figure 1.** DNA repair intermediates analyzed in this study. Structures with a gap in their sequence have discontinuous phosphodiester backbones. Dashes indicate continuous DNA strands. The 2AP residue is shown as **P**.

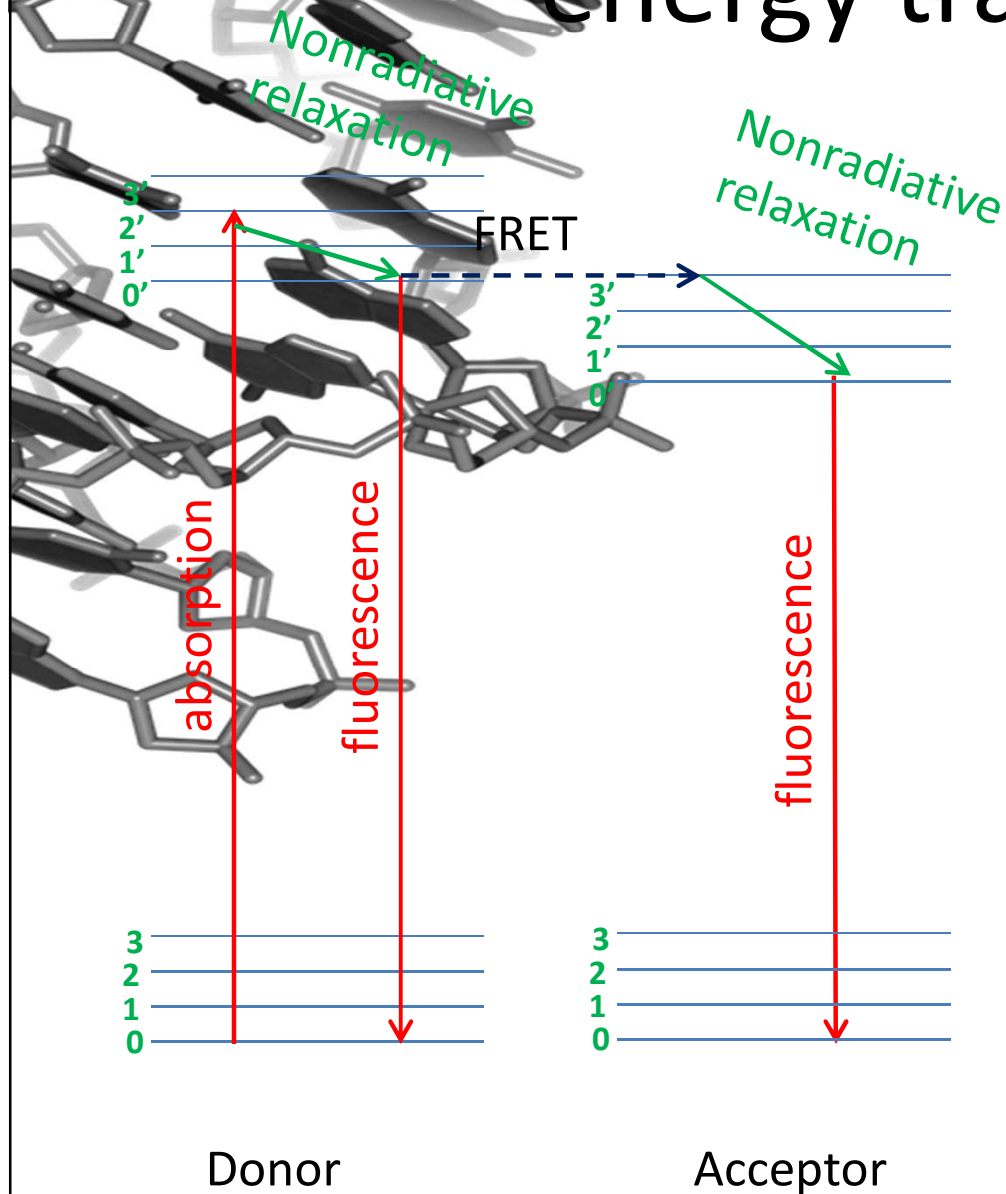


**Figure 2.** Schematic view of the DNA conformations. Damaged DNA structures are expected to equilibrate between several different conformations. The 2AP residue is indicated by the letter **P**.



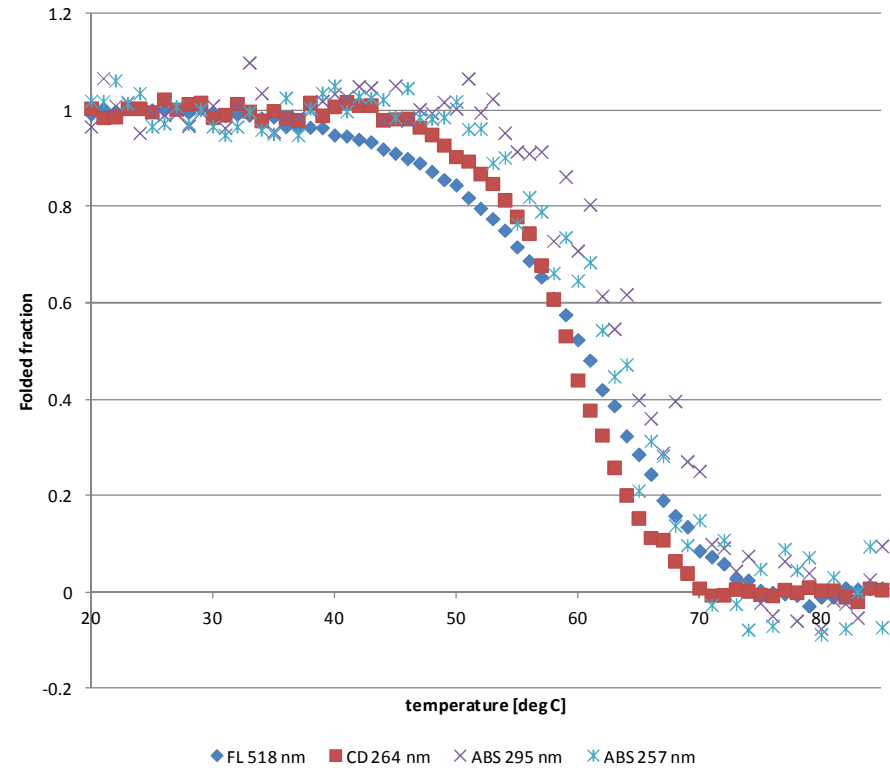
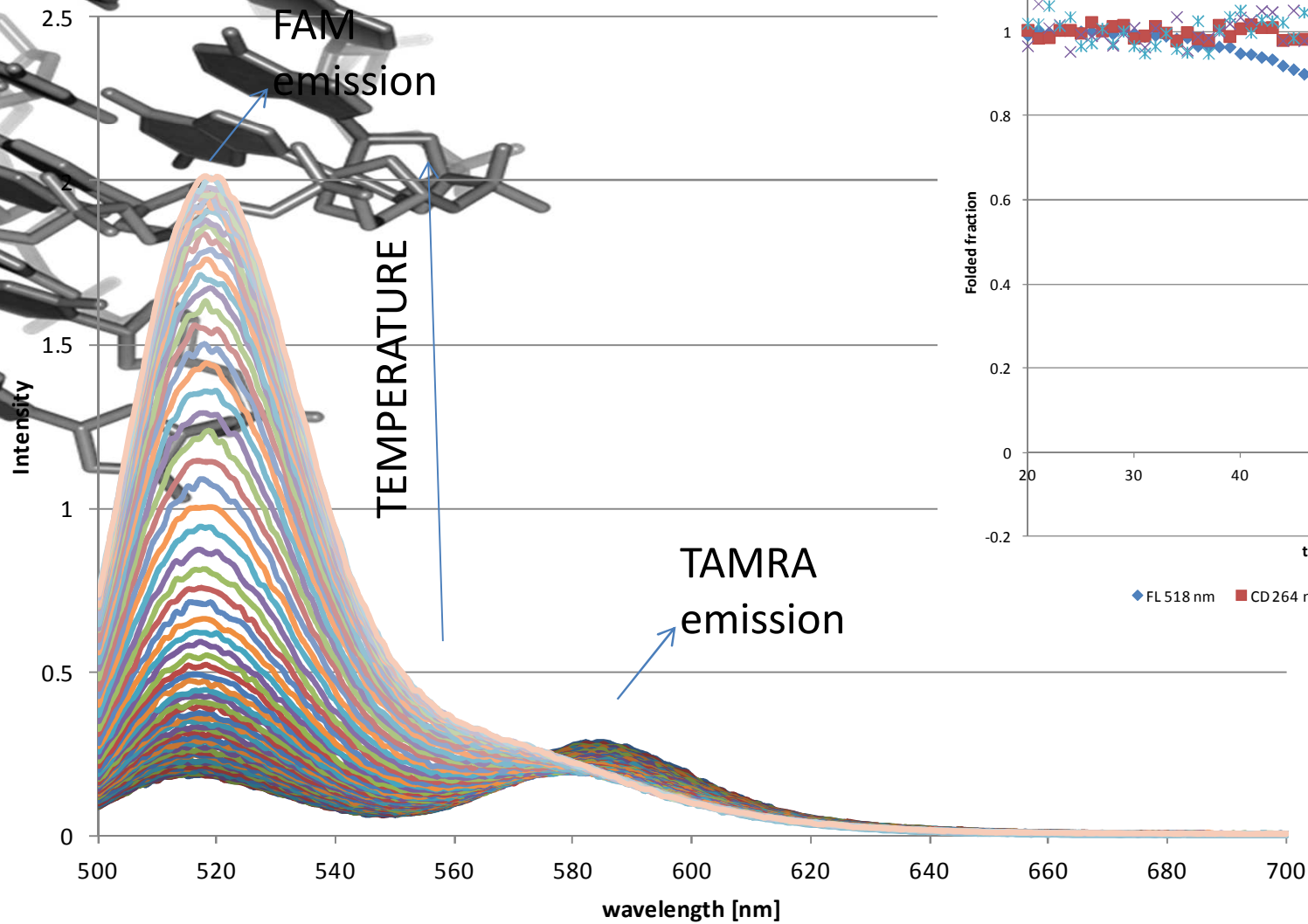
**Figure 3.** Kinetic analysis of DNA structures. (A) Fluorescence decay curves obtained by TCSPC were recorded at 390 nm with a time per step of 6.28 ps. The inset shows the early time kinetics of NICK, FBP, and free 2AP samples recorded on a streak camera system with 2 ps time resolution. (B) The relative amplitude of each lifetime obtained from a four-term exponential fit.

# Foerster (Fluorescence) resonance energy transfer (FRET)



- FRET might occur when the emission band of the donor overlaps with the excitation band of the acceptor and the molecules are close enough.
- FRET range 1-10 nm
- Various FRET pairs, characterized by  $R_0$  (distance where FRET is 50% for this pair)
- FRET efficiency  $E = 1 / (1 + r / R_0)^6$

# Foerster (Fluorescence) resonance energy transfer (FRET)



FAM – GQ – TAMRA  
150 mM K  
Excitation: 480 nm



# Fluorescence polarization/anisotropy (FP/FA)

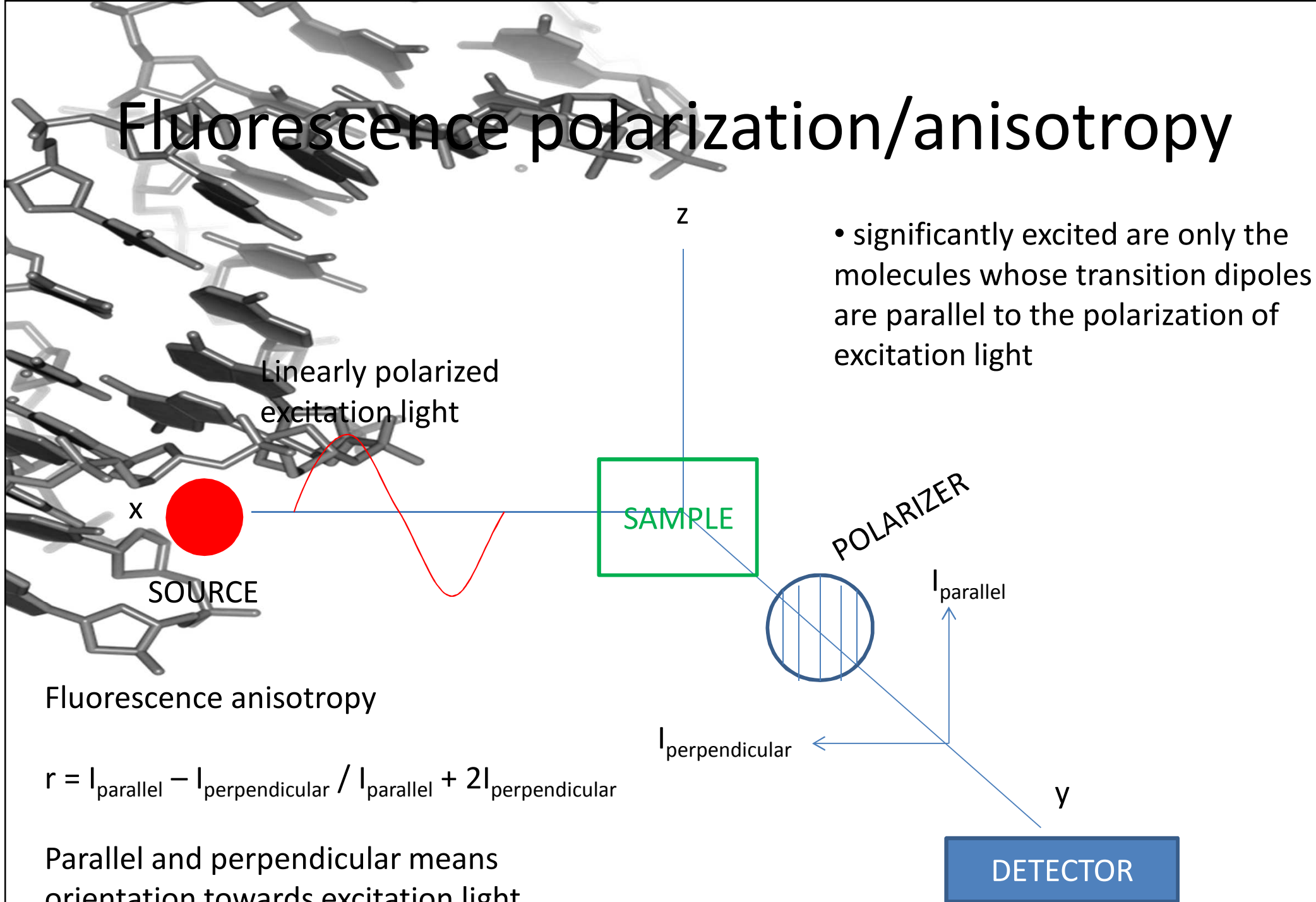
**Difference in the intensity of the sample-emitted light with polarization parallel and perpendicular to the polarization of the excitation light.**

- requirements: molecules are **fluorescent**

**FA provides information on molecular size (monomer x dimer) and shape, local viscosities of a fluorophore's environment and allows measurement of kinetics parameters of reactions.**

- often as a **time-resolved** method for rotational velocities measurement– short pulse of light ( $10^{-9}$  sec) followed by fluorescence measurement over time
- in this case the molecule must be **spherical** to avoid various rotational velocities in different directions and the fluorophore must be **firmly attached** to prevent rotation of the fluorophore only

# Fluorescence polarization/anisotropy



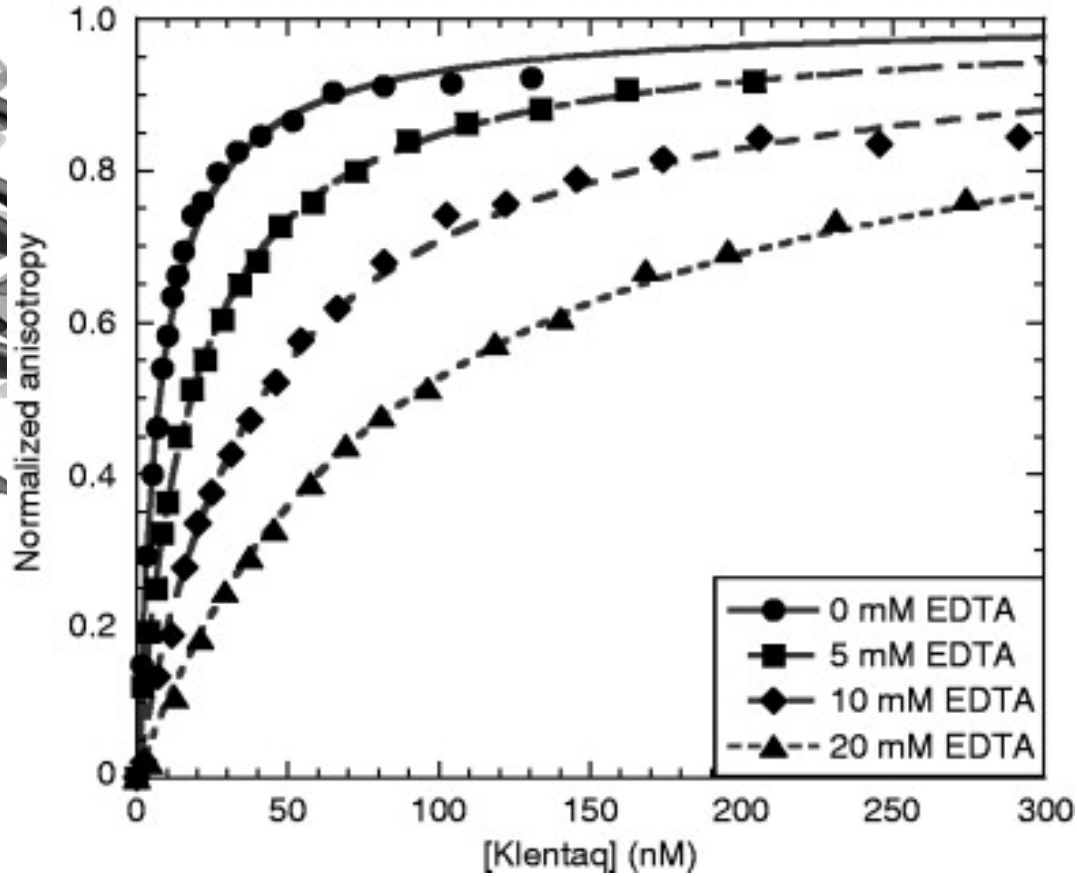
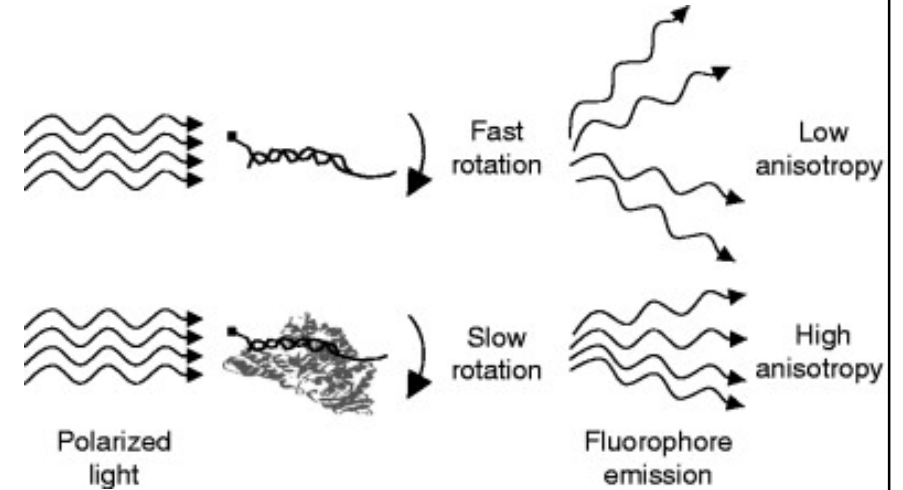
- significantly excited are only the molecules whose transition dipoles are parallel to the polarization of excitation light

Fluorescence anisotropy

$$r = \frac{I_{\text{parallel}} - I_{\text{perpendicular}}}{I_{\text{parallel}} + 2I_{\text{perpendicular}}}$$

Parallel and perpendicular means orientation towards excitation light

# Fluorescence polarization anisotropy



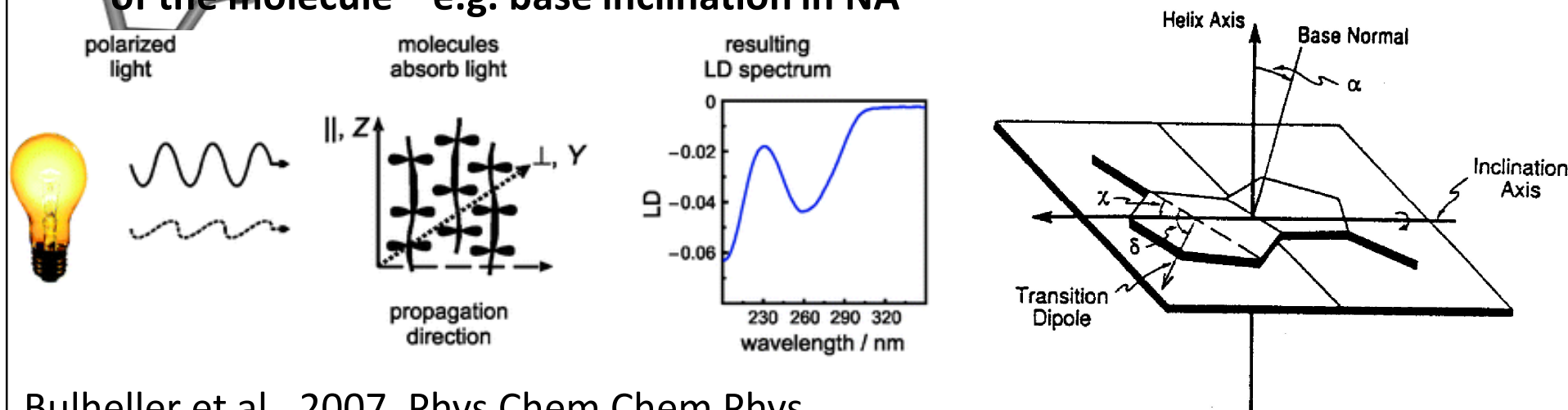
The effects of EDTA on the binding of Klentaq DNA polymerase to primed-template DNA (13/20-mer DNA)

# Linear dichroism (LD)

**Difference in absorption of the light linearly polarized parallelly and perpendicularly to the orientation of the molecules**

- requirements: molecules are **oriented** and molecules **absorb** in the region of interest
- orienting the molecules: gel, electric field, flow (rotation)

**LD is sensitive to the orientation of absorbing parts (nucleobases) towards the orientation of the molecule – e.g. base inclination in NA**

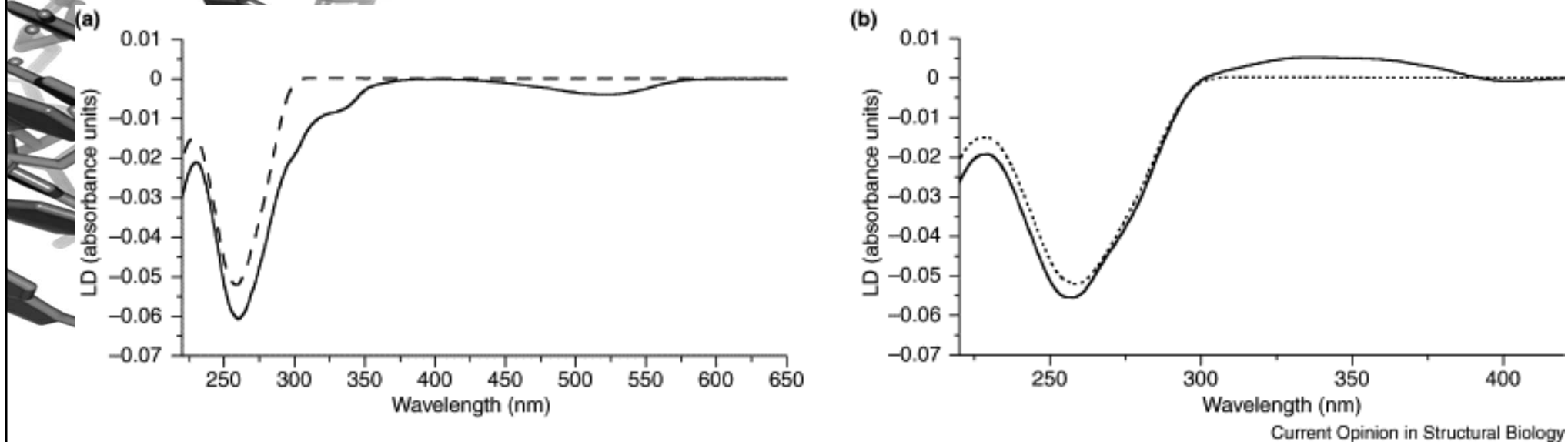


Bulheller et al., 2007, Phys Chem Chem Phys

Rodger et al., 2006, Phys Chem Chem Phys



# LD DNA + ligand



LD of DNA and DNA–ligand systems. **(a)** LD of calf thymus DNA (1000  $\mu\text{M}$  base, dashed line) and the DNA plus an ethidium bromide intercalator (50  $\mu\text{M}$ , solid line). **(b)** LD of calf thymus DNA (1000  $\mu\text{M}$  base, dashed line) and the DNA plus a minor groove binder (diaminophenyl indole, 50  $\mu\text{M}$ , solid line)



# Circular dichroism (CD)

## Difference in absorption of left-handed circularly polarized light and right-handed circularly polarized light by a molecule

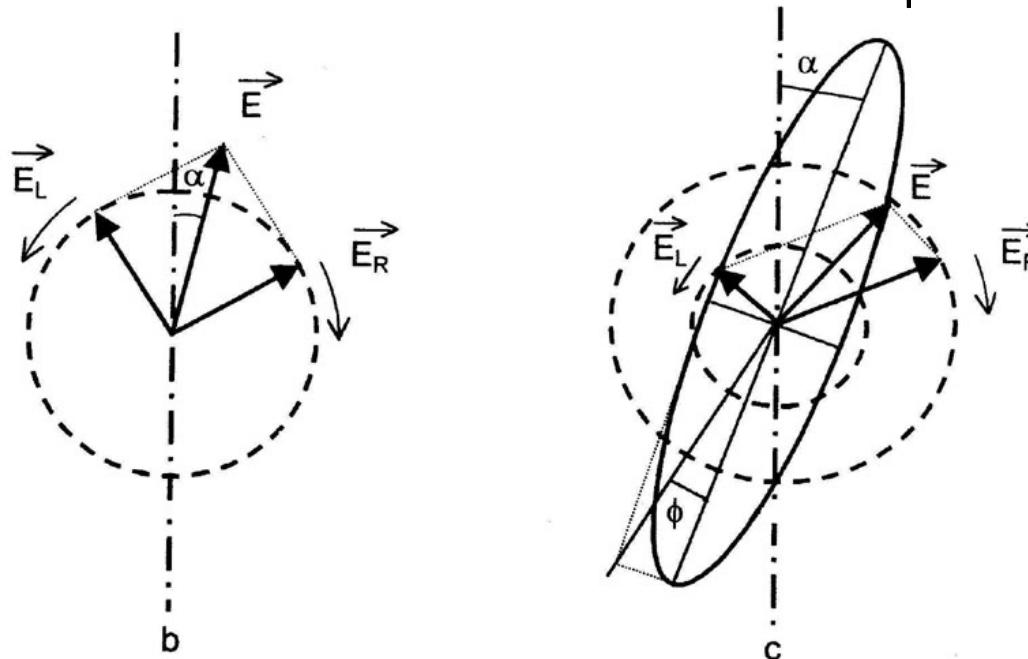
- requirements: molecules are **chiral** (sugar in NA), thus optically active and molecules **absorb** in the region of interest

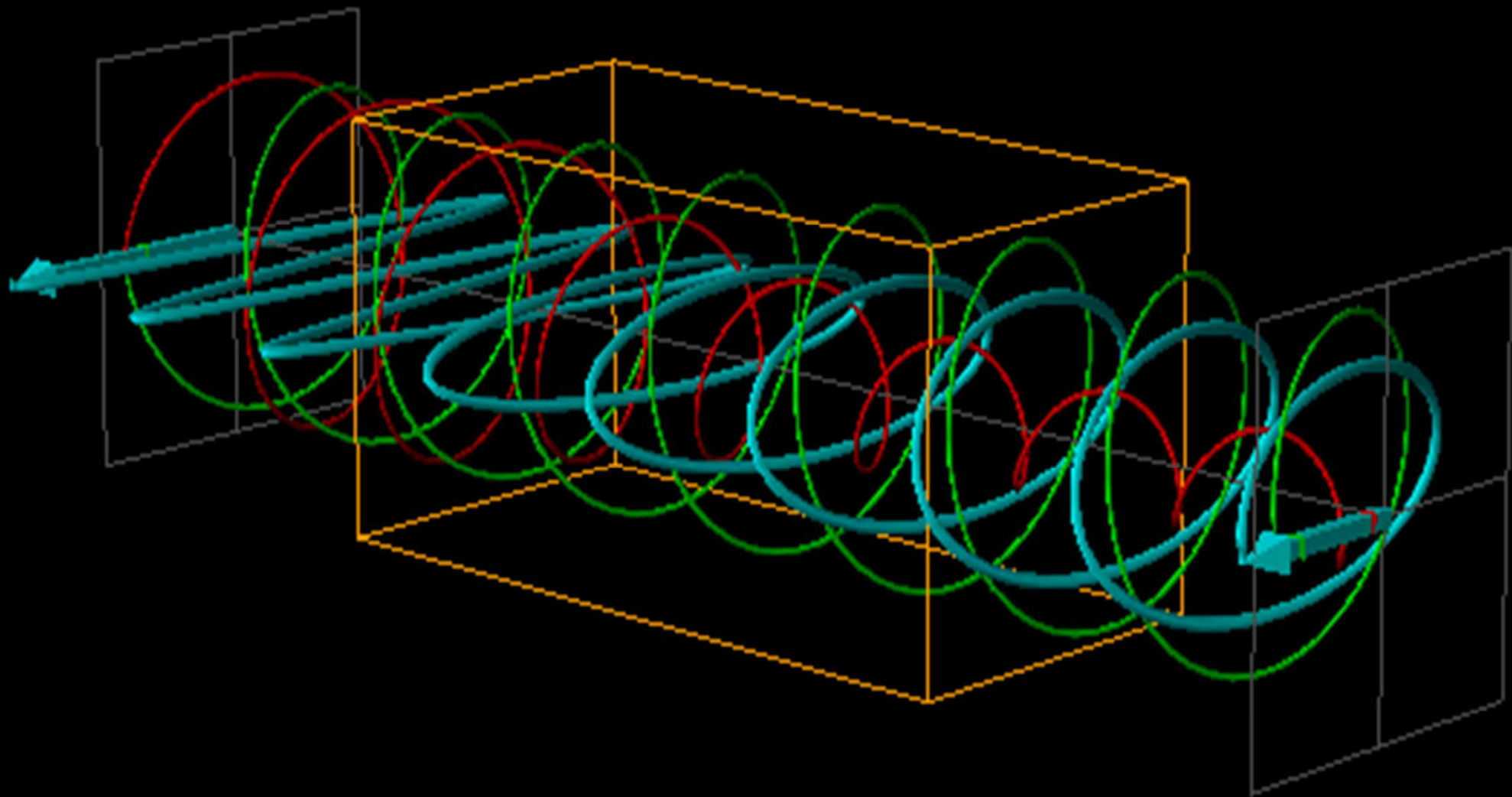
**CD is sensitive to the mutual orientation of absorbing parts (nucleobases) towards each other – base conformations (syn x anti) – secondary structure of DNA**

- **optical activity** = ability of the molecule to differentially interact with left-handed and right-handed circularly polarized light
- **Optical rotatory dispersion (ORD)** – angle of rotation of the linearly polarized light after passing through the optically active molecule – ORD in whole range of wavelenghts, with anomalous ORD, where molecule absorbs – more difficult interpretation than CD
- **Cotton effect** – CD / ORD band – positive x negative

# Circular dichroism (CD)

- Difference in absorbance:  $\Delta A = A_L - A_R$
- When known concentration, difference in molar absorption  $\Delta \epsilon = \epsilon_L - \epsilon_R = \Delta A / lc$  (Beer-Lambert law)
- Ellipticity – the angle that describes the extent of change of the linearly polarized light into a elliptically polarized light (0 for linearly polarized,  $45^\circ$  for circularly polarized)  
$$\tan \phi = (E_L - E_R) / (E_L + E_R) = 3298 * \Delta \epsilon$$
- CD can be calculated but the results do not fit well with the experiment

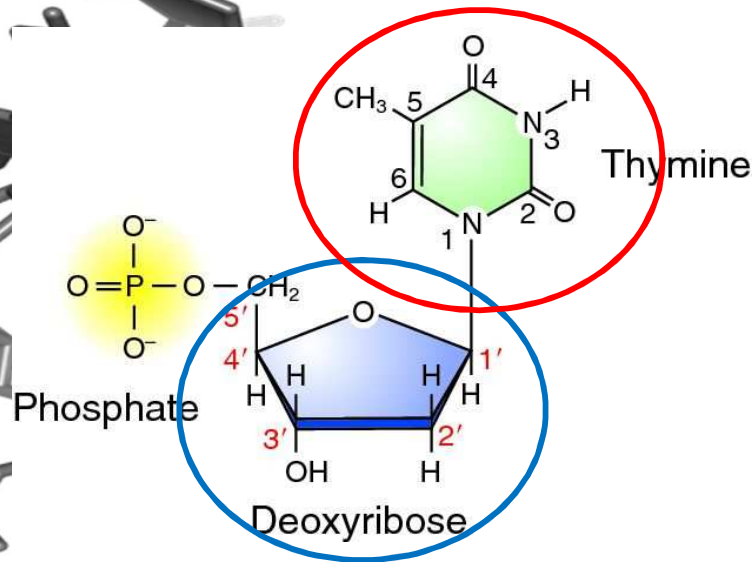




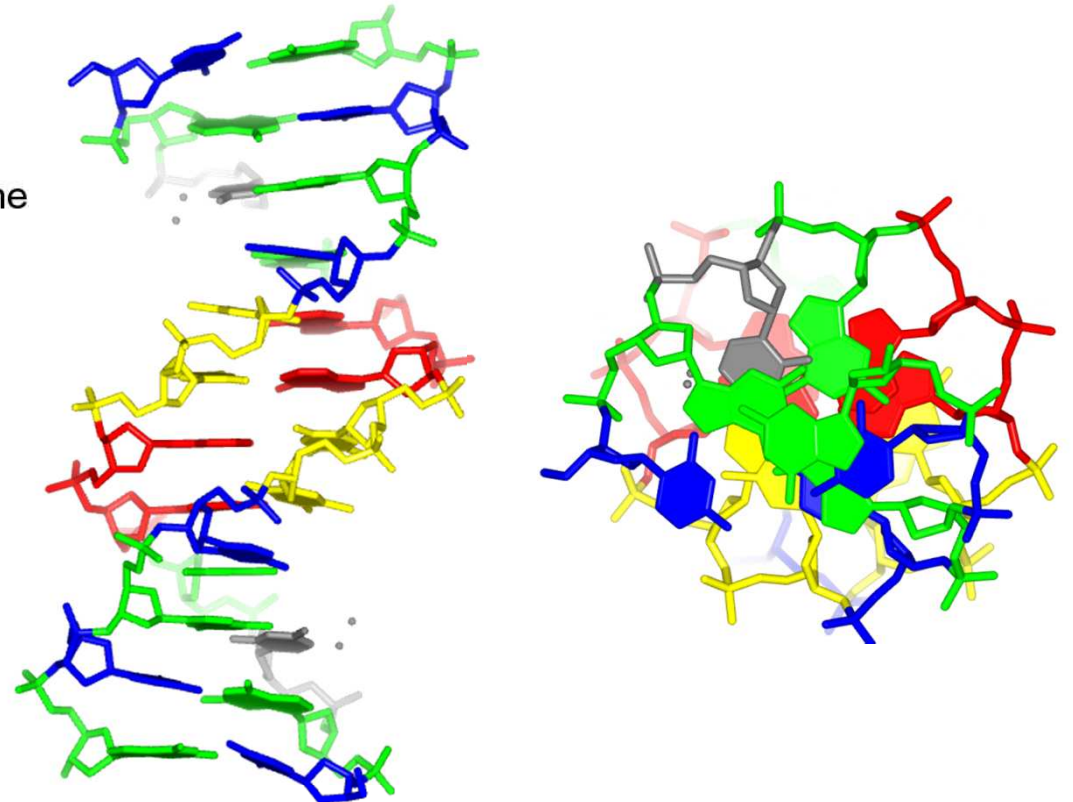
# Circular dichroism – DNA / RNA

## MUTUAL ORIENTATION OF BASES

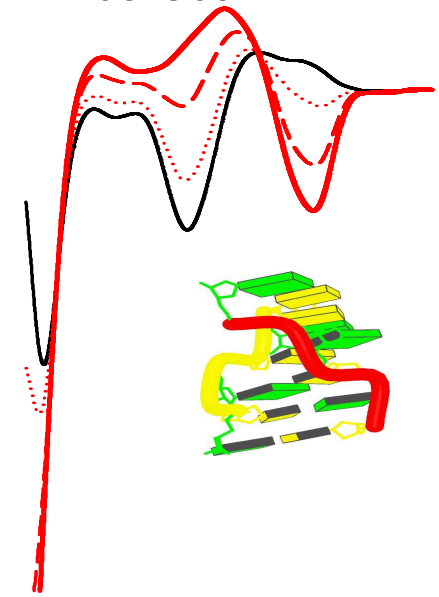
### ABSORPTION



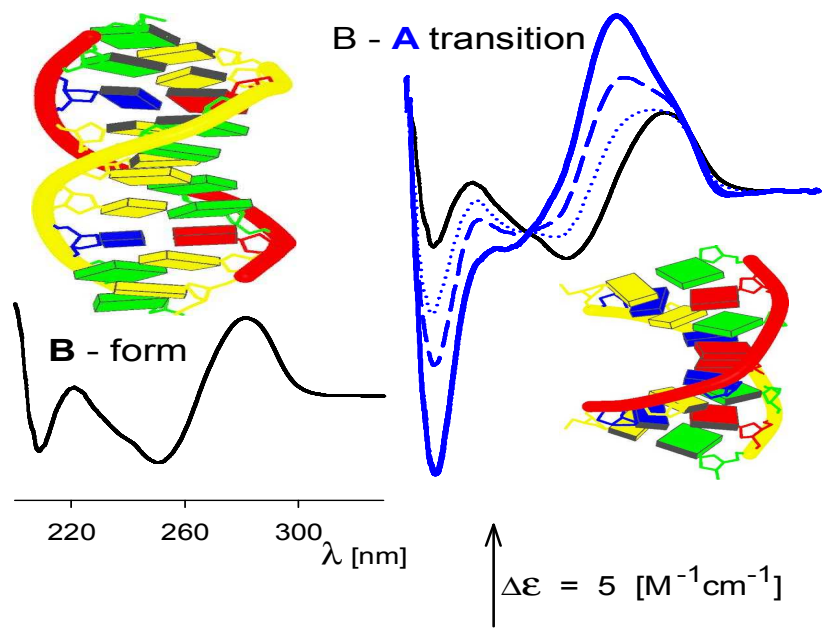
### CHIRALITY



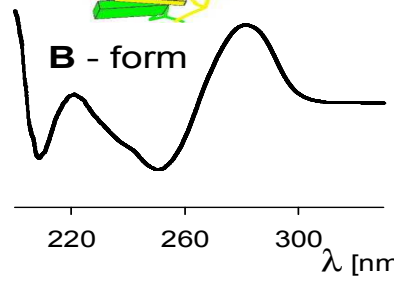
B - Z transition



B - A transition

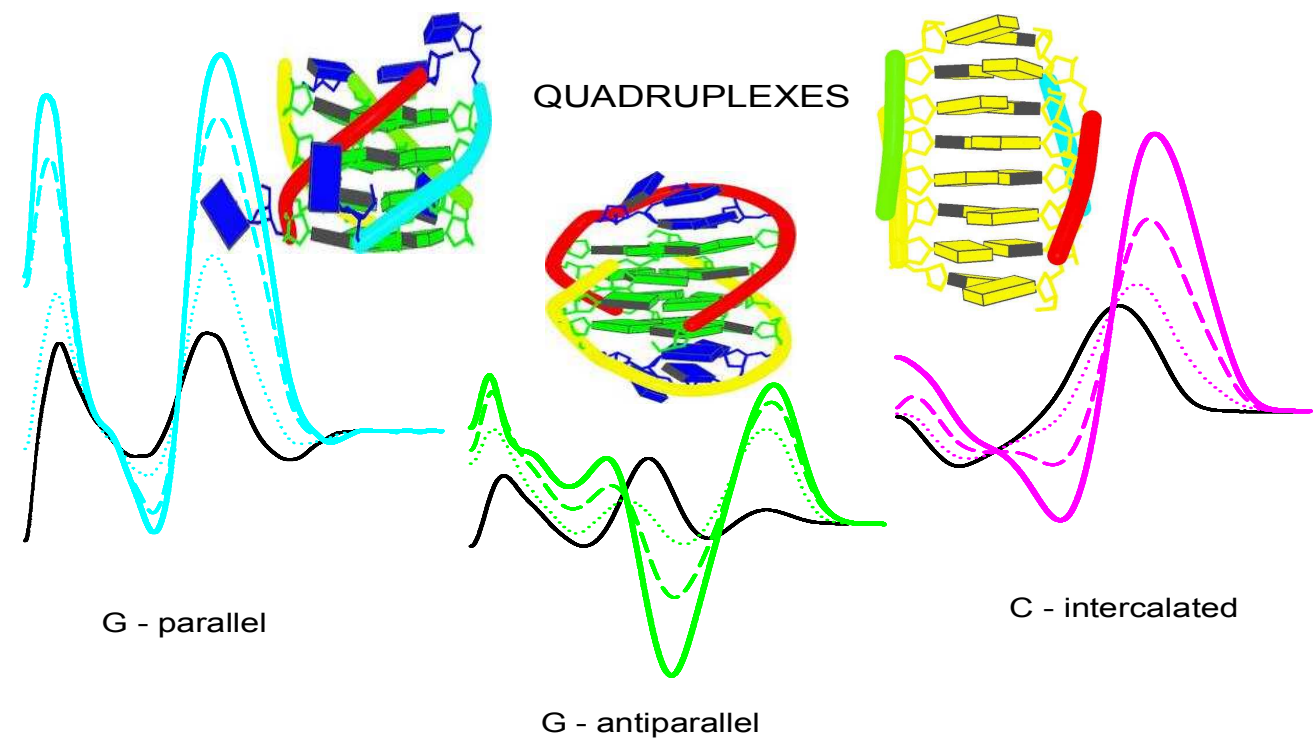


B - form



$\Delta\epsilon = 5 \text{ [M}^{-1}\text{cm}^{-1}\text{]}$

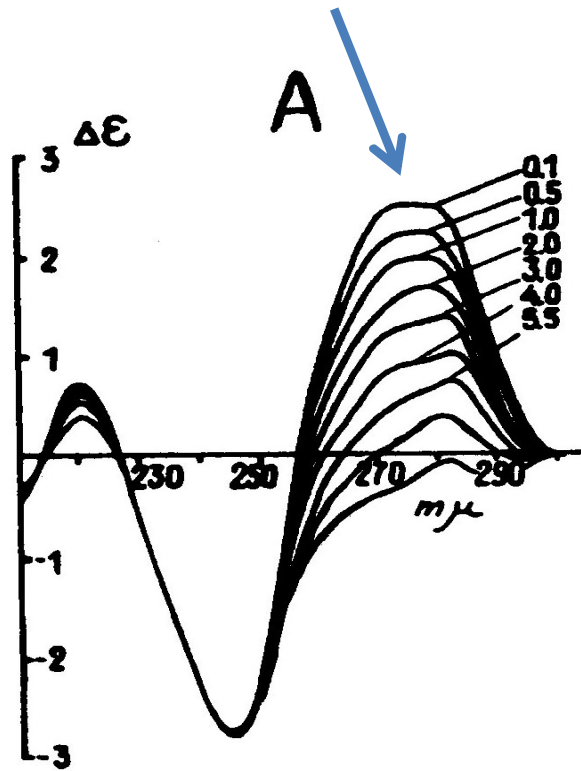
QUADRUPLEXES



# Transition cooperativity

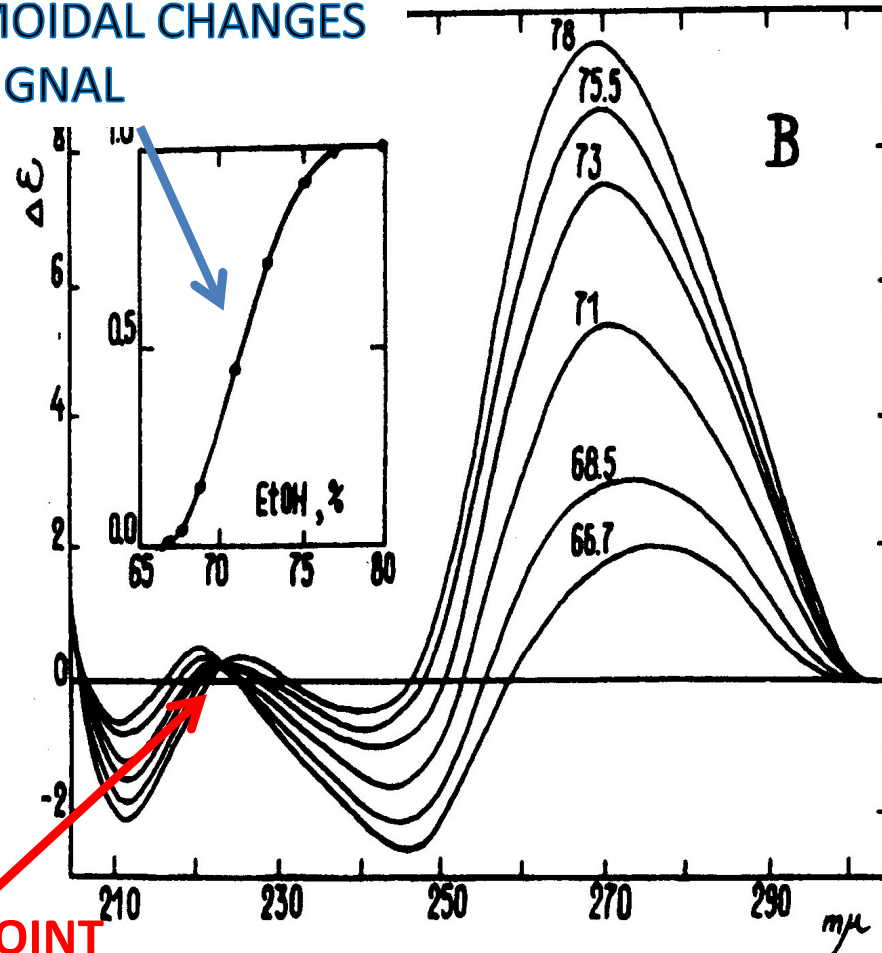
NON-COOPERATIVE  
TRANSITION

LINEAR CHANGES  
OF SIGNAL

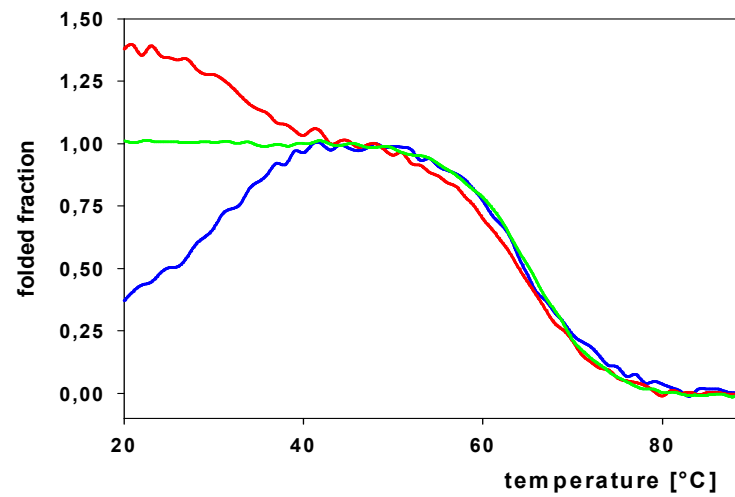
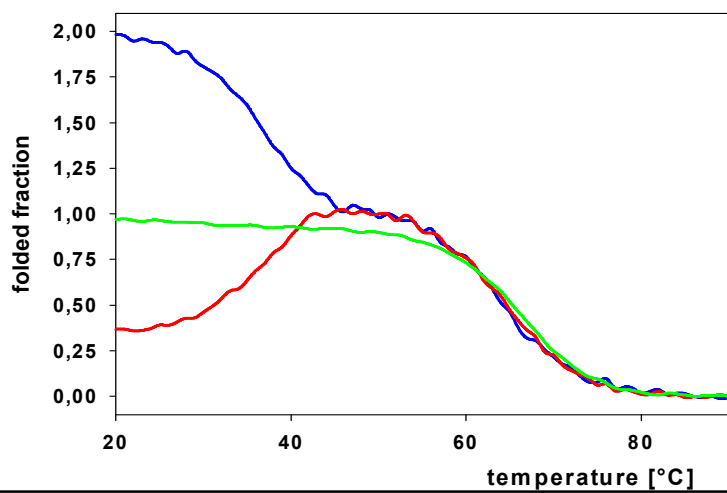
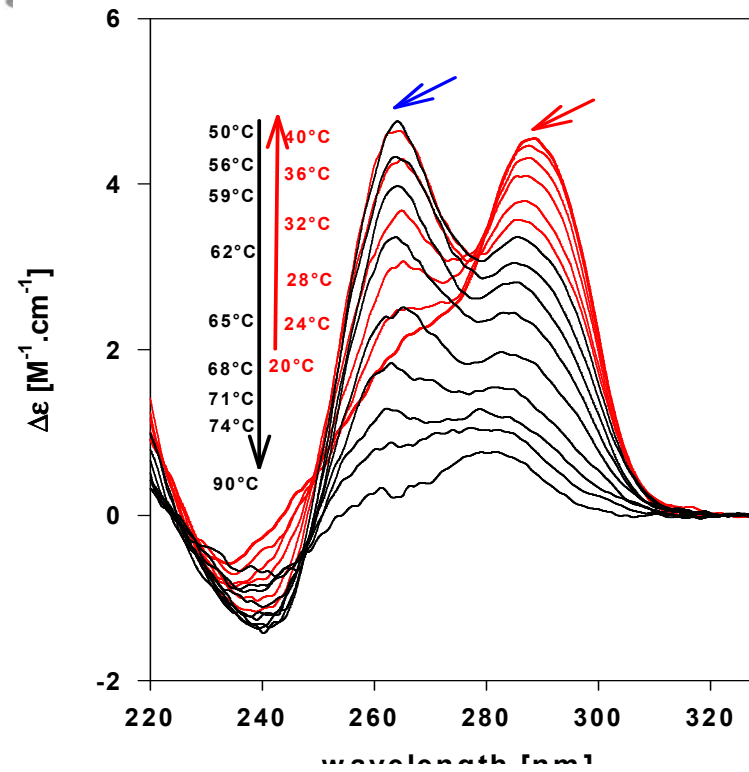
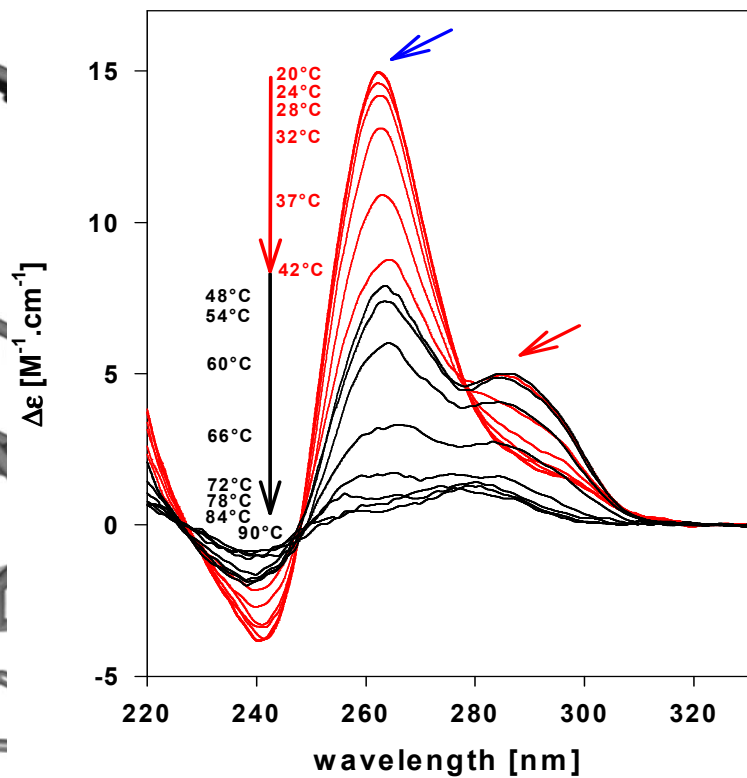


COOPERATIVE TRANSITION

SIGMOIDAL CHANGES  
OF SIGNAL

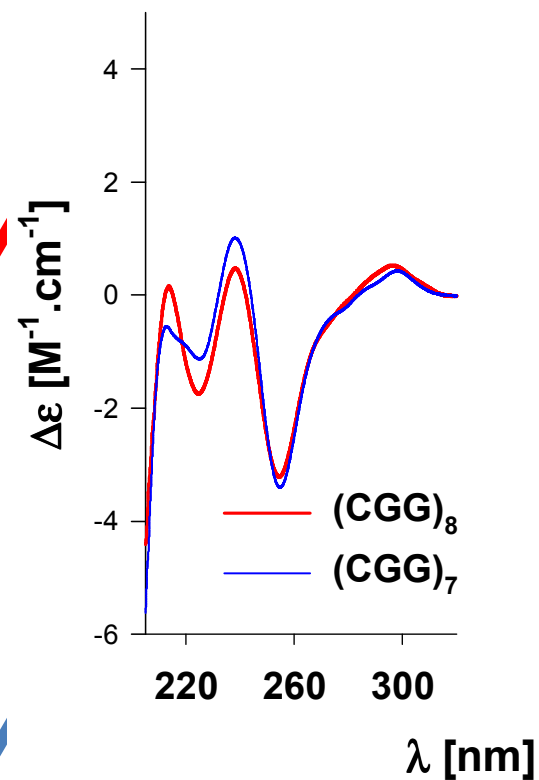
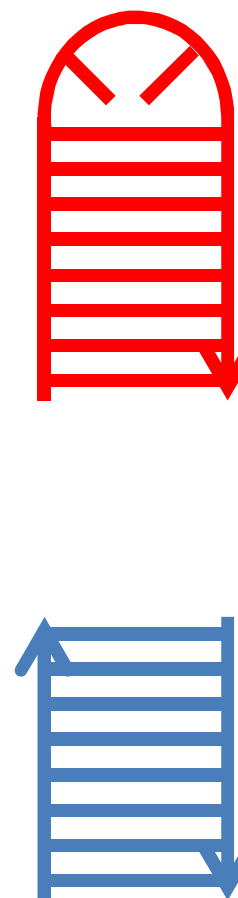
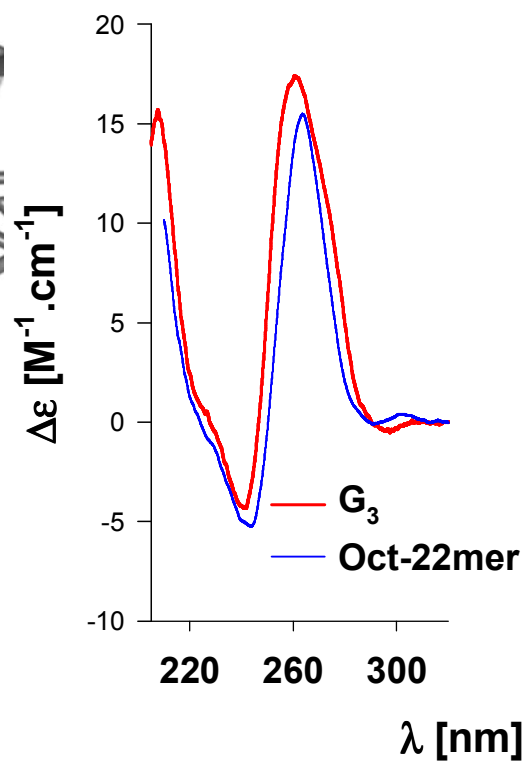
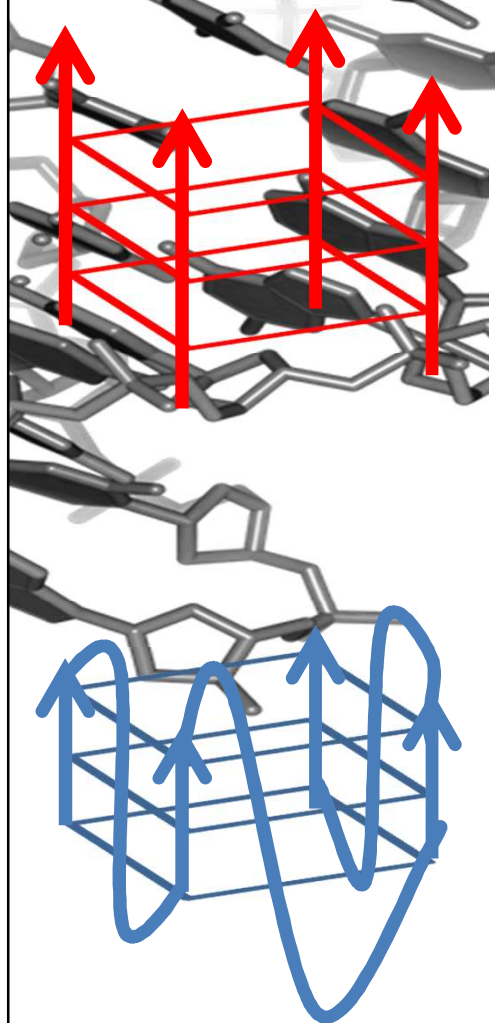


# CD – NA melting





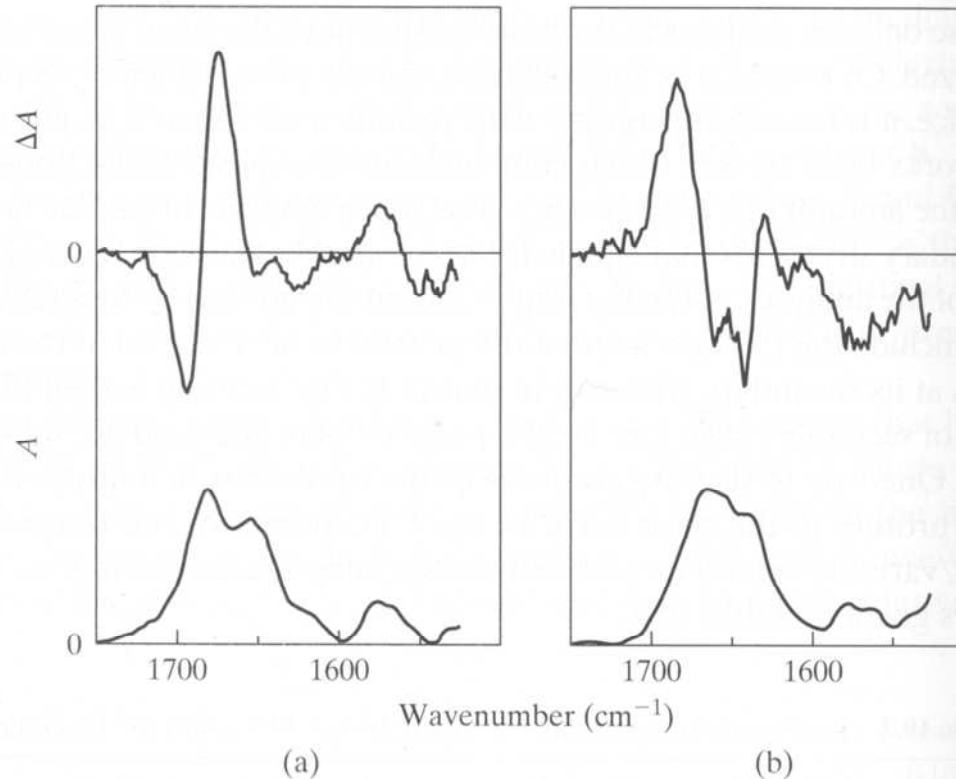
# Molecularity



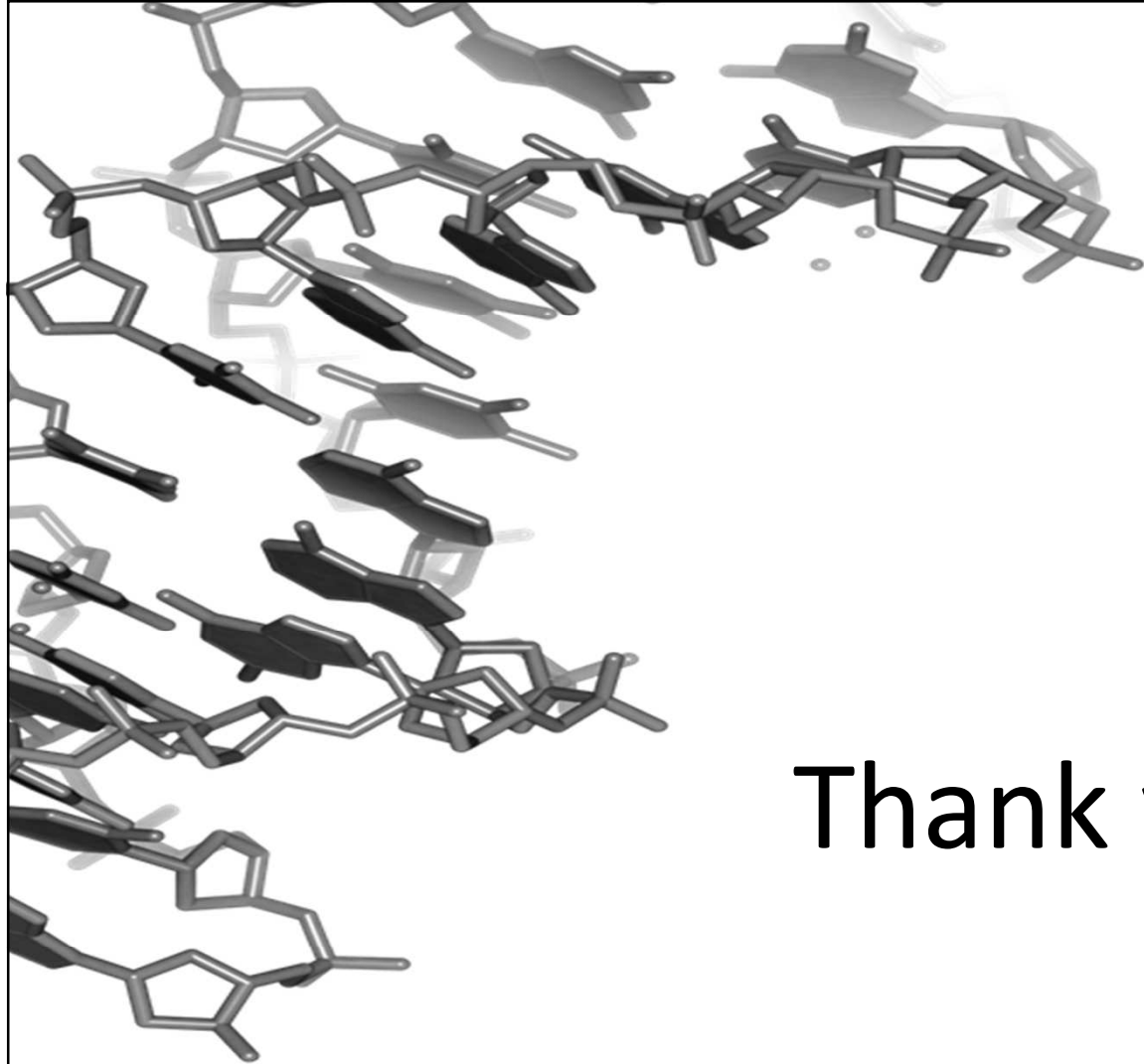
# Vibrational / infrared CD (VCD/IRCD)

Difference in absorption of left-handed circularly polarized light and right-handed circularly polarized light in a region of vibrational transitions ( $\lambda = 1-5 \mu\text{m}$ ).

- compared to eCD, IRCD shows well differentiated bands belonging to specific functional groups



The vibration CD and absorption spectra of homoduplex of d(GC)<sub>10</sub> as the right-handed B-form and the left-handed Z-form.



Thank you