

# ENZYMES USED IM MOLECULAR BIOLOGY

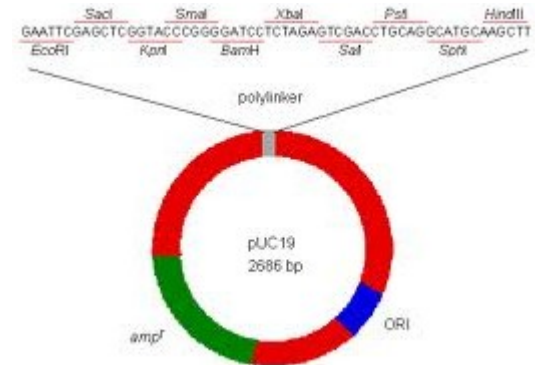
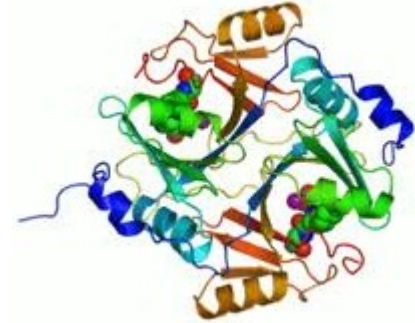

# Nucleic acid processing enzymes

- nucleases
- polymerases
- phosphatases
- methylases
- kinases
- ligases
- polynucleotidyl phosphorylase

# Nucleases

- hydrolases cleaving phosphodiester bonds
- DNases, RNases, „non-specific“

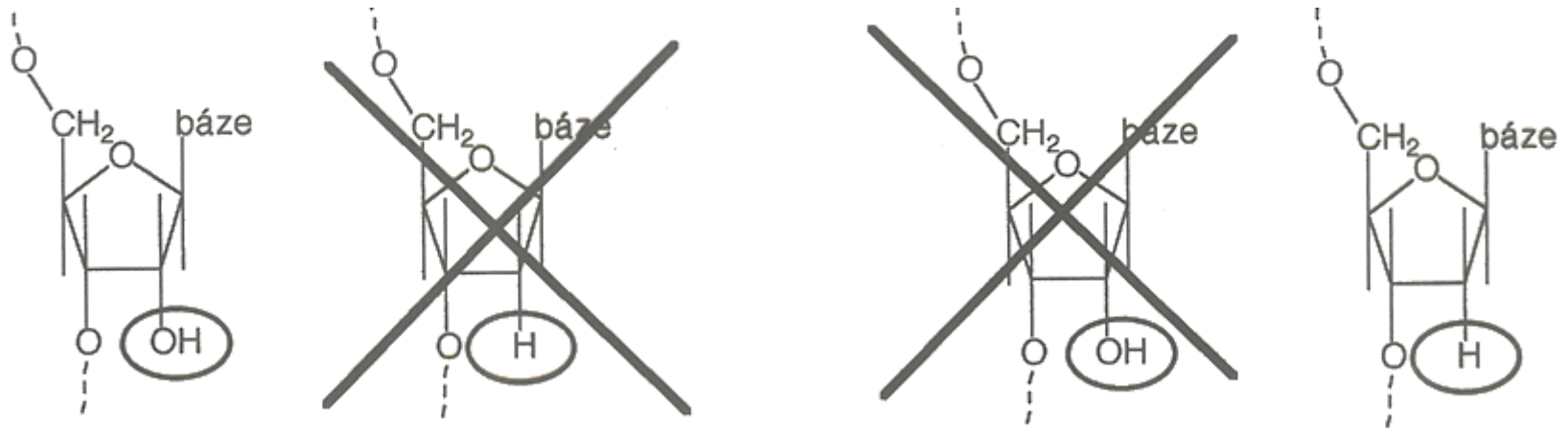

# Nucleases

- which phosphoester bond is hydrolyzed

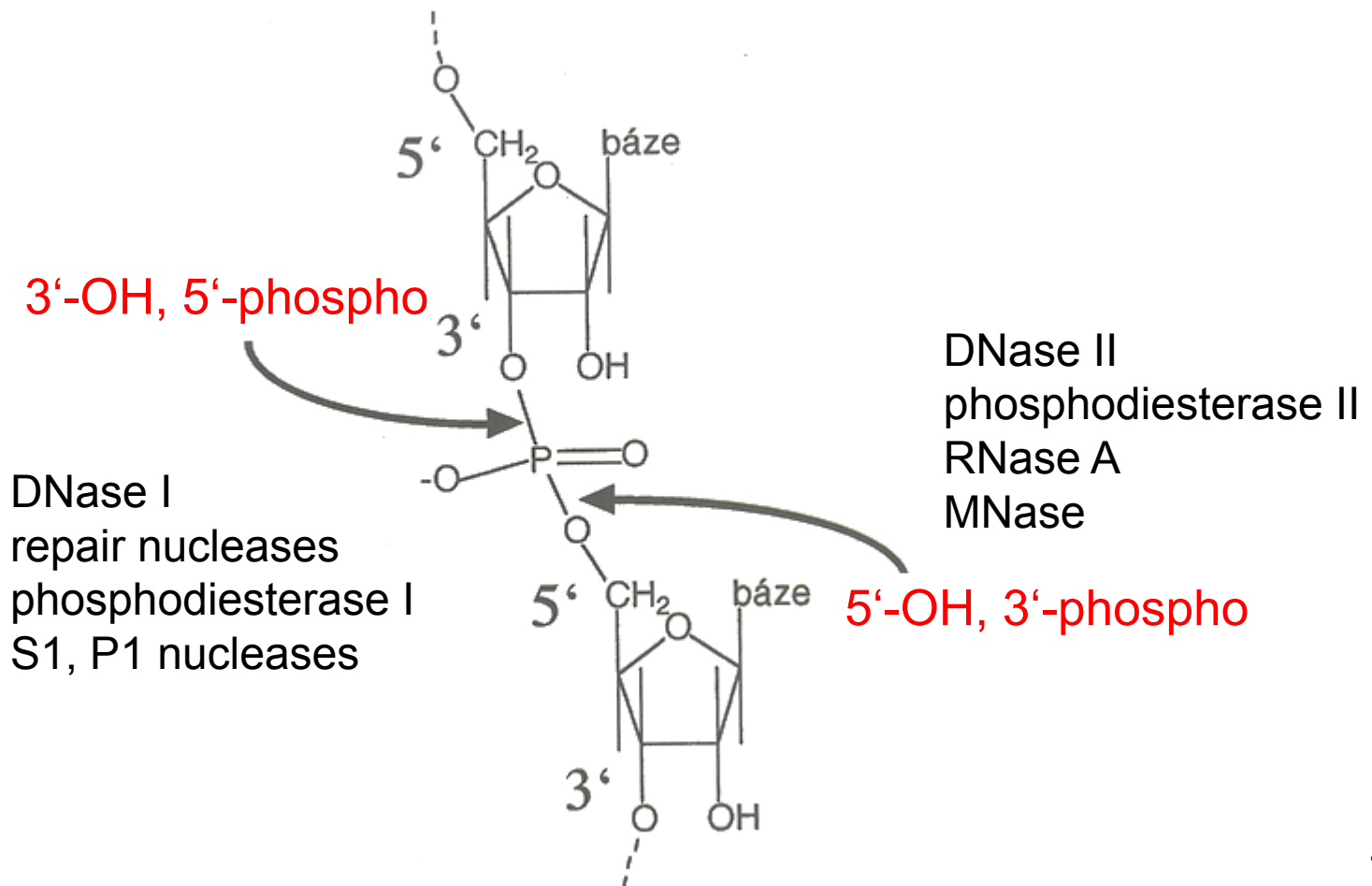

# Nucleases

- endonuclease or exonucleases

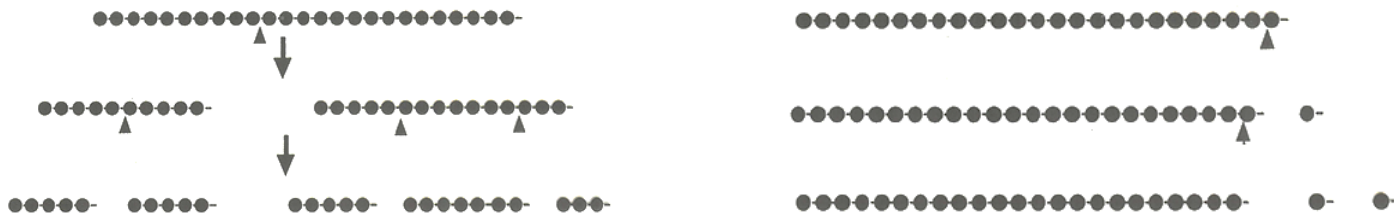

- exonucleases:

- processive or distributive



- direction of cleavage (5'→3', 3'→5')

# Nucleases

- other criteria (levels of selectivity/specificity):
  - secondary structure of substrates (ss, ds, untwisted)
  - preference for certain nucleotide (Pu vs Py or particular base) – RNases (A, U1, U2, T1, T2, Phyl, PhylI)
  - sequence specificity (restriction endonucleases)
  - modification specificity (methylation-sensitive restrictases)

# RESTRICTION ENZYMES

---

## *Sequence-specific DNA binding + cleavage*

Type I RE:            3 different subunits (specificity, methylation, nuclease)  
cleave outside binding sequence

**Type II RE:**            2 identical subunits, both share specific binding + nuclease  
cleave within the binding sequence (4-6 bp, palindromes)  
complementary methylases

Type III RE:            2 different subunits, „something between“

# RESTRICTION ENZYMES

Nomenclature:

***EcoRI***

E	Escherichia	Genus
CO	coli	Species
R	RY13	Strain
I	první	Order of discovery



# RESTRICTION ENZYMES

- sticky end formation

*Eco*RI (GAATTC) – 5'-overhangs

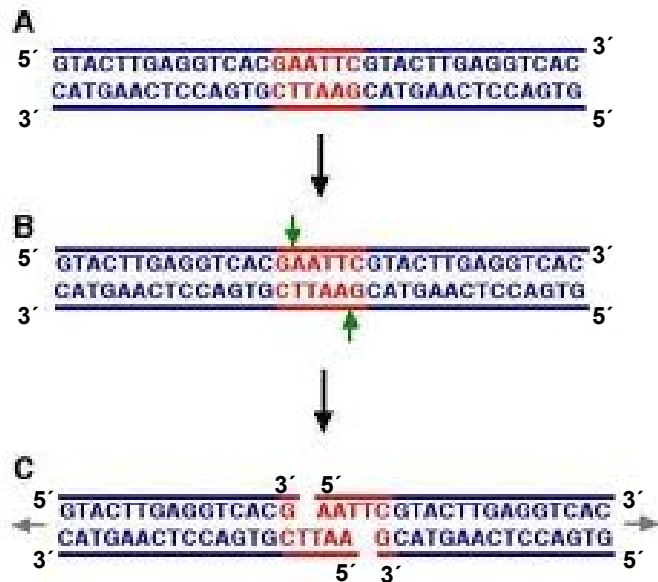

*Pst*I (CTGCAG) – 3'-overhangs

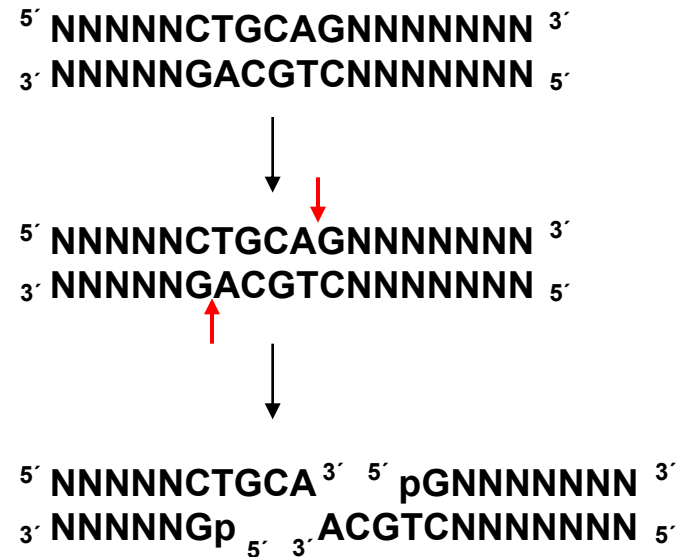

# RESTRICTION ENZYMES

- **blunt end formation**

*Hae*III (GGCC):

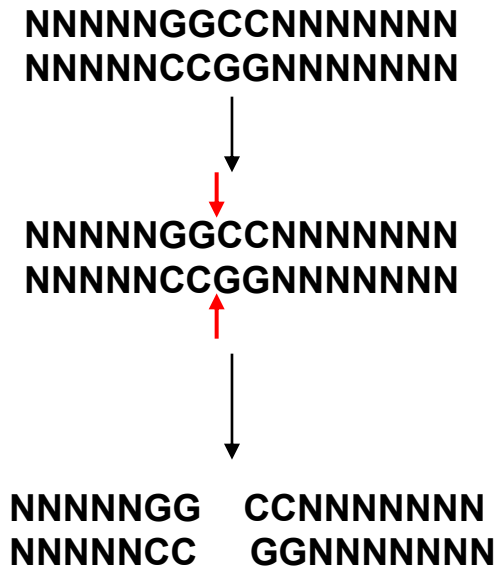

## Isoschisomers:

- recognize+cleave the same sequence  
X not necessarily in the same way

- may differ in sensitivity to methylation  
(Msp I x Hpa II, Bstn I x EcoR II)

## Linear diffusion mechanism:

- efficient searching for binding sites by sliding along DNA; balanced non-specific binding

## Star activity:

- less specific cleavage under improper conditions (reduced water activity)

# METHYLATION-RESTRICTION SYSTEMS

**Bacterial defence against viral (phage) infection: methylated DNA is not cleaved by the restrictases, unmodified phage DNA is**

Methylation systems in *v E. coli*:

- *dam* - <sup>6</sup>N methylation of adenine **GATC**  
roles in mismatch repair, DNA replication, gene expression
  - Bam*HI – GGATCC + (*Bacillus amyloli*)
  - Bcl*I – TGATCA - (*Bacillus caldolyticus*)
  - Mbo*I – GATC -
  - Sau*3AI – GATC +
- *dcm* – inner cytosine methylation (<sup>5</sup>C) in **CCAGG, CCTGG**
  - Eco*RII -
  - Bst*NI +
- *Eco*KI – <sup>6</sup>N methylation of adenine **AAC(N)<sub>6</sub>GTGC, GCAC(N)<sub>6</sub>GTT**

For example, plasmid DNA cloned in *E. coli* *dam*<sup>+</sup> is resistant to *Mbo*I

## Post-replication maintenance DNA methylation in symmetrical sequences



- bacterial DNA: hemimethylated after replication, methylation follows
- phage DNA: non-methylated, cleaved
- ca 0.2 % frequency of de-novo methylation: phage „learns“ how to survive and replicate

# METHYLATION-SENSITIVE RE

CG: *HpaII*  $mC^mCGG$  (either of the  $mCs$ )  
*CfoI*  $G^mCGC$   
*SmaI*  $CC^mCGGG$   
*TaqI*  $A^mCGT$   
*Clal*  $AT^mCGAT$

CNG: *MspI*  $mCCGG$

CHH: *Sau96I*  $GG(A/T)^mC^mC$

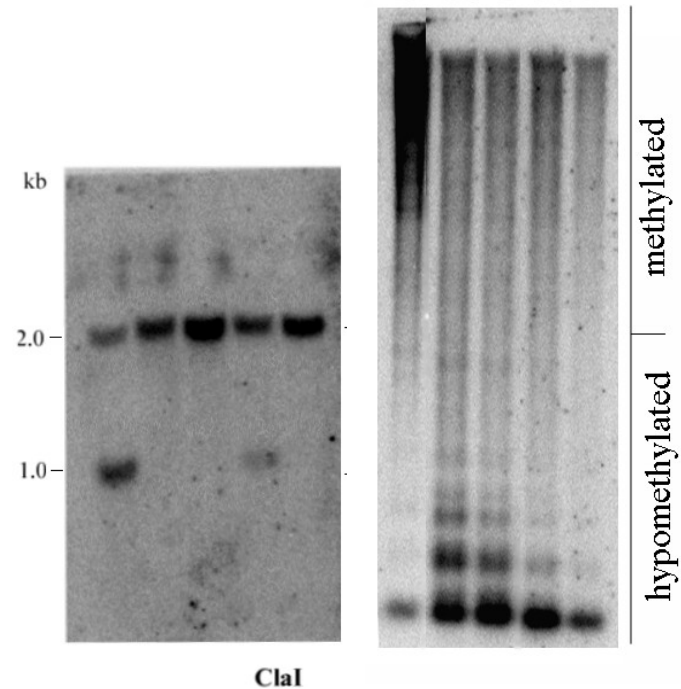

# DNA POLYMERASES

## *E. coli* DNA polymerase I:

5'→3' polymerase

5'→3' exonuclease (degradation ahead)

3'→5' exonuclease (proofreading)

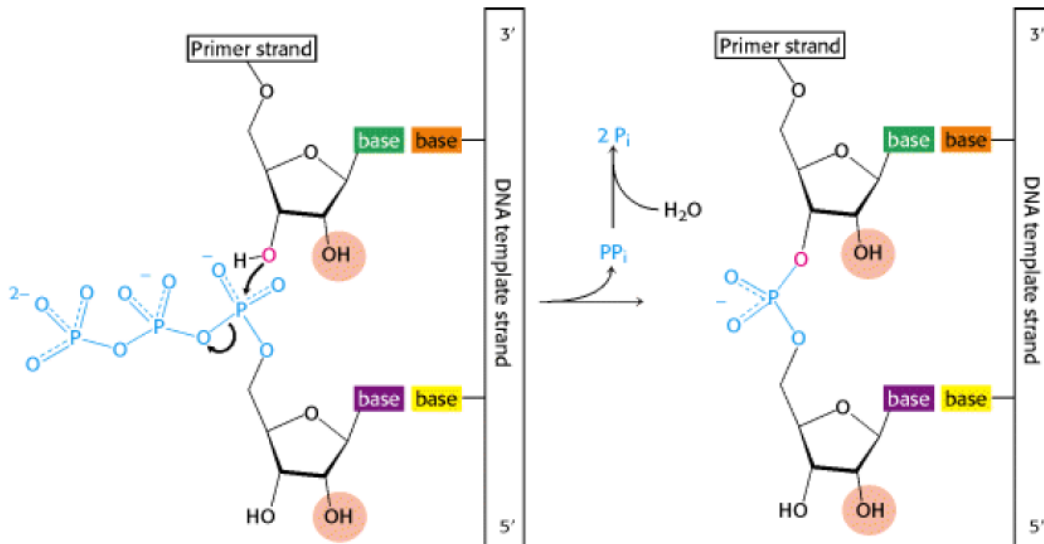
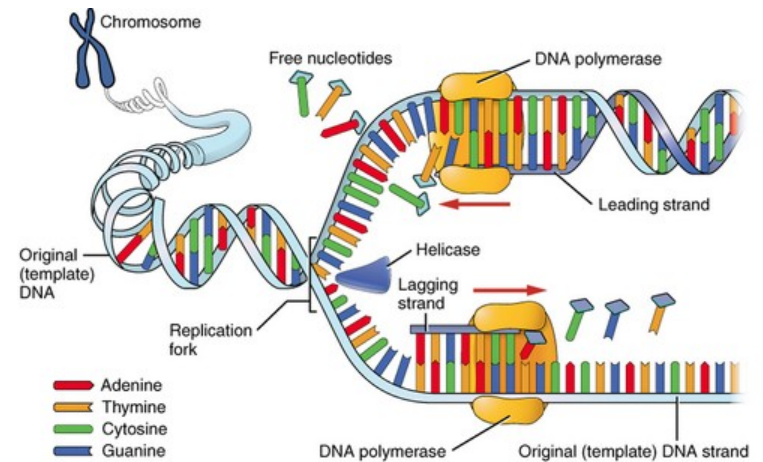

**Polymerization ALWAYS 5'→3'!**

Figure 5.25. Transcription Mechanism of the Chain-Elongation Reaction Catalyzed by RNA Polymerase.

# DNA POLYMERASES

Proofreading exonuclease activity  
(removal of misincorporated bases)

-labeling of 3'-ends

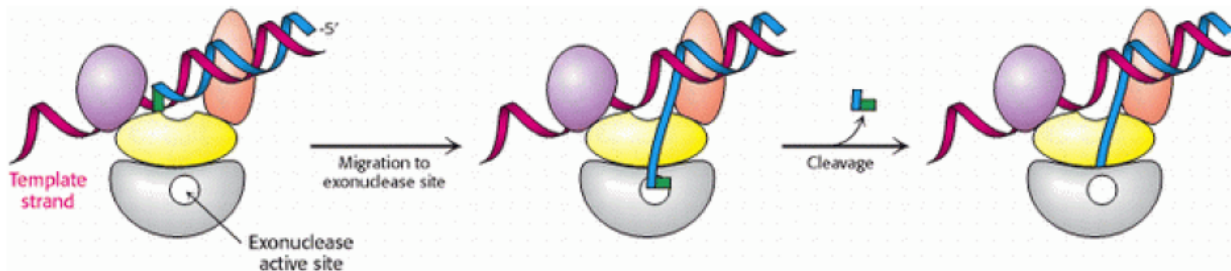
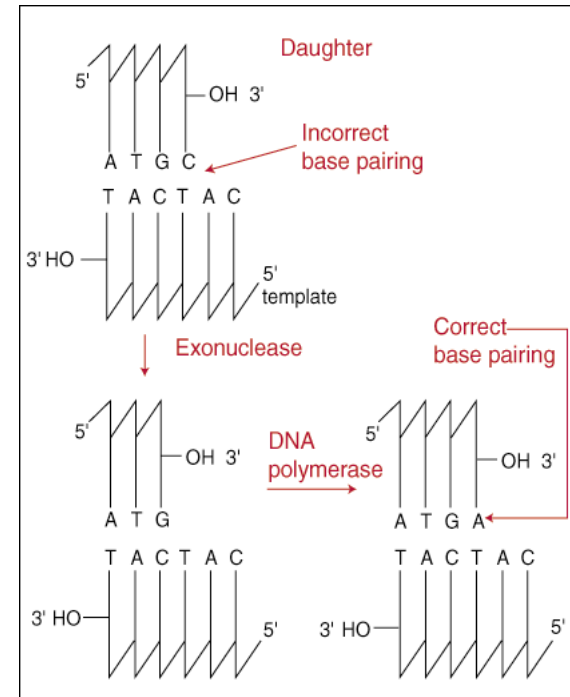

**Figure 27.15. Proofreading.** The growing polynucleotide chain occasionally leaves the polymerase site of DNA polymerase I and migrates to the exonuclease site. There, the last nucleotide added is removed by hydrolysis. Because mismatched bases are more likely to leave the polymerase site, this process serves to proofread the sequence of the DNA being synthesized.

# DNA POLYMERASES

5' → 3' exonuclease activity

## Nick Translation

- The nick translation process simultaneously:
  - Removes DNA ahead of a nick
  - Synthesizes DNA behind nick
  - Net result moves the nick in the 5' to 3' direction
- Enzyme often used is *E. coli* DNA polymerase I
  - Has 5' to 3' exonuclease activity
  - Allows enzyme to degrade DNA ahead of the nick

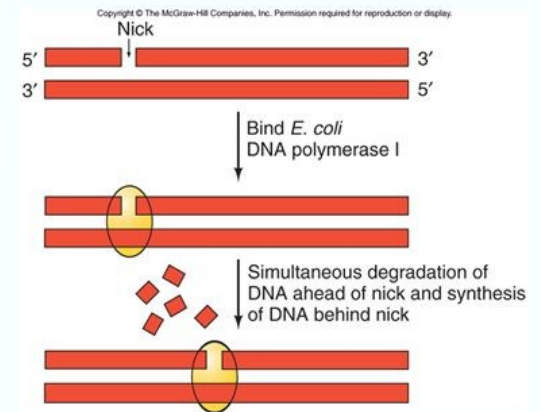



# DNA POLYMERASES

## Klenow fragment:

5' → 3' polymerase  
3' → 5' exonuklease

NO 5' → 3' exonuclease!!  
(small fragment)

„random priming“ DNA labeling

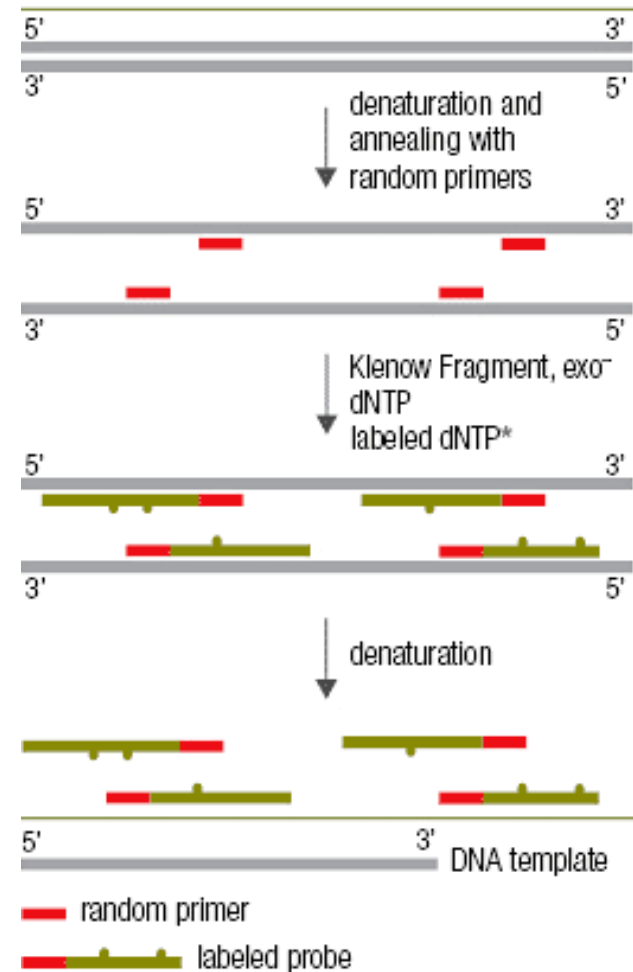

# Terminal (deoxy)nucleotidyl transferase

- statistical RNA/DNA polymerization without template
- transfers nucleotides from dNTP to free 3'-OH end
- selectivity control by metal ions: purine –  $Mg^{2+}$   
pyrimidine –  $Co^{2+}$
- 3'-OH overhangs (or ss NA) are preferred
- labeling of 3'-ends

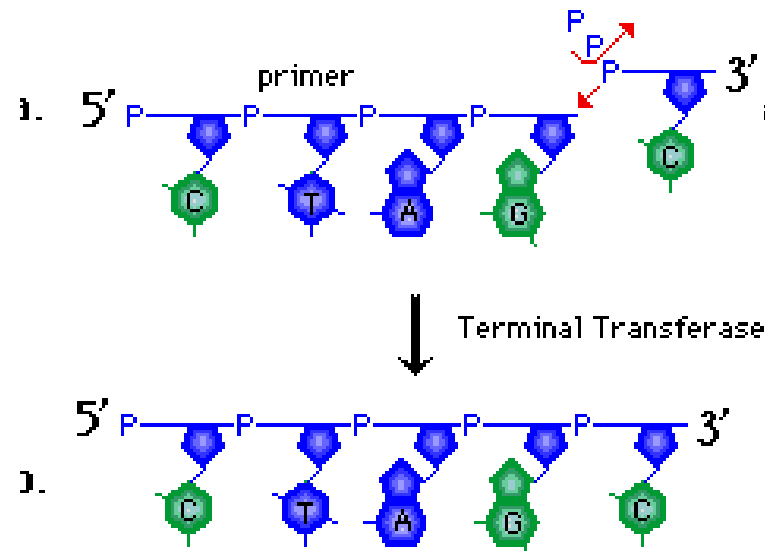

<http://bioweb.wku.edu/courses/biol350/RestrictionEnz3/Review.html>

## T4 polynucleotidyl kinase:

- transfer of  $\gamma$ -phosphate from ATP to 5'-OH end of DNA/RNA
- 5'-end labelling

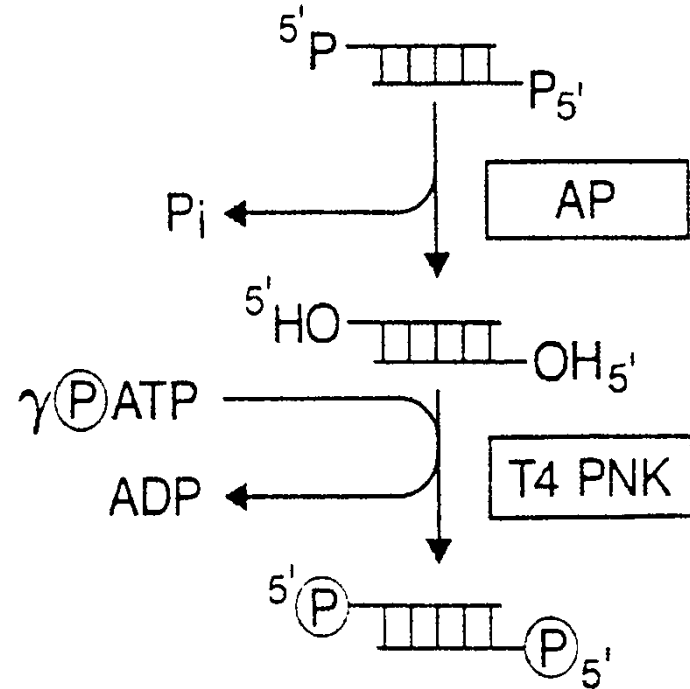
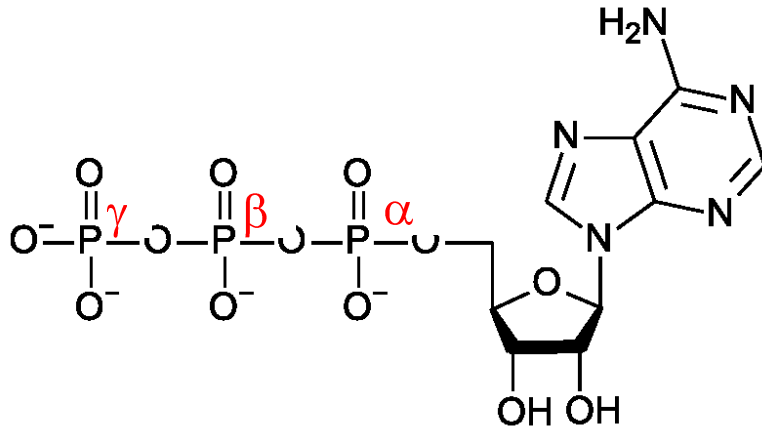

## Alkaline phosphatase (AP):

- 5'-phosphate removal  
(restrictases and other DNases produce 5'-phosphate)
- prevention of vector/insert self-ligation
- bacterial alkaline phosphatase (BAP)
- calf intestinal phosphatase (CIF)

# SUMMARY REMARKS TO DNA LABELING

- **5'-labeling: polynucleotidyl kinase + ATP** ( $\gamma$ -phosphate is used)
- $^{32}\text{P}$ ,  $^{33}\text{P}$ ,  $^{35}\text{S}$  (as thiophosphate); thiol-reactive labels

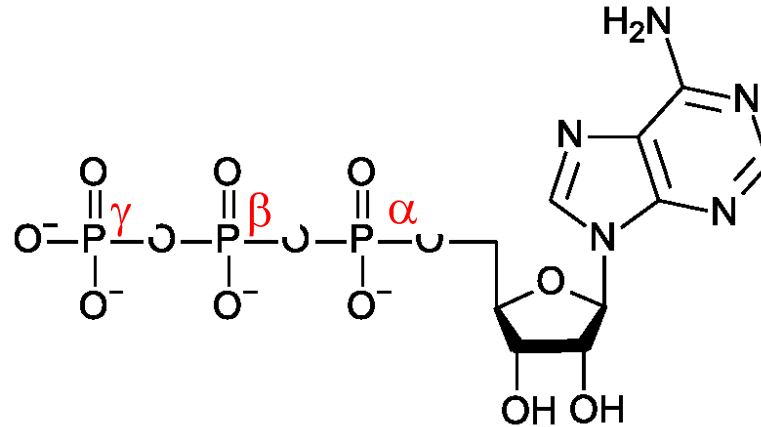

- **3'-end labeling: DNA-polymerases or terminal transferase(TnT, TdT)** (nucleotide including  $\alpha$ -phosphate is used)
- any labels attached to sugar or base
- nick translation, random priming, PCR

# DNA POLYMERASES

## Thermostable DNA polymerases:

Taq DNA polymerase (*Thermus aquaticus*)  
temperature optimum 72 – 80 °C

DyNAzyme, Vent, KOD... exo+/-....

fidelity *versus* speed *versus* tolerance to modifications

## Polymerase chain reaction - PCR

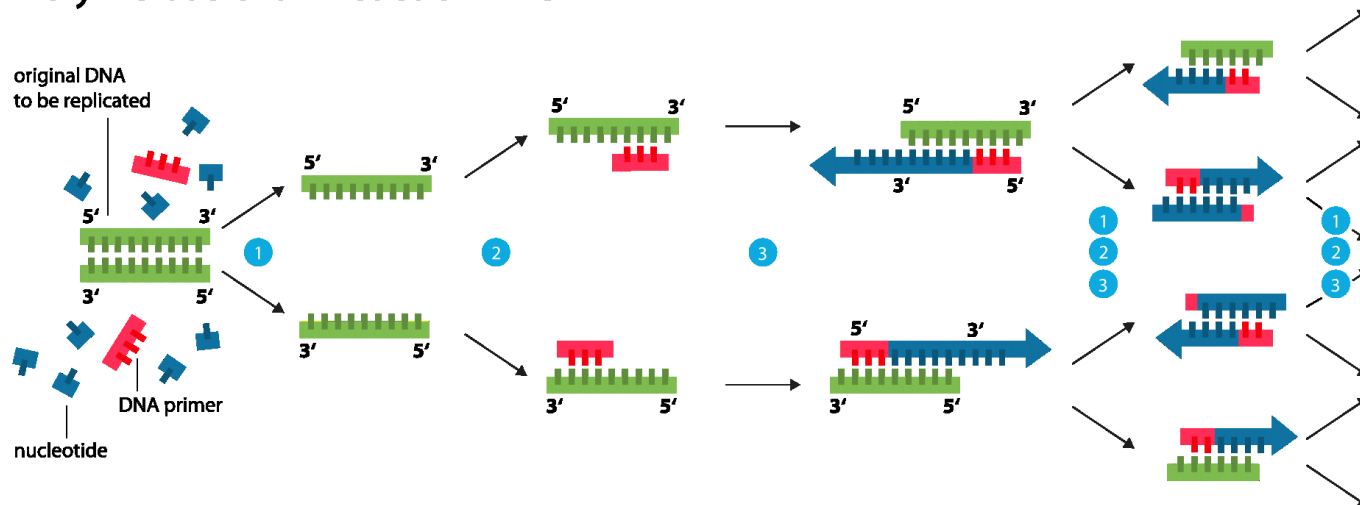

- 1 Denaturation at 94-96°C
- 2 Annealing at ~68°C
- 3 Elongation at ca. 72 °C

# Reverse transcriptase

RNA-dependent DNA polymerase

MuLV (Moloney murine leukemia virus) }  
AMV (avian myeloblastosis virus) } 37 – 42 C

„SuperScript“: higher temperatures  
no RNaseH activity

(RNaseH: exonucleolytic degradation of RNA strand in DNA/RNA hybrid)

RT-(q)PCR analysis of gene expression

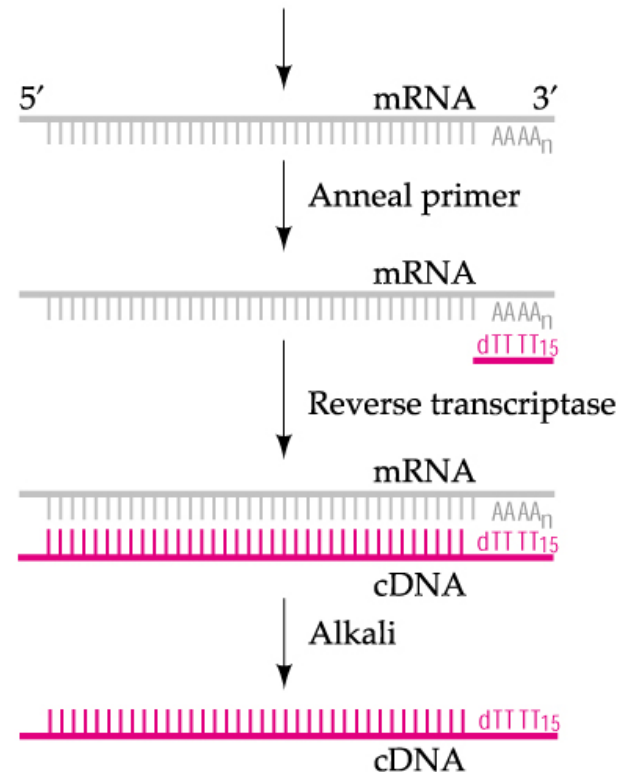

# DNA ligases

Bacteriophage T4 DNA ligase:  
 joining of sticky as well as blunt end  
 cofactor = ATP

E. coli DNA ligase:  
 joins sticky ends  
 bacterial ligases usually use NAD as the cofactor

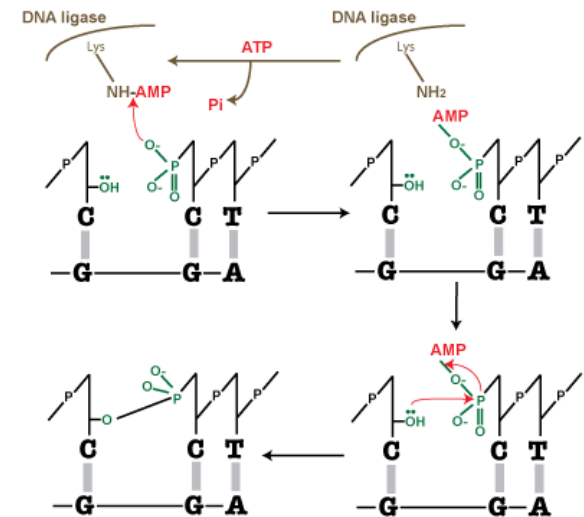
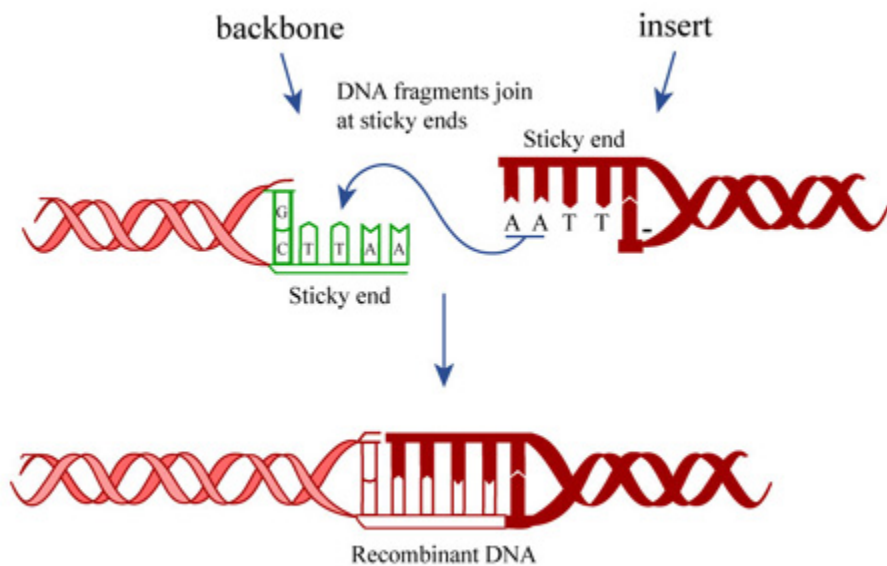
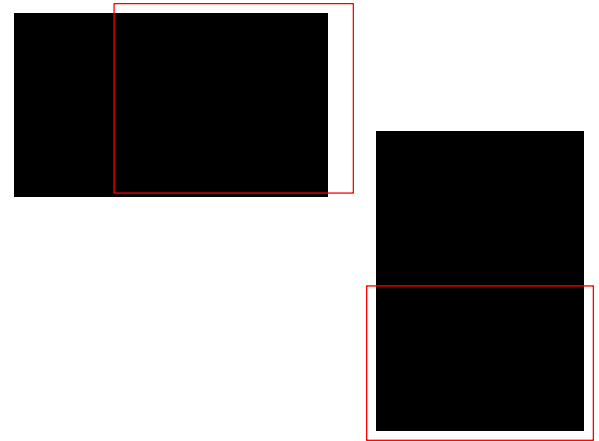

1. step: transfer of AMP to **5'-phospho**  
 DNA end (the intermediate involves a  
 diphosphate macroergic bond)

# SINGLE STRAND SELECTIVE NUCLEASES

In general: cleavage of both DNA and RNA

## Nuclease S1: endo- and exonuclease

acidic pH optimum (4.5),  $Zn^{2+}$  ions

-removal of ss overhangs, opening of hairpin loops

-open local structures

## Mung Bean Nuclease:

-similar to S1, milder conditions (less acidic)

## Nuclease P1:

-neutral pH optimum,  $Zn^{2+}$  ions

-ss-selective endonuclease + 3'phosphatase

- $^{32}P$  postlabeling analysis of DNA adducts

## Micrococcal nuclease (MNase)

-selective cleavage of untwisted DNA; AT-rich

-chromatin digestion to (oligo)nucleosomes

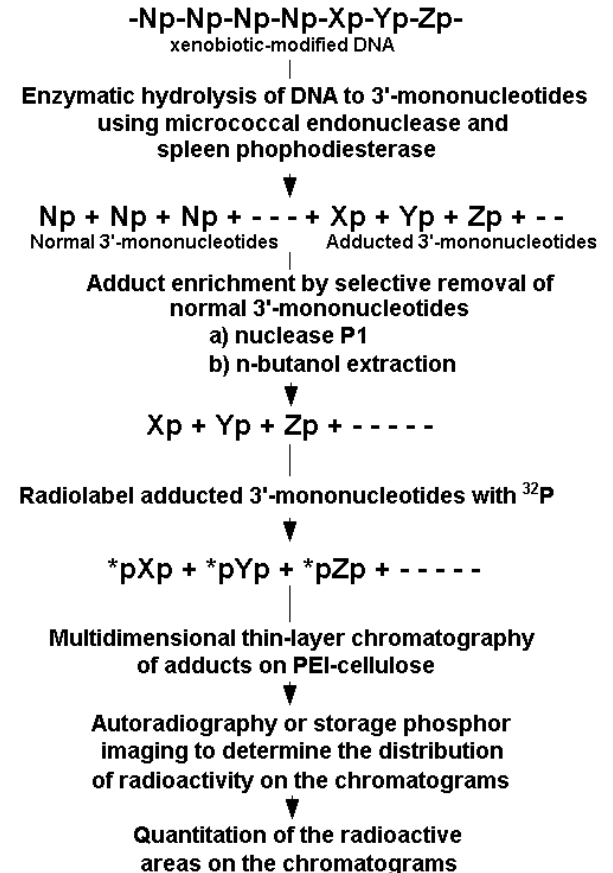



# SINGLE STRAND SELECTIVE NUCLEASES

In general: cleavage of both DNA and RNA

## Nuclease S1: endo- and exonuclease

acidic pH optimum (4.5),  $Zn^{2+}$  ions

- removal of ss overhangs, opening of hairpin loops
- open local structures

## Mung Bean Nuclease:

- similar to S1, milder conditions (less acidic)

## Nuclease P1:

- neutral pH optimum,  $Zn^{2+}$  ions
- ss-selective endonuclease + 3'phosphatase
- $^{32}P$  postlabeling analysis of DNA adducts

## Micrococcal nuclease (MNase)

- selective cleavage of untwisted DNA; AT-rich
- chromatin digestion to (oligo)nucleosomes

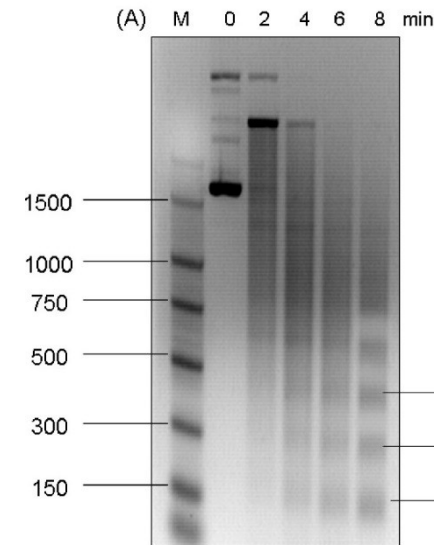
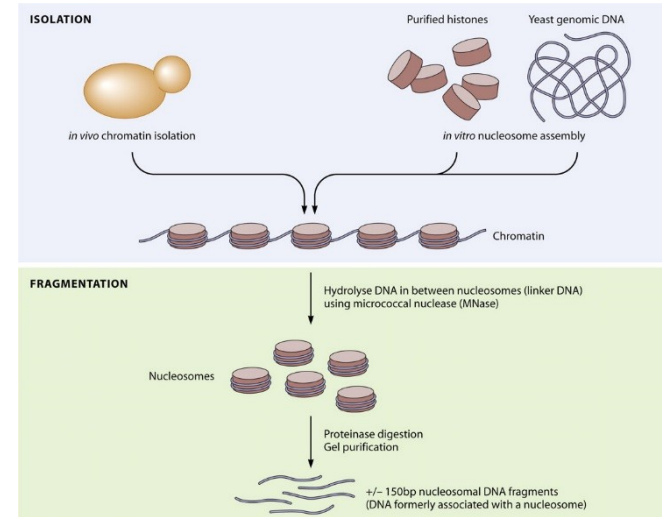

# Single-strand selective enzymes

- only detection of a open structure, not identification at the sequence level
- often sufficient: evidence of formation of a expected structure
- nucleases S1, P1, mung bean... cleave ss DNA (or RNA)
- scDNA cleaved by S1, then restriction cleavage to map S1 cleavage site

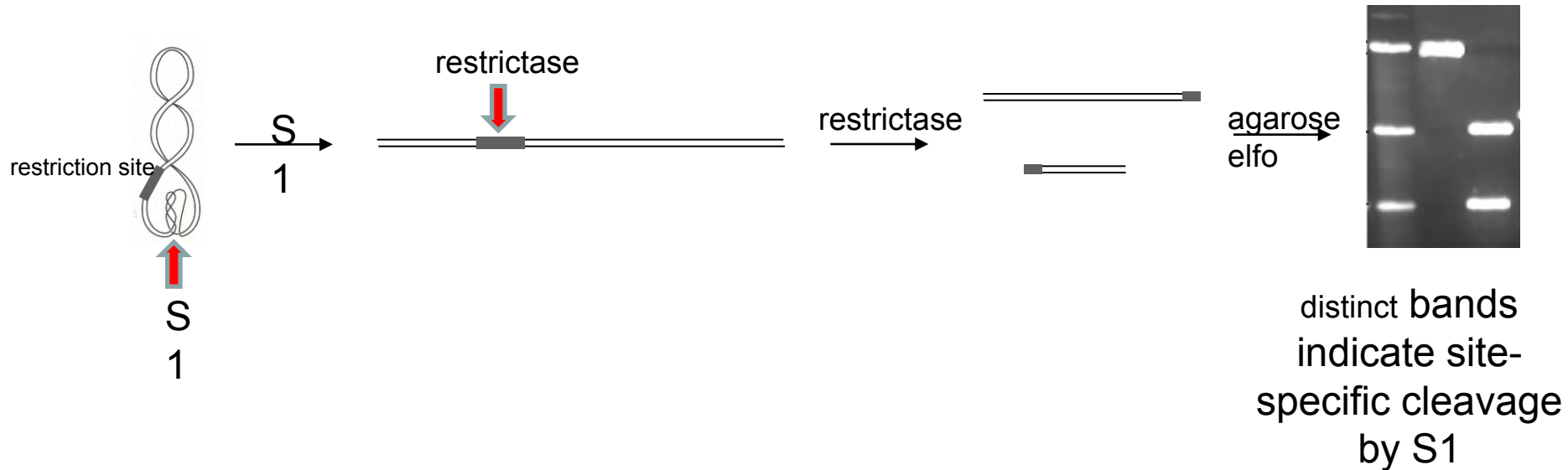

# Combination of chemical probes with S1 nuclease

- chemical probes work within wider range of conditions than enzymes
- modification of scDNA
- then restrictase cleavage
- chemical modification of bases in structure that existed in scDNA prevent formation of B-DNA
- then S1 cleavage in the modified site

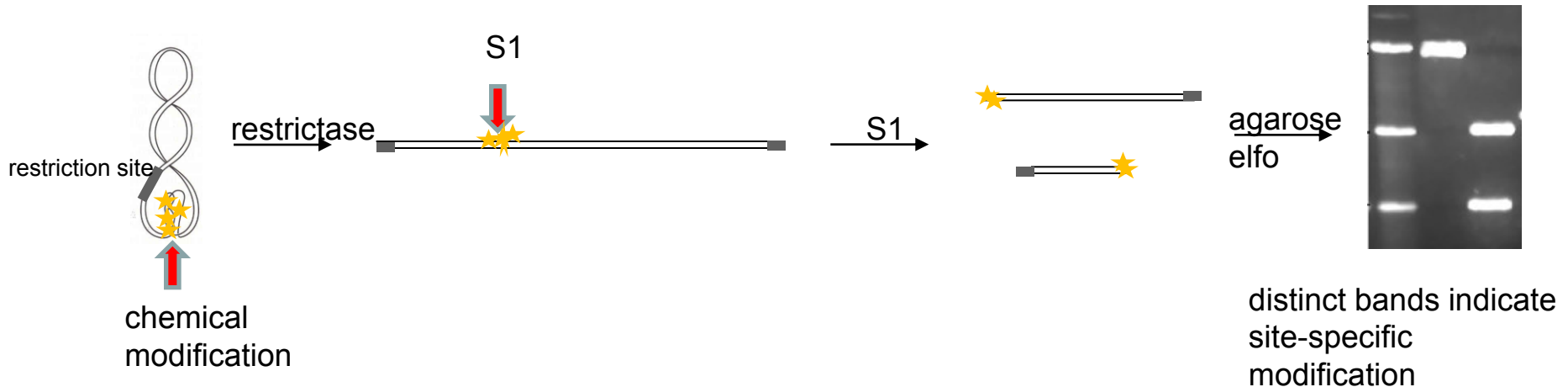

# NUCLEASES PROCESSING DNA ENDS

- Bal31 nuclease:** cleaves both 3' and 5' ends in dsDNA
- removal of ss overhangs, cleavage in nicks and gaps
  - shortens blunt-ended dsDNA
  - identification of terminal DNA sequences

- Exonuclease III:** degrades one strand in dsDNA (RNA strand in RN/DNA hybrid) from its 3'-terminus
- creates 5'-overhangs

- Lambda exonuclease:** degrades one strand in dsDNA from its 5'-terminus
- creates 3'-overhangs

(a) Bal31

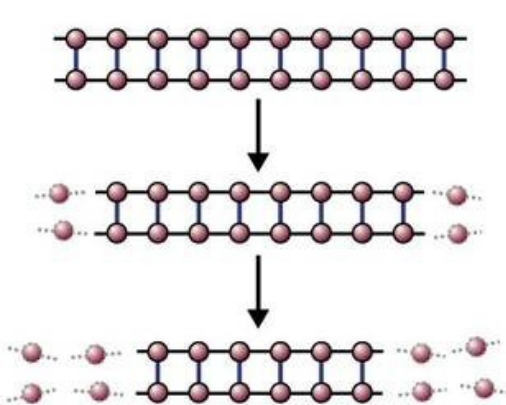

(b) Exonuclease III

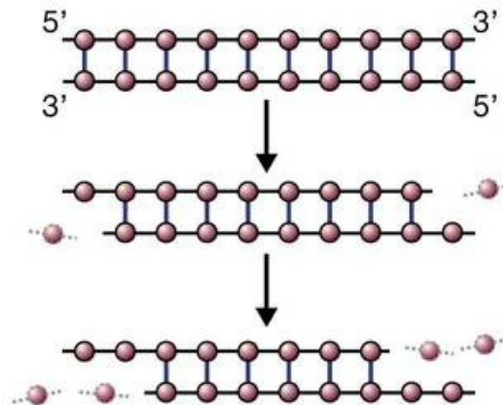

(c) Lambda-exonuclease

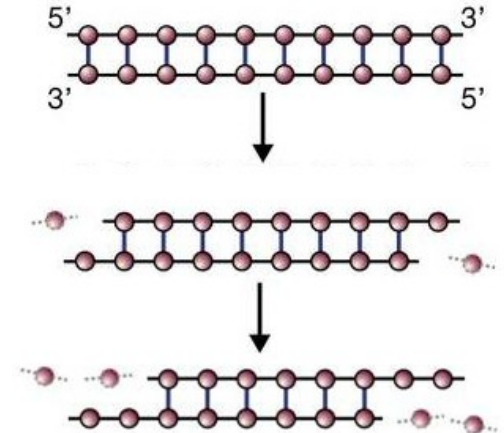

# PHOSPHODIESTERASES

## DNA/RNA exonucleases

### Phosphodiesterase I

from snake venom  
cleaves  $3' \rightarrow 5'$   
requires  $3'$ -OH  
produces  $5'$ -dNMP

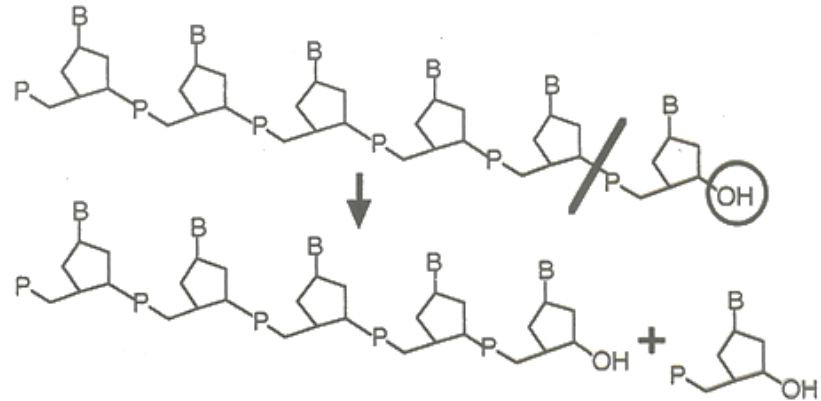

### Phosphodiesterase II

from spleen  
cleaves  $5' \rightarrow 3'$   
requires  $5'$ -OH  
produces  $3'$ -dNMP

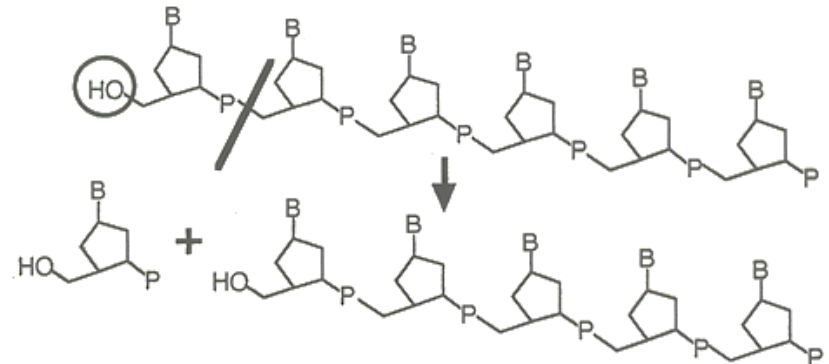

# RNase A:

endoribonuclease

cleaves preferentially ssRNA „after“ Py, produce 3'-phospho ends extremely stable, no cofactors, difficult to inactivate

DNA purification (RNA removal)

SNP mapping in DNA (RNase protection assay)

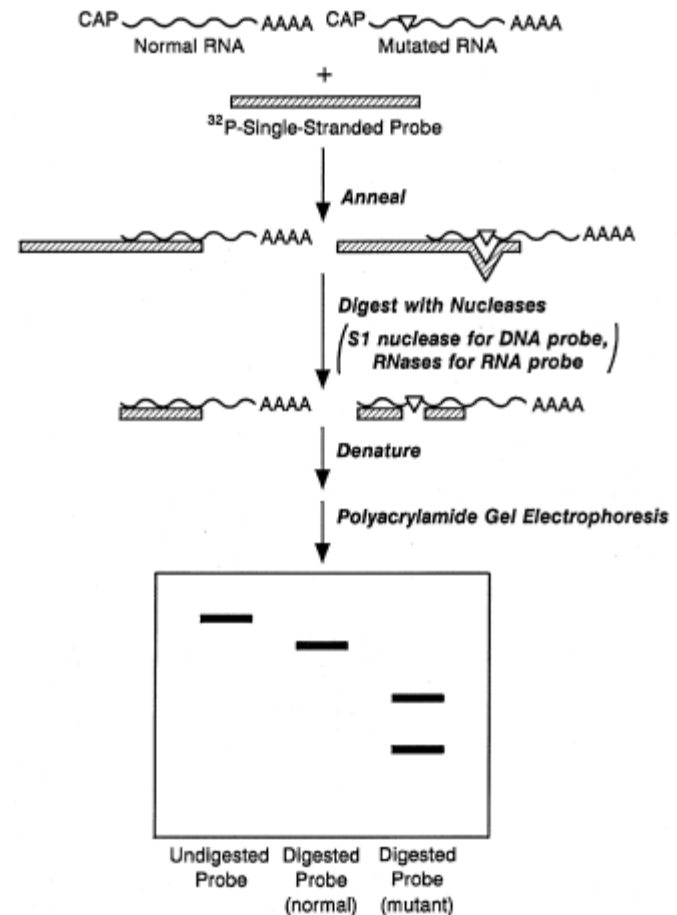
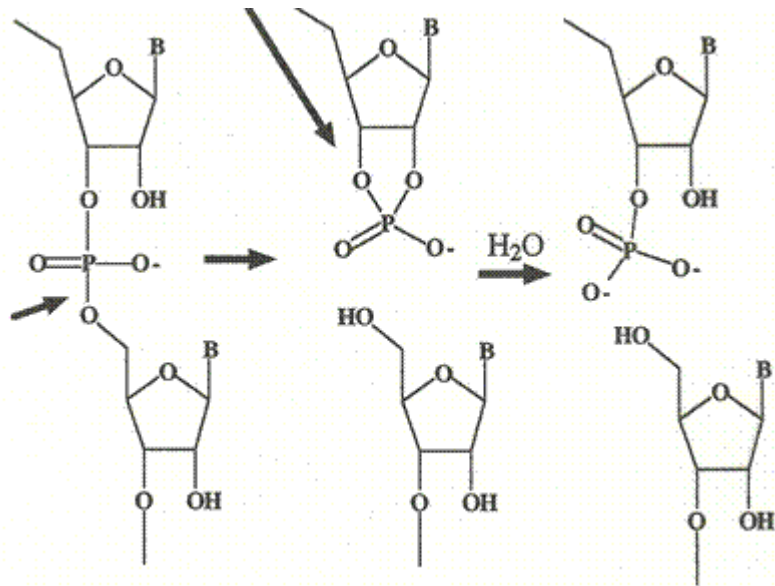

## DNase I: DNA endonuclease

cleavage of dsDNA or ssDNA to ~tetranucleotides

requires  $Mg^{2+}$  (inhibition by EDTA), neutral pH optimum

reductive inactivation (-S-S- bond stabilize structure),  $Ca^{2+}$  protection

in dsDNA creates single-strand breaks, 5'-phospho ends

RNA purification (RNase-free!!), protein-DNA footprinting

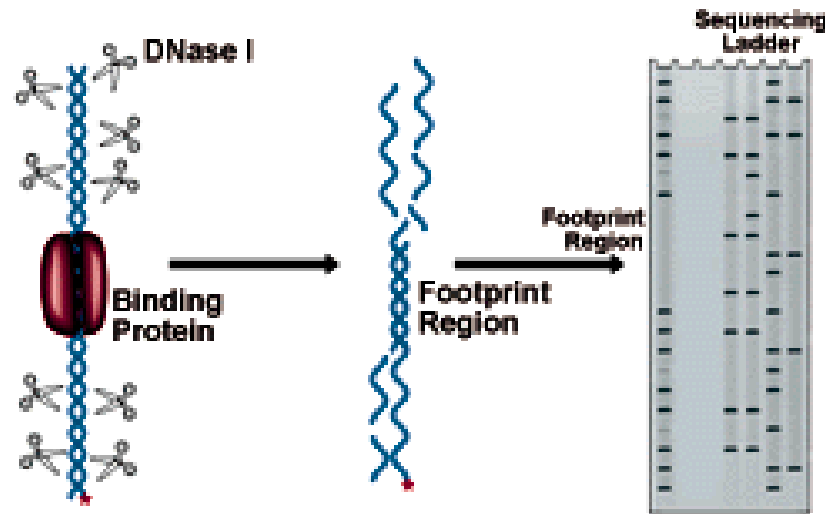

**DNase II:** double strand breaks, 3'-phospho ends, no cofactors, acidic pH optimum

# Polynucleotide phosphorylase

- random polymerization of ribonucleotides from NDPs
- RNA degradation by inorganic phosphate (not hydrolysis) into NDP
- reversible
- polyribonucleotide biosynthesis
- used during genetic code solution

Phosphorylase does not phosphorylate!

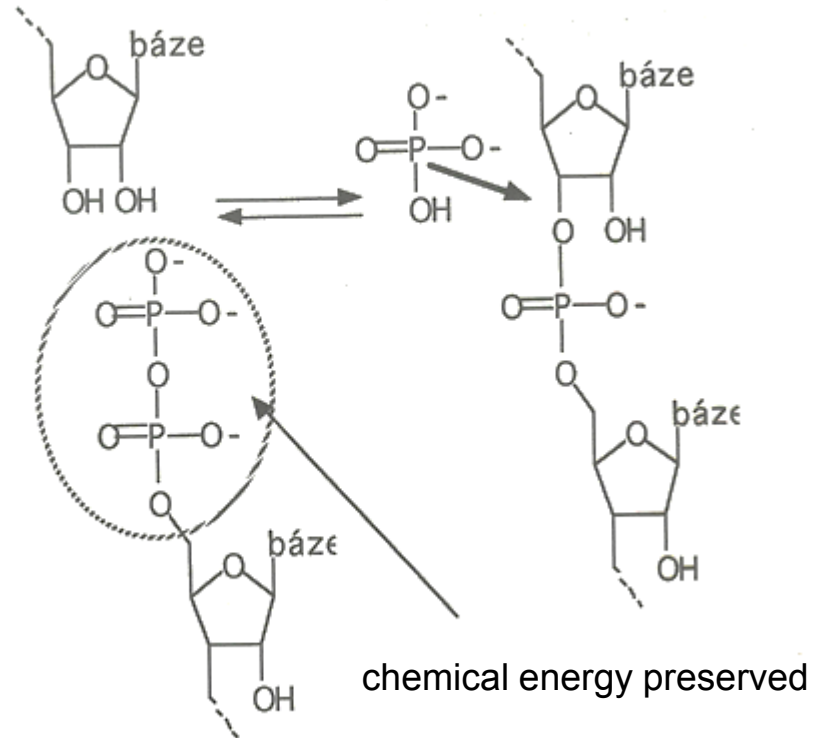



# Engineered nucleases for genome editing

# ZNF, TALEN

-constructs of a nuclease (fok I) with DNA binding domains (addressing cleavage to a specific sequence)

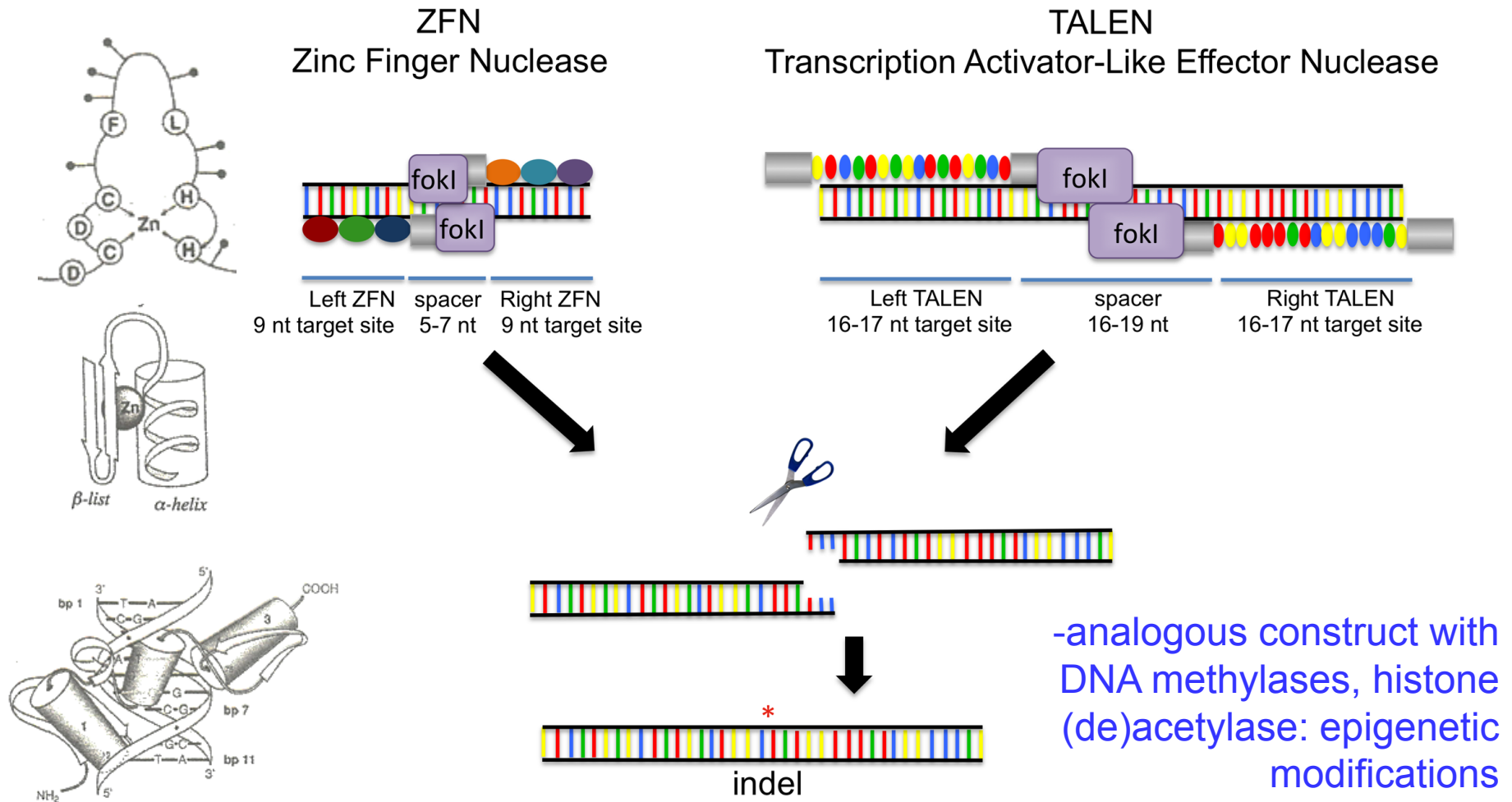

# CRISPP

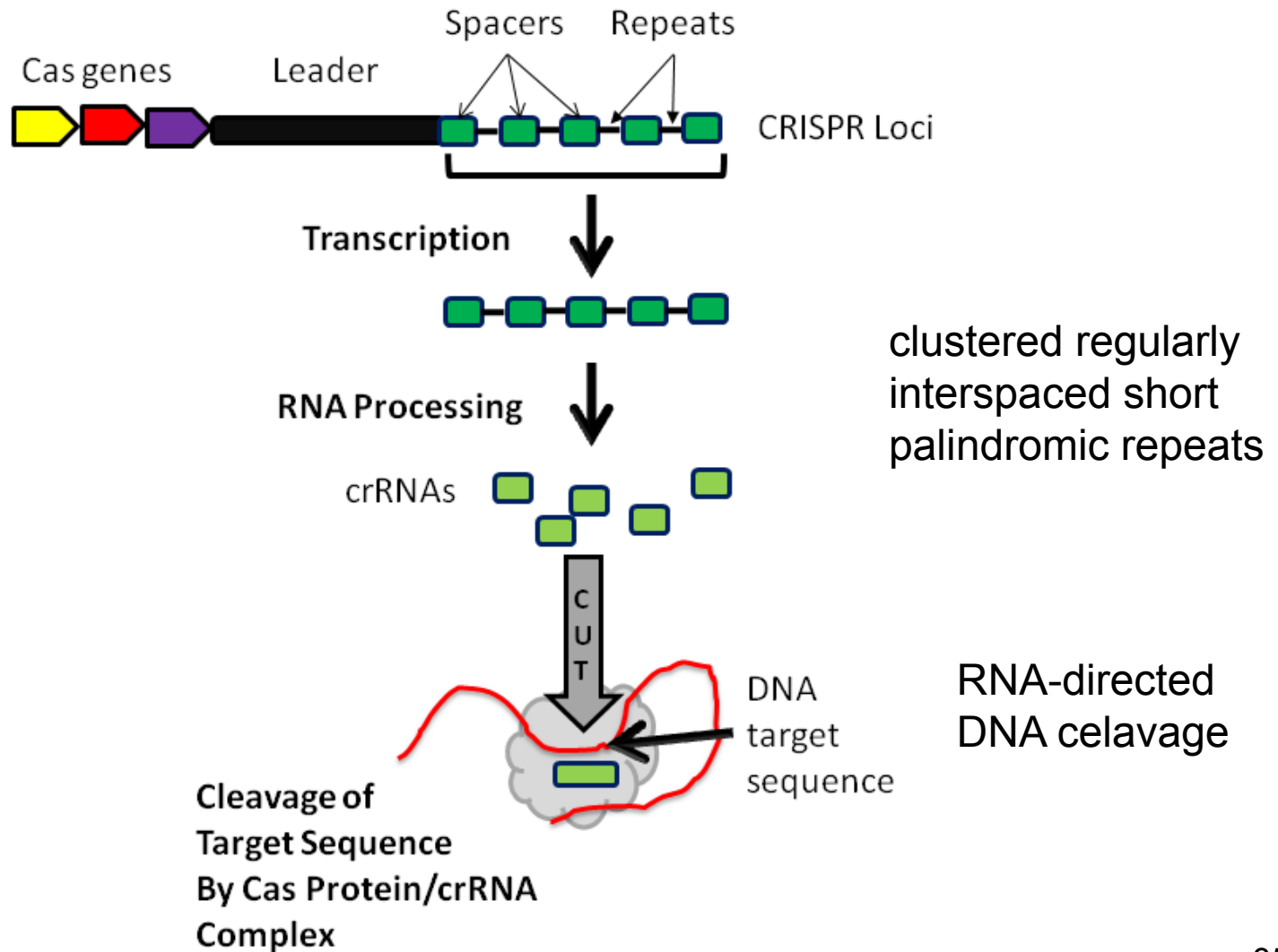

# Modifications of genomes

Repair of the (ZNF, TALEN, CRISPR-induced) double strand breaks via NHJ or HR:

-insertions, deletions – gene inactivation

-inversions

-transgene insertions, modifications of genes (precise by HR)

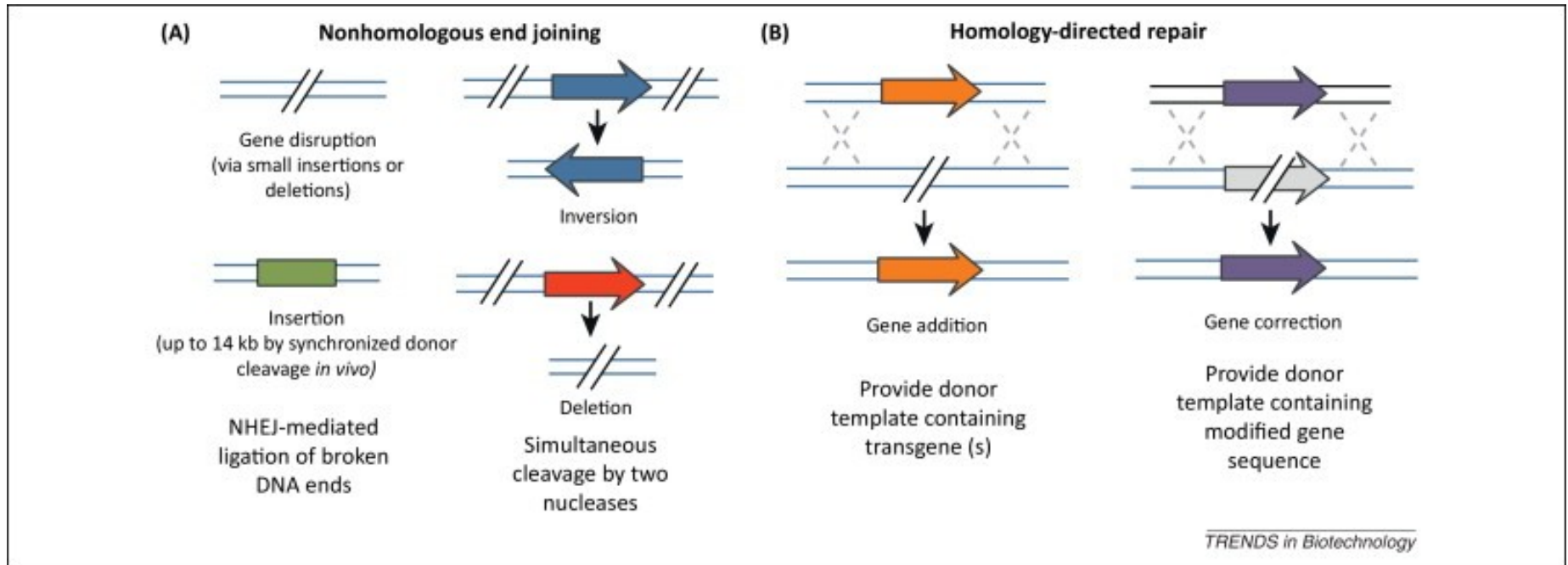

Gaj et al. Trends Biotechnol 2013



<http://worldofbiochemistry.blogspot.cz/2011/08/cartoon-about-cloning-2.html>