

MAE 212: Spring 2001

Lecture 14

PHASE DIAGRAMS AND EQUILIBRIUM MICROSTRUCTURES

N. Zabaras

For more details on the topic read Chapter 9 of the *Materials Science for Engineers* by J. Shackelford, pp. 304–353. Also you are strongly encouraged to read the Appendix on *Teaching Yourself Phase Diagrams* from the *Mechanics of Materials II* of Ashby and Jones. Both books are on reserve for MAE212 in the Engr. library.

Phase diagrams provide a graphical representation at equilibrium of the structure of an alloy or ceramic. They tell us what microstructure should exist at a given temperature and composition. Equilibrium structures give a base line from which non-equilibrium structures can be inferred.

We will begin with some definitions.

Alloys: A *metallic alloy* is a mixture of a metal with other metals or non-metals.

For example, Copper (Cu) and Zinc (Zn), when mixed, form the alloy *brass*. Magnesia (MgO) and alumina (Al₂O₃) when mixed in equal proportion form *spinel*. Iron (Fe) and carbon (C) mix to give *carbon steel*.

Components: *The alloy components* are the chemical elements which make up the alloy. Alloys are usually made by melting together and mixing the components.

For example, in *brass* the components are Cu and Zn. In *carbon steel* the components are Fe and C. In *spinel*, they are Mg, Al and O.

Binary alloy: A binary alloy contains two components. Most of the discussion here is about binary alloys.

Tertiary alloy: A tertiary alloy contains three components, etc.

Concentration: An alloy is described by stating the components and their concentrations.

The weight % of component A in a binary alloy consisting of elements A and B is defined as follows:

$$W_A = \frac{\text{weight of component A}}{\sum \text{weights of all components}} \times 100 \quad (1)$$

The atom (or mol) % of component A can also be introduced:

$$X_A = \frac{\text{number of atoms (or mols) of component A}}{\sum \text{number of atoms (or mols) of all components}} \times 100 \quad (2)$$

Note that from X_A and X_B , one can calculate W_A and W_B and the reverse. Recall that:
(Weight in g) / (atomic or molecular wt in g/mol) = number of mols.

Based on this transformation, try to show that

$$\begin{aligned} W_A &= \frac{X_A a_A}{X_A a_A + X_B a_B} \\ W_B &= \frac{X_B a_B}{X_A a_A + X_B a_B} \end{aligned} \quad (3)$$

where a_A and a_B are the atomic weights of A and B.

Note that in many books, the concentration (composition) is simply denoted as C or c . You always need to pay attention if this is a weight-based concentration or mole-based.

Structure: Alloys are usually made by melting the components and mixing them together while liquid. A binary alloy can take one of following forms:

- a single solid solution;
- two separated, essentially pure, components;
- two separated solid solutions;
- a chemical compound, together with a solid solution.

Later we will present examples of each of the above structures. The specific form of the microstructure present is decided by examining a flat surface of the alloys that has been polished and etched.

Phases: Phase is the part of an alloy with the same physical and chemical properties and the same composition. Phase must be distinguished from component, which is a distinct chemical substance from which the phase is formed.

For example, water is one phase, but water mixed with ice is two phases. The Al-Si, Cd-Zn and Al-Cu alloys are all made up of two phases.

The Constitution of an Alloy: The *constitution* of an alloy is described by:

- The phases present.
- The weight percentage of each phase.
- The composition of each phase.

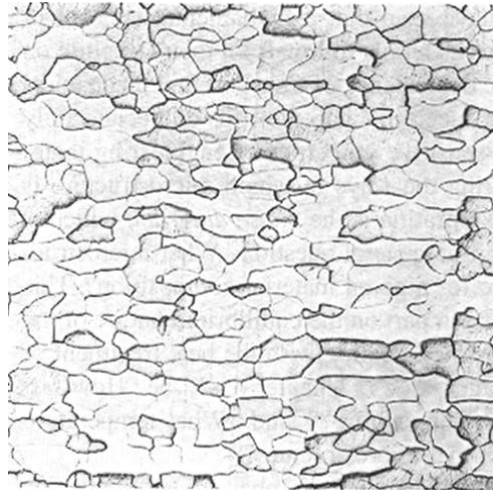

FIGURE 5-1

Figure 1: Single phase microstructure of commercially pure molybdenum. Although there are many grains in this microstructure, each grain has the same, uniform composition (From J. Shackelford, *Materials Science for Engineers*).

The properties of an alloy depend critically on its constitution and on two further features of its structure: the *scale* (nm or μm or mm) and *shape* (round, or rod-like, or plate-like) of the phases. The constitution, and the scale and shape of the phases, depend on the thermal treatment that the material has had.

As a first example, Figure 1 presents the single phase microstructure of pure molybdenum. Note that a single phase can be polycrystalline, but each grain differs only in orientation, not in chemical composition.

Cu and Ni are very similar in nature and they are completely soluble in each other in all proportions. For such alloys, there is a single phase (a solid solution).

When the solid solubility is limited, two phases are formed, each richer in a different component. An example is the pearlite shown in Fig. 2. Pearlite consists of alternating layers of ferrite and cementite. The cementite is nearly pure Fe_3C , while the ferrite is $\alpha - Fe$ with a small amount of cementite in solid solution. The components of pearlite are then Fe and Fe_3C .

Equilibrium Constitution: A sample has its *equilibrium constitution* when, at a given, constant temperature T and pressure p , there is no further tendency for its constitution to change with time. This constitution is the stable one.

State Variables: Are the independent variables over which we have control in establishing microstructures. The *constitution variables* or *state variables* are T , p and the composition.

For example, a pure metal at its melting point has two phases (the solid and liquid) at equilibrium. For a given pressure, any increase or decrease of the temperature will result in

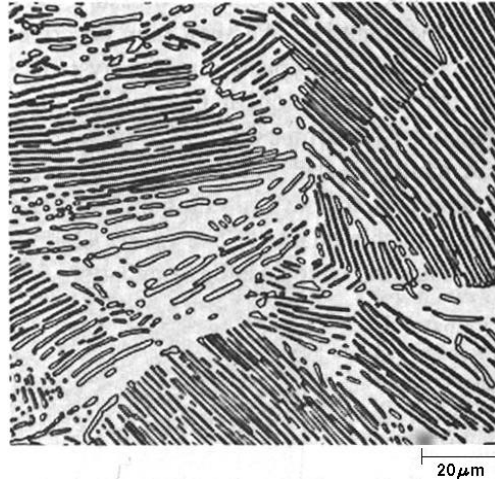

FIGURE 5-2

Figure 2: Two phase microstructure of pearlite found in steel with 0.8 wt % C. This carbon content is an average of the carbon content in each of the alternating layers of ferrite (with < 0.02 wt % C) and cementite (a compound, Fe_3C , which contains 6.7 wt % C). (From J. Shackelford, *Materials Science for Engineers*).

change of the microstructure (e.g. higher T will melt the solid phase, etc.). So, a pure metal at its melting temperature has no degrees of freedom.

Certain thermodynamic relations exist between the state variables. In general for a binary alloy we choose p, T , and X_B as the *independent variables* – though here we will drop p . The volume V and the composition $X_A (= 1 - X_B)$ are then determined: they are the *dependent variables*. Of course, the weight percentages W_A and W_B can be used instead.

For demonstration, let us consider the Al-Cu alloy:

Values of the state variables	Equilibrium constitution
$\left. \begin{array}{l} (a) \ T = 500^\circ C \\ \quad p = 1 \text{ atm.} \\ \quad W_{Al} = 96\% \\ \quad W_{Cu} = 4\% \end{array} \right\}$	\rightarrow Single-phase solid solution of copper in aluminum
$\left. \begin{array}{l} (a) \ T = 20^\circ C \\ \quad p = 1 \text{ atm.} \\ \quad W_{Al} = 96\% \\ \quad W_{Cu} = 4\% \end{array} \right\}$	\rightarrow Two phases: Al containing 0.1 wt% Cu, and $CuAl_2$

(4)

The microstructures in the Cu-Al alloy above are *equilibrium* constitutions because they are the ones reached by very slow cooling; slow cooling gives time for equilibrium to be reached. An alloy has its equilibrium constitution when there is no further tendency for the constitution to change with time.

Gibb's Phase Rule: The number of phases P which coexist in equilibrium is given by the

phase rule

$$F = C - P + 2 \tag{5}$$

where C is the number of *components* and F is the number of free *independent state variables* or degrees of freedom of the system.

If the pressure p is held constant (as it usually is for solid systems) then the rule becomes

$$F = C - P + 1 \tag{6}$$

A one-component system ($C = 1$) has two independent state variables (T and p). At the triple point three phases (solid, liquid, vapor) coexist at equilibrium, so $P = 3$. From the phase rule $F = 0$ so that at the triple point, T and p are fixed – neither is free but both are uniquely determined. If T is free but p depends on T then $F = 1$ and $P = 2$ that is, two phases, solid and liquid, say, co-exist at equilibrium. If both p and T are free $F = 2$ and $P = 1$; only one phase exists at equilibrium.

The information obtained from Gibb’s rule is difficult to appreciate without the visual aid of *phase diagrams*. The equilibrium diagram or *phase diagram* summarizes the equilibrium constitution of the alloy system.

Phase diagram example for one component system: As a simple example, the one-component phase diagram of H_2O is given in Fig. 3, while the one-component phase diagram of pure iron is given in 4. The equilibrium constitution of a one-component system is fixed by the variables p and T and so the equilibrium phases can be shown on a diagram with p and T axes. The one shown in Fig. 3 has only one solid phase, while pure iron in Fig. 4 has several. Single-phase regions are *areas*. Two phases co-exist along *lines*. Three phases co-exist at a *point*: the triple point. The behavior at constant p is given by a vertical cut through the diagram. The solid *melts* at T_m and *vaporizes* at T_v . The phase diagram at constant pressure is a line (shown on the right) along which the span of stability of each phase is marked.

Equilibrium constitution (or phase) diagrams for binary alloys

If the pressure is held constant at 1 atm, then the independent variables which control the constitution of a binary alloy are T and X_B or W_B . An equilibrium-constitution diagram or *equilibrium diagram* or *phase diagram*, is a diagram with T and X_B (or W_B) as axes. It shows the results of experiments which measure the equilibrium constitution at each T and X_B (or W_B). The phase diagram shows the equilibrium constitution for all the binary alloys that can be made of A and B, in all possible proportions.

The constitution point: The state variables define a point on the diagram: the “constitution point.” If this point is given, then the equilibrium number of phases can be read off. So, too, can their composition and the quantity of each phase.

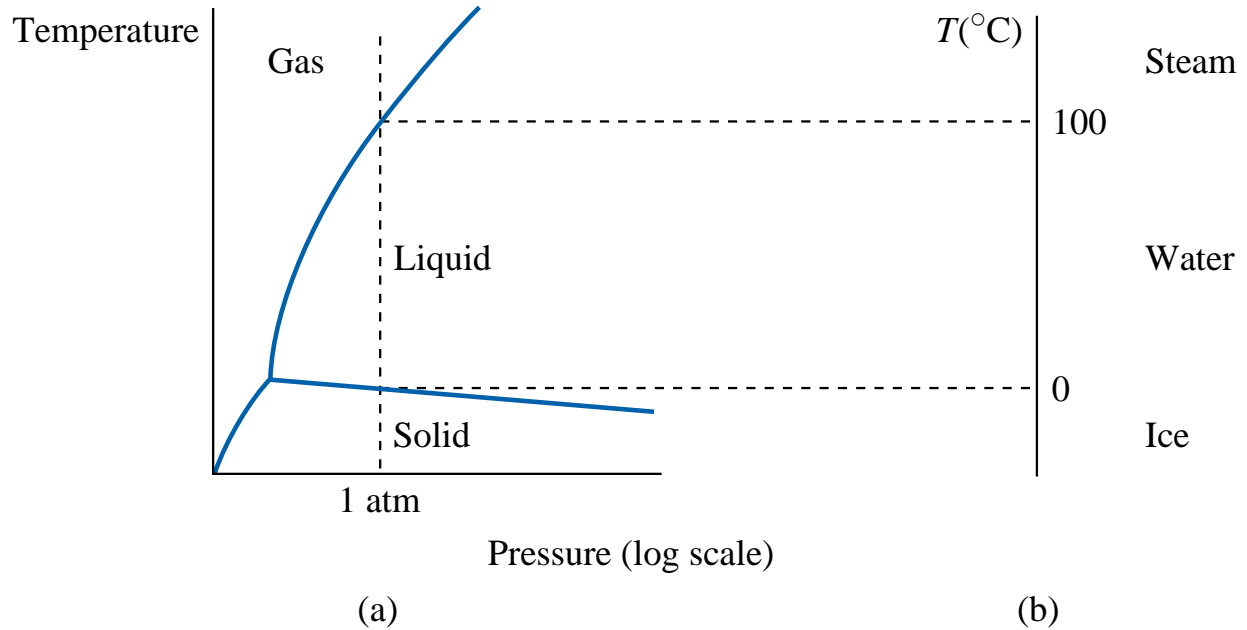

FIGURE 5-3

Figure 3: (a) Schematic representation of the one-component phase diagram for H_2O . (b) A projection of the phase diagram information at 1 atm generates a temperature scale labeled with the familiar transformation temperatures for H_2O (melting point at $0^\circ C$ and boiling at $100^\circ C$).

The phase diagram for a binary alloy shows *single-phase fields* (e.g., liquid) and *two-phase fields*. The fields are separated by *phase boundaries*. When a phase boundary is crossed, a phase change starts, or finishes, or both.

NOTE 1: When the constitution point lies in a single-phase region, the alloy consists of a single, homogeneous, phase. Its composition must (obviously) be that of the alloy. The *phase composition* and the *alloy composition* coincide in single-phase fields.

NOTE 2: When the constitution point for an alloy lies in the two-phase field the alloy breaks up into a mixture of two phases. The composition of each phase is obtained by constructing the *tie line* (the isotherm spanning the two-phase region, terminating at the nearest phase boundary on either side). The *composition of each phase* is defined by the ends of the tie line.

We will now discuss in detail some of the above definitions using several phase diagrams for the A-B alloy. The implications of Notes 1 and 2 will become clear through the following examples.

Phase diagram example for a binary alloy with a complete solid solution: The simplest phase diagrams are those associated with binary alloys in which the two components are completely

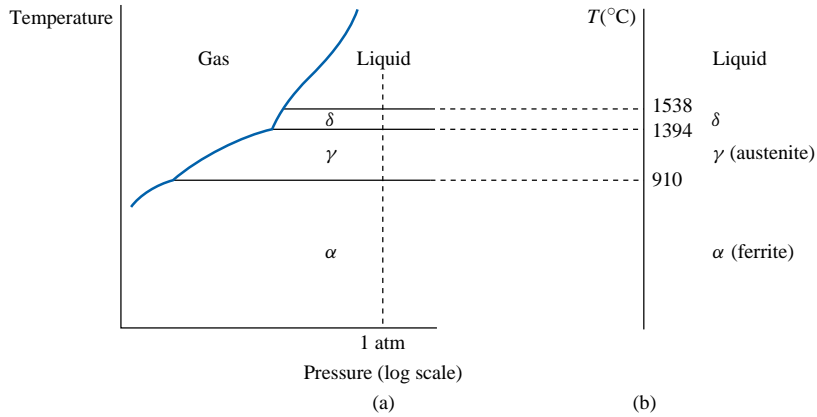

FIGURE 5-4

Figure 4: (a) Schematic representation of the one-component phase diagram for pure iron. (b) A projection of the phase diagram information at 1 atm generates a temperature scale labeled with important transformation temperatures for iron.

soluble to each other in both the solid and the liquid states (e.g. the Cu-Ni alloy). Figure 5 shows such a phase diagram for an alloy consisting of components A and B. Pay close attention to the details of this diagram. Between the two single phases (the liquid phase L and the solid phase SS), there is a two phase mixture labeled L + SS. The phase boundary which limits the bottom of the liquid field is called the *liquidus line*. The other boundary of the two-phase liquid-solid field is called the *solidus line*.

Figure 6 explains how to calculate the composition at a state point (i.e. at a given temperature and composition) within the two-phase region. Note that at such a point, an A-rich liquid exists in equilibrium with a B-rich solid solution. The horizontal line connecting the two-phase compositions at the system temperature is the tie line. The composition of each phase is defined by the end points of this line.

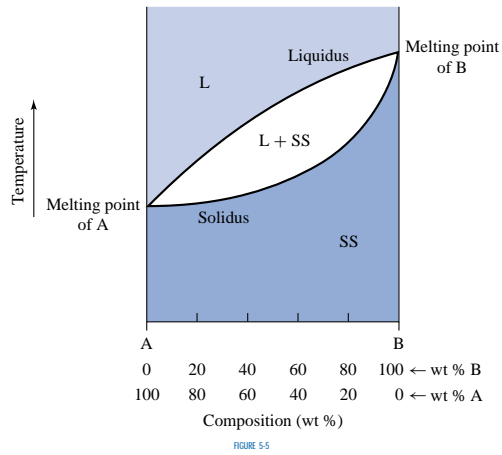

Figure 5: Binary phase diagram showing complete solid solution. The liquid-phase field is labeled L and the solid solution is designed SS. Note the two-phase region labeled L + SS (From J. Shackelford, *Materials Science for Engineers*).

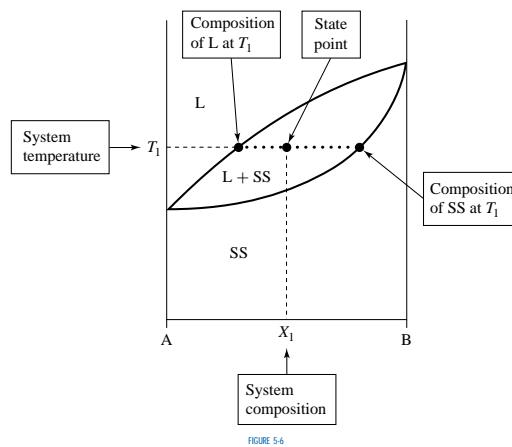

Figure 6: The compositions of the phases in a two-phase region of the phase diagram designed by a tie line (From J. Shackelford, *Materials Science for Engineers*).

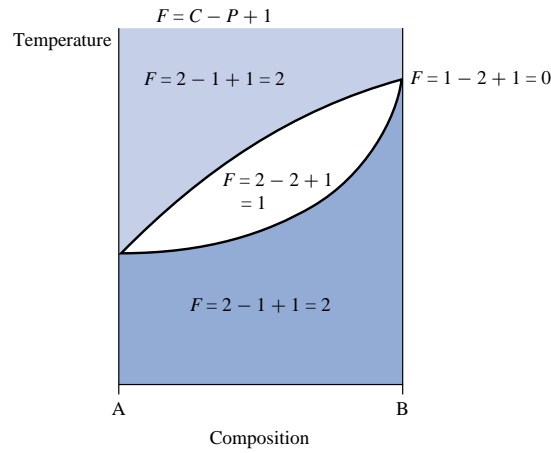

FIGURE 5-7

Figure 7: Application of Gibbs phase rule to various points in the phase diagram of Fig. 5 (From J. Shackelford, *Materials Science for Engineers*).

Figure 7 shows the application of the Gibbs rule to the above phase diagram. For example, within the two phase region ($P = 2$) of the binary alloy A-B ($C = 2$), there are $F = C - P + 1 = 2 - 2 + 1 = 1$ independent variables. As such, changes in temperature are possible, however the resulting compositions are not independent and must be established by the tie line associated with a given temperature.

Finally, Fig. 8 summarizes the different microstructures obtained in the different regions of the phase diagram.

Eutectic diagram example for a binary alloy with no solid solution: We consider a binary alloy where the components A and B have negligible solubility in each other (see Fig. 9). At low temperatures there is a two phase region that consists of pure A and pure B. The solidus line is horizontal and the corresponding temperature is known as the eutectic temperature. The liquidus lines start from the melting points of the pure components. Almost always, alloying lowers the melting point, so the liquidus lines *descend* from the melting points of the pure components, forming a shallow V. The bottom point of the V formed by two liquidus lines is the *eutectic point*.

Note that the solid at the eutectic composition (Fig. 9) will melt completely at the eutectic temperature. For other compositions, complete melting will require heating to the liquidus line after passing the two-phase region $A + L$ (or $B + L$).

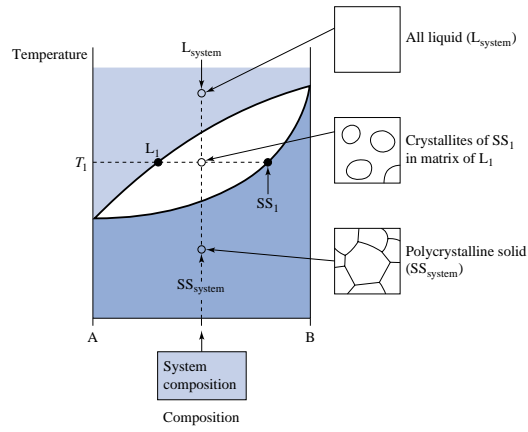

FIGURE 5-8

Figure 8: Various microstructures characteristic of different regions in the complete solid-solution phase diagram (From J. Shackelford, *Materials Science for Engineers*).

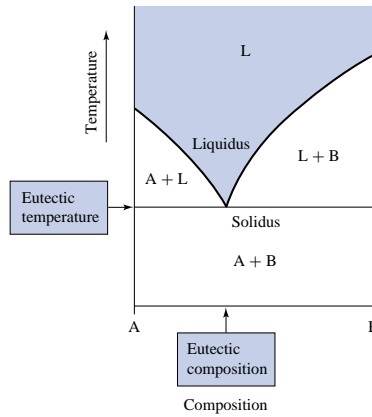

FIGURE 5-9

Figure 9: Binary eutectic phase diagram showing no solid solution. The general appearance can be contrasted to the opposite case of complete solid solution illustrated in Fig. 5 (From J. Shackelford, *Materials Science for Engineers*).

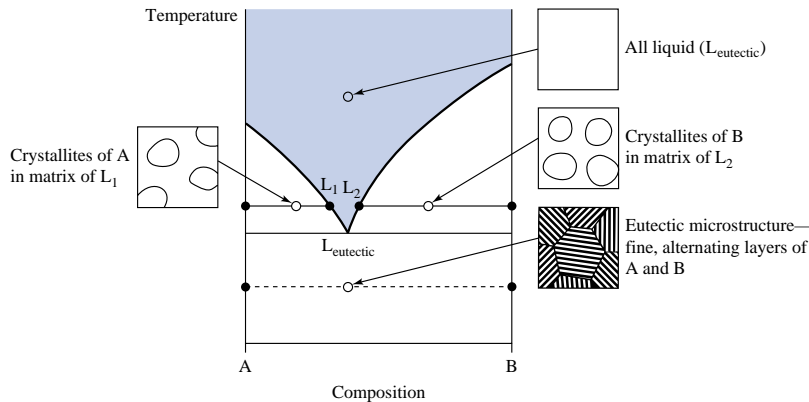

FIGURE 5-10

Figure 10: Various microstructures characteristic of different regions in a binary eutectic phase diagram with no solid solution (From J. Shackelford, *Materials Science for Engineers*).

Figure 10 shows the different microstructures. Note that the liquid and (solid+liquid) microstructures are similar in nature with those shown in Fig. 8. However, the solid microstructure (known as the eutectic structure) consists of fine-grained alternating layers of pure A and pure B.

Eutectic phase diagram example for a binary alloy with limited solid solution: Here A and B are partially soluble in each other. Figure 11 presents such a phase diagram. It is similar to that of Fig. 9 except for the solid solution regions α and β . The crystal structure of α will be that of A (α consists of B atoms in the lattice of A), while the crystal structure of β will be that of B (β consists of A atoms in the lattice of B).

Figure 12 shows the microstructures in the different regions of the phase diagram. Also, the tie lines needed to calculate the compositions of the different phases are shown as well.

The transformation of eutectic liquid to the fine grained microstructure upon cooling is called the eutectic reaction. It can be written as follows:



Example of the eutectoid phase diagram: In addition to the eutectic reaction, some phase diagrams contain the so called eutectoid reaction upon cooling. This reaction has the form:



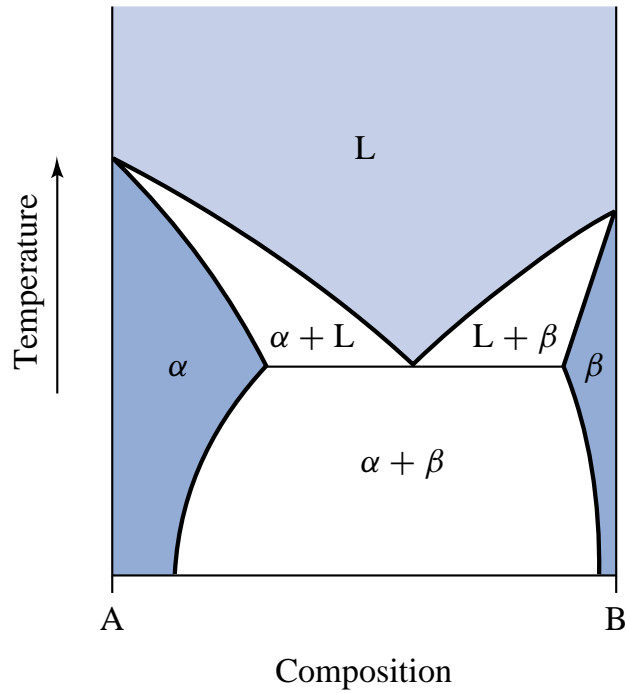

FIGURE 5-11

Figure 11: Binary eutectic phase diagram with limited solid solution. The only difference from Fig. 9 is the presence of solid-solutions α and β (From J. Shackelford, *Materials Science for Engineers*).

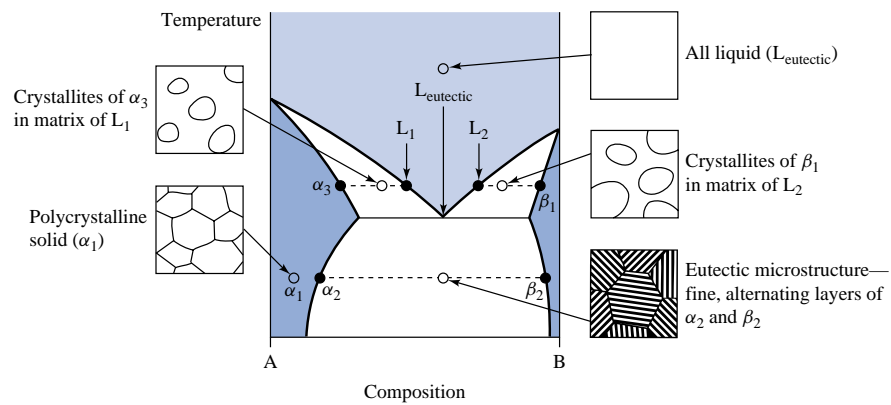

FIGURE 5-12

Figure 12: Various microstructures characteristic of different regions in the binary eutectic phase diagram with limited solid solution. This illustration is essentially equivalent to Fig. 10 except that the solid phases are now solid solutions (α and β) rather than pure components (A and B) (From J. Shackelford, *Materials Science for Engineers*).

Figure 13 presents the eutectoid phase diagram, while Fig. 14 presents the related microstructures. Note that both the eutectic and eutectoid (eutectic like) microstructures are fine-grained.

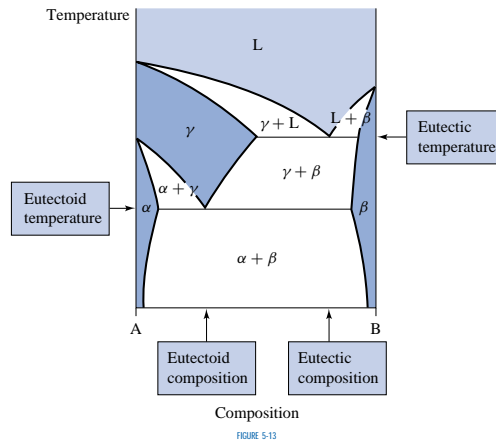

Figure 13: The eutectoid phase diagram contains both a eutectic reaction as well as a eutectoid reaction. (From J. Shackelford, *Materials Science for Engineers*).

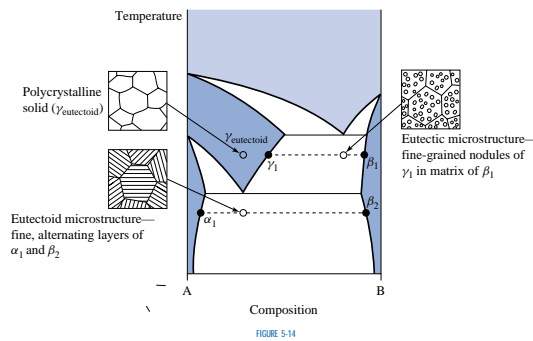

Figure 14: Microstructures in the different regions of the eutectoid phase diagram. (From J. Shackelford, *Materials Science for Engineers*).

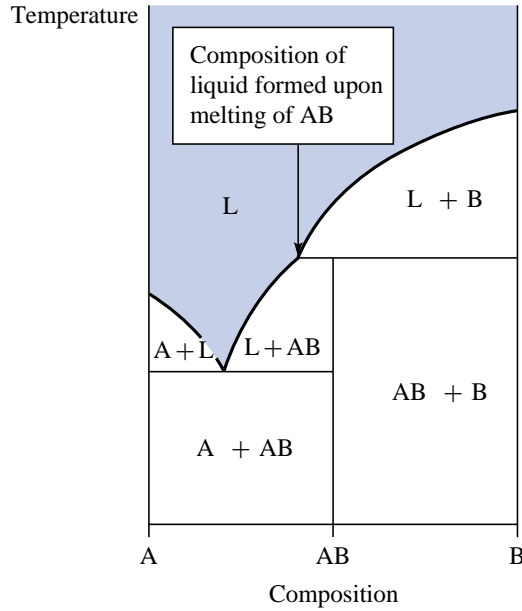
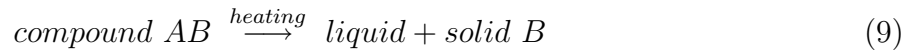

FIGURE 5-15

Figure 15: Peritectic phase diagram showing a peritectic reaction. For simplicity, no solid solution is shown (From J. Shackelford, *Materials Science for Engineers*).

Example of a peritectic phase diagram: Here we consider a binary alloy system in which A and B form a stable compound AB, which does not melt at a single temperature as do the components A and B. To simplify, we assume that there is no solid solution formed between the components and the intermediate compound. The peritectic reaction upon heating of AB is defined as follows:



where the liquid composition is defined in Fig. 15. The microstructures for this phase diagram are shown in Fig. 16. The liquid formed upon melting of the components has the same composition as the solid from which it was formed. On the other hand, the liquid formed by melting AB has composition other than that of AB.

The Lever Rule

You can get the *relative amounts* of each phase in a two-phase alloy microstructure from the phase diagram. Let us start with the familiar phase diagram given in Fig. 17. Let m_L be the mass of the liquid phase and m_{SS} the mass of the solid solution phase of the alloy. Also, let m_{total} be the total mass of the alloy. We consider the alloy here to have a wt % composition of 50%. Simple mass balance gives that:

$$m_L + m_{SS} = m_{total} \quad (10)$$

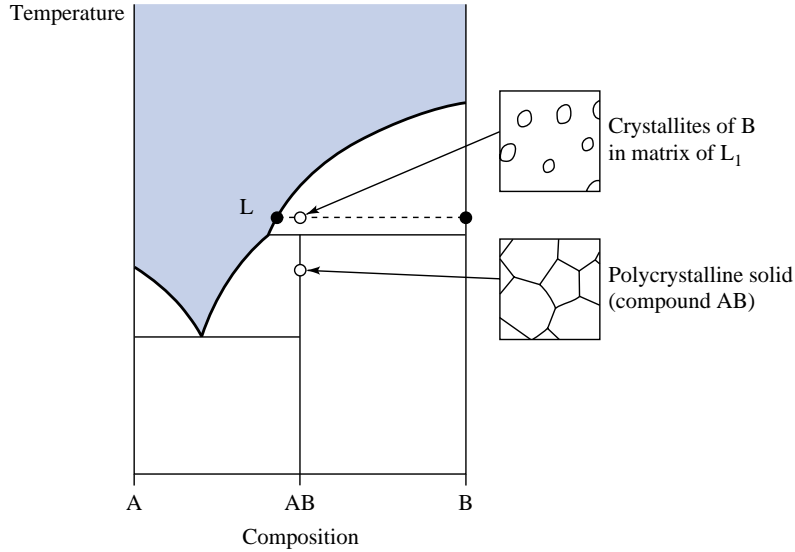

FIGURE 5-16

Figure 16: Microstructures for the peritectic diagram of Fig. 15 (From J. Shackelford, *Materials Science for Engineers*).

A mass balance tells us that the amount of B in the alloy is the sum of the amounts of B in the liquid and solid phases, i.e.

$$0.30m_L + 0.80m_{SS} = 0.50m_{total} \quad (11)$$

From the two equations above, we can show that $m_L = 0.6m_{total}$ and $m_{SS} = 0.4m_{total}$.

The above calculation can be easily generalized. Let x be the composition of the alloy and x_α and x_β the compositions of the two phases α and β at equilibrium (see Fig. 18(a)). The final results are as follows:

$$\frac{m_\alpha}{m_\alpha + m_\beta} = \frac{x_\beta - x}{x_\beta - x_\alpha} \quad (12)$$

$$\frac{m_\beta}{m_\alpha + m_\beta} = \frac{x - x_\alpha}{x_\beta - x_\alpha}$$

These equations represent the so called lever rule. The name of this rule becomes apparent from its mechanical analog (see Fig. 18(b)).

Phase Reactions During Slow Cooling

In all of the following examples, we will assume slow cooling of an alloy of given composition from a single-phase melt. As we mentioned earlier, slow cooling is essential to maintain equilibrium microstructures.

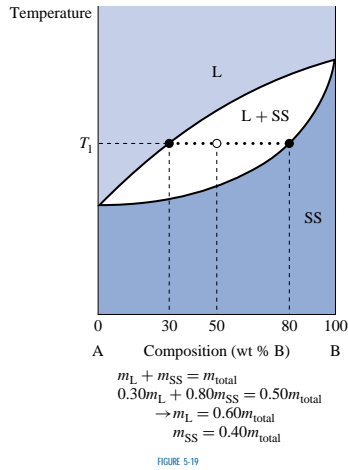

Figure 17: A more quantitative treatment of the tie line allows the amount of each phase (L and SS) to be calculated by means of a mass balance (From J. Shackelford, *Materials Science for Engineers*).

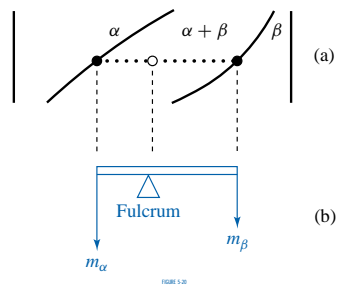

Figure 18: The lever rule is a mechanical analogy to the mass balance calculation. The (a) tie line in the two-phase region is analogous to (b) a lever balanced on a fulcrum (From J. Shackelford, *Materials Science for Engineers*).

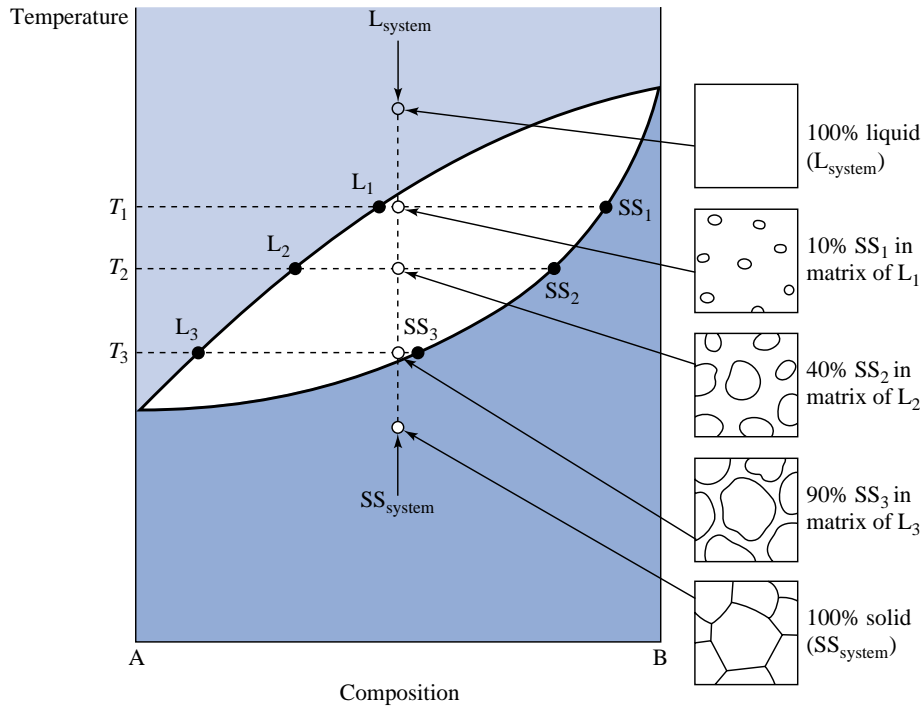

FIGURE 5-21

Figure 19: Microstructural development during the slow cooling of a 50%A – 50%B composition in a phase diagram with complete solid solution. At each temperature, the amounts of the phases in the microstructure correspond to a lever rule calculation. (From J. Shackelford, *Materials Science for Engineers*).

When the compositions of the phases change with temperature, we say that a phase reaction takes place. Figure 19 shows the phase reactions that take place during the slow cooling of 50%A – 50%B alloy from its melt. Both the % of each phase as well as the composition of each phase are shown during the cooling process.

Figure 20 shows the phase reactions during the slow cooling of an alloy at the eutectic composition.

The obtained microstructures are slightly more complicated if the alloy composition is different from the eutectic composition. In Fig. 21, the reactions upon cooling are presented for an alloy with higher than the eutectic composition. For example, consider the cooling of an alloy with 80 % B. Starting from above the liquidus curve, the regions of interest are shown in Figure 21.

- Upon reaching the liquidus curve, phase β appears in growing amounts as we further cool towards the eutectic temperature.
- Just before reaching the eutectic temperature, 33% of the microstructure is liquid. This amount of liquid undergoes the eutectic reaction and it is transformed to the

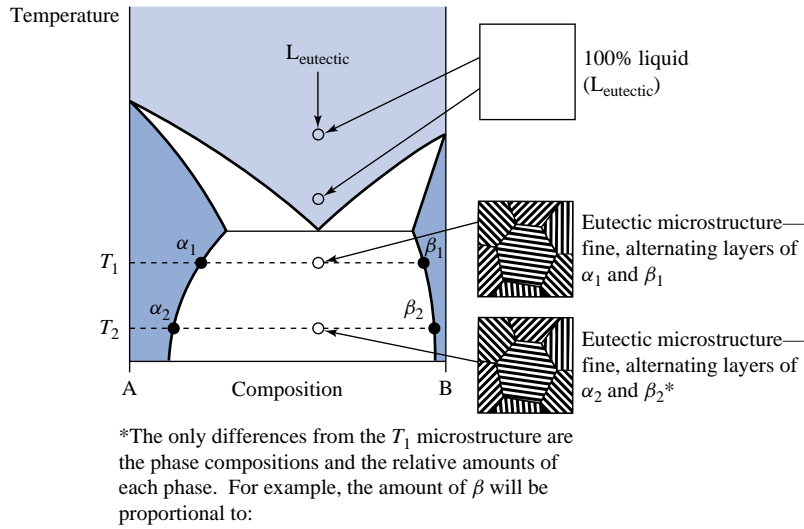

$$\frac{x_{\text{eutectic}} - x_{\alpha}}{x_{\beta} - x_{\alpha}}$$

FIGURE 5-22

Figure 20: Microstructural development during the slow cooling of a eutectic composition (From J. Shackelford, *Materials Science for Engineers*).

fine grained eutectic microstructure (17% α_3 and 83% β_3). At this point the phase β is present in two distinct forms: The large grains produced during cooling in the ($L + \beta$) region (called pro-eutectic β); and the finer β (called eutectic β) in the eutectic microstructure.

Figure 22 presents the reactions during slow cooling of an alloy with composition lower than the eutectic one.

Finally, Figure 23 present some microstructural developments that avoid the eutectic reaction.

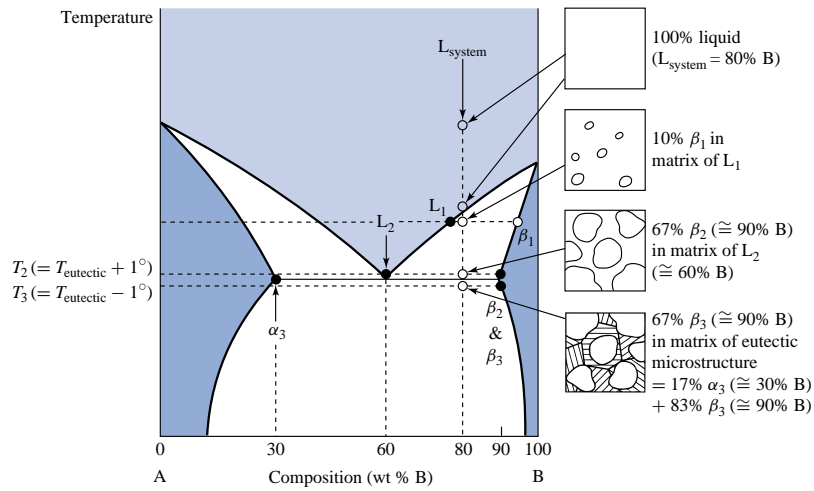

FIGURE 5-23

Figure 21: Microstructural development during the slow cooling of a hypereutectic composition (From J. Shackelford, *Materials Science for Engineers*).

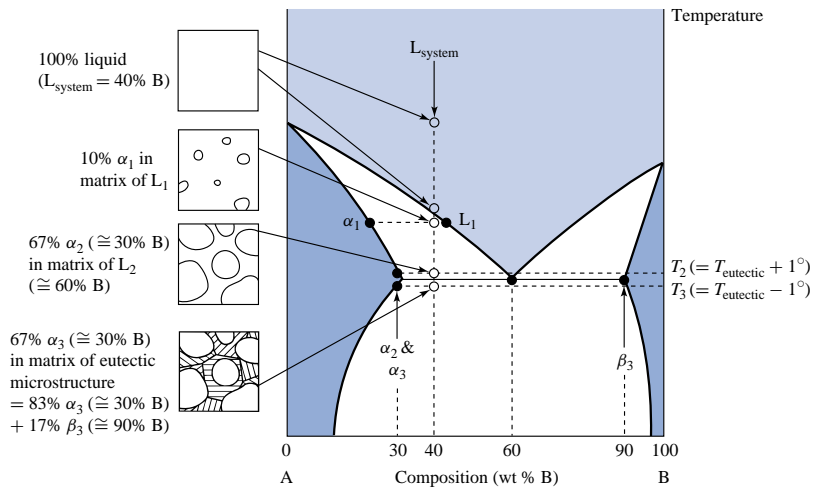

FIGURE 5-24

Figure 22: Microstructural development during the slow cooling of a hypoeutectic composition (From J. Shackelford, *Materials Science for Engineers*).

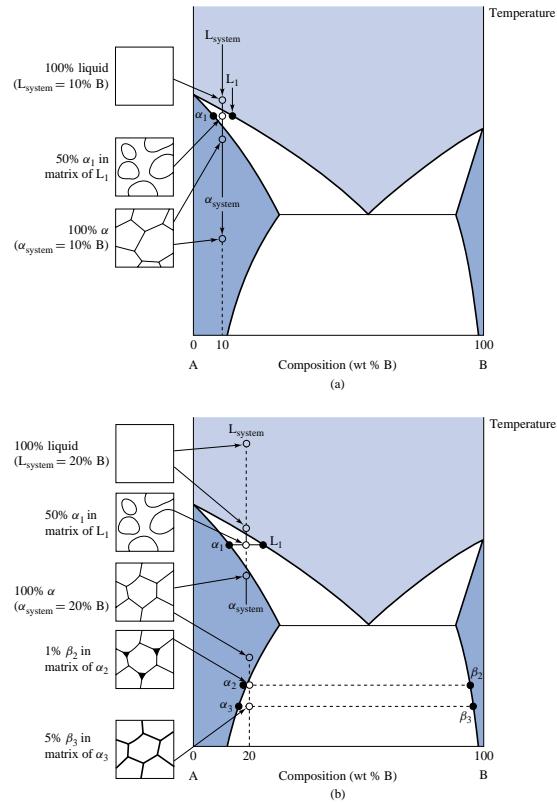

FIGURE 5-25

Figure 23: Microstructural development for a composition that avoids the eutectic reaction. (a) Solidification leads to a single solid-solution that remains stable upon further cooling (b) Upon cooling the α phase becomes saturated with B atoms. Further cooling leads to precipitation of a small amount of the β phase along grain boundaries (From J. Shackelford, *Materials Science for Engineers*).

The $Fe - Fe_3C$ phase diagram

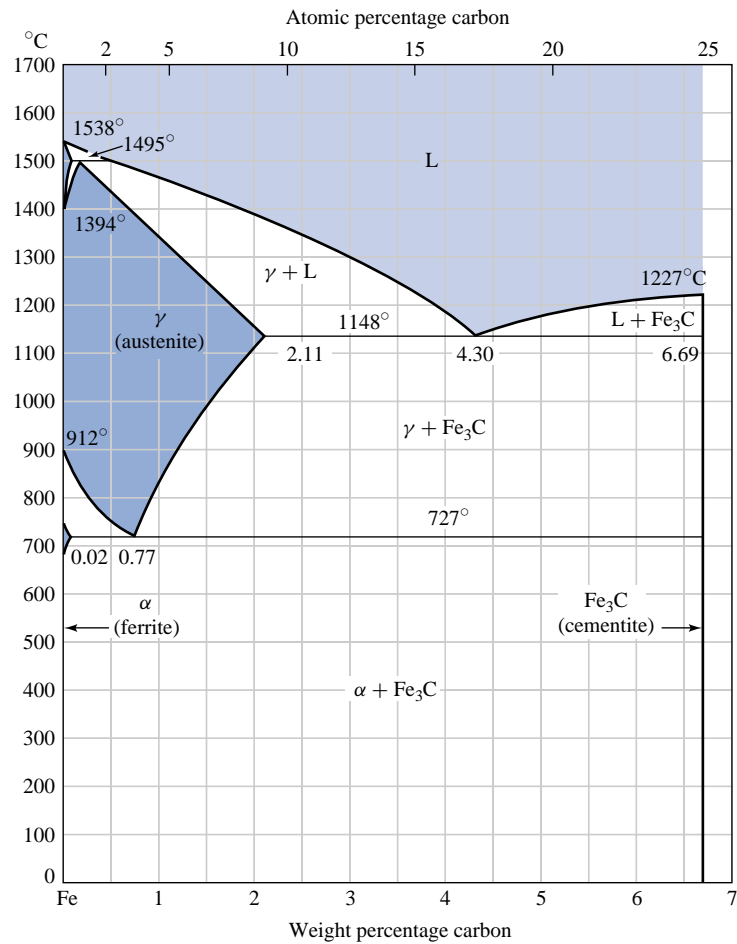

FIGURE 5-26

Figure 24: The $Fe - Fe_3C$ phase diagram. Note that the composition axis is given in weight percent carbon even though Fe_3C , and not carbon is a component.

Figure 24 is one of the most important phase diagrams. The phases are:

- Ferrite* α (b.c.c.) iron with up to 0.035 wt% C dissolved in solid solution.
- Austenite* γ (f.c.c.) iron with up to 1.7 wt% C dissolved in solid solution.
- δ -iron* δ (b.c.c.) with up to 0.08 wt% C dissolved in solid solution.
- Cementite* Fe_3C , a compound, at the right of the diagram.

The boundary between “irons” and “steels” is approximately at carbon content of 2.0wt% (the carbon solubility limit of austenite). Ferrite (or α) is the low-temperature form of iron.

On heating, it changes to austenite (or γ) at 914°C when it is pure, and this form remains stable until it reaches 1391°C when it changes to δ -iron (see Fig. 4).

Note that in Fig. 24 carbon (and not Fe_3C) is given as the composition axis.

At the eutectic point the phase reaction, on cooling, is



At the V at the bottom of the austenite field (eutectoid point), austenite, transforms on

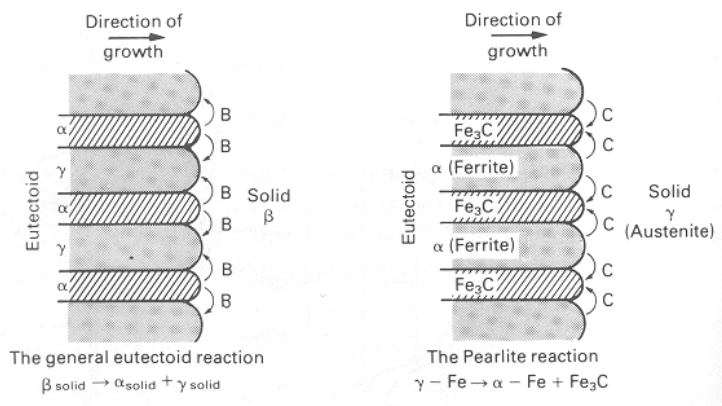

Figure 25: The general pearlite reaction $\gamma - \text{Fe} \rightarrow \alpha - \text{Fe} + \text{Fe}_3\text{C}$.

cooling to two other solids. Recall that a *eutectoid reaction* is a three-phase reaction by which, on cooling, a solid transforms into two other solid phases at the same time. The compositions of the two new phases are given by the ends of the tie line through the eutectoid point.

Eutectoid structures are like eutectic structures, but much finer in scale. The original solid decomposes into two others, both with compositions which differ from the original, and in the form (usually) of fine, parallel plates. In the eutectoid decomposition of iron, carbon diffuses to the carbon-rich Fe_3C plates, and away from the (carbon-poor) α -plates, just ahead of the interface. The colony of plates then grows to the right, consuming the austenite (γ) (see Fig. 25). The eutectoid structure in iron is called *pearlite* (because it has a pearly look). The micrograph (Figure 2) shows pearlite.

Figure 26 presents the development of microstructures for a $3.0 \text{ wt } \% \text{ C}$ (the so called white cast iron). The production of pearlite through the eutectoid reaction is shown in Fig. 27 for $0.77 \text{ wt } \% \text{ C}$ carbon steel.

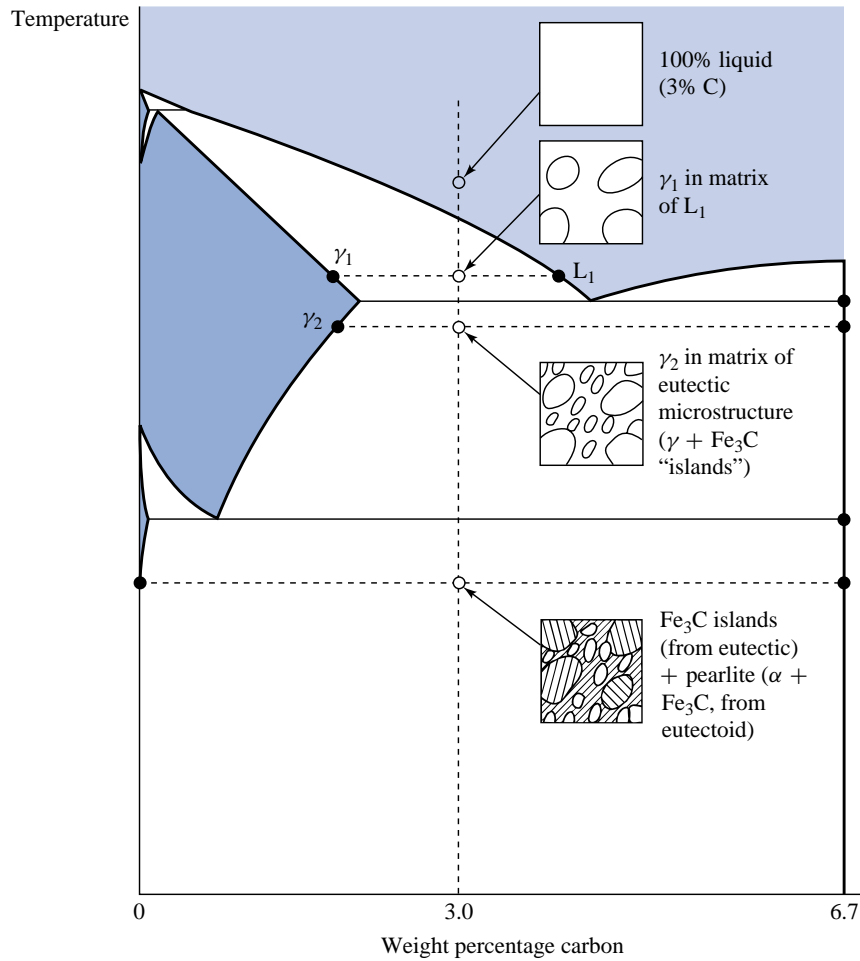

FIGURE 5-27

Figure 26: Microstructural development for white cast iron shown with the aid of the $Fe - Fe_3C$ phase diagram (From J. Shackelford, *Materials Science for Engineers*).

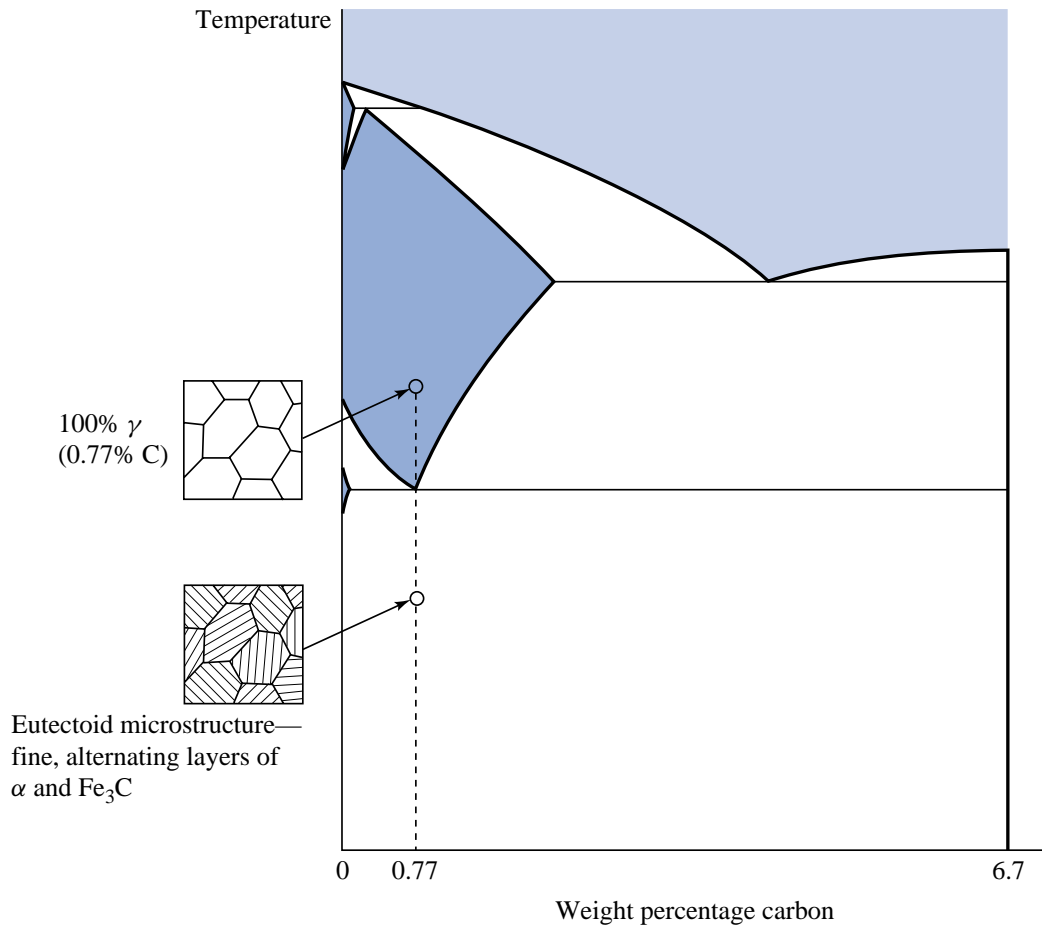

FIGURE 5-28

Figure 27: Microstructural development of eutectoid steel (of composition 0.77 wt % C) (From J. Shackelford, *Materials Science for Engineers*).

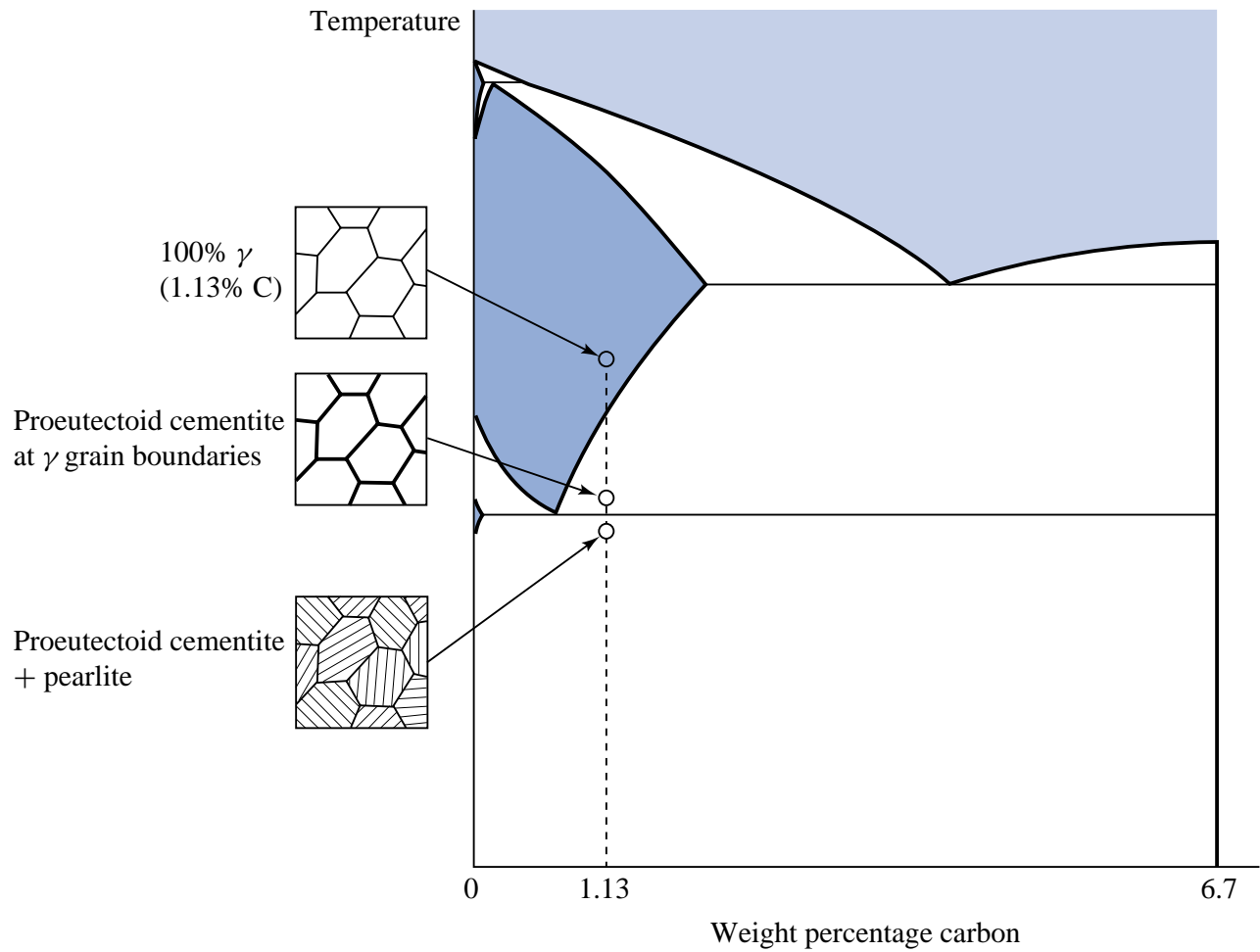

FIGURE 5-29

Figure 28: Microstructural development of hypereutectoid steel (of composition 1.13 wt % C) (From J. Shackelford, *Materials Science for Engineers*).

The microstructure development for a hypereutectoid (composition higher than 0.77 wt % C) steel can be found in Fig. 28. Note that the proeutectic Fe_3C is the matrix in the final microstructure (compare with the proeutectic phase in Fig. 21 which was the isolated phase).

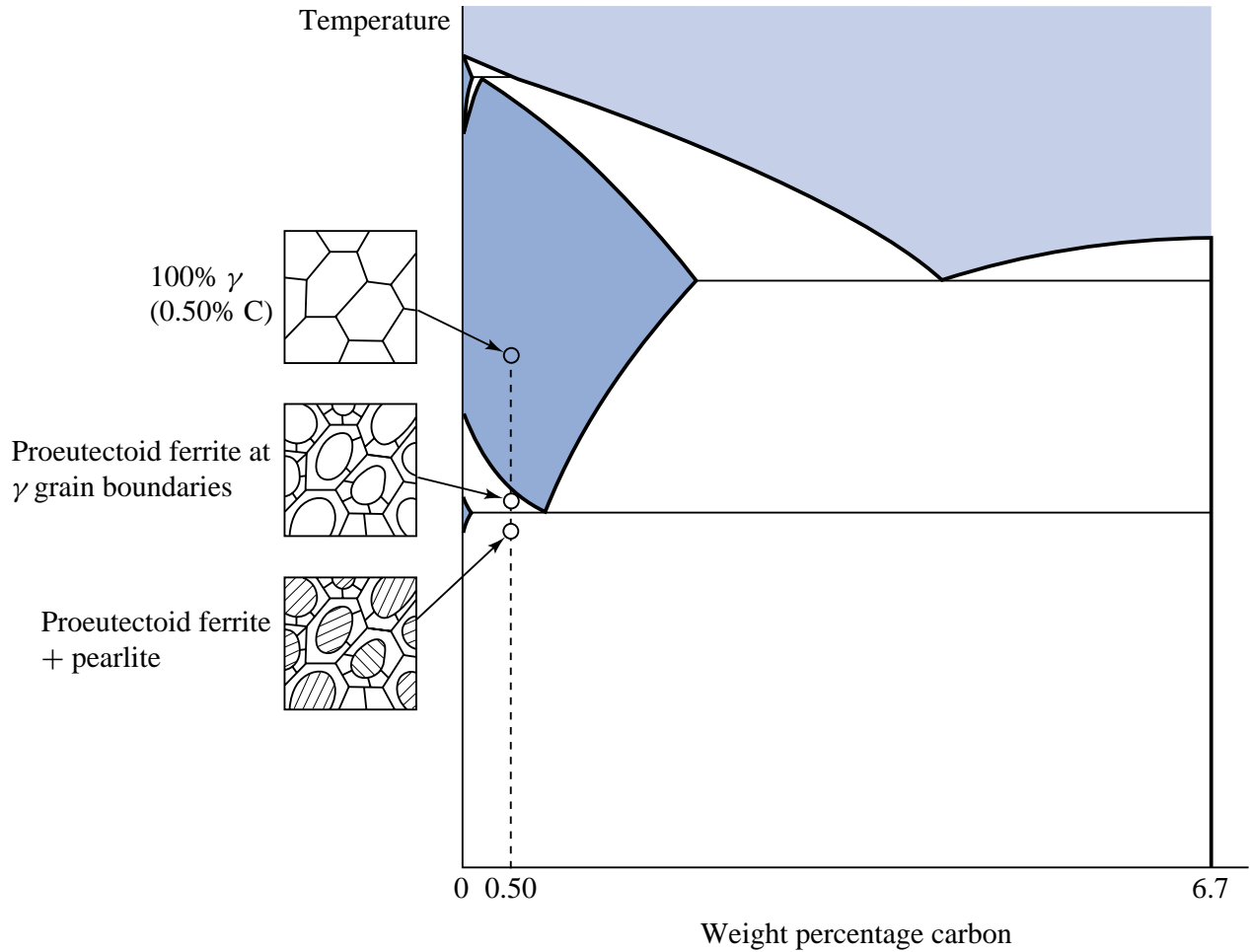

FIGURE 5-30

Figure 29: Microstructural development of hypoeutectoid steel (of composition 0.5 wt % C) (From J. Shackelford, *Materials Science for Engineers*).

Finally, the microstructure development for a hypoeutectoid (composition less than 0.77 wt % C) steel is shown in Fig. 29.

The Fe-C system

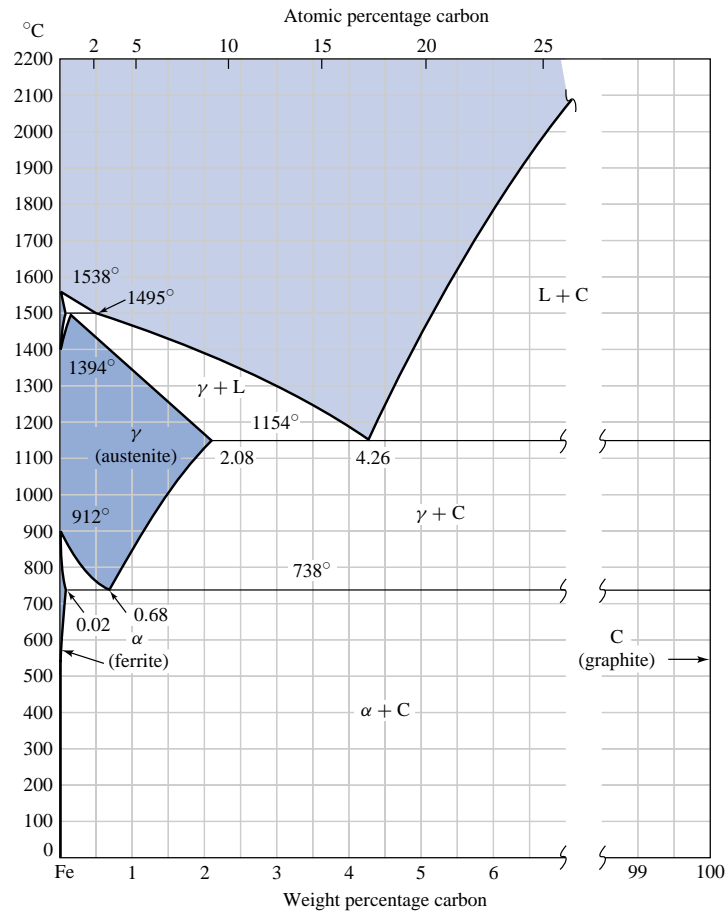

FIGURE 5-31

Figure 30: Very slow cooling can produce the $Fe - C$ phase diagram. The left side of this diagram is nearly identical to that for the $Fe - Fe_3C$ diagram (Fig. 24). In this case, however, the intermediate compound Fe_3C does not exist. The precipitation of graphite can be promoted by addition of small amount of silicon (not shown here).

The $Fe - Fe_3C$ phase diagram presented earlier is not truly an equilibrium diagrams (graphite C is more stable than Fe_3C). The precipitation of graphite is enormously slow and as such the Fe-C phase diagram is not very common (see Fig. 30). This precipitation can be promoted by adding a small amount of silicon.

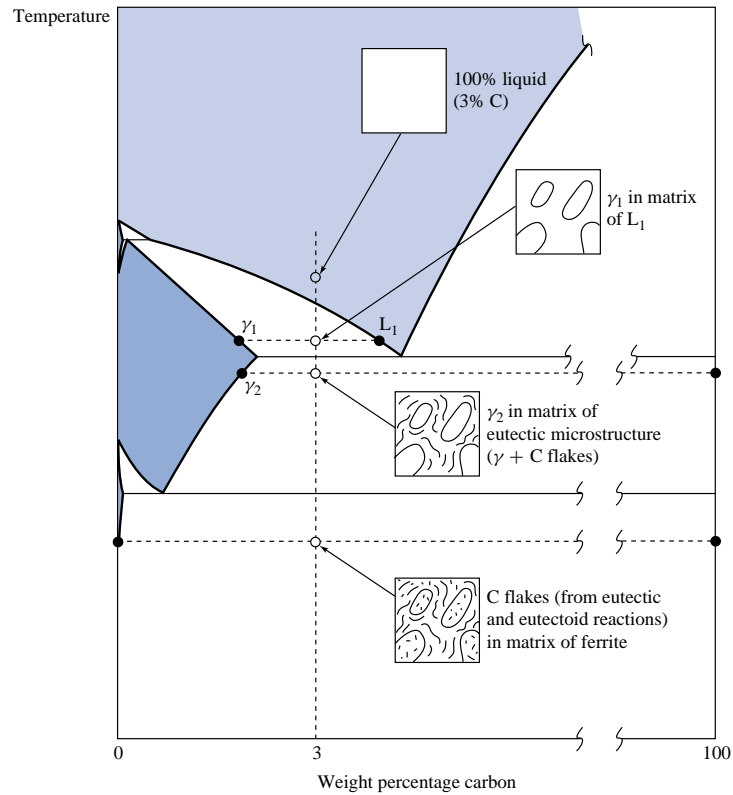

FIGURE 5-32

Figure 31: Microstructural development for gray cast iron (of composition 3.0 wt % C) shown in the Fe-C phase diagram. In the actual microstructure, a substantial amount of metastable pearlite was formed at the eutectoid temperature. It is also interesting to compare this sketch with that for white cast iron in Fig. 26. The small amount of silicon added to promote graphite precipitation is not shown in this two-component diagram (From J. Shackelford, *Materials Science for Engineers*).

The structure development for gray cast iron (composition in wt 3%) is shown in Fig. 31 on the Fe-C system. As before, silicon was added to promote graphite precipitation.