

# **Sonochemical Reactions**

**Chemical changes/reactions induced by ultrasound**

**No direct interaction of ultrasound field with molecules (in contrast to photochemistry, ...)**

- Liquid phase reactions – chemical reactions driven by cavitation effects**
- Solid state reactions – introduction of defects = speeding up diffusion**

# Sound

**Sound = pressure waves = periodic compression/expansion cycles traveling through a medium possessing elastic properties (gas, liquid, solid)**

**Liquids and gases – longitudinal pressure waves – compression/rarefaction  
Solids – longitudinal and transverse waves**

**The energy is propagated as deformations (tensile/compressive stress) in the media**

**The molecules oscillate about their original positions and are not propagated**

**The propagation of a sound wave = the transfer of vibrations from one molecule to another**

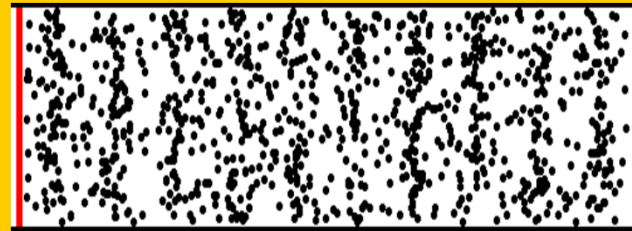

# Longitudinal Pressure Waves

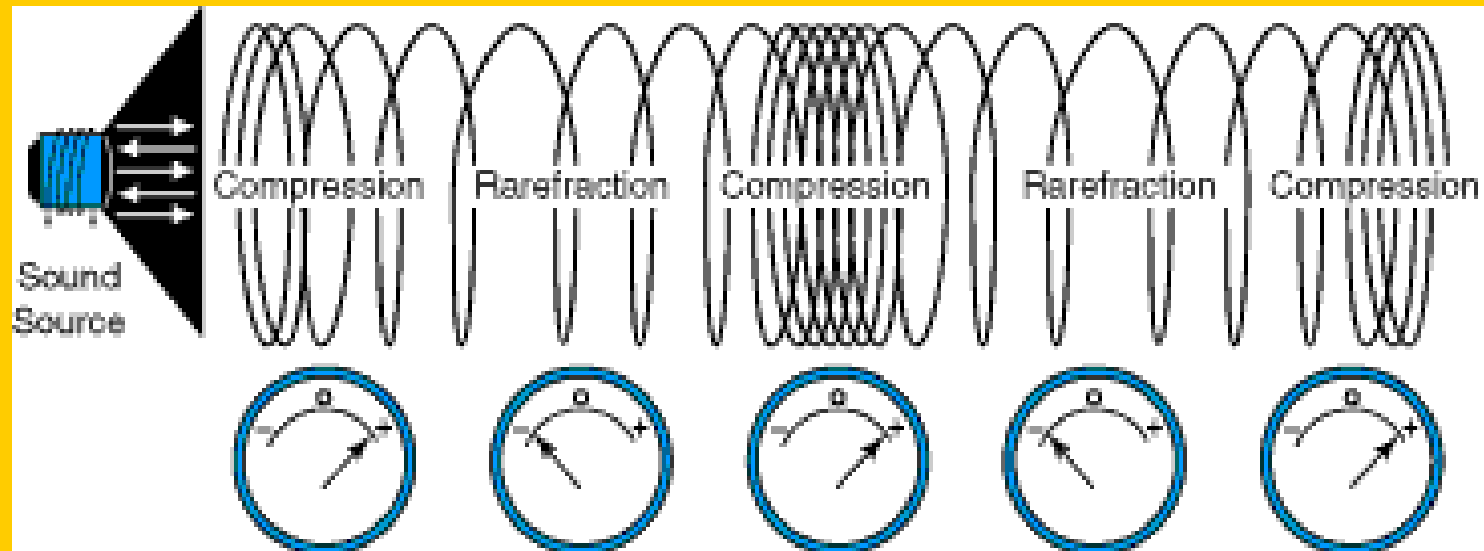

# Sound

In a typical liquid, the speed of sound decreases as the temperature increases, at all temperatures.

The speed of sound in water is almost five times greater than that in air (340 m s<sup>-1</sup>)

Substance	Speed of sound, $u$ [m s <sup>-1</sup> ]
Air	343
Helium	965
Water	1482
Lead	1960
Steel	5960
Granite	6000

# Speed of Sound

The speed of sound ( $u$ )

$$u^2 = 1/\kappa_S \rho = [\partial P / \partial \rho]_S \sim 1/(\langle (V)^2 \rangle)$$

$\kappa_S$  = adiabatic compressibility

$\rho$  = density

$P$  = pressure

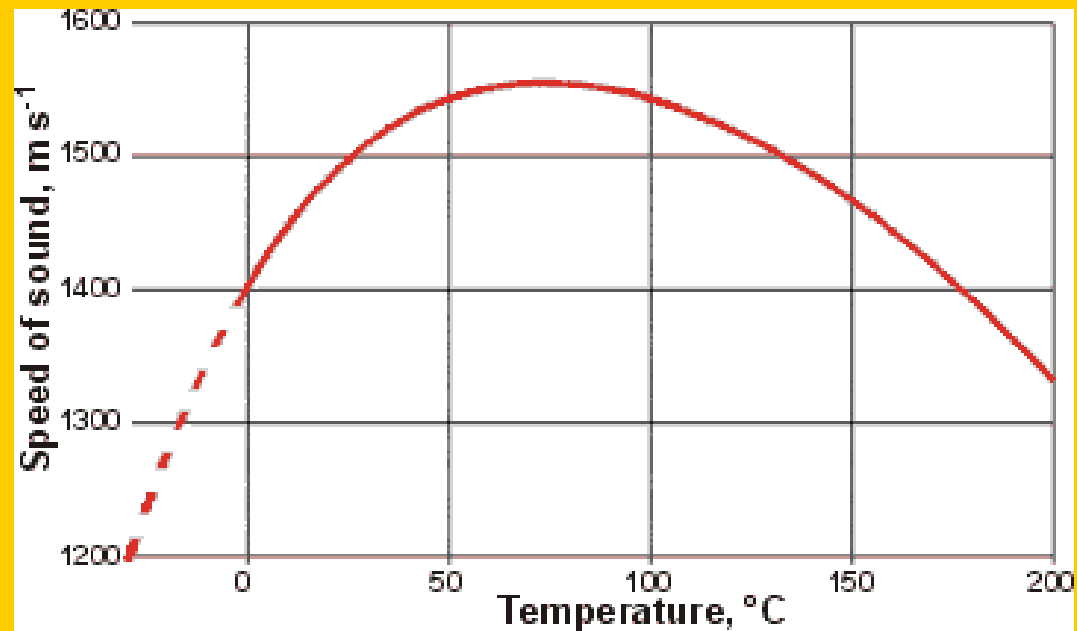

# Sound Intensity

$$\text{Sound Intensity} = \text{Power} / \text{area} = \text{Watts/m}^2$$

<i>Source of Sound</i>	<i>Intensity (W/m<sup>2</sup>)</i>	<i>Sound level (dB)</i>
<b>Jet Airplane 30 m away</b>	<b>10<sup>2</sup></b>	<b>140</b>
<b>Air-raid Siren, nearby</b>	<b>1</b>	<b>120</b>
<b>Threshold of Pain</b>	<b>10<sup>-1</sup></b>	<b>120</b>
<b>Concert</b>	<b>~10<sup>-1</sup></b>	<b>115</b>
<b>Riveter</b>	<b>10<sup>-3</sup></b>	<b>100</b>
<b>Busy Traffic</b>	<b>10<sup>-5</sup></b>	<b>70</b>
<b>Normal Conversations</b>	<b>10<sup>-6</sup></b>	<b>60</b>
<b>Whisper</b>	<b>10<sup>-10</sup></b>	<b>20</b>
<b>Threshold of Hearing</b>	<b>10<sup>-12</sup></b>	<b>0</b>

**0 dB (10<sup>-12</sup> W/m<sup>2</sup>)**

**10 dB = 10 as intense**

**20 dB = 10<sup>2</sup> as intense**

**30 dB = 10<sup>3</sup> as intense**

**120 dB = 10<sup>12</sup> as intense**

# Acoustic Pressure

$$P_a = P_A \sin 2\pi f t$$

$P_a$  acoustic pressure

$P_A$  pressure amplitude

$f$  sound frequency

$$c = \lambda f$$

(for 20 kHz,  $\lambda = 7.5$  cm)

$$P_{\text{total}} = P_a + P_h$$

$P_h$  hydrostatic pressure

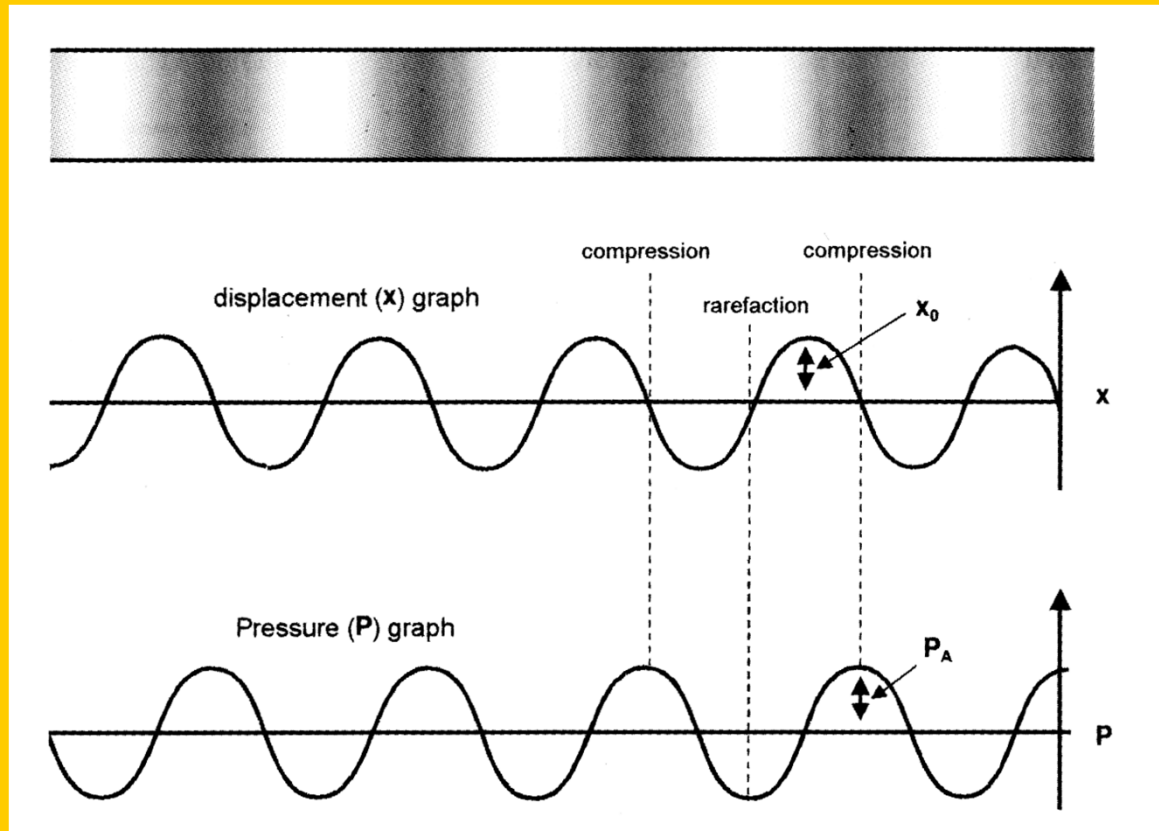

# Acoustic Pressure

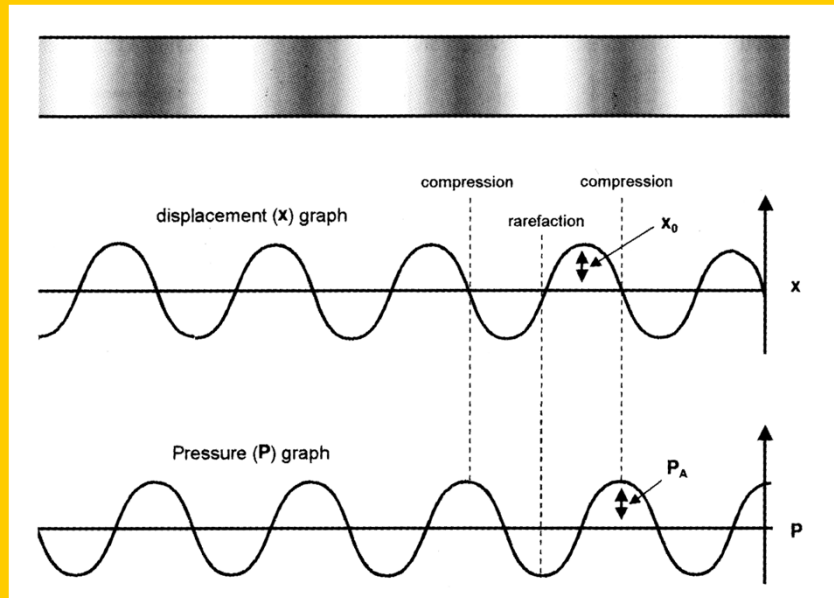

**Compression and  
rarefaction (expansion)  
regions**

$$P_A = \sqrt{2I\rho c}$$

**$P_A$  = driving pressure amplitude [Pa]**

**$I$  = irradiation intensity [ $\text{W m}^{-2}$ ]**

**(500 W system -  $1.3 \cdot 10^5 \text{ W m}^{-2}$ )**

**$\rho$  = liquid density [ $\text{kg m}^{-3}$ ]**

**$c$  = sound velocity in liquid [ $\text{m s}^{-1}$ ]**

**(Water  $1482 \text{ m s}^{-1}$ )**

$$P_A = 620\,700 \text{ Pa} = 6.2 \text{ bar}$$



# Ultrasound

Ultrasound frequencies from 20 kHz to 50 MHz

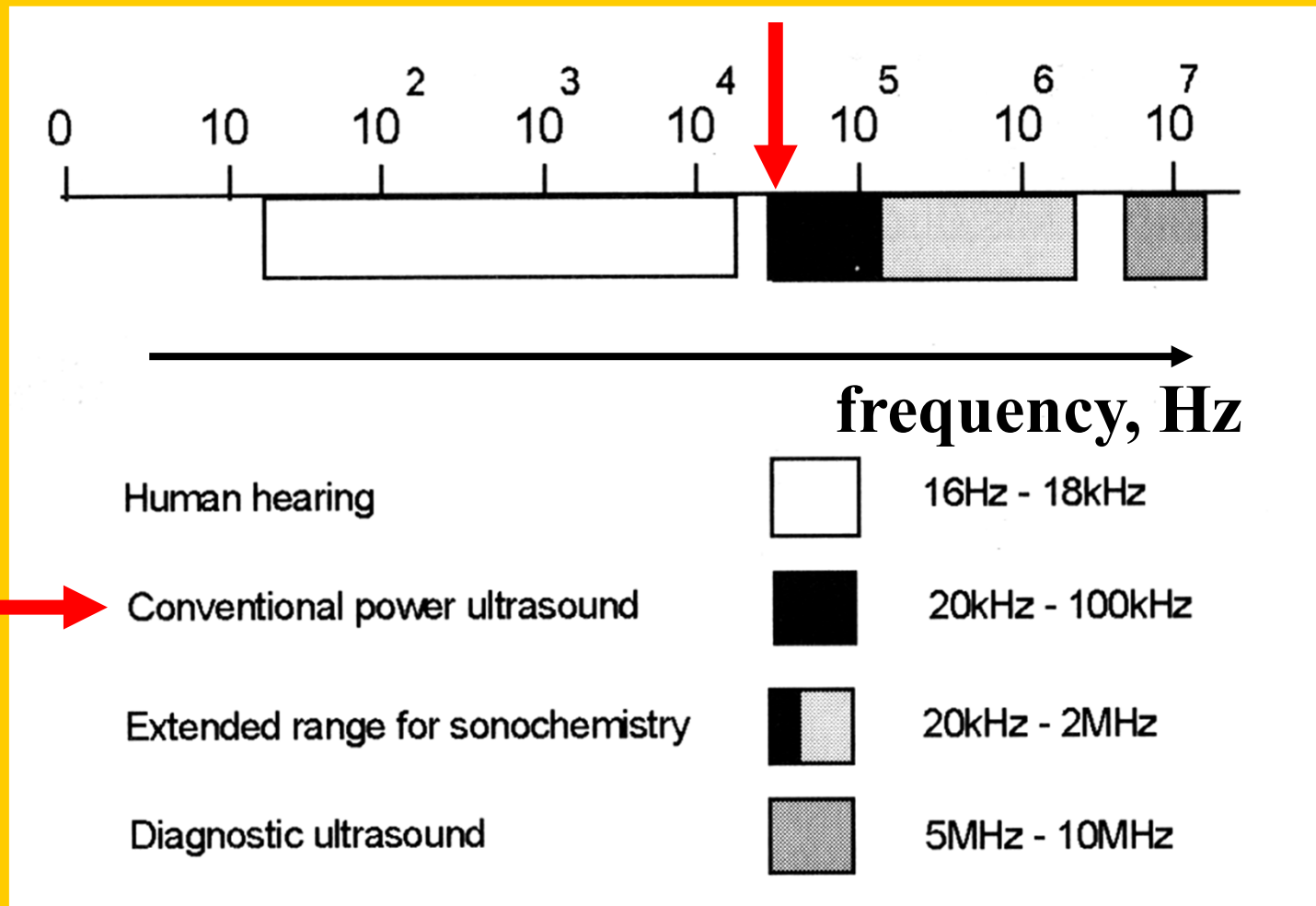

# Generation of Ultrasound

**Transducer – a device converting one type of energy into another**

**gas driven**

**whistle (F. Galton), liquid atomizer**

**siren**

**liquid driven**

**liquid whistle homogeniser, a jet of liquid passed through an orifice on a thin metal blade, vibrations, cavitation, mixing of immiscible liquids, ketchup, mayonnaise**

**electromechanical**

**magnetostrictive, Ni, Co/Fe, Al/Fe, Tb/Dy/Fe alloys shrink when placed in mg. field, solenoid, pulses, upper limit 100 kHz, cooling**

**piezoelectric, opposite charges applied on crystal sides, contraction/expansion, quartz,  $\text{Pb}(\text{Zr}/\text{Ti})\text{O}_3$  ceramics (PZT), up to MHz**

# Generation of Ultrasound

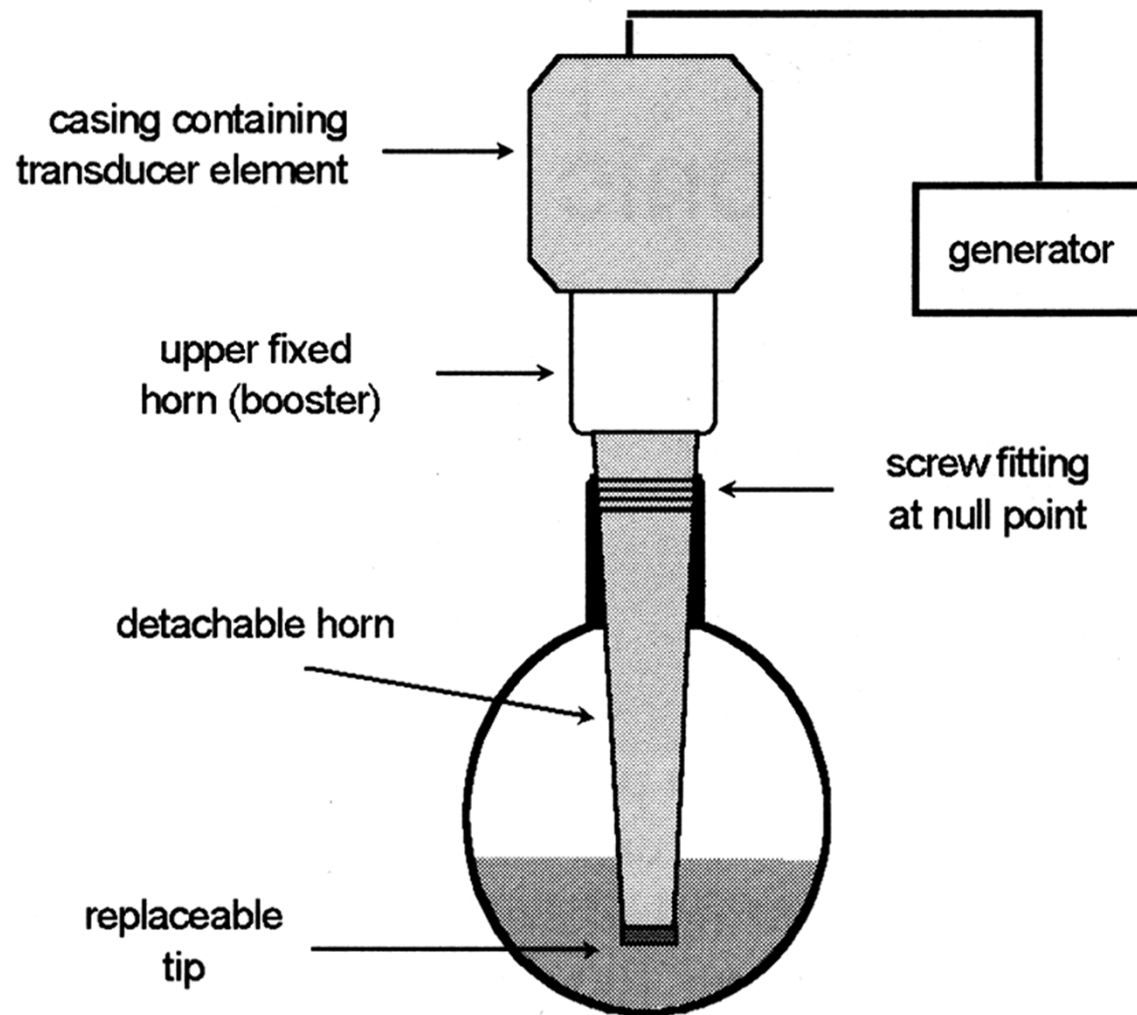

# Sonochemical Reactor

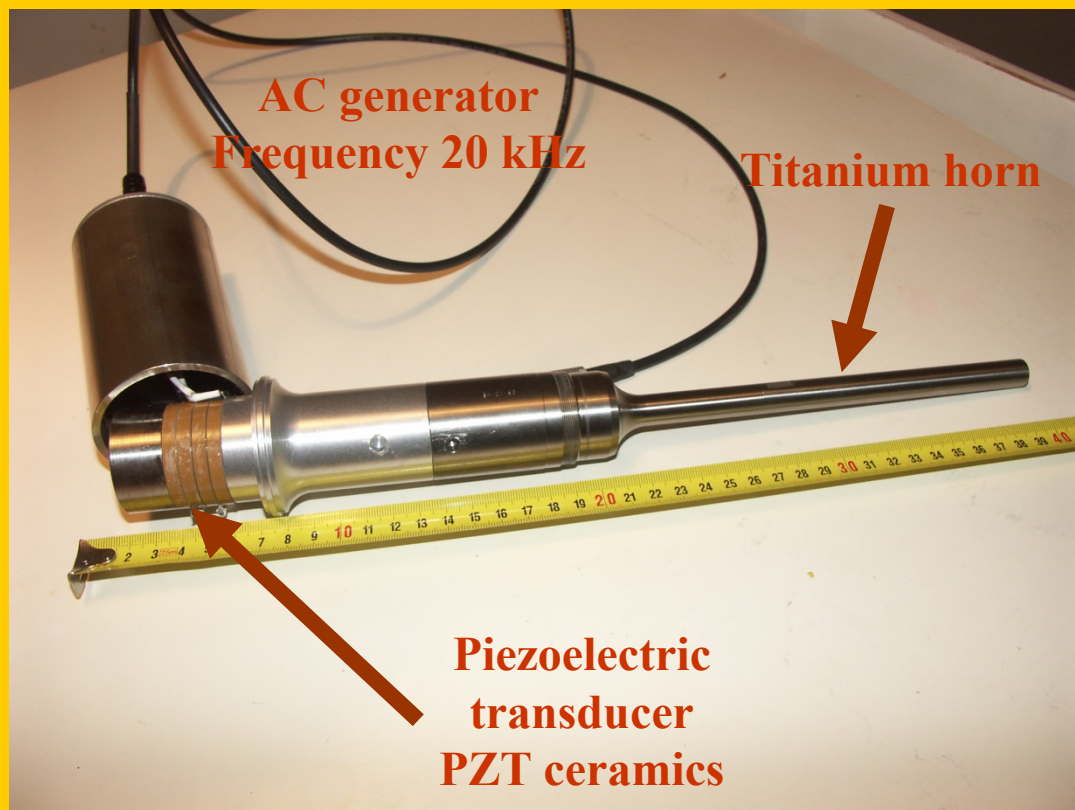

**Piezoelectric Ultrasound Generator  
Ultrasound Processor VCX 500 W**

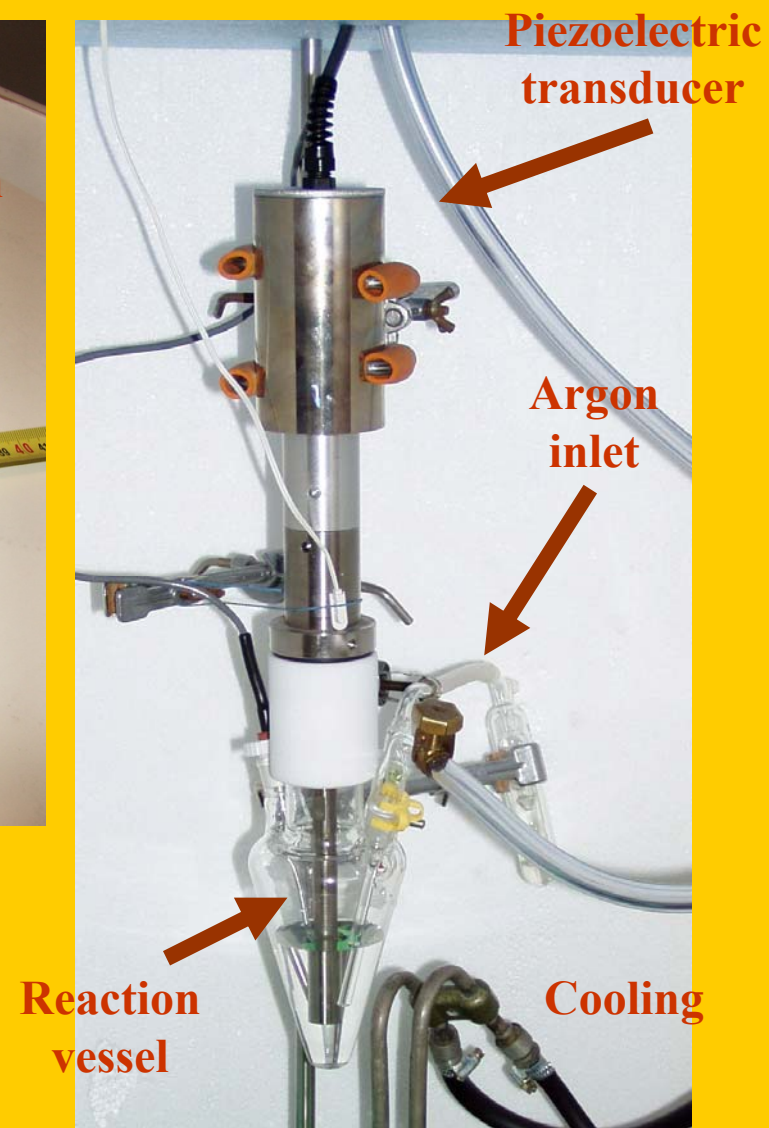

# Sonochemical Reactor

**Ultrasound Processor VCX 500 W**

Frequency 20 kHz

0 to 40 °C

Argon (flow rate 62 cm<sup>3</sup> min<sup>-1</sup>)

TIME of ultrasound treatment

PULSE irradiation and a dwell time 2:2

TEMP maximum temperature 50 °C

AMPL amplitude 50 %



# Sonochemical Reactor

Ti alloy horn, minimum length is a half-wavelength of sound in a material, 26 cm for 20 kHz in Ti, multiples of 13 cm

vibration amplitude 5 - 50  $\mu\text{m}$

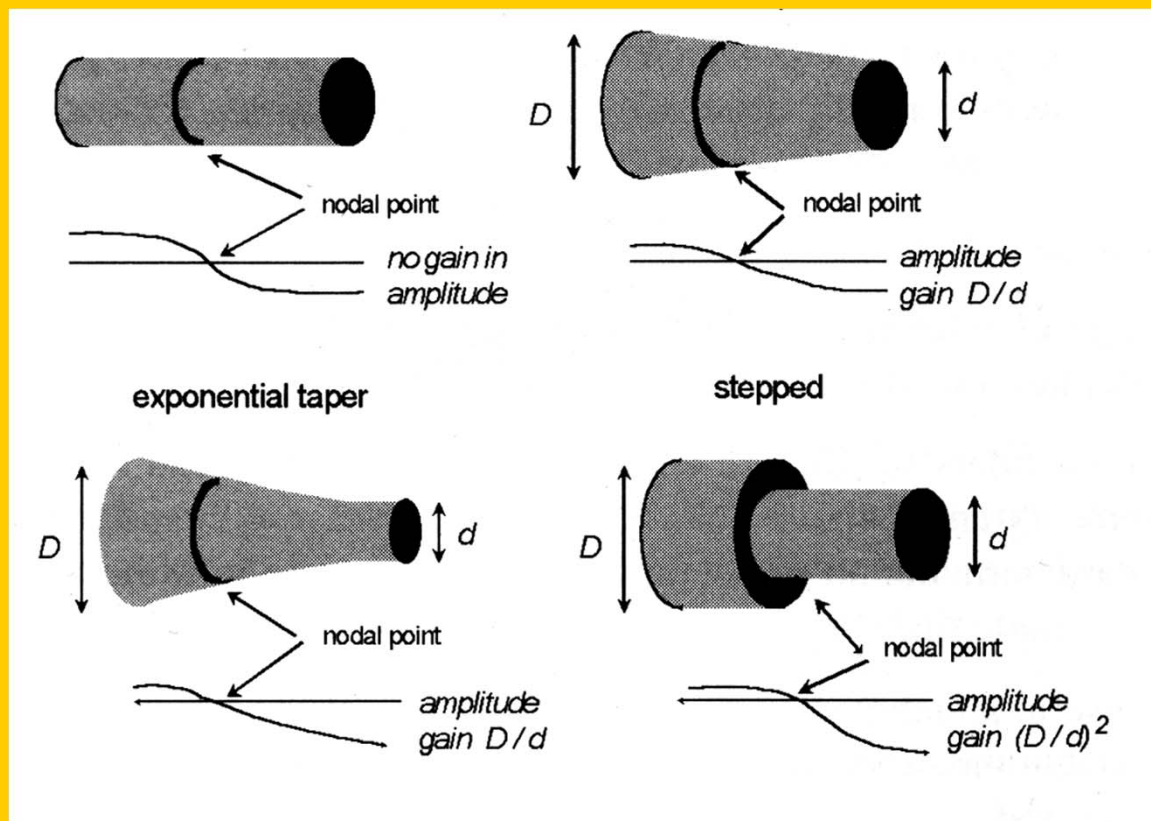

# Sonochemical Reactor

PZT wafers

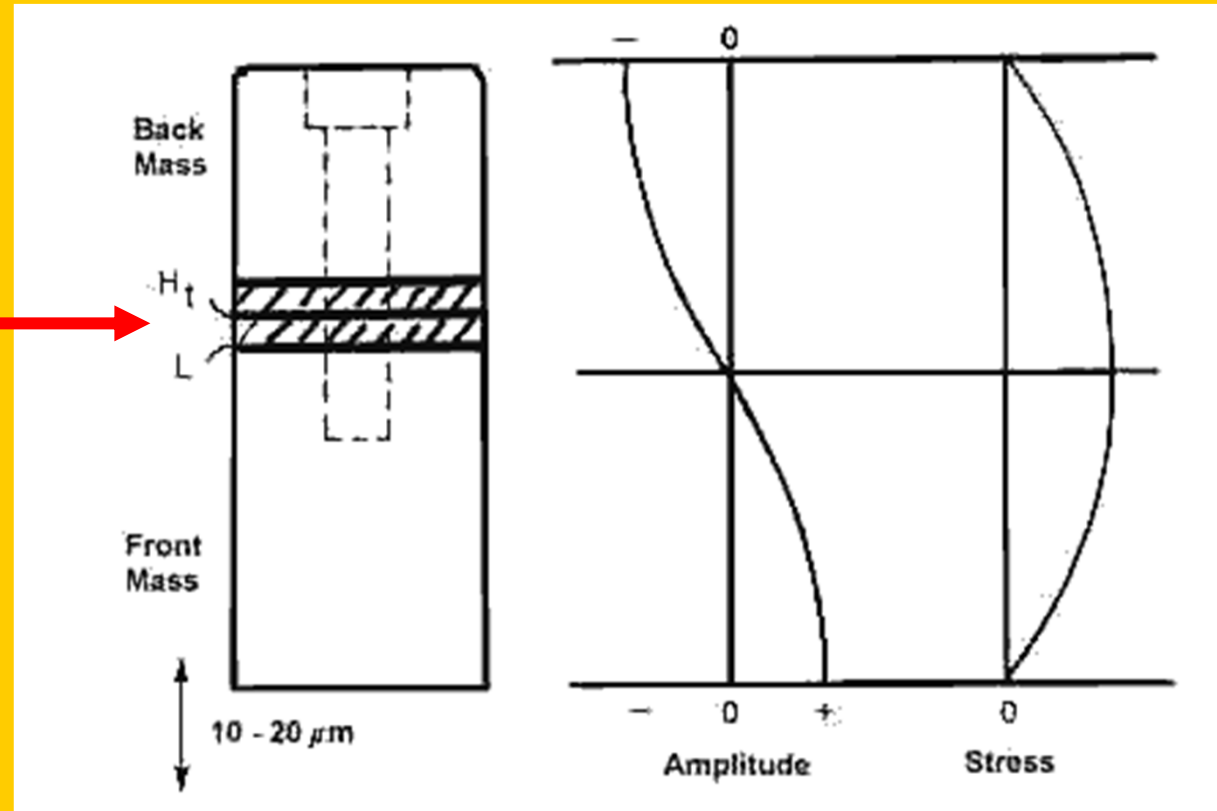

Sandwich transducer operating at 1-200 kHz

# Hydrodynamic Cavitation

**the passage of liquid through an orifice plate**

**the kinetic energy/velocity of the liquid increases at the expense of the pressure**

**throttling causes the pressure to fall (Bernoulli) below the threshold pressure for cavitation (vapor pressure)**

**cavities are generated**

**the liquid jet expands, the pressure recovers**

**energetic collapse of the cavities**



# Hydrodynamic Cavitation

Lord Rayleigh for the British Admiralty 1895

cavitation erosion of propeller blades



The University of Texas at Austin

$$R \ddot{R} + \frac{3}{2} \dot{R}^2 = \frac{1}{\rho} [p_g - P_0 - P(t)] - 4v \frac{\dot{R}}{R} - \frac{2\sigma}{\rho R}$$

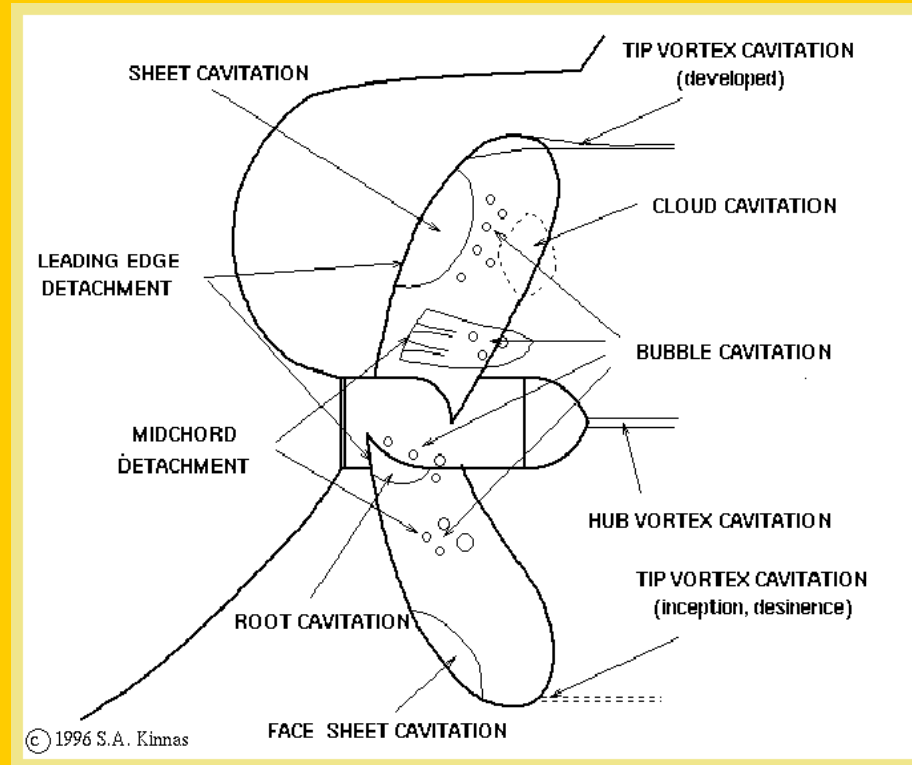

# Snapping Shrimp

**snaps a claw shut to create a water jet -  
speed of 30 m/s, or 100 km/h  
a drop of the pressure to below the vapor  
pressure of water - cavitation bubbles  
acoustic pressures of up to 80 kPa at a  
distance of 4 cm**

**The pressure wave is strong enough to kill  
small fish**



M. Versluis, B. Schmitz, A. von der Heydt, D. Lohse, How Snapping Shrimp Snap: Through Cavitating Bubbles. *Science* 289, 2114–2117 (2000)

# Snapping Shrimp

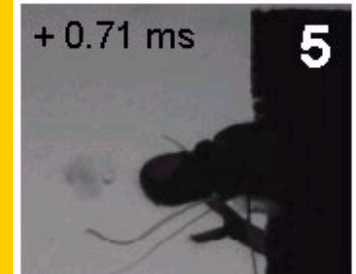
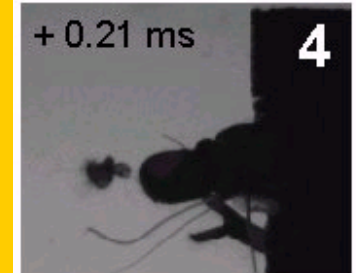
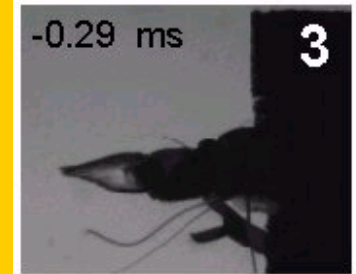
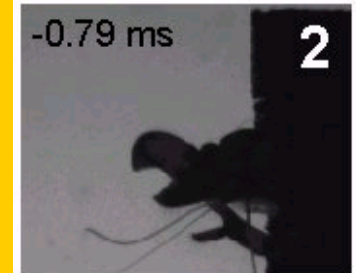
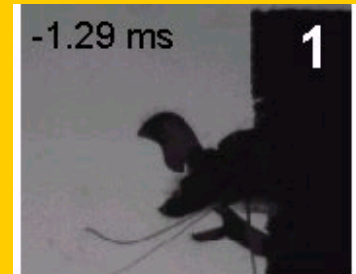
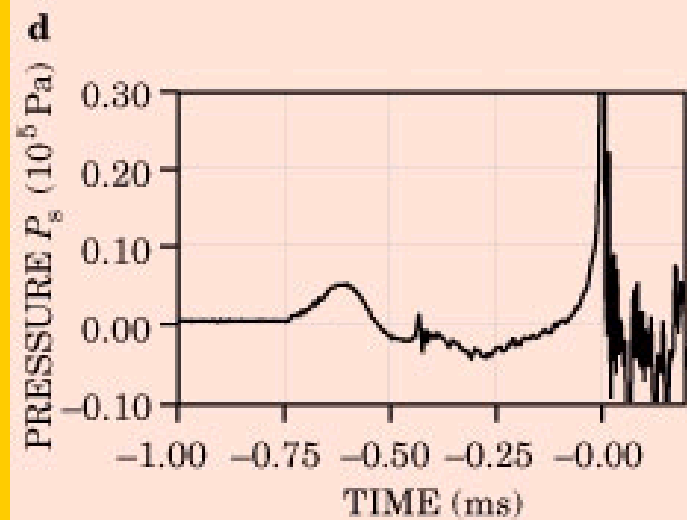
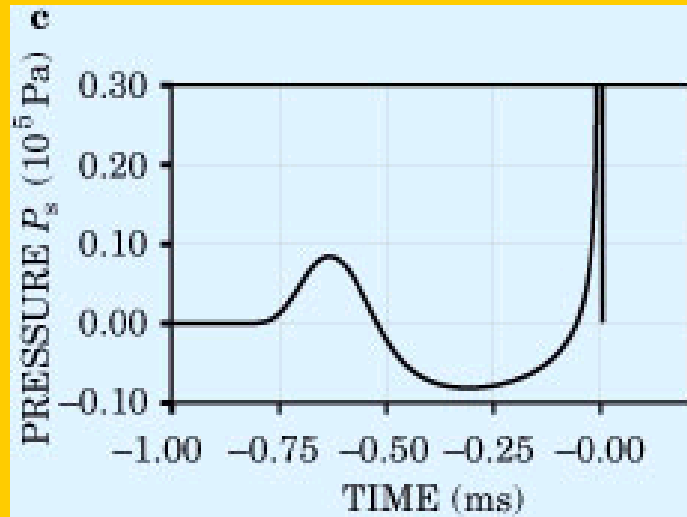
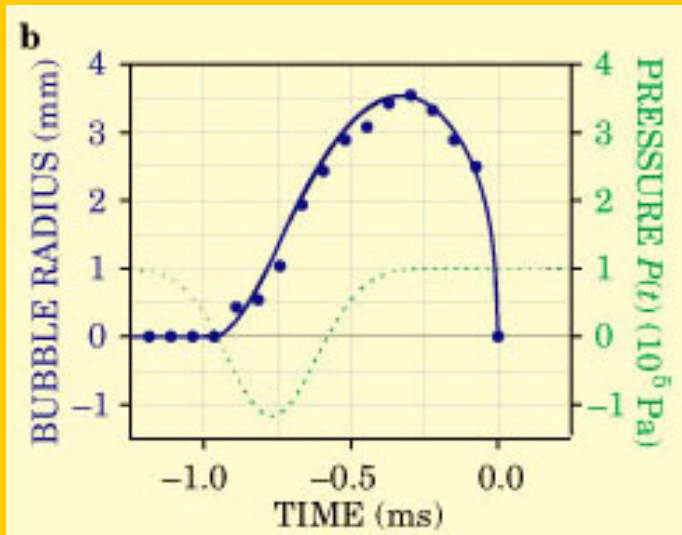

D. Lohse, B. Schmitz, M. Versluis, Nature 413, 477-478 (2001)

# Snapping Shrimp



cavitation bubbles

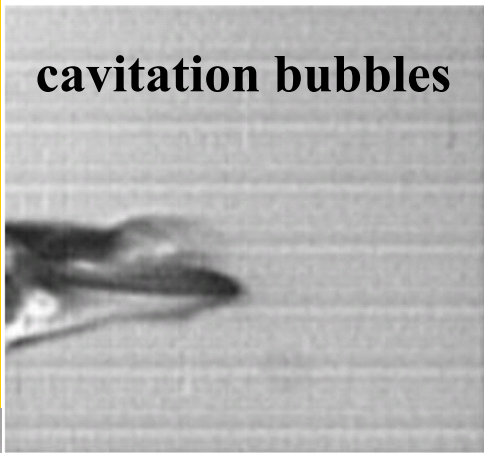

collapse

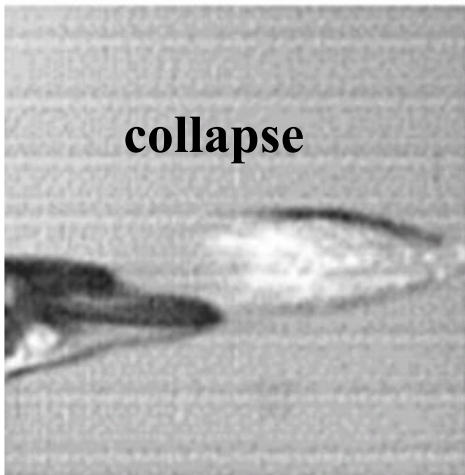

intense flash of light

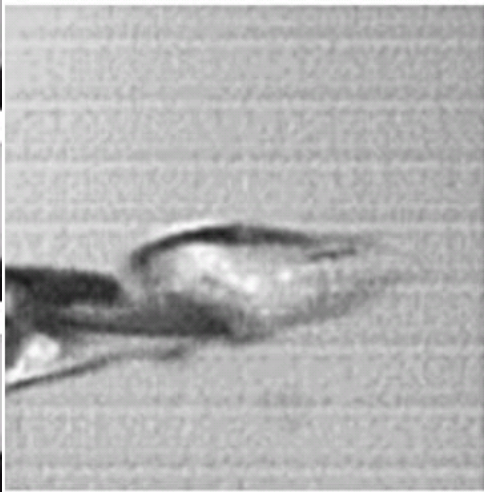

-1.29 ms

1

-0.79 ms

2

-0.29 ms

3

+ 0.21 ms

4

+ 0.71 ms

5

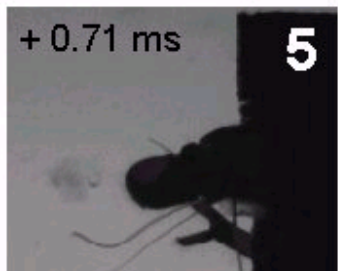
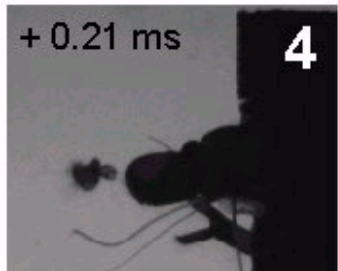
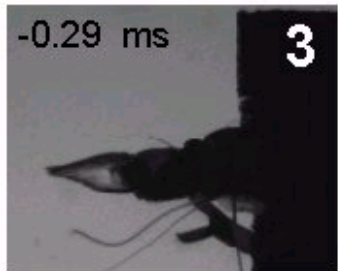
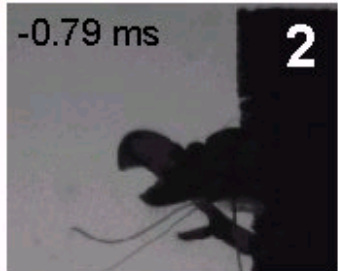

D. Lohse, B. Schmitz, M. Versluis, Nature 413, 477-478 (2001)

# Stable vs. Transient Cavitation

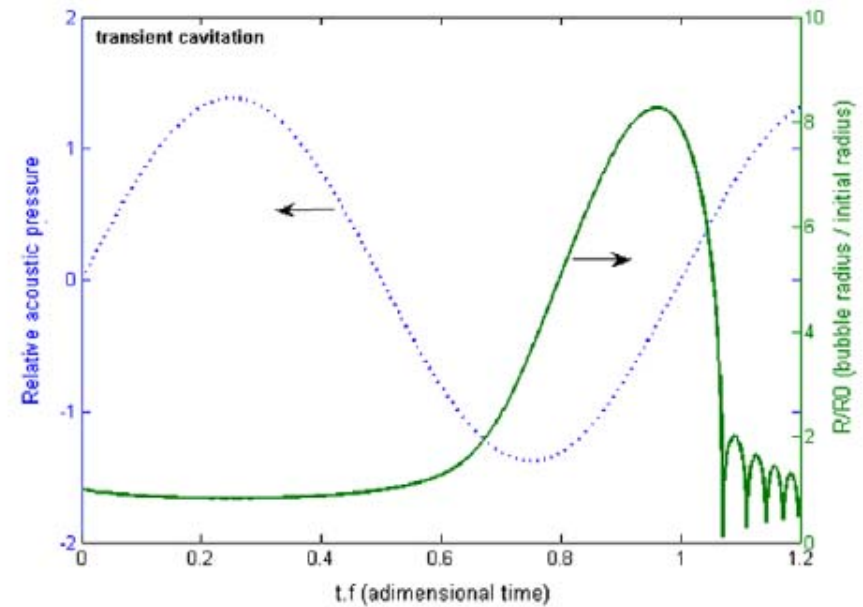
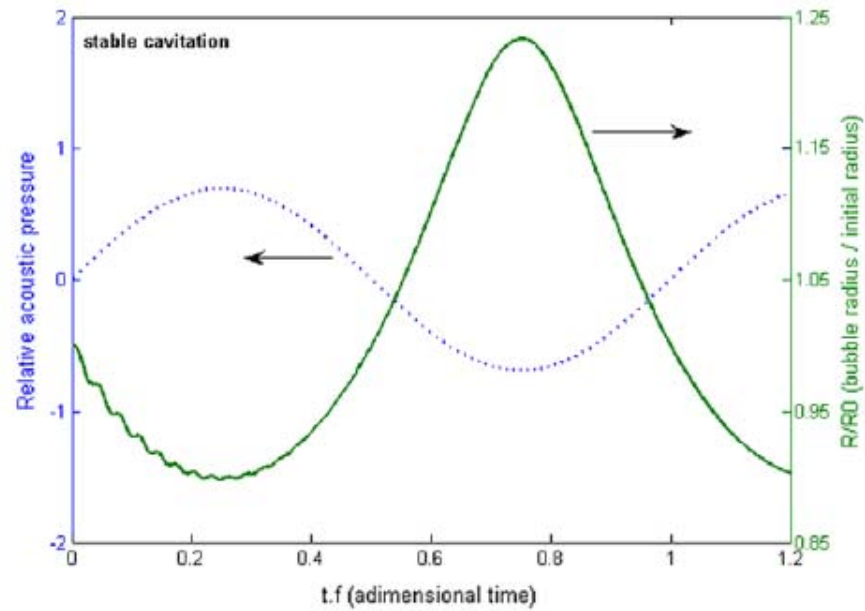

# Acoustic Cavitation

**Cavitation effects = creation, growth, and implosive collapse of bubbles (1-2  $\mu$ s) in a liquid = implosion **HOT SPOT** (1 ns)**

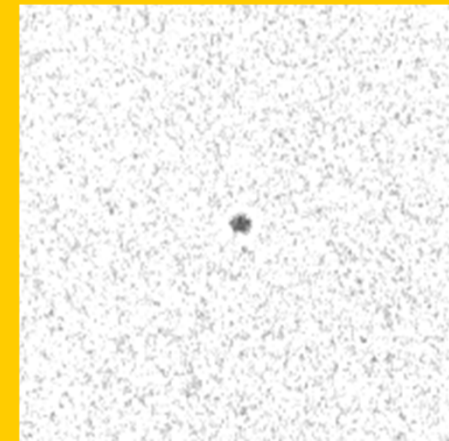
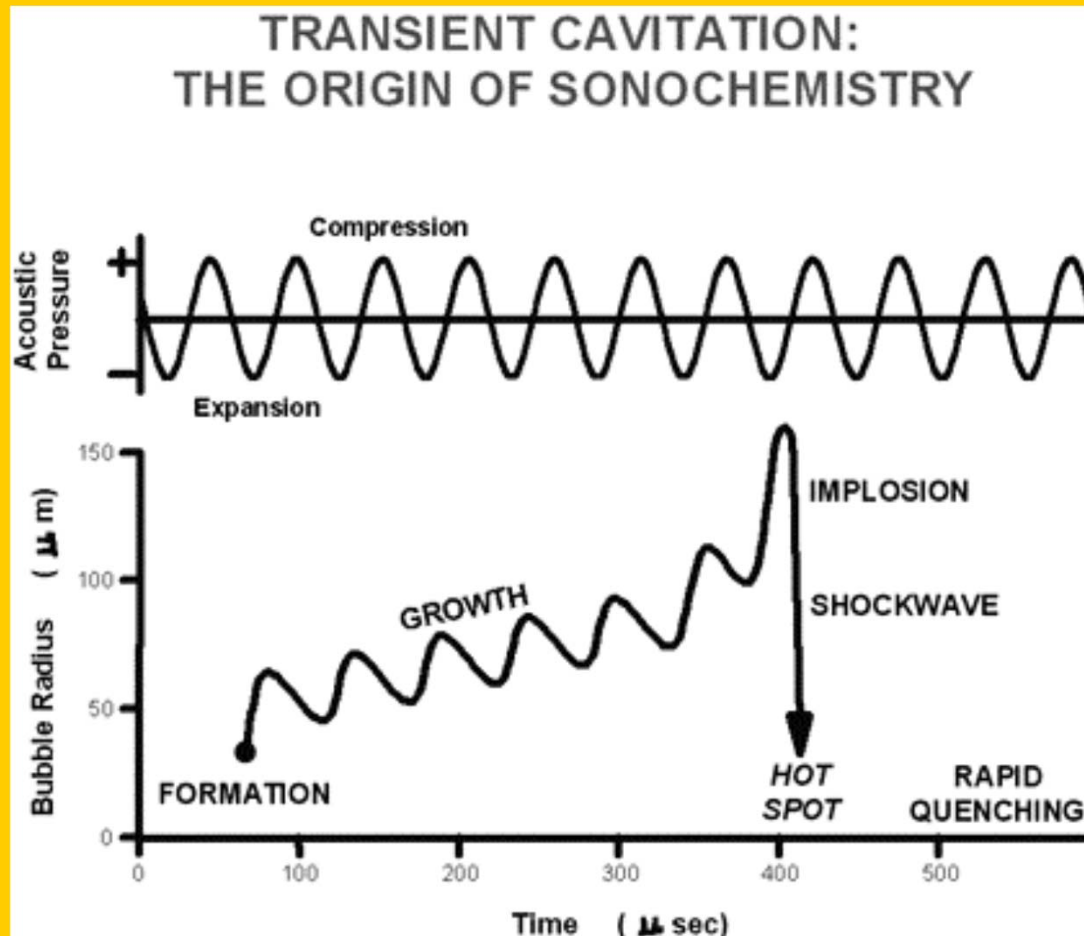

**stable cavitation - bubbles oscillate for many cycles**

**transient cavitation - transient cavities expand rapidly collapse violently**

# Acoustic Cavitation

**Cavitation effects = creation, growth, and implosive collapse of bubbles in a liquid**

**Bubble formation = breakage of liquid during **expansion**, overcoming tensile strength (pure water 1500 bar, only 6.2 bar available)**

**Weak spots needed = dissolved gas molecules, solid particles, trapped gases**

**Bubble growth (300  $\mu$ s), energy absorption, size oscillations  
critical size (170-300  $\mu$ m) = most efficient energy absorption, rapid growth,  
inefficient energy absorption, collapse**

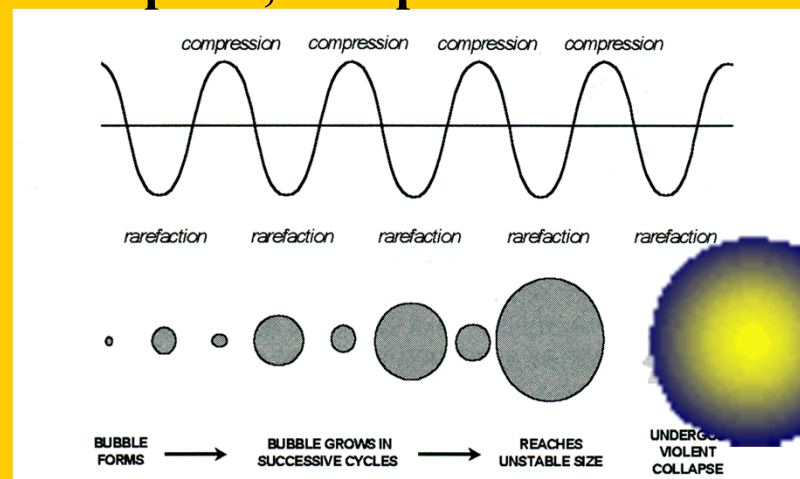

# Acoustic Cavitation

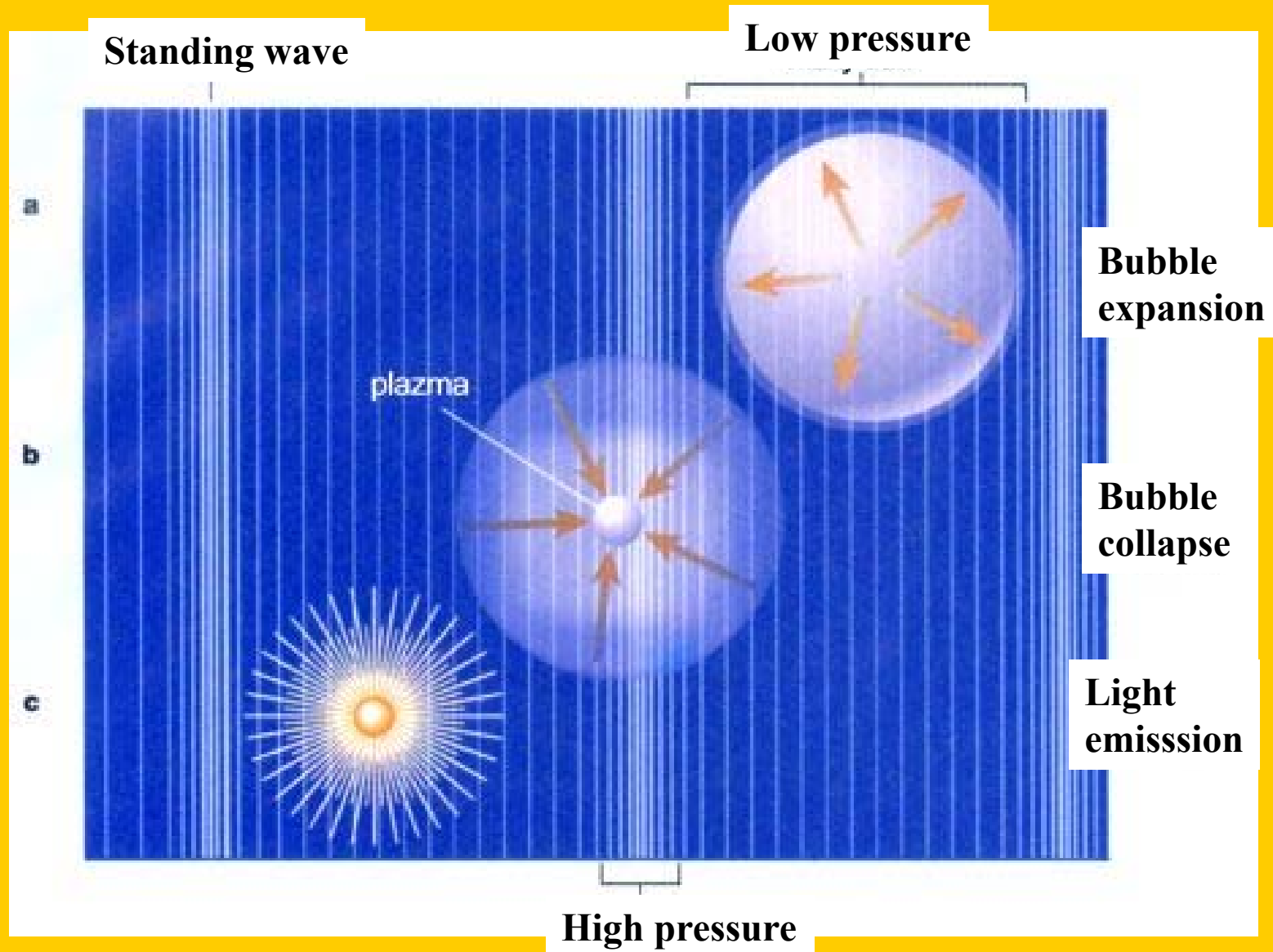



# Acoustic Cavitation

**Bubbles collapse = spherically symmetrical implosion,  
shear forces, adiabatic compression, life time 1-2  $\mu$ s**

**Hot spot = end of the collapse  
temperature of the gas inside bubble  
5 000 – 20 000 °C (for 1 ns)**

**surrounding liquid layer 2000 °C**

**pressure 500 – 1500 bar**

**Extreme cooling rates  $10^{10}$  K s<sup>-1</sup>  
red hot steel poured into water 2500 K s<sup>-1</sup>**

# Homogeneous Sonochemistry

## Two-Site Mechanism

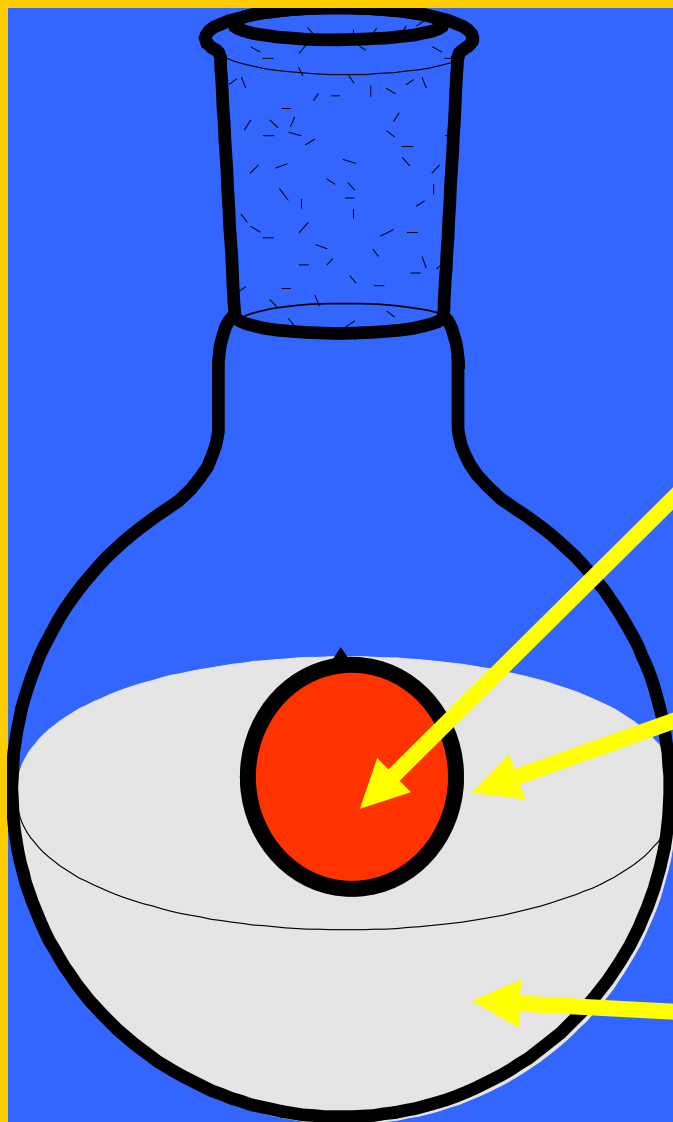

### Cavity interior

Filled with gases and vapors

temperatures 5 000 – 20 000 °C

pressure 500 – 1500 bar

### Surrounding liquid layer

temperatures 2000 °C

### Bulk liquid

Shock waves, shear forces

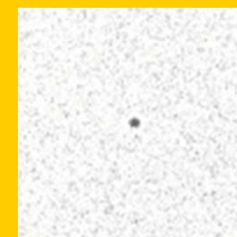

# Homogeneous Sonochemistry Mechanism

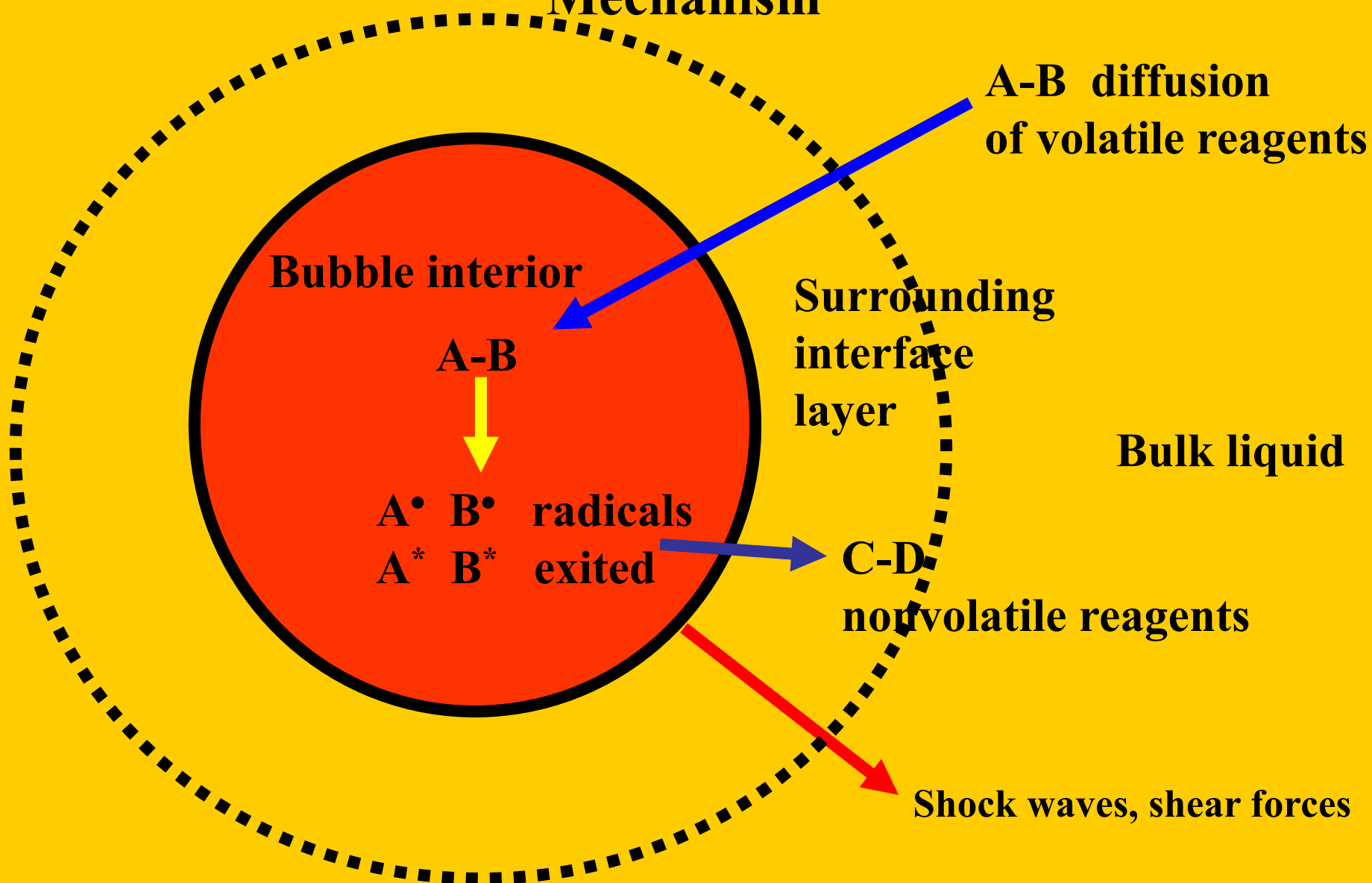

# How to Measure the Temperature inside a Bubble ?

**Sonoluminescence - Light generated during the implosive collapse of bubbles in liquids irradiated with ultrasound**

95% H<sub>2</sub>SO<sub>4</sub>(aq.)  
under Ar

20 kHz (14 W/cm<sup>2</sup>)

Ti horn directly immersed

T = 298 K

Kenneth S. Suslick  
University of Illinois

- Apparent blackbody temperature
- Ar emission
- SO and O<sub>2</sub><sup>+</sup> emission

**8 000 – 15 000 K**

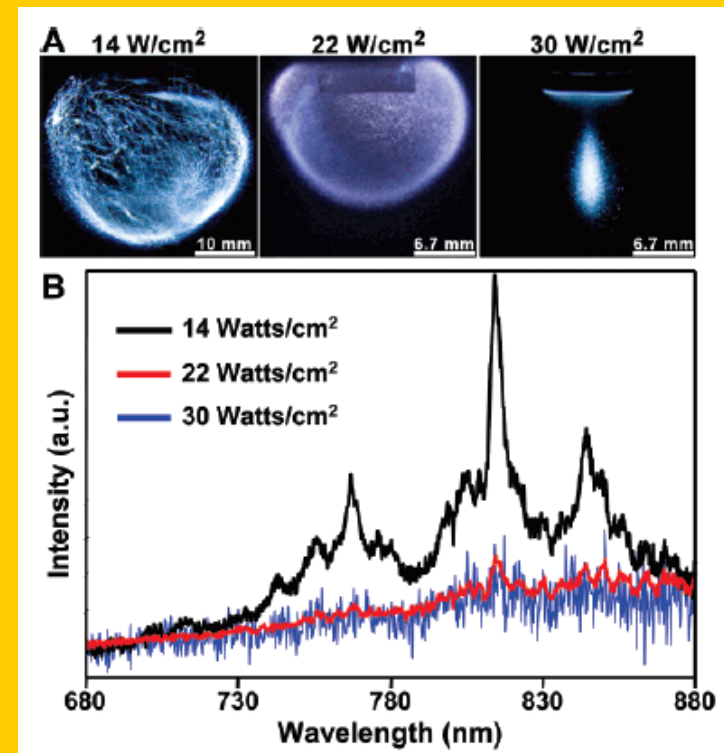

# Temperature/Pressure inside a Bubble

## Neppiras Equation

$$T_{\max} = T_0 \frac{P_a(\gamma - 1)}{Q} \quad P_{\max} = Q \left( \frac{P_a(\gamma - 1)}{Q} \right)^{\frac{\gamma}{\gamma - 1}}$$

$P_a$  = acoustic pressure

$T_0$  = solution temperature

$\gamma = C_p/C_v$

$Q$  = gas pressure inside a bubble upon initiation of the collapse, at its maximum size

Gas	$\gamma = C_p/C_v$
Kr	1.66
Ar	1.66
He	1.63
O <sub>2</sub>	1.41

# Fate of Bubbles under Ultrasonic Irradiation

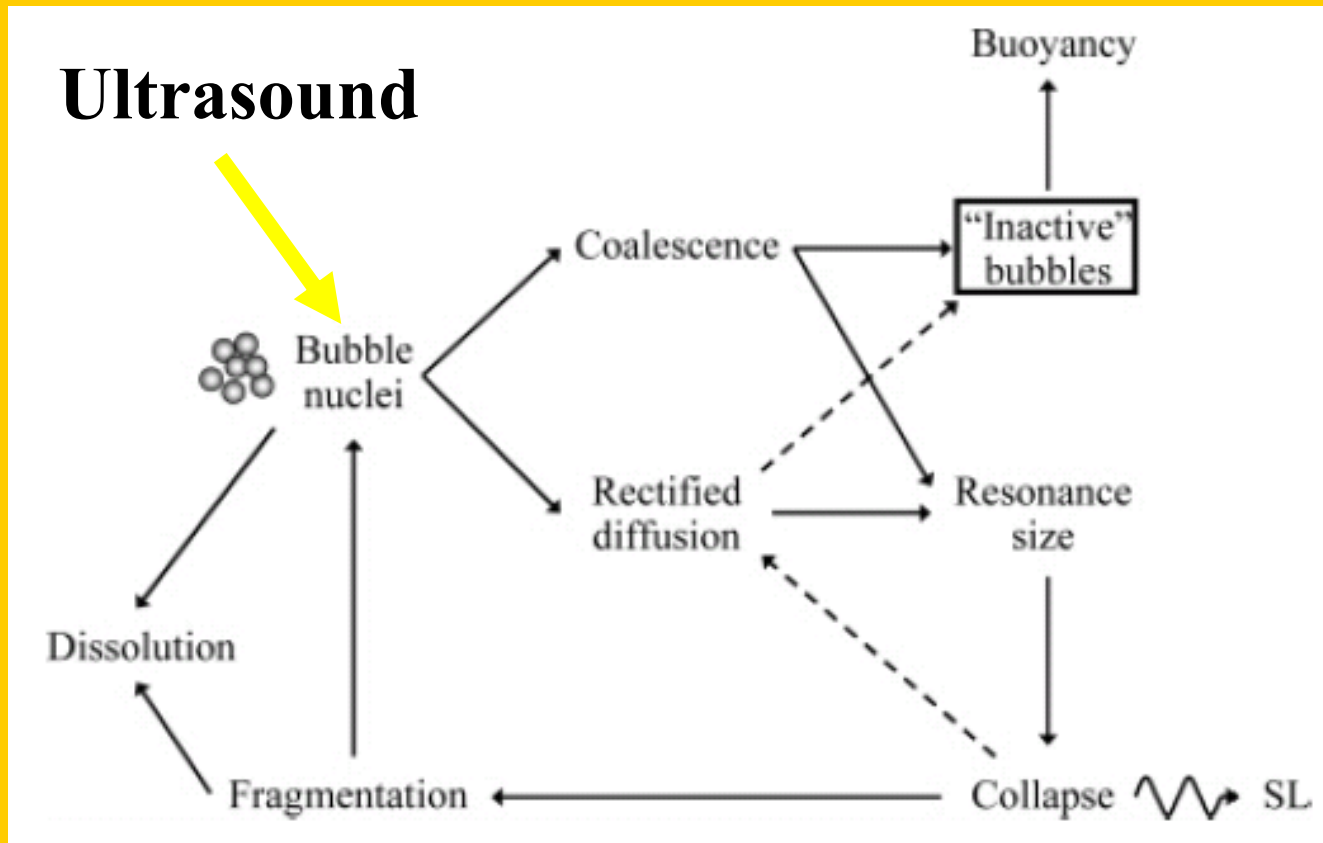

**Rectified diffusion – during expansion phase the bubble has larger surface area – more gas diffuses inside than during compression gets out**

# Single Bubble Sonoluminescence SBSL

**D. F. Gaitan, L. A. Crum, 1990**

**a method to trap a single  
sonoluminescing bubble within an  
acoustic standing wave field**

**Standing acoustic wave field**

**One bubble trapped**

**The bubble oscillates for many cycles**

**Bubble sonoluminescence**

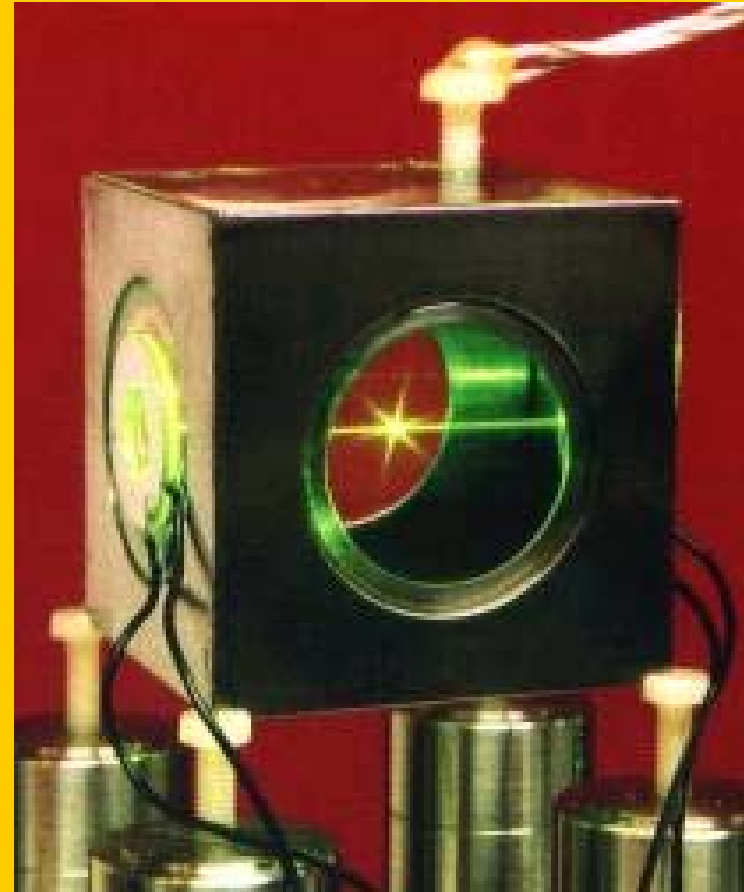

# Single Bubble Sonoluminescence SBSL

D. F. Gaitan, L. A. Crum, 1990

Standing acoustic wave field 1 bar

One bubble levitates in the acoustic field

The bubble oscillates for many cycles

Bubble sonoluminescence

C. A. and V. Bjerknes

The force on an object in a liquid depends on its volume and the pressure gradient, the time averaged force drives the bubble towards the antinode of sound pressure and keeps it there.

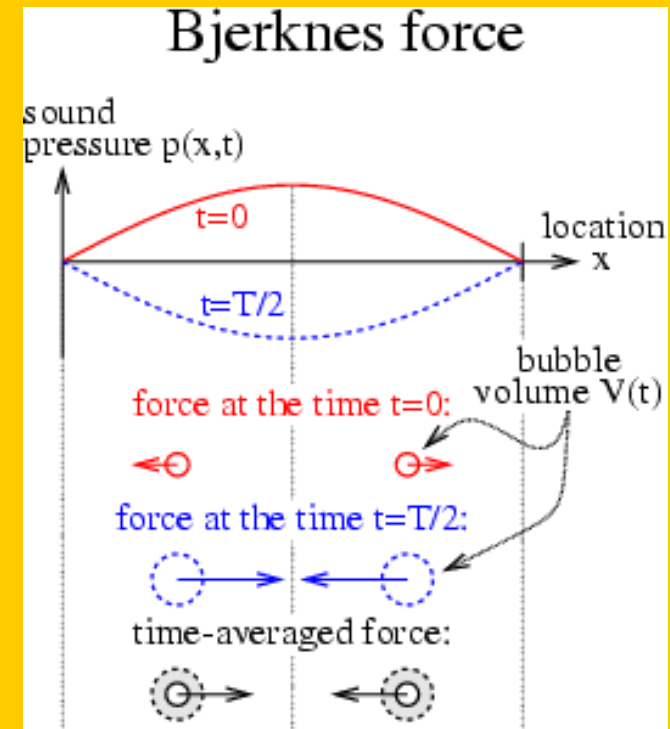



# Single Bubble Sonoluminescence SBSL

Proper conditions for a single  
sonoluminescing bubble within  
an acoustic standing wave field

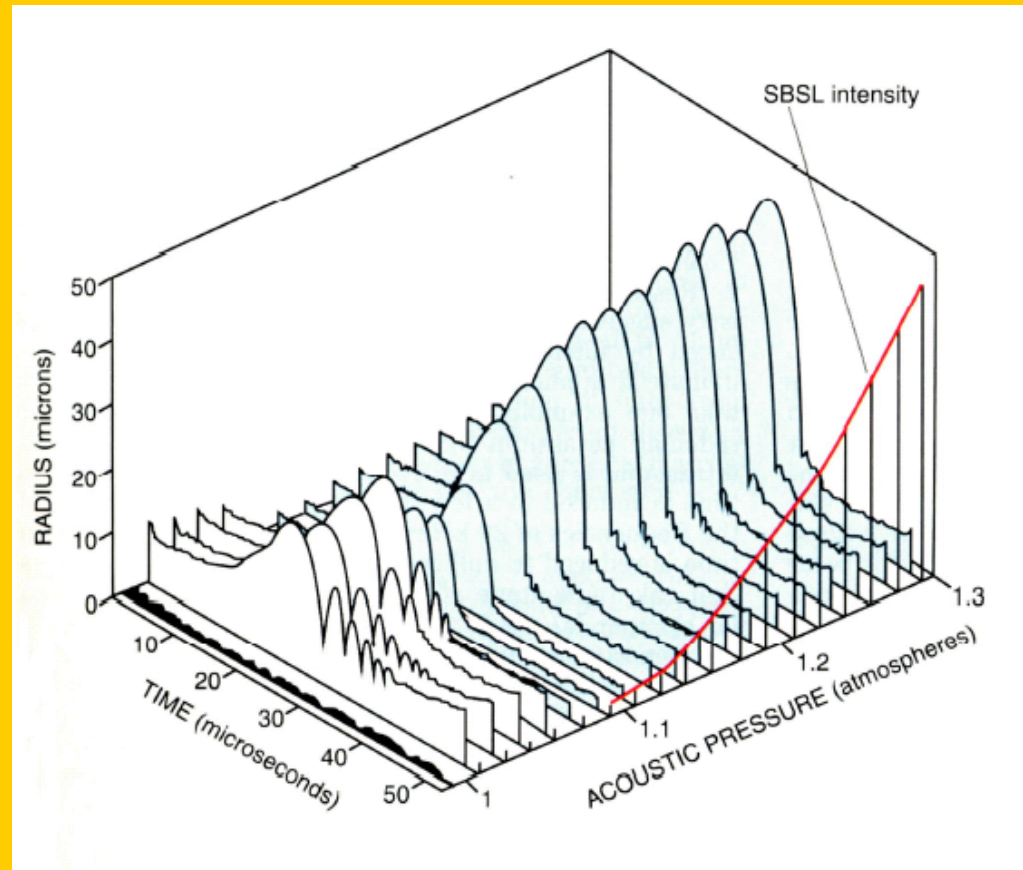

# Single Bubble Sonoluminescence SBSL

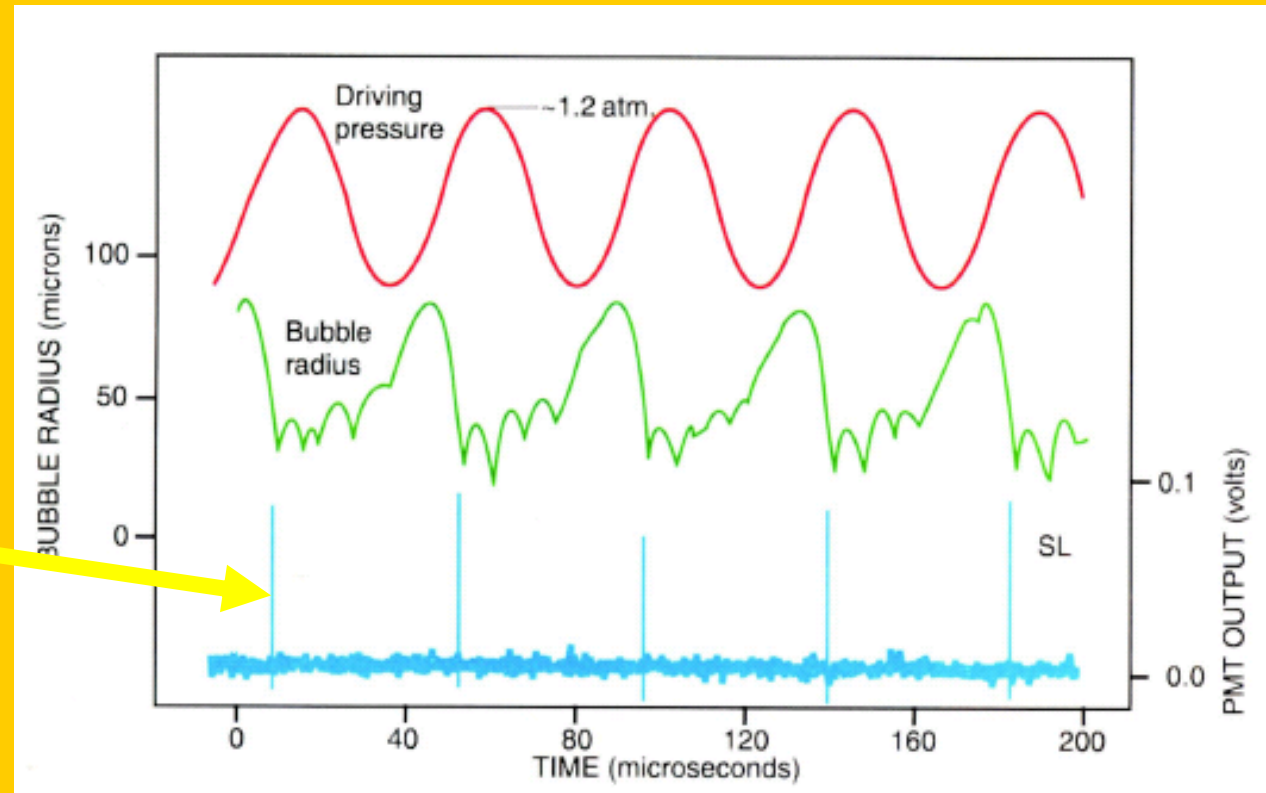

**Sonoluminescence  
Pulses 50 ps**

# Single Bubble Sonoluminescence SBSL

**Red – MBSL in dodecane**

**Blue – MBSL in water, 16 kHz**

**Green – SBSL in water, 43 kHz**

**Black – blackbody curve for 16200 K**

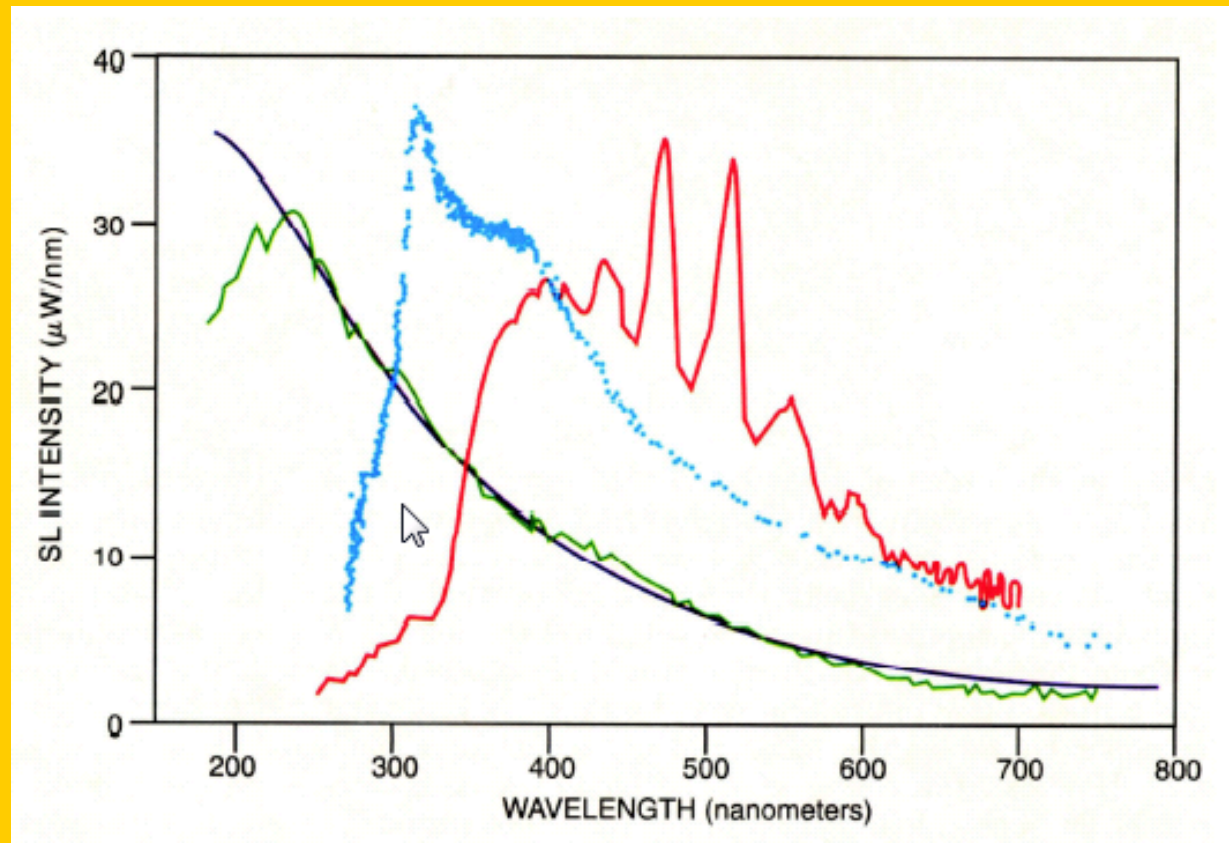

# Single Bubble Sonoluminescence SBSL

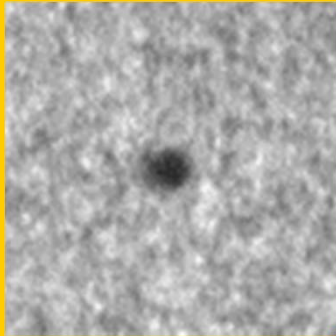

Red - bubble radius  
Green - bubble temperature  
Blue - acoustic pressure 1.3 bar/25 kHz

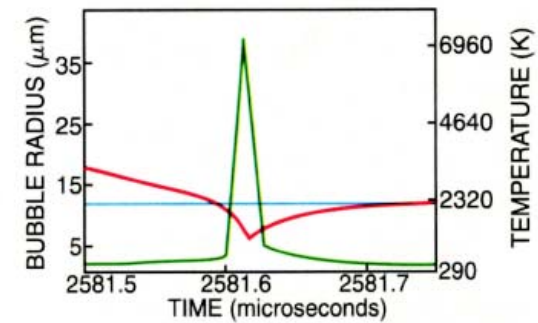
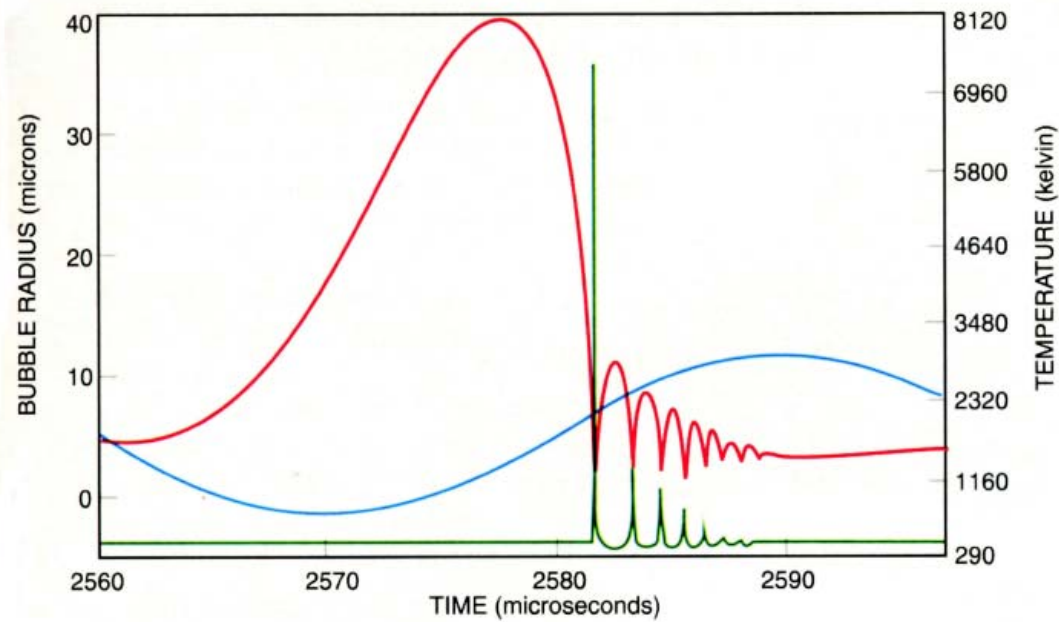

# **Multi Bubble Sonoluminescence**

## **MBSL**

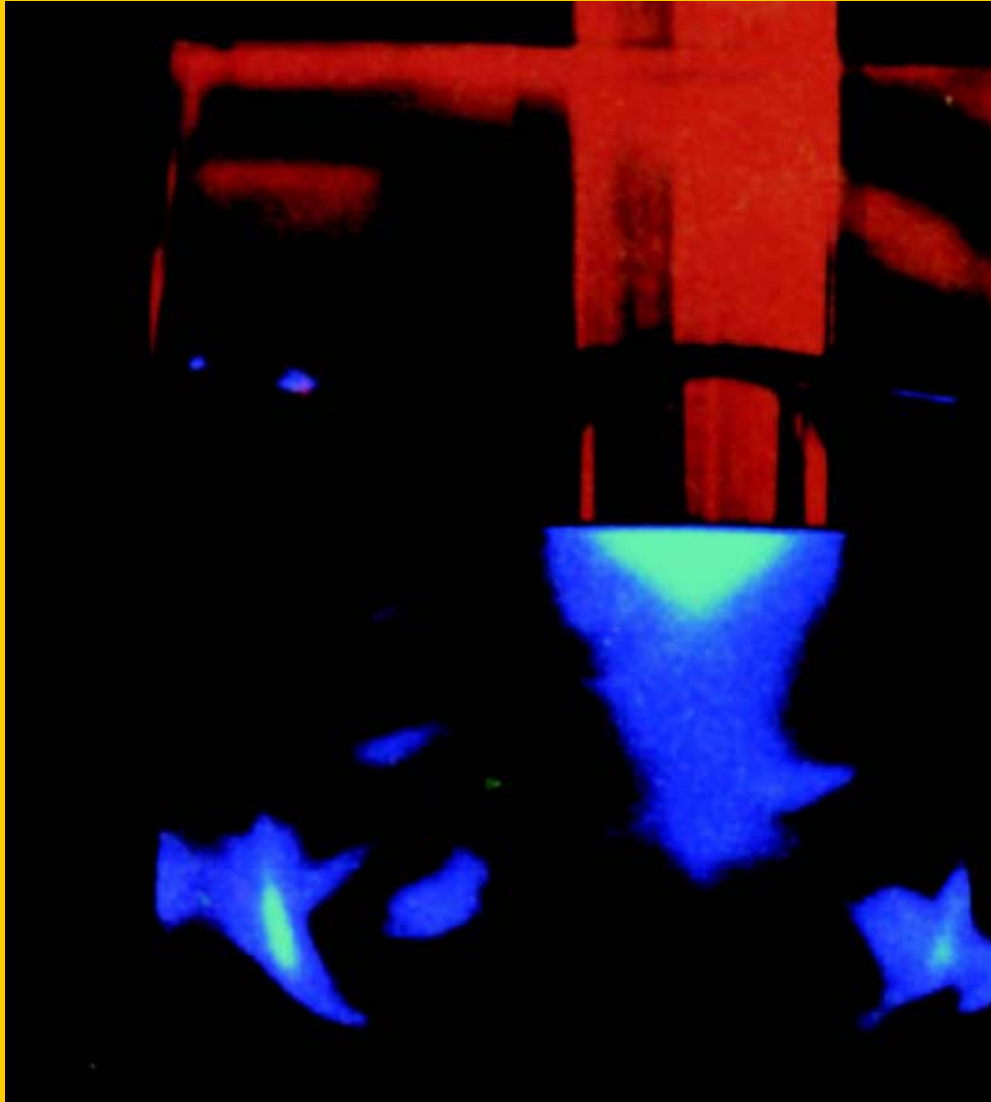

**Multi-bubble sonoluminescence**

**Spatial and temporal average**

**250 bar**

# Sonoluminescence

Light generated during the implosive collapse of bubbles in liquids irradiated with ultrasound

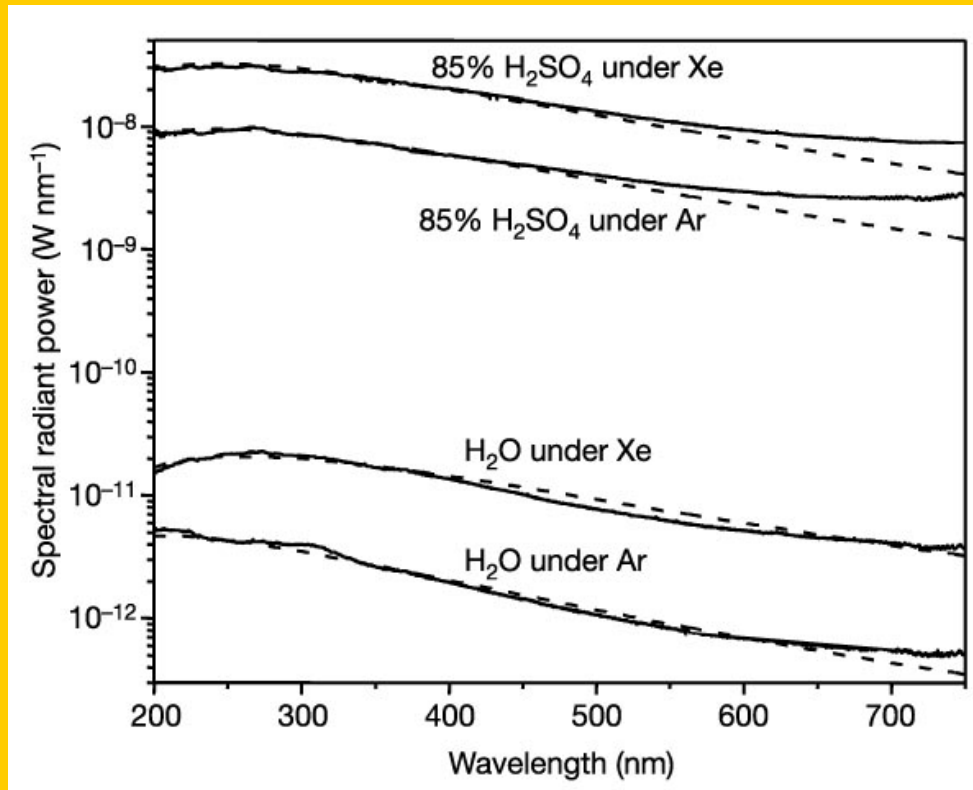

**Apparent  
blackbody  
temperature**  
(all 4 spectra)

**12500 ± 1500 K**

# Sonoluminescence

95% H<sub>2</sub>SO<sub>4</sub>(aq.)

blackbody temperature

Ar emission

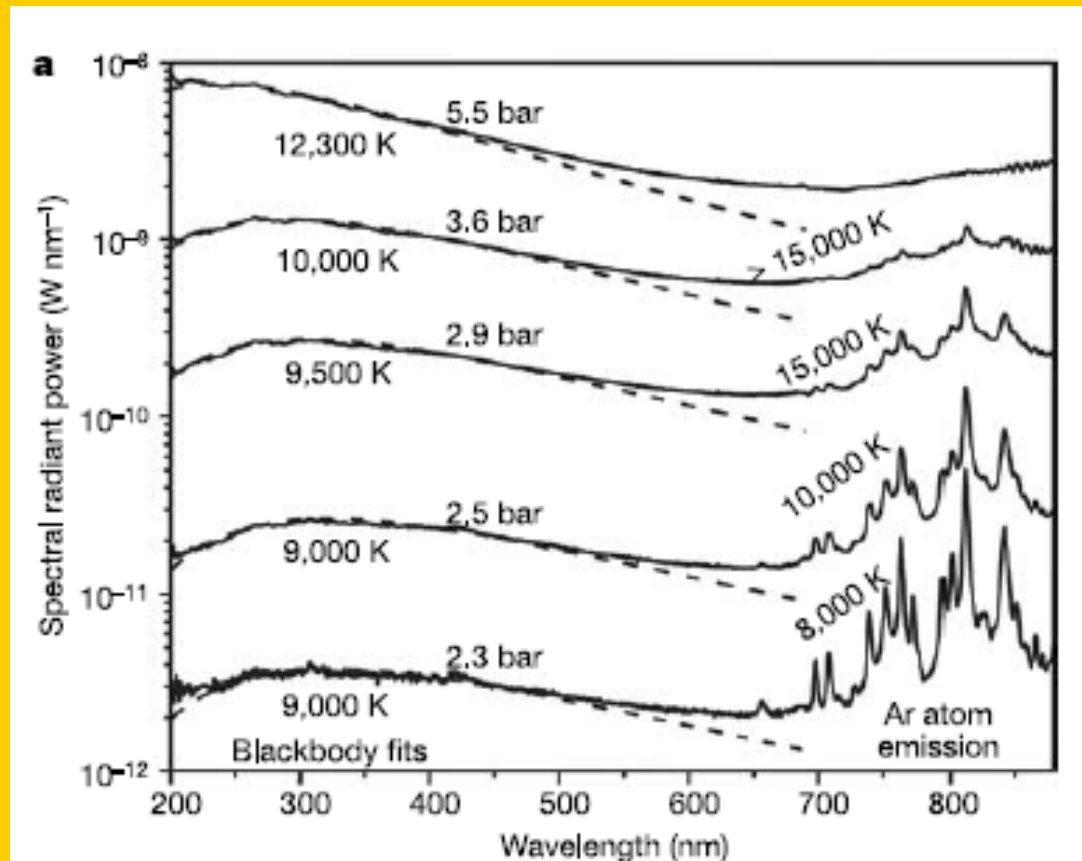

an optically  
opaque  
plasma core

# Sonoluminescence

95% H<sub>2</sub>SO<sub>4</sub>(aq.)

SO and O<sub>2</sub><sup>+</sup> emission  
with vibronic progression

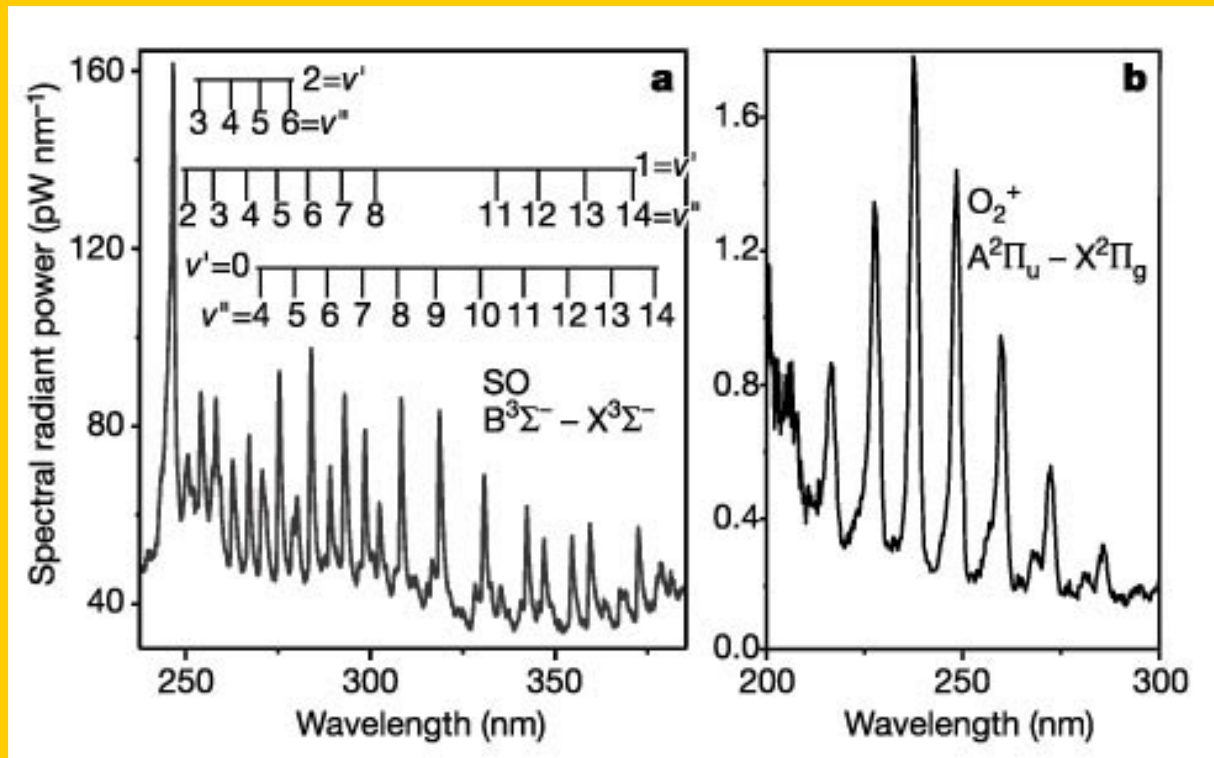

1580 ± 110 K at 3.3 bar

2470 ± 170 K at 4.2 bar

3480 ± 240 K at 5.1 bar



# Sonofusion Fraud

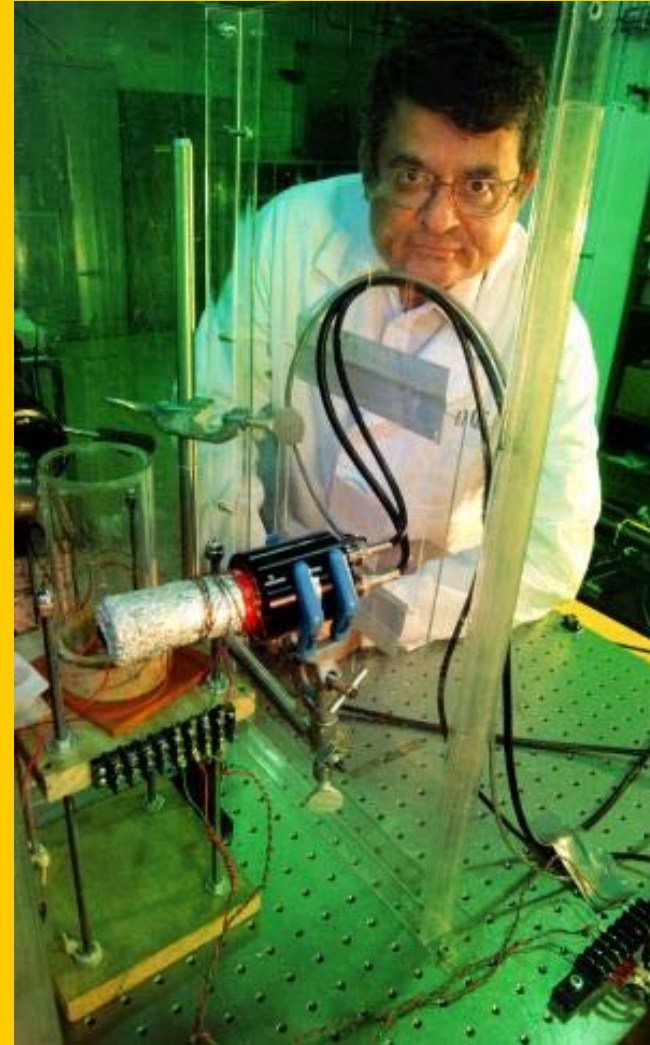
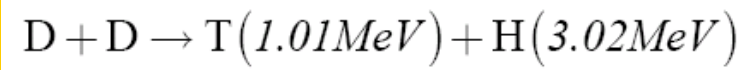
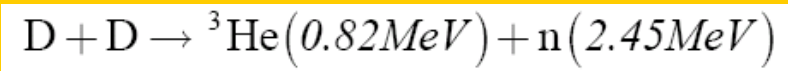

# Sonofusion Fraud

Degassed deuterated acetone

$(CD_3)_2CO, 0^\circ C$

$4 \times 10^5 \text{ neutrons s}^{-1}$

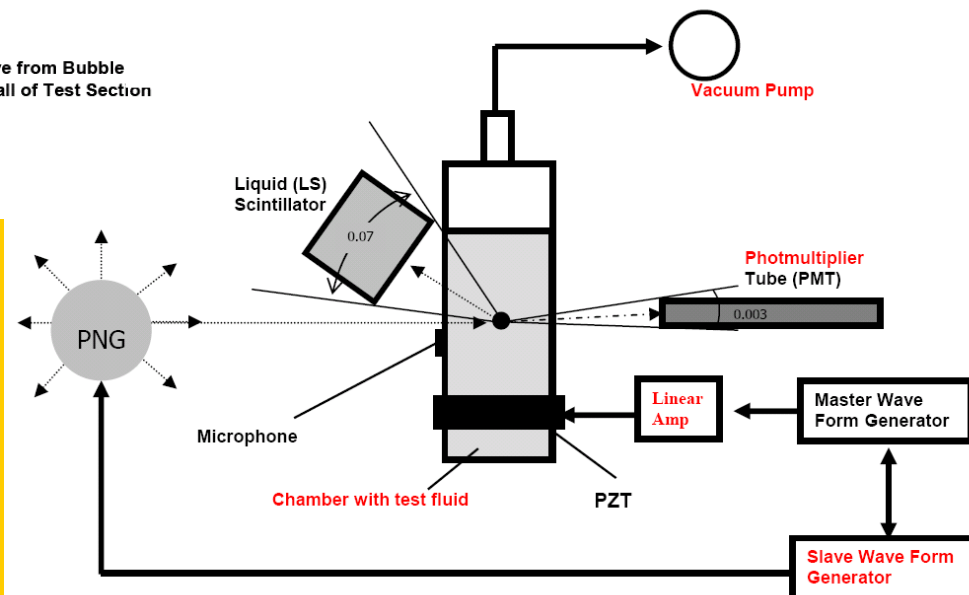
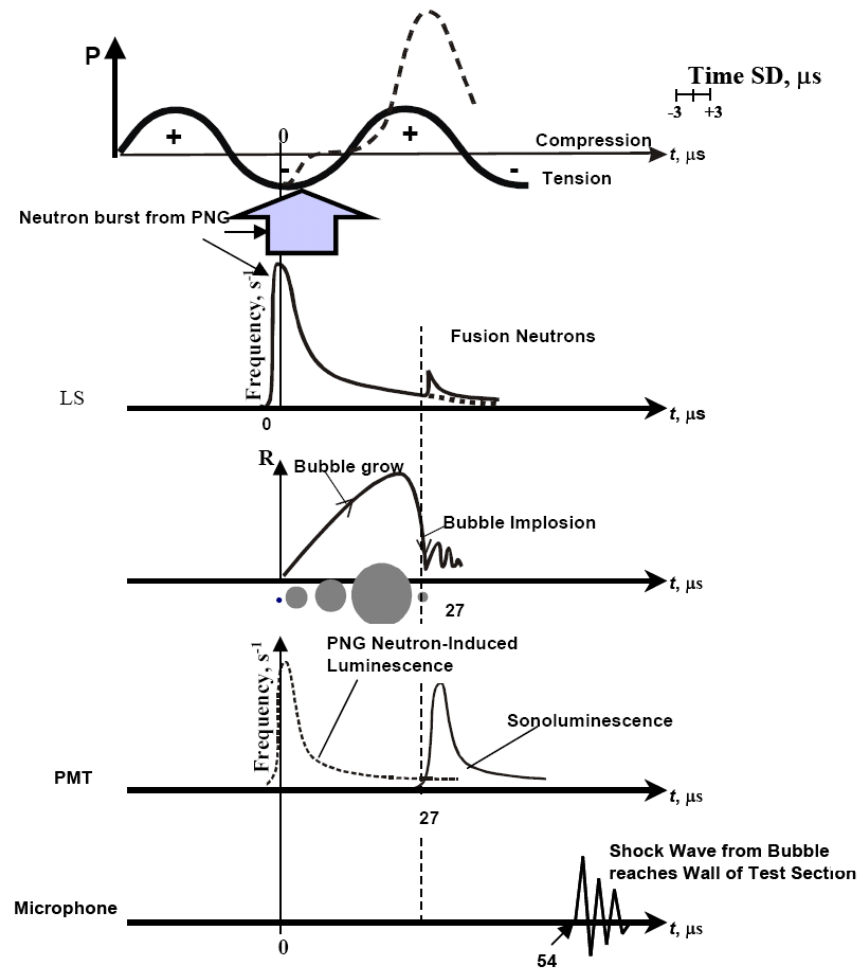

# Power Measurement in Sonochemistry

## Calorimetry

$P$  = power, W

$P_{el}$  = input power to generator

$P_{hf}$  = high-freq. power output

$P_{th}$  = power input into liquid

$$P_{th} = \frac{dT}{dt} c_p m$$

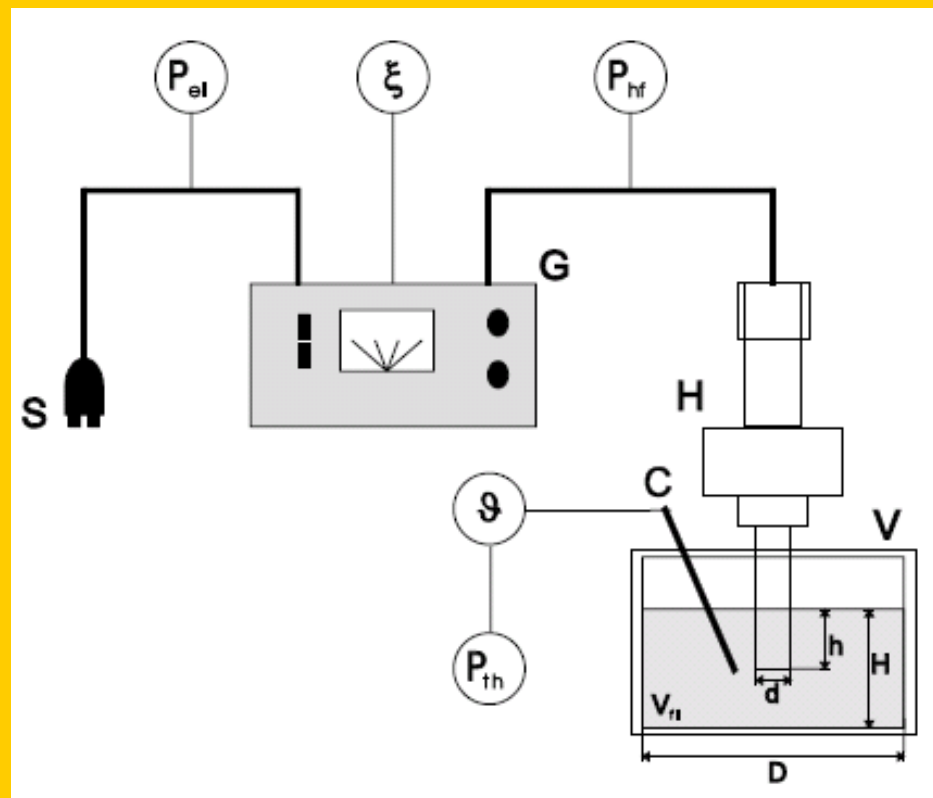

# Power Measurement in Sonochemistry

## Calorimetry

P = power, W

T = temperature, K

t = time, s

$c_p$  = heat capacity, J g<sup>-1</sup> K<sup>-1</sup>

$$P = \frac{dT}{dt} c_p m$$

m = mass, g

Volume 50 cm<sup>3</sup>

Argon atmosphere

Error 5%

heat capacity, J g<sup>-1</sup> K<sup>-1</sup>

Water 4.2

Tetraglyme 2.08

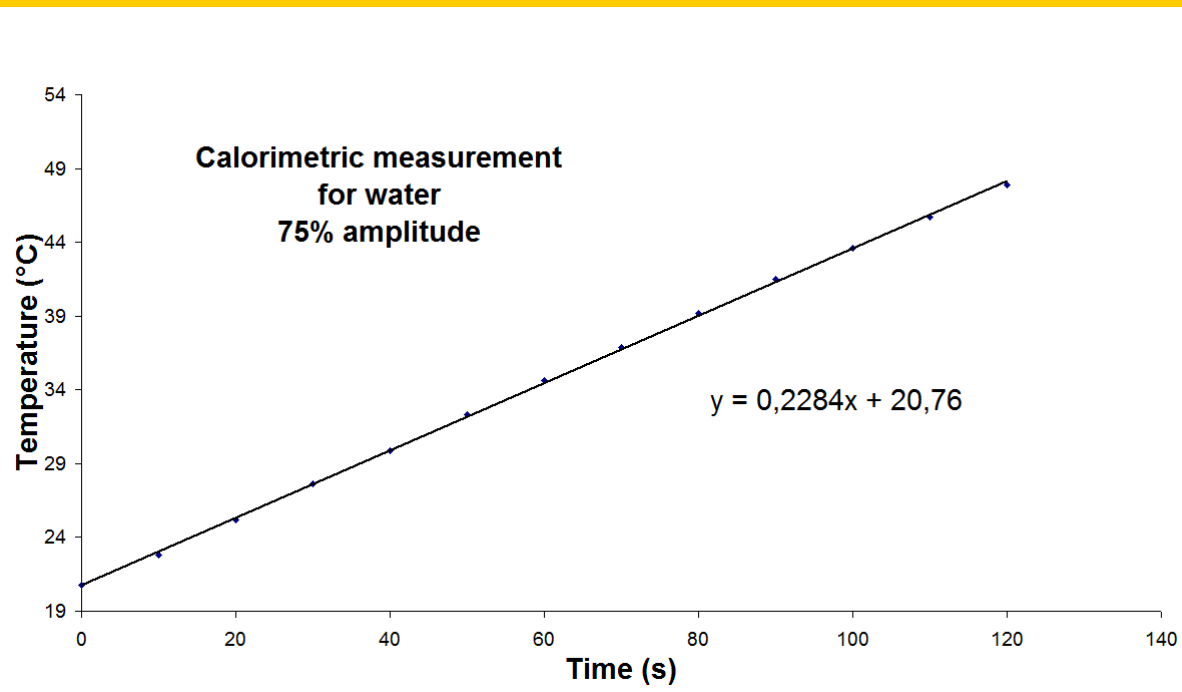

# Power Measurement in Sonochemistry

## Chemical dosimetry

### The Weissler reaction

Volume 50 cm<sup>3</sup>

KI 0.1 M

CCl<sub>4</sub> 0.2 cm<sup>3</sup>

Time 30 min

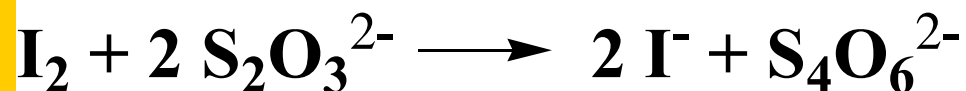
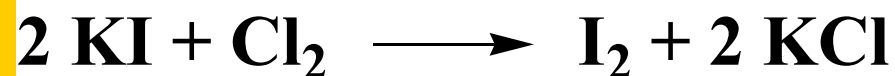

I<sub>3</sub><sup>-</sup>

$\lambda_{\text{max}} = 355 \text{ nm}$

$\epsilon = 26303 \text{ dm}^3 \text{ mol}^{-1} \text{ cm}^{-1}$

## Weissler Reaction

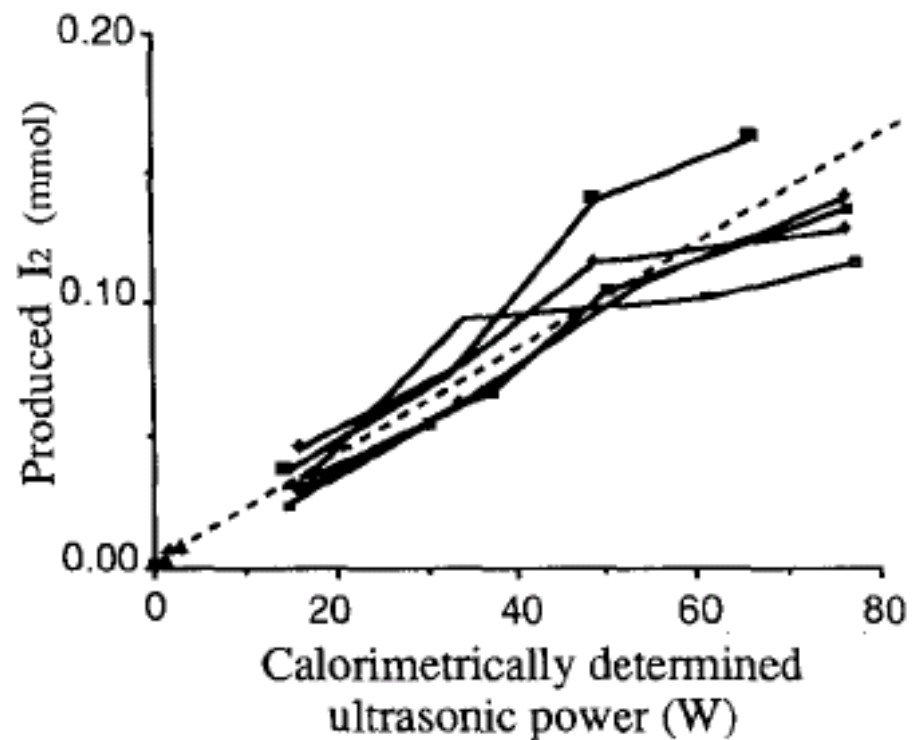
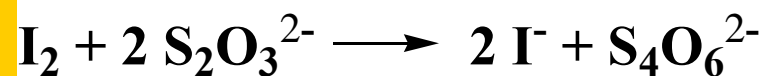
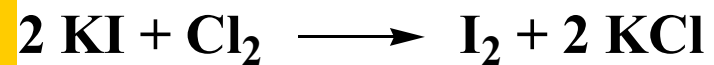

# Power Measurement in Sonochemistry

## Chemical dosimetry

### The Fricke reaction

Volume 50 cm<sup>3</sup>  
(NH<sub>4</sub>) Fe(SO<sub>4</sub>)<sub>2</sub>·6H<sub>2</sub>O  
0.001 M

H<sub>2</sub>SO<sub>4</sub> 0.4 M  
NaCl 0.001 M  
Time 30 min

Fe<sup>3+</sup>  
 $\lambda_{\max} = 304 \text{ nm}$   
 $\varepsilon = 2197 \text{ dm}^3 \text{ mol}^{-1} \text{ cm}^{-1}$

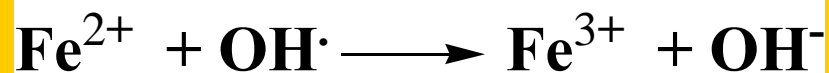

# Fricke Reaction

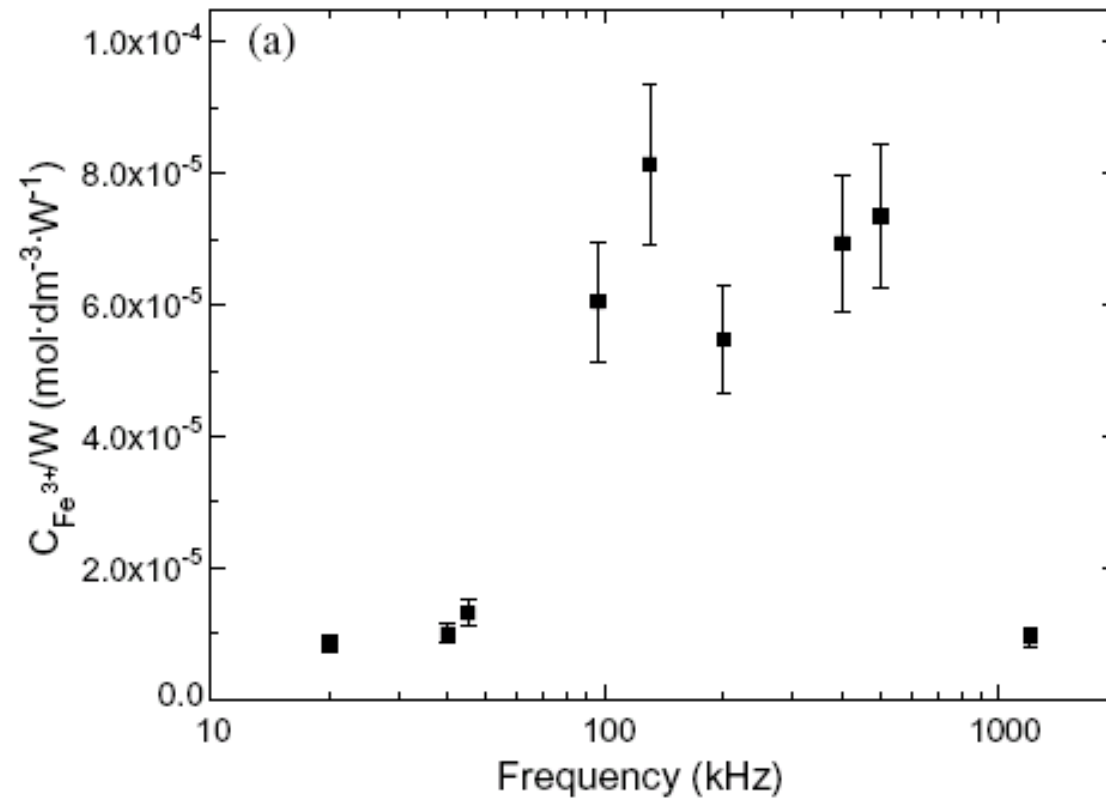
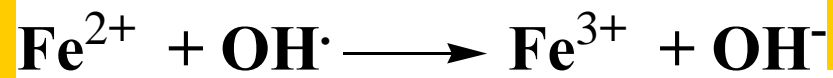
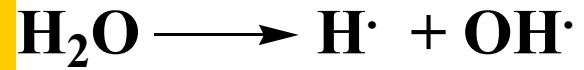



# Power Measurement in Sonochemistry

Chemical dosimetry

Porphyrin decomposition ratio

$$1 - R_{TPPS} = 1 - \frac{C_{TPPS}}{C_{TPPS}^0}$$

TPPS

$3.3 \cdot 10^{-6} \text{ M}$

Volume  $50 \text{ cm}^3$

TPPS

$\lambda_{\text{max}} = 412 \text{ nm}$

$\varepsilon = 500000 \text{ dm}^3 \text{ mol}^{-1} \text{ cm}^{-1}$

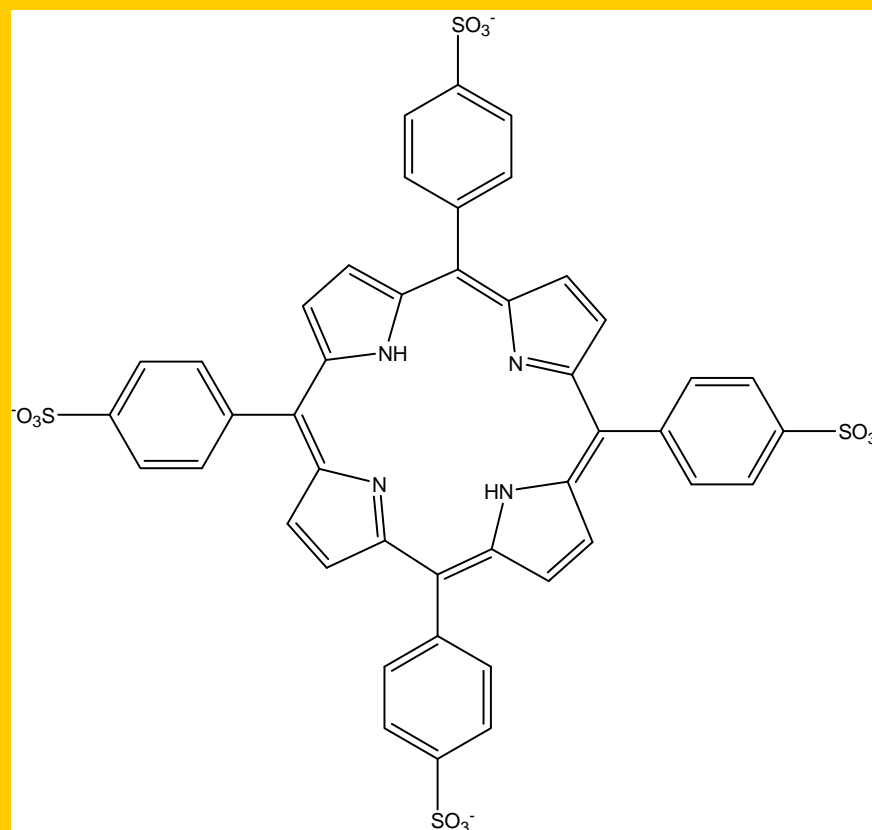

# Porphyrin Decomposition

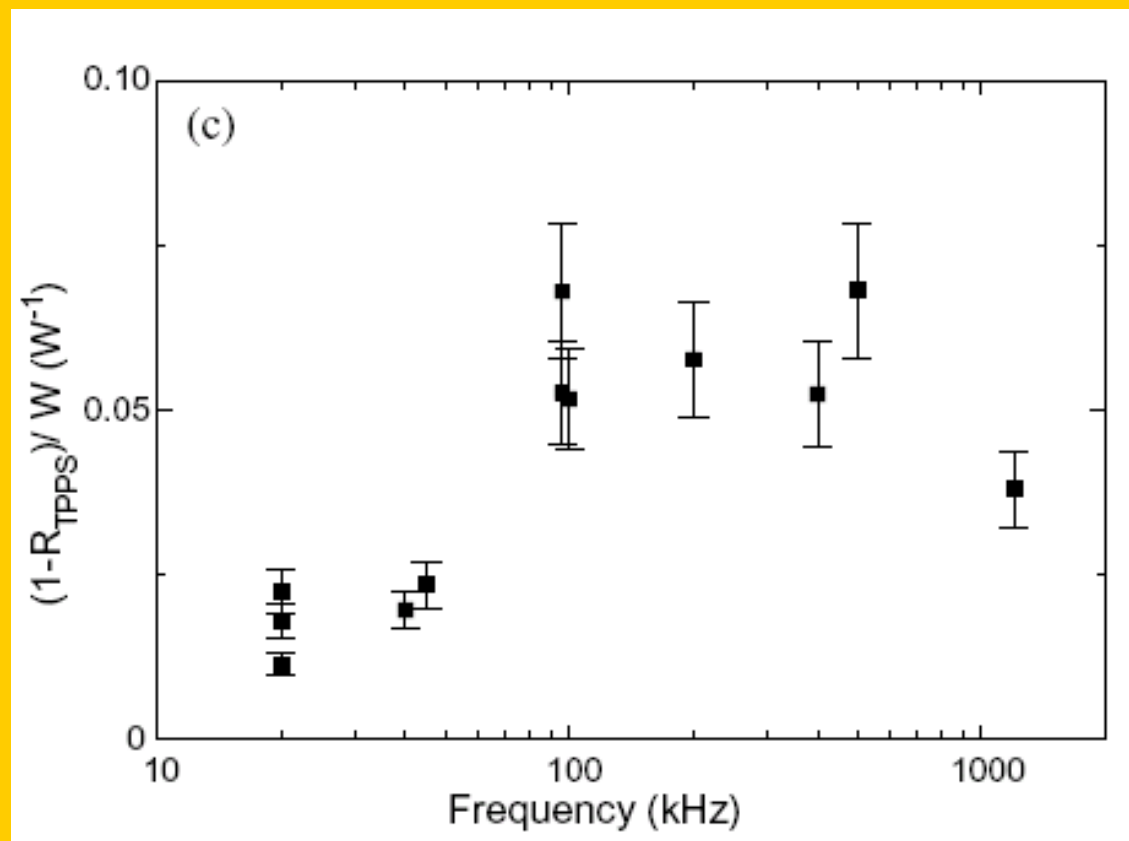

# Power Measurement in Sonochemistry

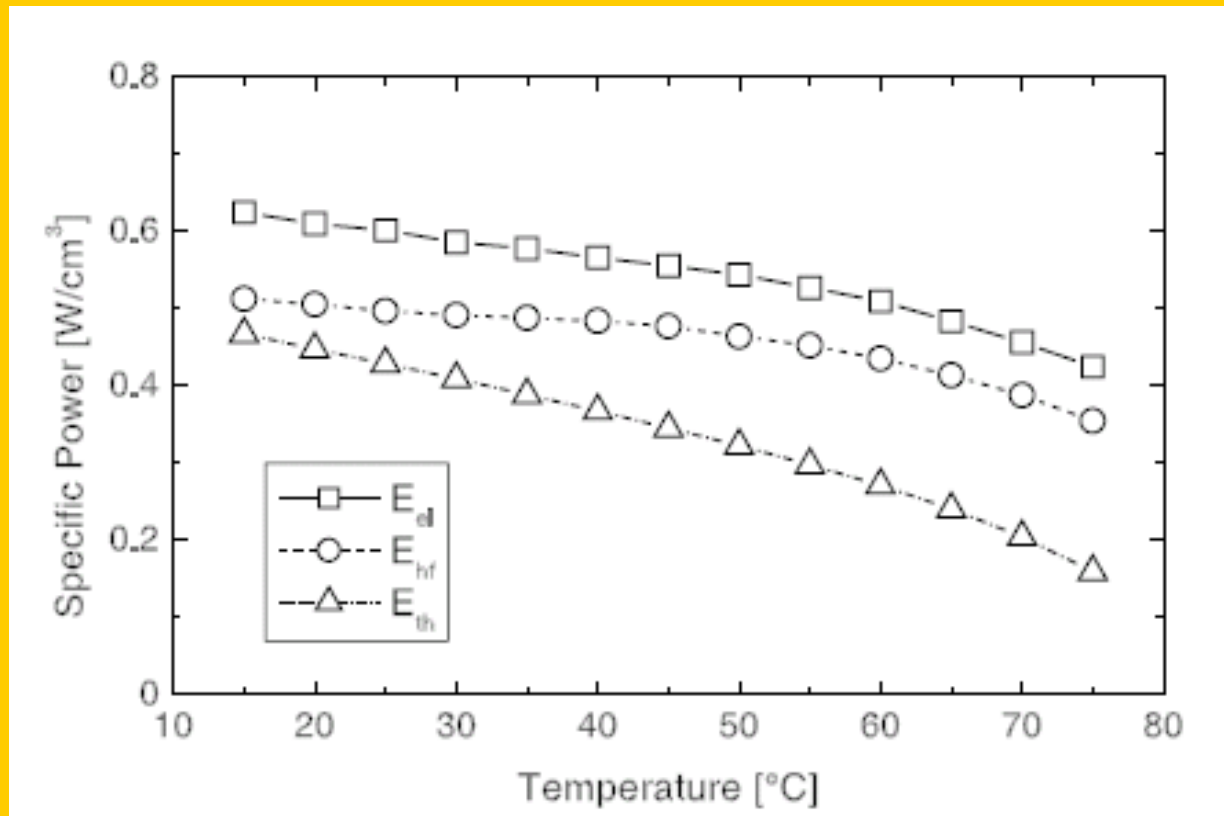

# Reactor Optimization

**cavitating bubbles in the optimised cell (water, 20 kHz,  $P_{us} = 10$  W)  
and simulated intensity distribution for the same geometry**

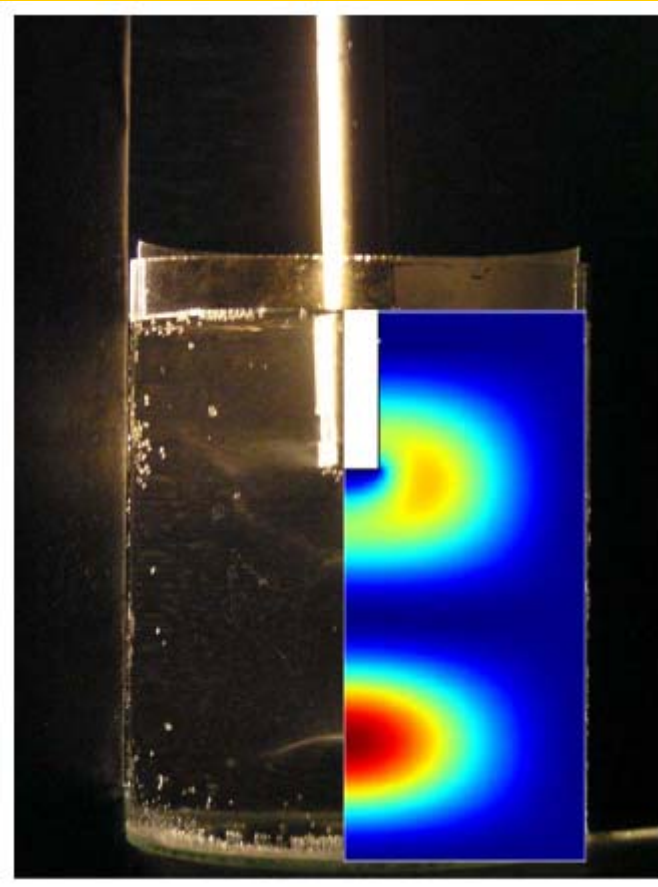
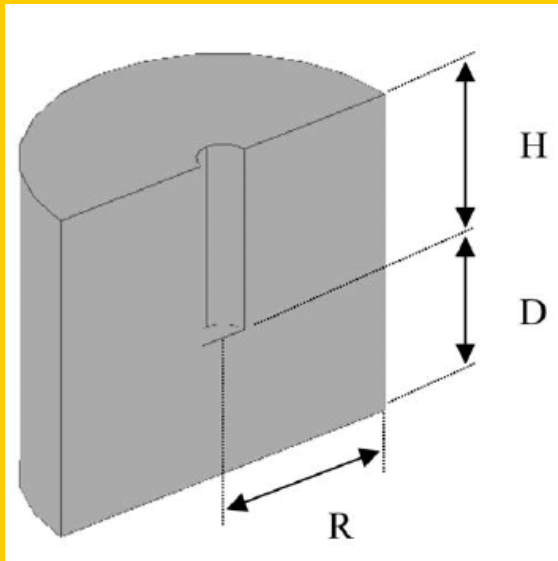

# Heterogeneous Sonochemistry

**Solid surfaces = implosion, microjets, shock waves**  
**200  $\mu\text{m}$  minimum particle size at 20 kHz for microjets**

**surface erosion**

**removal of unreactive coatings (oxides, nitrides, carbonaceous)**

**fragmentation of brittle materials, increased surface area**



# Heterogeneous Sonochemistry

**LARGE PARTICLES**

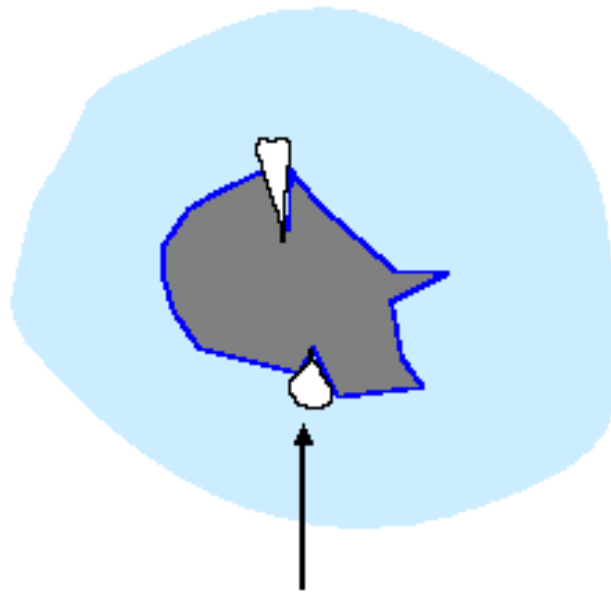

surface cavitation due to defects  
leading to **fragmentation**

**SMALL PARTICLES**

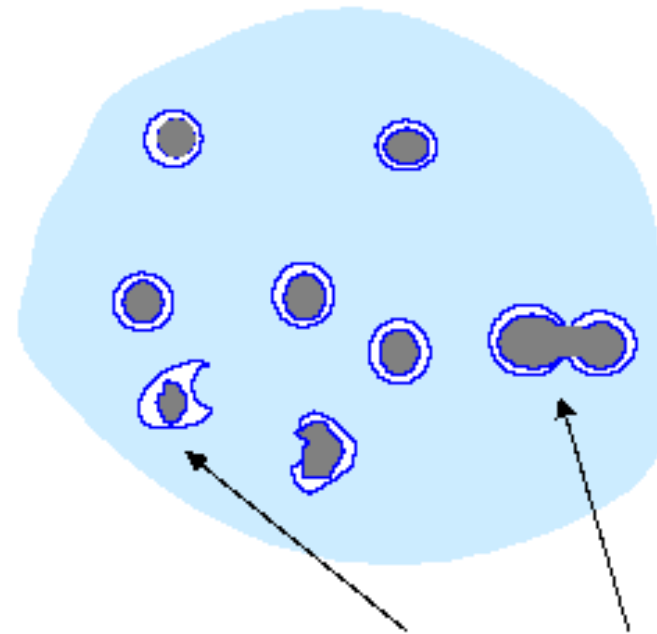

collision can lead to **surface erosion** or **fusion**

# Heterogeneous Sonochemistry

**Solid particles in liquid = shock waves**

**high speed interparticle collisions (500 km/s)**

**surface smoothing, surface coating removal  
Ni catalytic activity in hydrogenation increased  
 $10^5$  fold by NiO removal**

**localized melting of metal particles at the impact  
point fragmentation, increased surface area  
intercalation rates enhanced 200 fold in layered  
oxides and sulfides ( $V_2O_5$ ,  $MoO_3$ ,  $MoS_2$ ,  $ZrS_2$ ,  
 $TaS_2$ )**

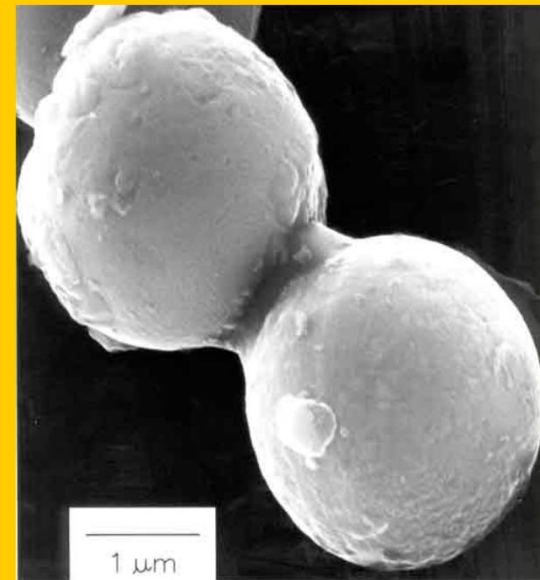

# Heterogeneous Sonochemistry

**Metal powders**

**Cr (mp 2130 K) and Mo (mp 2890 K) agglomerate**

**W (mp 3683 K) does not**

**temperature at the point of impact ~ 3000 °C**

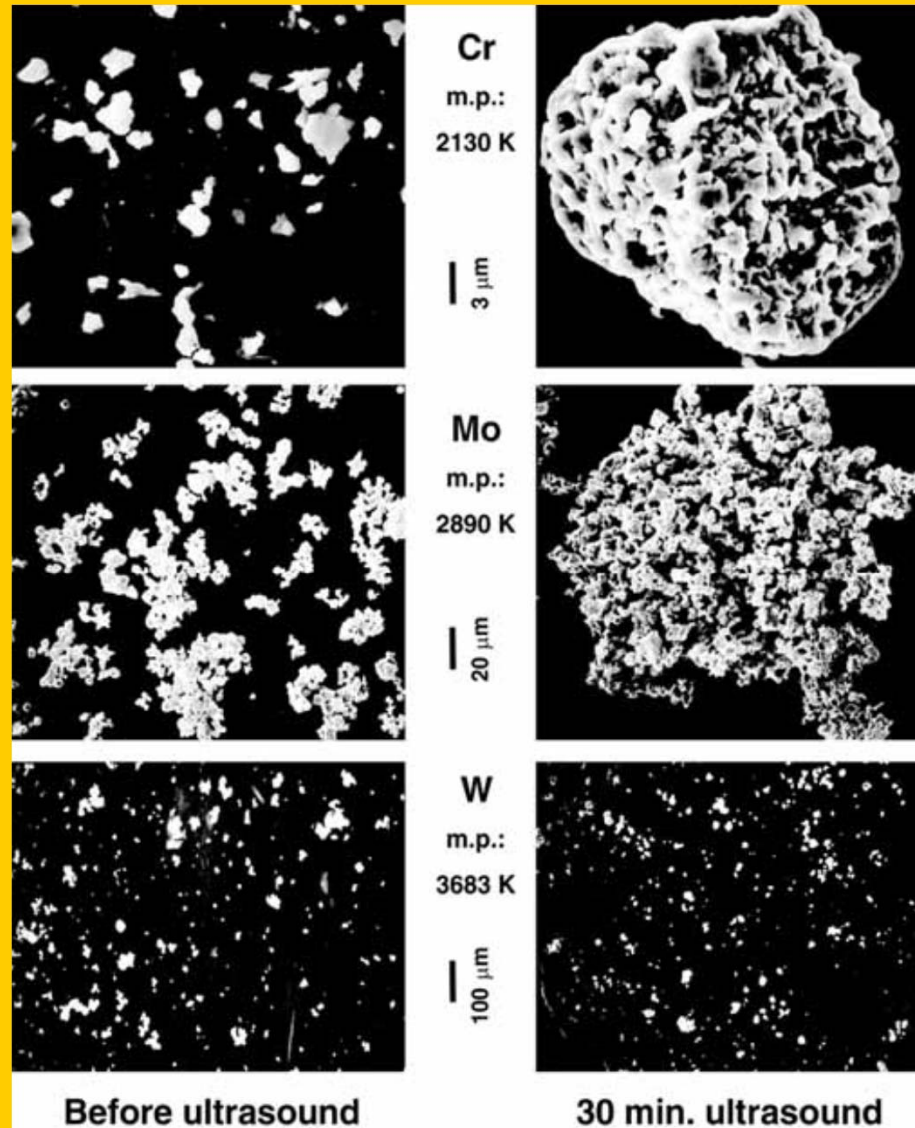



## **Cavitation Corrosion of the Tip**



# Control of Sonochemical Reactions

**sound intensity** - minimum for cavitation threshold, depends on frequency, optimum intensity for given reaction conditions, at high powers great number of bubbles hinder sound transmission, decoupling of a liquid from the source, breakdown of transducer material,  $10 - 100 \text{ W cm}^{-2}$

**sound frequency** - 20 – 100 kHz, the higher the frequency, the higher power needed to actuate cavitation, stronger cavitation effects, rarefaction phase shortens at high frequency

**sound attenuation** - proportional to the frequency, more power needed at high frequencies

## Effect of Frequency on Cavitation in Water

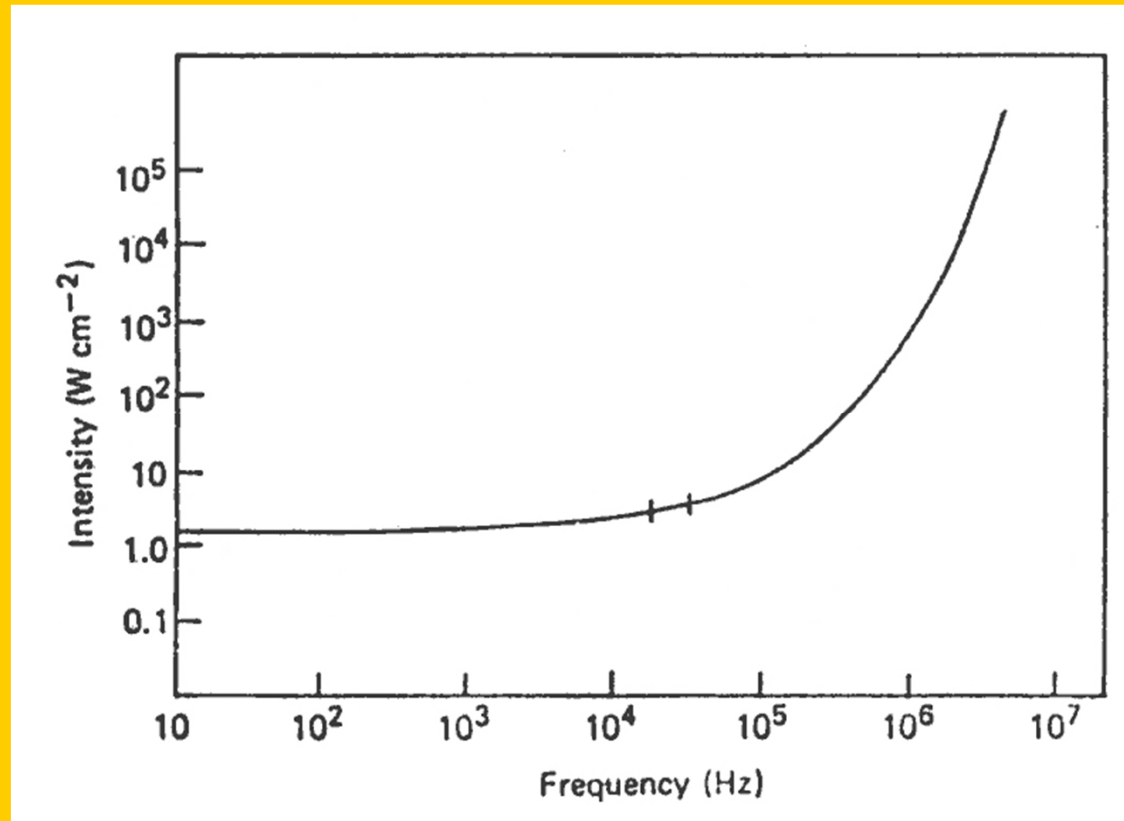

**The frequency dependence of the intensity required to produce cavitation for degassed water at room temperature. The intensity required to produce vaporous cavitation above the frequency of 100 kHz rises rapidly.**

# Control of Sonochemical Reactions

**volatile reactants - primary reaction site inside the bubbles, diameter 200  $\mu\text{m}$ , 5000  $^{\circ}\text{C}$ , easy bubble formation, more reactant vapors inside bubbles, but the cavitation is cushioned**



**nonvolatile reactants - reaction in the thin layer (200 nm) surrounding the bubble, 2000  $^{\circ}\text{C}$ , less cushioning, more energetic cavitation (collapse)**

**high boiling solvents - high vapor pressure inside the bubble cushions the implosion, nonvolatile solvents give less cushioning, more energetic cavitation**

**less cavitation in viscous liquids, viscosity resists shear forces**

**low surface tension facilitates cavitation, in water add surfactants**

# Control of Sonochemical Reactions

**temperature - higher temperature increases vapor pressure of a medium, lowers viscosity and surface tension, many bubbles formed at temperatures close to solvent boiling point, a barrier to sound transmission, reaction rates decrease with increasing temperature, more vapors in bubbles**

**ambient gas**

**energy developed on bubble collapse:**

**monoatomic (Ar) > diatomic (N<sub>2</sub>) > triatomic (CO<sub>2</sub>)**

**Xe: low thermal conductivity, heat of the collapsing cavity retained**

**He: high thermal conductivity, heat of the collapsing cavity dissipated, no reaction**

**external pressure - higher pressure suppresses bubble formation but makes cavitation more energetic, optimum pressure for a given frequency**

## Effect of Temperature on Cavitation in Water

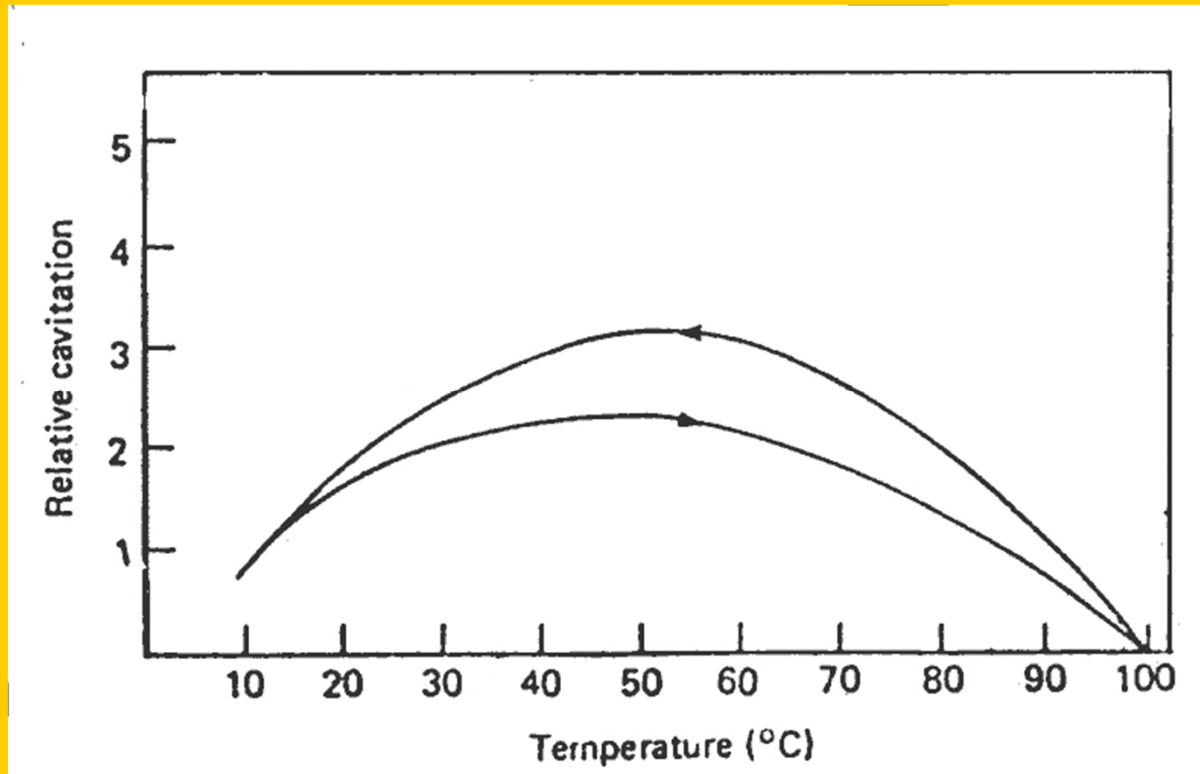

The effect of temperature on cavitation and its associated hysteresis effect for tap water. The increase in intensity as the temperature is increased can be observed before it falls away at the boiling point. When the temperature is allowed to fall an increase in intensity is found in the region of 50-60 °C. This is quite a significant effect and appears to occur in all liquids.

# Sonochemical Reactions

**Solid surfaces = implosion, microjets, shock waves**

**200  $\mu\text{m}$  minimum particle size at 20 kHz for microjets**

**surface erosion**

**removal of unreactive coatings (oxides, nitrides, carbonaceous)**

**fragmentation of brittle materials, increased surface area**

**Li, Mg, Zn, Al, Cu react at room temperature**



# Homogeneous Sonochemical Reactions

Liquids = heating/cooling by cavity implosions



precursor decomposition:



nitrides, carbides, sulfides

alkane cracking

polymer degradation, lower MW, surface modification

emulsification of immiscible liquids (oil-water, Hg-organics, polymer-inorganics)



## $M(\text{acac})_n$ as Precursors

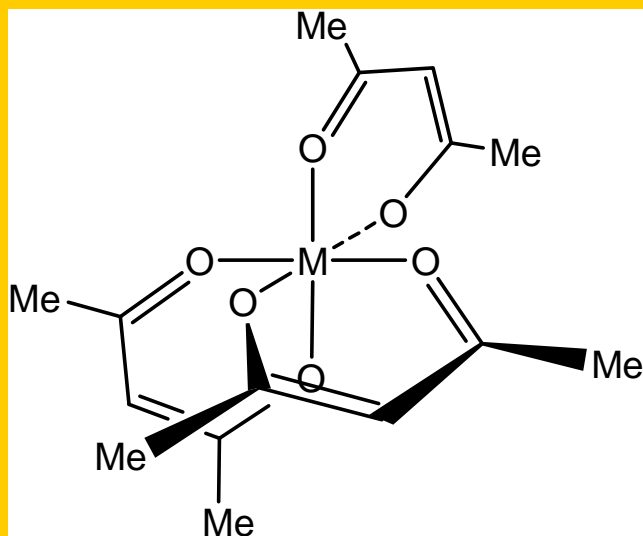

- Well studied class of compounds
- Many elements form acac complexes
- Metal complexes – precursors in CVD, sol-gel, thermolysis routes to oxides
- Easily chemically modified
- Volatile, organics soluble
- Nontoxic

# Chemistry of $M(\text{acac})_n$ Precursors

## Thermal decomposition pathway

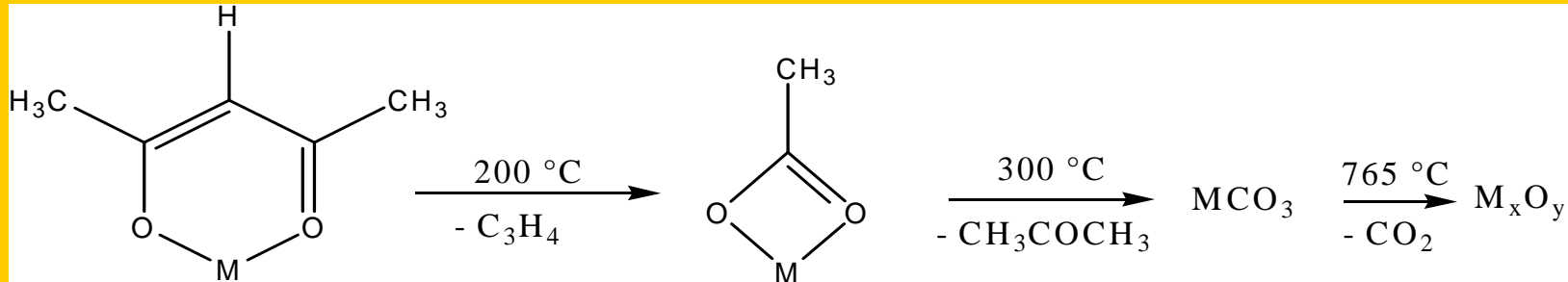

Ismail, H. M. *J. Anal. Appl. Pyrolysis* 1991, 21, 315–326.

## Ligand Removal by Water

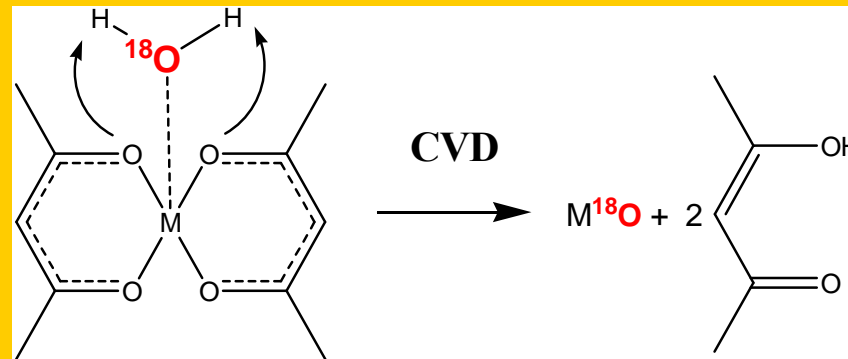

Pinkas, J.; Huffman, J. C.; Baxter, D. V.; Chisholm, M. H.; Caulton, K. G. *Chem. Mater.* 1995, 7, 1589–1596.

# Sonochemical Synthesis of Iron Oxide Nanoparticles

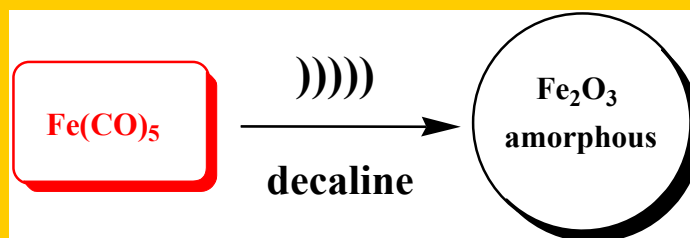

Cao, X.; Prozorov, R.; Koltypin, Y.; Kataby, G.; Felner, I.; Gedanken, A. *J. Mater. Res.* 1997, 12, 402–406.

Cao, X.; Koltypin, Yu.; Prozorov, R.; Katabya, G.; Gedanken, A. *J. Mater. Chem.* 1997, 7, 2447–2451.

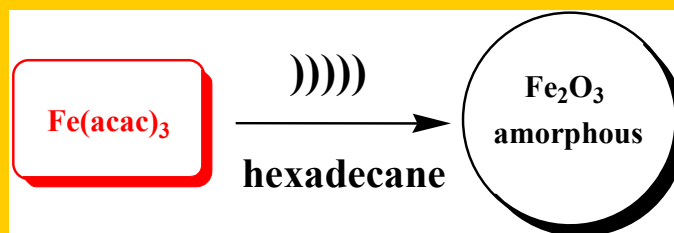

**Amorphous product, by heating to 700 °C converted to  $\alpha$ -Fe<sub>2</sub>O<sub>3</sub> 20–40 nm**

Nikitenko, S. I.; Moisy, Ph.; Seliverstov, A. F.; Blanc, P.; Madic, C. *Ultrasonics Sonochem.* 2003, 10, 95–102.

# Sonochemical Synthesis of Iron Oxide Nanoparticles

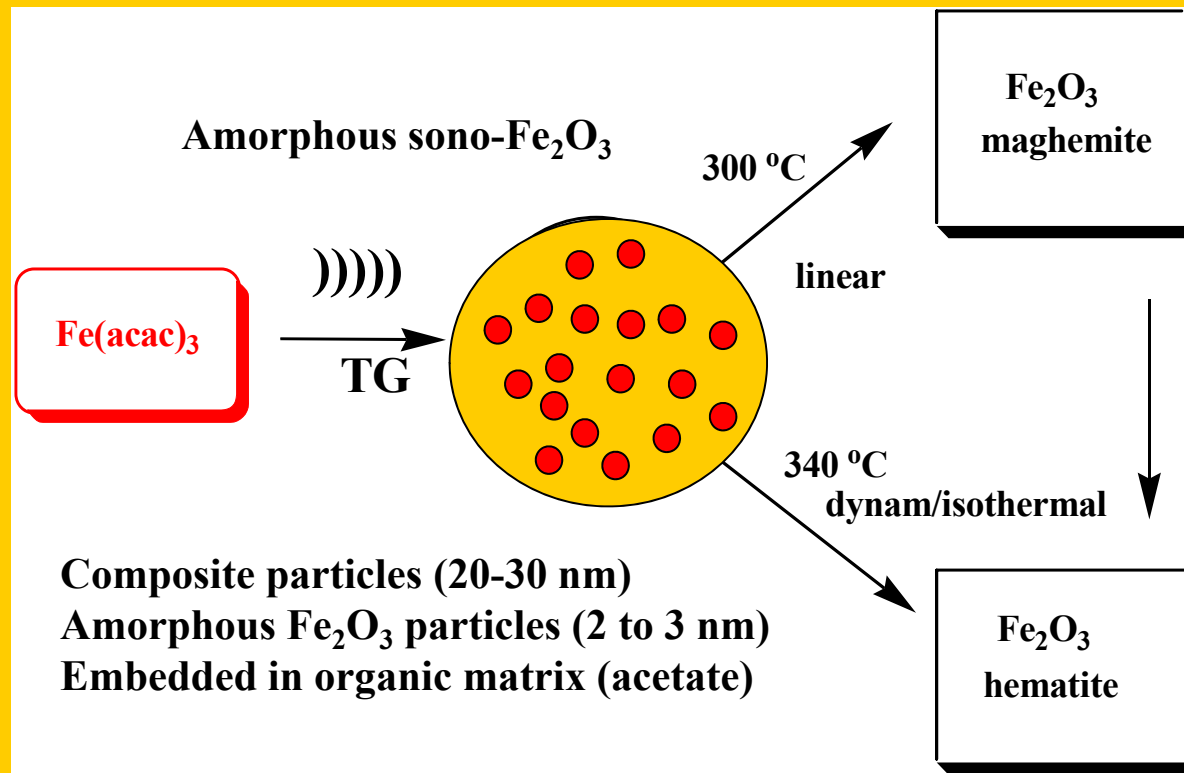

## Defect spinel

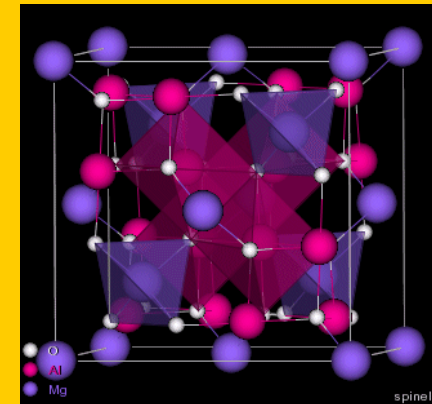

## Corundum



J. Pinkas, V. Reichlova, R. Zboril, Z. Moravec, P. Bezdicka, J. Matejkova: Sonochemical synthesis of amorphous nanoscopic iron(III) oxide from Fe(acac)<sub>3</sub>

*Ultrasonic Sonochem.* 2008, 15, 256-264

## SEM of Nanoscopic Fe<sub>2</sub>O<sub>3</sub>

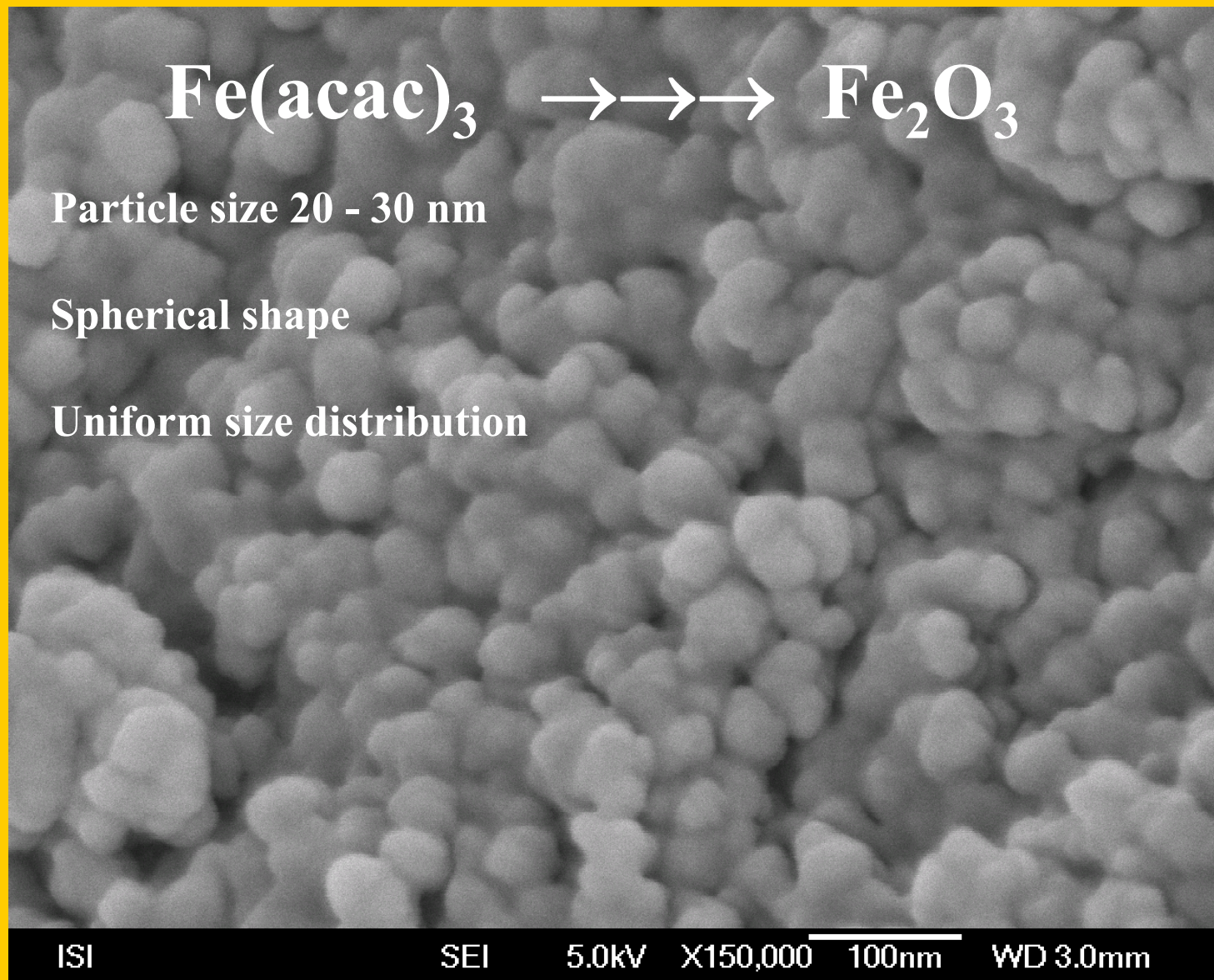

# IR Spectrum of Sono-Fe<sub>2</sub>O<sub>3</sub>

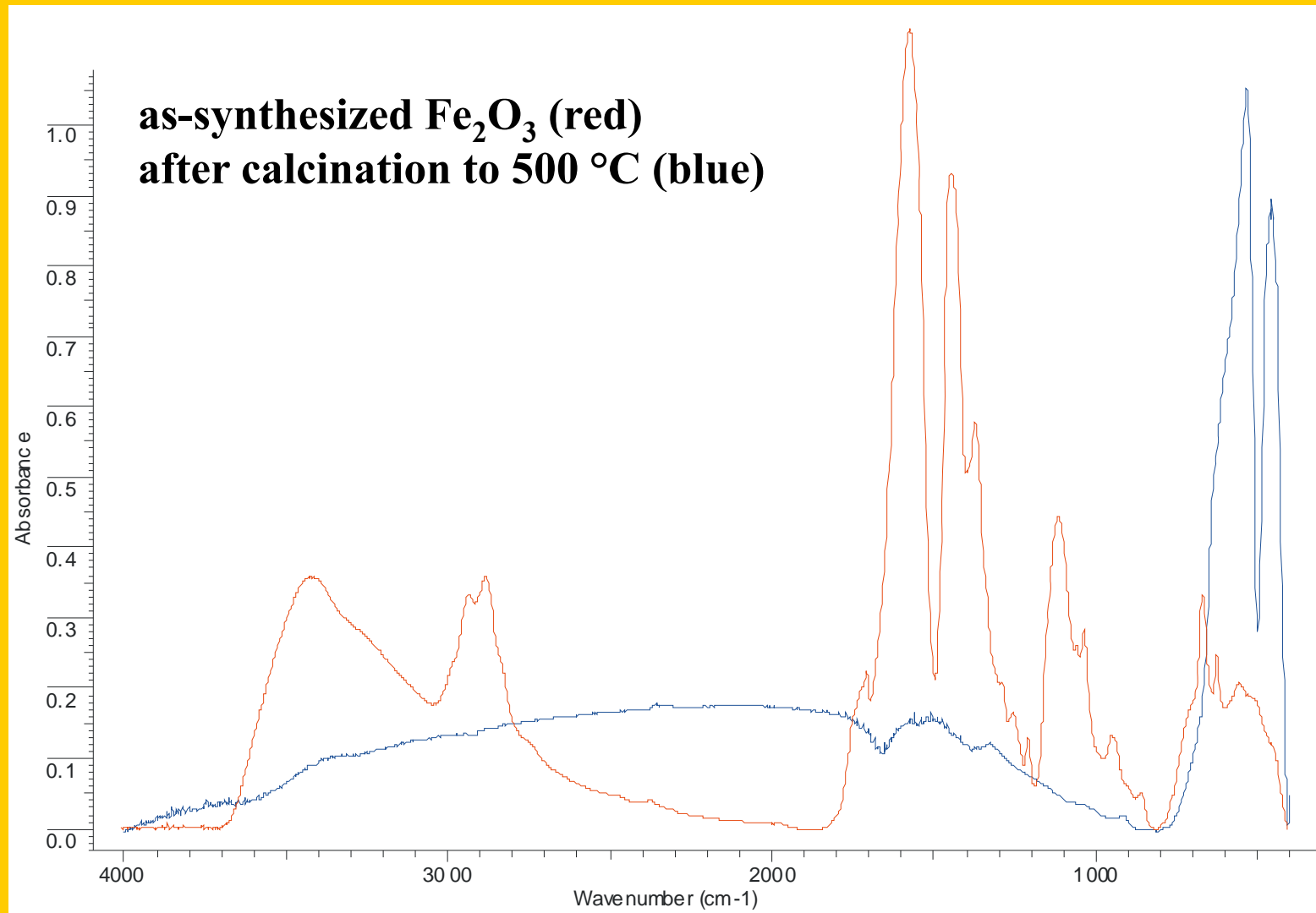

# IR Spectrum of Sono-Fe<sub>2</sub>O<sub>3</sub>

## Acetate stretching

Diketonate vibr. absent

$\nu_{as}(\text{COO})$   
**1566 cm<sup>-1</sup>**

$\nu_s(\text{COO})$   
**1432 cm<sup>-1</sup>**

$$\Delta = \nu_{as}(\text{COO}) - \nu_s(\text{COO}) = 134 \text{ cm}^{-1}$$

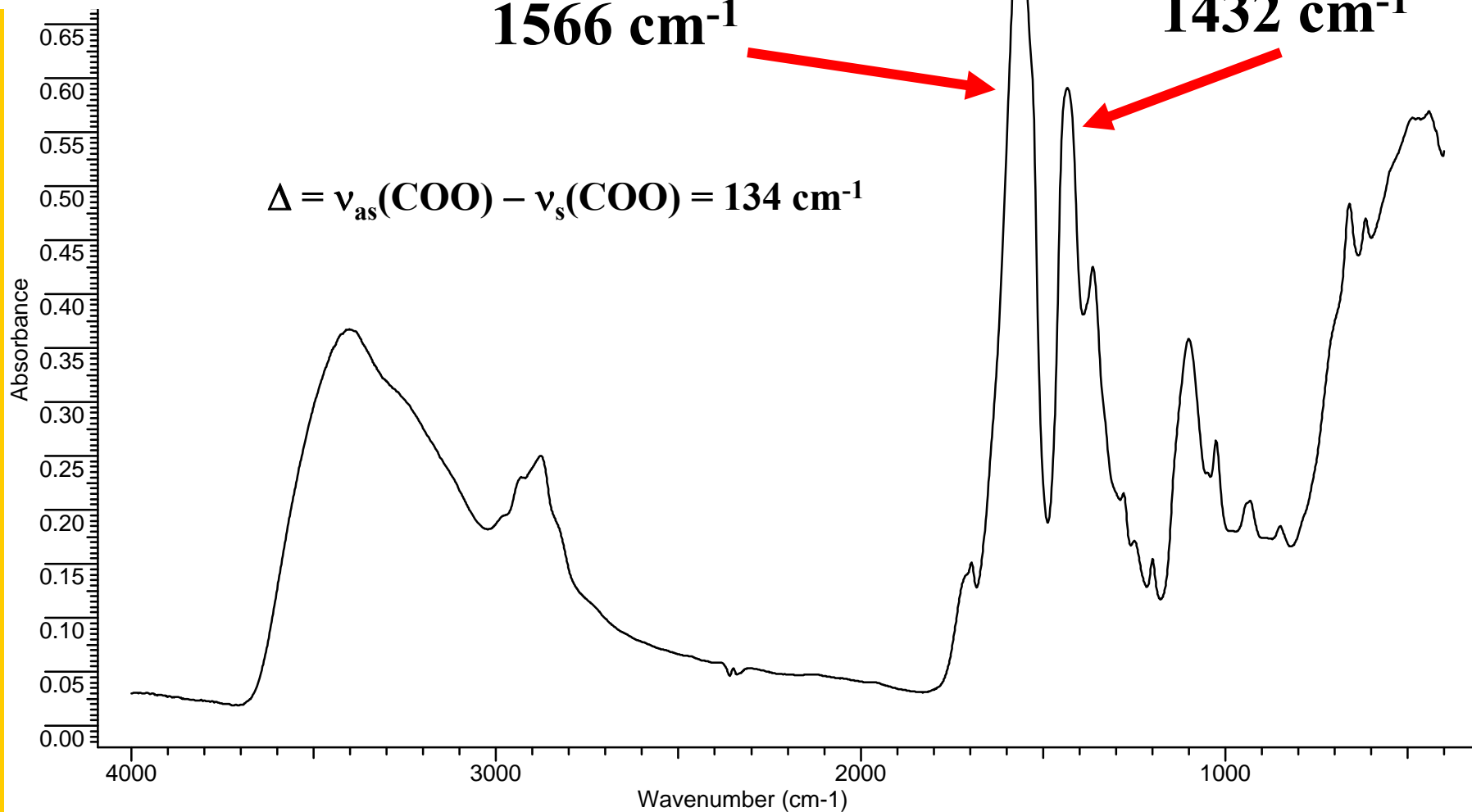

# Decomposition of Acac Ligands

Speculation about the nature of residual organic groups

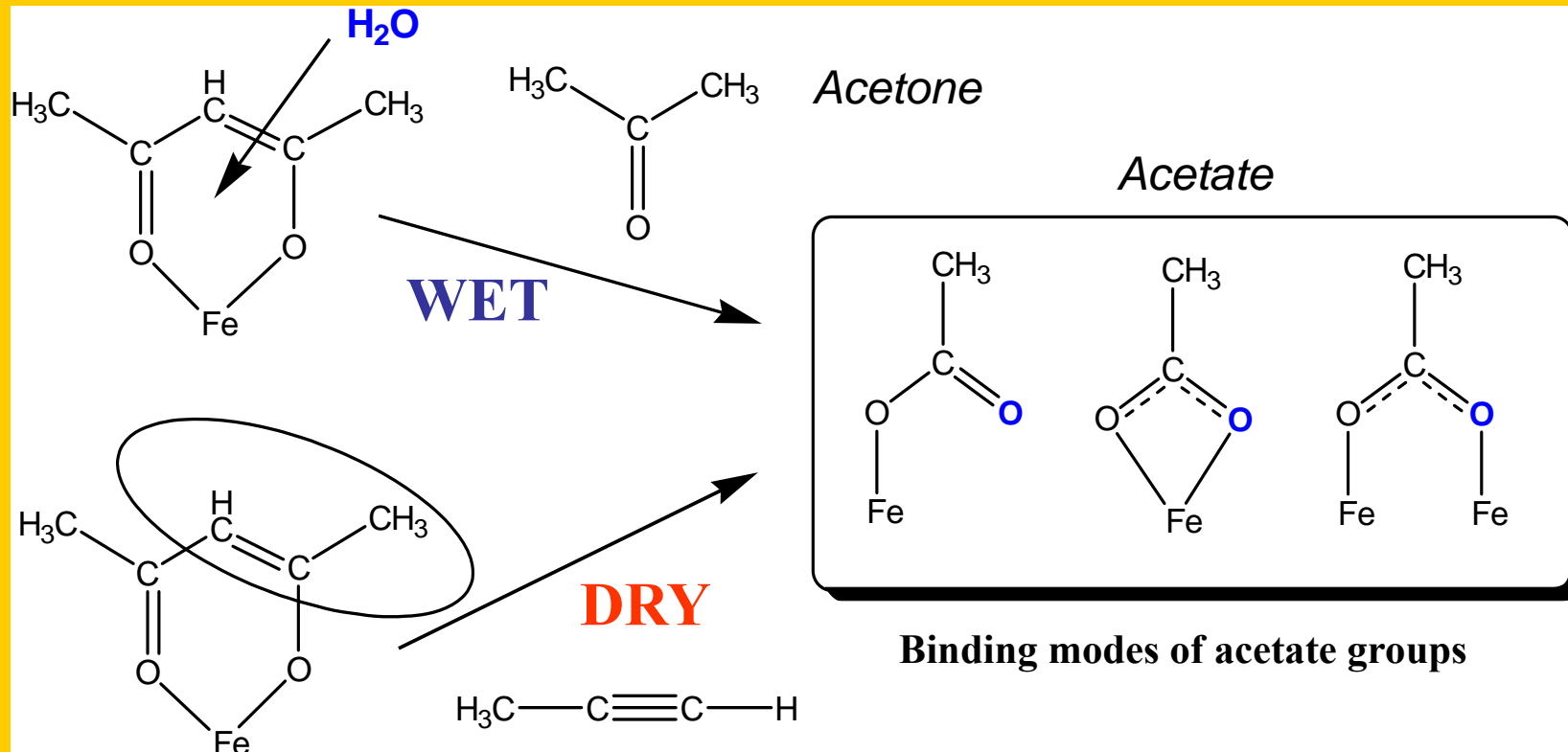



## Deacon-Phillips Rules

$$\Delta = \nu_{\text{as}}(\text{COO}) - \nu_{\text{s}}(\text{COO})$$

$$\Delta \text{CH}_3\text{COO}^- = 164 \text{ cm}^{-1}$$

$\Delta$  larger than ionic form = unidentate

$\Delta$  smaller than ionic form = bidentate

$\Delta$  comparable to ionic form = bridging

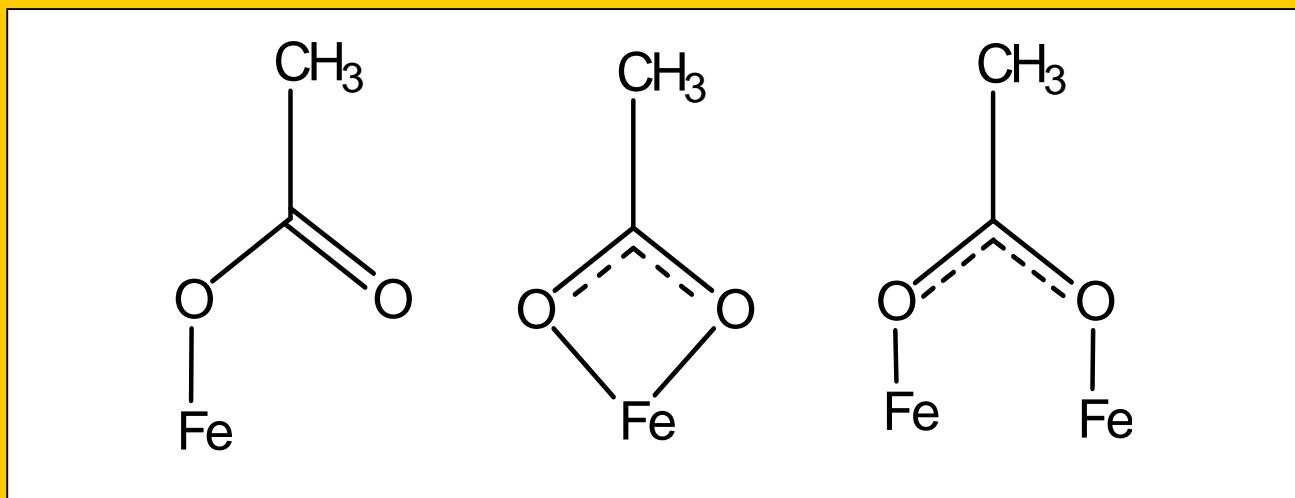

Deacon, G. B.; Phillips, R. J. *Coord. Chem. Rev.* 1980, 3, 227–250.

# TEM

proves amorphous  
character  
of sono- $\text{Fe}_2\text{O}_3$

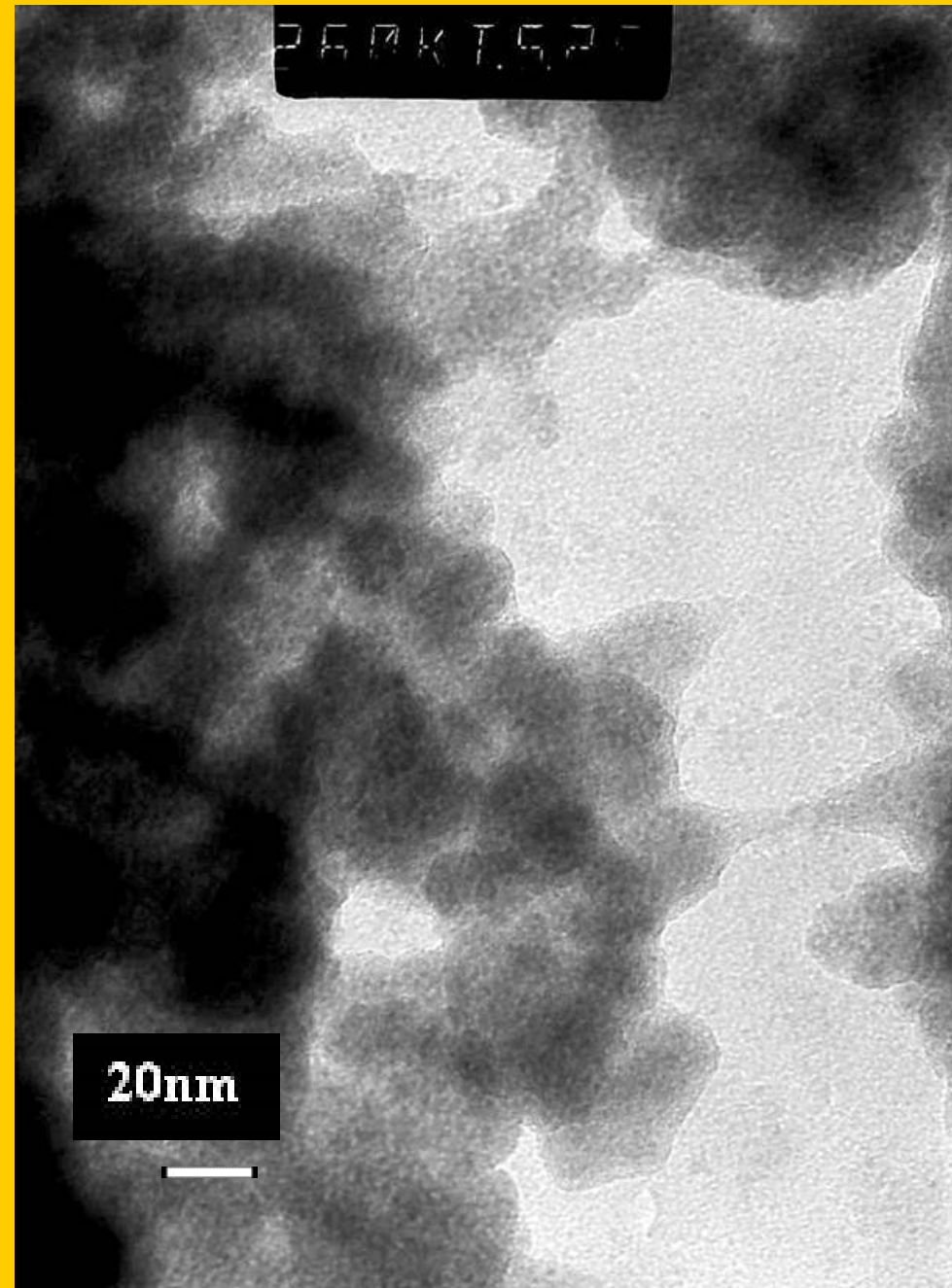

# Crystallization of Amorphous $\text{Fe}_2\text{O}_3$ under TEM Beam



Electron diffraction

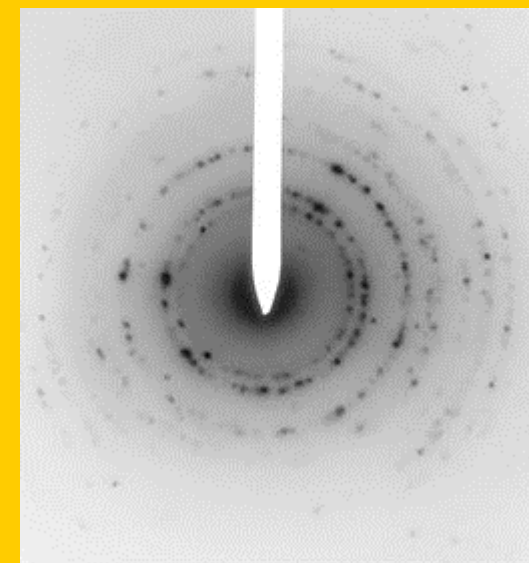
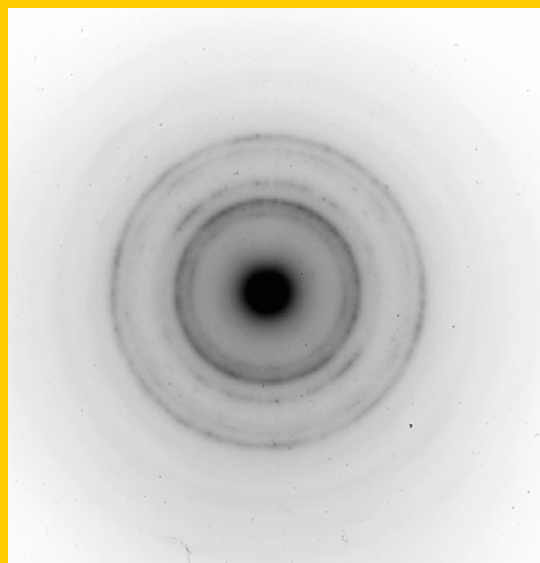

Maghemite or Magnetite



Time under TEM beam

**Amorphous  $\text{Fe}_2\text{O}_3$**

**HR-TEM**

**$\text{Fe}_2\text{O}_3$  calcined at 300 °C**

5 nm

**Crystallization induced  
by heating (300 °C)**

5 nm

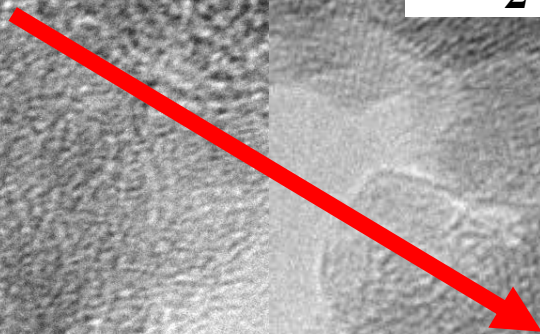

**TEM of amorphous  $\text{Fe}_2\text{O}_3$**

**TEM**

**$\text{Fe}_2\text{O}_3$  calcined at 300 °C**

20 nm

**Smaller particle size  
on calcination – why?**

20 nm

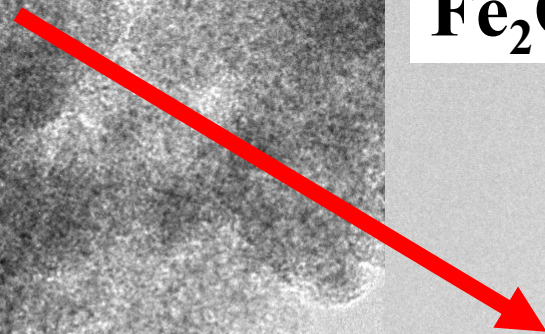

## Specific Surface Area

**Surface area** 48 to 260 m<sup>2</sup> g<sup>-1</sup> (BET) depending on H<sub>2</sub>O content

**BET surface area of the Fe<sub>2</sub>O<sub>3</sub> heated to different temperatures during 12h outgassing periods**

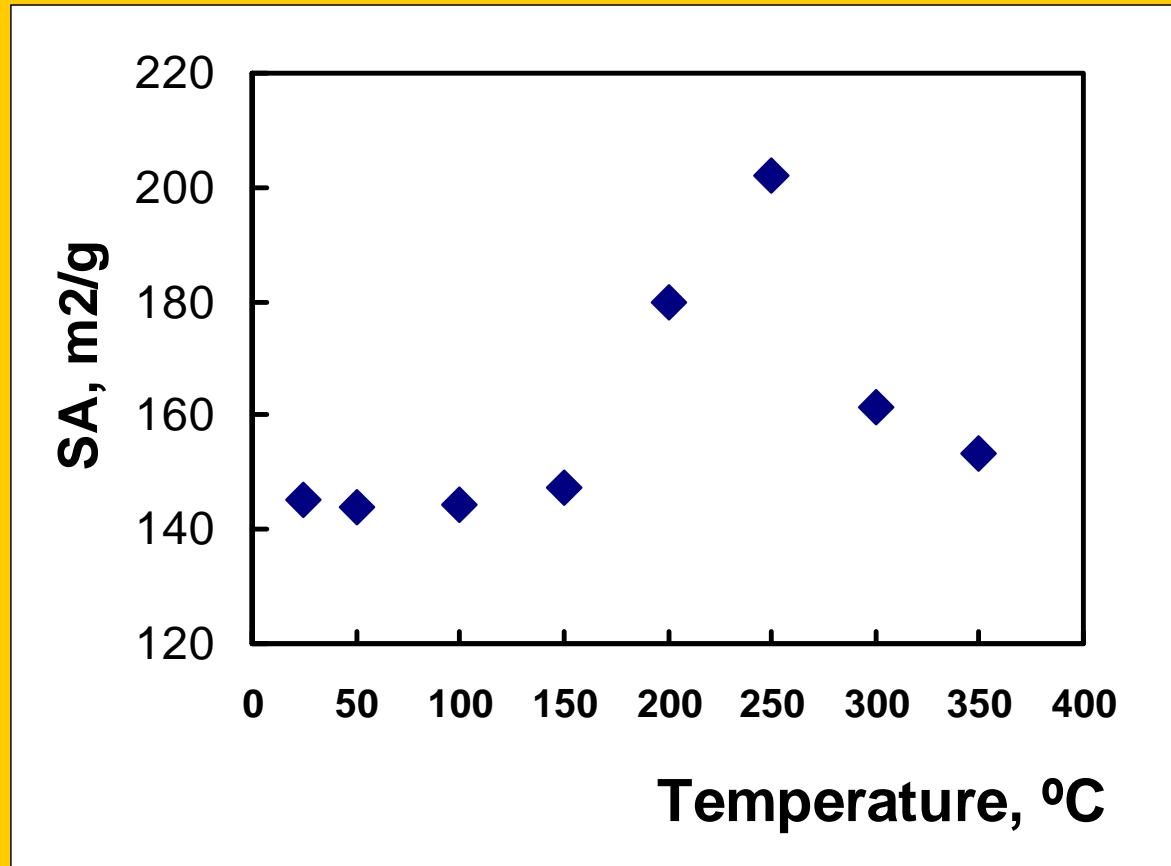

**The oxide surface area increases as the acetate groups are removed, then the particle size increases because of sintering**

# Composite Particles of Sono-Fe<sub>2</sub>O<sub>3</sub>

HR-TEM (5 nm bar)

TEM (20 nm bar)

after heating to 250 °C  
Organic matrix  
partially removed

5 nm

20 nm

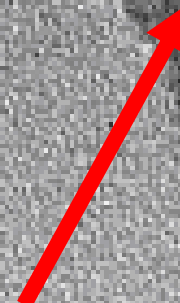

# Composite Particles of $\text{Fe}_2\text{O}_3$

TEM (10 nm bar)

Iron oxide particle size 2 to 3 nm

Embedded in organic matrix

10 nm

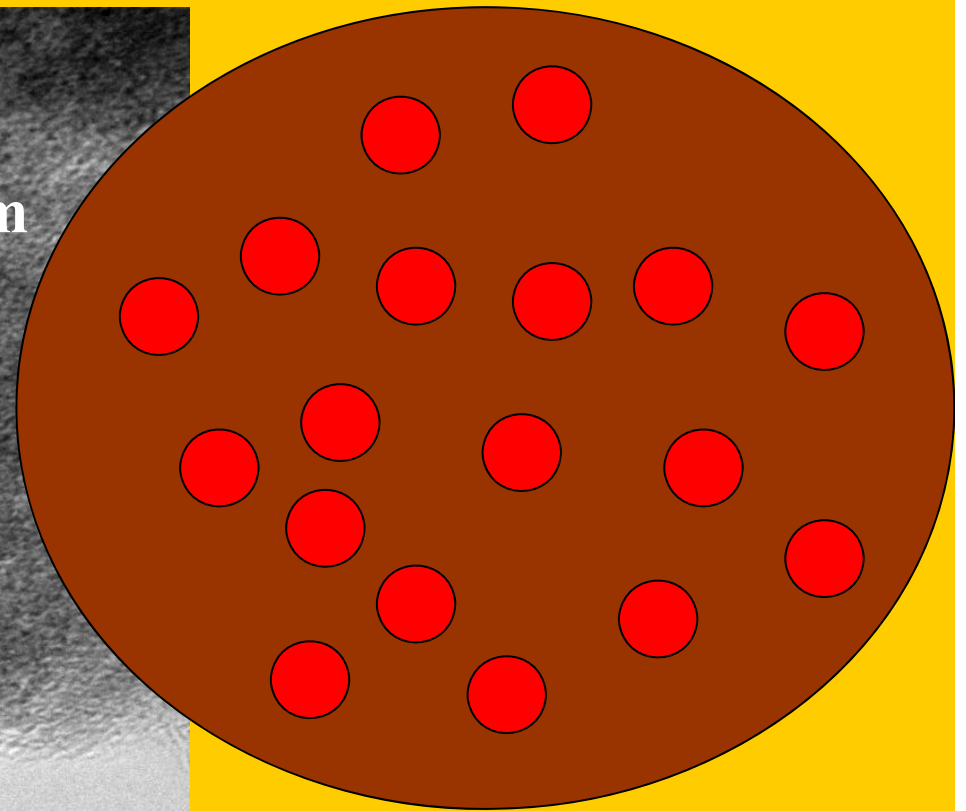



# XRD

of amorphous  $\text{Fe}_2\text{O}_3$

heated dynamically in air

up to 250, 300, and 360 °C

## Maghemite

$\gamma - \text{Fe}_2\text{O}_3$

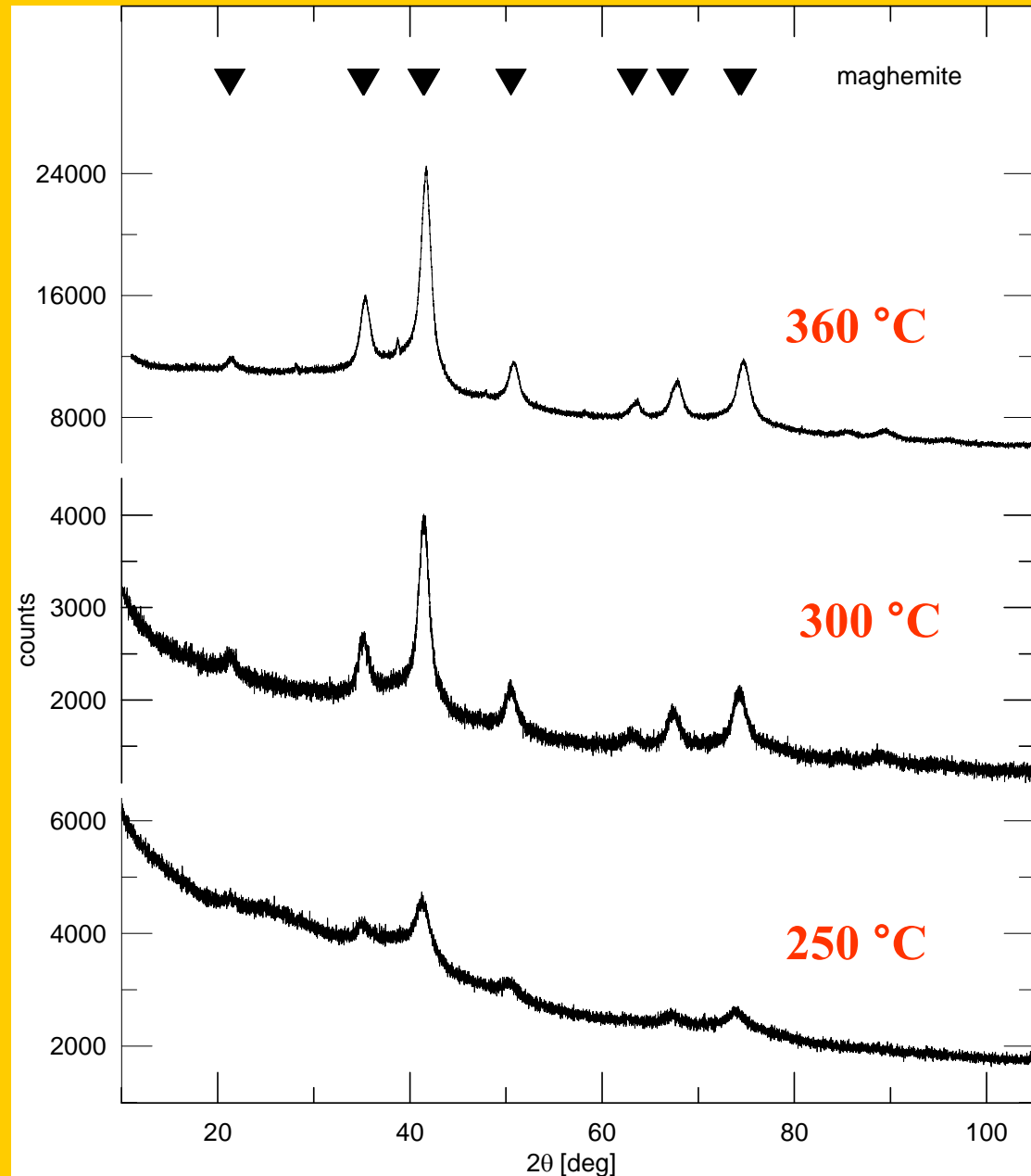

# TEM of Fe<sub>2</sub>O<sub>3</sub> Calcined at 600 °C

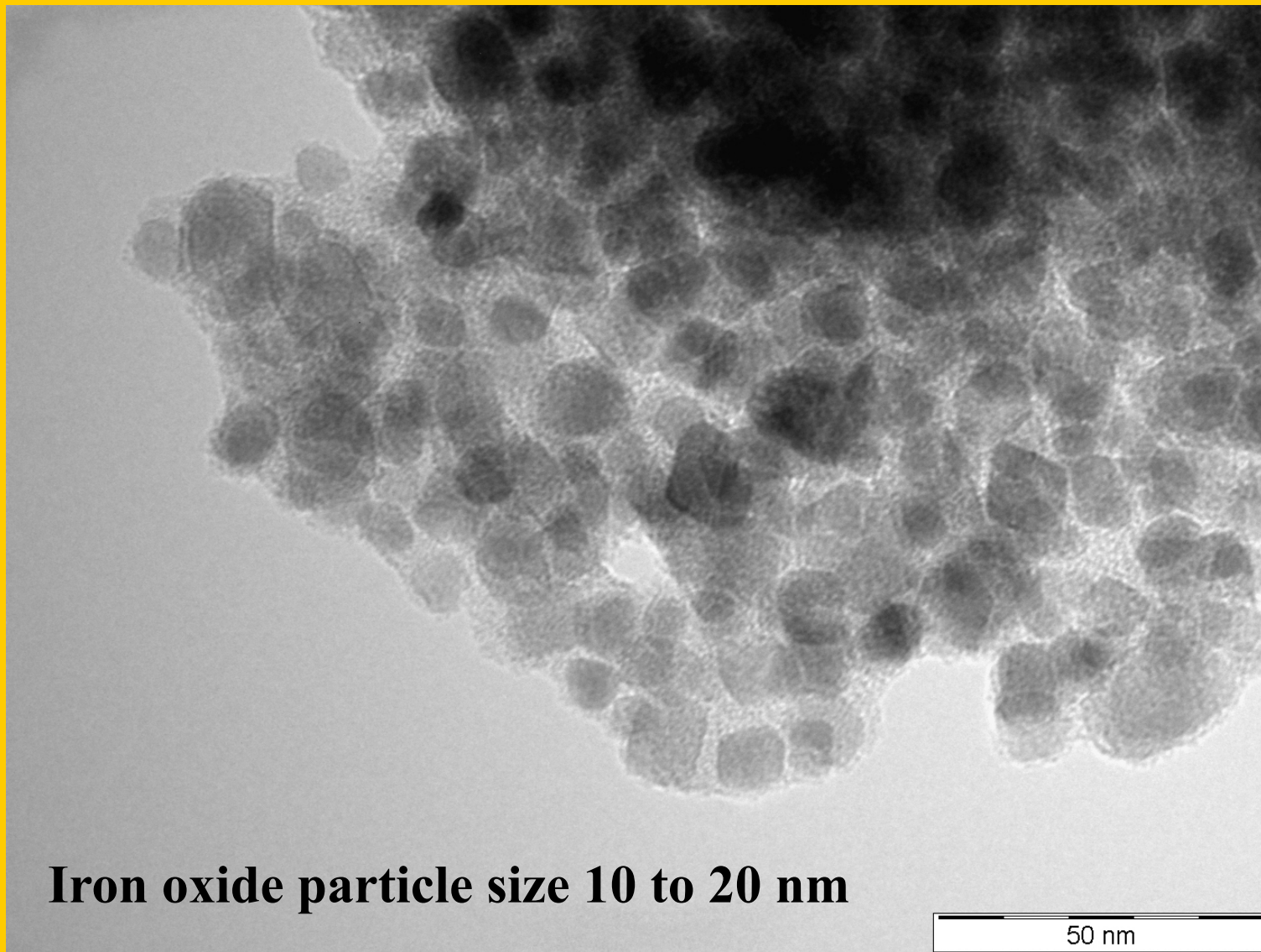

# HT-XRD of Sono-Fe<sub>2</sub>O<sub>3</sub> 280 - 390 °C

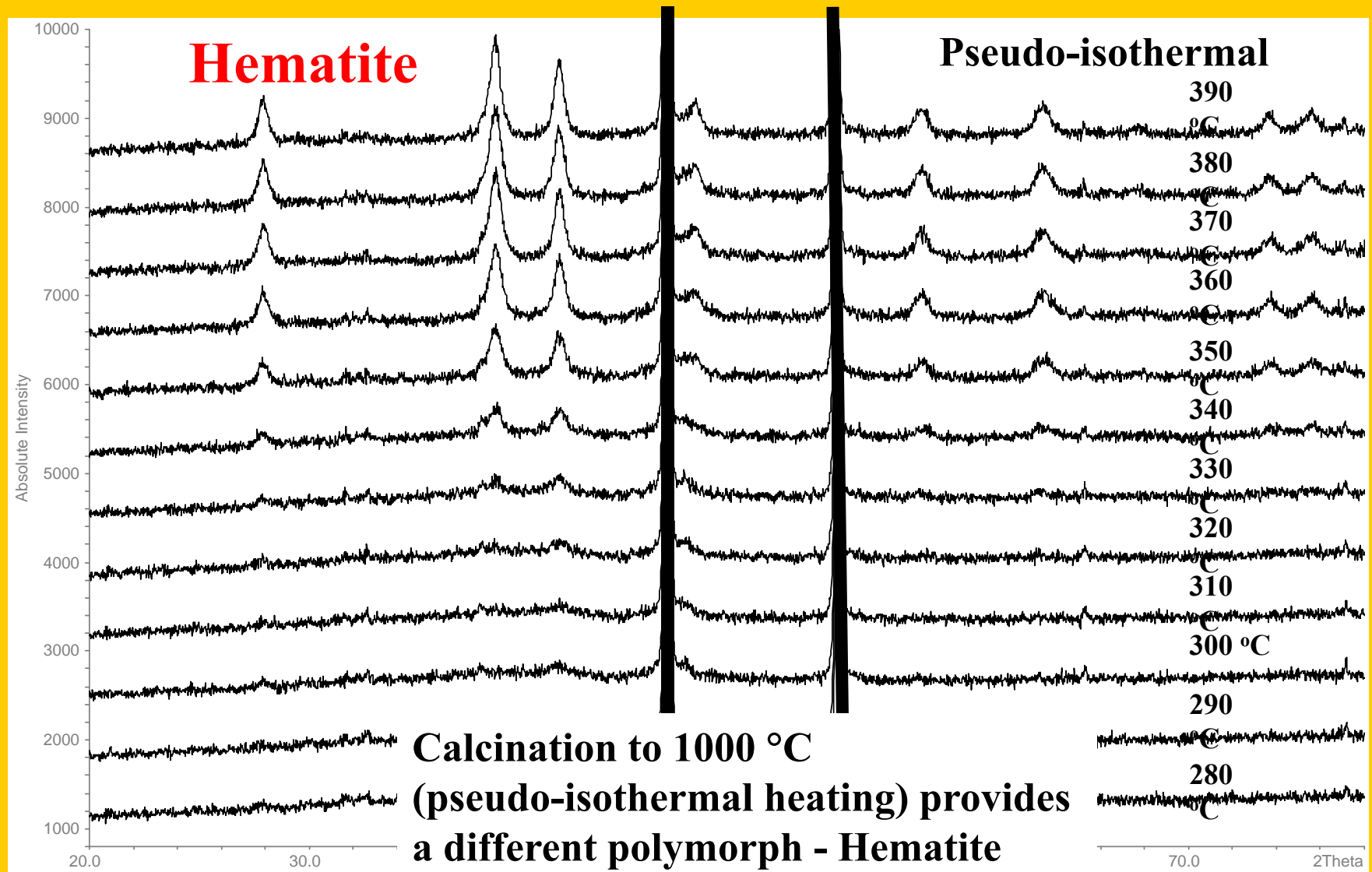

Ramp 1 °C min<sup>-1</sup>, 1 min equilb., 30 min data collect., 10 °C steps

# Hematite Particle Size

coherence  
length  
D (nm)

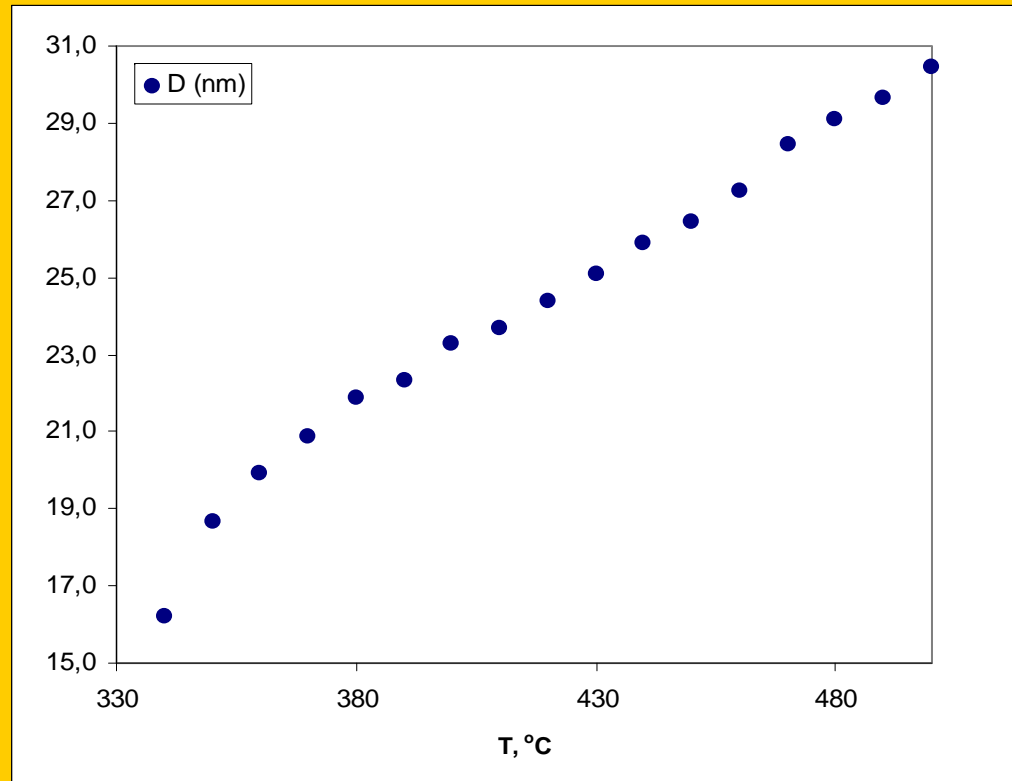

**Dependence of the coherence length, D (nm) of  $\alpha$ - $\text{Fe}_2\text{O}_3$  on the crystallization temperature under dynamic-isothermal conditions of the HT-XRD measurement**