

MACROEVOLUTION

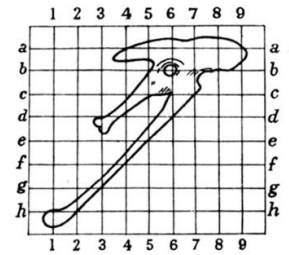
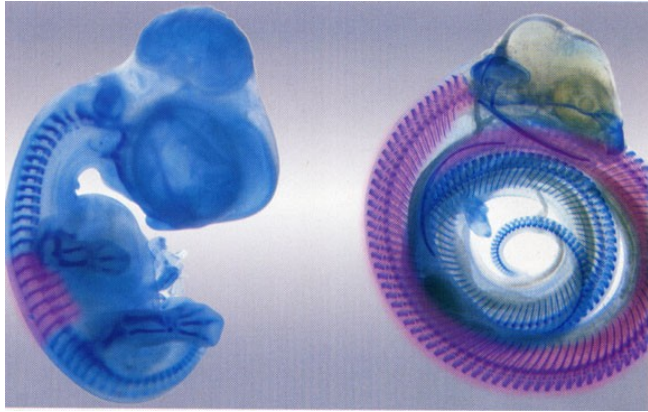
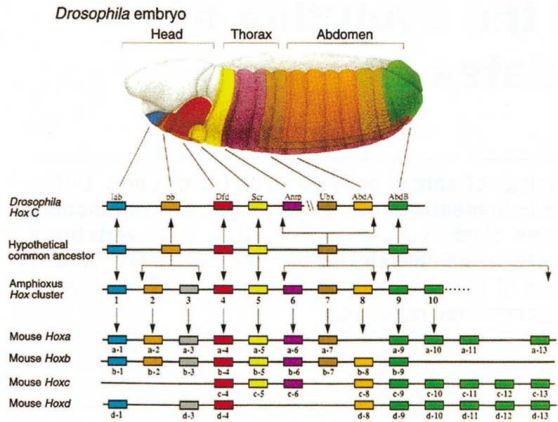

Fig. 161. Pelvis of Archaeopteryx.

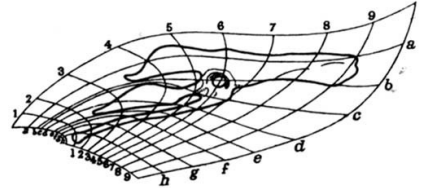
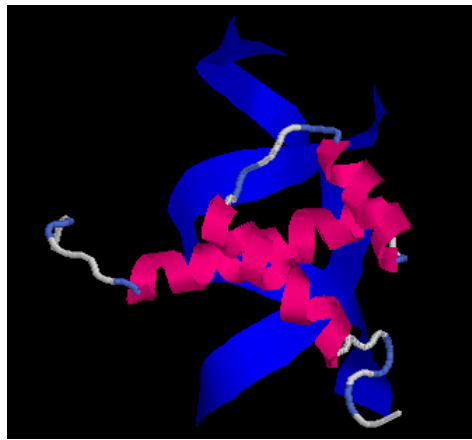
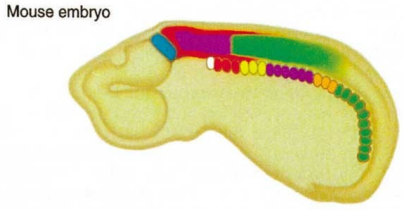

Fig. 162. Pelvis of Apatornis.



Phyletic Gradualism



Morphology

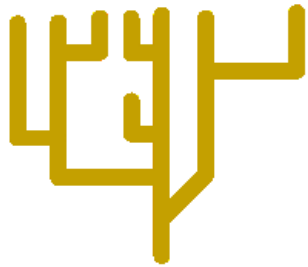

Time

Punctuated Equilibrium

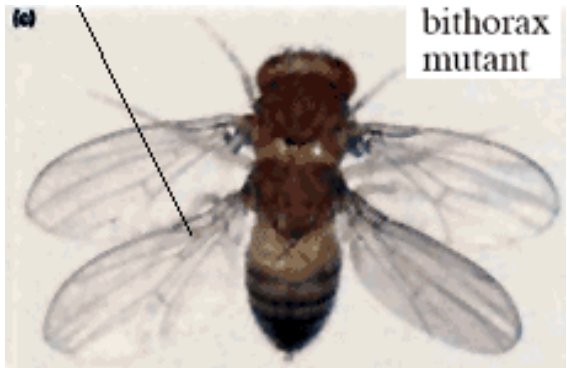

RATE OF EVOLUTION PUNCTUATED EQUILIBRIA

Rate of evolution:

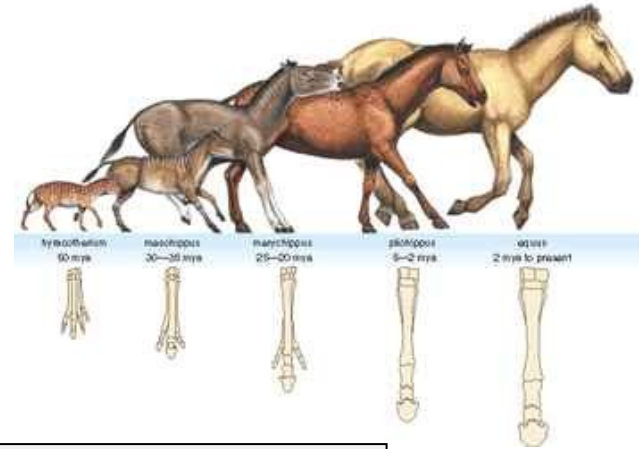

difference between trait values in time t_2 and t_1

Haldane (1949)

$$r = \frac{\ln x_2 - \ln x_1}{\Delta}$$

time interval
 $t_2 - t_1$

1 darwin = e-fold change in a trait over 1 million years

G. G. Simpson:

evoluce bradytelic (slow)

horotelic (standard, eg. horses)

tachytelic (fast)

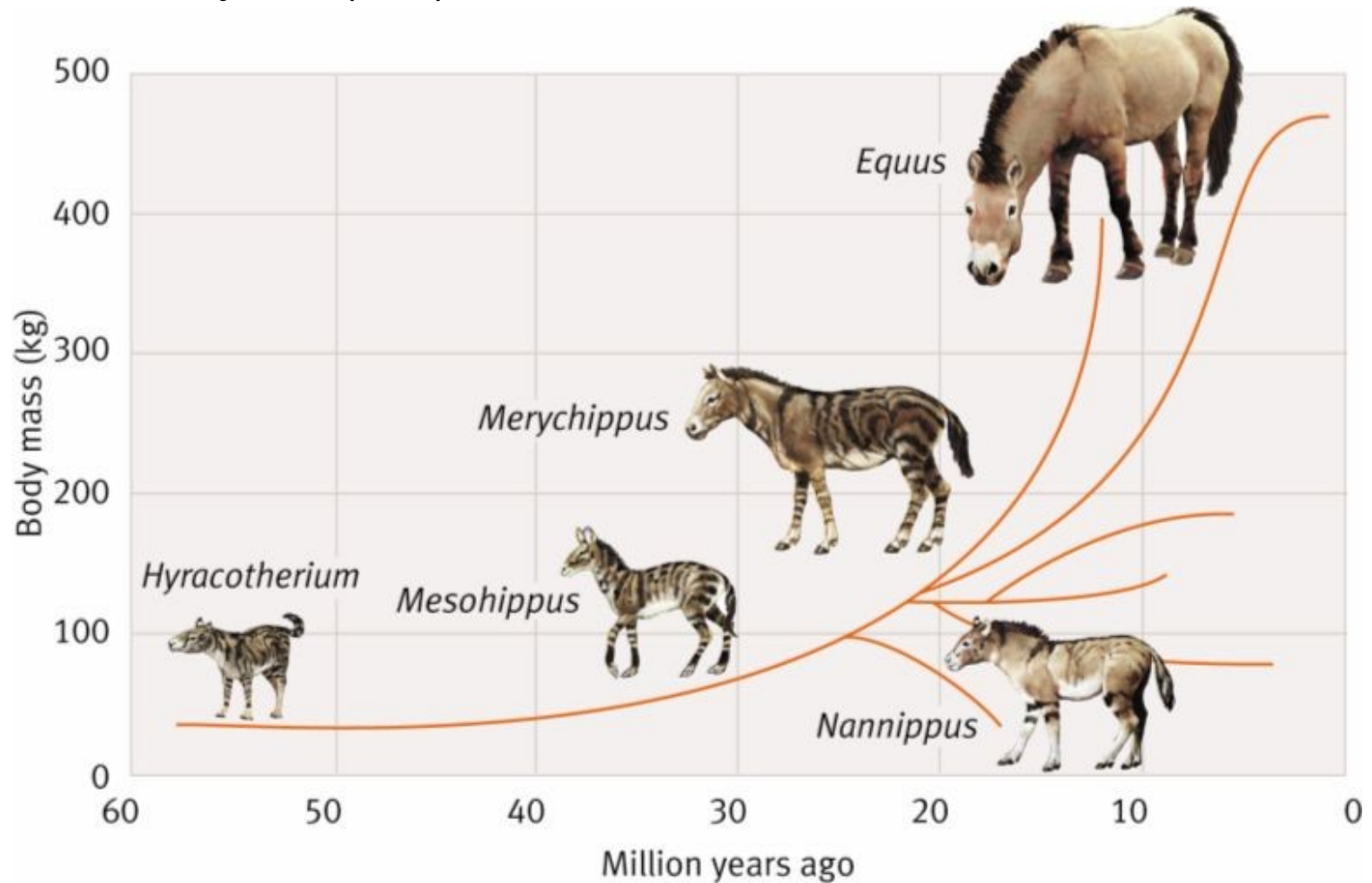

Haldane (1949): Tertiary horses – 0.04 darwins
domestication – 10^3 darwins

Kuertén (1959): Holocene mammals – 12.6 darwins
Pleistocene mammals – 0.5 darwins
Tertiary mammals – 0.02 darwins

... differences caused by different time intervals

disadvantages: 1. factor e is not biologically natural

2. uses absolute time

3. does not take into account measured time interval

4. impossible to compare areas/volumes/linear dimensions

⇒ Haldane (1949), Gingerich (1993): 1 haldane = change measured in units of standard deviation per generation

Theory of punctuated equilibria:

Stephen Jay Gould, Niles Eldredge (1972)

stasis vs. rapid change

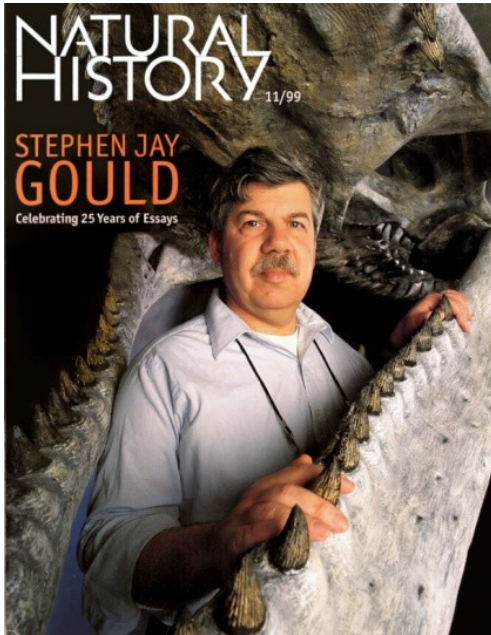
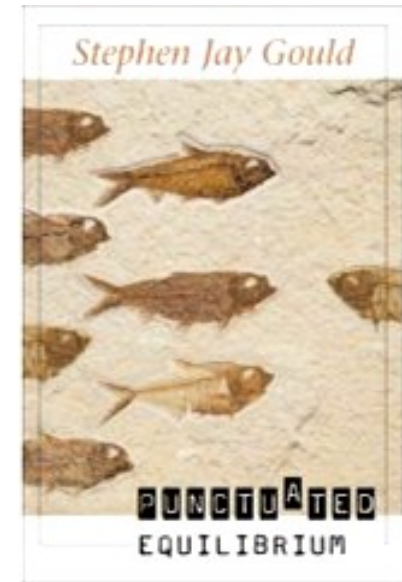

S.J. Gould

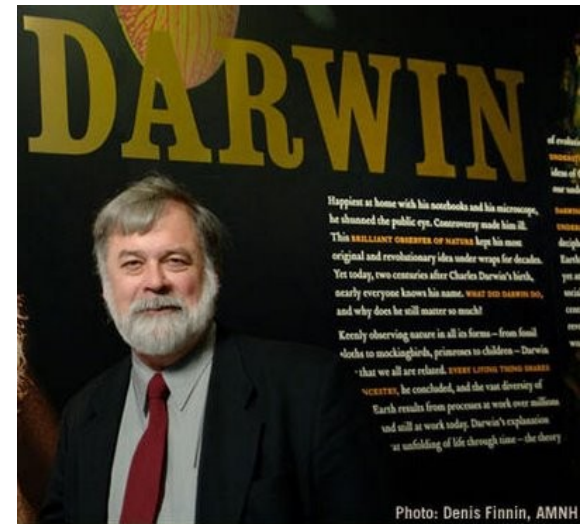

N. Eldredge

stasis vs. rapid change

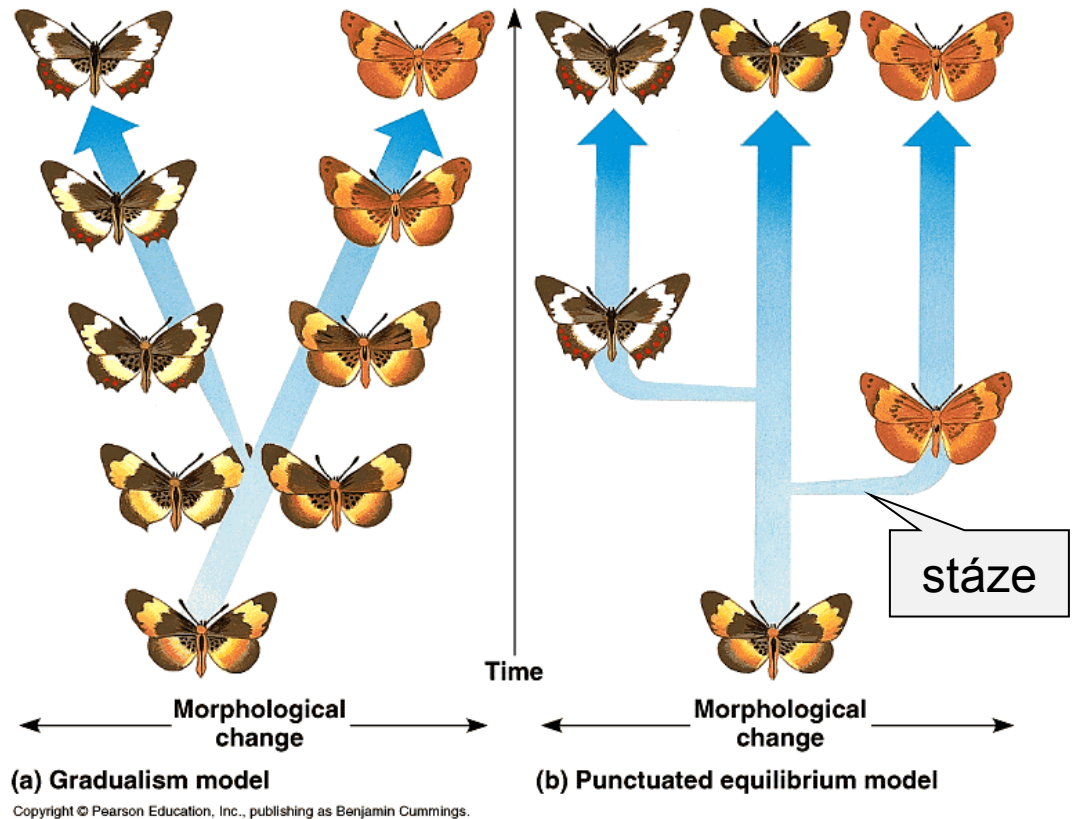
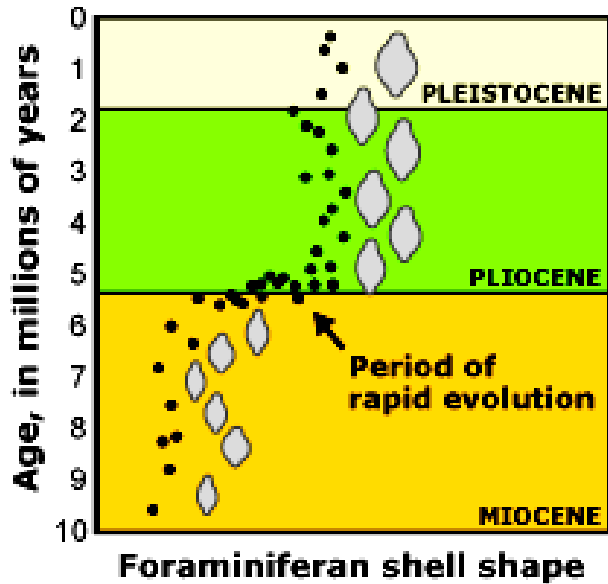

Mechanism?

peripatric speciation

macromutation – R. Goldschmidt, *The Material Basis of Evolution* (1940):
„hopeful monsters“

Peripatric speciation and punctuated equilibria

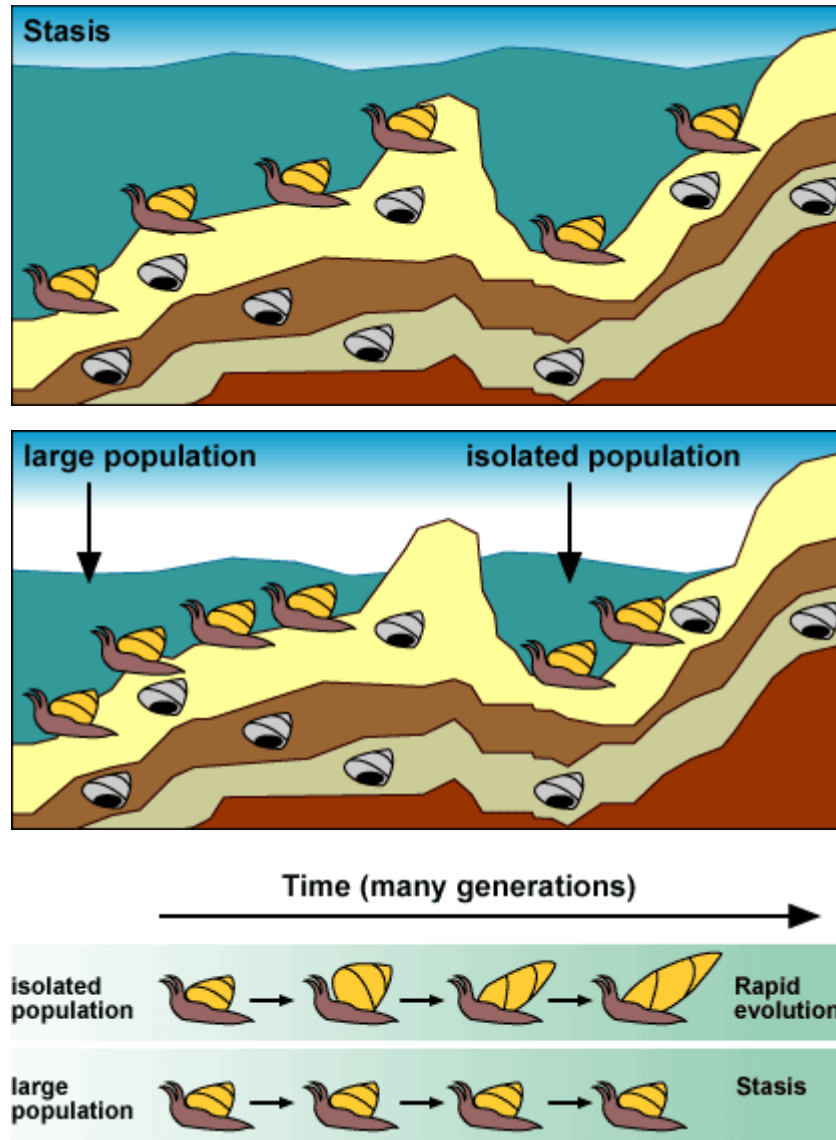

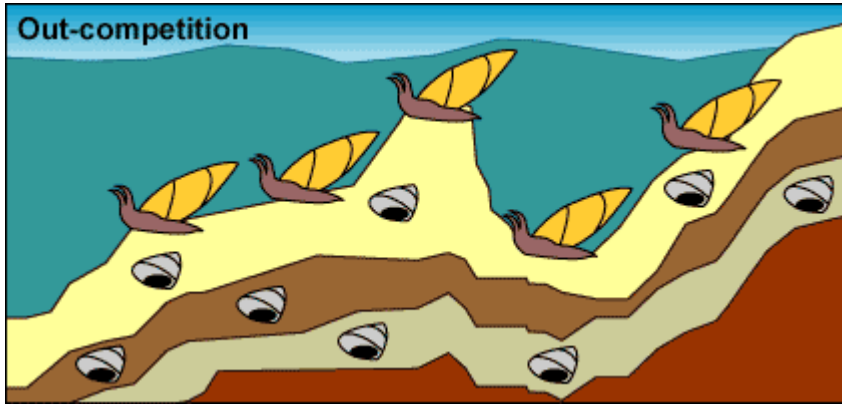
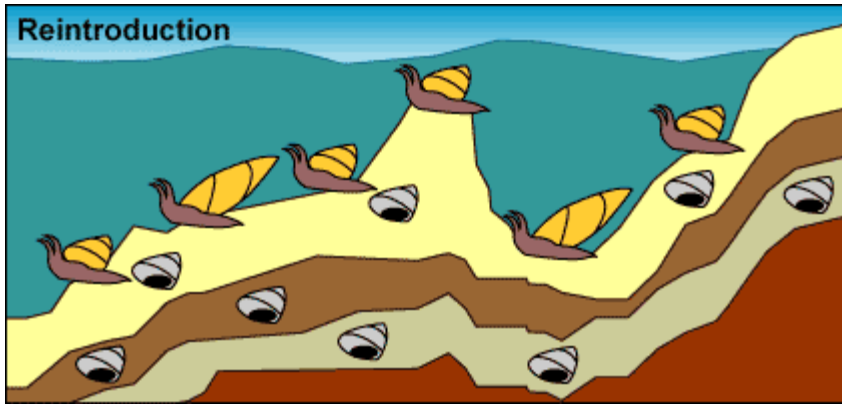
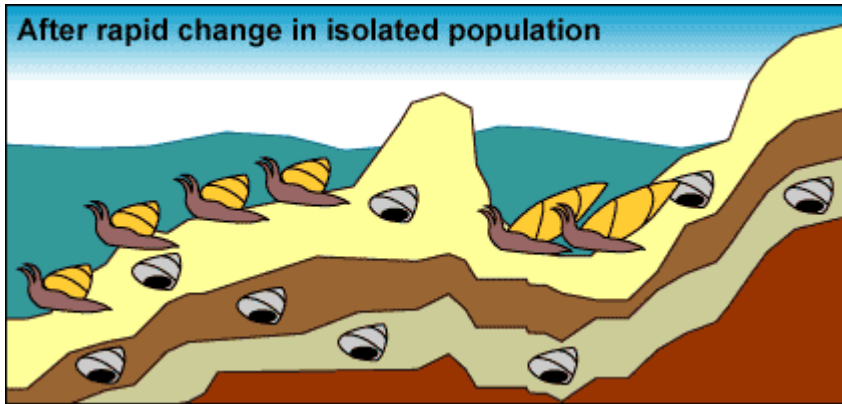

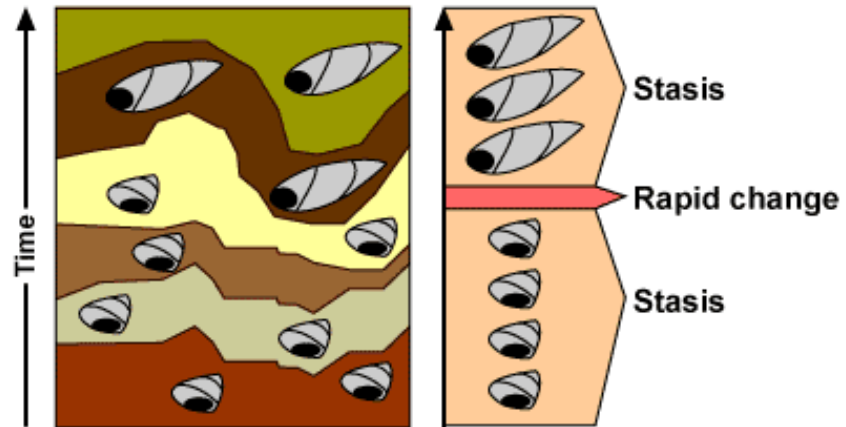
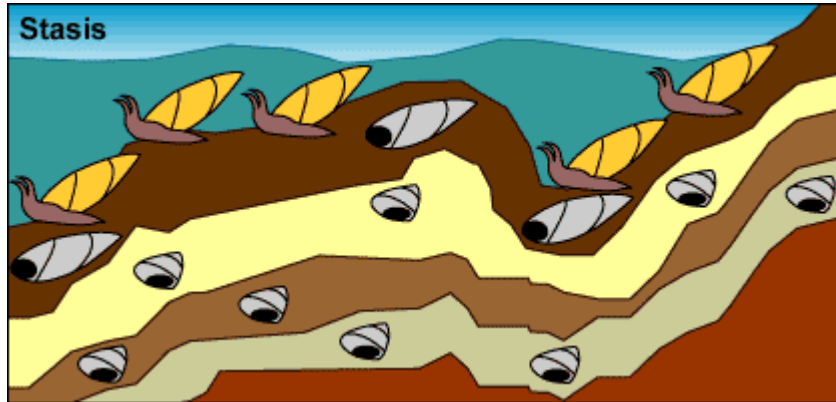

Species of different genera and classes has not changed by the same rate or to the same degree (see „living fossils“).

Periods during which species were changing were short relative to periods during which they stayed unchanged.

Except of (nonexisting) completely constant rate there is only variable rate – species change either in discrete steps (punctuatedism) or gradually. Therefore, stasis is only an extreme case of slow evolution.

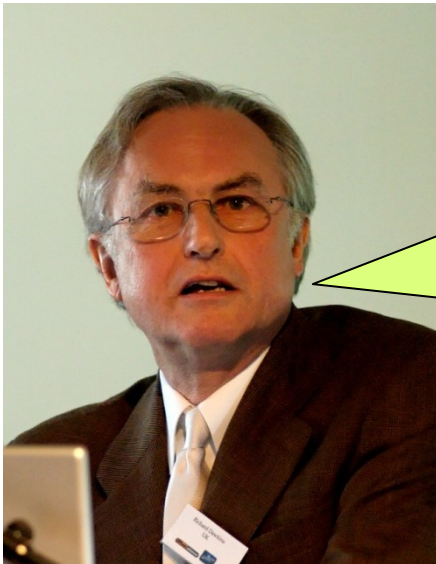
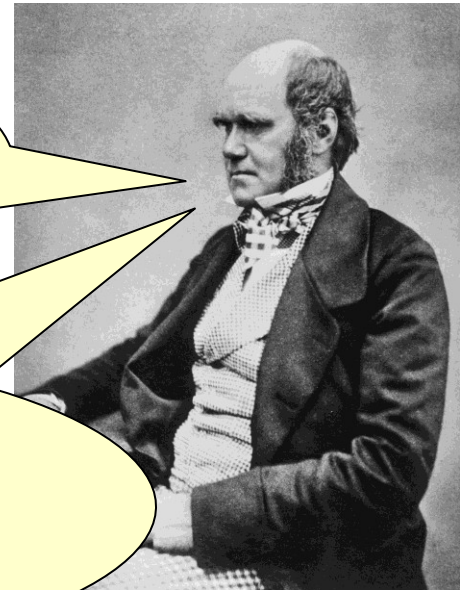

R. Dawkins: Blind watchmaker

Punctuational process typical for language evolution:
changes play an important role in periods of divergence of a new language
Bantu, Indo-European and Austronesian group: 10-33% differences
connected with language splitting

How to explain stasis?

genetic or ontogenetic constraints

habitat tracking – glacial/interglacial cycles

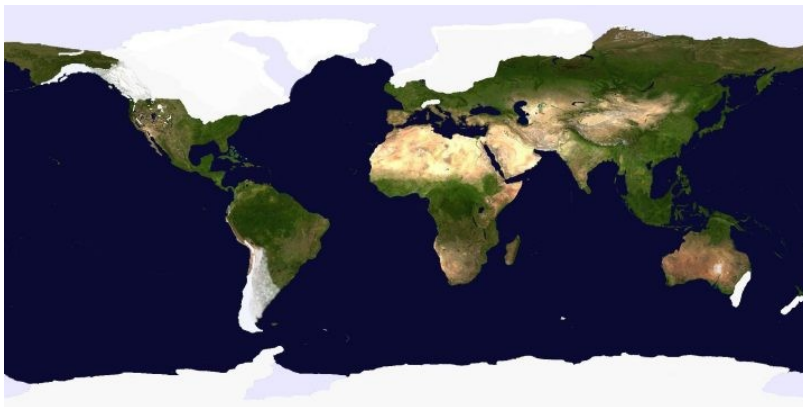

short-term local divergence – rapid changes spatially limited

Relation between micro- and macroevolution

Steven M. Stanley (1975): macroevolution separated from microevolution

S.J. Gould (1980): „deposition of neo-Darwinism from the throne“, „effective death of neo-Darwinism“

Modern Synthesis narrow, extrapolationistic and reductionistic

Is macroevolution really different from microevolution?

evolution of horses

Darwin's finches

mammal evolution



evolution as „matryoshka“

Evolution of horses:

2 dental dimensions

mean rate can be explained by acting of directional selection
(sufficient 2 selective deaths/million of individuals/generation)

if $N_e < 10^4$ individuals, can be explained by drift alone

likewise also other fossils

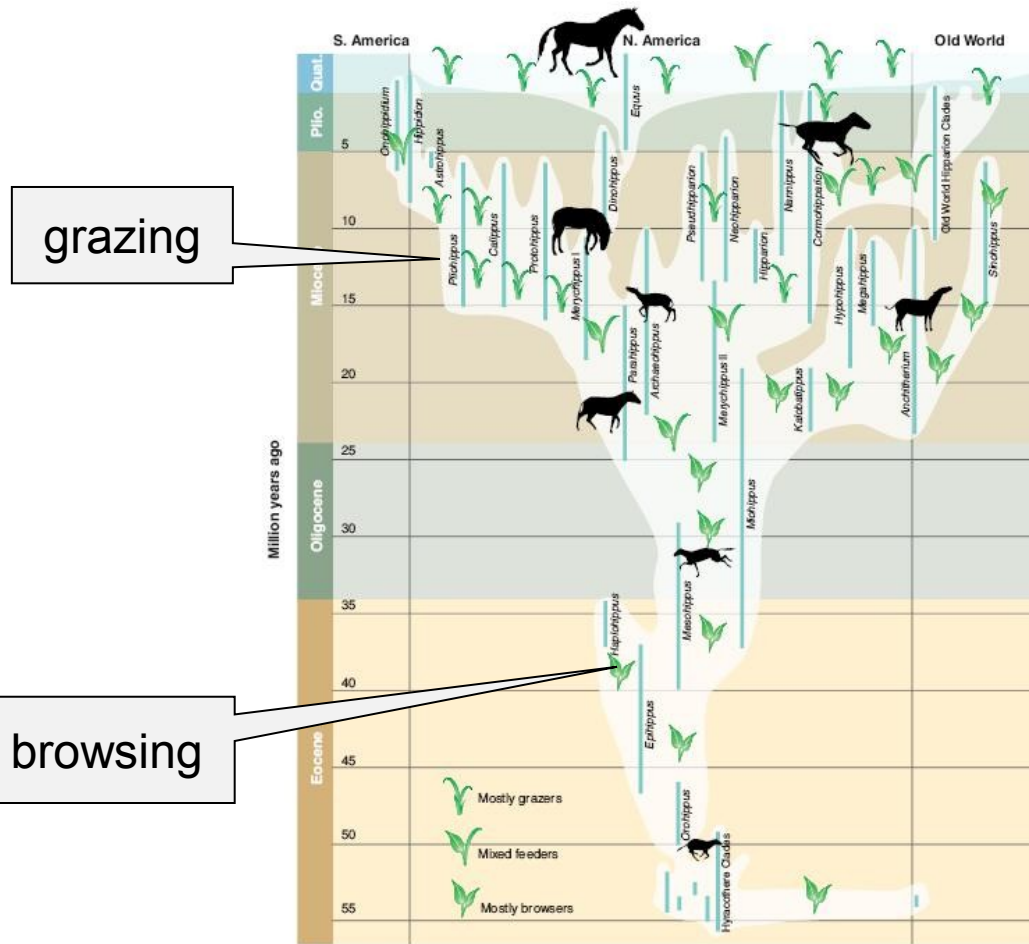
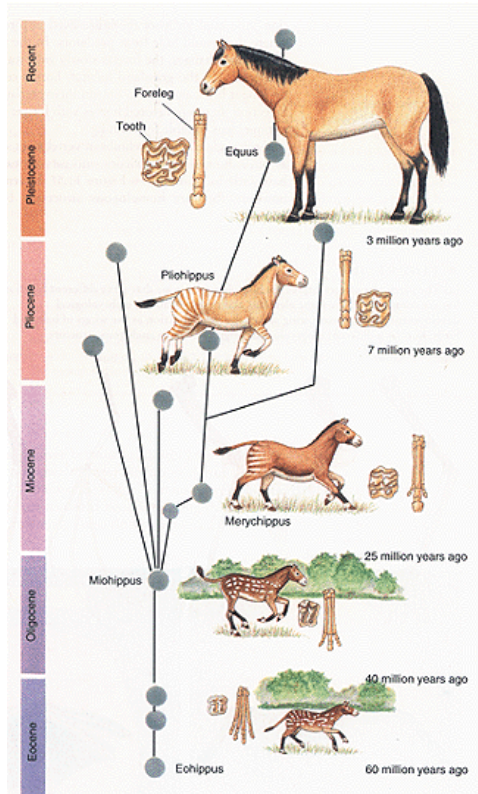

Darwin's finches:

with known age of Galapagos enough time for diversification to 14 species
(in fact more complicated – reversions, possible extinction of some species)

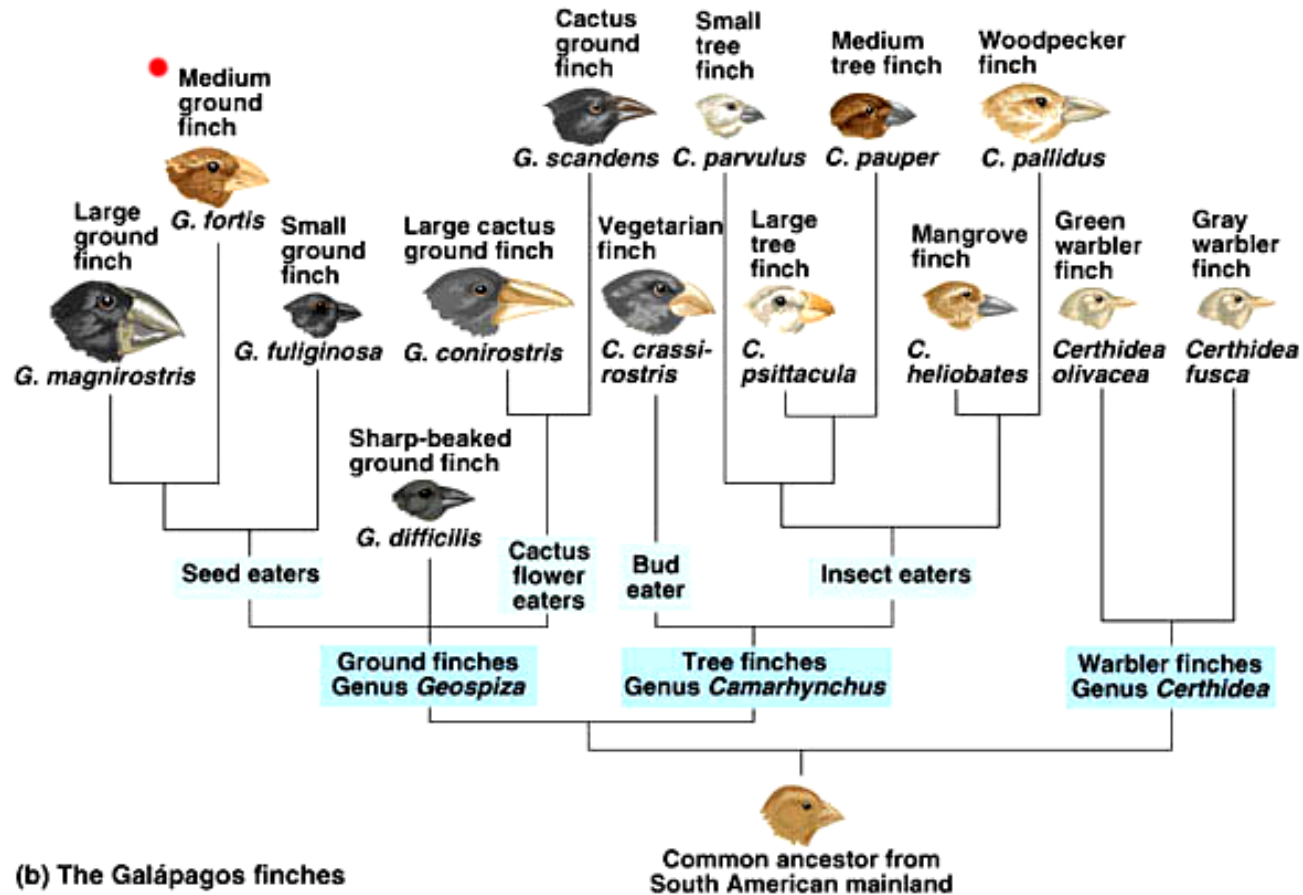

Evolution of mammals from therapsid reptiles:

changes gradual

large differences between reptiles and mammals are adaptive in individual links \Rightarrow same mechanisms as in microevolution

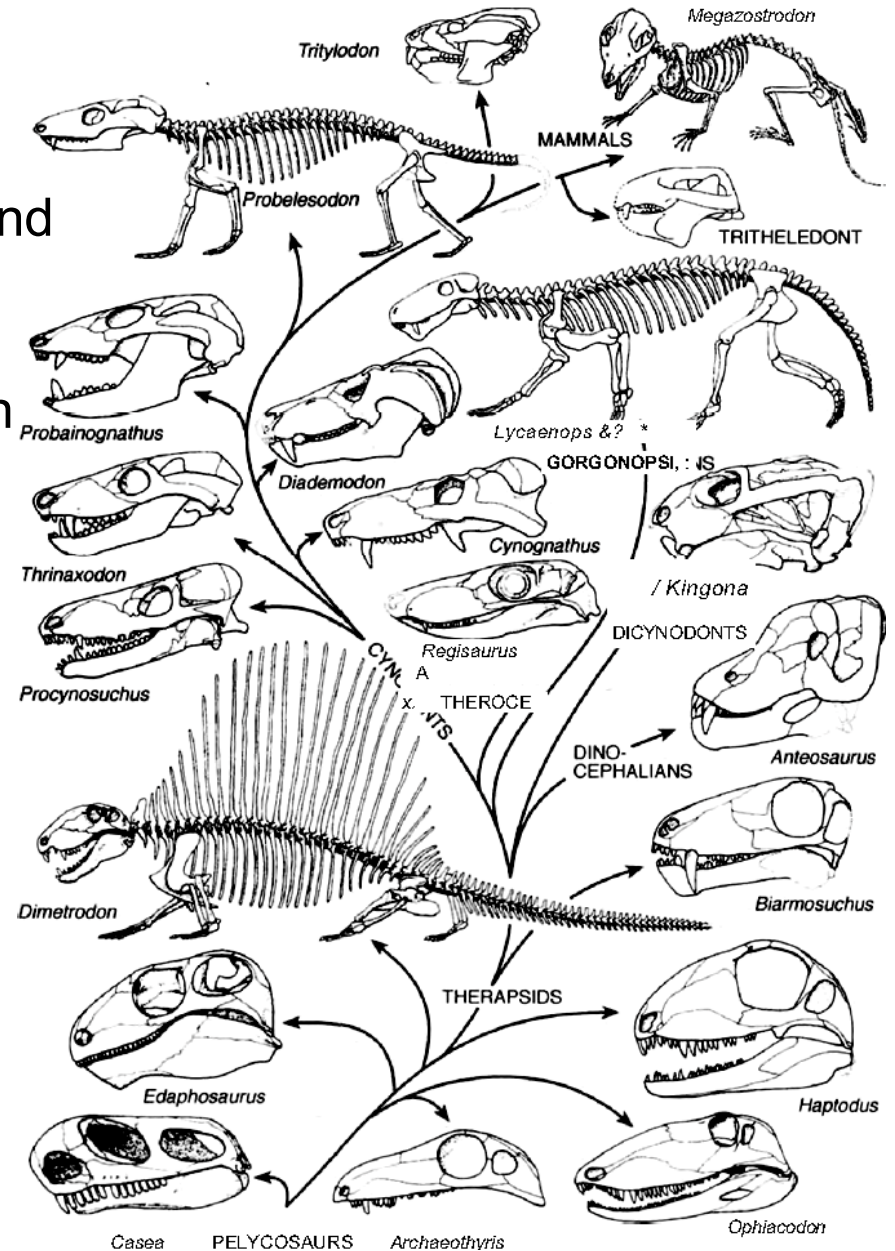

Relation of macroevolution and ontogeny

J. F. Meckel, E. Serres: embryos display traits of embryos of species preceding on the *Scala Naturae*

Ernst Haeckel – **biogenetic law** (= **recapitulation I.**): ontogeny recapitulates phylogeny (eg. gills during mammal embryonal development)

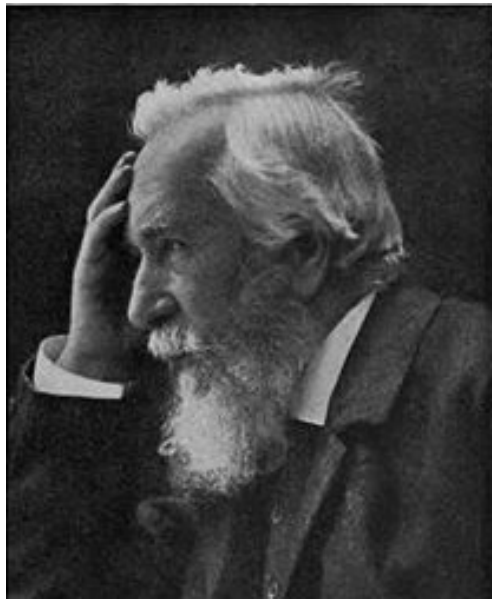

RECAPITULATION IN MAN (?)

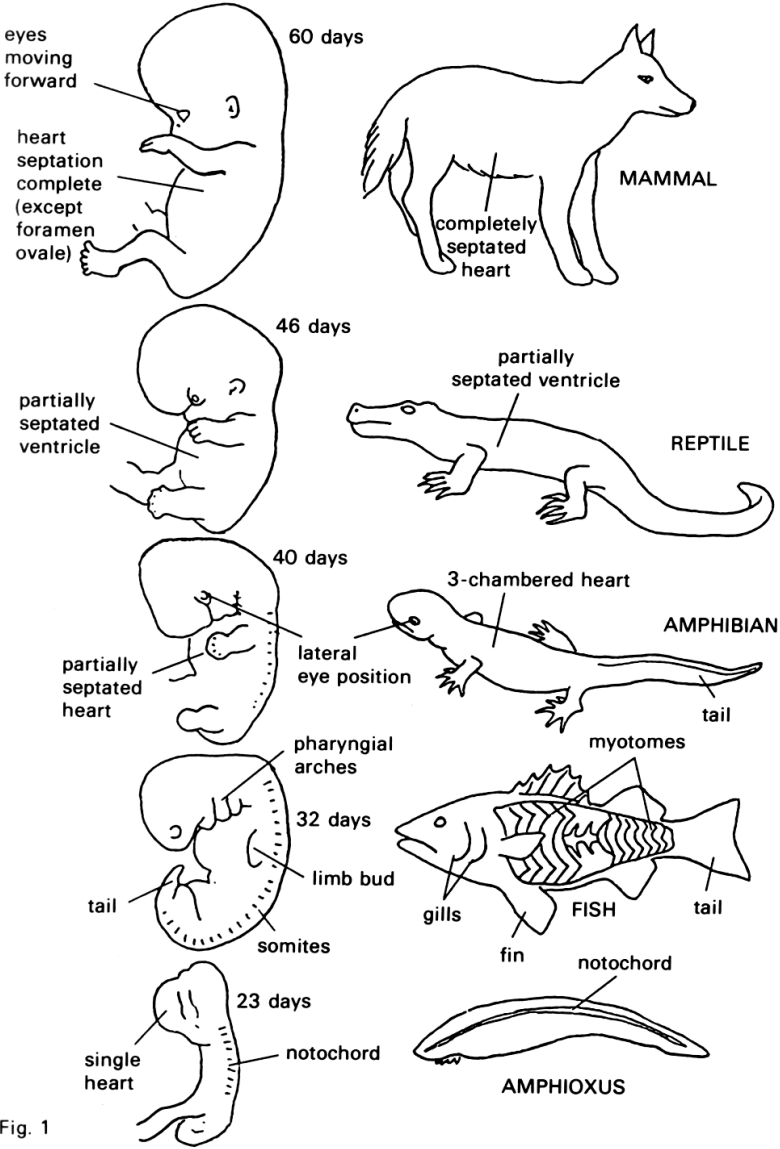
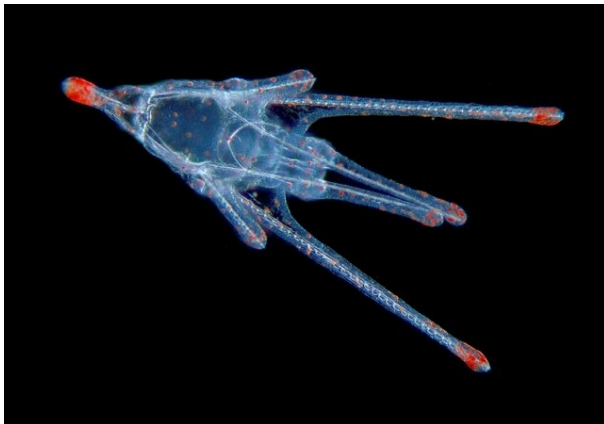
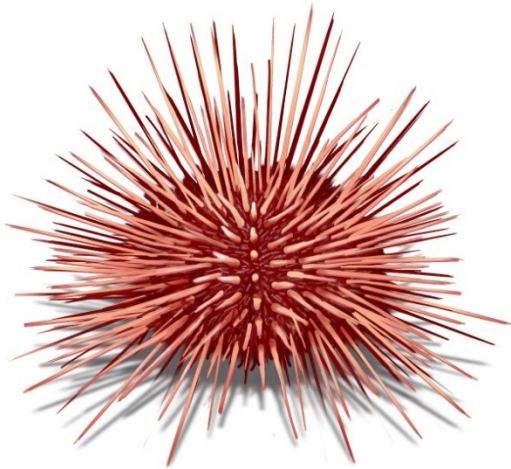

Fig. 1

× specialized larval forms (= non-terminal addition): zoëa of crabs, Müller's larva of echinoderms, caterpillar of butterflies etc.

terminal vs. non-terminal addition



Karl Ernst von Baer – embryological laws:



Vertebrate embryos pass through stable stages during their development which are not identical to any animals species.

Embryos of related species are similar to each other and dissimilar to adults of ancestral species.

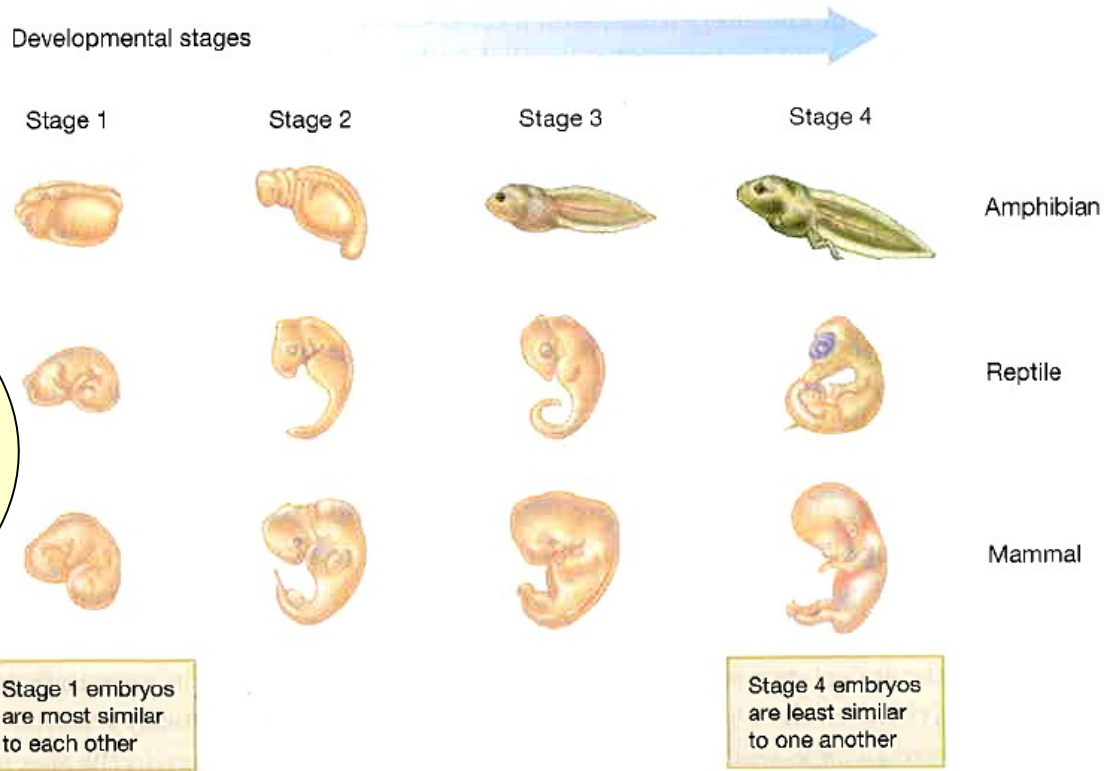

Karl Ernst von Baer – embryological laws:

1st law: General traits of a large animal group appear in the embryo earlier than special traits (eg. cartilage in bony fishes).

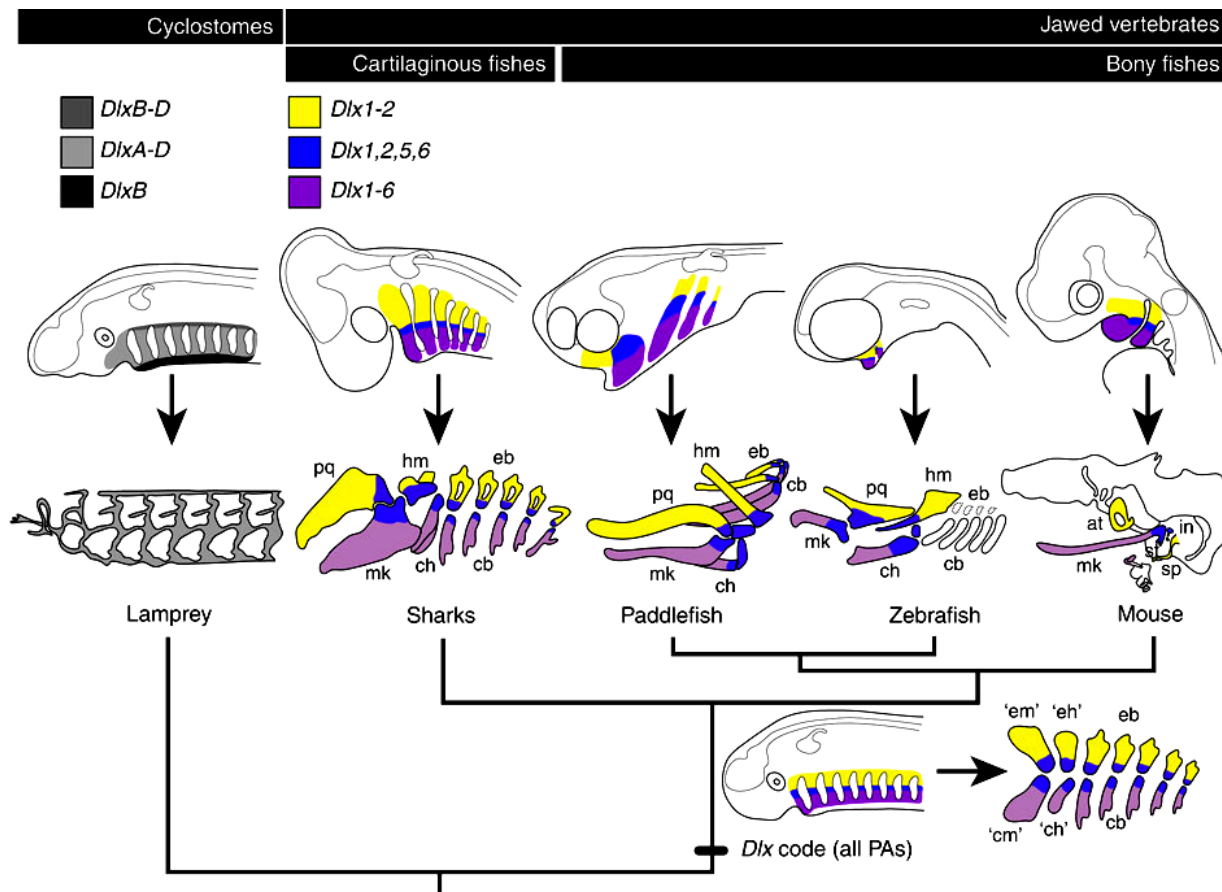

General principles of ontogeny and evolution:

modularization and individualization: serial homology and homonymy

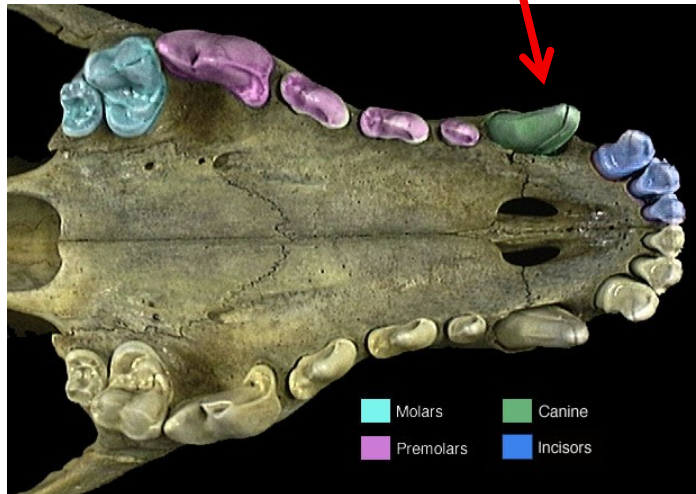
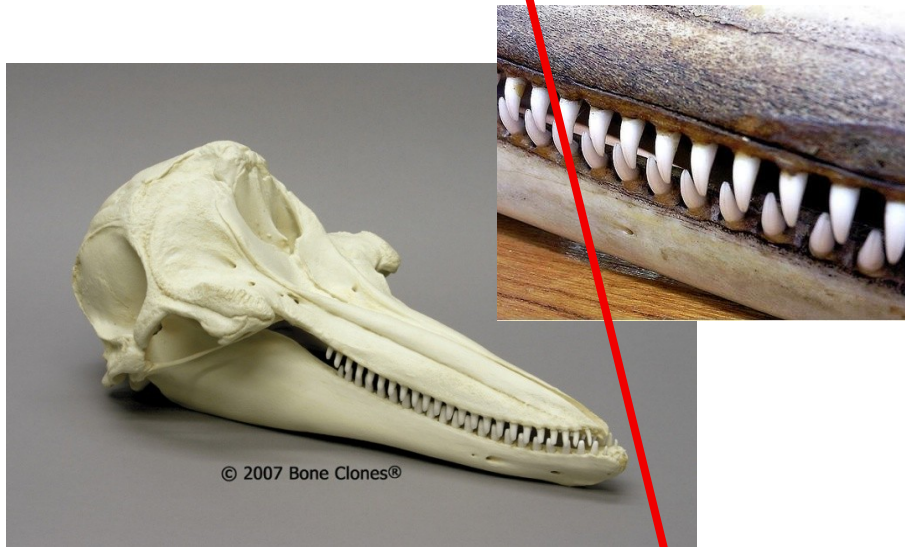

General principles of ontogeny and evolution:

heterotopy = change of the position of a trait phenotypic expression
(eg. photosynthesis in succulent stem; sesamoid bones – *patella*, ossified tendons in dinosaur tails, „panda’s thumb“)

■ Human thumb bones actually correspond to the sixth finger on the panda hand.

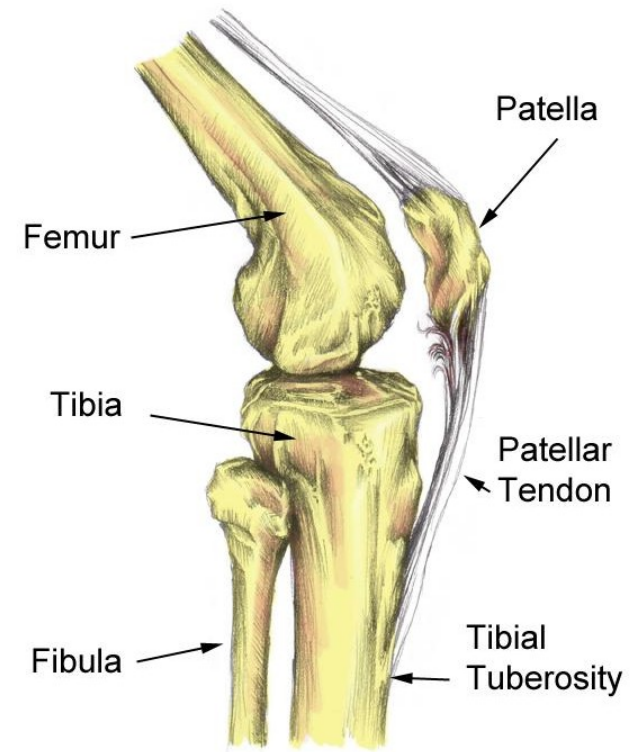
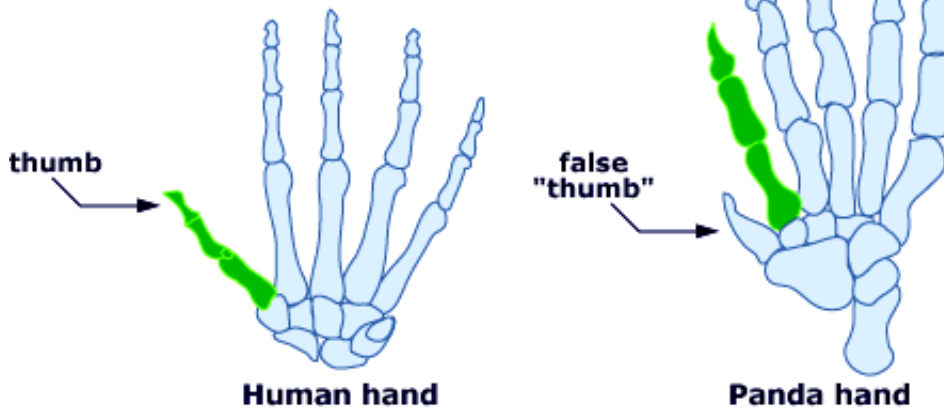

General principles of ontogeny and evolution:

heterochrony and allometry

Heterochrony

<http://www.bio.miami.edu/dana/dox/heterochrony.html>

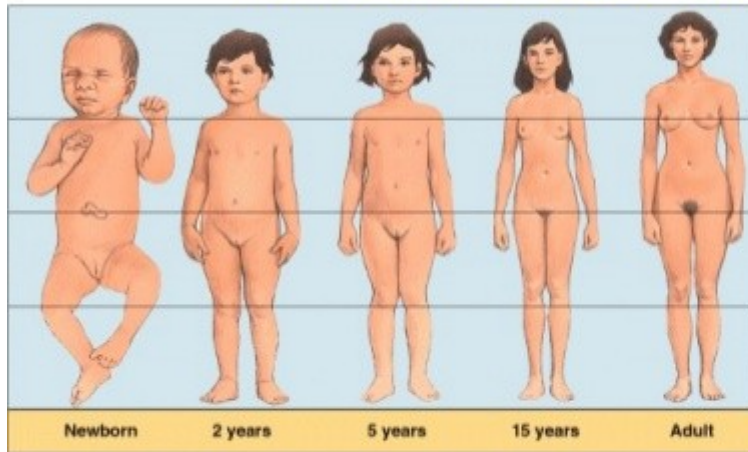

Allometric Growth

Differential growth in organs and body parts



Paedomorphy

Retention of juvenile structures

Heterochrony:

		Somatic traits	Reproductive org.
peramorphosis			
paedomorphosis			

= change of timing of ontogenetic events:

1. speed of the process
2. timing of the process

Heterochronie:

		Somatic traits	Reproductive org.
peramorphosis	hypermorphosis	--	deceleration
	acceleration	acceleration	--
paedomorphosis			

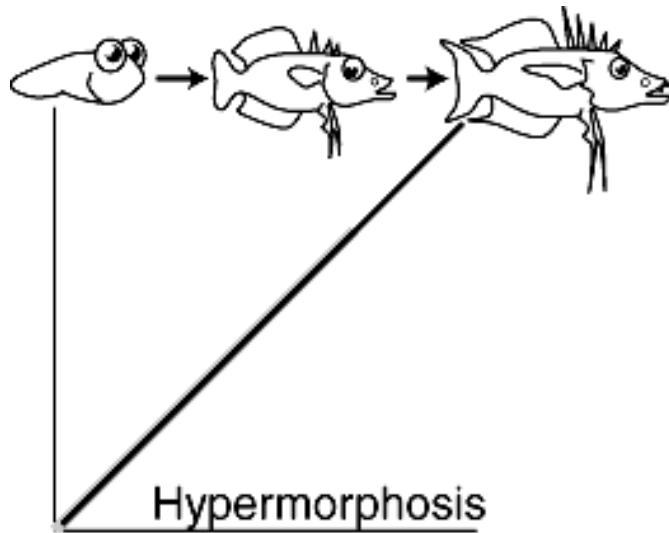

hypermorphosis



Megaceros giganteus

Heterochrony:

		Somatic traits	Reproductive org.
peramorphosis	hypermorphosis	--	deceleration
	acceleration	acceleration	--
paedomorphosis	progenesis	--	acceleration
	neoteny	deceleration	--

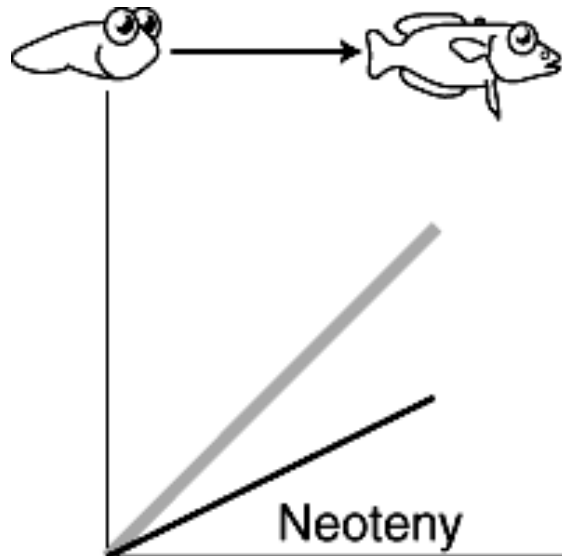

Heterochrony and allometry:

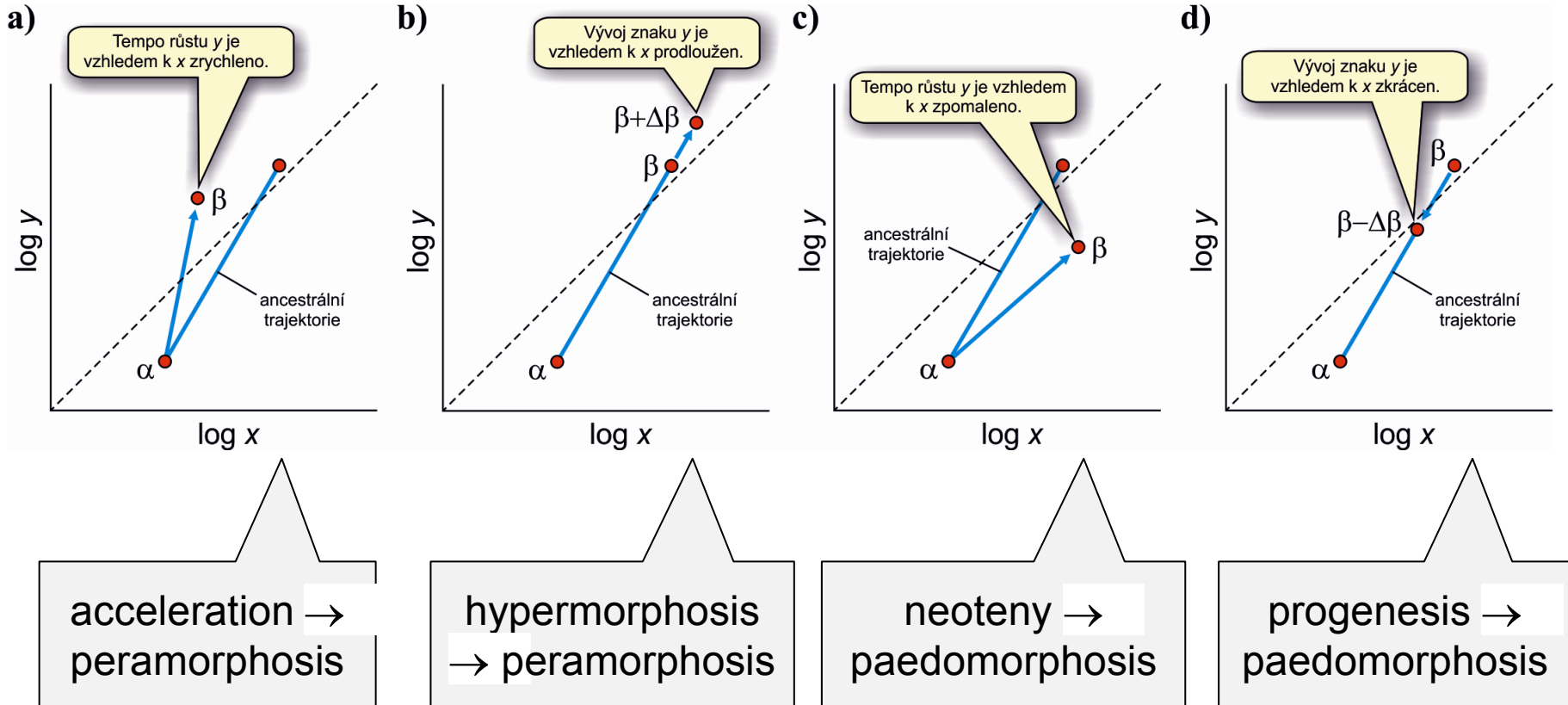

neoteny:



Ambystoma mexicanum



Birds have paedomorphic dinosaur skulls

Bhart-Anjan S. Bhullar¹, Jesús Marugán-Lobón², Fernando Racimo¹, Gabe S. Bever³, Timothy B. Rowe⁴, Mark A. Norell⁵
& Arhat Abzhanov¹

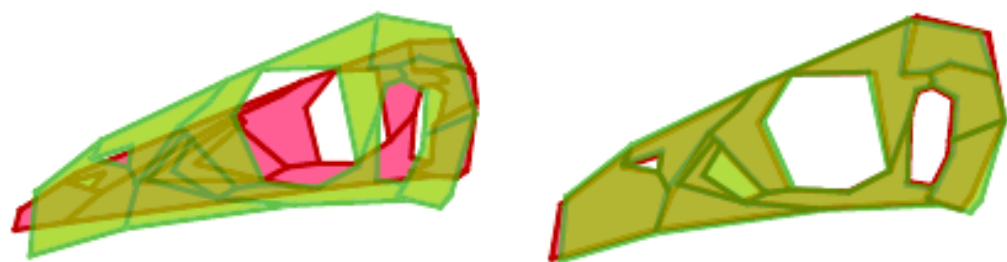
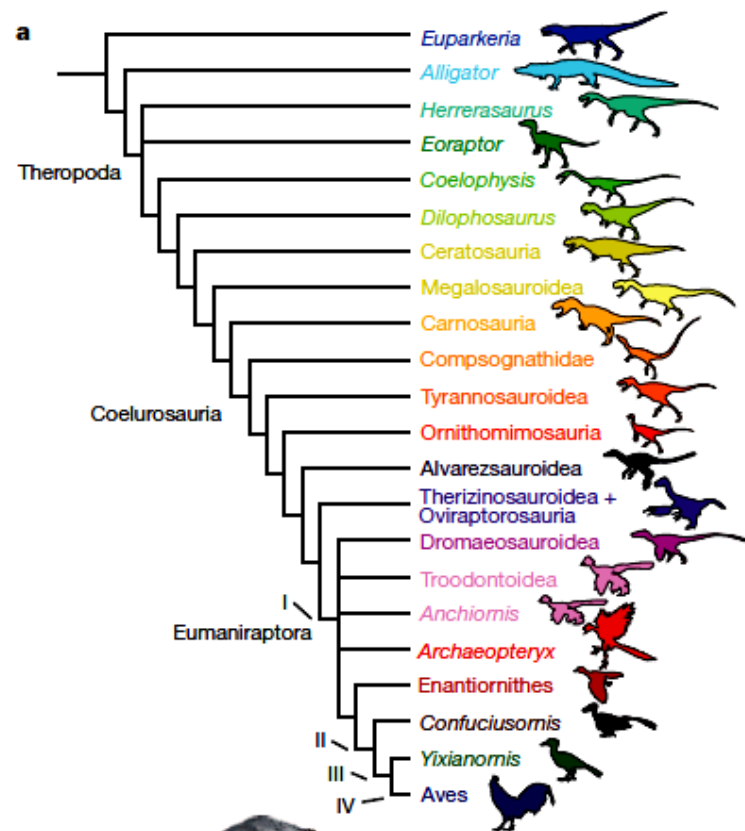

Figure 4 | Similarity of embryonic *Alligator* and adult *Confuciusornis* skulls. Superimposition of *Alligator* embryo skull (green) onto *Alligator* adult skull (red, left) and onto *Confuciusornis* adult skull (red, right), showing the nearly identical skull configuration of the latter two and indicating paedomorphic cranial morphology in *Confuciusornis*.



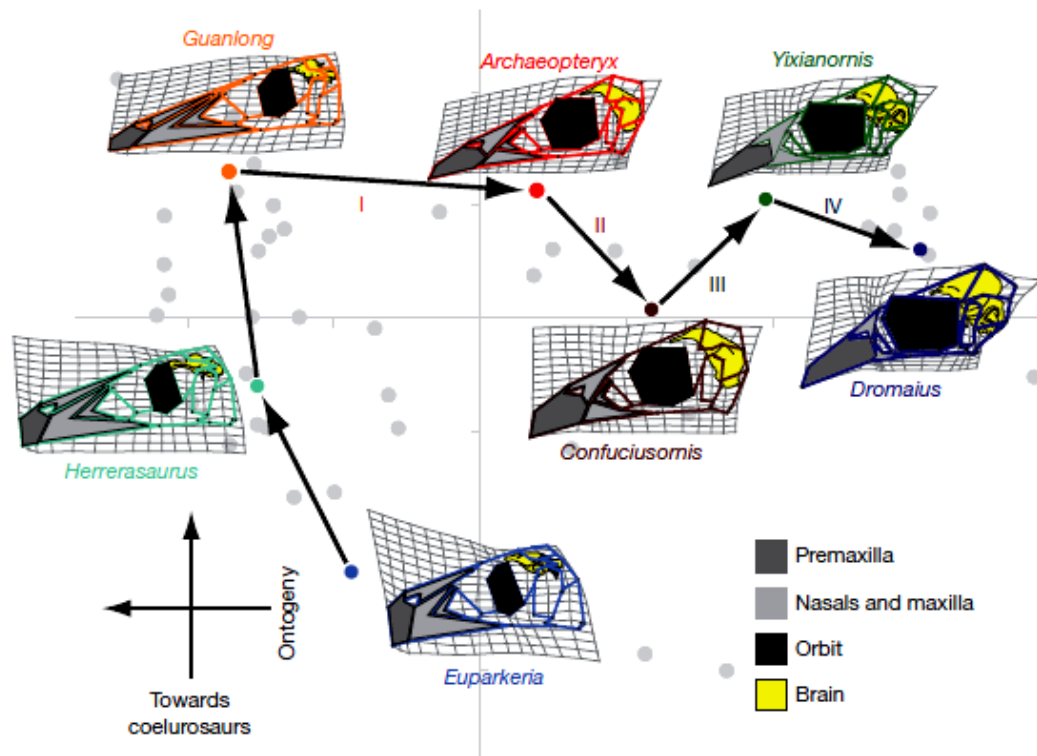
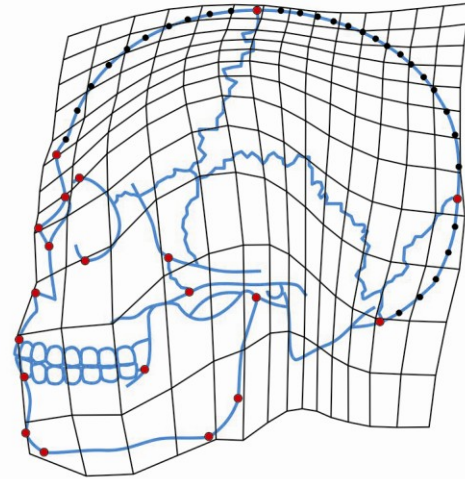
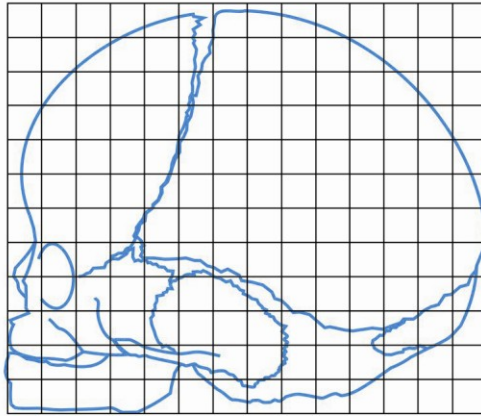

Figure 5 | Summary of heterochrony and phylogeny in bird skull evolution. A phylogenetic sequence with skull outlines set on deformation grids is depicted from the primitive stem-group archosaur *Euparkeria* to the modern

emu *Dromaius*. Heterochronic transformations referred to in the text are enumerated with Roman numerals. Major anatomical regions involved in heterochronic transformations are labelled.

Neoteny in humans?

a)



b)

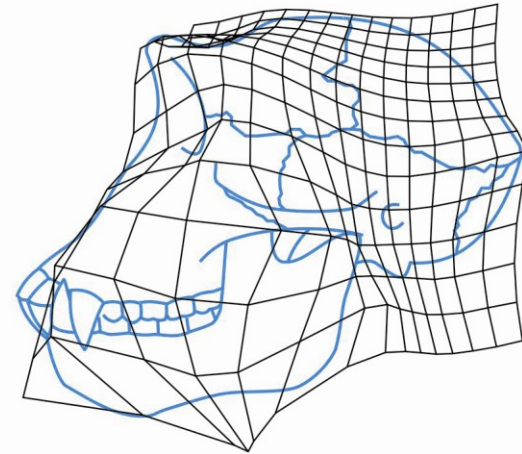
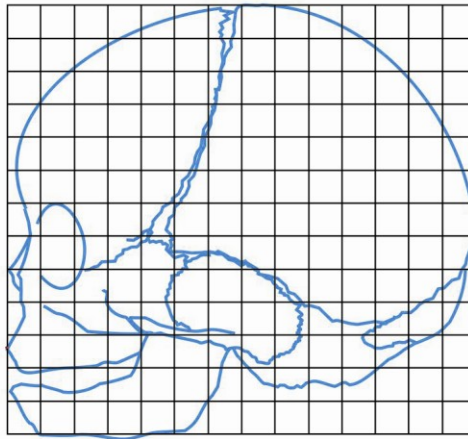

Human neotenic features compared to the chimp^{*)} (Wikipedia):

Head:

- rounded skull
- slender cranial bones
- reduced brow ridges
- large brain
- flat face
- broadened face
- hairless face
- hairs on top head
- large eyes
- ear shape
- small nose
- small teeth
- small upper and lower jaw



Genitals:

- absence of baculum (*os penis*)
- presence of hymen
- anteriorly oriented vagina

Limbs/posturer:

- legs longer than hands
- foot structure
- upright posture

„Naked“ body

^{*)} some of them are not, in fact, neotenic!

Origin of macroevolutionary novelties:

change of function of a gene product:

pigment producing enzyme → change of coloration

digestive enzyme → change of sexual habits

loss of function:

genes suppressing own pathogenicity

deletion of host proteins recognized by parasites (eg. CCR5- Δ 32

deletion in the *CCR5* gene → resistancy to the HIV and variola

.... 5-14% of Europeans, in Africans and Asiatics rare)

changes in gene regulation

prions – incorrect translation termination ⇒ bovine spongiform

encephalopathy,

scrapie of sheep and goats, kuru, Creutzfeld-Jakob disease in humans

role of gene duplications – more radical changes enabled

symbiosis, gene transfer (retroviruses)

homeotic genes

Homeotic (*Hox*) genes

William Bateson: „homeosis“ = anatomical changes of large extent (eg. development of an extra finger, cervical vertebra instead of thoracic, limb in ectopic position)

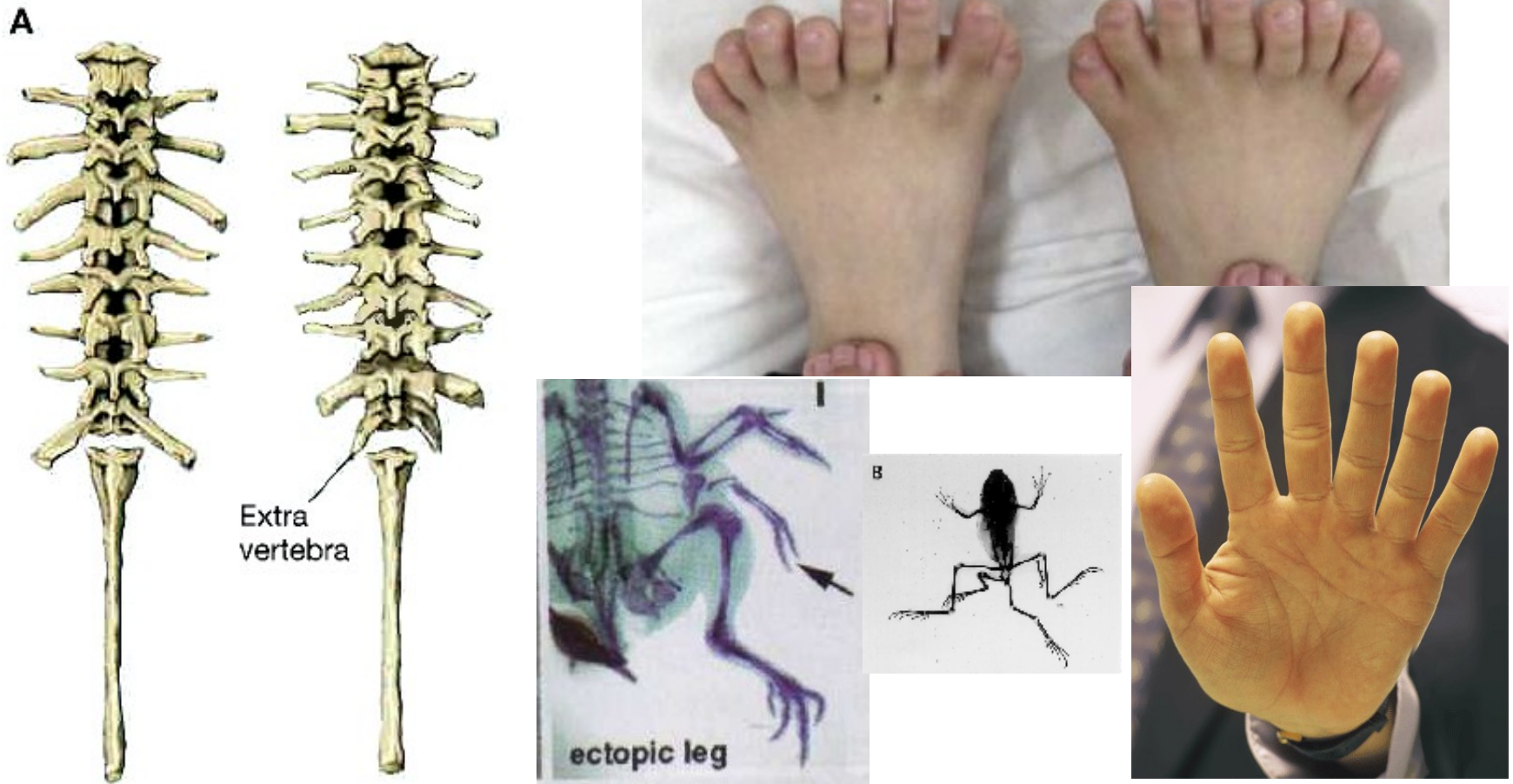

Homeotic (*Hox*) genes

Edward Lewis: **homeotic genes** = genes responsible for basic segmentation of multicellular animals – homeotic mutations do not change the number of segments but their identity

control of transcription of other genes (eg. *Ubx* probably regulates hundreds of „target“ genes)

determination of basic body segmentation

high evolutionary conservativeness

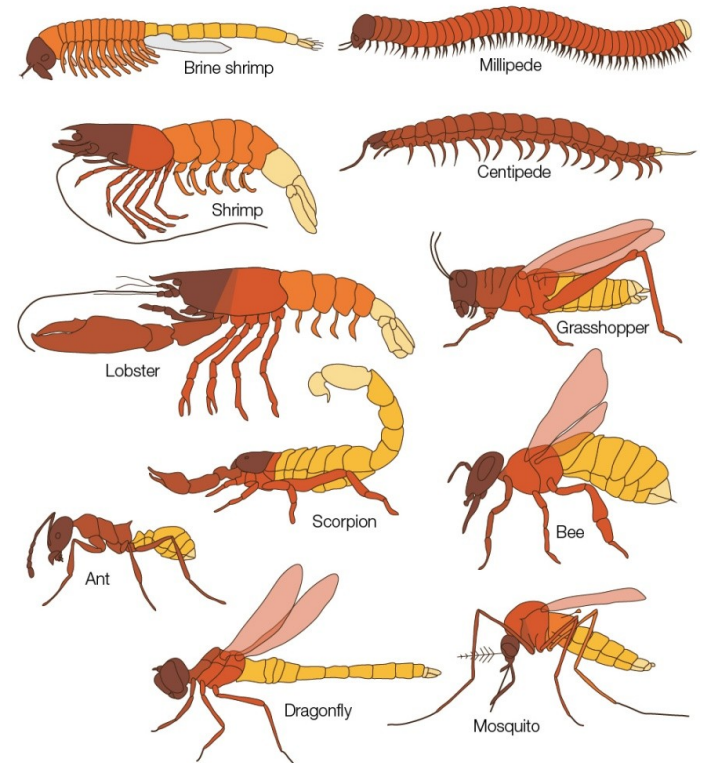

Homeotic mutation

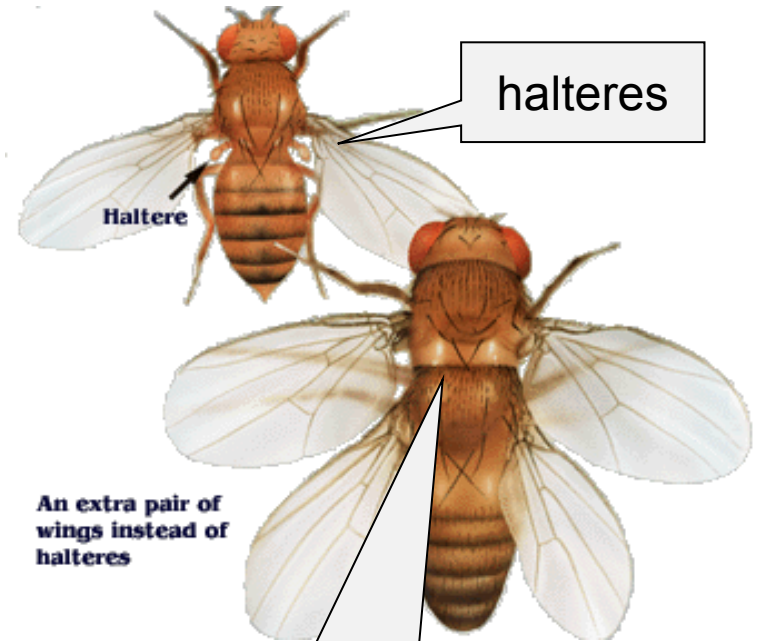

mutation of the
Ultrabithorax gene:
3rd thoracic segment
(T3) → T2

Bithorax

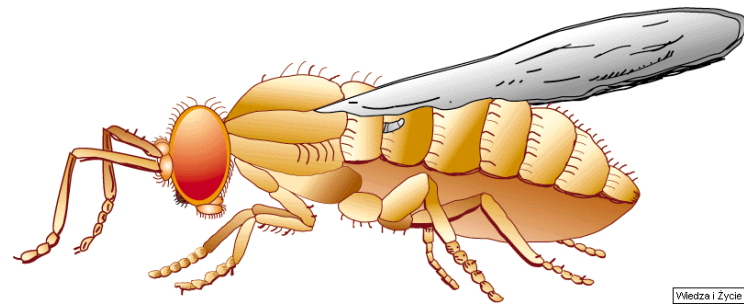

Antennapedia

Wiedza i Życie

Hox genes: basic antero-posterior body segmentation

linear clusters, same order as the segments

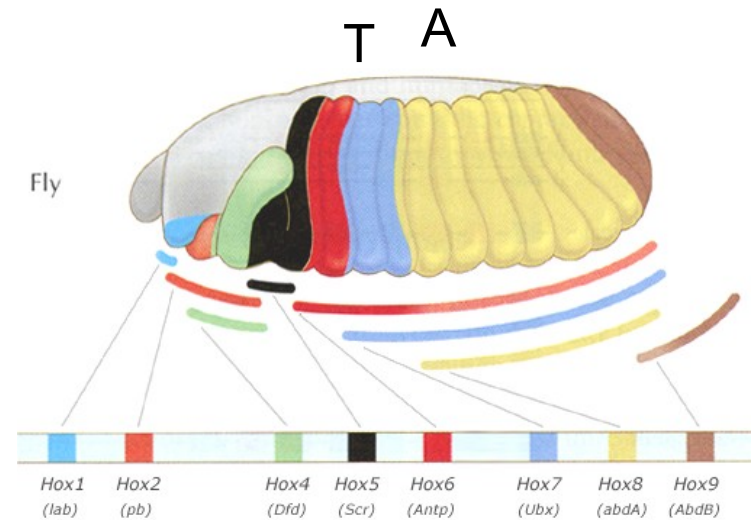
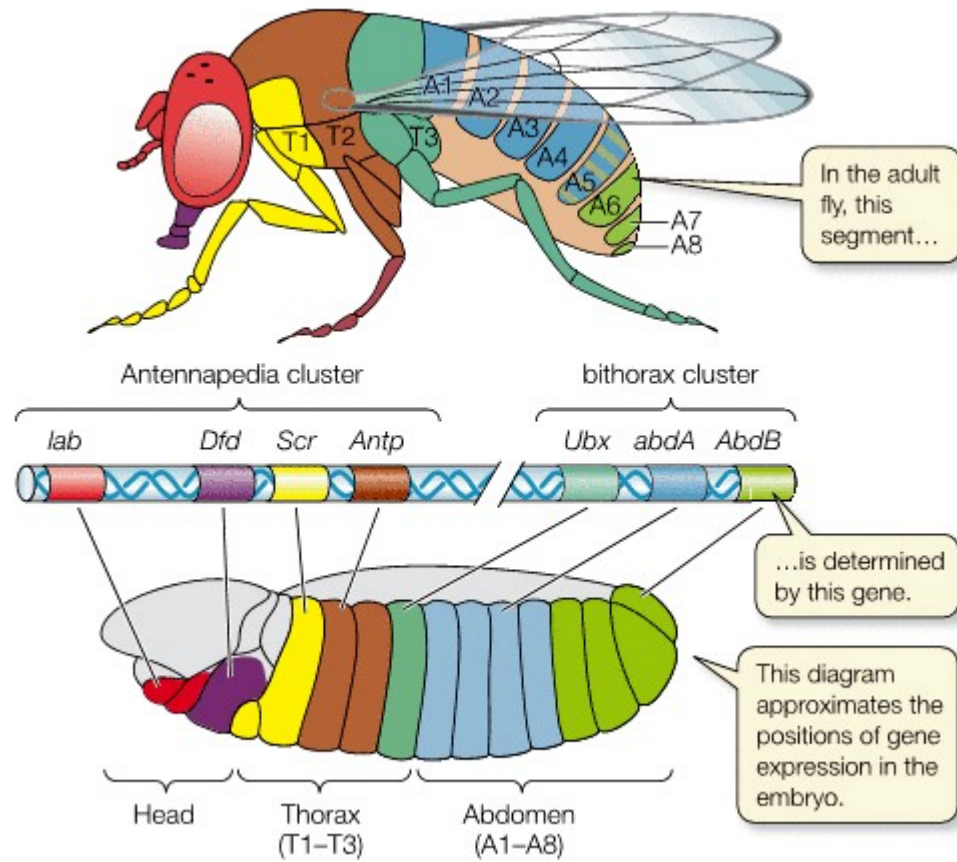

Hox gene effects are overlapping

Drosophila: 1 linkage group, 2 clusters:

Antennapedia (ANT-C)

Bithorax (BX-C)

vertebrates:

4 linkage groups

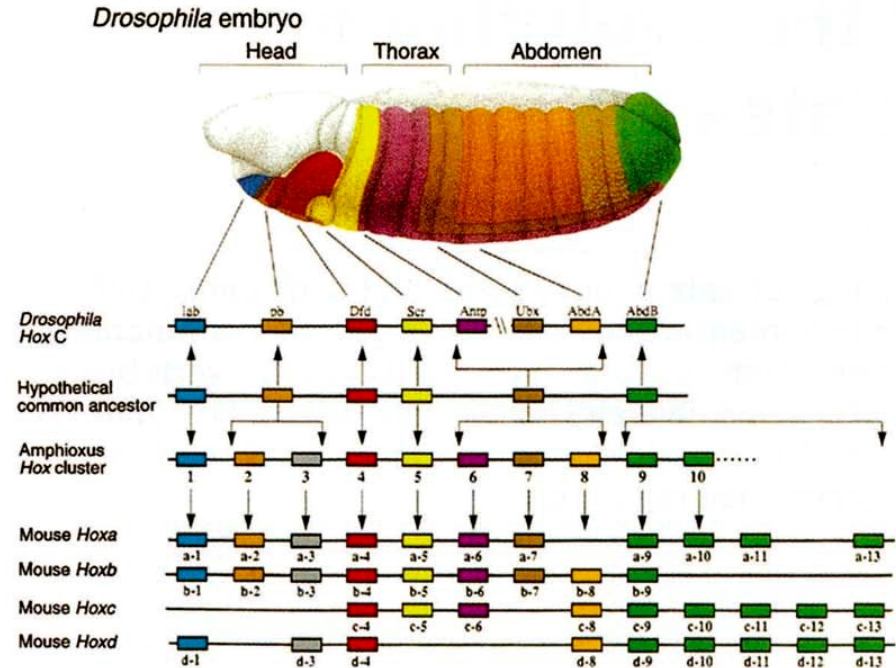

Mouse embryo

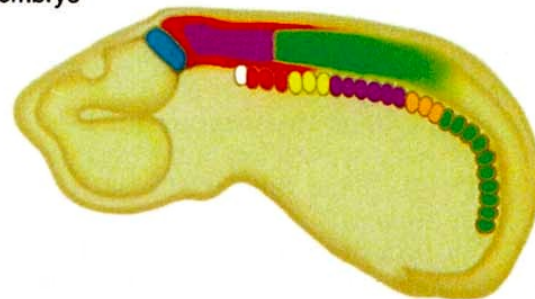

Drosophila

člověk

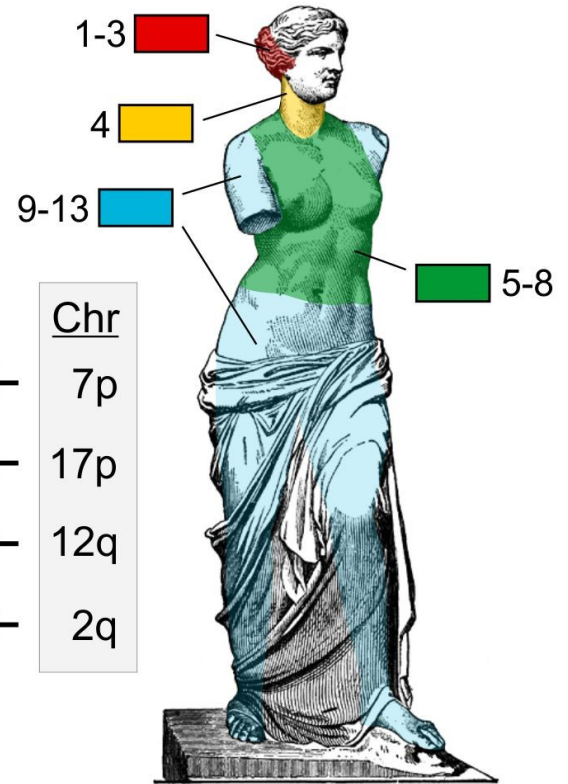
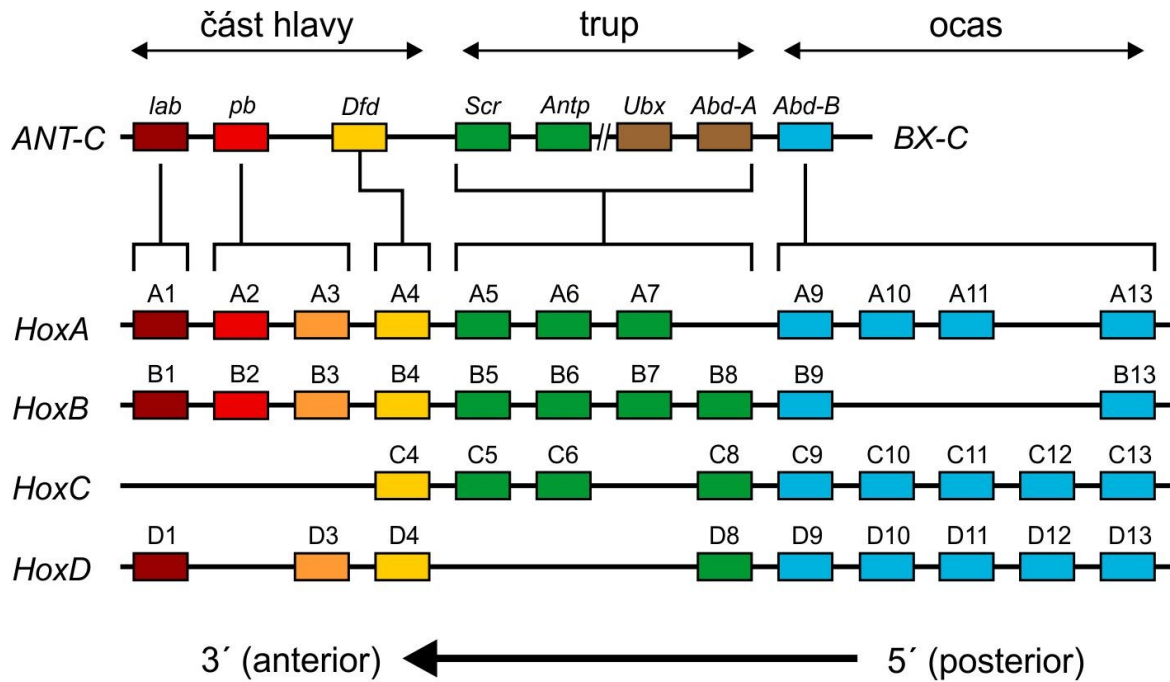

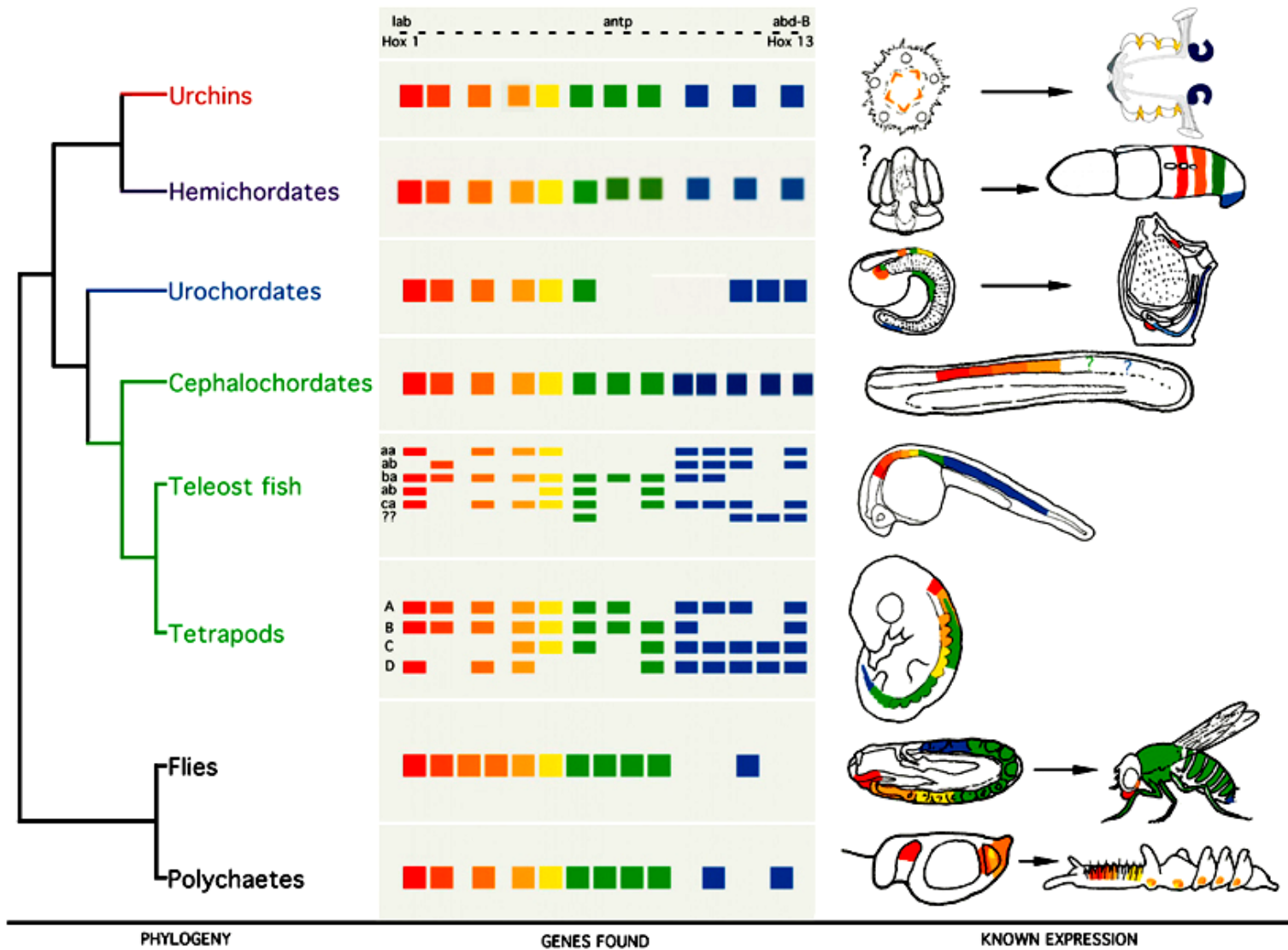

Homeobox: 180 bp → homeodomain

60 AA (expression regulation)

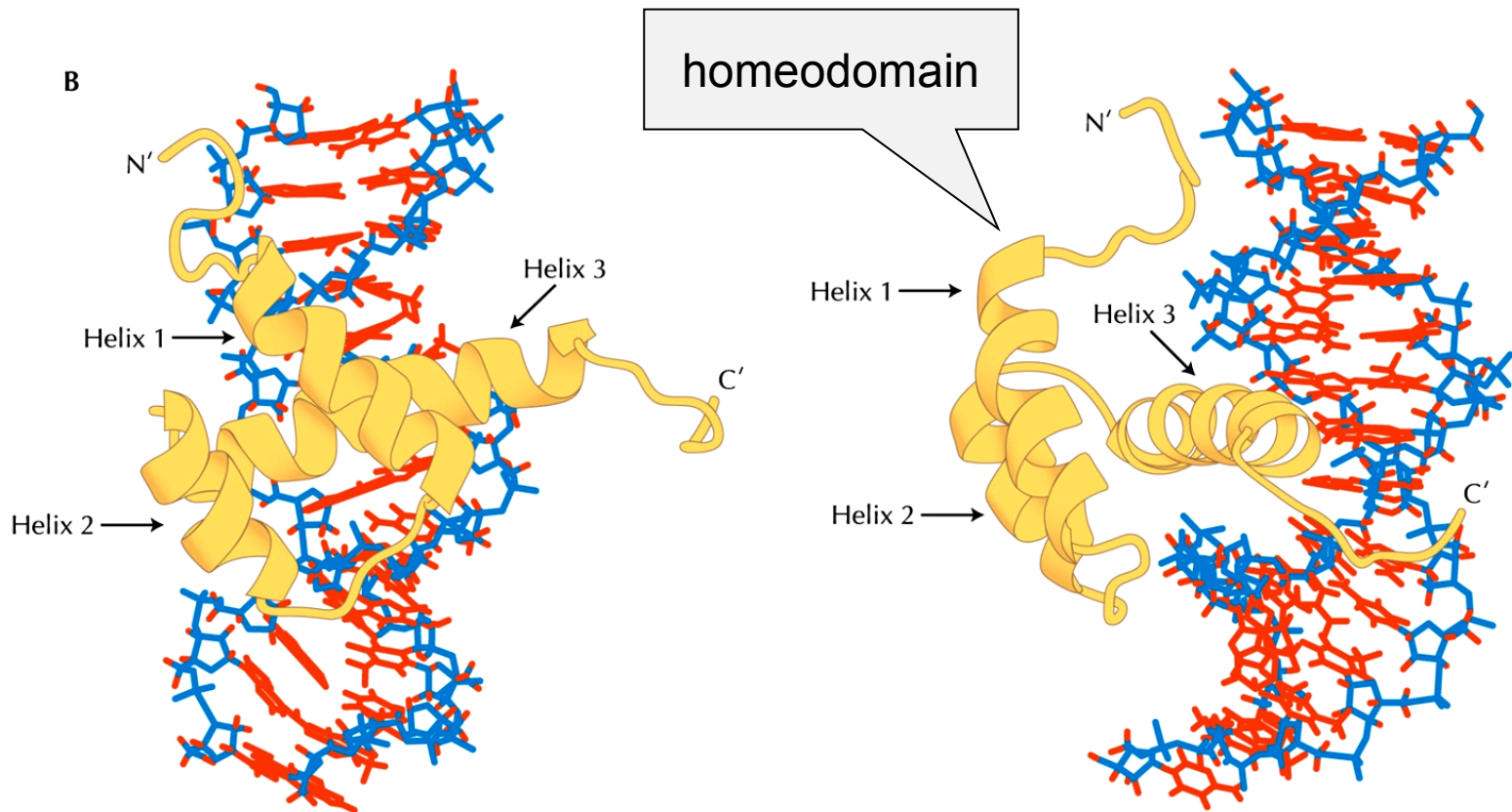

Hox-genes are highly conservative

A

Scr group

Fruit fly	TKRQRTSYTRYQTLELEKEFHFNRYLTRRRRIEIAHALCLTERQIKIWFQNRMMKLLKKEH
Grasshopper	TKRQRTSYTRYQTLELEKEFHFNRYLTRRRRIEIAHALCLTERQIKIWFQNRMMKWKKEH
Beach hopper	TKRQRTSYTRYQTLELEKEFHFNRYLTRRRRIEIAHALCLTERQIKIWFQNRMMKWKKEH
Centipede	TKRQRTSYTRYQTLELEKEFHFNRYLTRRRRIEIAHSLCLSERQIKIWFQNRMMKWKKEH
Mite	TKRQRTSYTRYQTLELEKEFHFNRYLTRRRRIEIAHSLCLSERQIKIWFQNRMMKWKKEH
Leech	NKRTRTSYTRHQTLELEKEFHFNRYLSRRRRIEIAHVLNLSERQIKIWFQNRMMKWKKDH
Sea urchin	SKRSRTAYTRYQTLELEKEFHFNRYLTRRRRIEIAHALGLTERQIKIWFQNRMMKWKKEH
Zebra fish	GKRARTAYTRYQTLELEKEFHFNRYLTRRRRIEIAHALCLSERQIKIWFQNRMMKWKKDN
Mouse	GKRARTAYTRYQTLELEKEFHFNRYLTRRRRIEIAHALCLSERQIKIWFQNRMMKWKKDN
Human	GKRARTAYTRYQTLELEKEFHFNRYLTRRRRIEIAHALCLSERQIKIWFQNRMMKWKKDN

Antp group

Fruit fly	RKRGRQTYTRYQTLELEKEFHFNRYLTRRRRIEIAHALCLTERQIKIWFQNRMMKWKKEN
Grasshopper	RKRGRQTYTRYQTLELEKEFHFNRYLTRRRRIEIAHALCLTERQIKIWFQNRMMKWKKEN
Beach hopper	RKRGRQTYTRYQTLELEKEFHFNRYLTRRRRIEIAHALCLTERQIKIWFQNRMMKWKKEN
Centipede	RKRGRQTYTRYQTLELEKEFHFNRYLTRRRRIEIAHALCLTERQIKIWFQNRMMKWKKEN
Spider	RKRGRQTYTRYQTLELEKEFHFNRYLTRRRRIEIAHALCLTERQIKIWFQNRMMKWKKEN
Leech	QKRTRQTYTRYQTLELEKEFYSNRYLTRRRRIEIAHSLALSERQIKIWFQNRMMKWKKEN
Sea urchin	GKRGRQTYTRQQTLELEKEFHFVTRRRRFEIAQSLGLSERQIKIWFQNRMMKWKREH
Zebra fish	GRRGRQTYTRYQTLELEKEFHFNRYLTRRRRIEIAHALCLTERQIKIWFQNRMMKWKKEN
Mouse	GRRGRQTYTRYQTLELEKEFHYNRYLTRRRRIEIAHALCLTERQIKIWFQNRMMKWKKES
Human	GRRGRQTYTRYQTLELEKEFHYNRYLTRRRRIEIAHALCLTERQIKIWFQNRMMKWKKES

ParaHox genes

MADS-box genes in plants

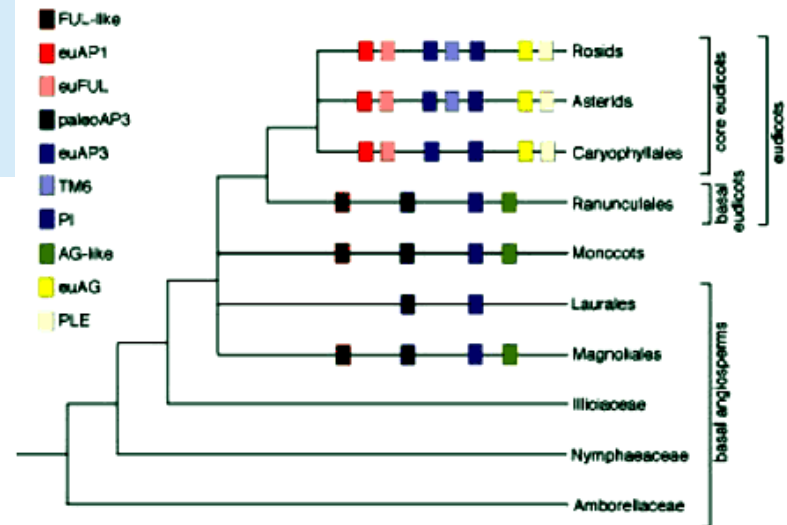
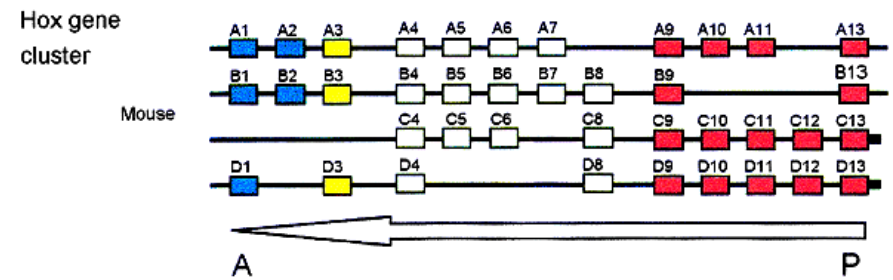
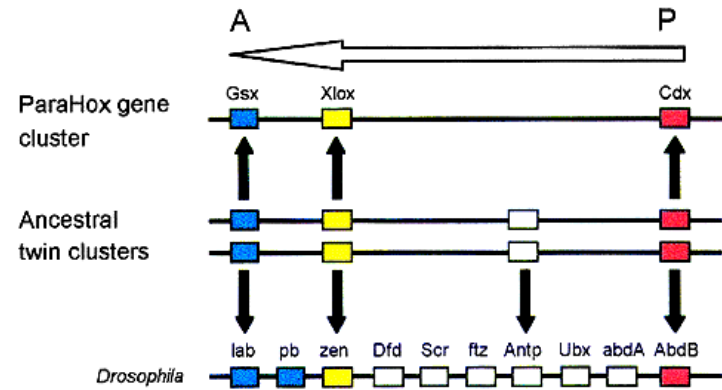
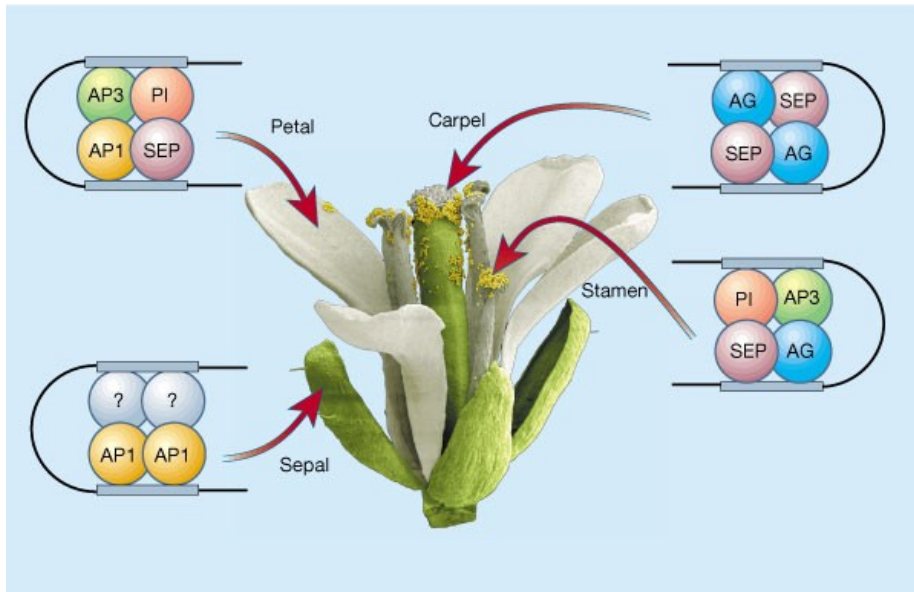

3 hypotheses of the origin of dipteran arrangement:

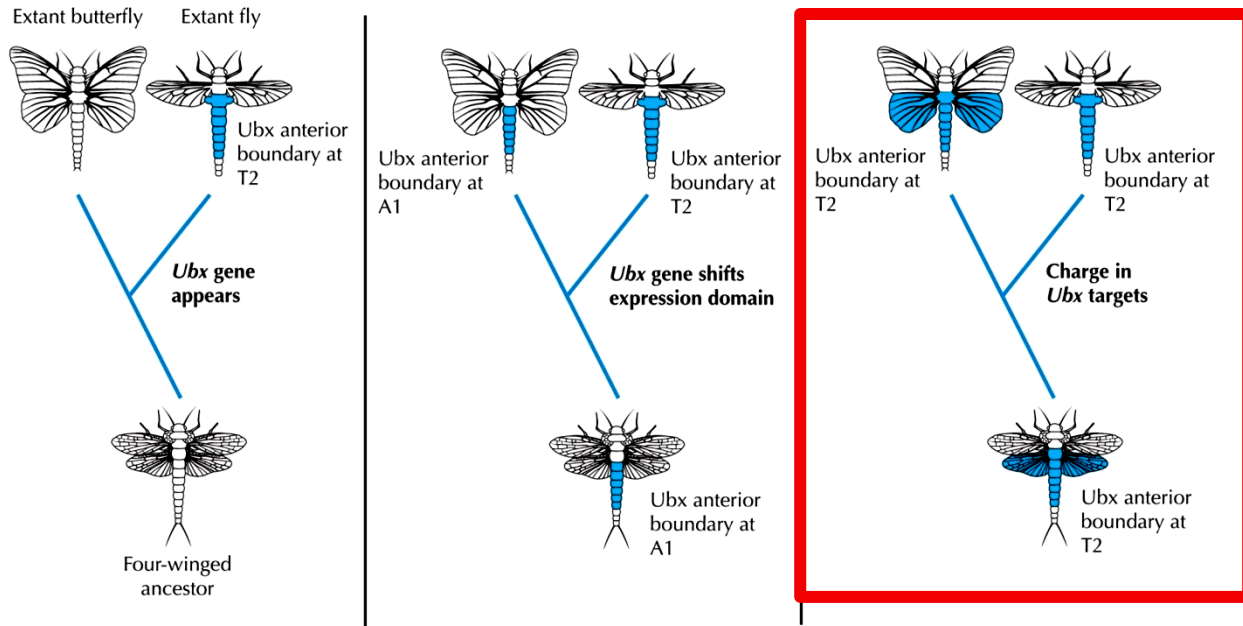

Ubq protein expression:

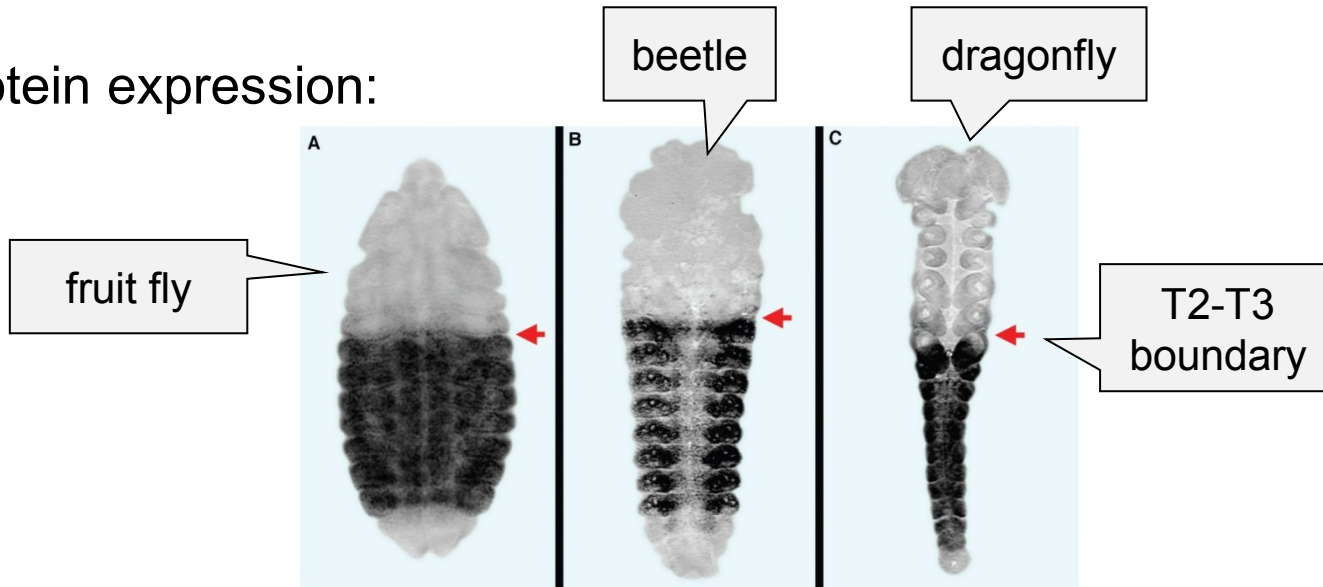

original function:
venation development

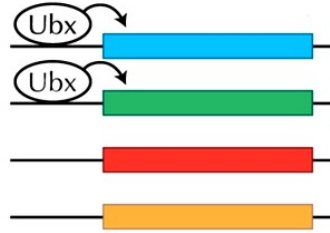
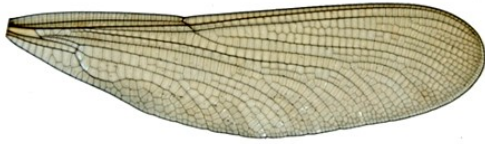

Ancestral insect
hindwing

Promotes vein
development



Dipteran
haltere



Lepidopteran
hindwing

loss of
function ...

... but origin of
halteres

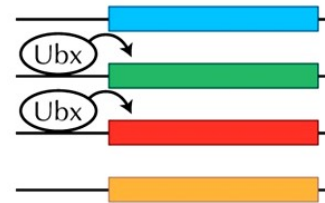

Creates balloon
shape

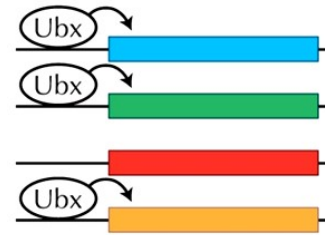

Promotes vein
development

Controls scale
morphology
and color

in butterflies also
scale morphology
and wing coloration

Evolution of thoracic segments in crustaceans – shift of anteroposterior boundary of expression of the *Ubx* gene:

thoracic segments: copepods – 6, lobster – 8, brine shrimps – 11 (ancestral)

movement → maxillipedes

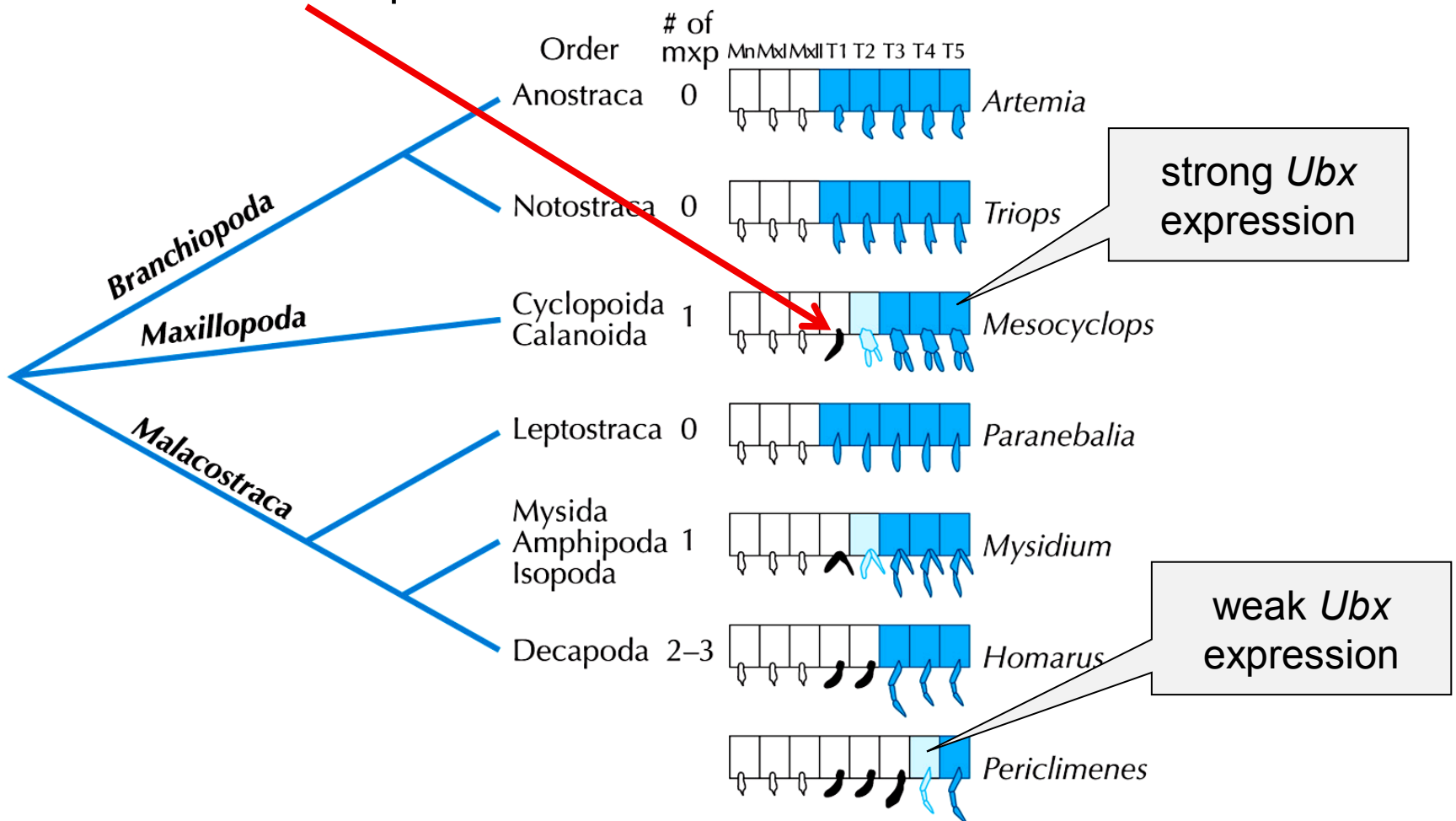

shift of anteroposterior boundary of *Ubx* gene expression = position of transition of locomotory segments and maxillipedes

např. opossum shrimps: 2nd segment, prawns: 4th segment

2nd thoracic limb of opossum shrimps = transitional segment between 1st (maxillipede) and 3rd limb (locomotion)

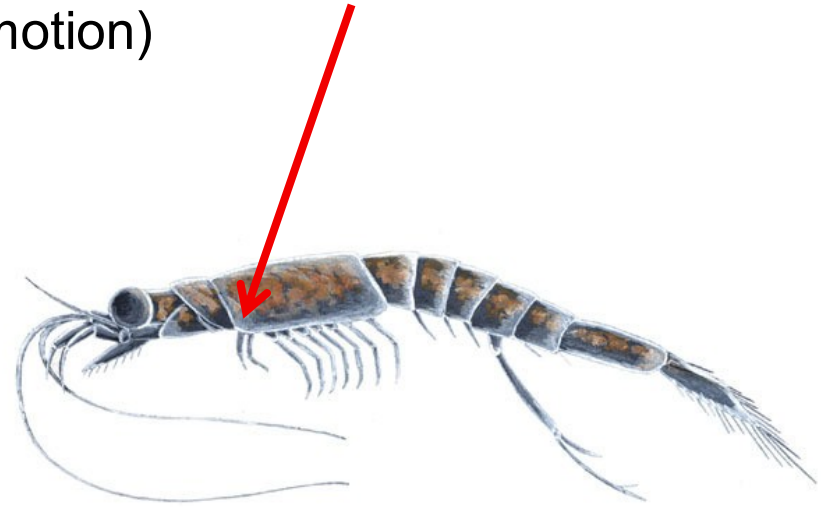
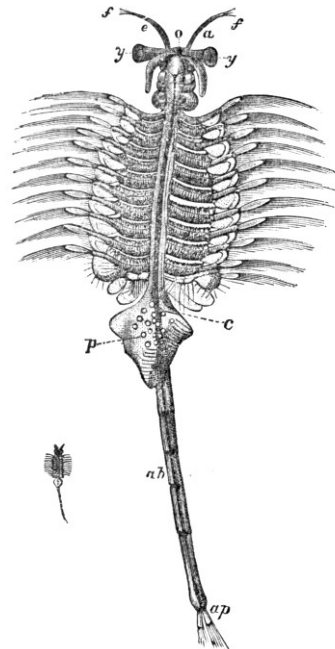

Besides transcriptional factors also regulatory enhancers:

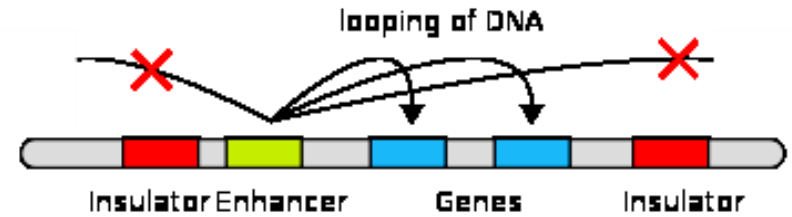
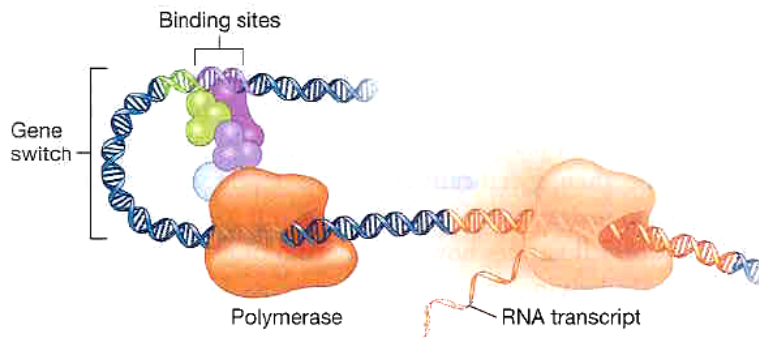
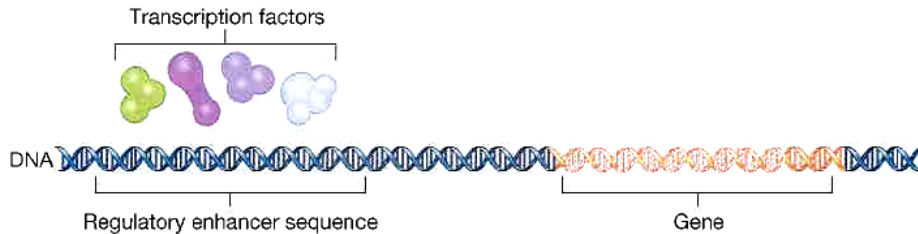

Activators

The regulatory proteins bind to DNA at distant sites known as enhancers. When DNA folds so that the enhancer is brought into proximity with the transcription complex, the activator proteins interact with the complex to increase the rate of transcription.

Repressors

These regulatory proteins bind to "silencer sites" on the DNA preventing the binding of activator to nearby enhancers and so slowing transcription.

Basal factors

These transcription factors, in response to coactivators, position RNA polymerase at the start of a protein-coding sequence, and then release the polymerase to transcribe the mRNA

Coactivators

These transcription factors transmit signals from activator proteins to the basal factors.

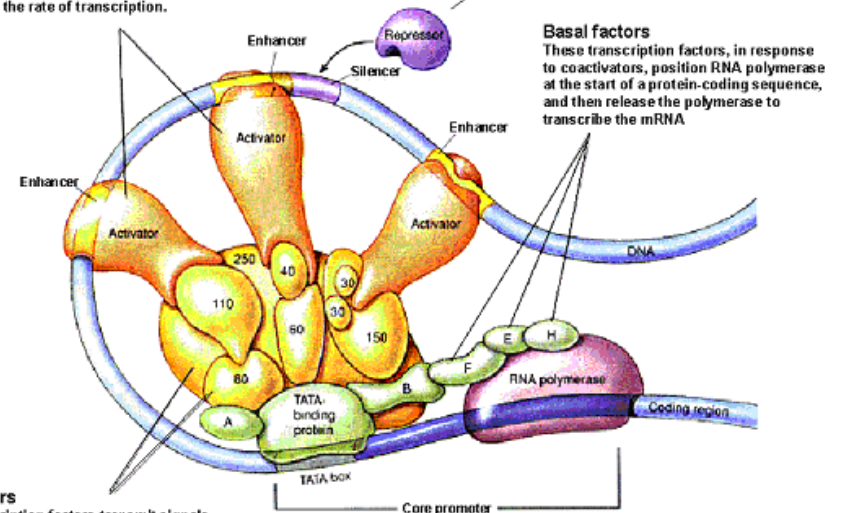

Macroevolutionary trends species selection

trends: real \times passive (eg. wall effect)

Edward Drinker Cope: trend to bigger size

Species selection:

= preferential survival or proliferation of species

different
extinction rates

(a) Differential extinction rate

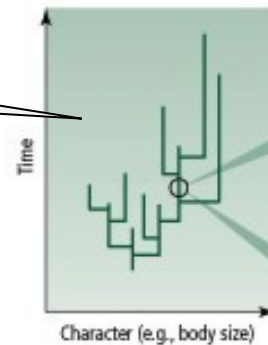

Neutral

Stabilizing
selection

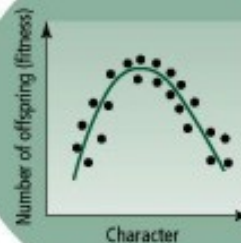
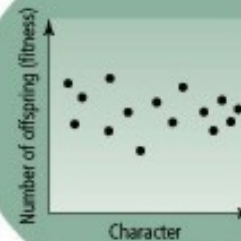

different
speciation rates

(b) Differential speciation rate

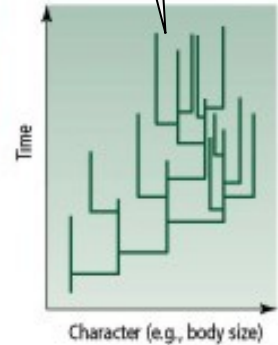

the trait connected with differential survival or speciation

these features independent of natural selection

trait is heritable during speciation

SS favours only nonadaptive trends
(otherwise = natural selection)

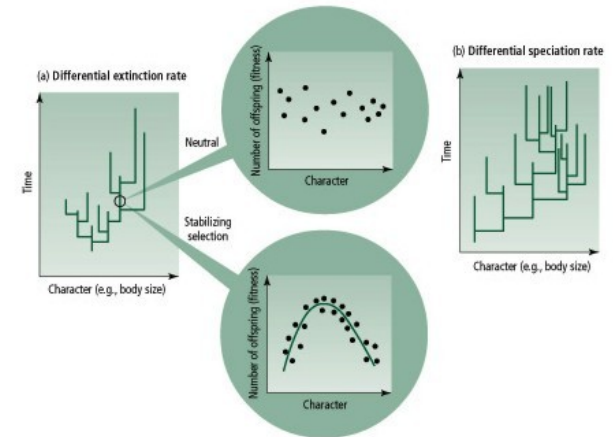

Necessary to prove:

higher speciation rate/lower extinction rate in lineages which deviate from the average in the direction of the trend

the trend and distribution of varied speciation/extinction rates are not caused by shift in fossil record

the trend and distribution of varied speciation/extinction rates are not caused by natural selection