

## **Průtoková cytometrie a sorting**

Karel Souček

Biofyzikální ústav AV ČR, Masarykova Univerzita,  
FNUSA-ICRC

# Tyto částice mají něco společného ...

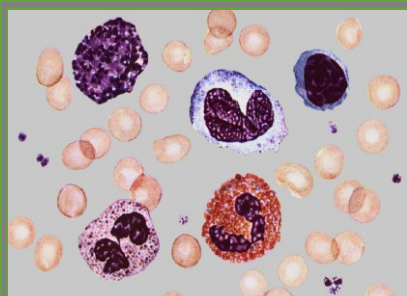

Blood cells



Chromosomes



Algae

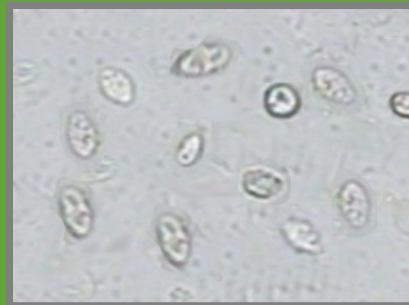

Protozoa

... určité parametry těchto částic mohou být měřeny pomocí průtokové cytometrie.

# Komerční zařízení a vývoj

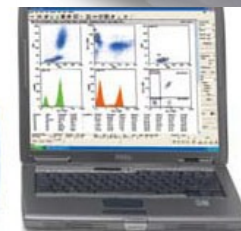
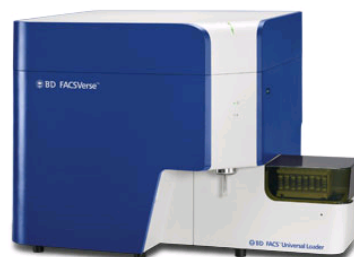

# Cytometry Publications/Year

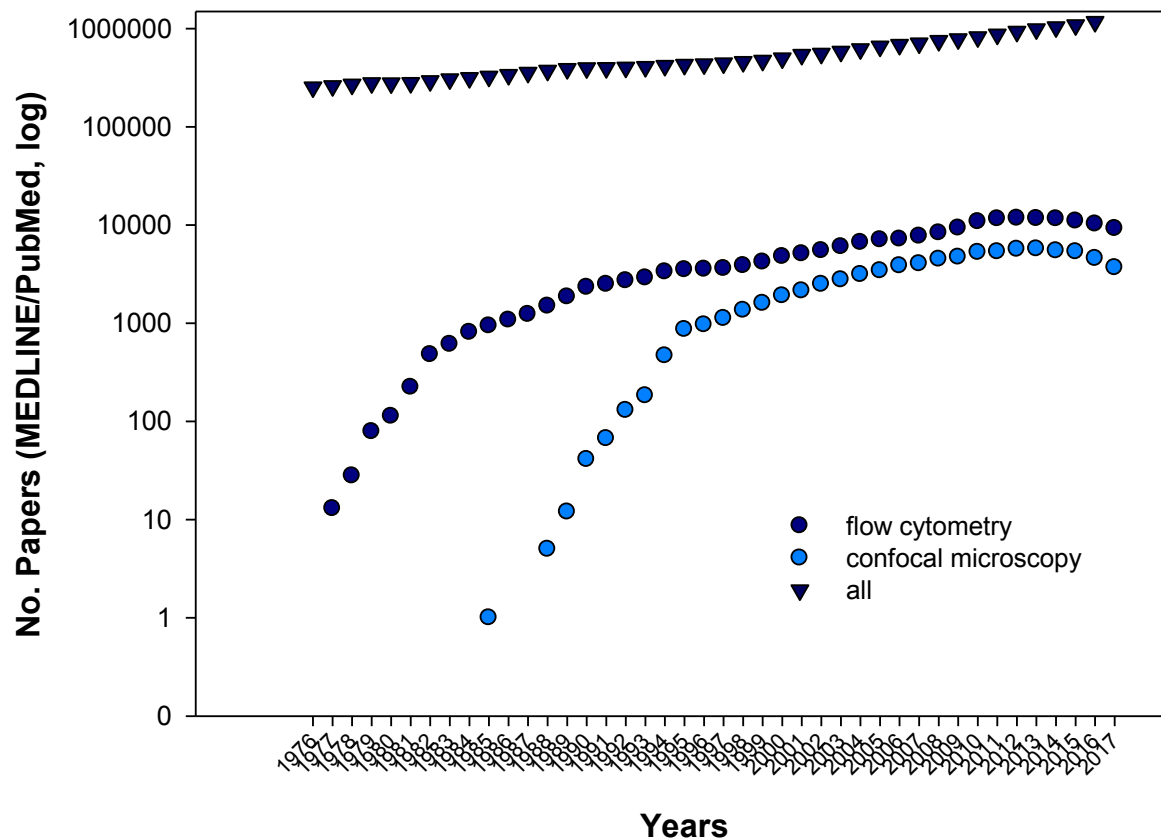



# Co je průtokový cytometr?

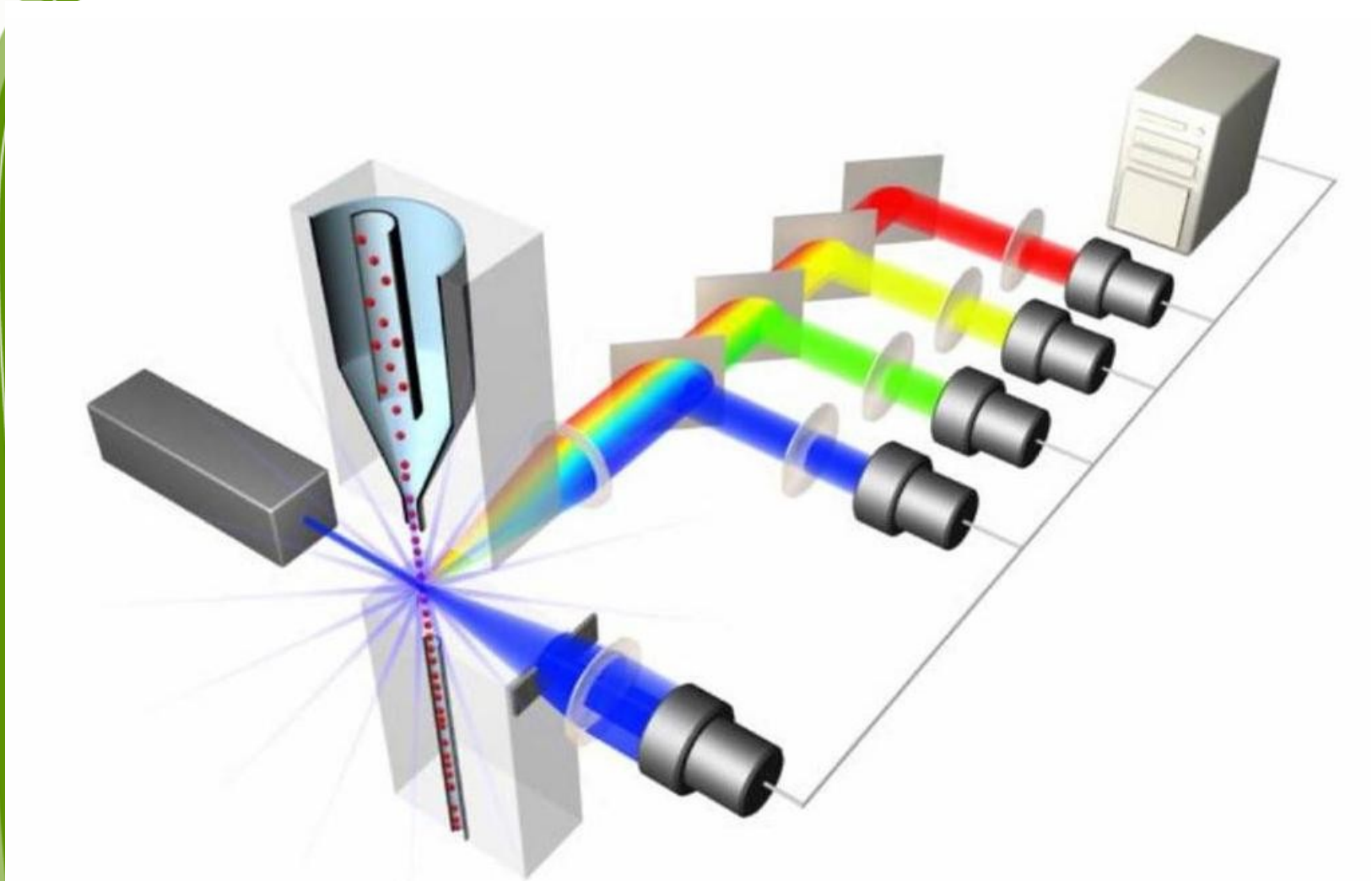

# Signal processing

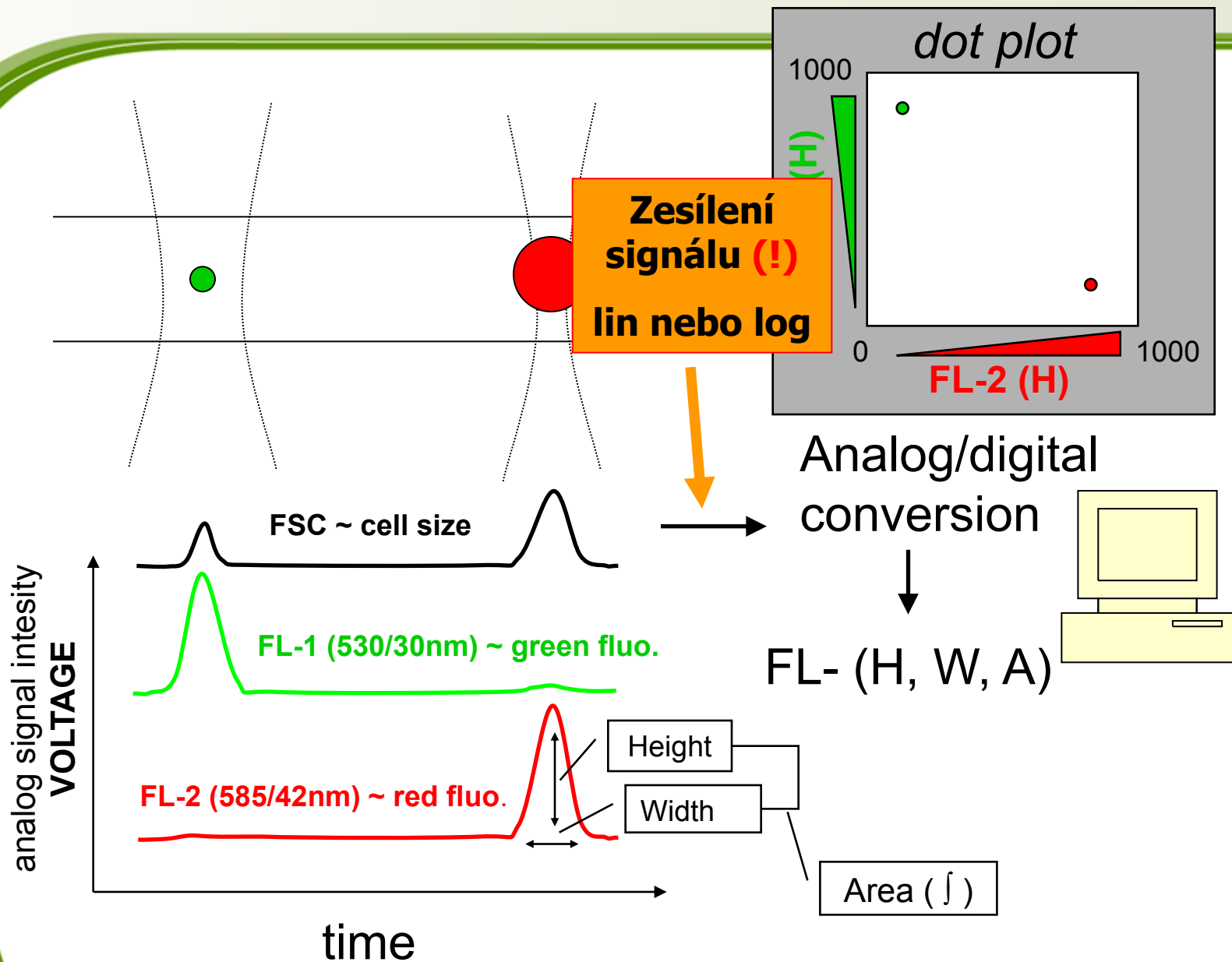

# Co můžeme analyzovat pomocí průtokové cytometrie?

- ▶ Počítat částice v suspenzi
- ▶ Oddělit živé částice od neživých
- ▶ Hodnotit  $10^5$  až  $10^6$  částic za méně než 1 minutu
- ▶ Kvantifikovat rozptyl světla, a intenzitu fluorescence pro jednotlivé buňky (částice)
- ▶ Fyzicky separovat jednotlivé částice (populace) pro další analýzu

# new automatic cell cloning assay (ACCA) for determination of clonogenic capacity of CSCs

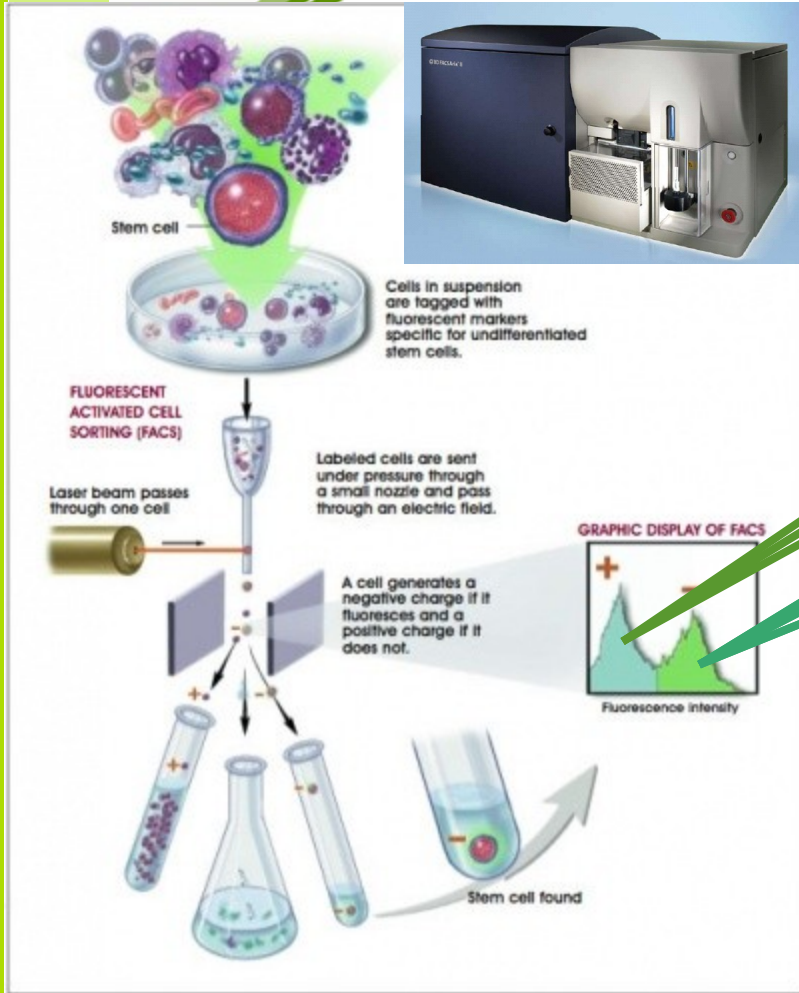

single cell/well  
up to 384 well plate



re-culture after sorting (2D, 3D)

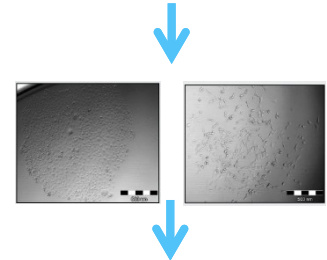

analysis: CyQuant, ATP, xCelligence, microscopy



# Jaké jsou principy?

- Rozptyl světla (Light scatter) pomocí laseru nebo UV lampy
- Detekce specifické fluorescence
- Hydrodynamicky zaostřený proud částic
- Elektrostatická separace částic
- Možnost multivariační analýzy dat

## Stain Your Own Cell





# Historie barvení biologických materiálů

Až do poloviny 19. století – *byly používány pouze přírodní barviva*

*Anton van Leeuwenhoek* použil v roce 1719 šafrán na obarvení svalových buněk

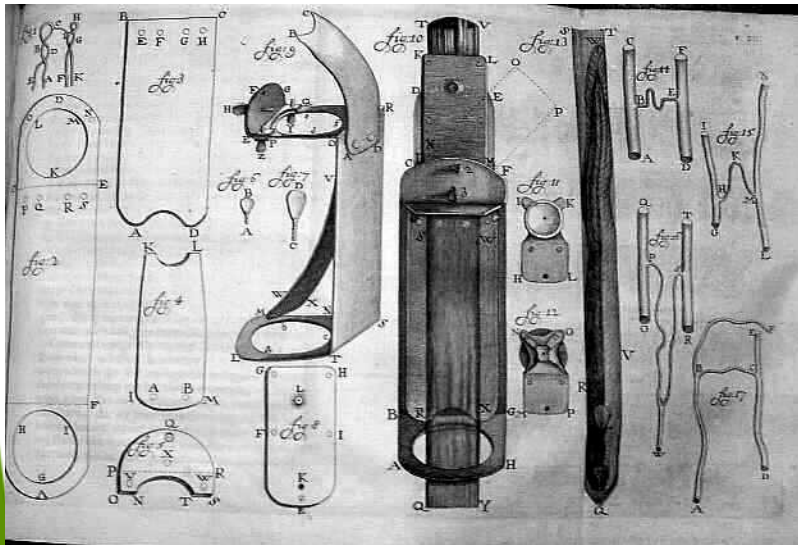

Leeuwenhoek  
Microscope  
(circa late 1600s)



# Rozptyl světla

- Hmota rozptyluje světlo vlnových délek které není schopna absorbovat
- Viditelné spektrum je 350-850 nm proto malé částice a molekuly ( $< 1/10 \lambda$ ) spíše viditelné světlo rozptylují
- Pro malé částice byl popsán tzv. **Rayleightův rozptyl (scatter)** jehož intenzita je  $\sim$  stejná všemi směry
- Rozptyl větších částic charakterizuje tzv. **Mieův rozptyl**. Jeho množství je větší ve směru v jakém dopadá světlo na ozářenou částici  $\Rightarrow$  *na tomto principu je založeno měření velikosti částic pomocí průtokového cytometru*

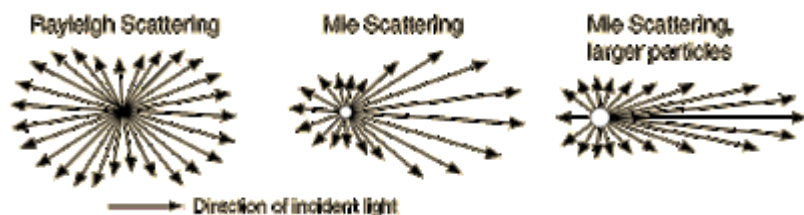

# George Gabriel Stokes (1819 – 1903)

Anglický fyzik a matematik  
působící na univerzitě v Cambridge



<http://www.nndb.com/people/131/000097837/>

1852 – popsal fluorescenci  
Název vznikl z anglického slova *fluospar*  
(fluorit, kazivec = nerost  $\text{CaF}_2$ )  
- ke svému pozorování použil roztok  
**chininu**, jako zdroj světla sluneční  
paprsky, jako excitační filtr sloužilo tmavě  
modré okenní sklo a jako emisní filtr byla  
použita sklenice bílého vína

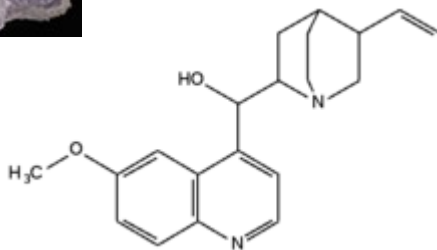

G. C. Stokes „*On the Change of Refrangibility of Light*“ *Philosophical Transactions of the Royal Society of London*, 1852, vol. 142, p. 463.)

[ 463 ]

XXX. *On the Change of Refrangibility of Light.* By G. G. STOKES, M.A., F.R.S.,  
Fellow of Pembroke College, and Lucasian Professor of Mathematics in the  
University of Cambridge.

Received May 11,—Read May 27, 1852.

## Fluorescenční spektra

Fluorescenční proces je cyklický.

Kromě fluorochromu nevratně zničeného (photobleaching - „vysvícení“) může být opakovaně excitován.

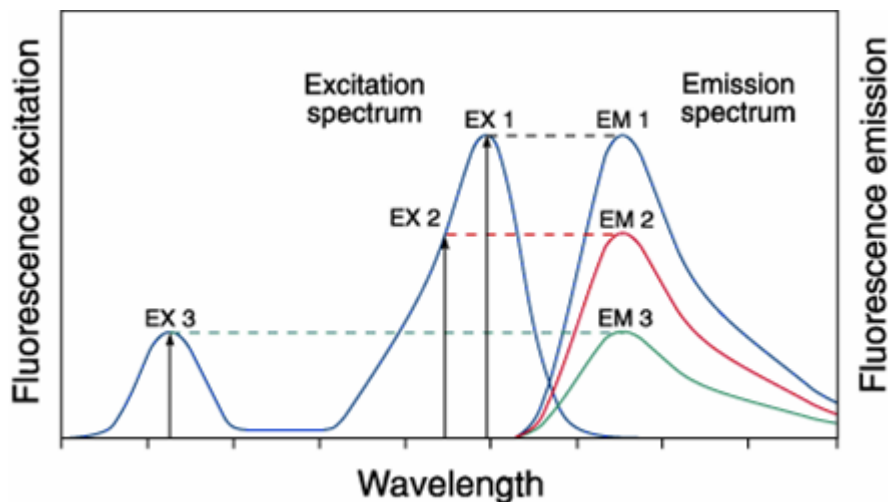

Excitation of a fluorophore at three different wavelengths (EX 1, EX 2, EX 3) does not change the emission profile but does produce variations in fluorescence emission intensity (EM 1, EM 2, EM 3) that correspond to the amplitude of the excitation spectrum.

# Detekce fluorescence

## Vybavení pro fluorescenci

- (1) zdroj excitace
- (2) fluochrom
- (3) vlnové filtry pro izolaci emitovaných fotonů od excitovaných
- (4) detektory pro registraci emitovaných fotonů

## Fluorescenční přístroje

- spektrofluorometer měří průměrné vlastnosti objemu vzorku v kyvetě.
- fluorescenční mikroskop popisuje fluorescenci jako jev v prostorovém systému souřadnic
- flow cytometer měří fluorescenci v proudícím toku, umožňuje detekovat a kvantifikovat subpopulace uvnitř velkého vzorku

## Fluorescenční signál

- spektrofluorometer je flexibilní, umožňuje n v kontinuálním spektru excitačních a emisní vlnových délek
- flow cytometr potřebuje fluorescenční značkovatelné určitou vlnovou délkou.

## Fluorescence pozadí

- endogenní složky - autofluorescence
- nenávanané nebo nespecificky vázané zr = reagenční pozadí

## Vícebarevné značení

- dvě a více značek, zároveň monitoruje různé funkce
- nutné: vhodně zvolit značky zdroj excitace a separační filtry

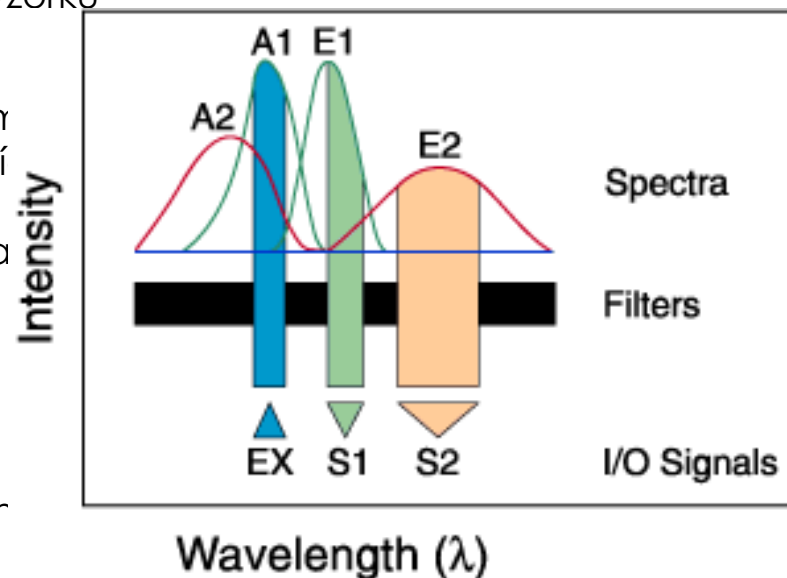



# Fluorescence Output of Fluorophores

## Comparing Different Dyes

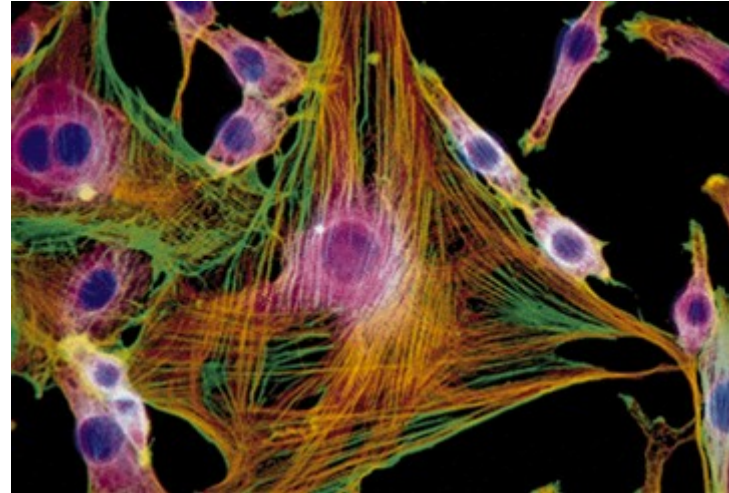
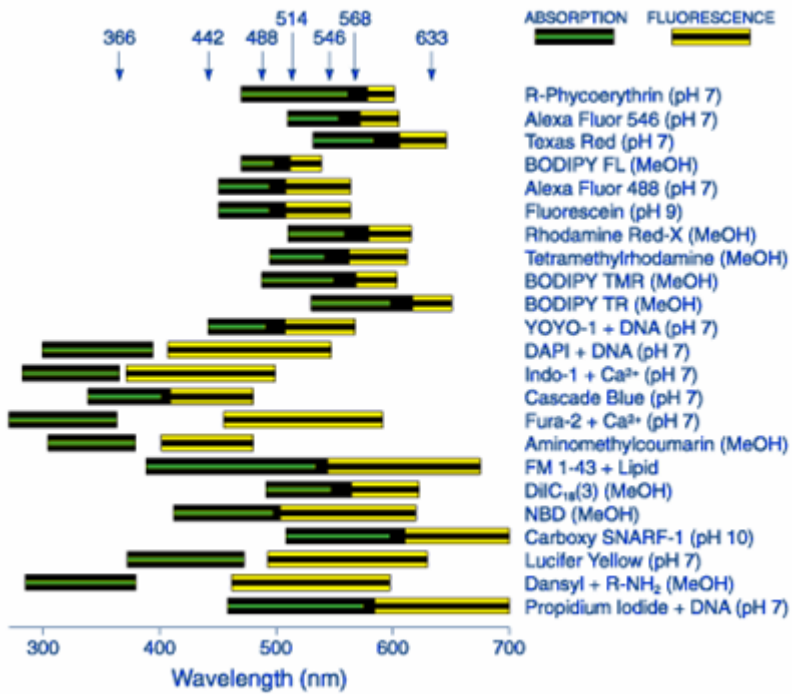

Mouse 3T3

F-actin ~  
BODIPY FL phalloidin

anti-β tubulin ~  
Texas Red  
goat anti-mouse IgG

DNA ~  
DAPI

POPO-1    BOBO-1    YOYO-1    TOTO-1    JOJO-1    POPO-3    LOLO-1    BOBO-3    YOYO-3    TOTO-3

λ Hind III

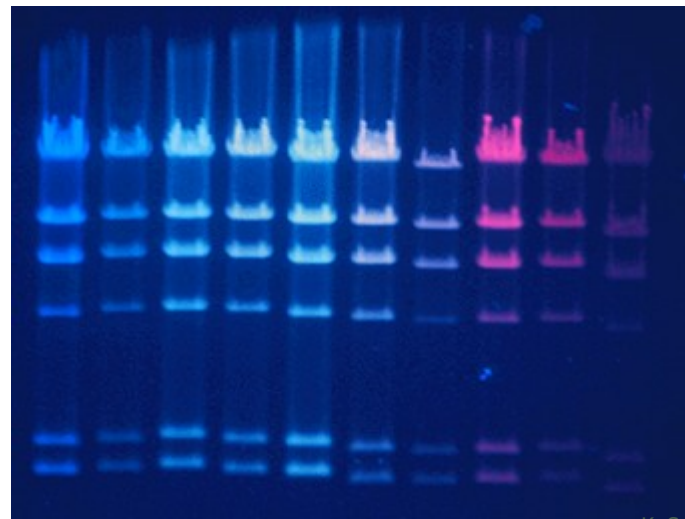
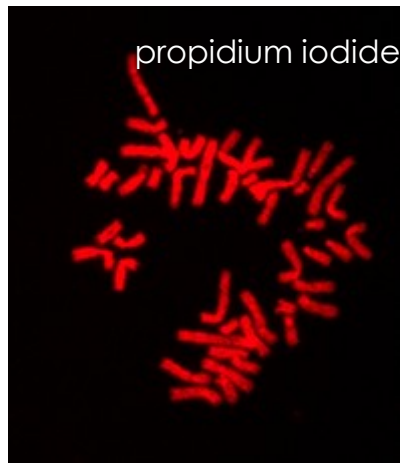



# Technické součásti

- Zdroje světla
- Detekční systémy
- Fluidní systém
- Separace
- Sběr dat
- Analýza dat

# Wallace Coulter



- **Wallace Coulter - Coulter orifice - 1956 -**
- (patent 1953) – měření změny vodivosti během průchodu buněk v suspenzi malým otvorem

Originální  
patentová  
aplikace  
W.Coultera 1953

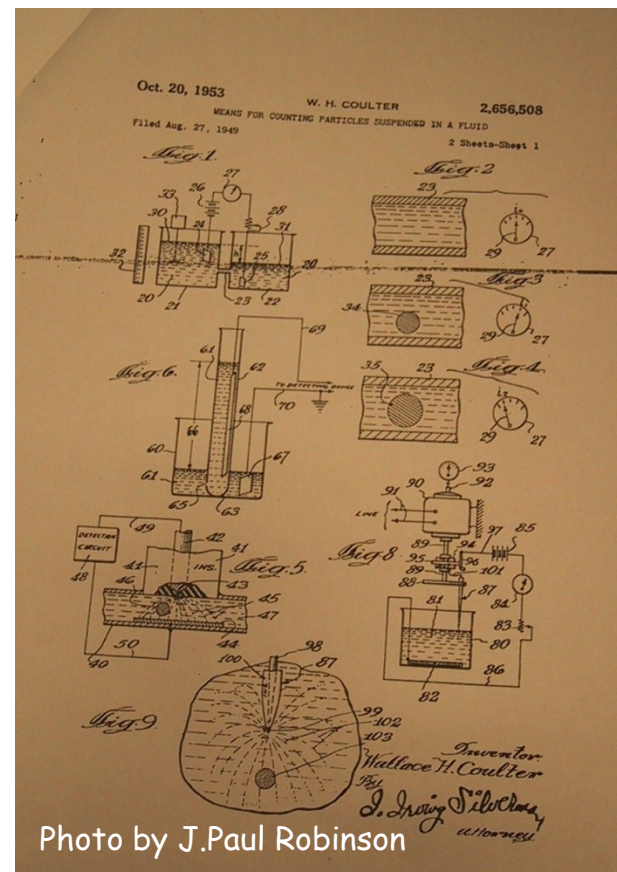

# Jak počítat buňky?

- ▶ Hemocytometer (Bürkerova komůrka) byla standardem pro počítání buněk do ~ 1950
- ▶ Rozměry jsou 3x3x0.1 mm. Obvykle jsou červené krvinky ( $1 \times 10^6/\text{mm}^3$ ) počítány po naředění 1:200
- ▶ Leukocyty ( $5 \times 10^3/\text{mm}^3$ ) jsou ředěny 1:10 v roztoku lyzujícím červené krvinky
- ▶ Statistická chyba:
  - ▶ koeficient variance (CV) je při 500 spočítaných buňkách 4.4%
  - ▶ chyba pipetování a ředění je ~ 10%

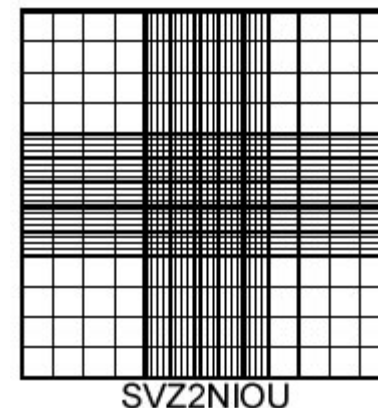
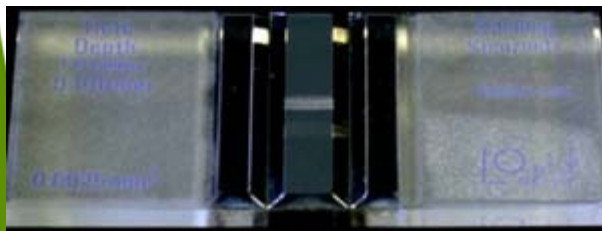

# Roche Innovatis Cedex



High Resolution Color Image

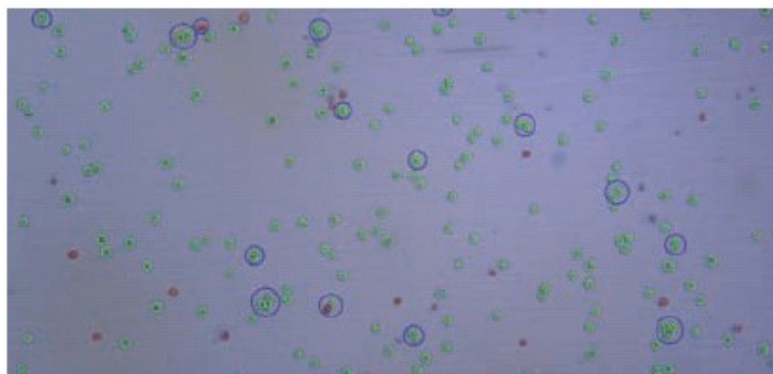

Visual Labeling



## Coulter Counter



První komerční verze CC

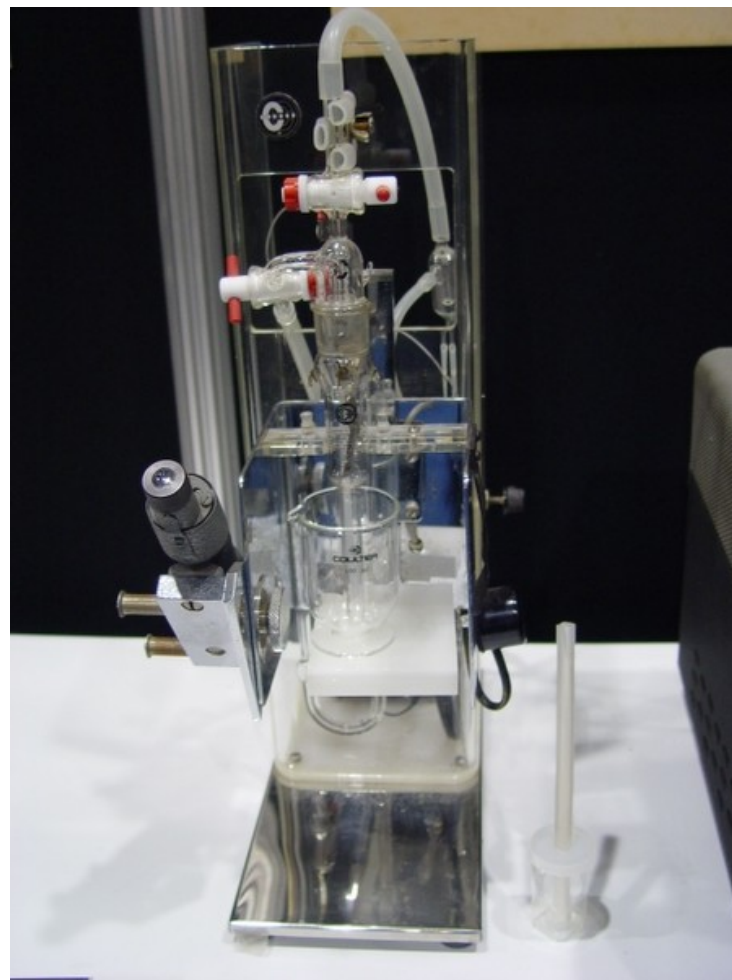



# Coulter Counter

1-2

FIG.1-1 FUNCTIONAL BLOCK DIAGRAM FOR MODEL ZF COUNTER

July '80

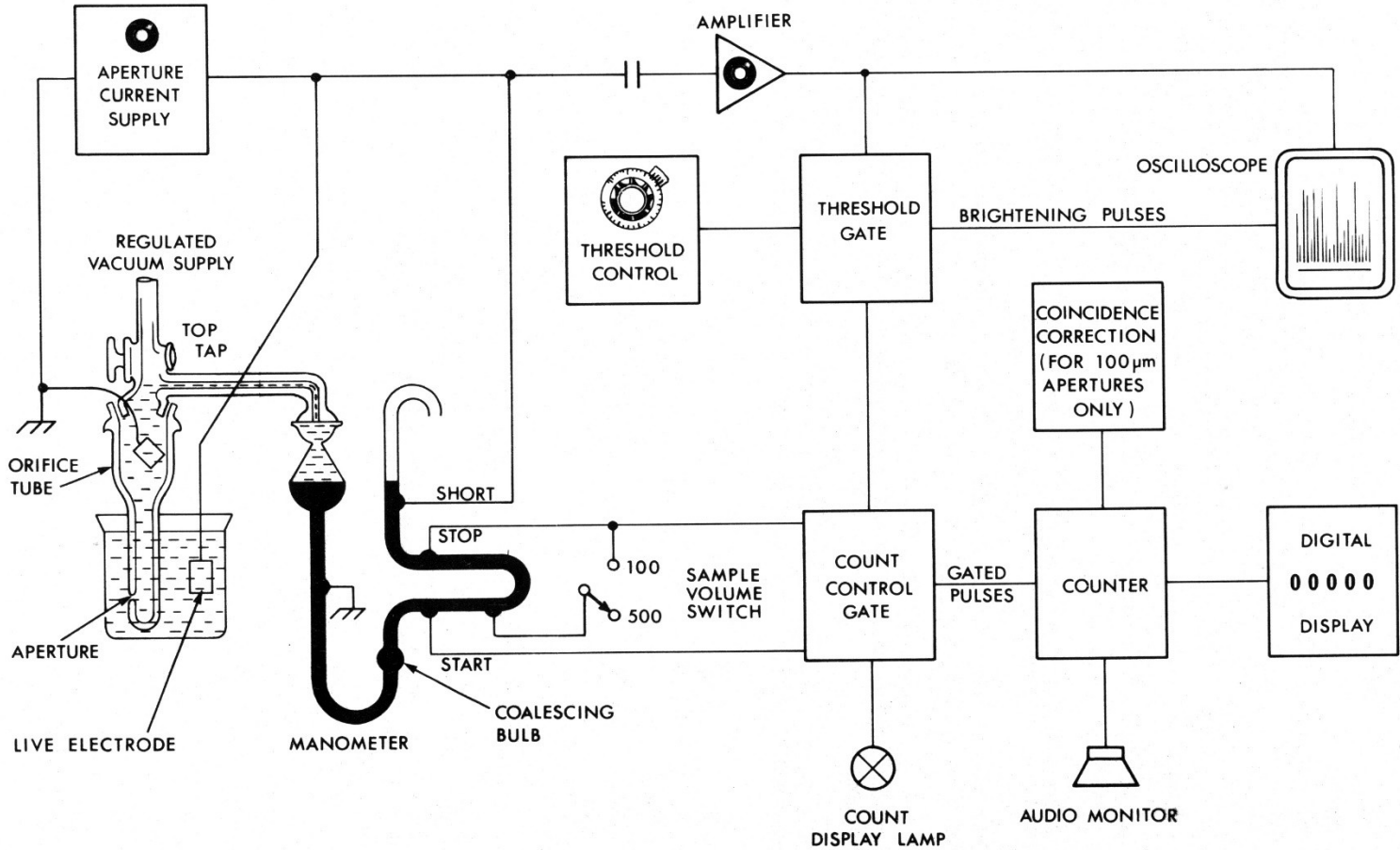



# Beckman Coulter

## ➤ Multisizer™ 3&4 COULTER COUNTER®

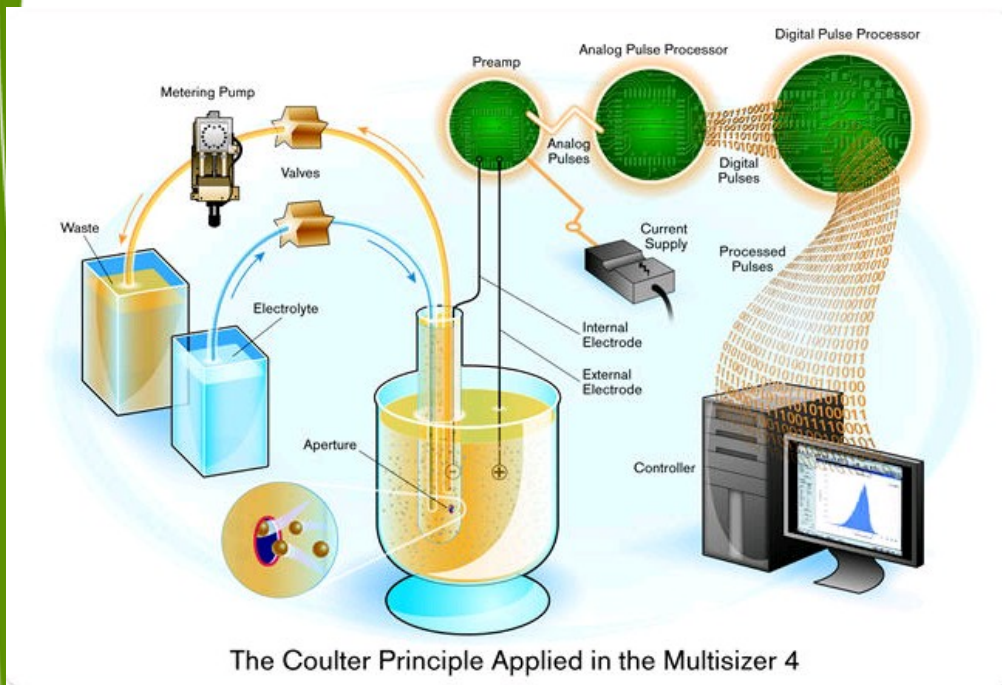

# Roche Innovatis CASY TT

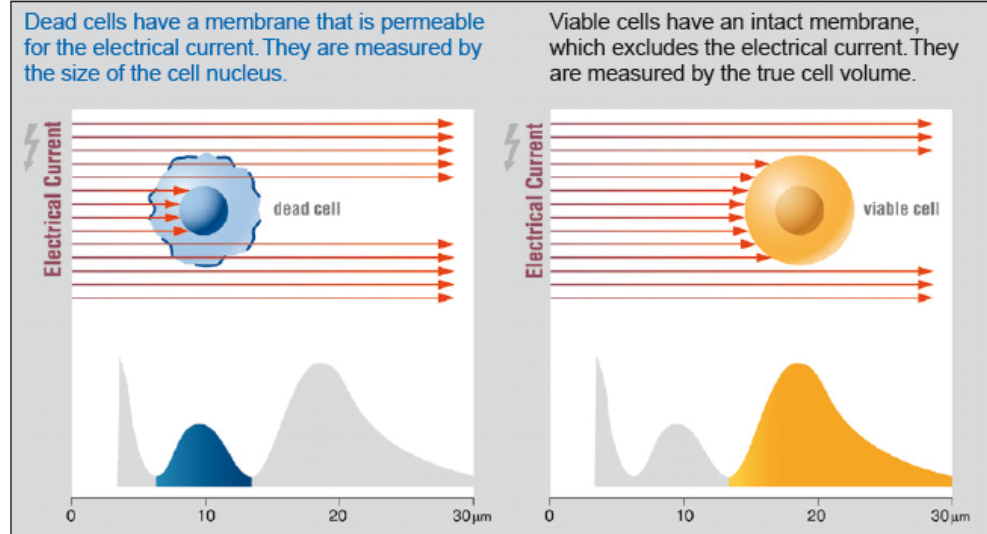

**Figure 1: Viability Measurement by Electrical Current Exclusion.** The status of the cell membrane distinctly affects the electrical signal generated when a cell is passing the measuring pore.





Cytograph. Stolní přístroj schopný měřit rozptyl světla **He-Ne laseru** (1970).

# Technické součásti

## ■ Detekční systémy

Fotonásobiče (Photomultiplier Tubes (PMTs))

dříve 1-2

nyní 4-8 (12-18)

Diody

detekce rozptylu světla (light scatters)

## ■ Zdroje světla

**Lasery** (350-363, 420, 457, 488, 514, 532, 600, 633 nm)

Argon ion, Krypton ion, HeNe, HeCd, Yag

**UV (Arc) Lampy**

Mercury, Mercury-Xenon

# Mack Fulwyler- sorter

**Mack Fulwyler - sorter 1965** - Los Alamos National Labs – jeho sorter separoval částice na základě elektronicky měřeného objemu (stejný princip jako Coulter counter) a separoval pomocí elektrostatického vychýlení.

Cílem bylo sortovat červené krvinky, protože u nich byla naměřena bimodální distribuce buněčného objemu. Princip separace byl založen na principu inkoustové tiskárny Richarda Sweeta ze Stanfordu (1965)

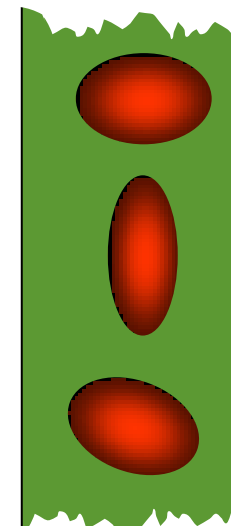
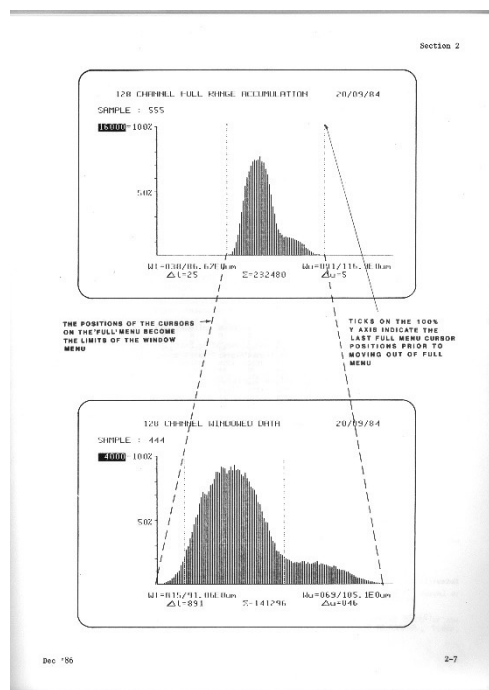

Po té co bylo objasněno, že bimodalita červených krvinek je artefakt byla tato skupina schopna separovat **neutrofilů a lymfocytů** z krve.



# Richard Sweet

Richard Sweet vyvinul elektrostatickou inkoustovou tiskárnu jejíž princip využil Mack Fulwyler pro svůj buněčný sorter.

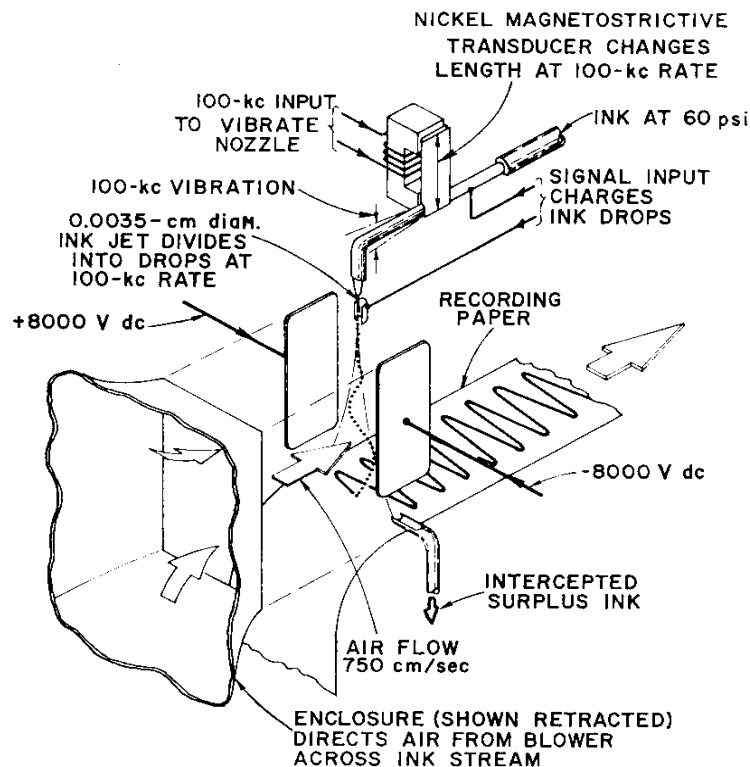

FIG. 1. Ink-jet oscillograph.

## THE REVIEW OF SCIENTIFIC INSTRUMENTS

VOLUME 36, NUMBER 2

FEBRUARY 1965

### High Frequency Recording with Electrostatically Deflected Ink Jets\*

RICHARD G. SWEET

*Systems Techniques Laboratory, Stanford Electronics Laboratories, Stanford University, Stanford, California*  
(Received 28 September 1964)

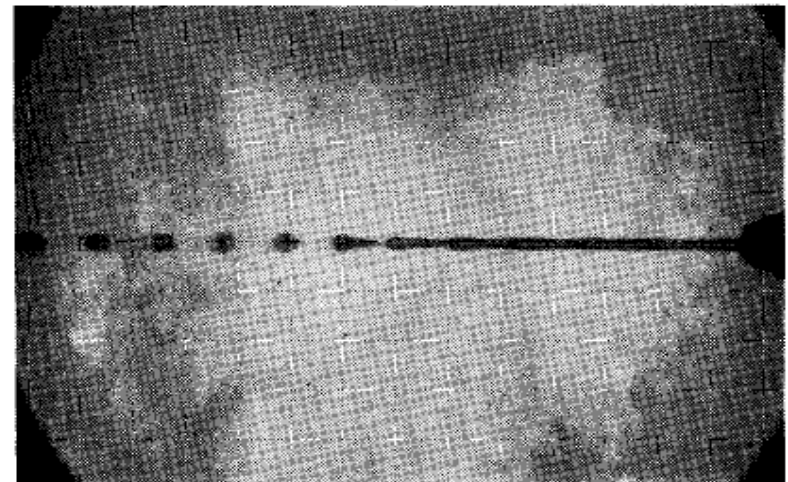
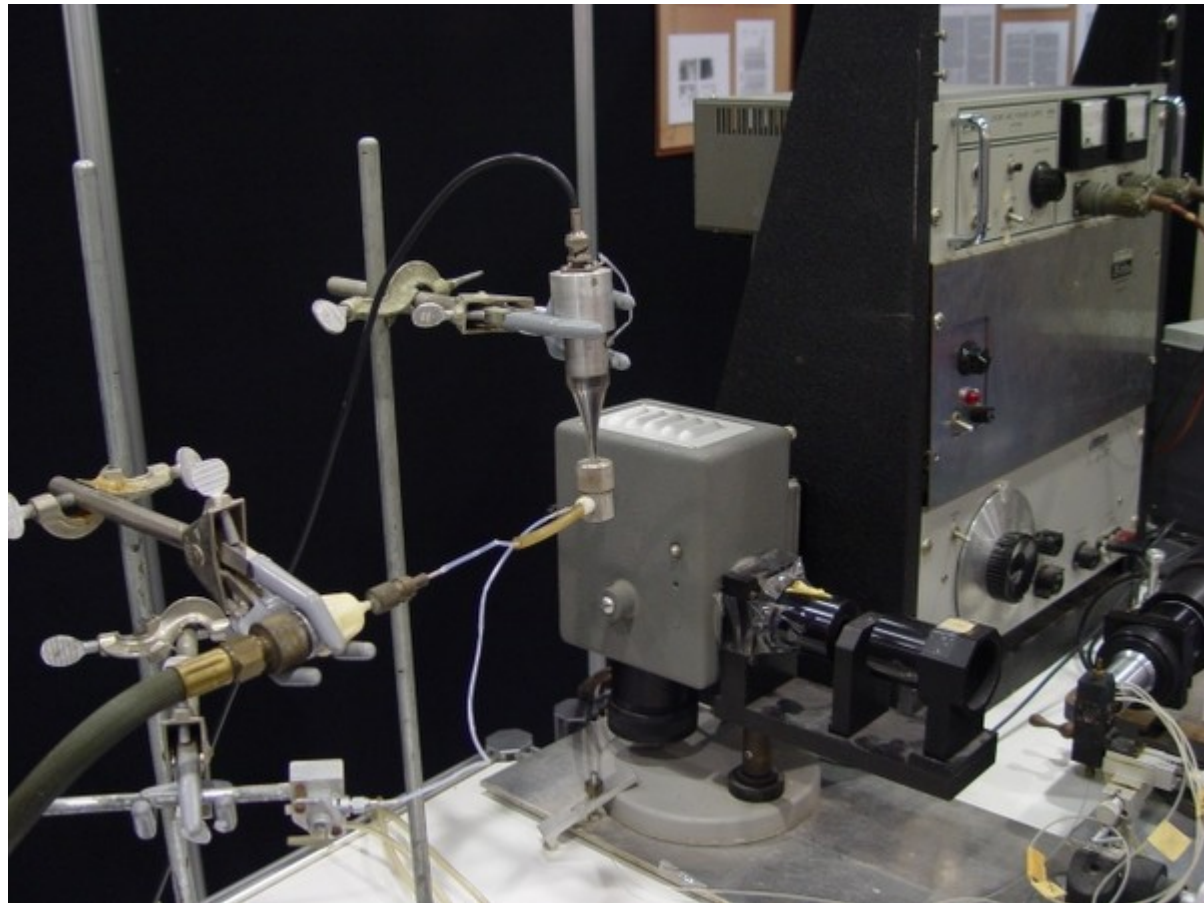

FIG. 3. Ink-drop formation.



## Mack Fulwyler- sorter



# Mack Fulwyler- sorter

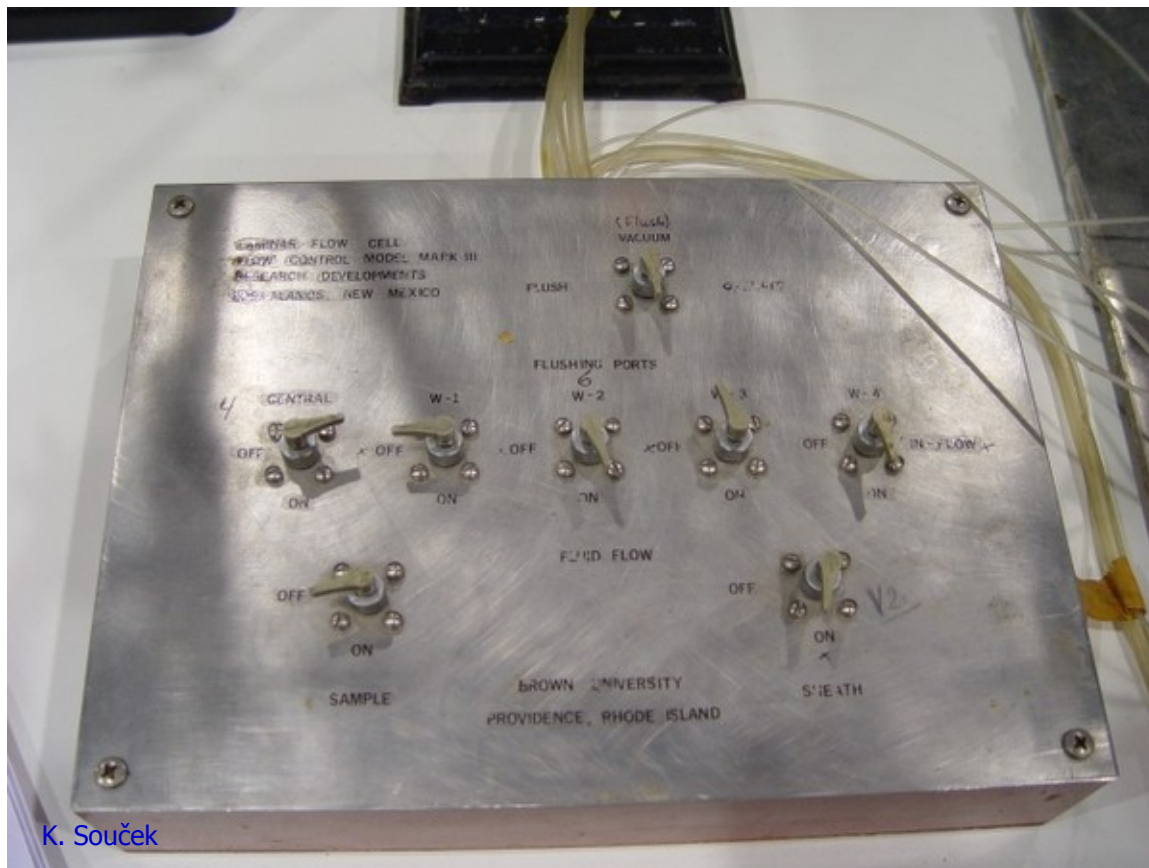

K. Souček

# Mack Fulwyler in His Own Words

J. Paul Robinson

Purdue University Cytometry Laboratories, Bindley Biosciences Center, Purdue University, West Lafayette, Indiana

Received 12 July 2005; Revision 15 July 2005; Accepted 15 July 2005

MACK FULWYLER IN HIS OWN WORDS

65

FIG. 1. The Fulwyler instrument as installed in Dr. Boris Rotman's Laboratory in Brown University, immediately prior to disassembly in March 2005. The instrument had not been altered or moved since installation in 1967, except for the addition of a laser instead of the UV lamp.

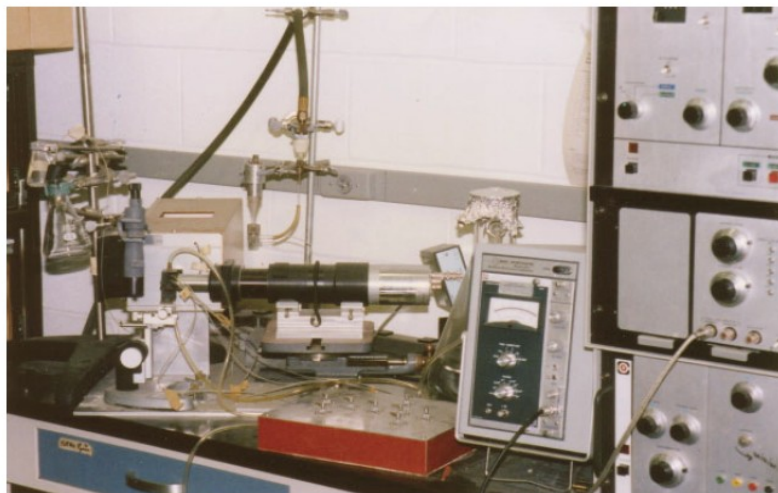

April 30, 1968

M. J. FULWYLER

3,380,584

PARTICLE SEPARATOR

Filed June 4, 1965

5 Sheets-Sheet 1

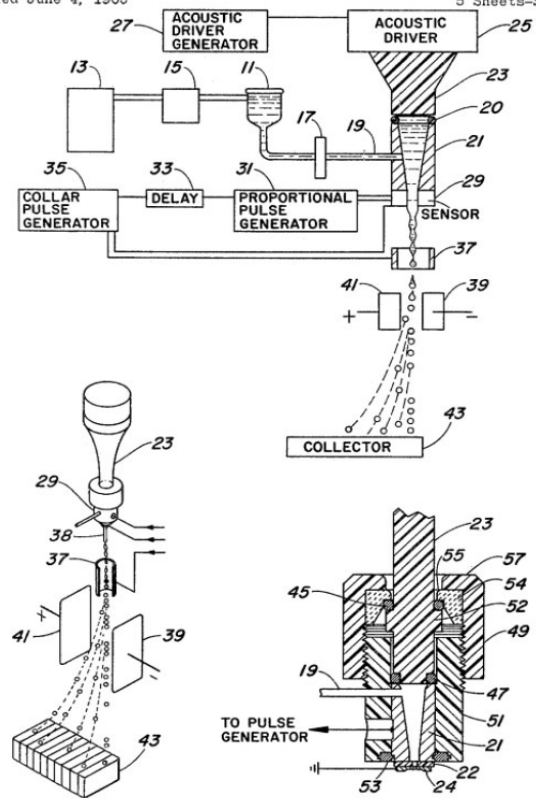

FIG. 4. A page from Fulwyler's patent on the cell separation technology patent #3,380,584 showing the fundamental components of the invention of the cell sorter.

INVENTOR.  
Mack J. Fulwyler  
BY  
*Richard A. Robinson*  
Attorney



# K čemu to všechno je... například...

ASLO

Association for the  
Sciences of Limnology  
and Oceanography



Home Members Libraries Publications Meetings Employment Activities Search

## Position Announcements

### Flow Cytometer Research Technician

Flow Cytometer - Research Technician

The Ocean Biogeochemistry Laboratory at Bigelow Laboratory of Ocean Sciences is seeking an energetic and motivated technician to join our research group. The primary responsibility of the successful candidate will be operation of our high-speed flow cytometer/ cell sorter in support of our oceanographic research. This technical position requires extensive knowledge of cytometric principles, an ability to troubleshoot and maintain analytical instrumentation, prior experience in method development, a willingness and capability of going to sea to operate the flow cytometer (cruises from 1 to several weeks), and a high degree of self-confidence and independence. A wide diversity of sample types are analyzed ranging from enumerating and sorting single cells from oceanic samples to quantification of cellular rate processes employing fluorogenic assays to combining isotopic methods with flow sorting.

The successful applicant must have at least a B.Sc. degree and 2+ years of demonstrated experience with flow cytometric cell sorters as a primary operator. The successful applicant must also be highly organized, have a strong ability to multi-task, be self-confident and independent. This position will initially be for one year with continuation for additional years based upon successful job performance.

Send CV, cover letter, and contact information for 3 references to [jobs@bigelow.org](mailto:jobs@bigelow.org). Please reference (RT-2012-4) in the subject line. Review of applicants will begin immediately and continue as applications are received until the position is filled. The preferred starting date is no later than 1 January 2013, but this may be negotiated. Salary will be commensurate with prior experience. Bigelow Laboratory is an Equal Opportunity Employer.

## Submission Forms

[Submit Job Announcements](#)

[Submit Student Opportunities](#)

## Employment and Student Opportunities

[Positions Offered](#)

[Student Opportunities](#)

[Job-Related Links](#)

## Career Information

[Aquatic Science Careers](#)

[Careers in Public Policy](#)

[Early Career Scientists](#)

## Programs and Opportunities

[Programs for Recent PhDs](#)

## Position Available

### FLOW CYTOMETRY TECHNICIAN

#### Oceanography, MIT

The Chisholm Laboratory at MIT (<http://web.mit.edu/chisholm/www/>) is seeking a full-time flow cytometry technician to participate in research involving oceanic cyanobacteria. The position requires a Bachelors degree in science or engineering and two years experience. Applicants must have a solid background in and experience with flow cytometry, including extensive knowledge of hardware, data analysis, and experimentation. Duties include maintenance of flow cytometry instruments, experimentation, and assisting other lab members with flow cytometry as needed. Must be able to work as a member of a multidisciplinary team. Opportunities for graduate study

Please send a resume and 3 letters of recommendation to Dr. Marcia Osburne ([mosburne@mit.edu](mailto:mosburne@mit.edu)), or Dr. Marcia Osburne, MIT, 15 Vassar St. rm 48-336B, Cambridge, MA 02139

## Moss Landing Marine Laboratories



Home About Us Academics Faculty Research Affiliates Marine Operations Public

## ABOUT US

- [About Us](#)
- [Contact Information](#)
- [Map & Directions](#)

## ANNOUNCEMENTS

- [Employment Opportunities](#)
- [Events](#)
- [News](#)
- [Seminars](#)

### 4/9/12 - Job Opportunity: Biological Oceanography Technician

Date: April 9, 2012 - 8:00am  
Biological Oceanography - Job Opportunity

The Biological Oceanography Lab is seeking assistance (half-time or more) on Dr. Welschmeyer's ballast treatment testing project associated with the California Maritime Academy (CMA). The duties will include training/execution

many routine chemical and biological oceanographic analyses (e.g., DOC/POC, chlorophyll a, live organism microscopy, epifluorescence microscopy, flow cytometry, bacteria culturing assays, etc.). The employee will travel often between MLML and CMA.

Requirements: the employee must be available for two consecutive 48 hour periods (or more) each week; full time work is ideal. (Student schedules with M-W or T-Th classes will not work). A willingness to work long hours (odd hours) is mandatory; excellent pipeting skills, notetaking, and spreadsheet skills would be appreciated (state drivers license is helpful). Pay is \$20/h immediately; work will proceed through summer with possible sampling trips to southern California and South America.

Please contact Dr. Nick Welschmeyer by email ([Welschmeyer@mml.calstate.edu](mailto:Welschmeyer@mml.calstate.edu)) for information.



# K čemu to všechno je... například...

- 43 miliónů lidí na světě je infikováno virem HIV (WHO)
- ročně zemře ~ 2 miliónu lidí na HIV/AIDS (v Africe je ~ 11 miliónu AIDS sirotků)
- kvantifikace CD4 T lymfocytů je klíčový parametr při monitorování léčby
- Průtoková cytometrie je „zlatý standard“
- Optimalizované postupy a zařízení pro levné (< 3 EUR / vzorek) a rychlé detekce (250 vzorků / den)
- **Avdoğan Ozcan**: „Kill the cost. save live“

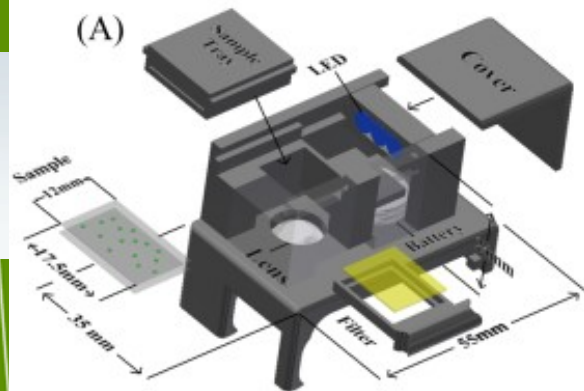

(B)

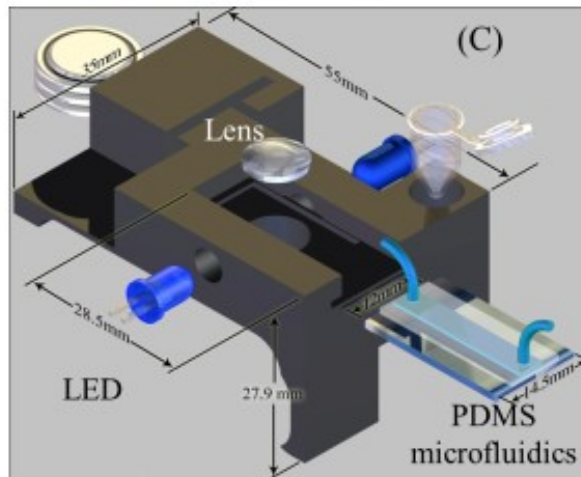

(D)

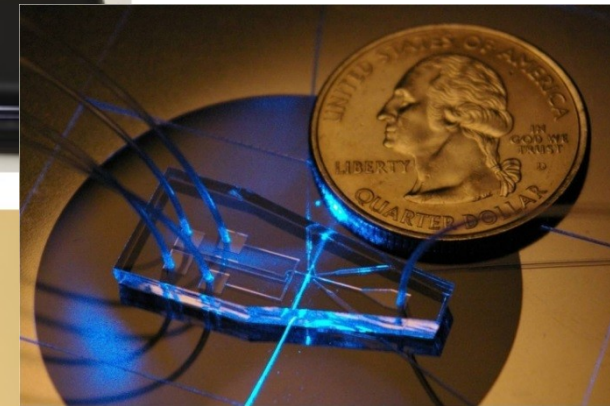
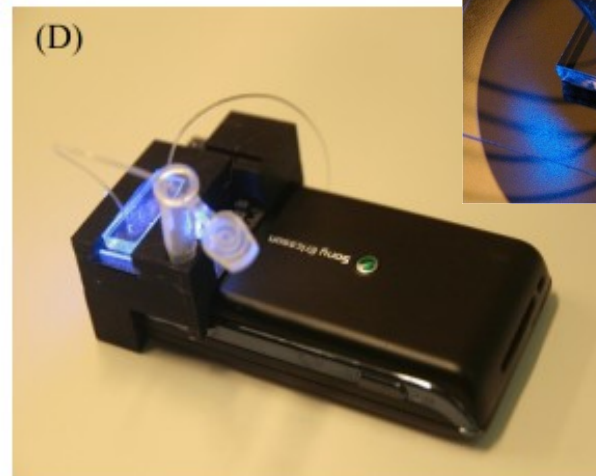



## fluidics

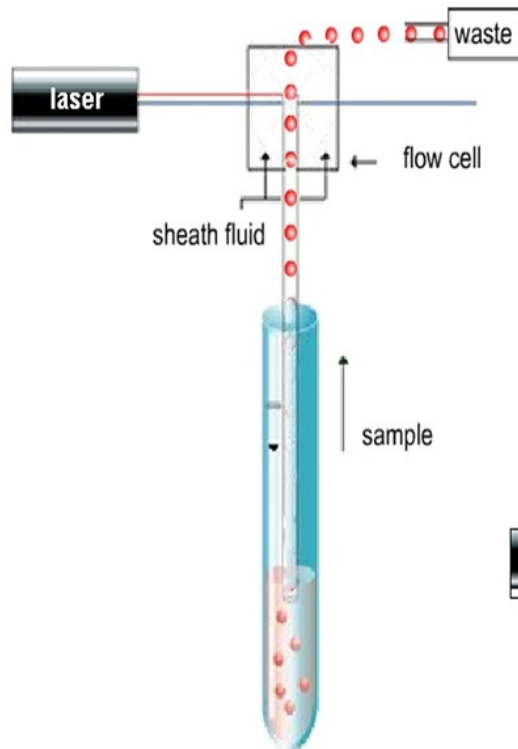

## optics

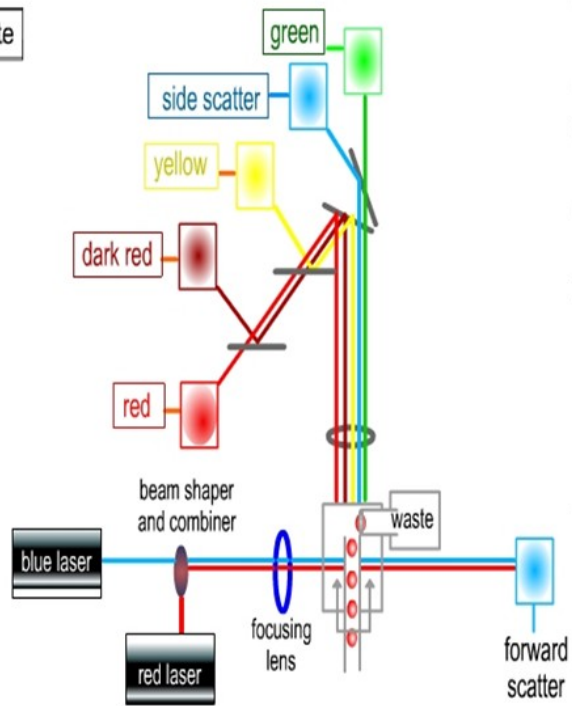

## electronics

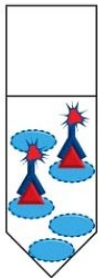
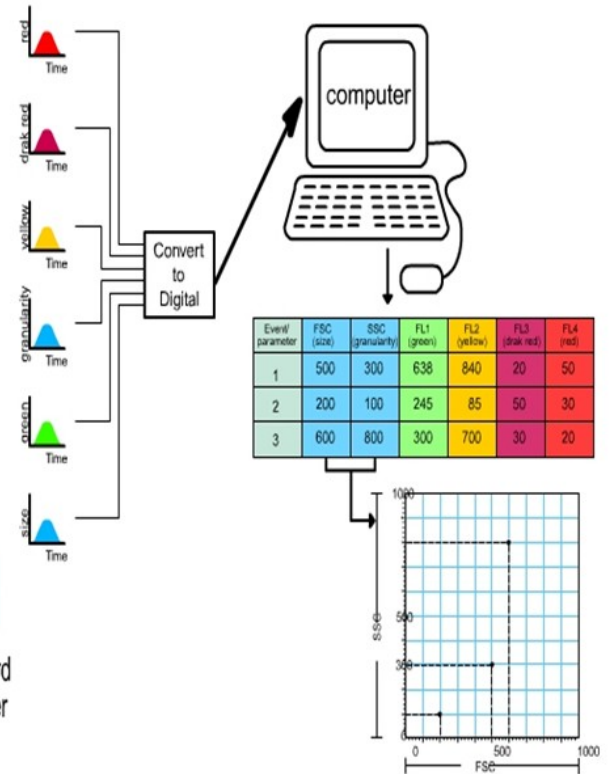

**Key**

- Cell
- Antigen
- Fluorochrome conjugated Primary antibody

# Fluidika - Laminární vs. turbulentní proudění

- **Turbulentní** proudění je charakteristické chaotickými (stochastickými) změnami
- **Laminární** proudění – kapalina proudí v paralelních vrstvách které se vzájemně nemísí



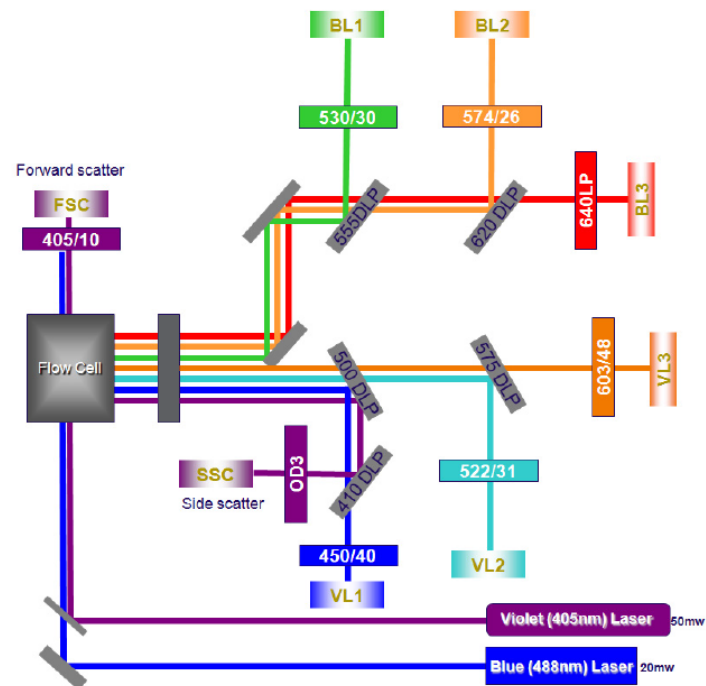
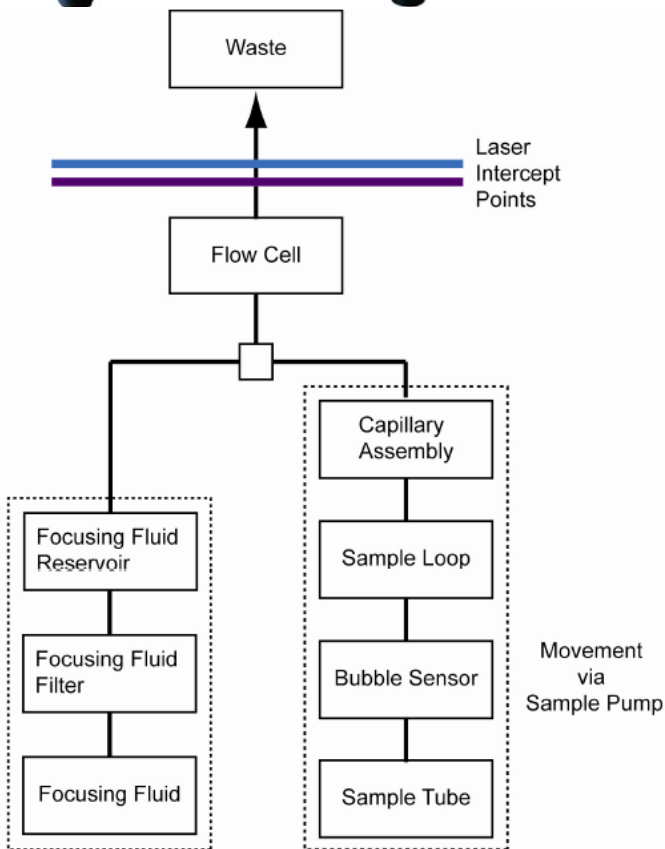

## Způsoby pro zobrazení dat

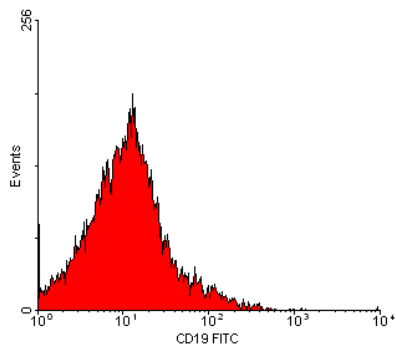

4Color TBNK + TruCO2.01

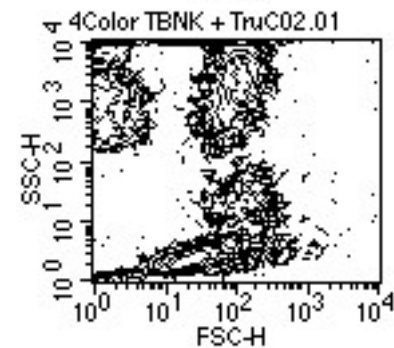
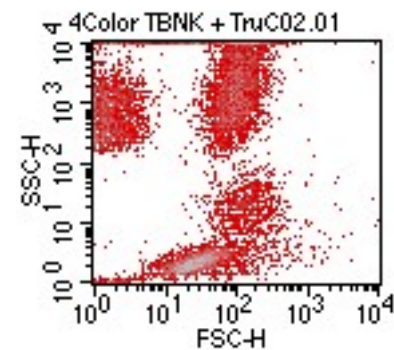
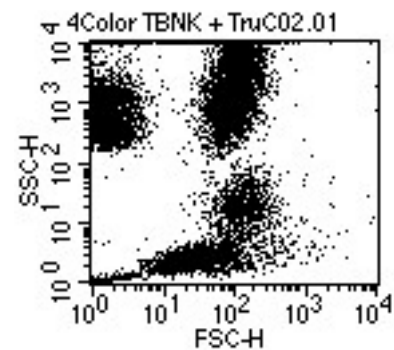
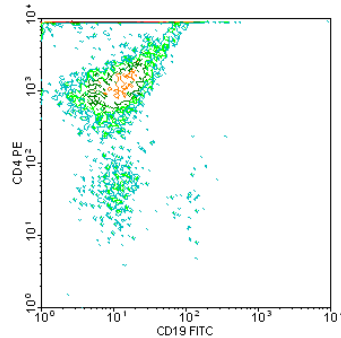
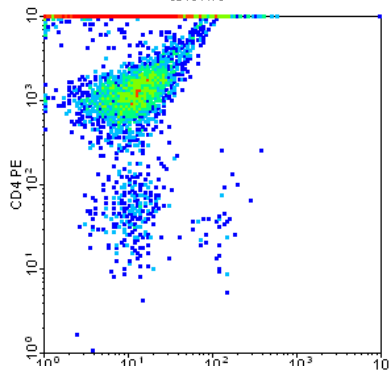
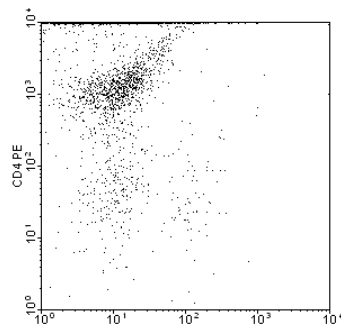
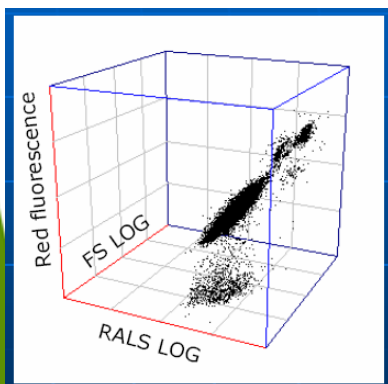



# Vícebarevné analýzy generují mnoho dat...

STATISTIKA

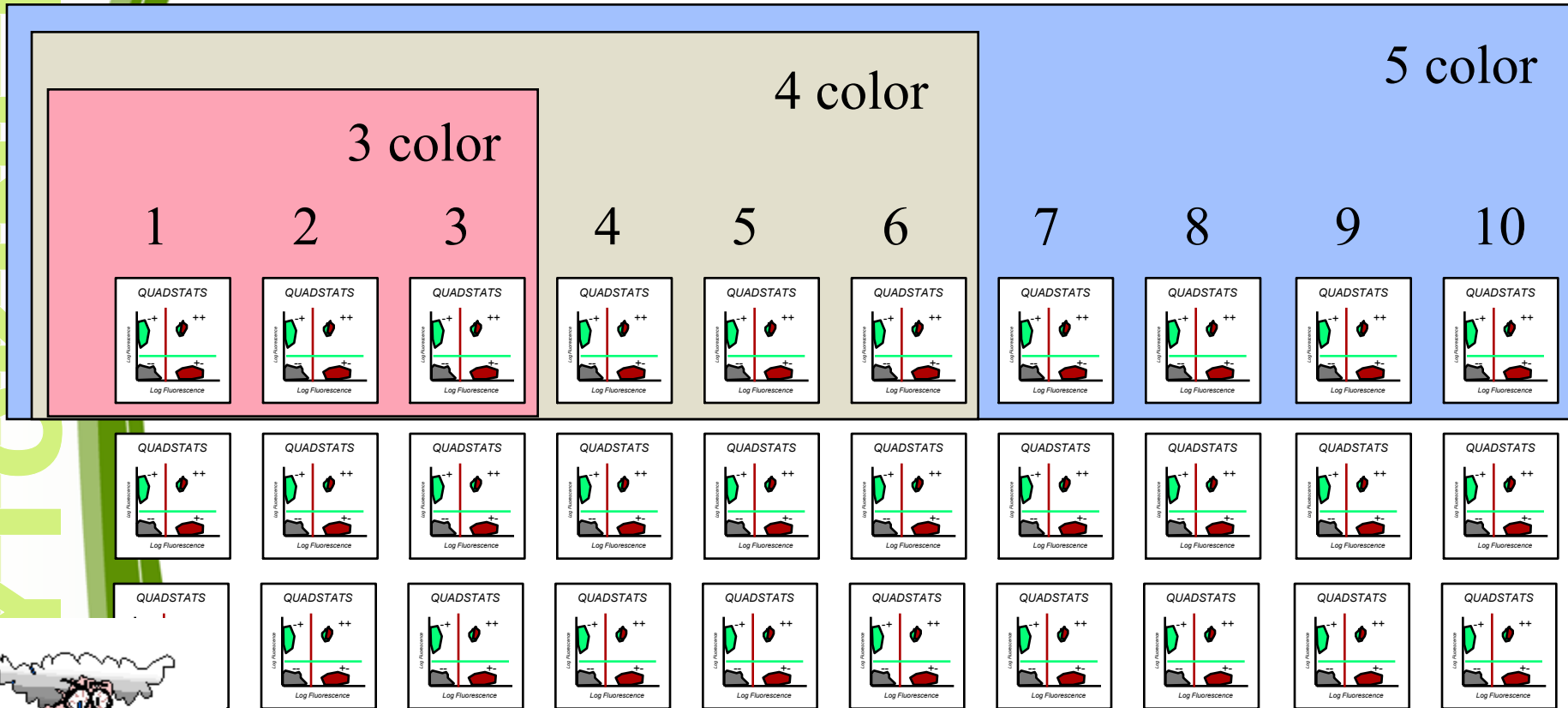



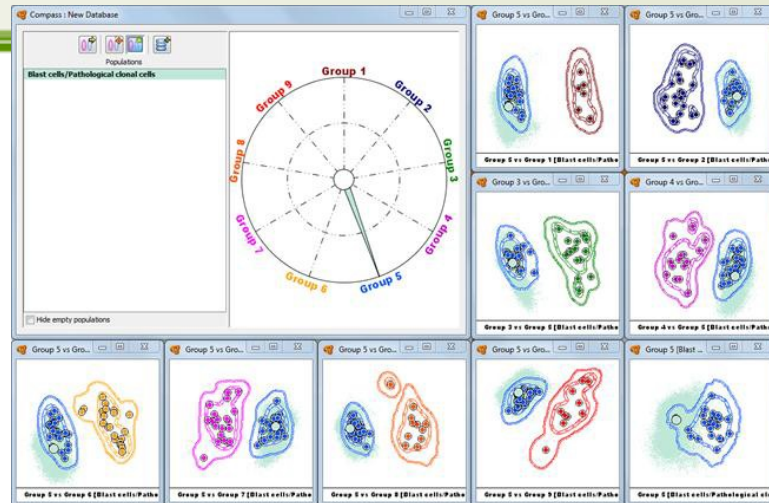
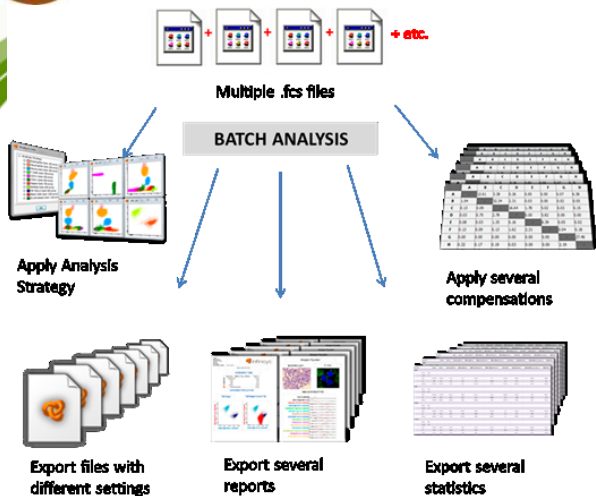

### Automatic Population Separator

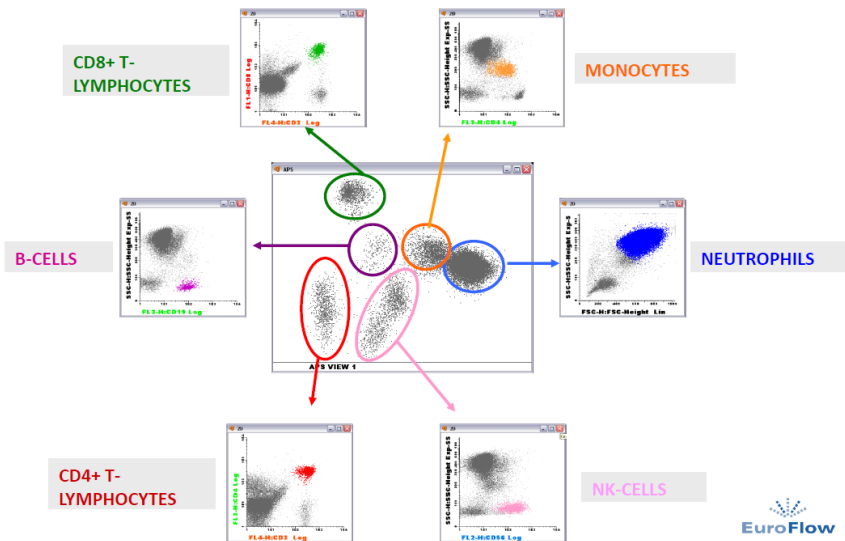

# Analyze: Cytobank

Plot raw data

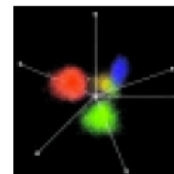
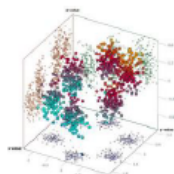
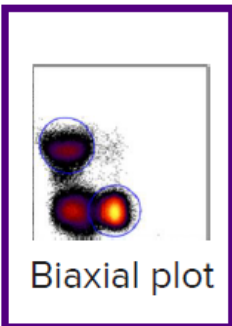
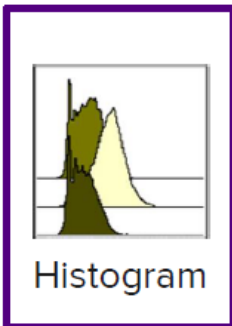

Reduce dimensionality

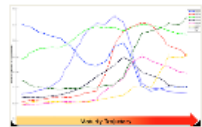
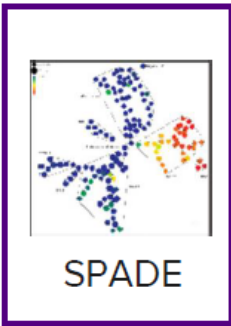
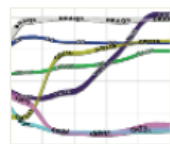
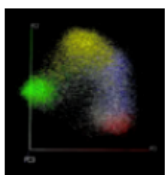

Summarize statistics

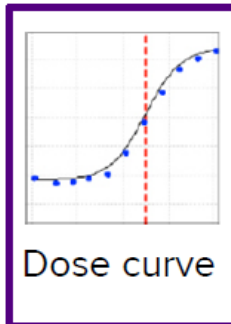
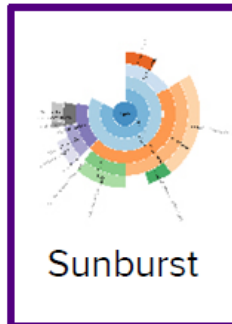
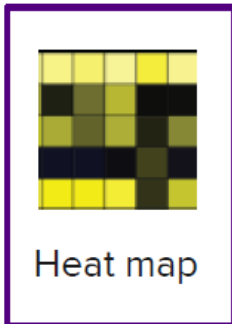
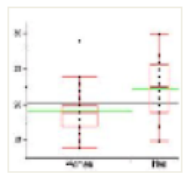

FLUIDIGM®

Cell tracking and proliferation

# CYTOKINETIKA

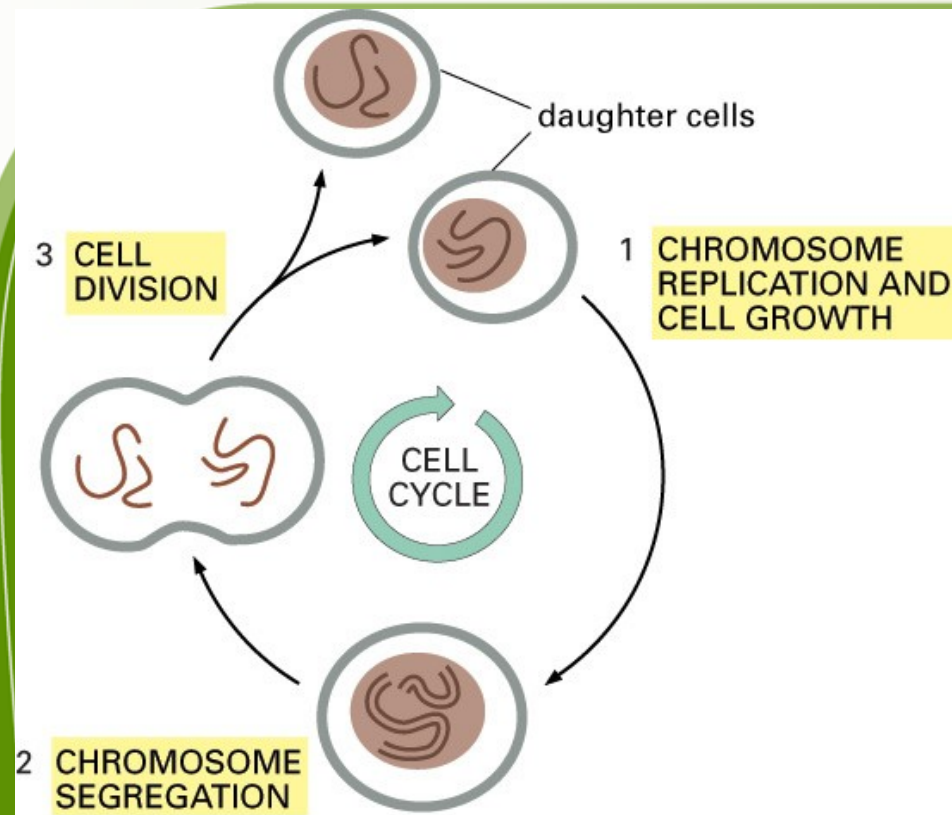
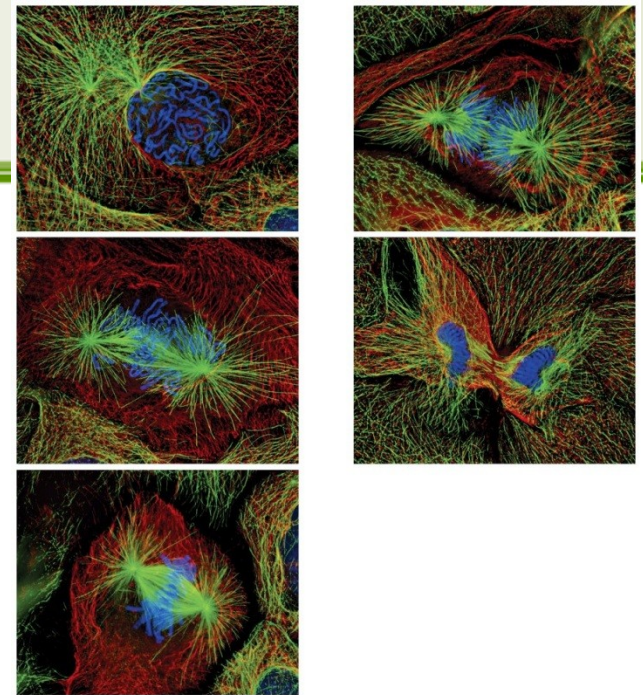
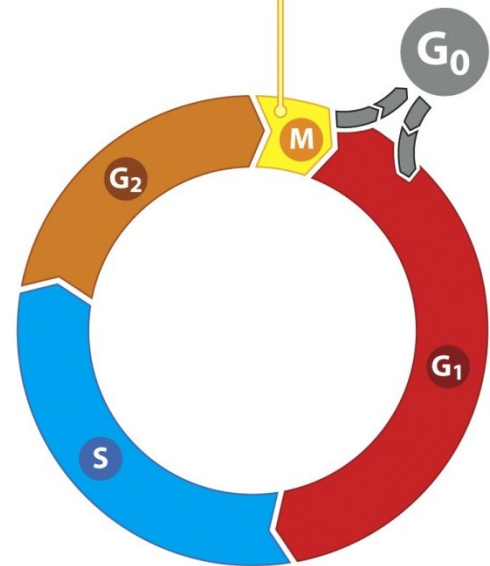

Figure 17-1. Molecular Biology of the Cell, 4th Edition.



prophase, metaphase, anaphase, telophase



# Approaches

- Cell cycle analysis
- DNA synthesis analysis
- Cell tracking



# Buněčný cyklus

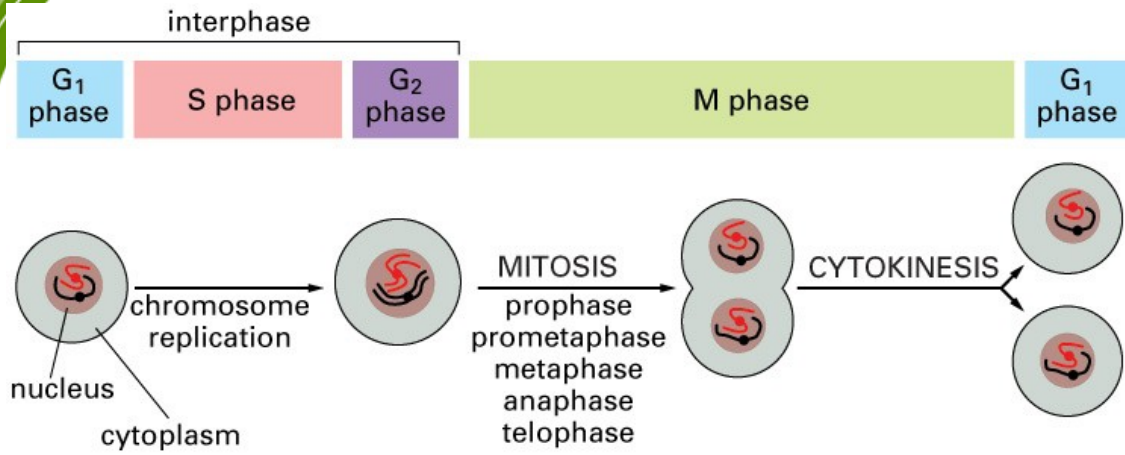

Figure 18-1. Molecular Biology of the Cell, 4th Edition.

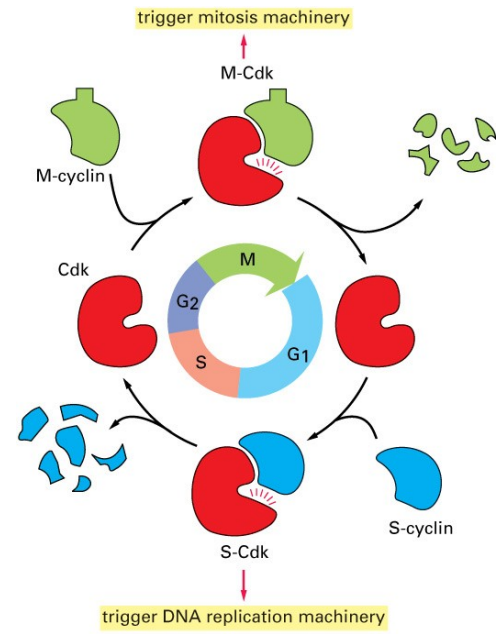
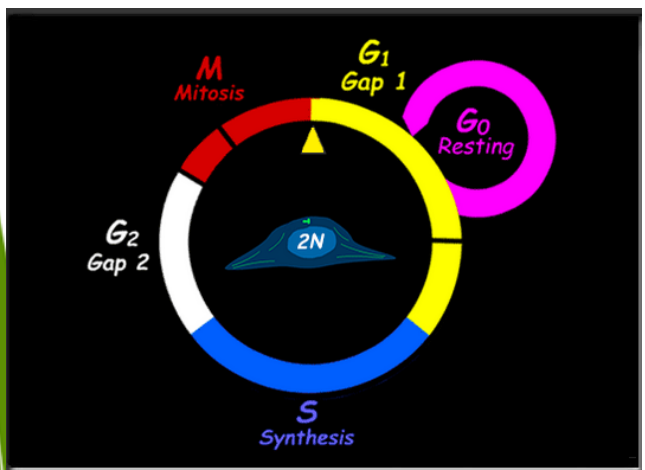

Figure 17-16. Molecular Biology of the Cell, 4th Edition.

oocyte grows without dividing (months)

FERTILIZATION

fertilized egg divides without growing (hours)

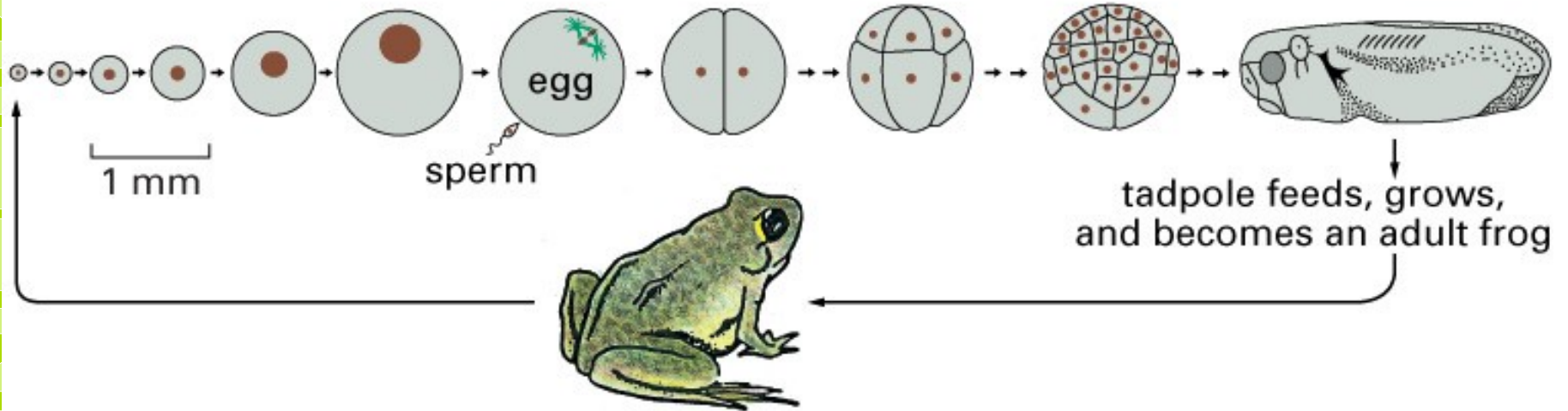
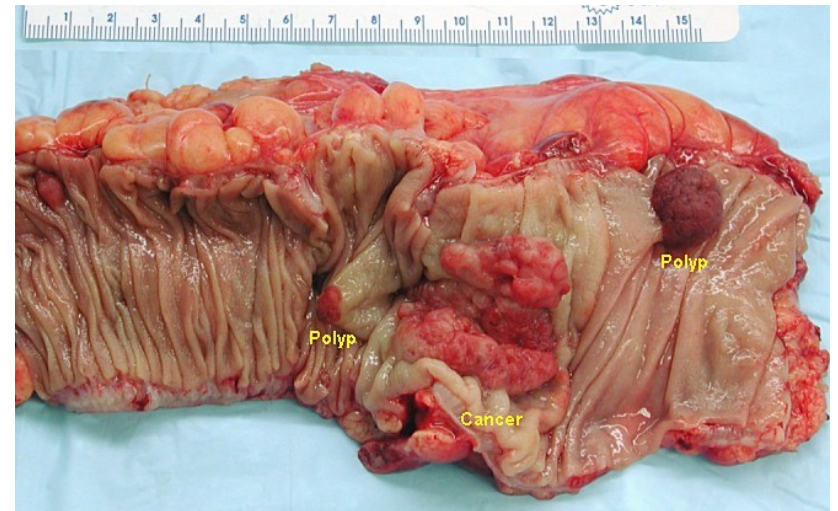

Figure 17-8. Molecular Biology of the Cell, 4th Edition.



# Cell cycle analysis

- One of the oldest applications of flow cytometry, analysis of the cells in cell cycle phases based on the quantification of DNA
- flow cytometry is a convenient method for quick and relatively precise determination of cell cycle
- DNA is simply labeled using fluorescent dyes specific for DNA
  - Propidium iodide
  - 4',6-diamidino-2-phenylindole (DAPI)
    - fluorescence increases after binding to DNA. Membranes have to be permeabilized.
  - Hoechst 33342
  - Vybrant® DyeCycle™
  - DRAQ5
  - Quaternary benzo[c]phenanthridine alkaloids (QBAs)
    - I. Slaninová, J. Slanina and E. Taborská, "Quaternary benzo[c]phenanthridine alkaloids--novel cell permeant and red fluorescing DNA probes," *Cytometry A*, vol. 71, no. 9, pp. 700-708, 2007.
    - labeling of live cells (possible cytotoxicity)

# Normal Cell Cycle

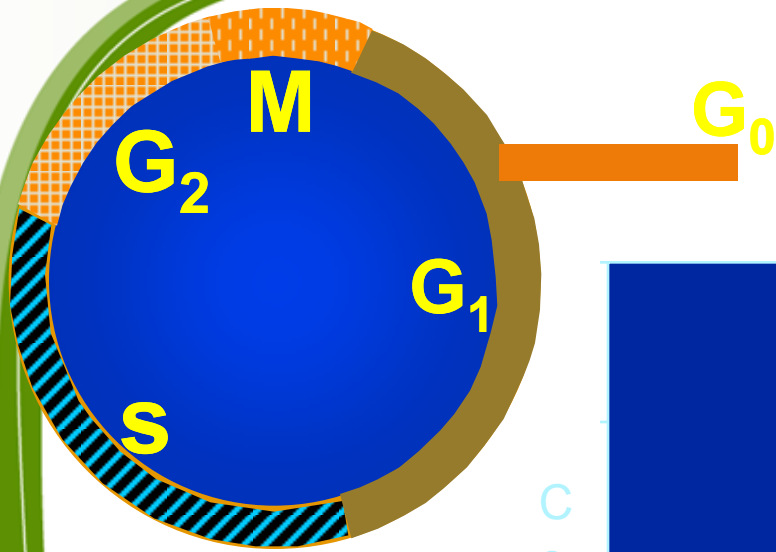

## DNA Analysis

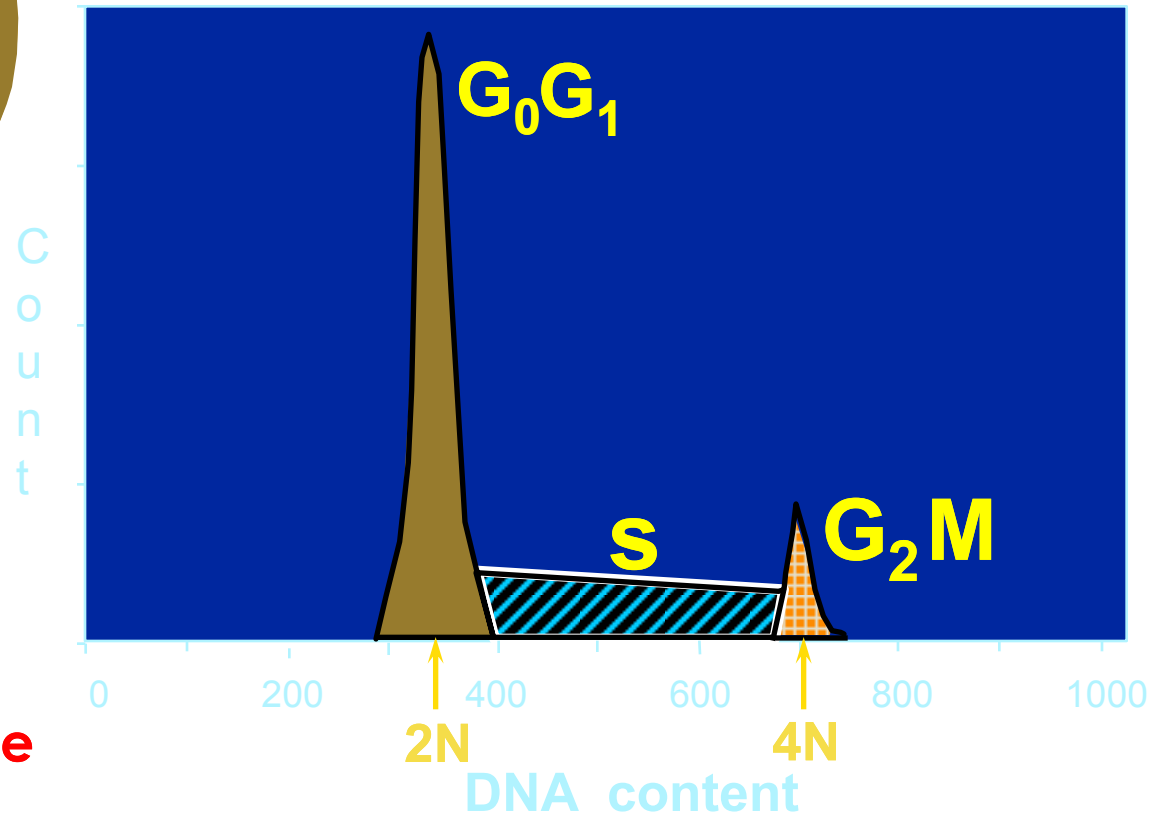

- propidium iodide
- DAPI
- Hoechst 33342
- 7-AAD

# Cell cycle histogram: how to analyze?

- **It is not recommended** to statistically analyze it using simple gating in the histogram
- **It is necessary** to use software tools for modeling of distribution of cell cycle phases

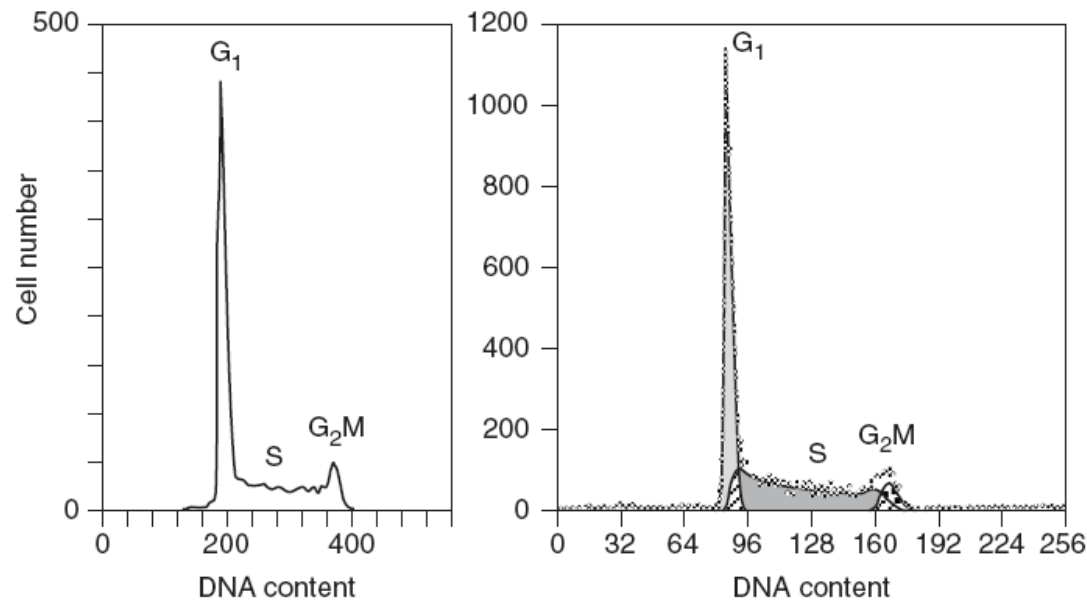



## ModFit LT™

An impressive new version of the industry standard.

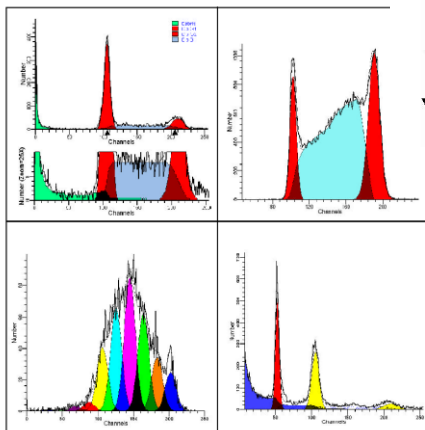

# PHOENIX FLOW SYSTEMS

## MultiCycle for Windows

Advanced DNA Cell Cycle Analysis Program

MultiCycle AV fits 6 different cell cycle models automatically. The variability in results is one aid to assessing confidence in S and G2 phase estimates. Display of statistics is optional.

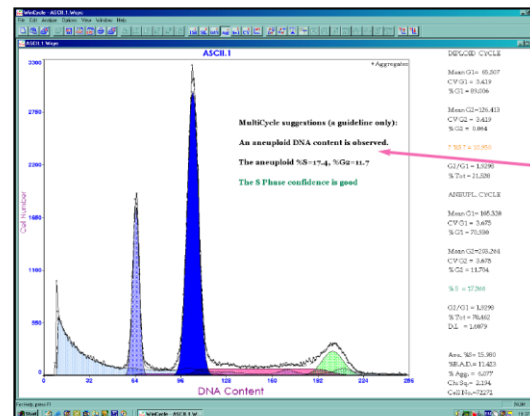

A summary interpretation clearly states results. A built-in decision tree helps take the guesswork out of evaluating the quality of the cell cycle analysis.

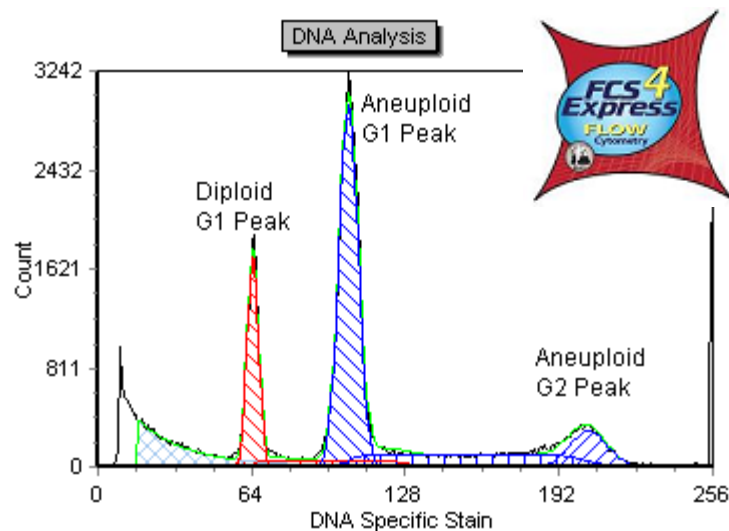
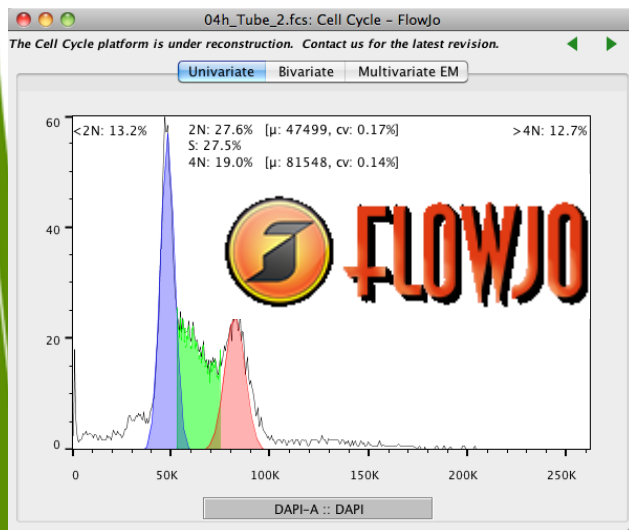

## Analysis of synchronized cells

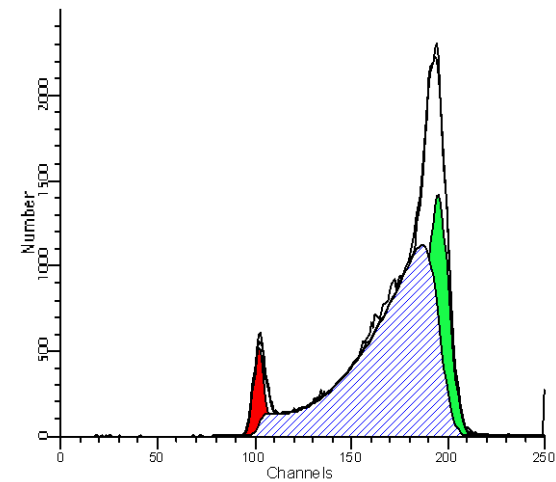
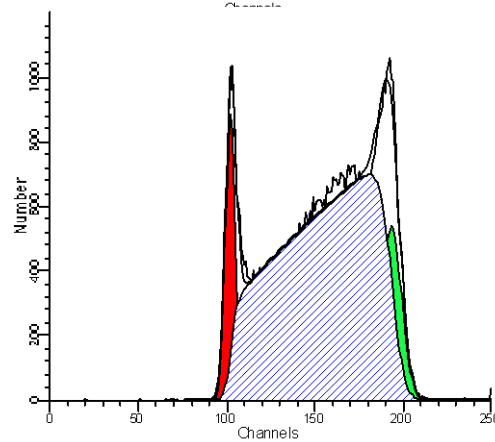
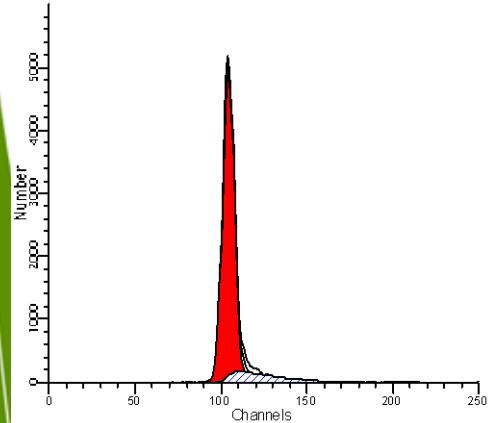
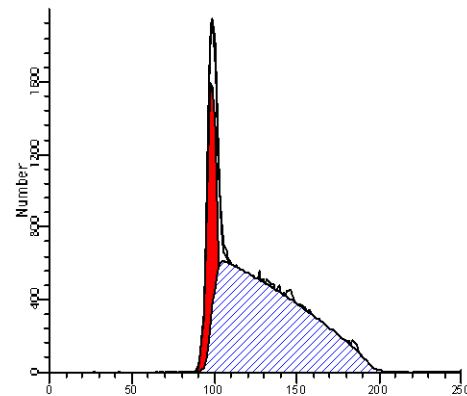
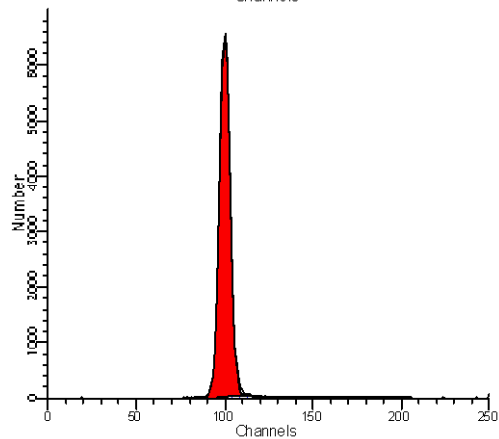
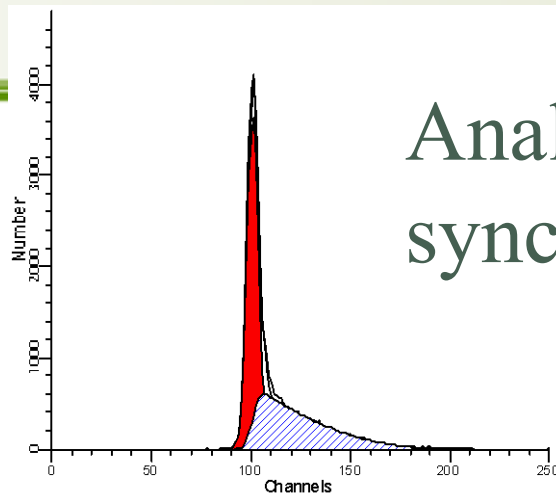
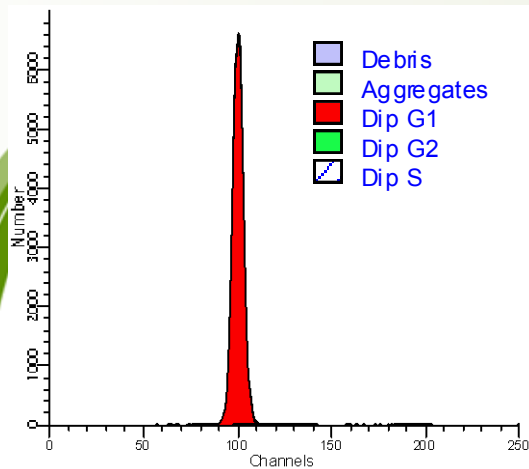

# Analysis of BrdU incorporation

- Bromodeoxyuridin (BrdU) is incorporated into DNA instead of thymidine during S-phase
- BrdU is detected using specific antibody after the fixation and partial denaturation of DNA (acid, DNase)
- DNA can be stained in the last step

# Analysis of BrdU incorporation

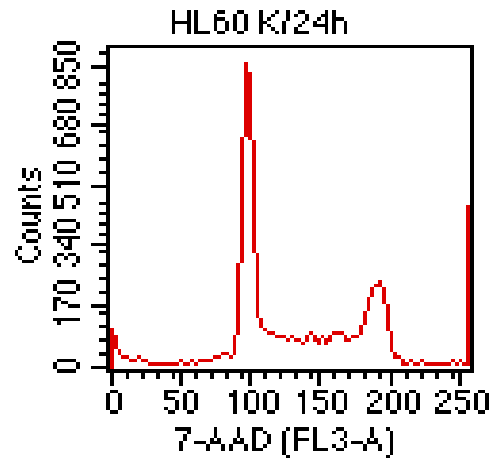
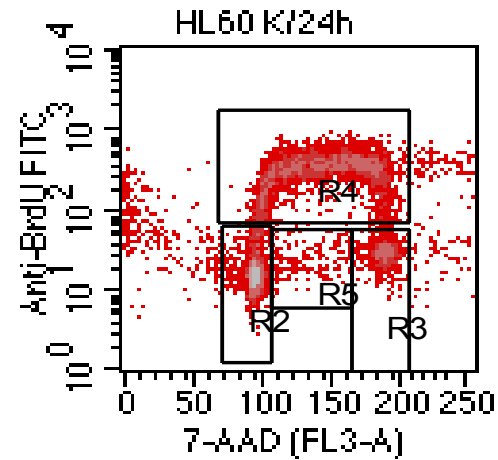
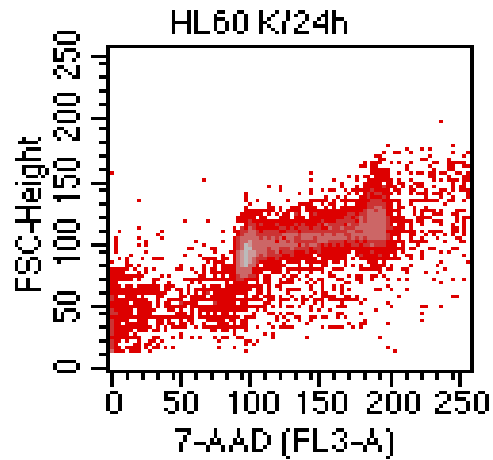

File: HL60 K/24h

Region	% Gated
R1	100.00
R2	35.48
R3	10.25
R4	47.87
R5	1.32

# Click azide/alkyne reaction



Metabolically or enzymatically  
azide-modified protein

Cu(I), 1 hour  
Room temperature

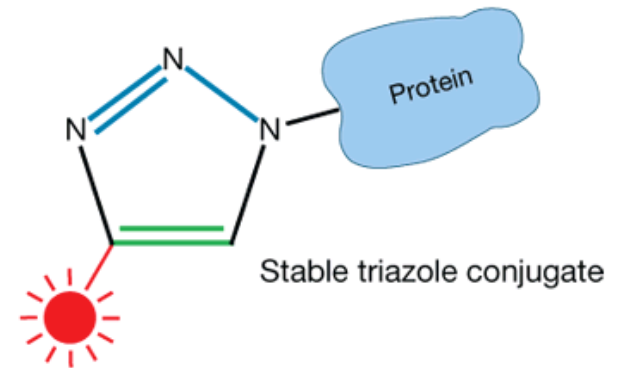

TAMRA, Dapoxyl®, or biotin alkyne

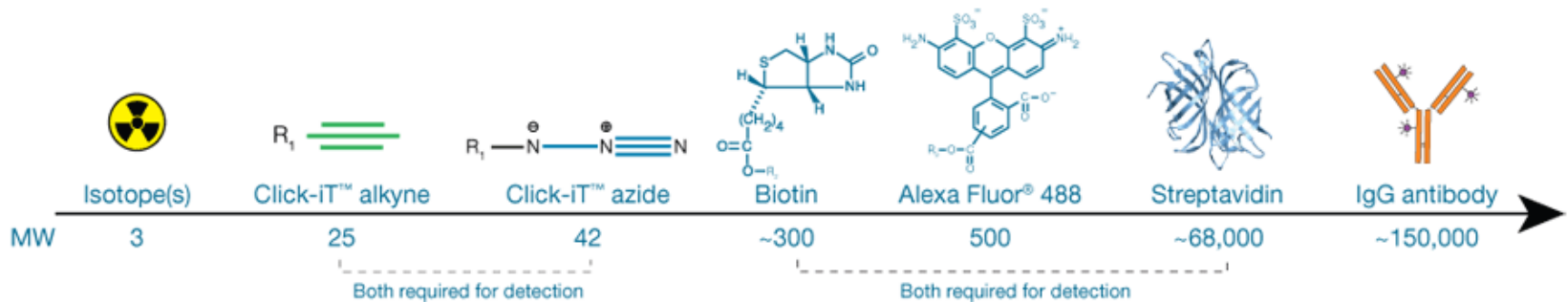

CYTOKINETIKA



## Click-IT (Invitrogen) applications

# analysis of DNA synthesis (EdU - 5-Ethynyl-2'-deoxyuridine)

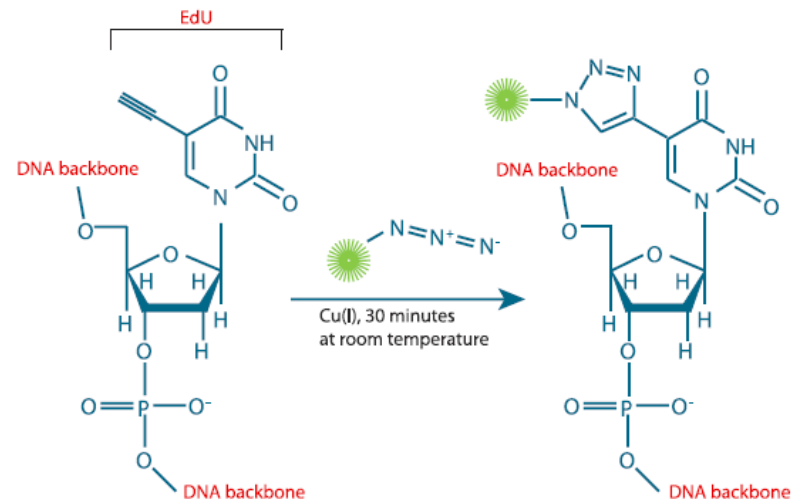

 Fluorescent dye or hapten

$^3\text{H}$ -thymidine

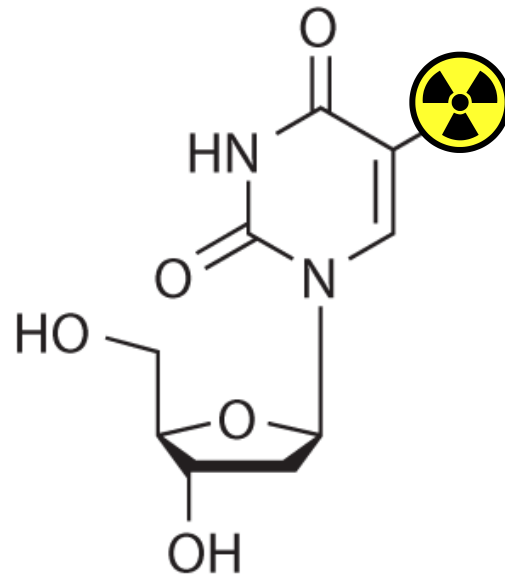

Tritiated ( $^3\text{H}$ ) thymidine



## $^3\text{H}$ -thymidine

- Original method for measuring cell proliferation
- Radioactive
- Not compatible for multiplexed analyses



BrdU

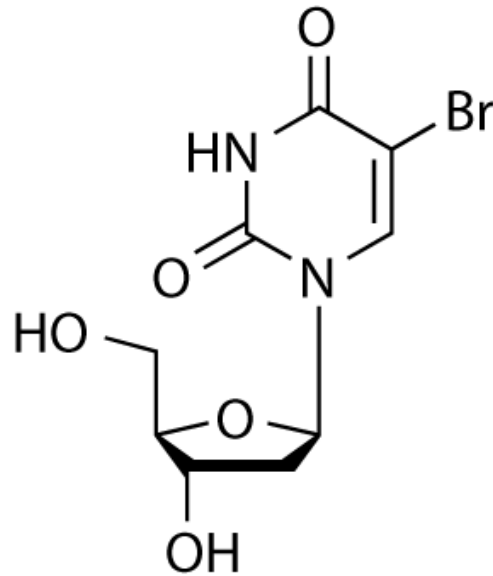

**BrdU (5-bromo-2'-deoxyuridine)**

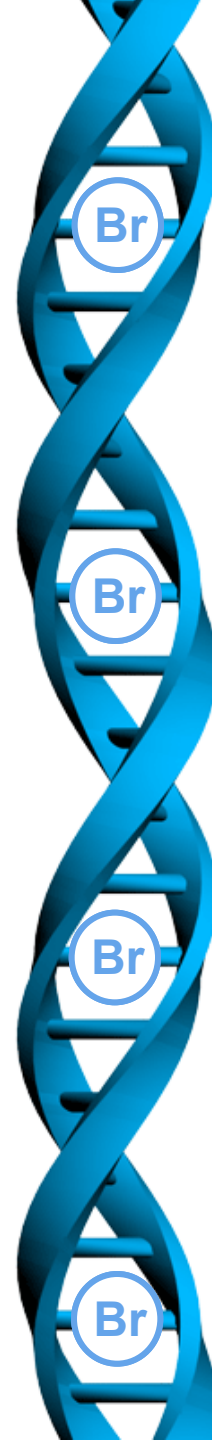

# CYTOKINETIKA

BrdU

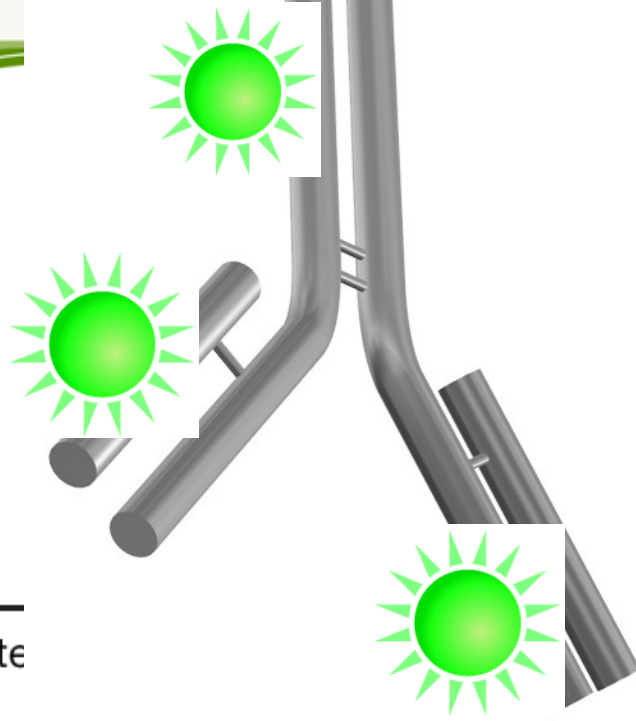

Incorporate

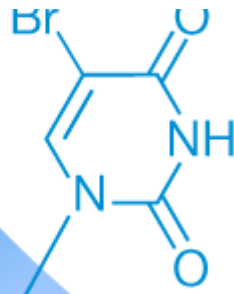



# CYTOKINETIKA

BrdU



*Acid or DNase*



# CYTOKINETIKA

BrdU

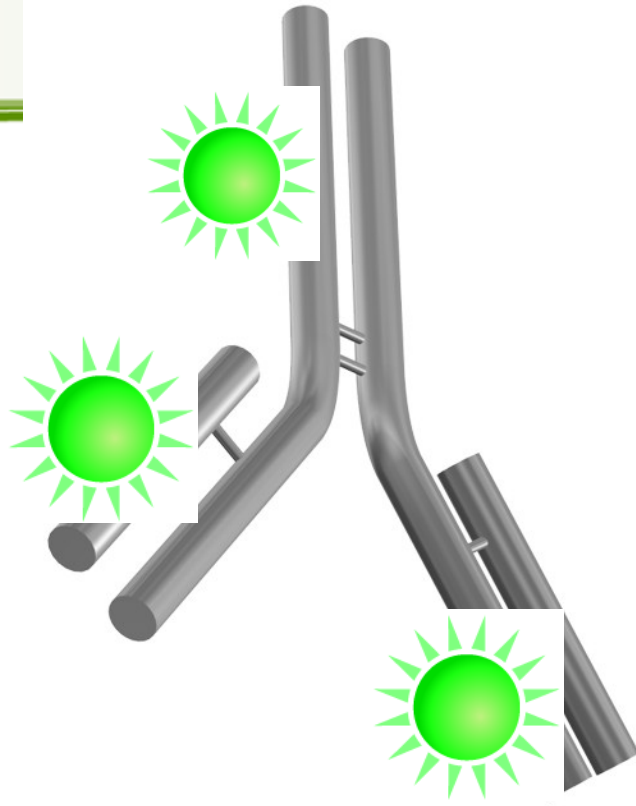

BrdU

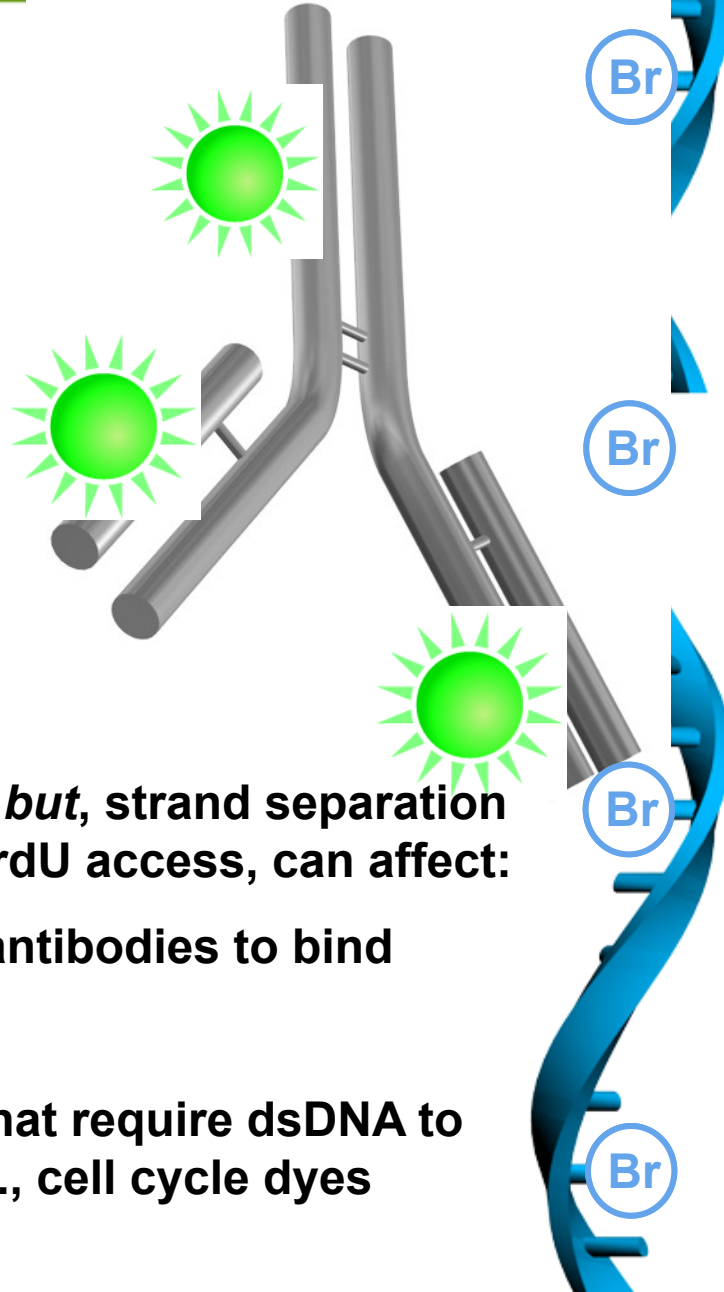

- Non-radioactive
- Multiplex compatible *but*, strand separation requirement for anti-BrdU access, can affect:
  - Ability for other antibodies to bind
  - Morphology
  - Ability for dyes that require dsDNA to bind efficiently, i.e., cell cycle dyes

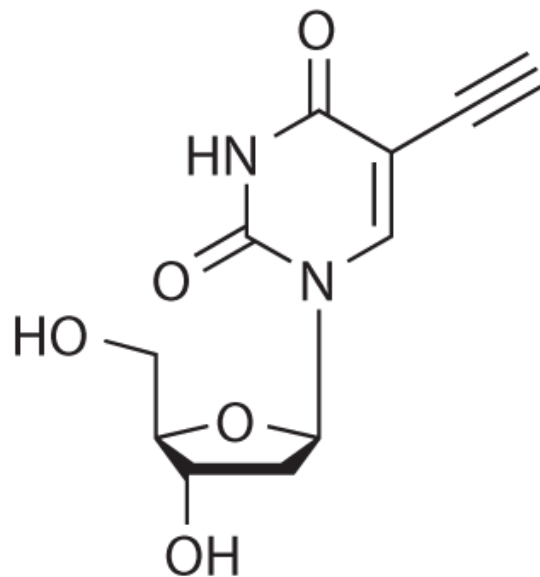

**EdU (5-ethynyl-2'-deoxyuridine)**



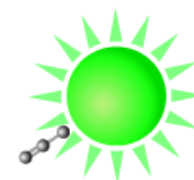
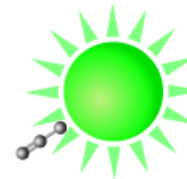
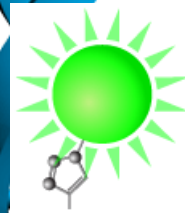
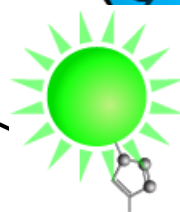
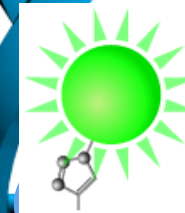
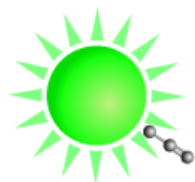
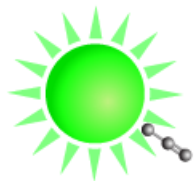
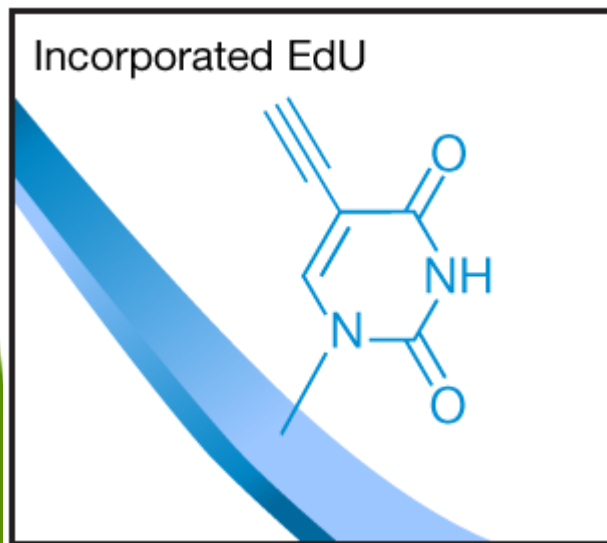



- **Non-radioactive**
- **No DNA denaturation required**
- **Simplified protocol**
- **Small molecule detection**
- **Multiplex compatible, including**
  - **Other antibodies**
  - **Dyes for cell cycle analysis**

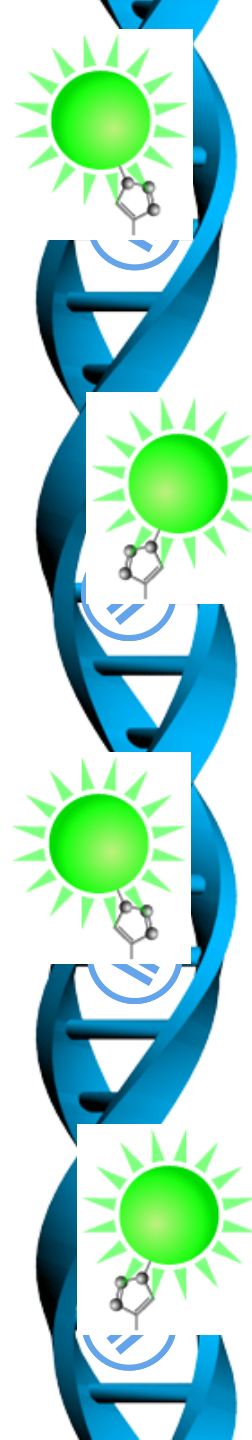

# Flow cytometry most common application

Immunophenotype characterisation of the cells  
(CSCs markers, differentiation, ...)

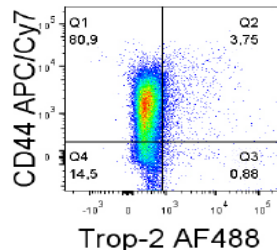

Cell Cycle (DNA content, Cell cycle modulation after treatment)

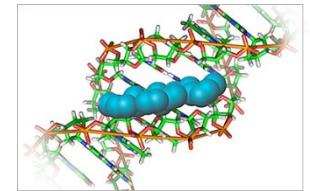

Cell Death analysis  
(AnnexinV, Cleaved Caspase3, ...)

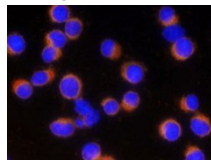

DNA damage (  $\gamma$ H2AX,...)

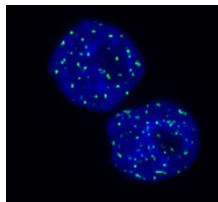

Proliferation (BrdU, EdU, mitosis - pH3)



Viability assays (propidium iodid, CalceinAM, ...)

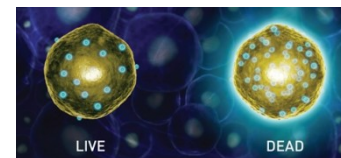

# Example of final set-up

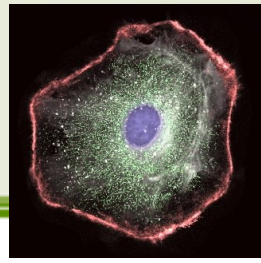
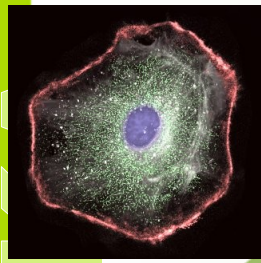

Parametr	Marker	Fluorochrome
Cell Surface Marker	CD44	APC/Cy7
Cell Surface Marker	Trop-2	AF488
Viability	LIVE/DEAD kit	Yellow
DNA synthesis	Click-iT EdU	AF647
Cell Cycle	DNA content	PO-PRO-1
DNA damage	$\gamma$ H2AX	PE
Apoptosis	Cleaved Caspase 3	AF494

# sample of final results (DU-145)

## Viability and Immunophenotype

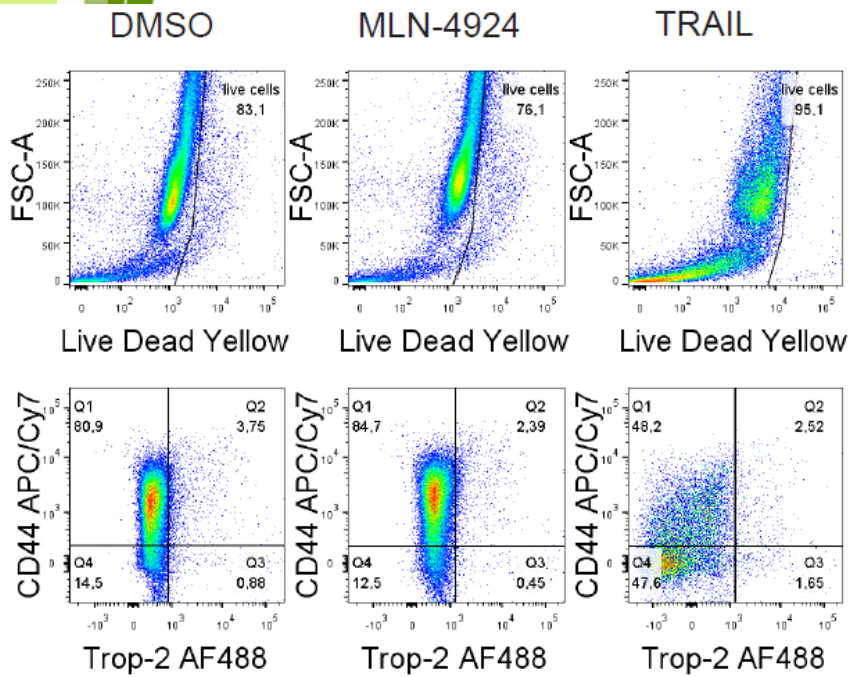

## Cell cycle and Proliferation

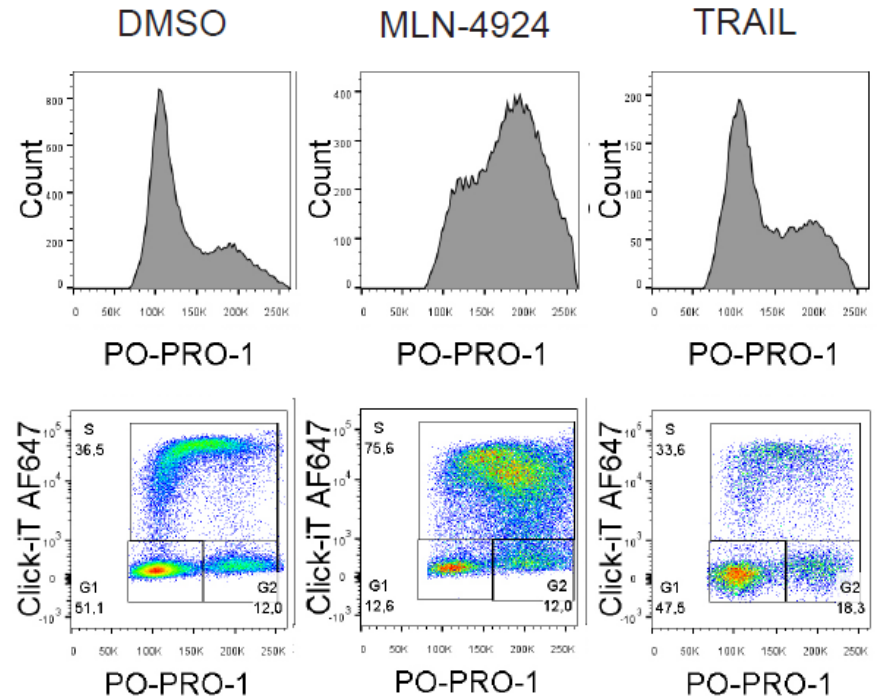

# Example of final results

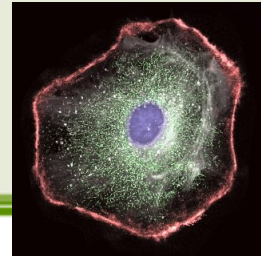
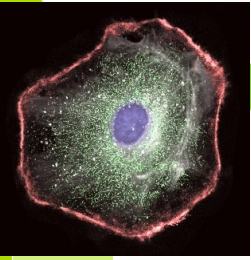

## DNA damage and Apoptosis

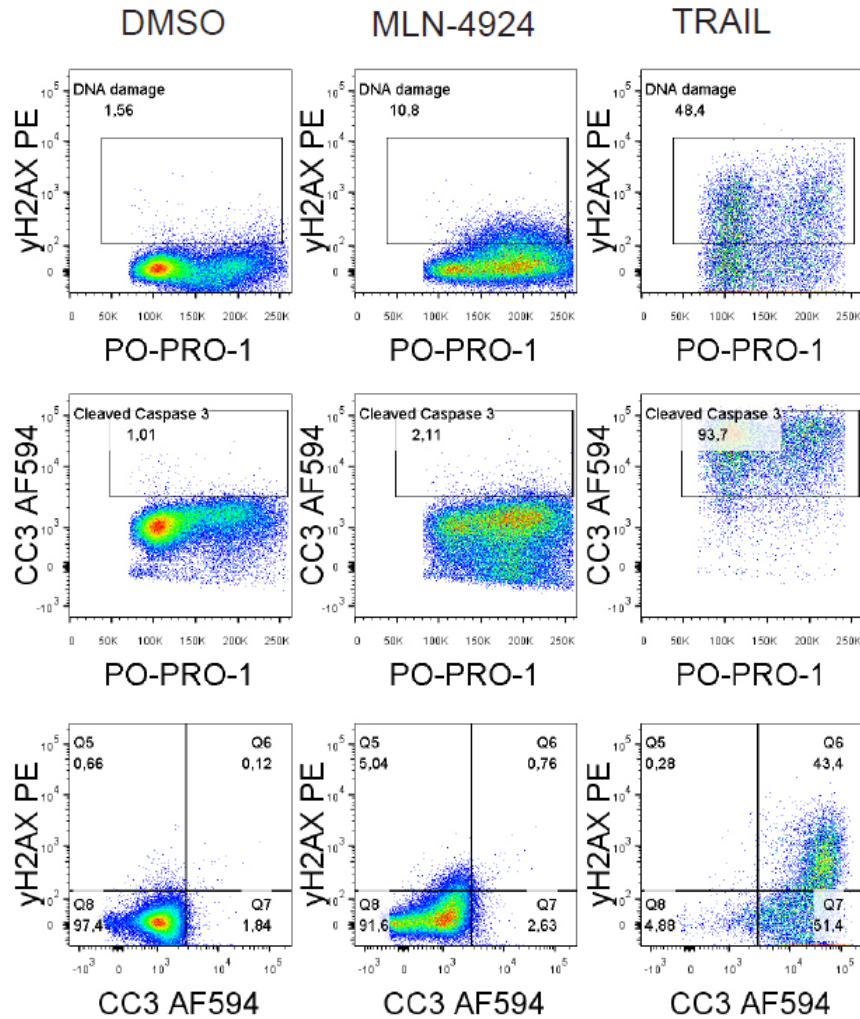

CYTOKINETE





# The Nobel Prize in Chemistry 2008

► "for the discovery and development of the green fluorescent protein, GFP"

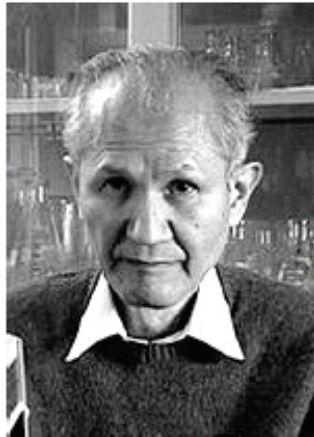

Photo: J.  
Henriksson/SCANPIX

**Osamu Shimomura**

🕒 1/3 of the prize

USA

Marine Biological  
Laboratory (MBL)  
Woods Hole, MA, USA;  
Boston University Medical  
School  
Massachusetts, MA, USA

b. 1928  
(in Kyoto, Japan)



Photo: J.  
Henriksson/SCANPIX

**Martin Chalfie**

🕒 1/3 of the prize

USA

Columbia University  
New York, NY, USA

b. 1947



Photo: UCSD

**Roger Y. Tsien**

🕒 1/3 of the prize

USA

University of California  
San Diego, CA, USA;  
Howard Hughes Medical  
Institute

b. 1952

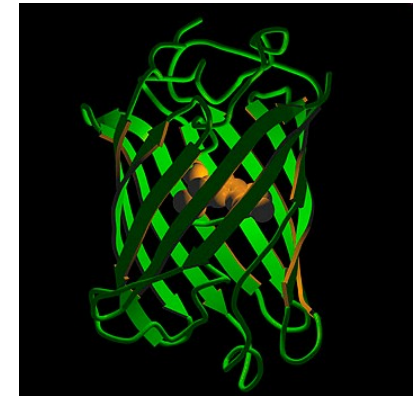

# Fluorescent proteins

## ▶ bioluminescence resonance energy transfer (BRET)

### *Aequorea victoria* - jellyfish

- ▶ Blue bioluminescence.  $\text{Ca}^{2+}$  interacts with aequorin photoprotein.
- ▶ Blue light excites **green fluorescent protein**.

### *Renilla reniformis* – coral

- ▶ luminescence appears after degradation of coelenterazine in the presence of luciferase enzyme.
- ▶ Blue light excites **green fluorescent protein**

*Aequorea victoria* “Crystal jelly”

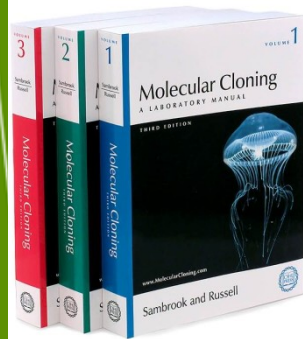

[http://www.mbayaq.org/efc/living\\_species/default.asp?hOri=1&inhab=440](http://www.mbayaq.org/efc/living_species/default.asp?hOri=1&inhab=440)

*Renilla reniformis* "Sea Pansy"



<http://www.whitney.ufl.edu/species/seapansy.htm>

# Fluorescent proteins

- ▶ **Osamu Shimomura**
- ▶ 1961 discovered GFP and aequorin

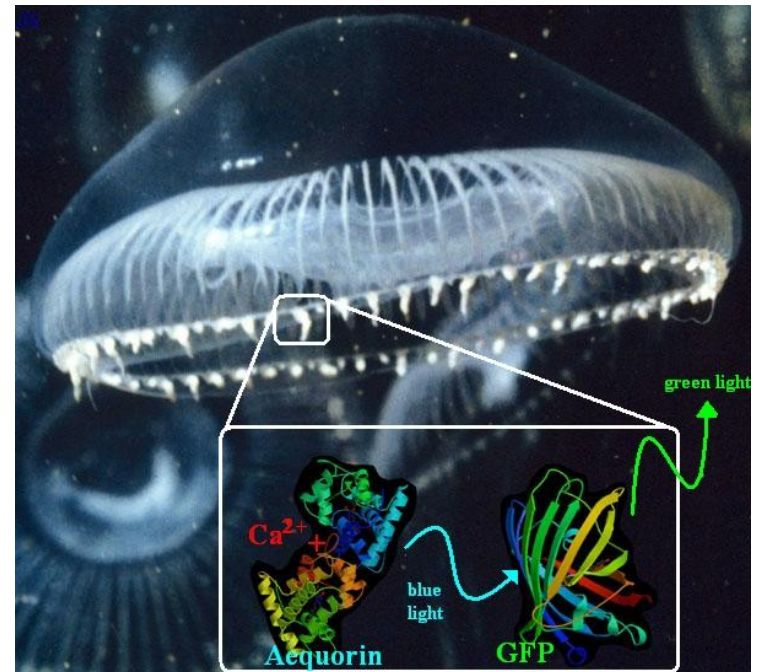
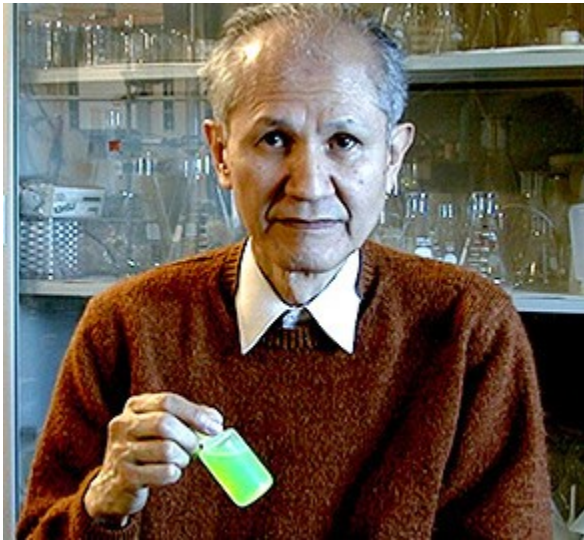



# Fluorescent proteins

- Douglas Prasher
- Martin Chalfie

Science. 1994 Feb 11;263(5148):

**Green fluorescent protein as a marker for gene expression.**

Chalfie M, Tu Y, Euskirchen G, Ward WW, Prasher DC.

Department of Biological Sciences, Columbia University, New York, NY 10027.

- ▶ A complementary DNA for the *Aequorea victoria* green fluorescent protein (GFP) produces a fluorescent product when expressed in prokaryotic (*Escherichia coli*) or eukaryotic (*Caenorhabditis elegans*) cells. Because exogenous substrates and cofactors are not required for this fluorescence, GFP expression can be used to monitor gene expression and protein localization in living organisms.

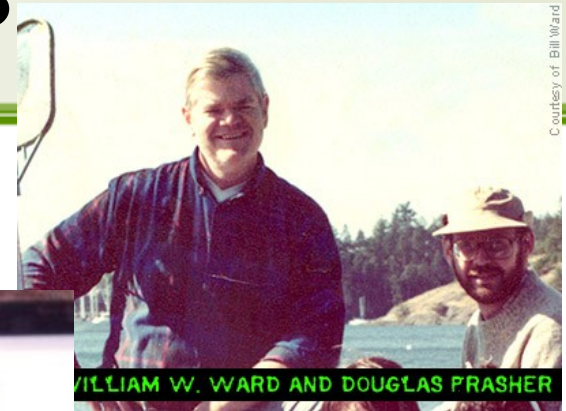
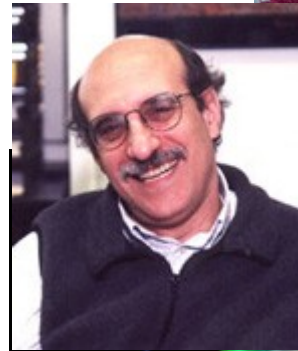

Courtesy of Bill Ward



Courtesy of Advanced Cell Technology

# Fluorescent proteins

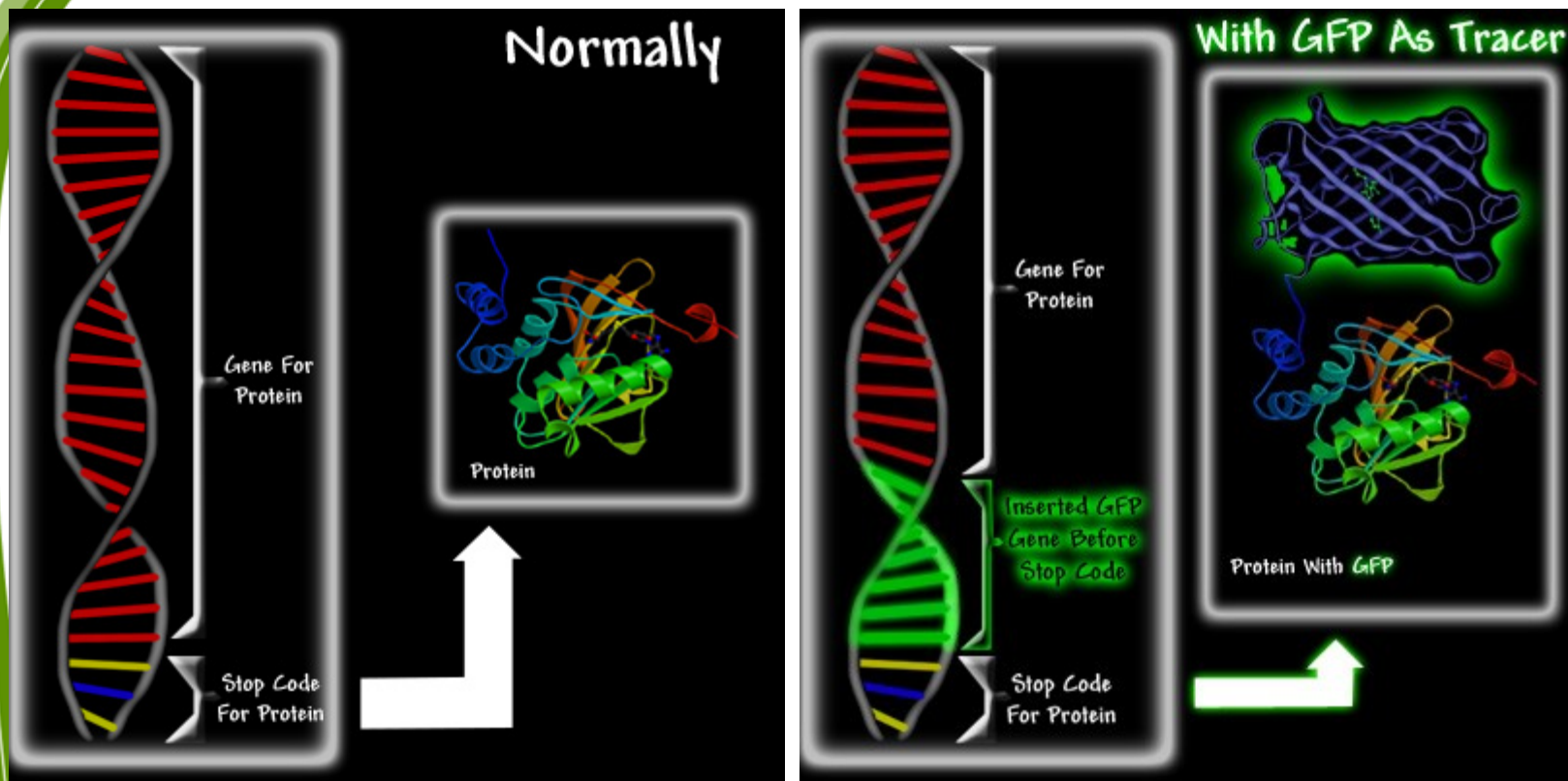

<http://www.conncoll.edu/ccacad/zimmer/GFP-ww/GFP2.htm>

## Roger Tsien

- ~ 2002 – mutated FP = wide spectrum of colors

<http://www.tsienlab.ucsd.edu/>

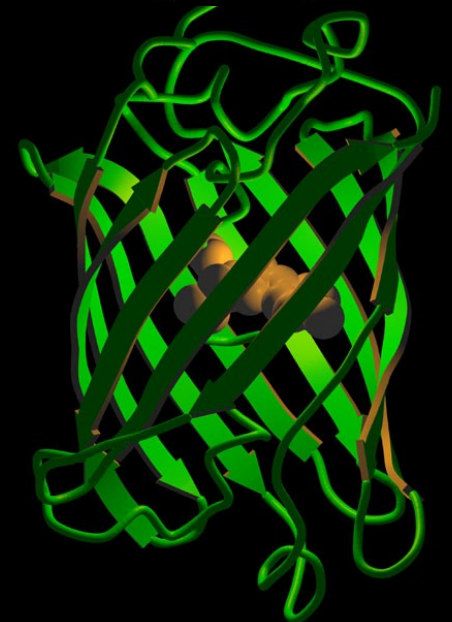
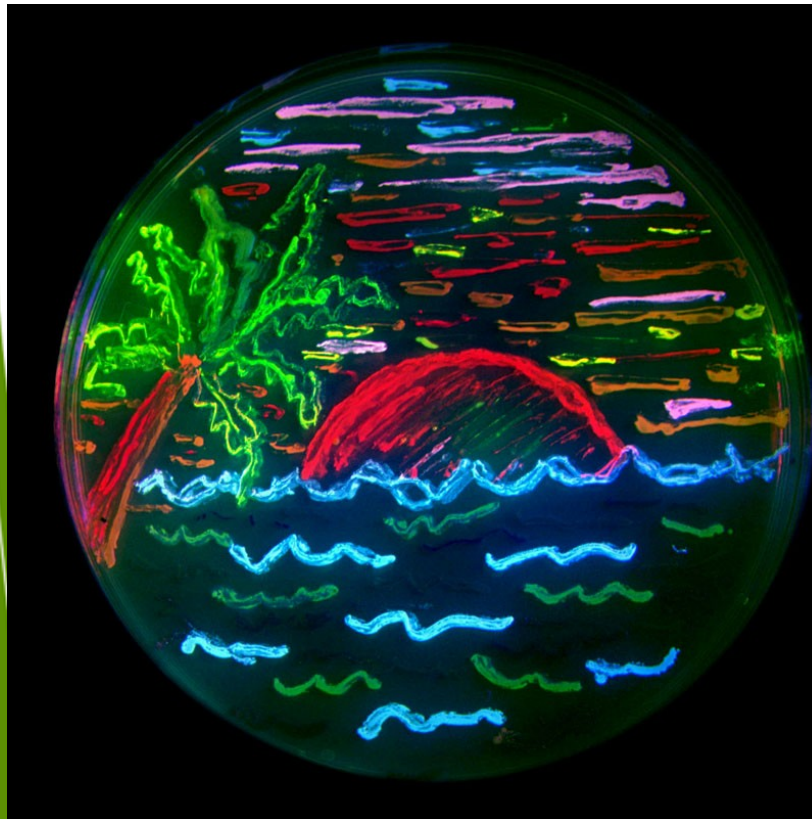



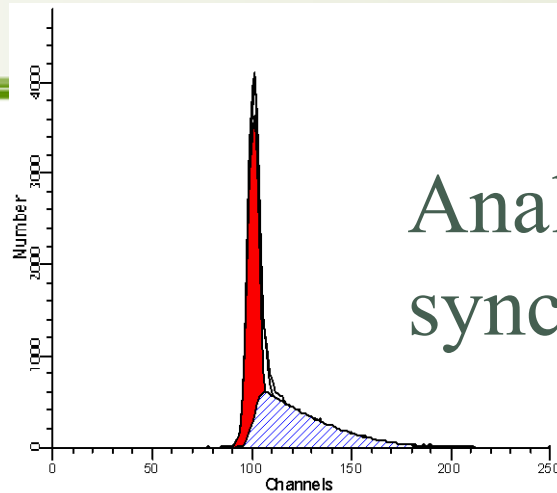
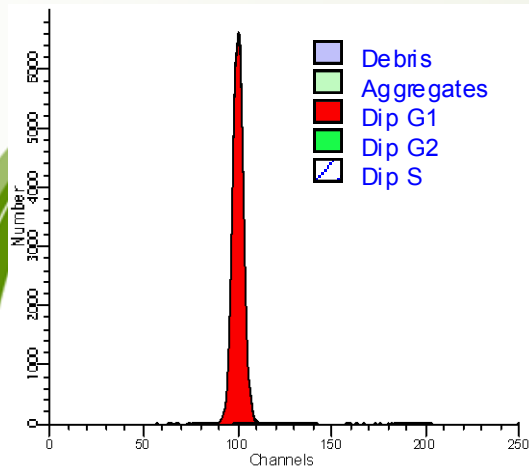

## Analysis of synchronized cells

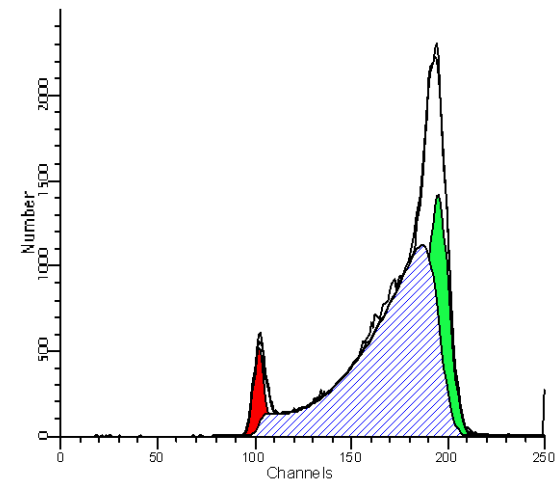
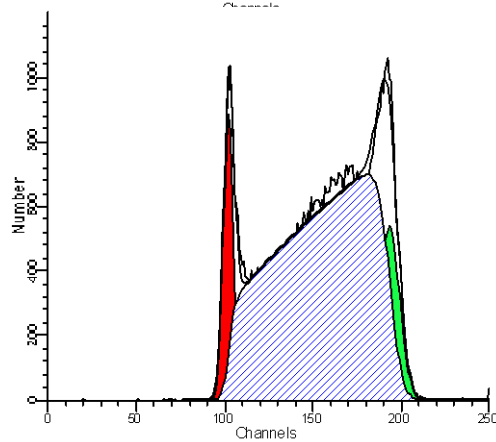
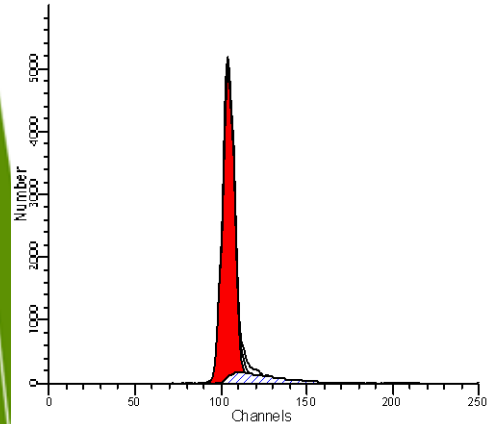
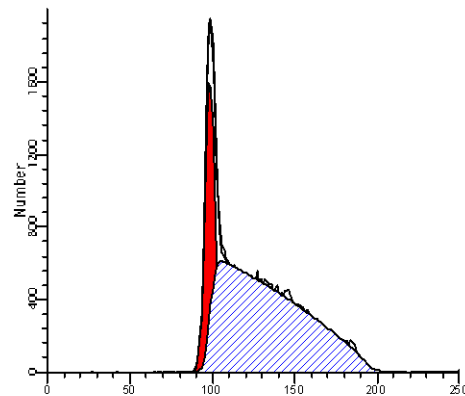
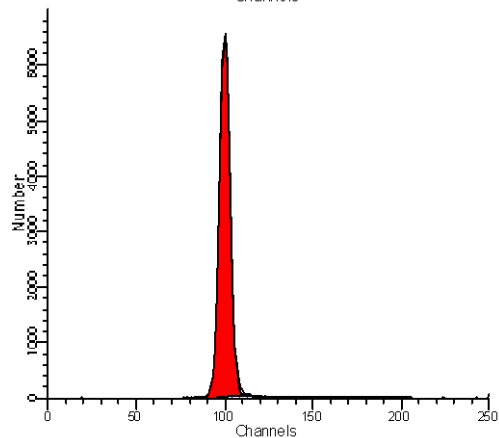

# Fucci

(fluorescent ubiquitination-based cell cycle indicator) cells

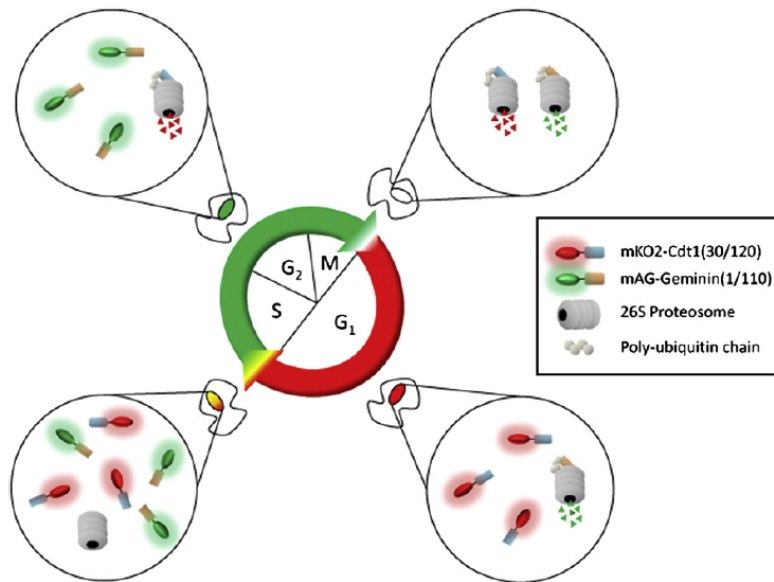

Chemistry & Biology 15, February 2008 ©2008 Elsevier Ltd

**Ubiquitin E3 ligase complexes**

**G1 - APC<sup>Cdh1</sup>**

**S, G2, M- SCF<sup>Skp2</sup>**

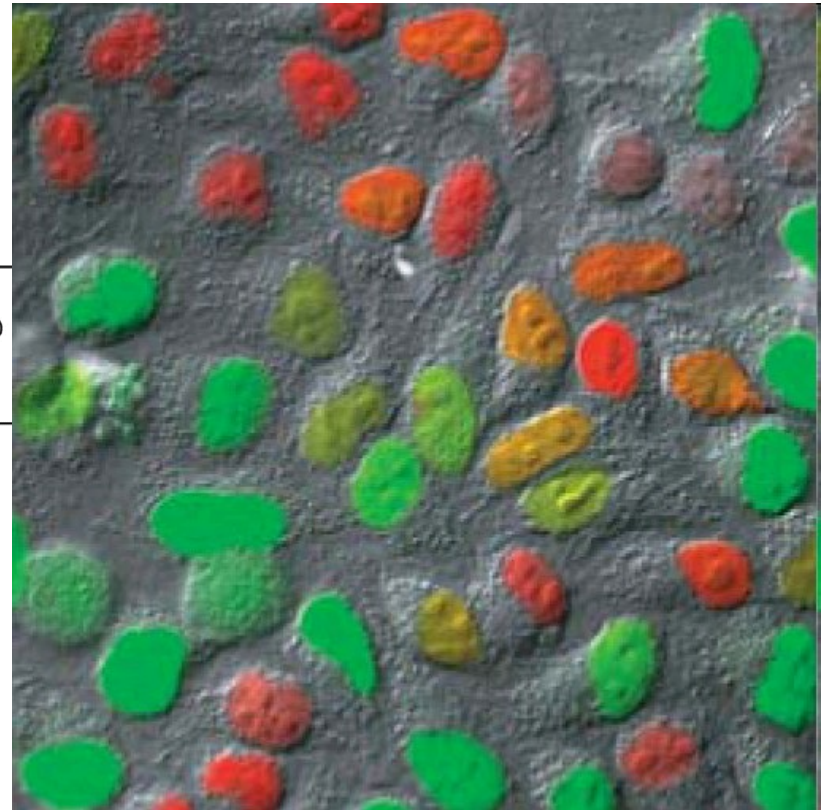

*Nature Methods* - 5, 283 (2008)

## Fucci

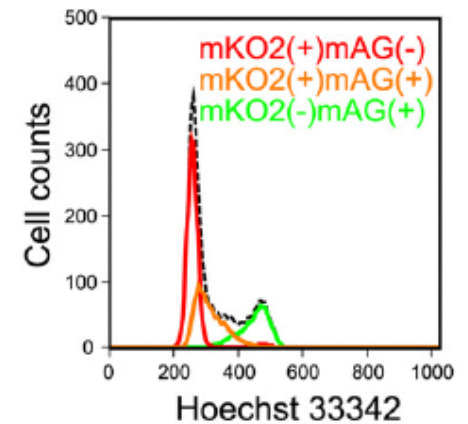
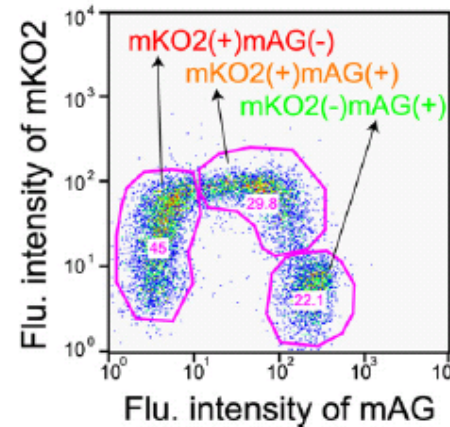
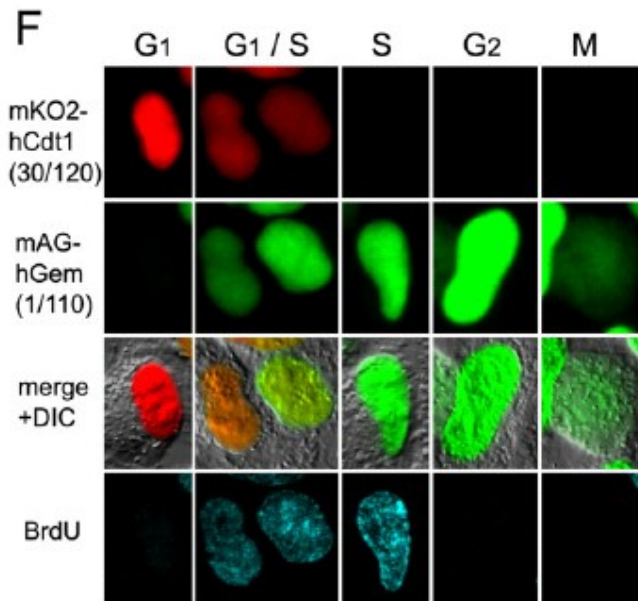

## Resource

Cell

## Visualizing Spatiotemporal Dynamics of Multicellular Cell-Cycle Progression

Asako Sakaue-Sawano,<sup>1,3</sup> Hiroshi Kurokawa,<sup>1,4</sup> Toshifumi Morimura,<sup>2</sup> Aki Hanyu,<sup>5</sup> Hiroshi Hama,<sup>1</sup> Hatsuki Osawa,<sup>1</sup> Saori Kashiwagi,<sup>2</sup> Kiyoko Fukami,<sup>4</sup> Takaki Miyata,<sup>6</sup> Hiroyuki Miyoshi,<sup>7</sup> Takeshi Imamura,<sup>5</sup> Masaharu Ogawa,<sup>2</sup> Hisao Masai,<sup>8</sup> and Atsushi Miyawaki<sup>1,3,\*</sup>

<sup>1</sup>Laboratory for Cell Function and Dynamics

<sup>2</sup>Laboratory for Cell Culture Development

<sup>3</sup>Advanced Technology Development Group, Brain Science Institute, RIKEN, 2-1 Hirosawa, Wako-city, Saitama 351-0198, Japan

<sup>4</sup>Life Function and Dynamics, ERATO, JST, 2-1 Hirosawa, Wako-city, Saitama 351-0198, Japan

<sup>5</sup>School of Life Science, Tokyo University of Pharmacy and Life Science, 1432-1 Horinouchi, Hachioji, Tokyo 192-0392, Japan

<sup>6</sup>Departments of Biochemistry, The Cancer Institute of the Japanese Foundation for Cancer Research, 3-10-6 Ariake, Koto-ku, Tokyo 135-8550, Japan

<sup>7</sup>Department of Anatomy and Cell Biology, Nagoya University Graduate School of Medicine, 65 Tsurumai-cho, Showa-ku, Nagoya, Aichi 466-8550, Japan

<sup>8</sup>Subteam for Manipulation of Cell Fate, BioResource Center, RIKEN Tsukuba Institute, 3-1-1 Koyadai, Tsukuba, Ibaraki 305-0074, Japan

<sup>\*</sup>Genome Dynamics Project, Tokyo Metropolitan Institute of Medical Science, 3-18-22 Honkomagome, Bunkyo-ku, Tokyo 113-8613, Japan

\*Correspondence: matsushi@brain.riken.jp

DOI 10.1016/j.cell.2007.12.033

<http://cfd.s.brain.riken.jp/Fucci.html>

CONTROL

SCH900776

MU380

VEHICLE

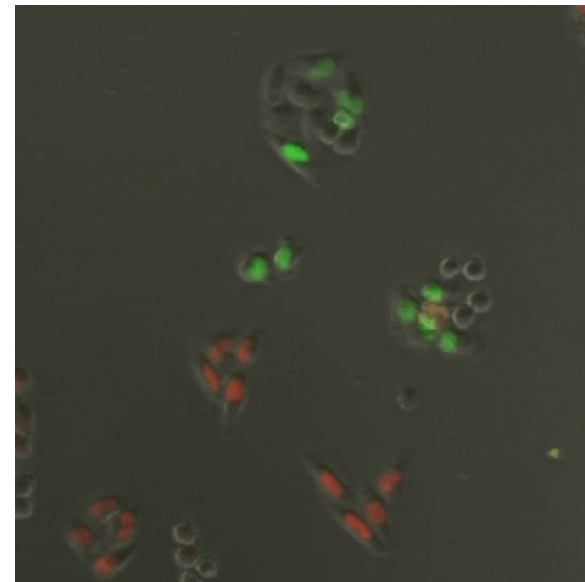
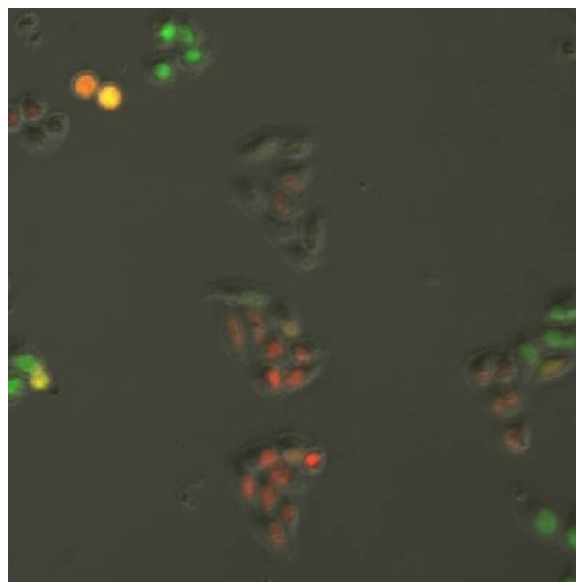
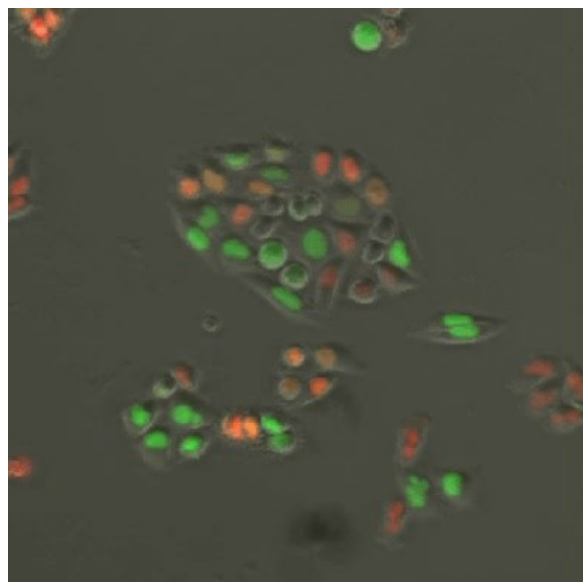

GEMCITABINE

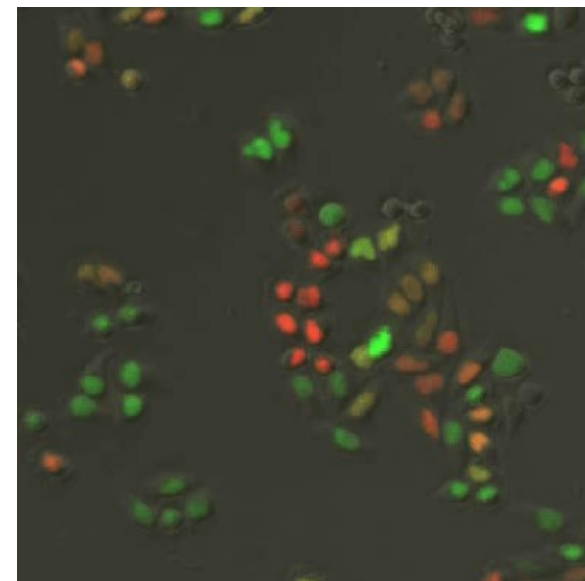
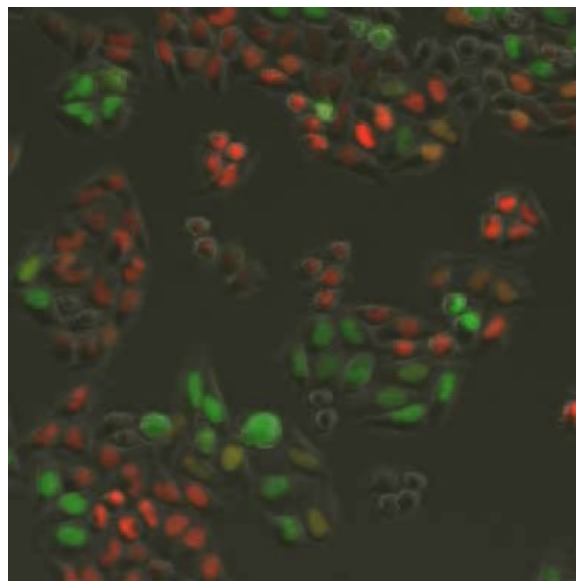
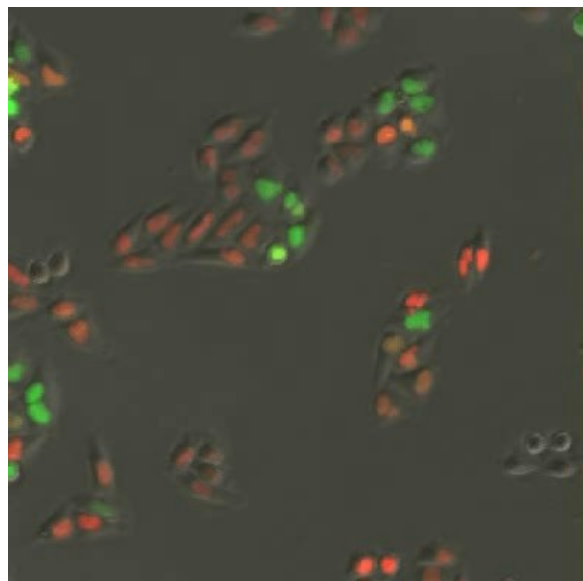

## Summary

- ▶ **DNA analysis**
  - ▶ Require fine sample preparation, debris elimination, sw tool for precise analysis of histograms
  - ▶ It is possible to combine with analysis of other parameters e.g. DNA synthesis
- ▶ **Cell division enumeration**
  - ▶ Mostly for synchronized populations
- ▶ **Fluorescent proteins**
  - ▶ Fucci – elegant tool for *in vitro* a *in vivo* experiments

**Trendy: instrumentace**



# Spectral flow cytometry

# J.P. Robinson, Purdue University

CYTOKINETIKA

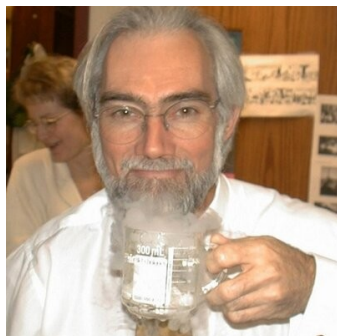

Cytometry Part A • 81A: 35–44, 2012

ORIGINAL ARTICLE

**Cytometry**

PART A  
Journal of the  
International Society for  
Advancement of Cytometry



## Hyperspectral Cytometry at the Single-Cell Level Using a 32-Channel Photodetector

Gérald Grégori,<sup>1,2</sup> Valery Patsekina,<sup>1,3</sup> Bartek Rajwa,<sup>1,3</sup> James Jones,<sup>4</sup> Kathy Ragheb,<sup>1,3</sup> Cheryl Holdman,<sup>1,3</sup> J. Paul Robinson<sup>1,3,4\*</sup>

2  
DOI: 10.1017/S1431927605510328

Microsc Microanal 11(Suppl 2), 2005  
Copyright 2005 Microscopy Society of America

### Multispectral Flow Cytometry: Next Generation Tools For Automated Classification

J. Paul Robinson<sup>a,b</sup>, Valery Patsekina<sup>a</sup>, Gerald Grégori<sup>a</sup>, Bartek Rajwa<sup>a,b</sup>, and James Jones<sup>a,b</sup>

<sup>a</sup>Department of Basic Medical Science, School of Veterinary Medicine, and <sup>b</sup>Weldon Department of Biomedical Engineering, Purdue University, West Lafayette, IN, 47907, USA



US007280204B2

(12) **United States Patent**  
Robinson et al.

(10) Patent No.: **US 7,280,204 B2**  
(45) Date of Patent: **Oct. 9, 2007**

(54) <b>MULTI-SPECTRAL DETECTOR AND ANALYSIS SYSTEM</b>	5,394,237 A	2/1995	Chang et al.	188/79/51
	5,422,712 A	6/1995	Ogano	356/73
	5,675,517 A	10/1997	Stokdijk	702/85
(75) Inventors: <b>Joseph Paul Robinson</b> , West Lafayette, IN (US); <b>Bartłomiej Rajwa</b> , West Lafayette, IN (US); <b>Gérald Grégori</b> , Marseille (FR); <b>Valery Patsekina</b> , West Lafayette, IN (US)	5,719,667 A *	2/1998	Miers	356/73
	6,240,541 B1 *	6/2001	Baraji et al.	356/73
	6,630,307 B2 *	10/2003	Bruchez et al.	435/6
	6,885,440 B2 *	4/2005	Silcott et al.	356/73
	6,947,134 B2 *	9/2005	Chang et al.	356/318
	7,057,712 B2 *	6/2006	Beck et al.	356/72

(73) Assignee: **Purdue Research Foundation**, West Lafayette, IN (US)

(Continued)

FOREIGN PATENT DOCUMENTS

(*) Notice: Subject to any disclaimer, the term of this patent is extended or adjusted under 35 U.S.C. 154(b) by 139 days.	EP	0 315 939	5/1989
--	----	-----------	--------

(Continued)

# Spectral flow cytometry

**SONY** Sony Biotechnology Inc.

Products ▸ Resources ▸ Support ▸ About Us ▸ Contact Us ▸ Order Info ▸  Site Q

Overview Features Applications Specifications Literature

## See Everything

The SP6800 Spectral Analyzer is Sony Biotechnology Inc.'s newest innovative life science system fundamentally expanding the way cell and biomarker analysis can be performed. This system incorporates a unique optical bench, Blu-ray™ disc technology, and advanced algorithms to deliver some of the most accurate and precise data available.

The SP6800 Spectral Analyzer also introduces new Flow Point technology to analyze core stream and sample event location within the flow cell. To improve accuracy of data, this system also provides unique functions to display and analyze cellular autofluorescence and allows the user to easily automatically remove.



**Sheath inlet** **outlet**  
**Sample inlet**  
**Insertion Notch**  
**Quartz part**

# Conventional vs. spectral analysis

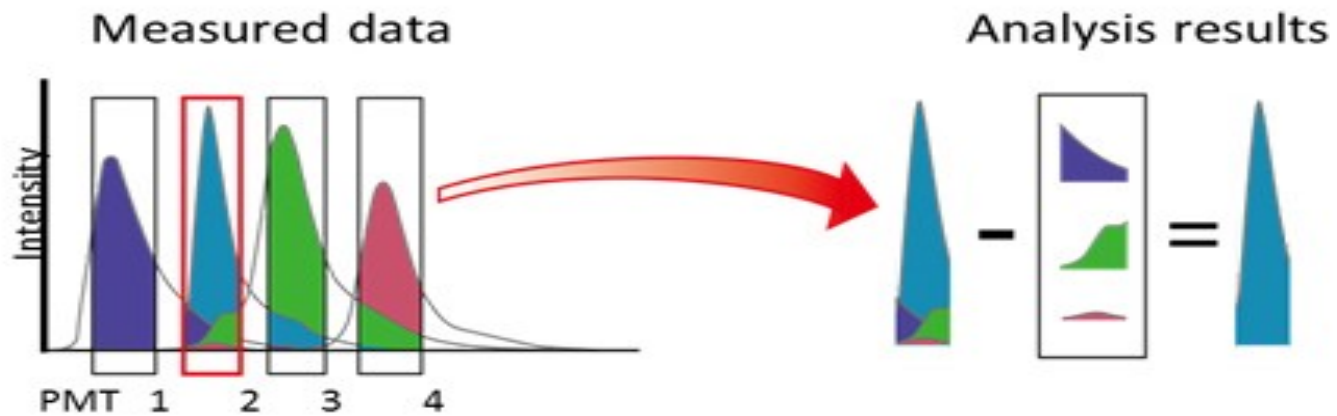

# Why Mass Cytometry?

- Highly multi-parametric, on a single cell basis
- Facilitates exploration of complex pathways
- Enables discovery of cellular relationships, responses, and developmental pathways
- Allows deep-profiling of your cell system of interest

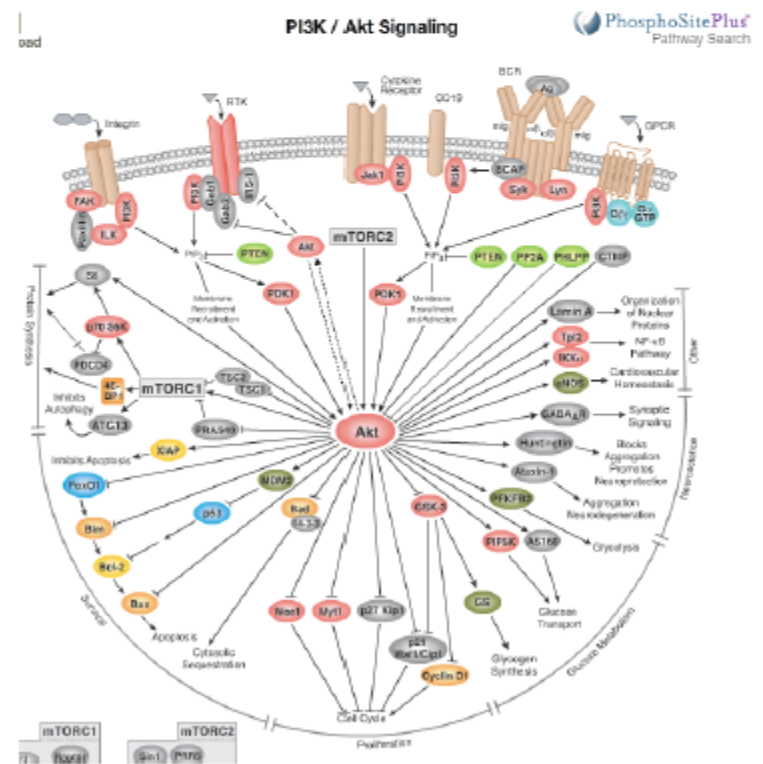
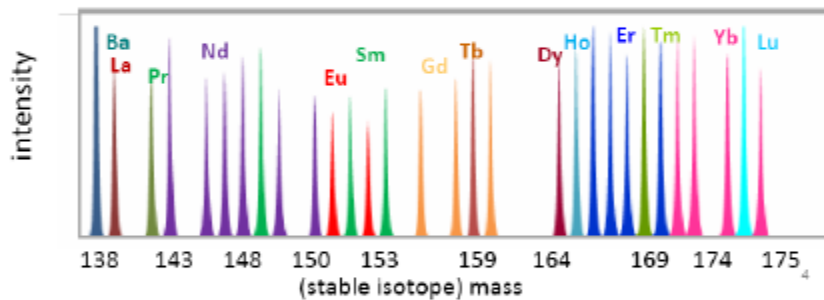

# Single Cell Mass Cytometry

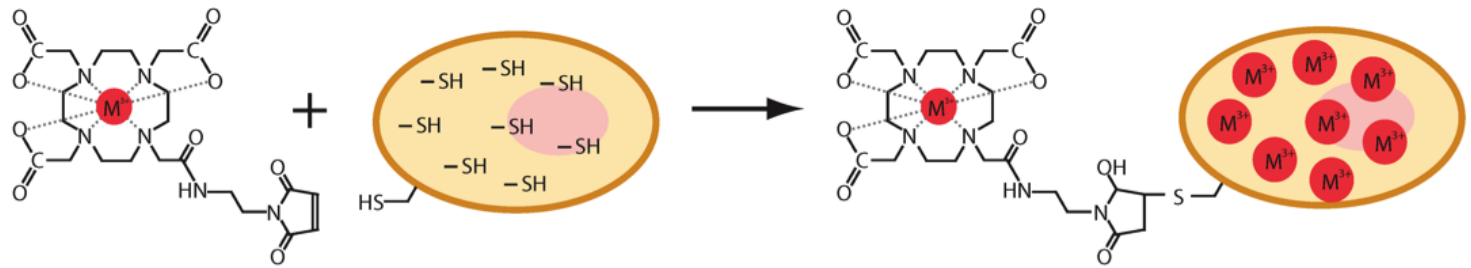

Cells were covalently labeled with a bifunctional compound, maleimido-mono-amide-DOTA (mDOTA). This compound can be loaded with a lanthanide(III) isotope ion, and reacts covalently with cellular thiol groups through the maleimide moiety.

**Single-Cell Mass Cytometry of Differential Immune and Drug Responses Across a Human Hematopoietic Continuum**

Sean C. Bendall, *et al.*

*Science* **332**, 687 (2011);

# Single Cell Mass Cytometry

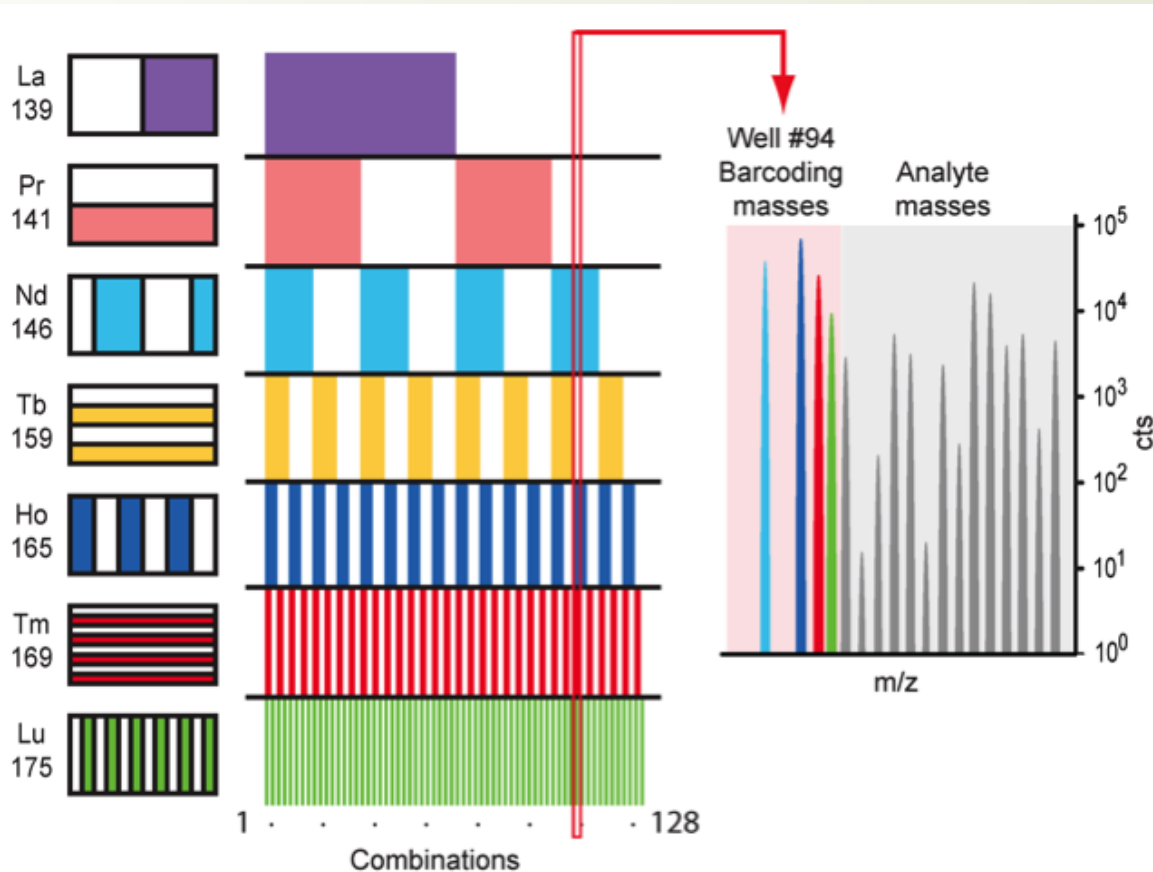

Seven unique lanthanide isotopes were used to generate 128 combinations, enough to barcode each sample in a 96-well plate. The seven lanthanide isotopes, their masses and their locations on the 96-well plate are shown.

**Single-Cell Mass Cytometry of Differential Immune and Drug Responses Across a Human Hematopoietic Continuum**

Sean C. Bendall, *et al.*

*Science* **332**, 687 (2011);



# Personální systémy

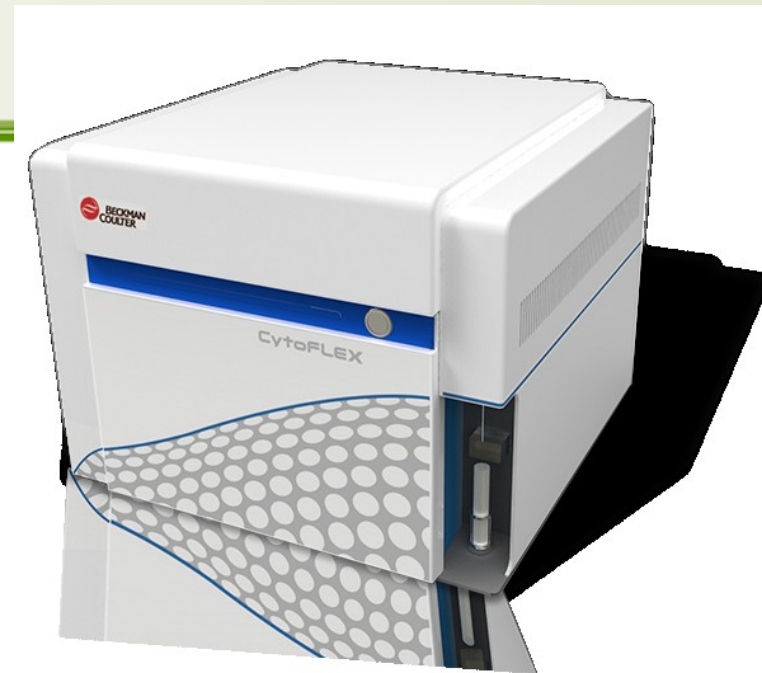

**Trendy: Reagencie**

# PrimeFlow™ RNA Assay

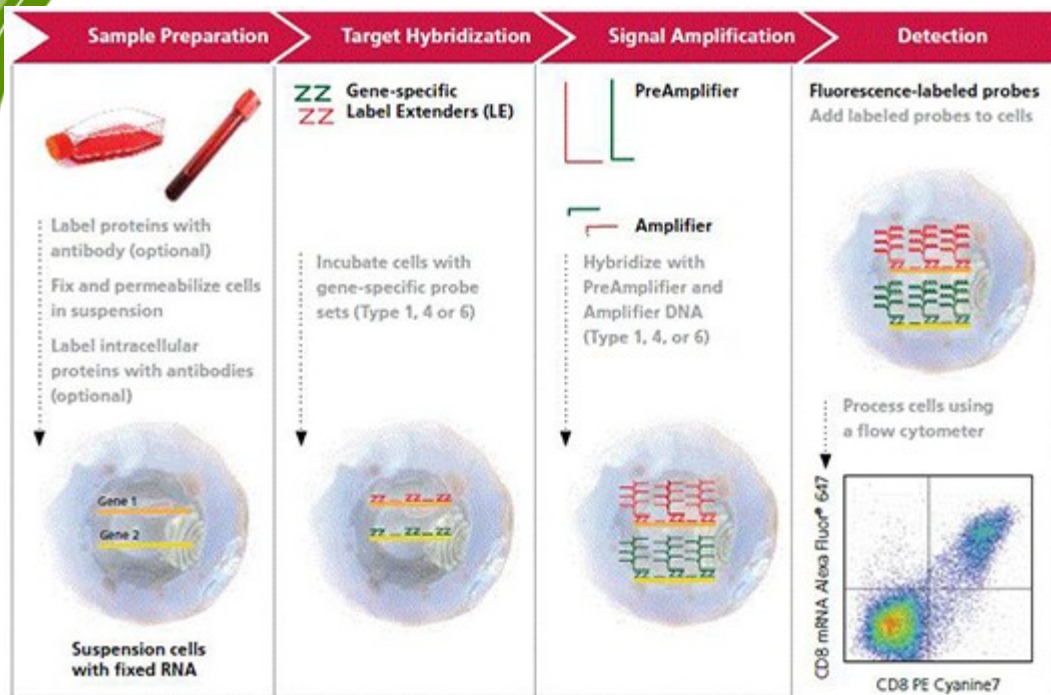

# Brilliant Violet polymers

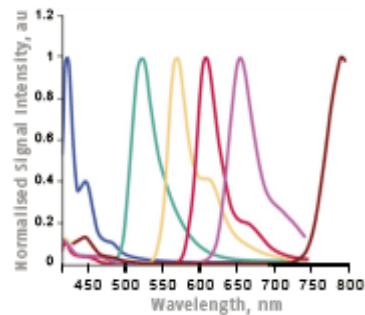

## Shrnutí přednášky

### **průtoková cytometrie:**

- nabízí široké spektrum aplikací;
- rychlý způsob analýzy a separace heterogenních populací;
- separace populací;
- multiparametrové analýzy