

ENZYMES USED IM MOLECULAR BIOLOGY

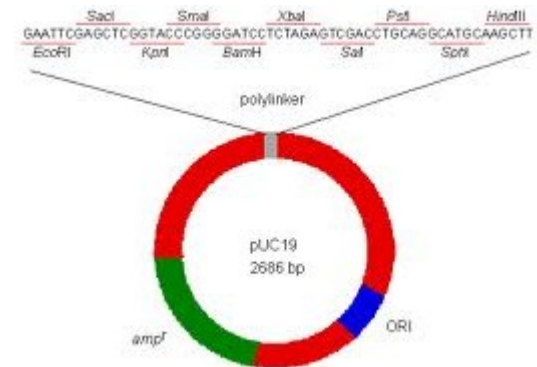
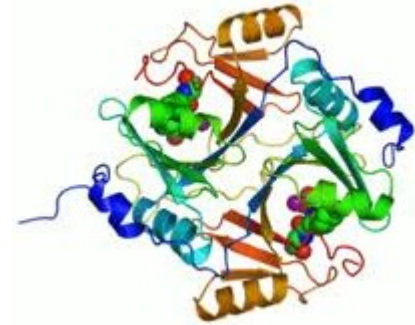

Nucleic acid processing enzymes

- nucleases
- polymerases
- phosphatases
- methylases
- kinases
- ligases
- polynucleotidyl phosphorylase

Nucleases

- hydrolases cleaving phosphodiester bonds
- DNases, RNases, „non-specific“

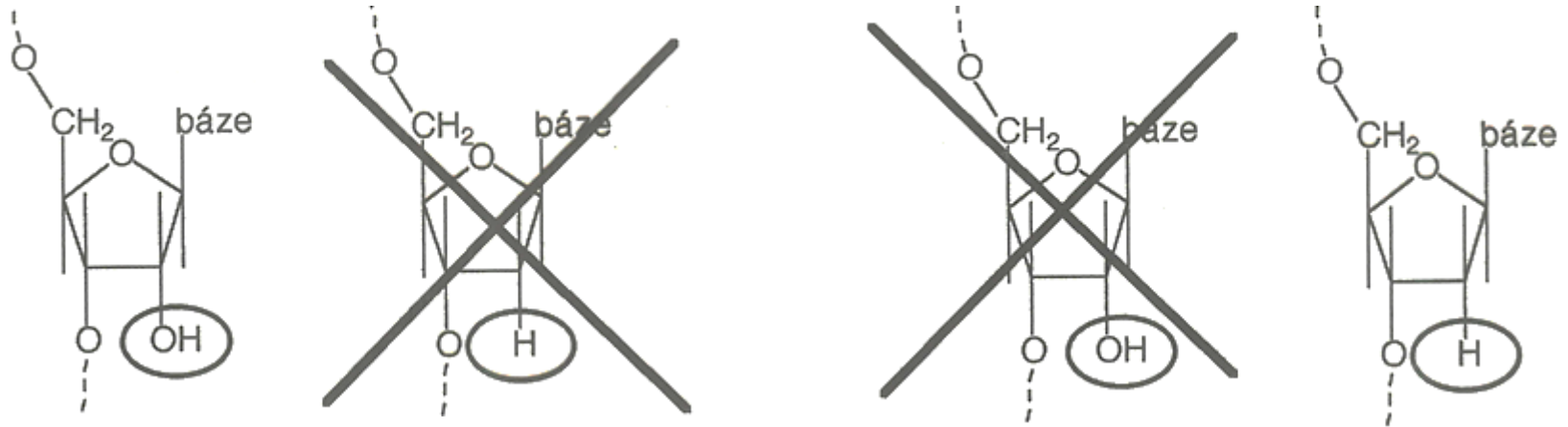

Nucleases

- which phosphoester bond is hydrolyzed

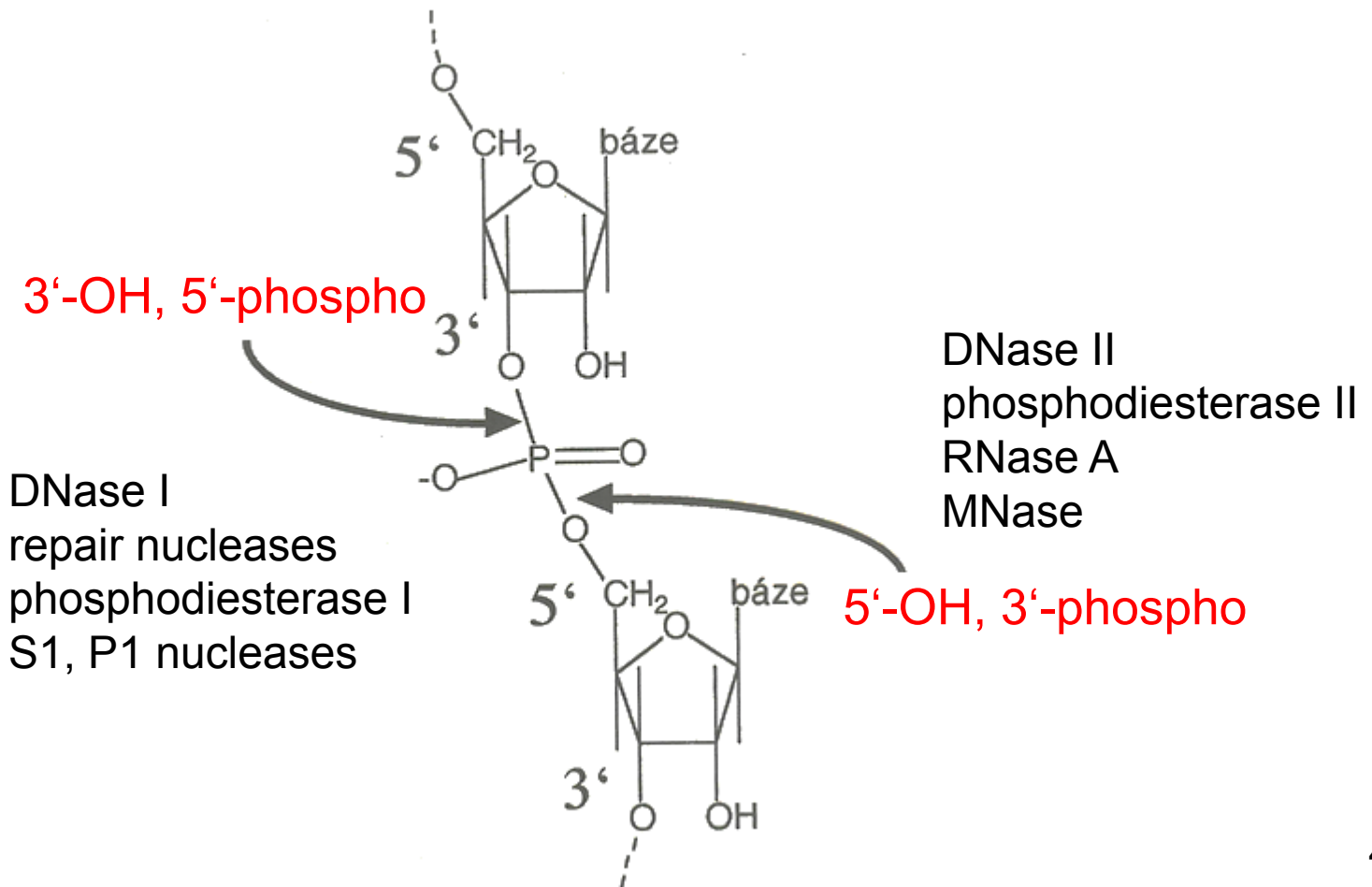

Nucleases

- endonuclease or exonucleases

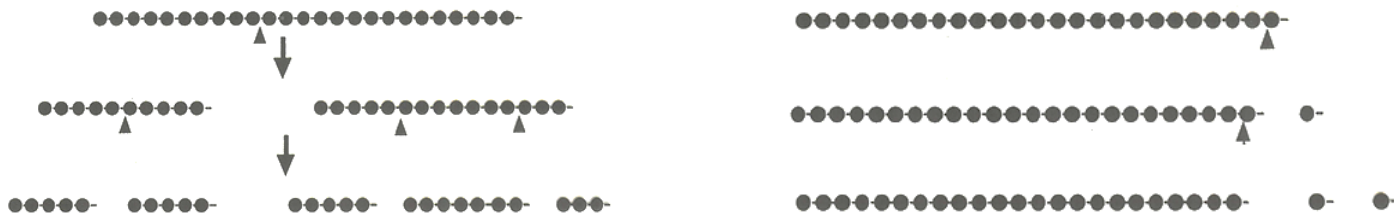

- exonucleases:

- processive or distributive



- direction of cleavage (5'→3', 3'→5')

Nucleases

- other criteria (levels of selectivity/specificity):
 - secondary structure of substrates (ss, ds, untwisted)
 - preference for certain nucleotide (Pu vs Py or particular base) – RNases (A, U1, U2, T1, T2, Phyl, PhylI)
 - sequence specificity (restriction endonucleases)
 - modification specificity (methylation-sensitive restrictases)

RESTRICTION ENZYMES

Sequence-specific DNA binding + cleavage

Type I RE: 3 different subunits (specificity, methylation, nuclease)
cleave outside binding sequence

Type II RE: 2 identical subunits, both share specific binding + nuclease
cleave within the binding sequence (4-6 bp, palindromes)
complementary methylases

Type III RE: 2 different subunits, „something between“

RESTRICTION ENZYMES

Nomenclature:

EcoRI

E	Escherichia	Genus
CO	coli	Species
R	RY13	Strain
I	první	Order of discovery

RESTRICTION ENZYMES

- sticky end formation

*Eco*RI (GAATTC) – 5'-overhangs

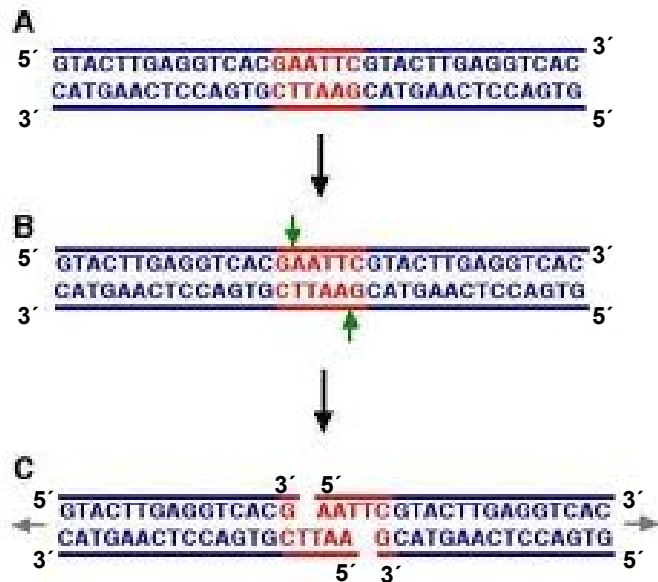

*Pst*I (CTGCAG) – 3'-overhangs

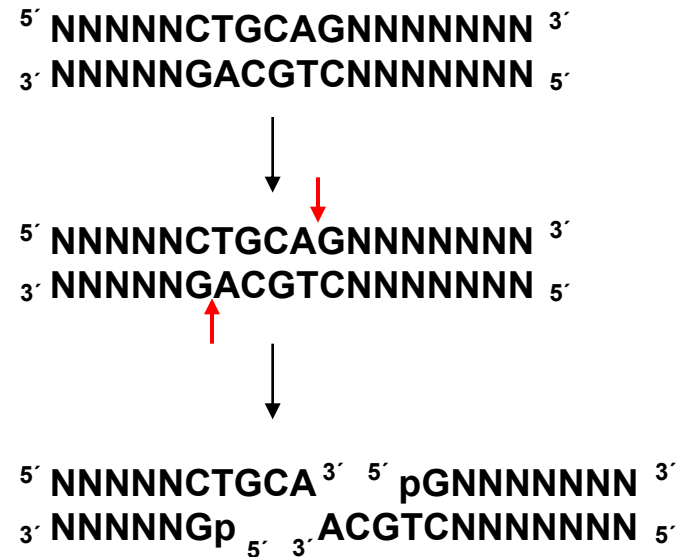

RESTRICTION ENZYMES

- **blunt end formation**

*Hae*III (GGCC):

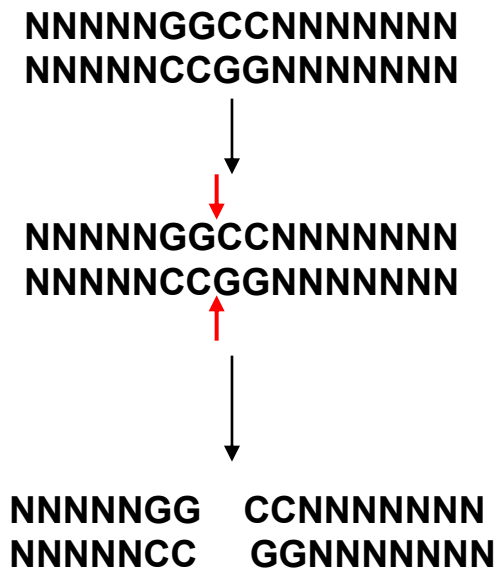

Isoschisomers:

- recognize+cleave the same sequence
- X not necessarily in the same way

- may differ in sensitivity to methylation (Msp I x Hpa II, Bstn I x EcoR II)

Linear diffusion mechanism:

- efficient searching for binding sites by sliding along DNA; balanced non-specific binding

Star activity:

- less specific cleavage under improper conditions (reduced water activity)

METHYLATION-RESTRICTION SYSTEMS

Bacterial defence against viral (phage) infection: methylated DNA is not cleaved by the restrictases, unmodified phage DNA is

Methylation systems in *v E. coli*:

- *dam* - ⁶N methylation of adenine **GATC**
roles in mismatch repair, DNA replication, gene expression
 - Bam*HI – GGATCC + (*Bacillus amyloli*)
 - Bcl*I – TGATCA - (*Bacillus caldolyticus*)
 - Mbo*I – GATC -
 - Sau*3AI – GATC +
- *dcm* – inner cytosine methylation (⁵C) in **CCAGG, CCTGG**
 - Eco*RII -
 - Bst*NI +
- *Eco*KI – ⁶N methylation of adenine **AAC(N)₆GTGC, GCAC(N)₆GTT**

For example, plasmid DNA cloned in *E. coli* *dam*⁺ is resistant to *Mbo*I

Post-replication maintenance DNA methylation in symmetrical sequences



- bacterial DNA: hemimethylated after replication, methylation follows
- phage DNA: non-methylated, cleaved
- ca 0.2 % frequency of de-novo methylation: phage „learns“ how to survive and replicate

METHYLATION-SENSITIVE RE

CG: *HpaII* mC^mCGG (either of the mCs)
CfoI G^mCGC
SmaI CC^mCGGG
TaqI A^mCGT
Clal AT^mCGAT

CNG: *MspI* $mCCGG$

CHH: *Sau96I* $GG(A/T)^mC^mC$

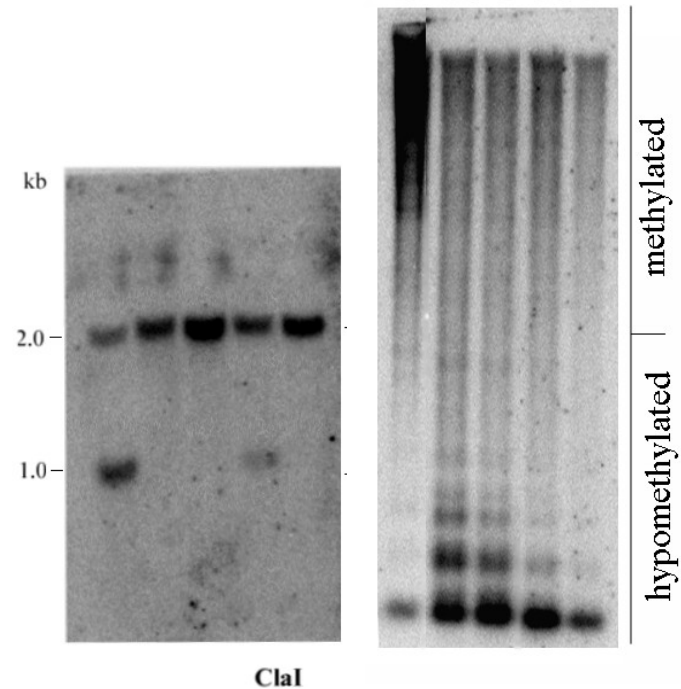

DNA POLYMERASES

E. coli DNA polymerase I:

5'→3' polymerase

5'→3' exonuclease (degradation ahead)

3'→5' exonuclease (proofreading)

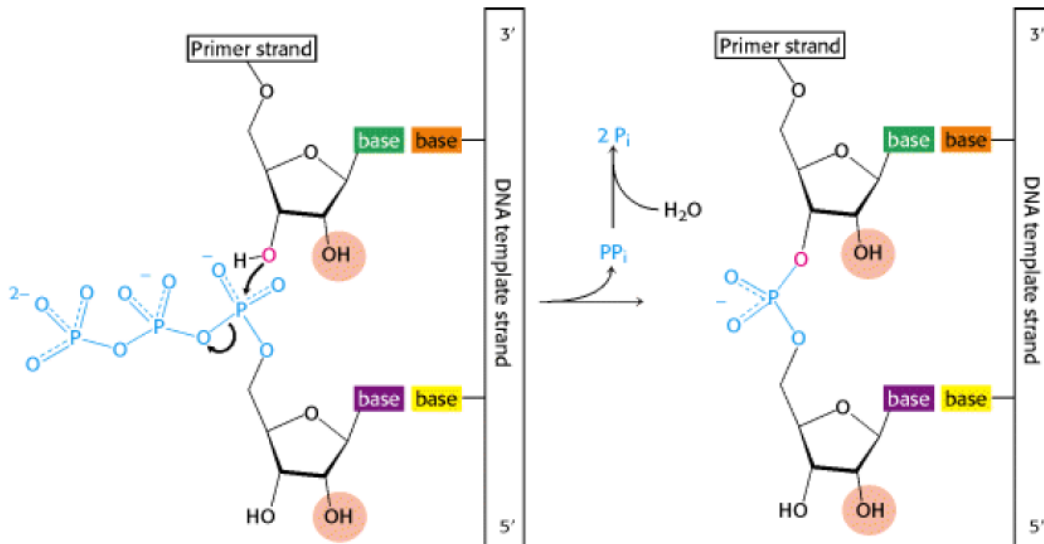
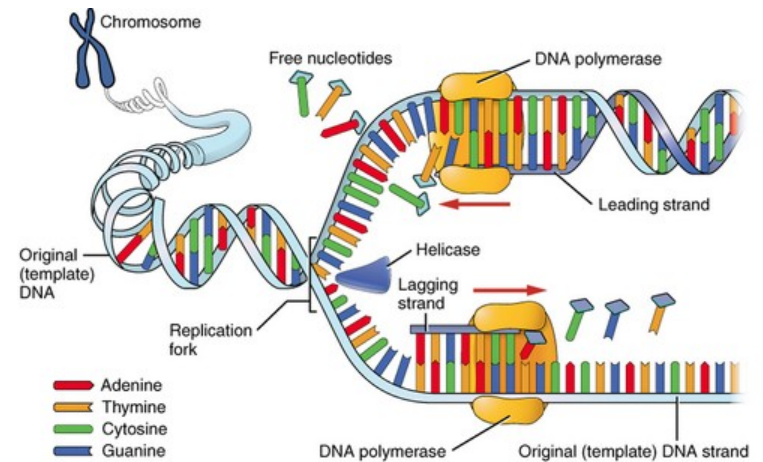

Polymerization ALWAYS 5'→3'!

Figure 5.25. Transcription Mechanism of the Chain-Elongation Reaction Catalyzed by RNA Polymerase.

DNA POLYMERASES

Proofreading exonuclease activity
(removal of misincorporated bases)

-labeling of 3'-ends

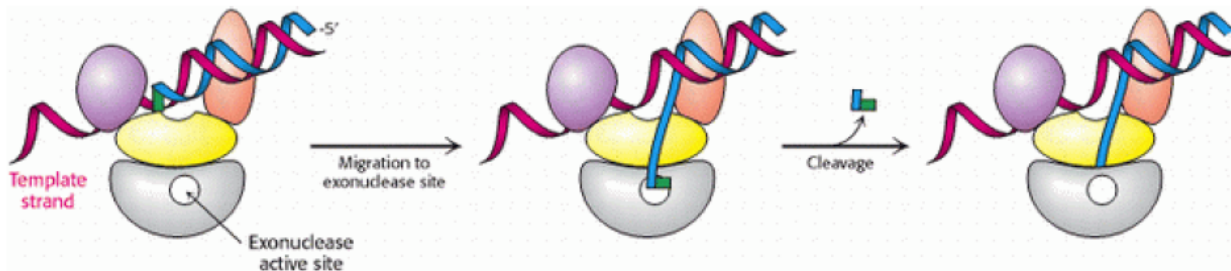
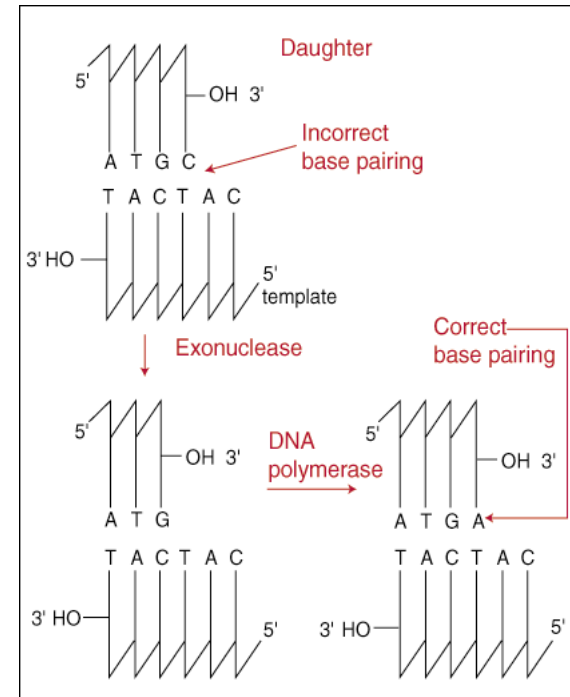

Figure 27.15. Proofreading. The growing polynucleotide chain occasionally leaves the polymerase site of DNA polymerase I and migrates to the exonuclease site. There, the last nucleotide added is removed by hydrolysis. Because mismatched bases are more likely to leave the polymerase site, this process serves to proofread the sequence of the DNA being synthesized.

DNA POLYMERASES

5' → 3' exonuclease activity

Nick Translation

- The nick translation process simultaneously:
 - Removes DNA ahead of a nick
 - Synthesizes DNA behind nick
 - Net result moves the nick in the 5' to 3' direction
- Enzyme often used is *E. coli* DNA polymerase I
 - Has 5' to 3' exonuclease activity
 - Allows enzyme to degrade DNA ahead of the nick

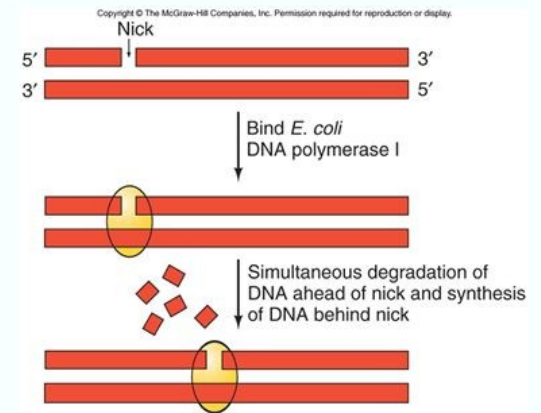

DNA POLYMERASES

Klenow fragment:

5' → 3' polymerase
3' → 5' exonuklease

NO 5' → 3' exonuclease!!
(small fragment)

„random priming“ DNA labeling

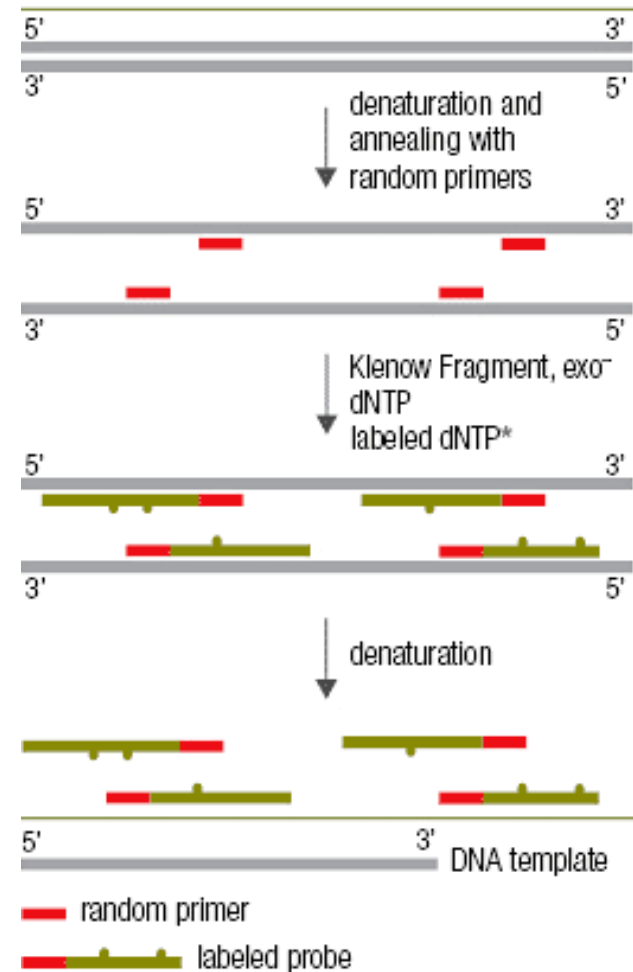

Syntéza DNA in vitro („primer extension“)

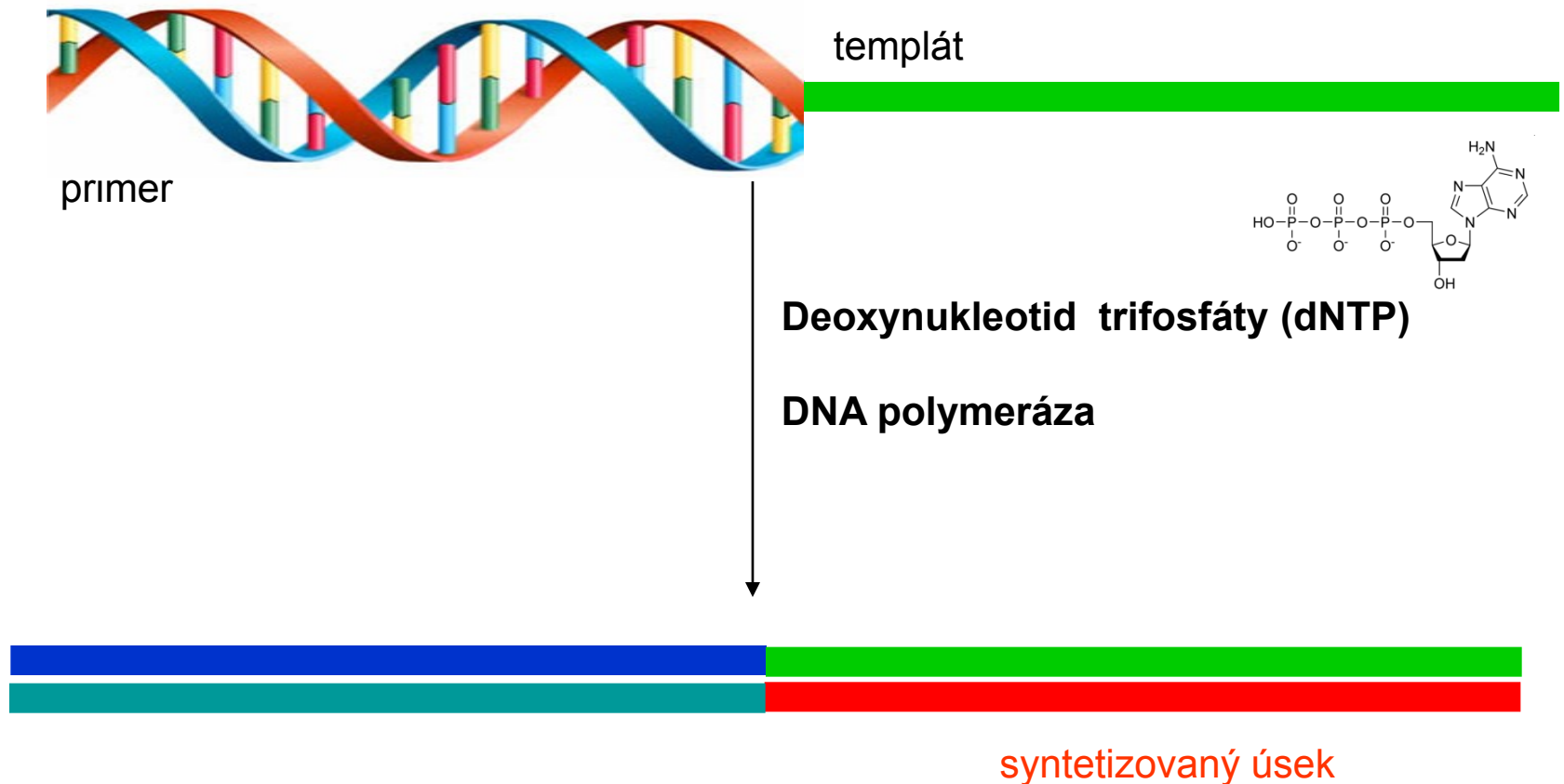

vložení značek do DNA pomocí DNA polymeráz

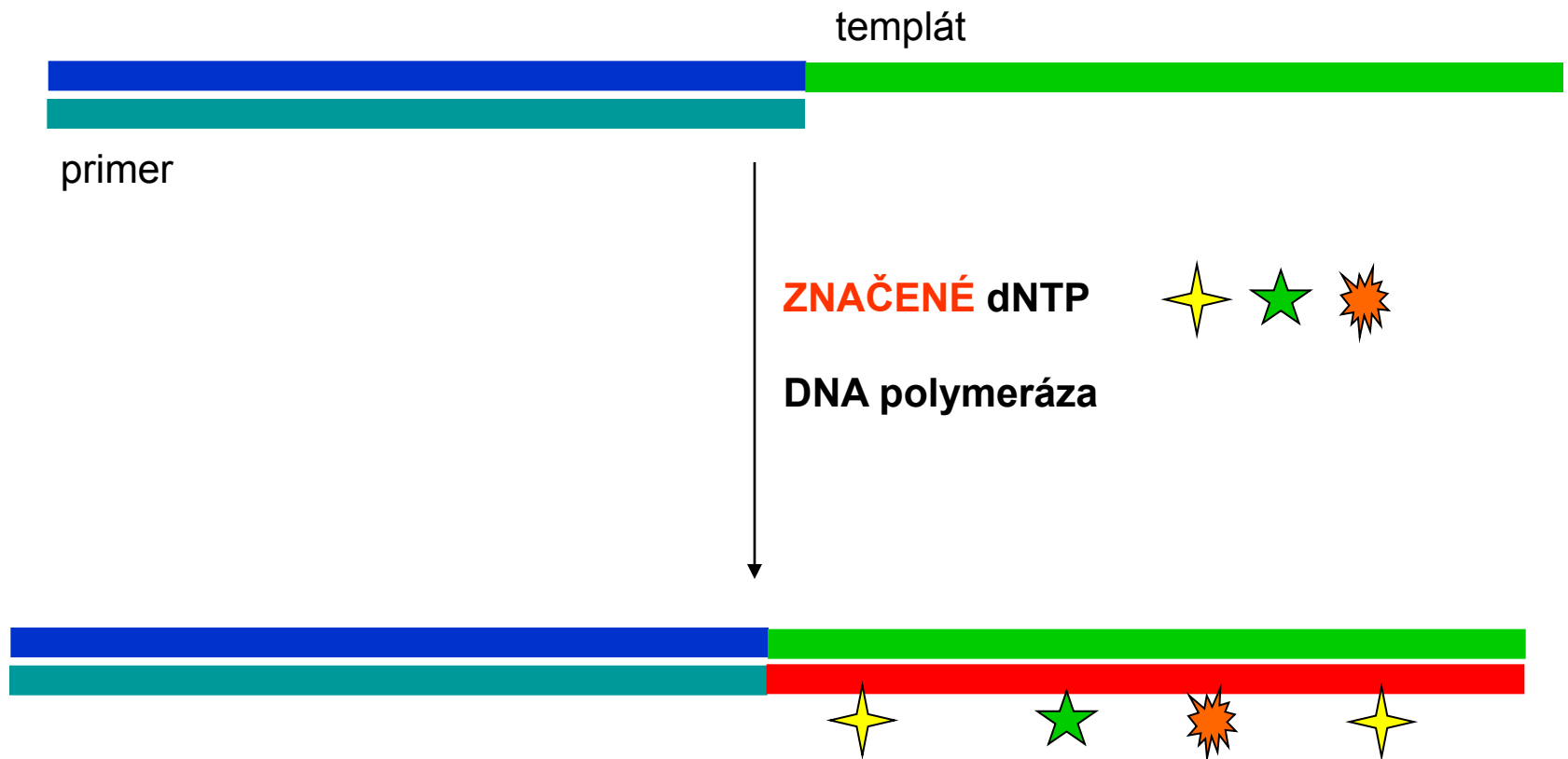

vložení značek do DNA pomocí DNA polymeráz

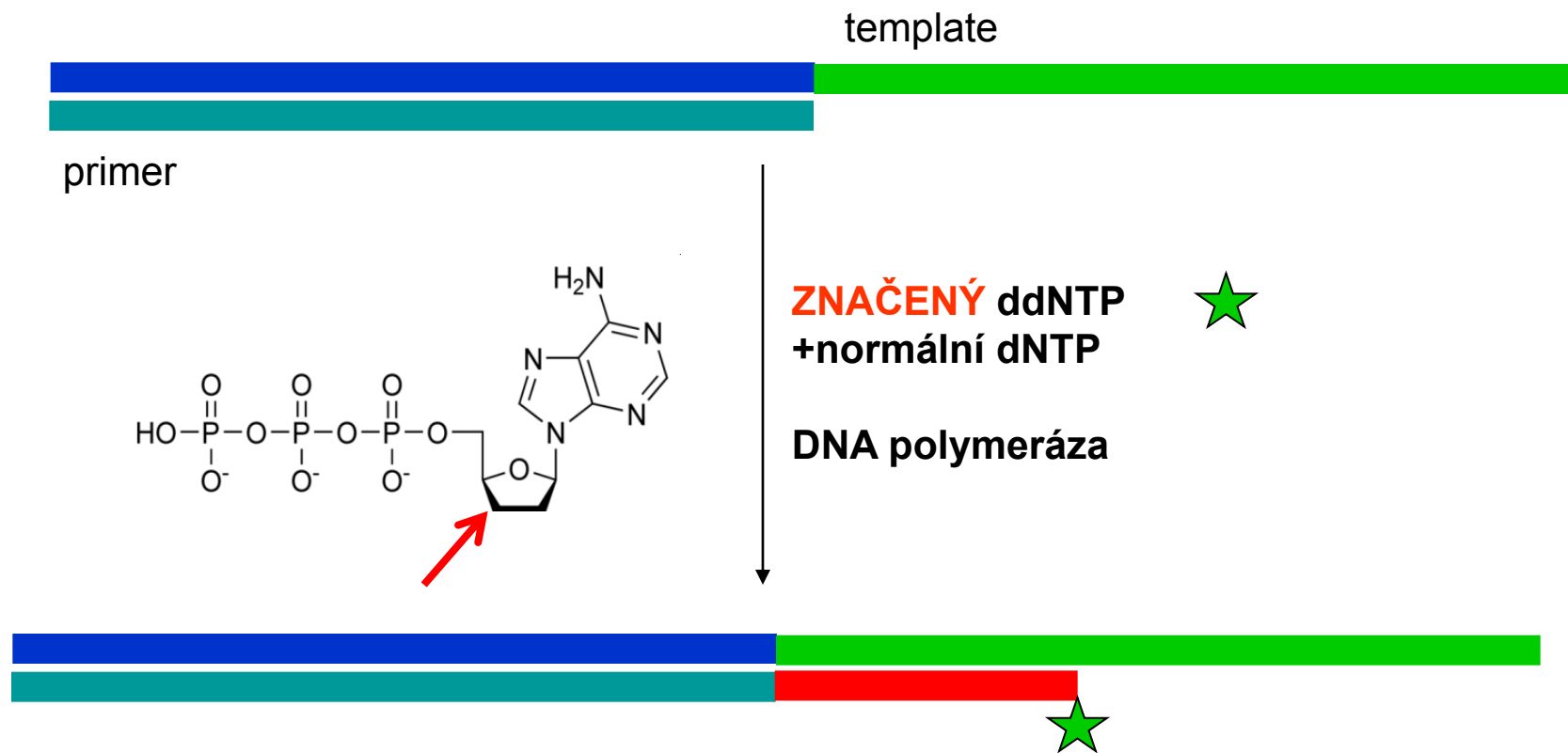

značení a sekvenování DNA

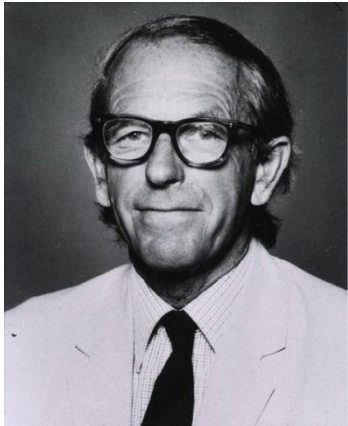

F. Sanger

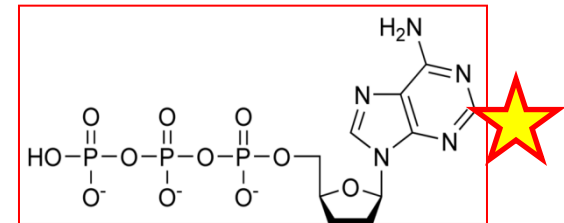
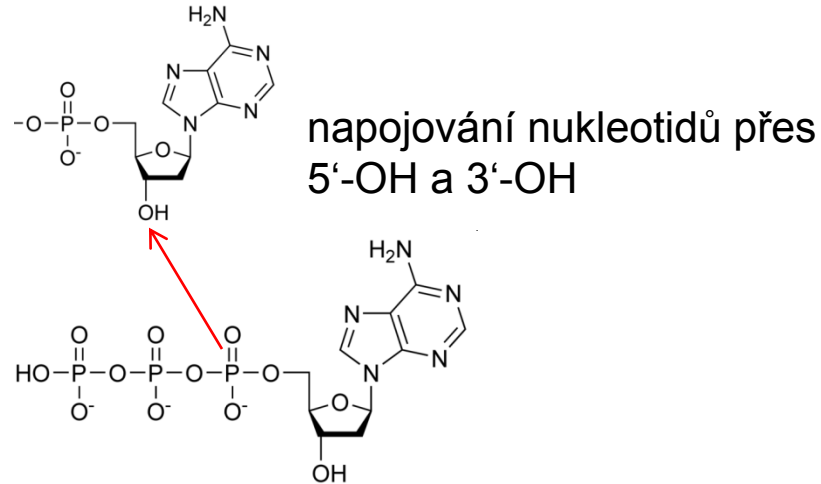

značené dideoxy:
navázání značky podle
komplementární báze

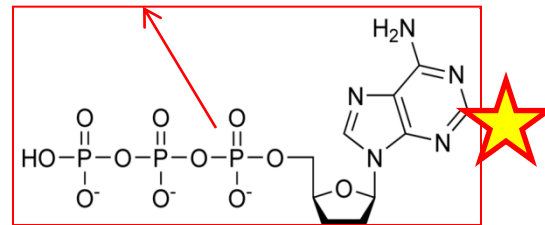

2',3'-dideoxynukleotidy:
terminátory syntézy DNA (není
kam napojit další nukleotid)

značení a sekvenování DNA

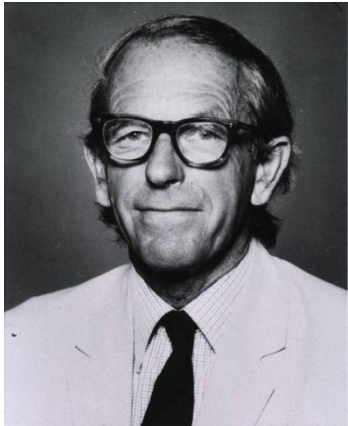

F. Sanger

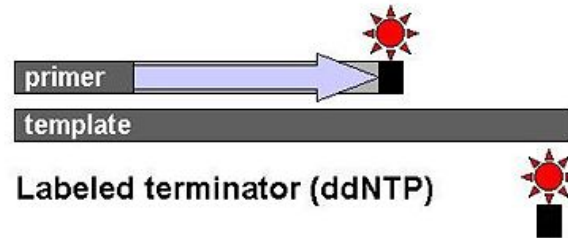

-směs normálních deoxy
a značených dideoxy

-pro každou bázi jiná barva

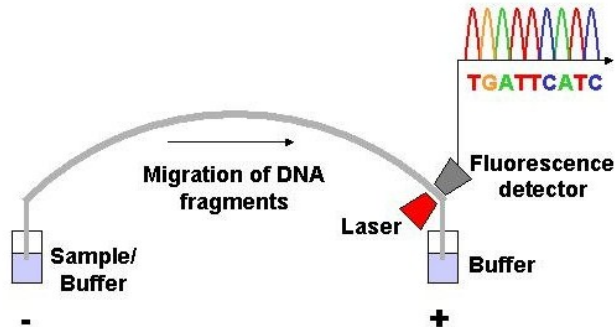

-různě dlouhé produkty,
dělení elektroforézou

-značka (barva) odpovídá
koncové bázi

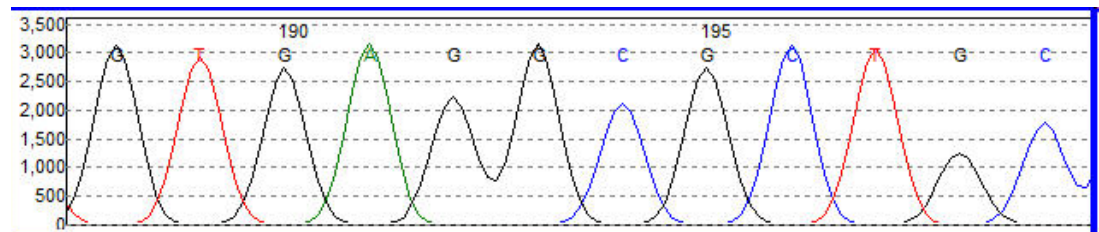

T4 polynucleotidyl kinase:

- transfer of γ -phosphate from ATP to 5'-OH end of DNA/RNA
- 5'-end labelling

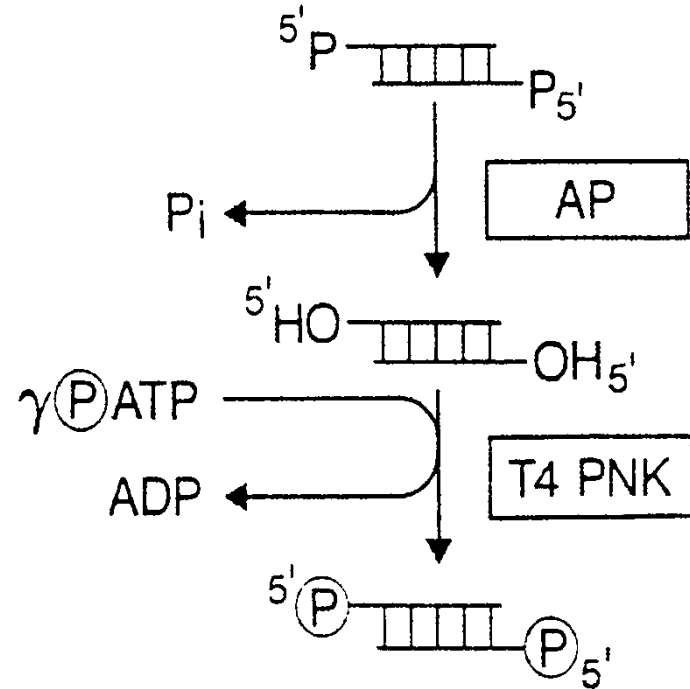
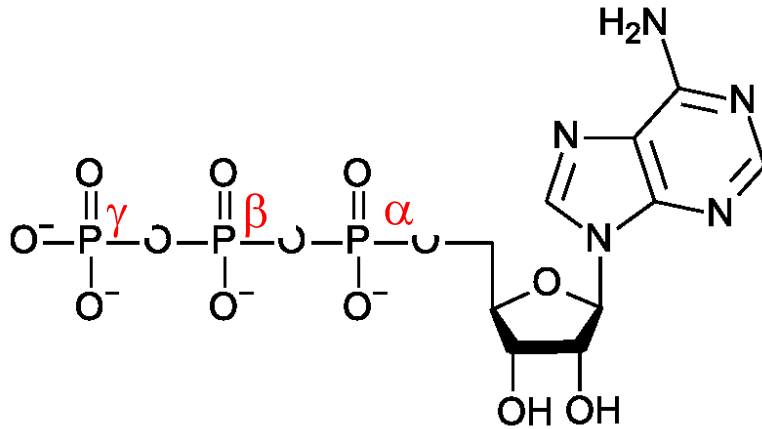

Alkaline phosphatase (AP):

- 5'-phosphate removal
(restrictases and other DNases produce 5'-phosphate)
- prevention of vector/insert self-ligation
- bacterial alkaline phosphatase (BAP)
- calf intestinal phosphatase (CIF)

SUMMARY REMARKS TO DNA LABELING

- **5'-labeling: polynucleotidyl kinase + ATP** (γ -phosphate is used)
- ^{32}P , ^{33}P , ^{35}S (as thiophosphate); thiol-reactive labels

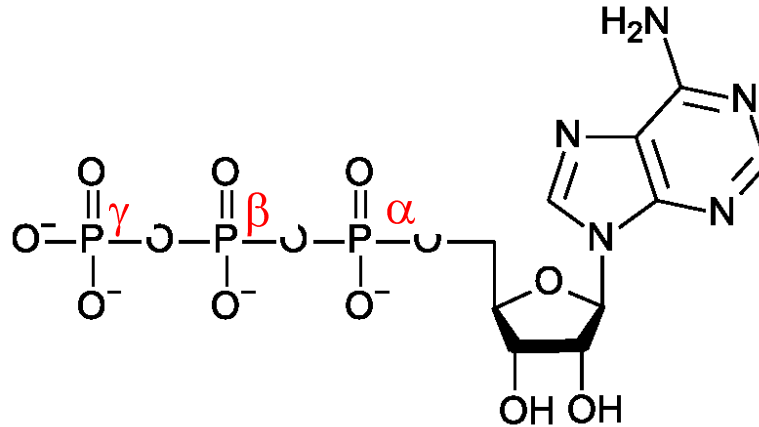

- **3'-end labeling: DNA-polymerases or terminal transferase (TnT, TdT)** (nucleotide including α -phosphate is used)
- any labels attached to sugar or base
- nick translation, random priming, PCR

DNA POLYMERASES

Thermostable DNA polymerases:

Taq DNA polymerase (*Thermus aquaticus*)
temperature optimum 72 – 80 °C

DyNAzyme, Vent, KOD... exo+/-....

fidelity *versus* speed *versus* tolerance to modifications

Polymerase chain reaction - PCR

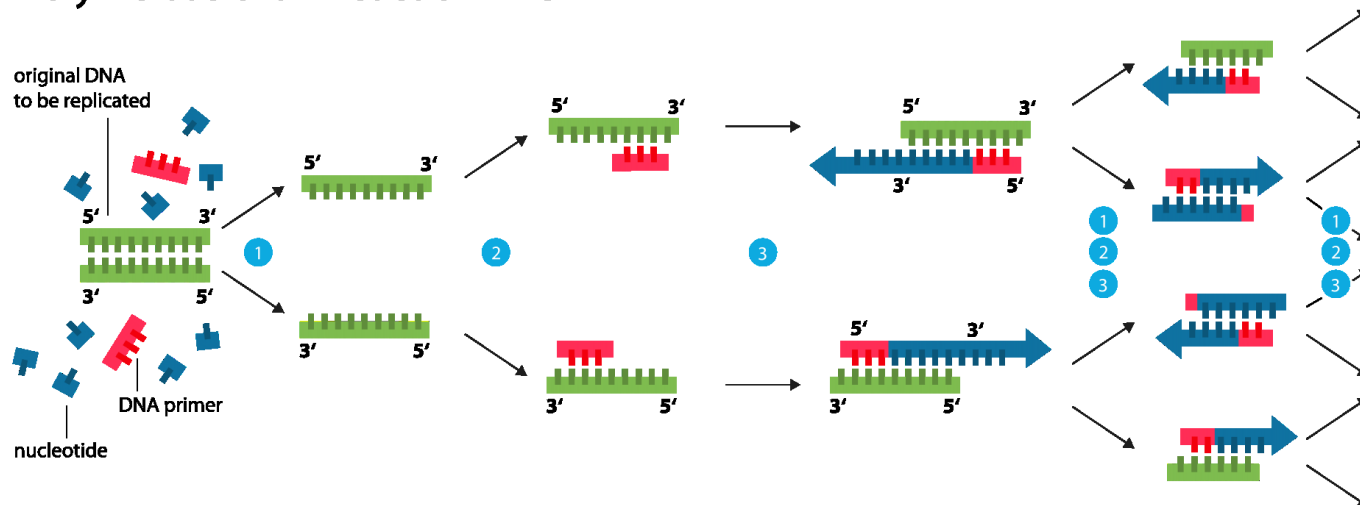

- 1 Denaturation at 94-96°C
- 2 Annealing at ~68°C
- 3 Elongation at ca. 72 °C

Reverse transcriptase

RNA-dependent DNA polymerase

MuLV (Moloney murine leukemia virus) }
AMV (avian myeloblastosis virus) } 37 – 42 C

„SuperScript“: higher temperatures
no RNaseH activity

(RNaseH: exonucleolytic degradation of RNA strand in DNA/RNA hybrid)

RT-(q)PCR analysis of gene expression

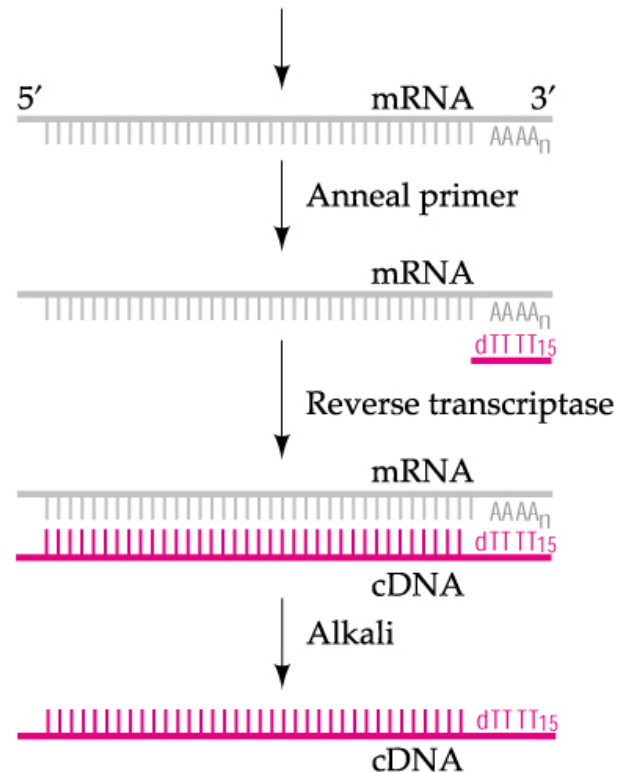

DNA ligases

Bacteriophage T4 DNA ligase:
 joining of sticky as well as blunt end
 cofactor = ATP

E. coli DNA ligase:
 joins sticky ends
 bacterial ligases usually use NAD as the cofactor

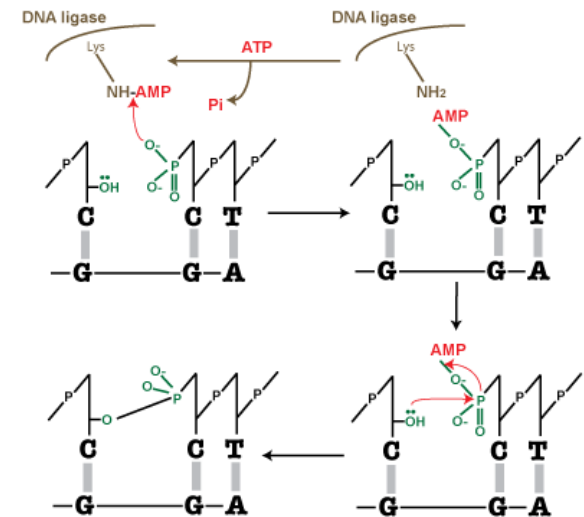
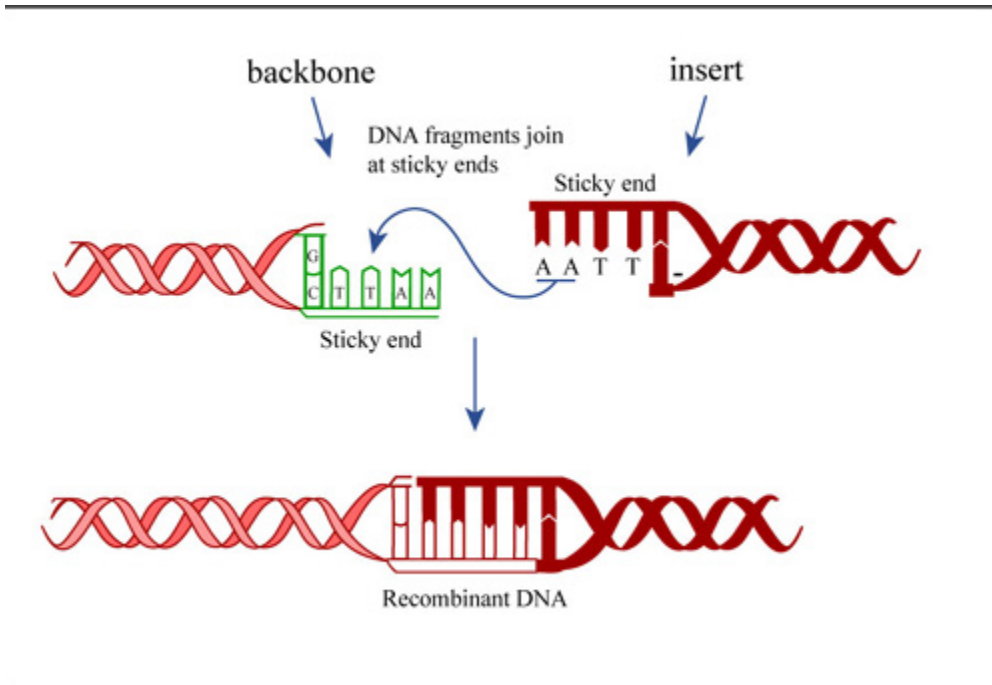
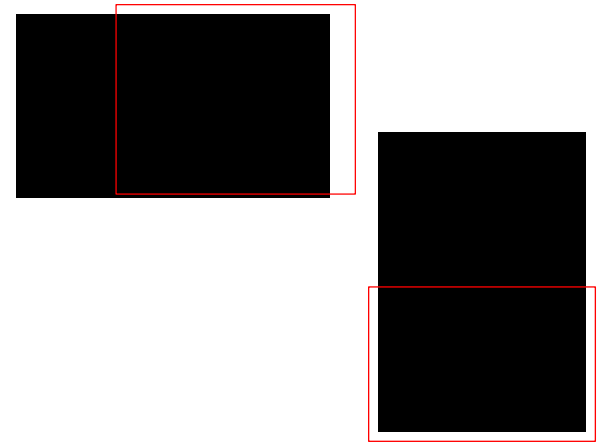

1. step: transfer of APM to **5'-phospho**
 DNA end (the intermediate involves a
 diphosphate macroergic bond)

SINGLE STRAND SELECTIVE NUCLEASES

In general: cleavage of both DNA and RNA

Nuclease S1: endo- and exonuclease

acidic pH optimum (4.5), Zn^{2+} ions

-removal of ss overhangs, opening of hairpin loops

-open local structures

Mung Bean Nuclease:

-similar to S1, milder conditions (less acidic)

Nuclease P1:

-neutral pH optimum, Zn^{2+} ions

-ss-selective endonuclease + 3'phosphatase

- ^{32}P postlabeling analysis of DNA adducts

Micrococcal nuclease (MNase)

-selective cleavage of untwisted DNA; AT-rich

-chromatin digestion to (oligo)nucleosomes

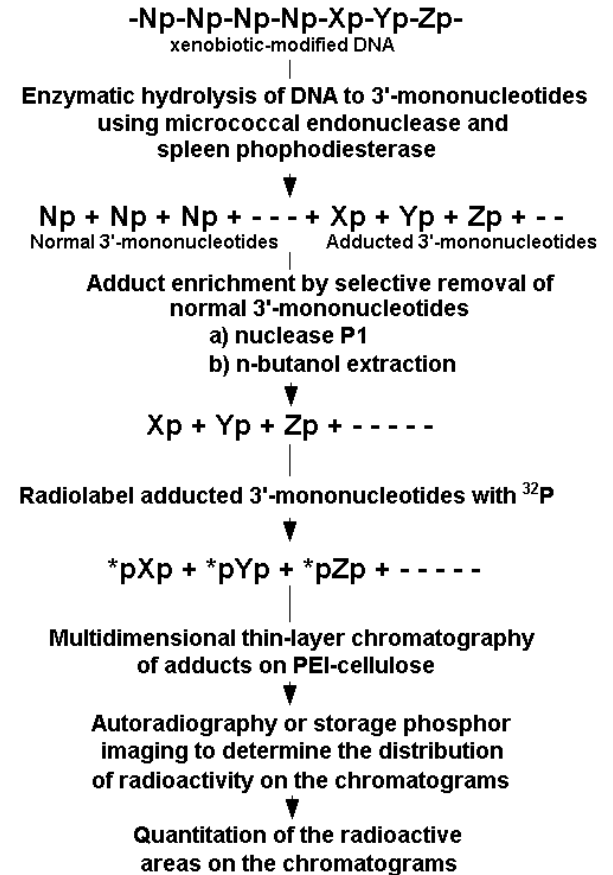

SINGLE STRAND SELECTIVE NUCLEASES

In general: cleavage of both DNA and RNA

Nuclease S1: endo- and exonuclease

acidic pH optimum (4.5), Zn^{2+} ions

-removal of ss overhangs, opening of hairpin loops

-open local structures

Mung Bean Nuclease:

-similar to S1, milder conditions (less acidic)

Nuclease P1:

-neutral pH optimum, Zn^{2+} ions

-ss-selective endonuclease + 3'phosphatase

- ^{32}P postlabeling analysis of DNA adducts

Micrococcal nuclease (MNase)

-selective cleavage of untwisted DNA; AT-rich

-chromatin digestion to (oligo)nucleosomes

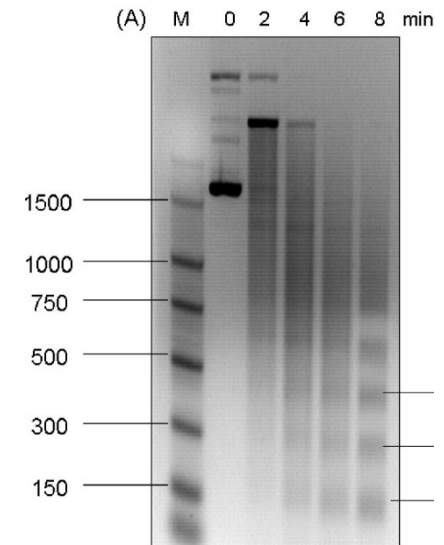
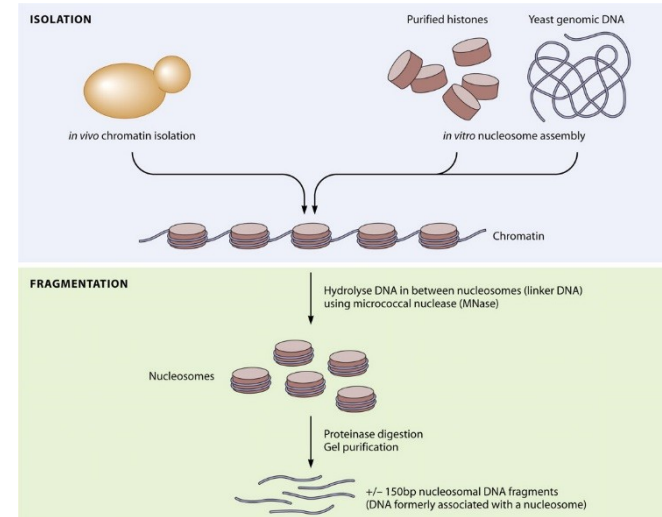

Single-strand selective enzymes

- only detection of a open structure, not identification at the sequence level
- often sufficient: evidence of formation of a expected structure
- nucleases S1, P1, mung bean... cleave ss DNA (or RNA)
- scDNA cleaved by S1, then restriction cleavage to map S1 cleavage site

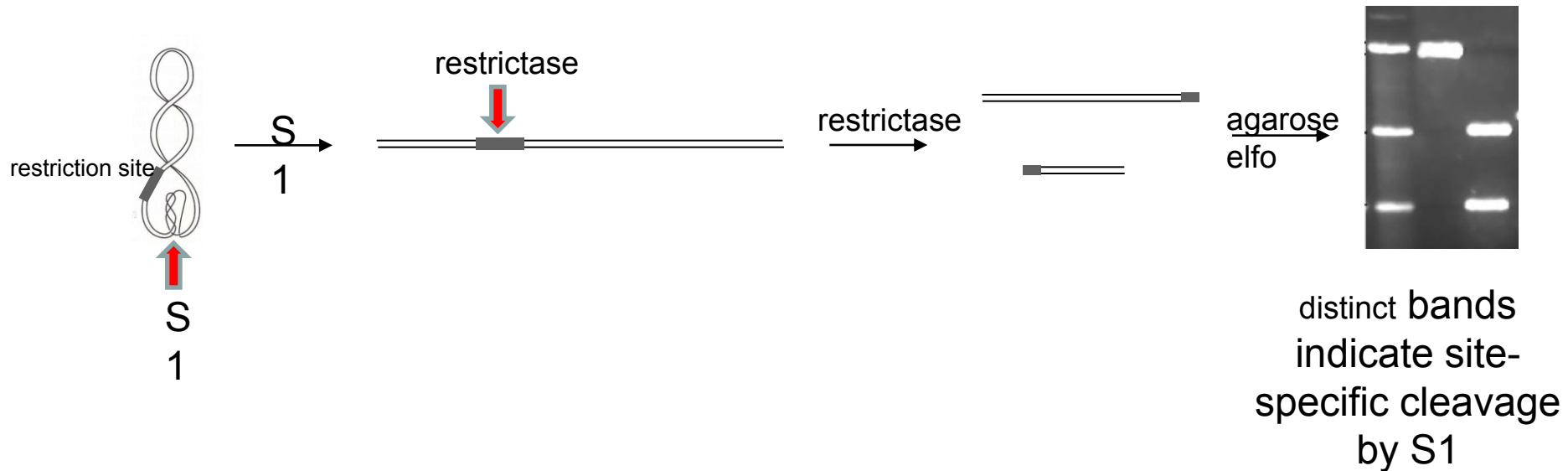

Combination of chemical probes with S1 nuclease

- chemical probes work within wider range of conditions than enzymes
- modification of scDNA
- then restrictase cleavage
- chemical modification of bases in structure that existed in scDNA prevent formation of B-DNA
- then S1 cleavage in the modified site

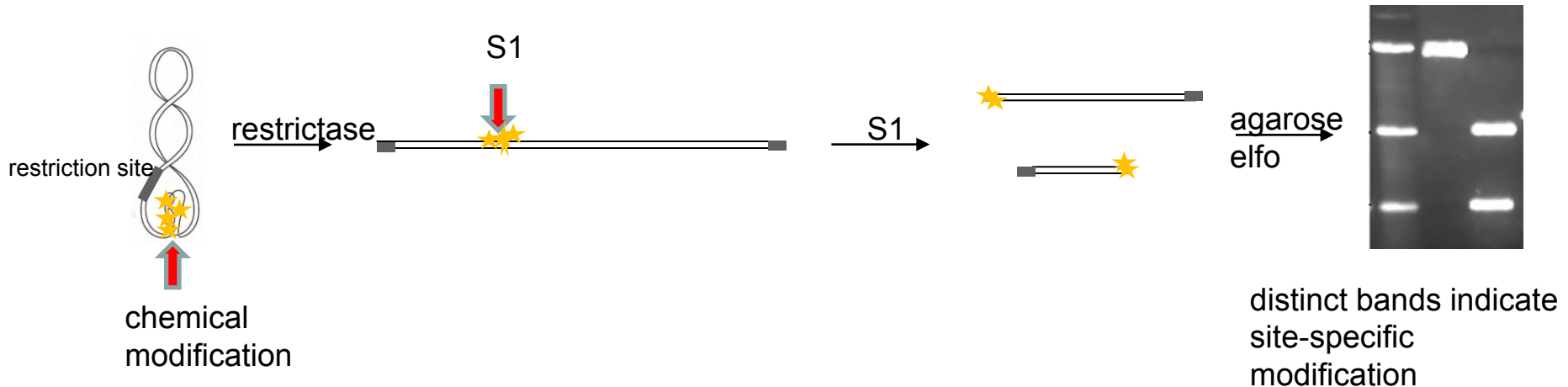

NUCLEASES PROCESSING DNA ENDS

- Bal31 nuclease:** cleaves both 3' and 5' ends in dsDNA
- removal of ss overhangs, cleavage in nicks and gaps
 - shortens blunt-ended dsDNA
 - identification of terminal DNA sequences

- Exonuclease III:** degrades one strand in dsDNA (RNA strand in RN/DNA hybrid) from its 3'-terminus
- creates 5'-overhangs

- Lambda exonuclease:** degrades one strand in dsDNA from its 5'-terminus
- creates 3'-overhangs

(a) Bal31

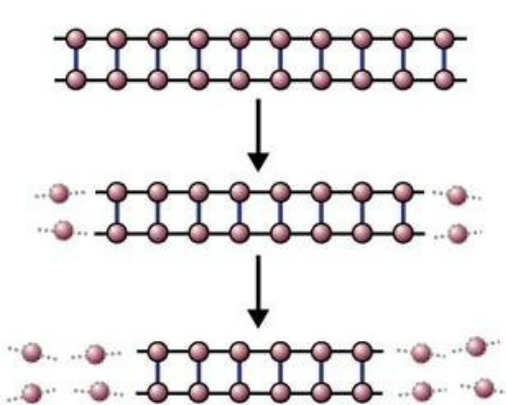

(b) Exonuclease III

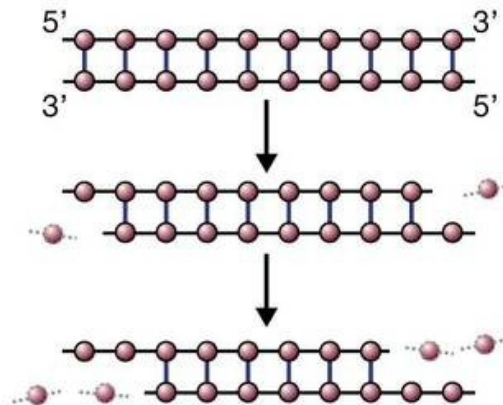

(c) Lambda-exonuclease

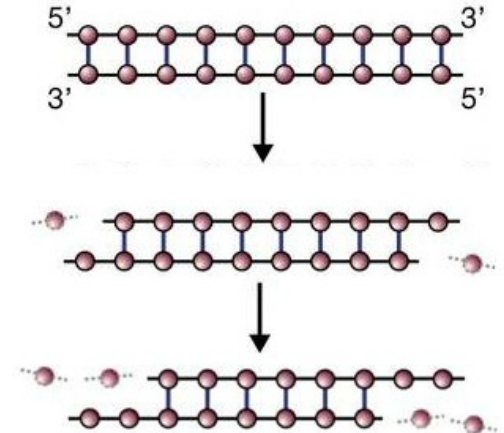

PHOSPHODIESTERASES

DNA/RNA exonucleases

Phosphodiesterase I

from snake venom
cleaves $3' \rightarrow 5'$
requires $3'$ -OH
produces $5'$ -dNMP

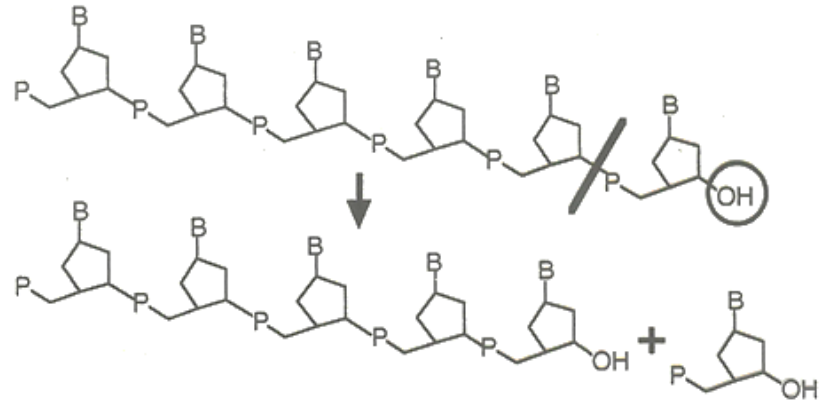

Phosphodiesterase II

from spleen
cleaves $5' \rightarrow 3'$
requires $5'$ -OH
produces $3'$ -dNMP

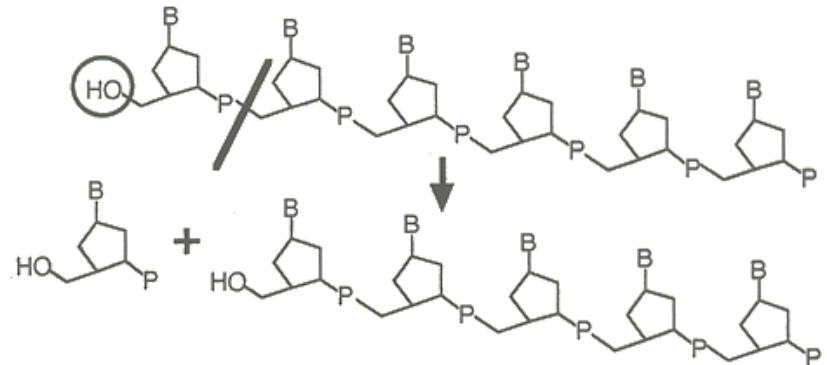

RNase A:

endoribonuclease

cleaves preferentially ssRNA „after“ Py, produce 3'-phospho ends extremely stable, no cofactors, difficult to inactivate

DNA purification (RNA removal)

SNP mapping in DNA (RNase protection assay)

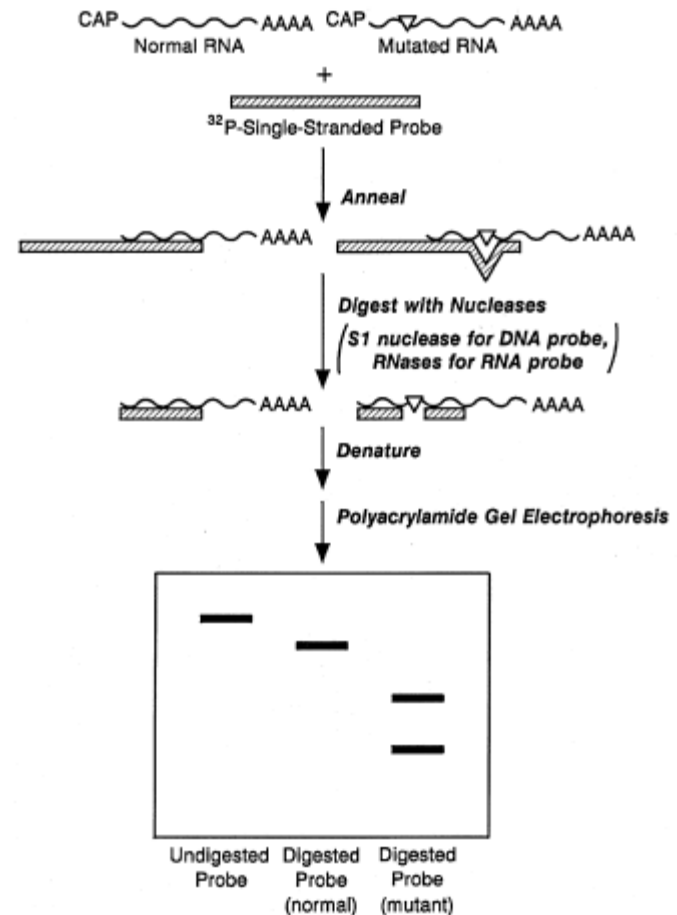
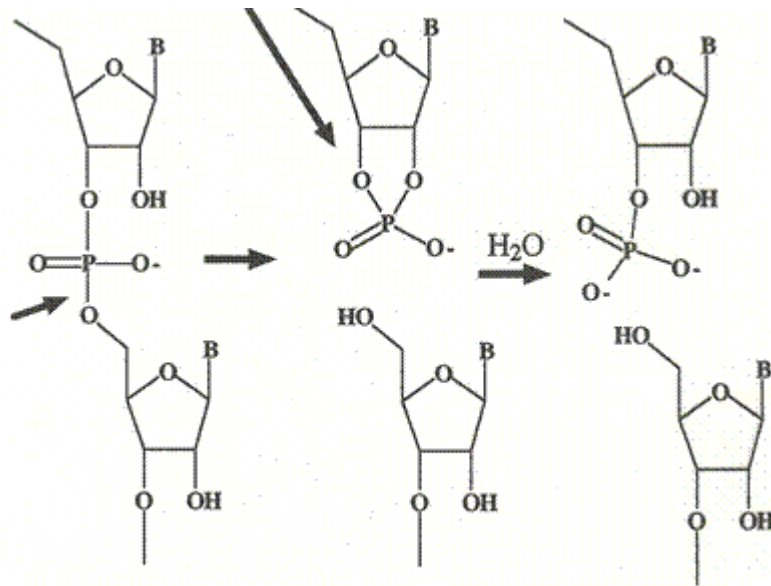

DNase I: DNA endonuclease

cleavage of dsDNA or ssDNA to ~tetranucleotides

requires Mg^{2+} (inhibition by EDTA), neutral pH optimum

reductive inactivation (-S-S- bond stabilize structure), Ca^{2+} protection

in dsDNA creates single-strand breaks, 5'-phospho ends

RNA purification (RNase-free!!), protein-DNA footprinting

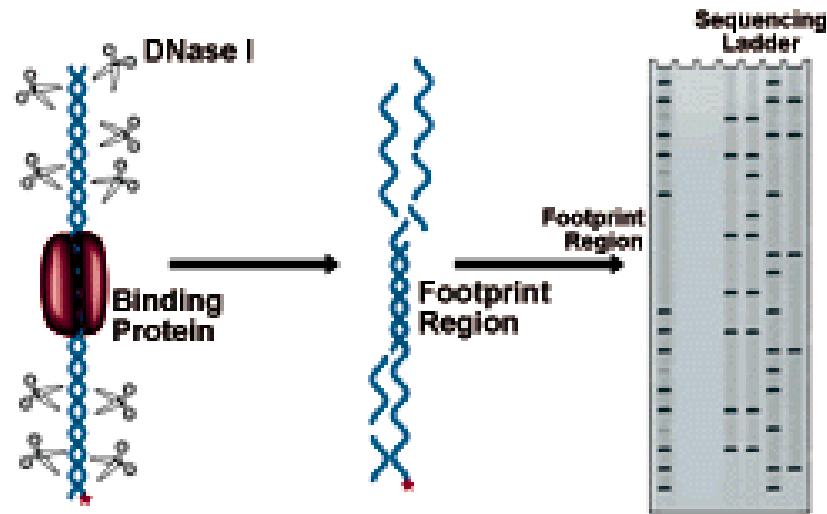

DNase II: double strand breaks, 3'-phospho ends, no cofactors, acidic pH optimum

Polynucleotide phosphorylase

- random polymerization of ribonucleotides from NDPs
- RNA degradation by inorganic phosphate (not hydrolysis) into NDP
- reversible
- polyribonucleotide biosynthesis
- used during genetic code solution

Phosphorylase does not phosphorylate!

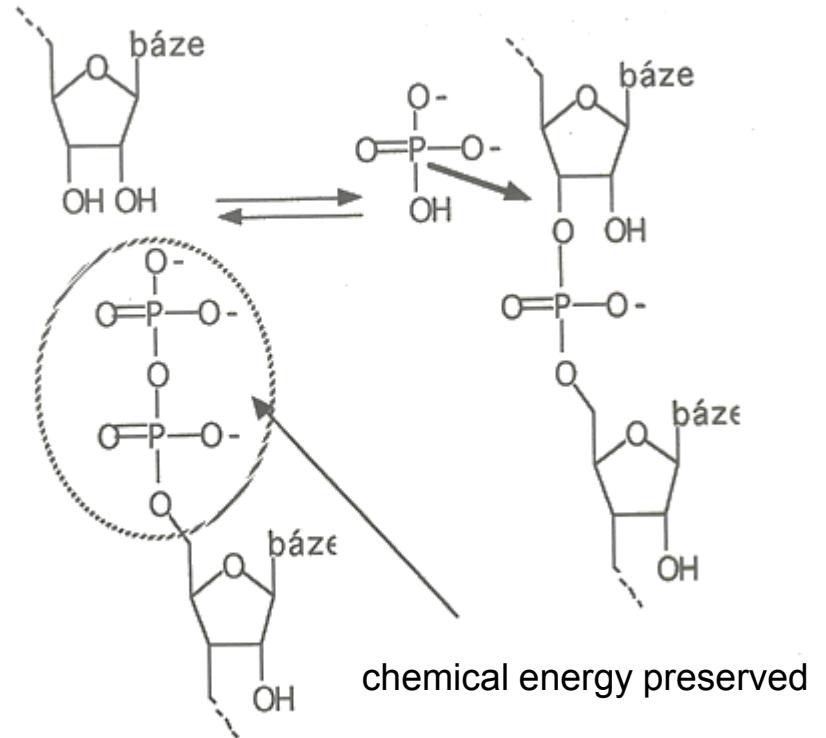

Engineered nucleases for genome editing

ZNF, TALEN

-constructs of a nuclease (fok I) with DNA binding domains (addressing cleavage to a specific sequence)

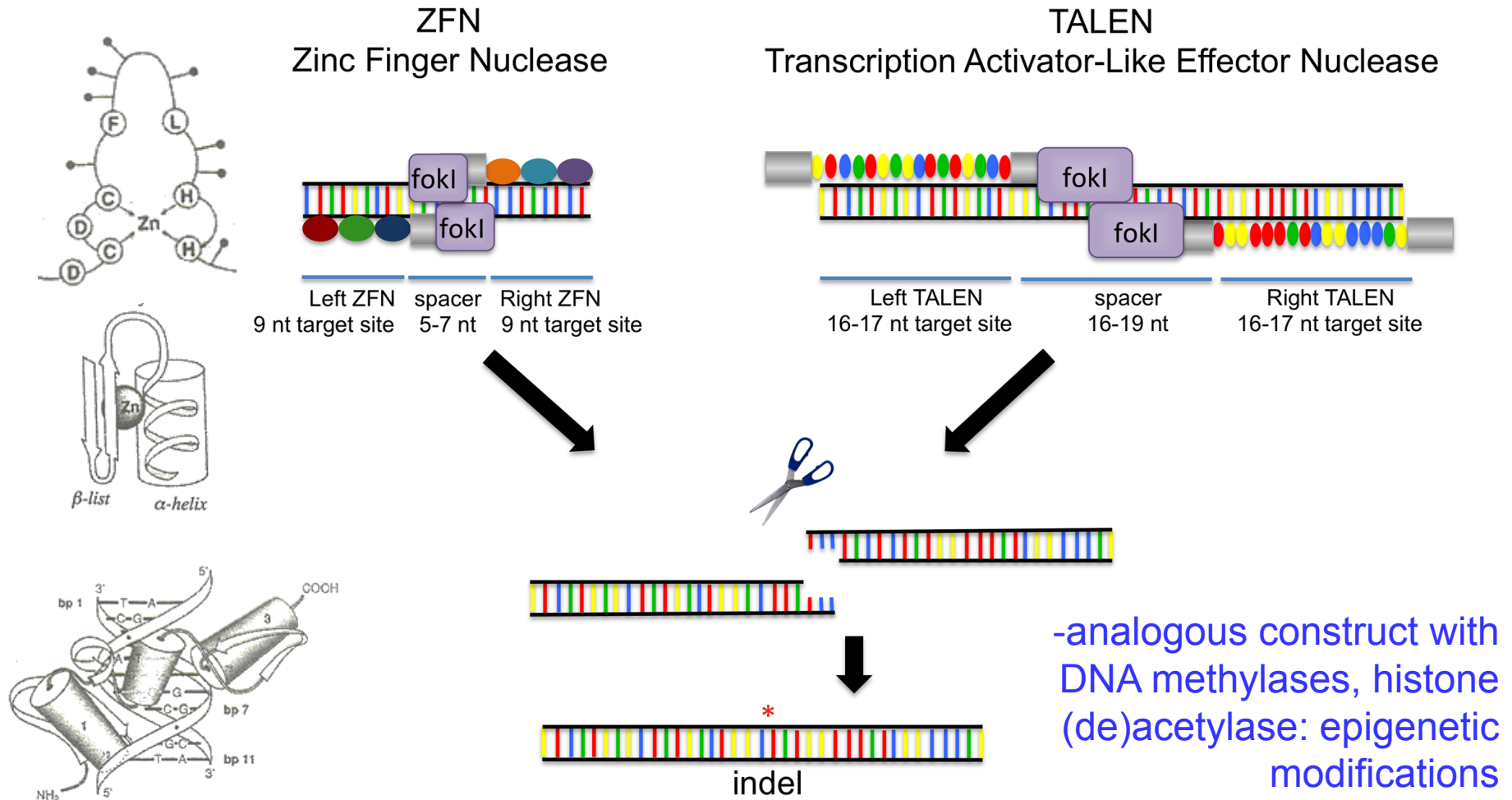

CRISPR-Cas9

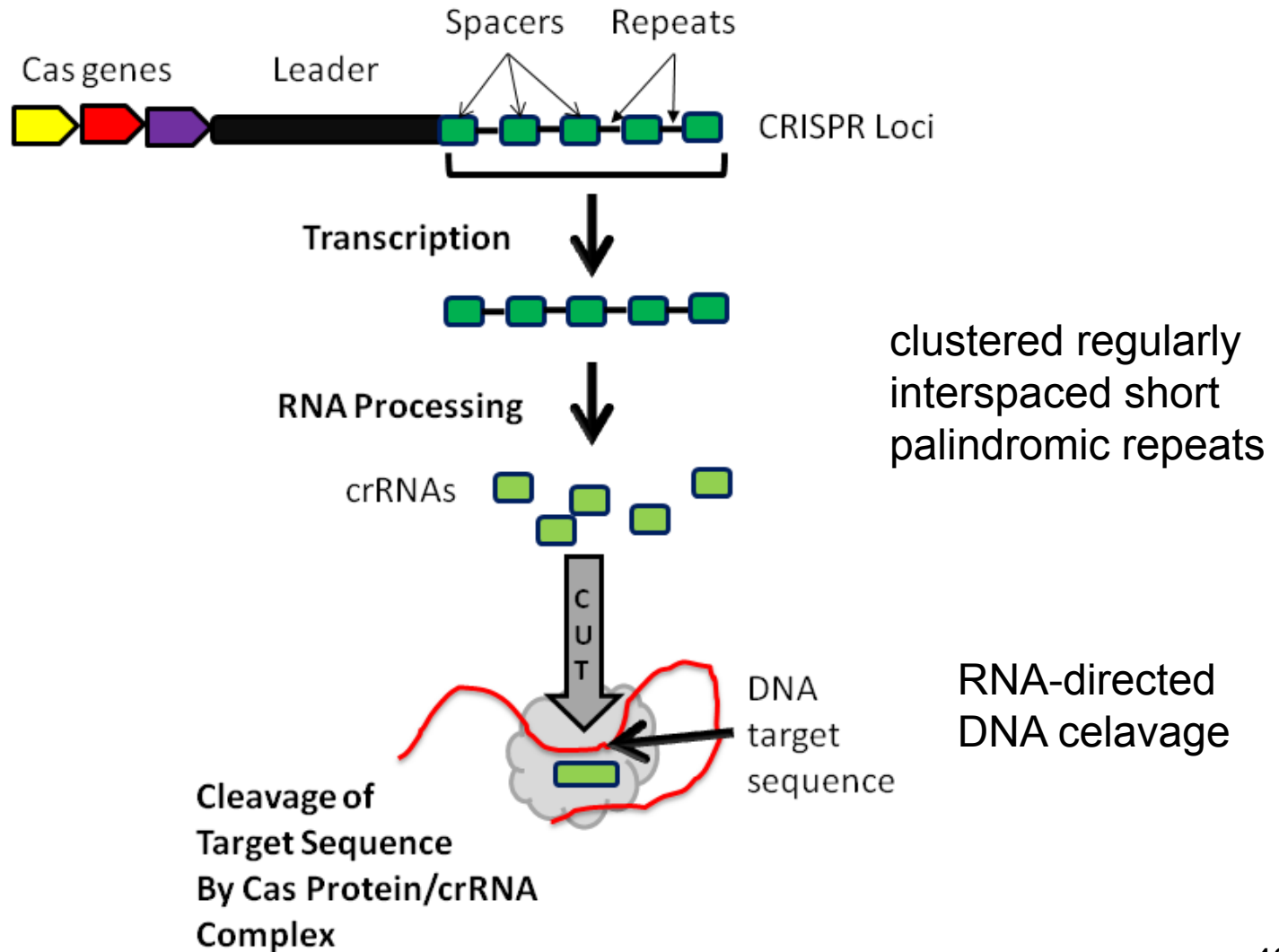

Modifications of genomes

Repair of the (ZNF, TALEN, CRISPR-induced) double strand breaks via NHJ or HR:

-insertions, deletions – gene inactivation

-inversions

-transgene insertions, modifications of genes (precise by HR)

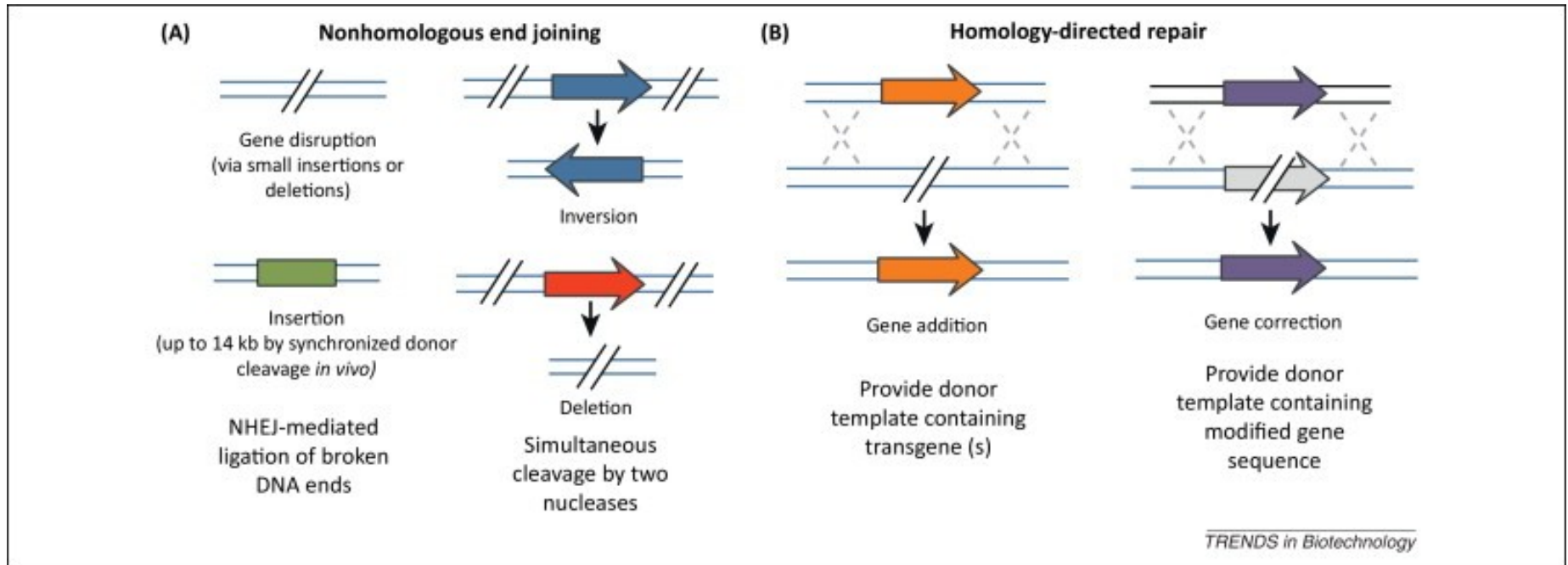

Gaj et al. Trends Biotechnol 2013



<http://worldofbiochemistry.blogspot.cz/2011/08/cartoon-about-cloning-2.html>