

Analýza nekódujících RNA, microRNA

Doc. MUDr. Mgr. Marek Mráz, PhD
Vedoucí laboratoře
CEITEC MU a FN Brno

- Nic si nepište...vše bude online

Regulační RNA : >75% genomu je transkribováno do RNA

>200.000 lncRNA genes

> 200 nucleotides in length

- Transcription regulation
- Chromatin interactions
- Organizing nuclear domains
- RNA binding and regulation

~2500 miRNA genes

~22 nucleotides

- Inhibition of mRNA translation and stability

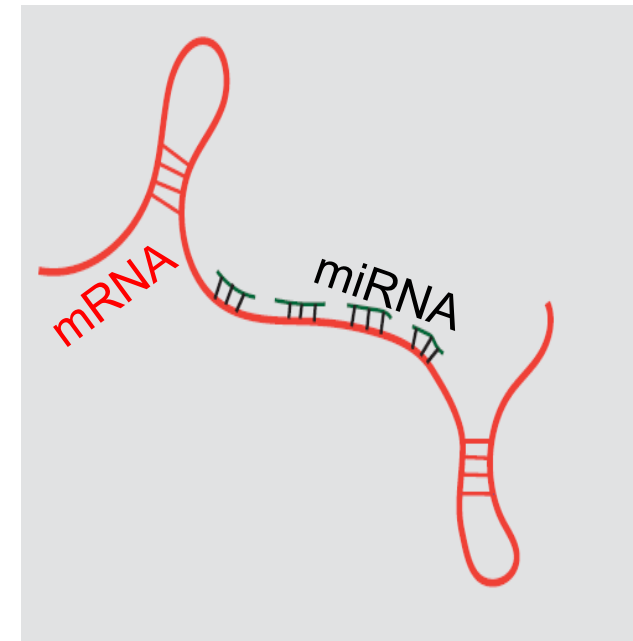
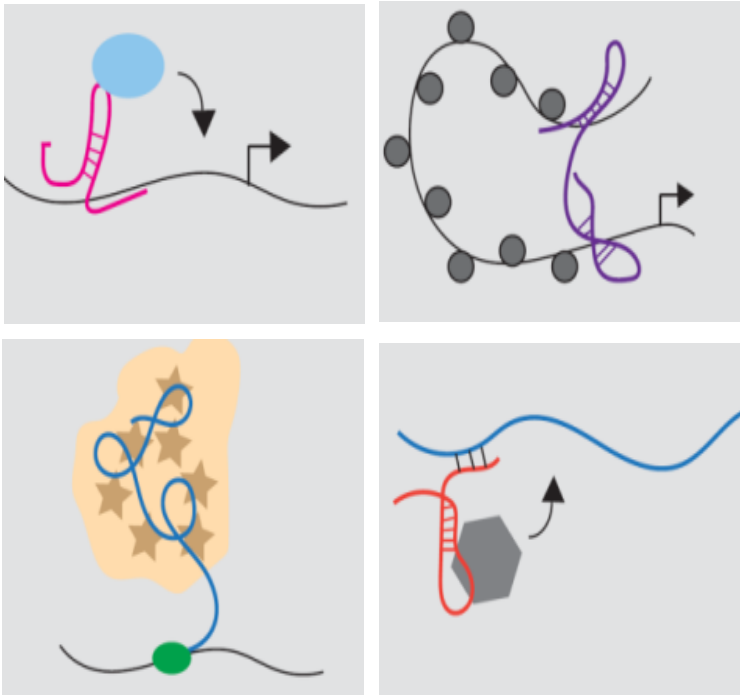

- Lidské miRNA geny: **cca 2000**

microRNA (miRNA)

- ❑ krátké RNA molekuly
~22 nukleotidů
- ❑ komplementární vazba k
cílové mRNA
- ❑ inhibují translaci a snižují
stabilitu mRNA



**Stovky evolučně
konzervovaných microRNA**

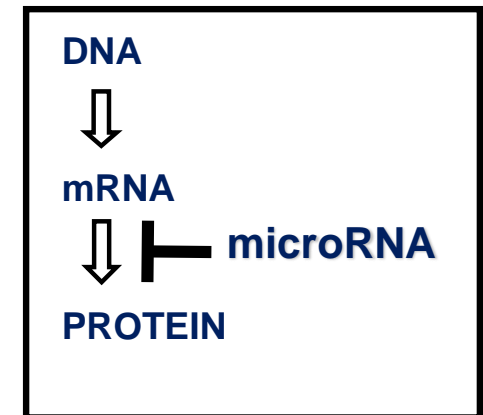
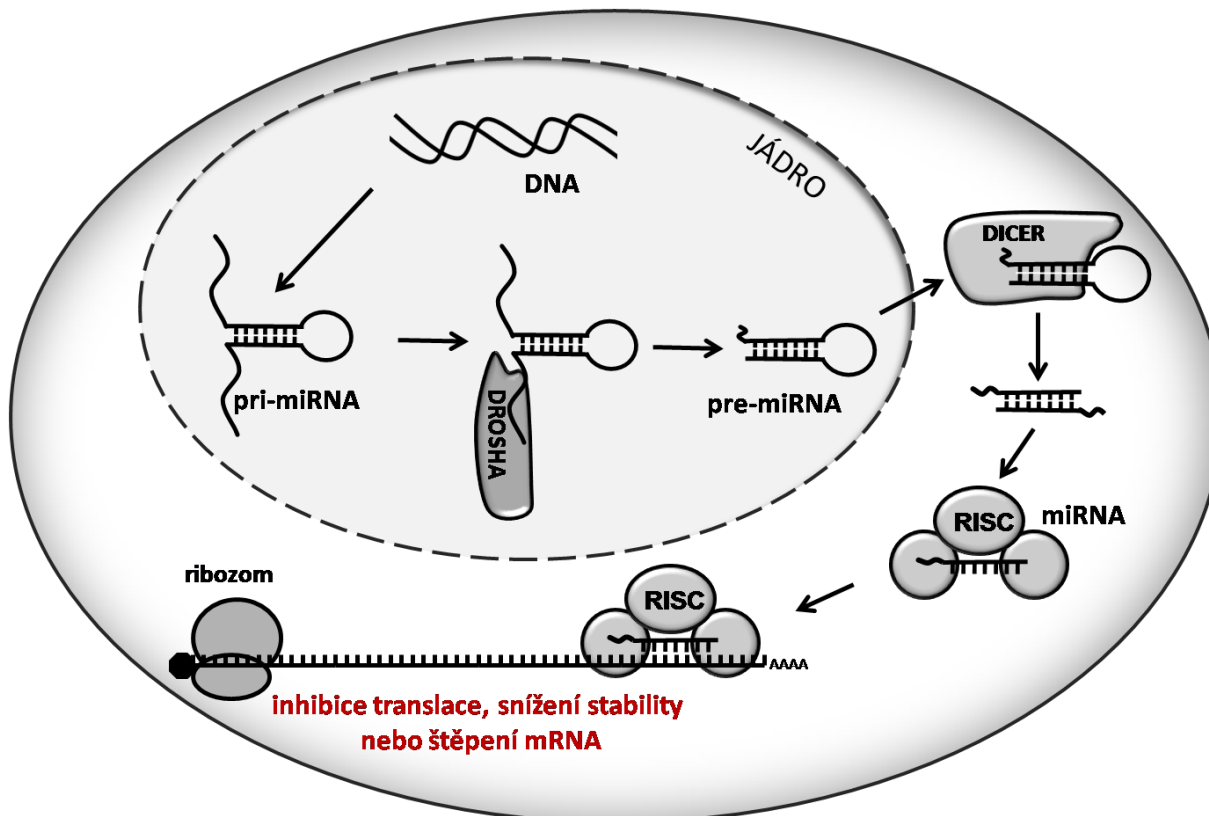

MicroRNAs were discovered by V. Ambros and G. Ruvkun in *C. elegans*

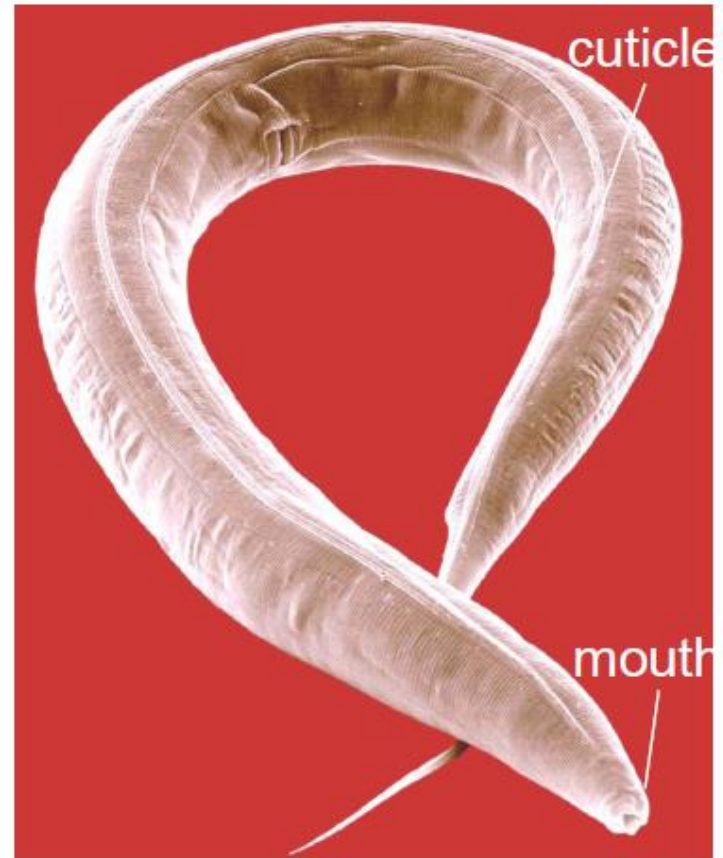
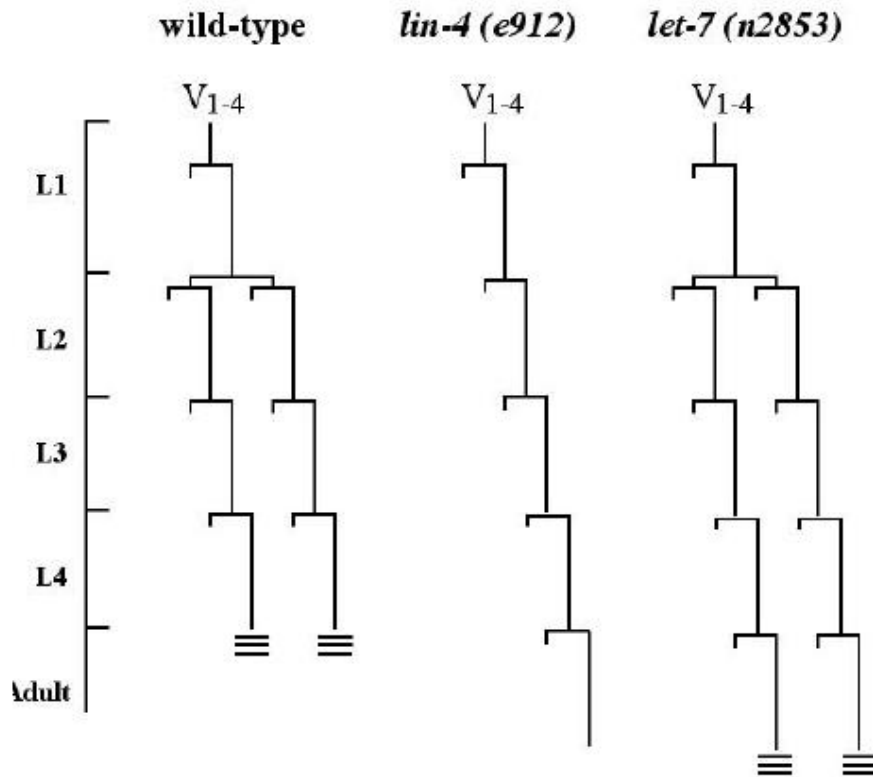

Lee et al. 1993 *Cell*

Reinhart et al. 2000 *Nature*

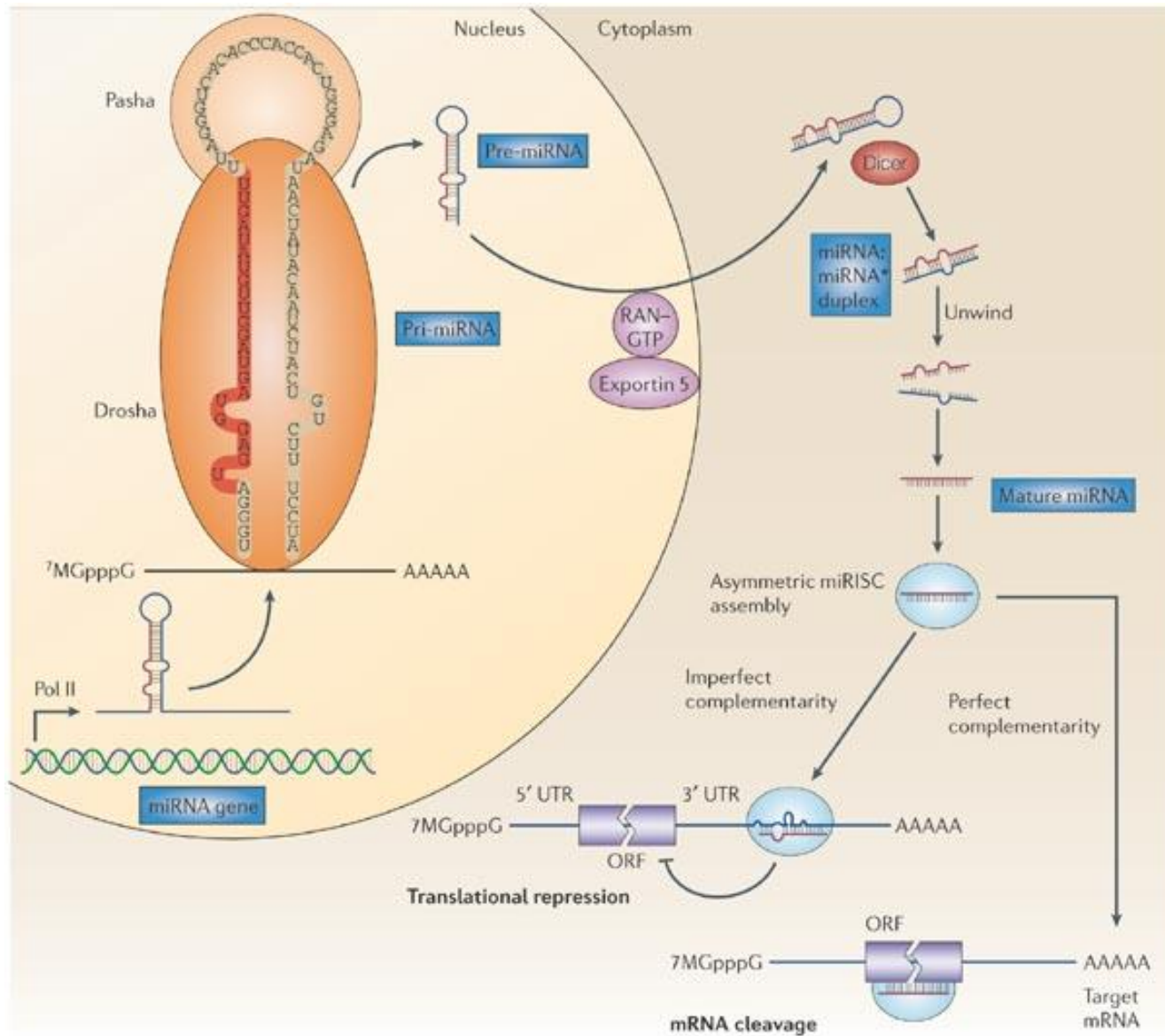

Genomic Organization of miRNA Genes

(a) Independent promoter

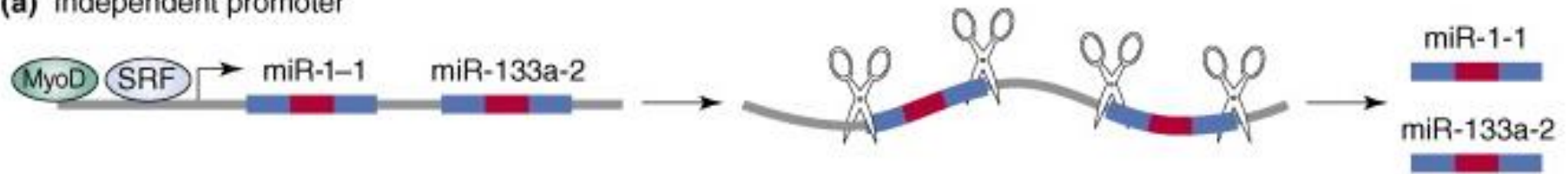

(b) Intronic



(c) Exonic



- Intronic miRNAs often in antisense direction, made from own promoter

- Exonic miRNAs - non-coding (or in alternatively spliced exons)



miRBase

<http://www.mirbase.org/>

miRBase MANCHESTER

Home Search Browse Genomics Help Download Submit

miRBase has moved to <http://www.mirbase.org/> - please update your links.

News - release 14

The miRBase database has moved to a new location at <http://www.mirbase.org/>, hosted in the [Faculty of Life Sciences, University of Manchester](#). All pre-existing URLs should forward to their new locations. Please update your links, and note the new contact email address (mirbase@manchester.ac.uk).

With release 14, the miRBase sequence database has broken through the 10000 entries barrier!

miRNA count: 10883 entries
Release 14: Sept 2009

Search by miRNA name or keyword

Download published miRNA data
[Download page](#) | [FTP site](#)

This site is featured in:
[NetWatch - Science 303:1741 \(2004\)](#)
[Highlights, Web watch - Nature Reviews Genetics 5:244 \(2004\)](#)

miRBase: the microRNA database

miRBase provides the following services:

- The [miRBase database](#) is a searchable database of published miRNA sequences and annotation. Each entry in the miRBase Sequence database represents a predicted hairpin portion of a miRNA transcript (termed mir in the database), with information on the location and sequence of the mature miRNA sequence (termed miR). Both hairpin and mature sequences are available for [searching](#) and [browsing](#), and entries can also be retrieved by name, keyword, references and annotation. All sequence and annotation data are also [available for download](#).
- The [miRBase Registry](#) provides miRNA gene hunters with unique names for novel miRNA genes prior to publication of results. Visit the [help pages](#) for more information about the naming service.
- The miRBase Targets database and pipeline has been rebranded as [microCosm](#), and is now hosted at the [EBI](#). The microCosm resource continues to be maintained by the [Enright group](#). miRBase currently links miRNAs to targets predicted by microCosm, [TargetScan](#) and [Pictar](#), and aims to provide a more extensive target prediction aggregation service in the future.

To receive email notification of data updates and feature changes please subscribe to the [miRBase announcements mailing list](#). Any queries about the website or naming service should be directed at mirbase@manchester.ac.uk.

miRBase is hosted and maintained in the [Faculty of Life Sciences](#) at the [University of Manchester](#) with funding from the [BBSRC](#), and was previously hosted and supported by the [Wellcome Trust Sanger Institute](#).

miRNAs as Oncogenes and Tumor Suppressors

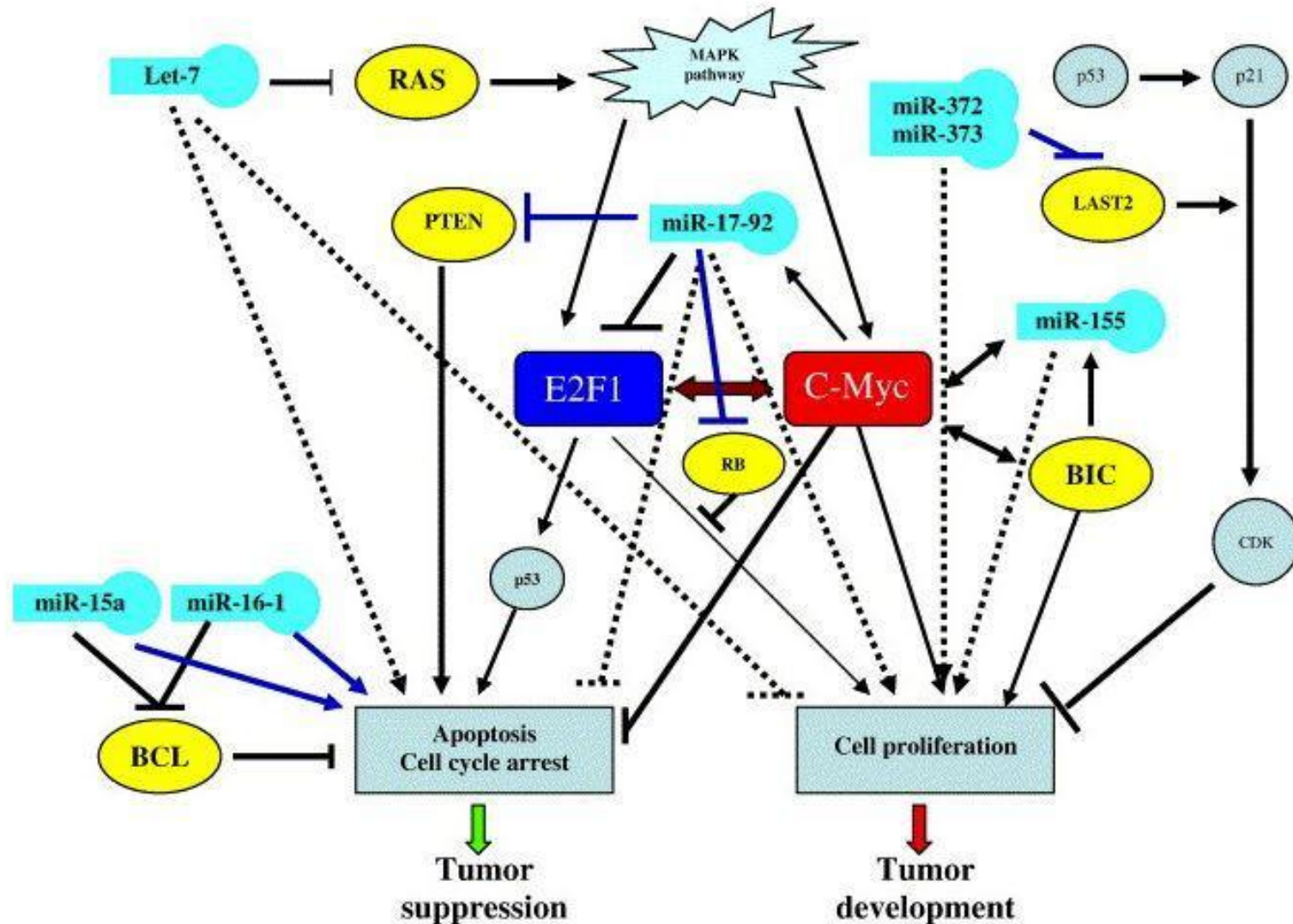

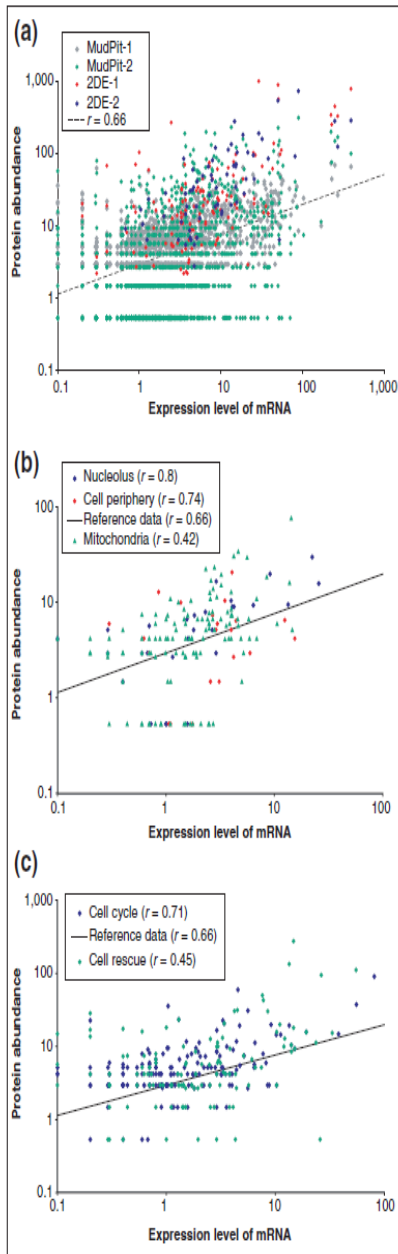

mRNA neznamená, že v buňce bude i protein

Historicky vždy velká neshoda mezi daty z expresních čipů a expresí proteinů (Western Blot)

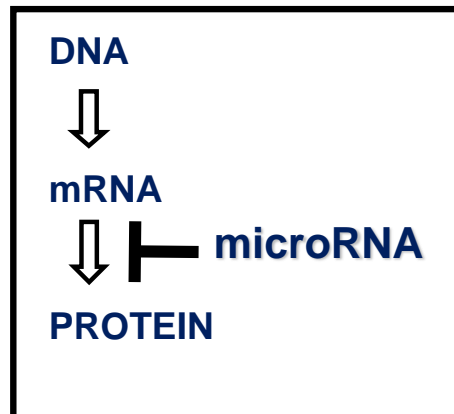

Specifika analýzy exprese microRNAs:

- velmi malé molekuly – 22nt – specifikum izolace, specifické značení i design sond
- malé zastoupení ve vzorku – separace microRNA
- v lidském genomu cca 2000 genů
- některé mají velmi podobnou sekvenci – rozdíl 1nt
- pre-miR, pri-miR, mature-miR
- málo se ví o jejich funkcích – obtížná interpretace výsledků
- zatím málo zkušeností a standardizace

Izolace

NGS

Real-Time PCR

Microarrays

1/ Izolace a stabilita microRNA

Problémy: velikost 22nt, celkově cca 0,01% z celkové RNA

Izolace:

TRizol/TriReagent
miRvana (Ambion)
PureLink (Invitrogen)
a další

Obohacení:

PAGE
FlashPAGE Fractionator
(Ambion)

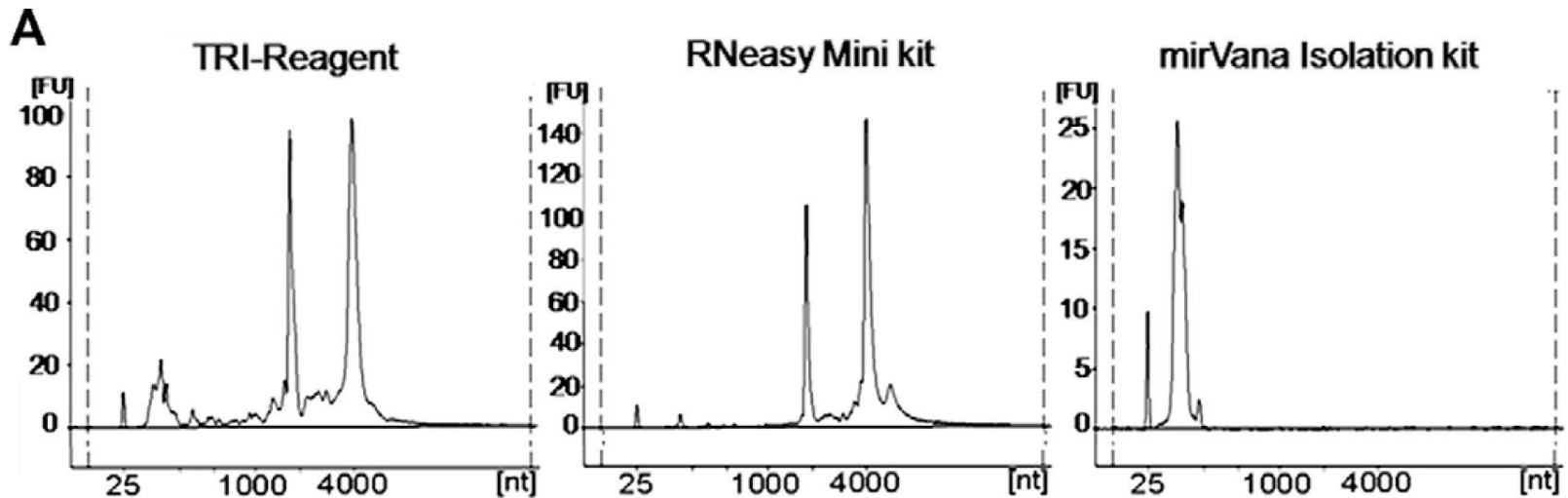

Mraz et al., 2009

Izolace:

TRIzol/TriReagent

miRvana (Ambion)

PureLink (Invitrogen)

a další

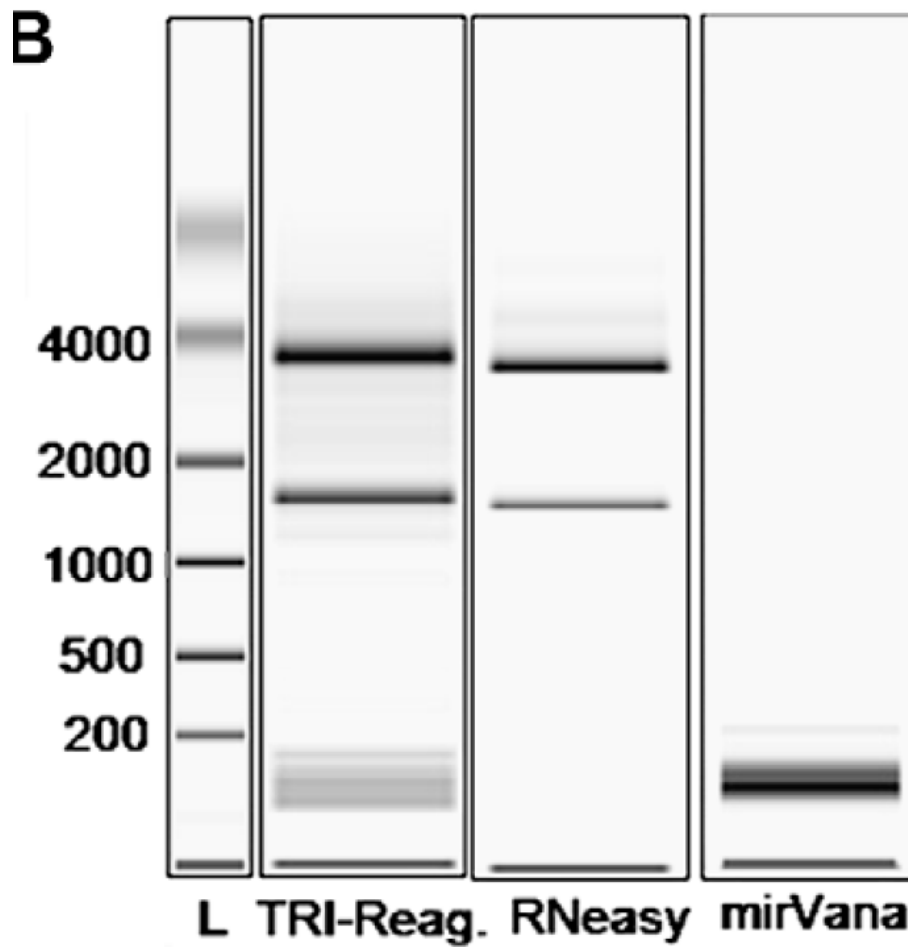

RT-PCR

Problems....?

TaqMan-based real-time PCR quantification of mature miRNAs

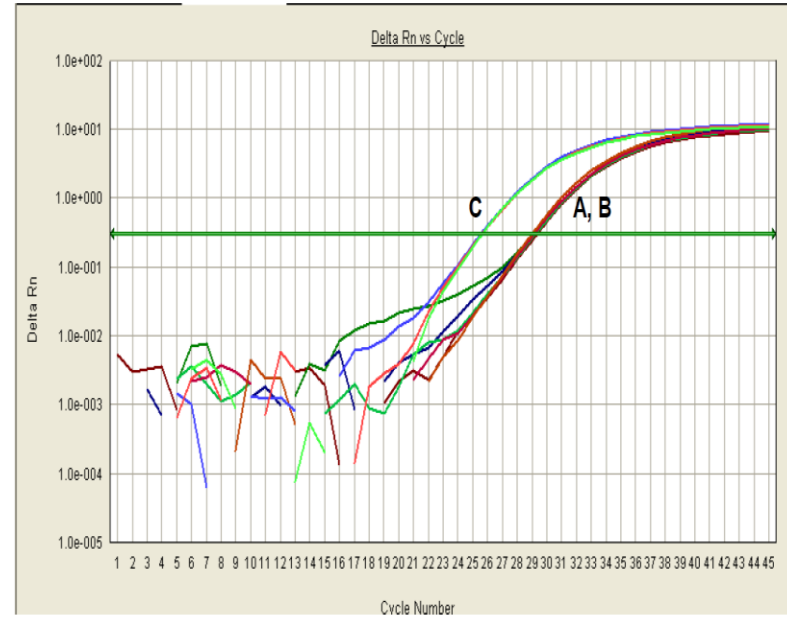
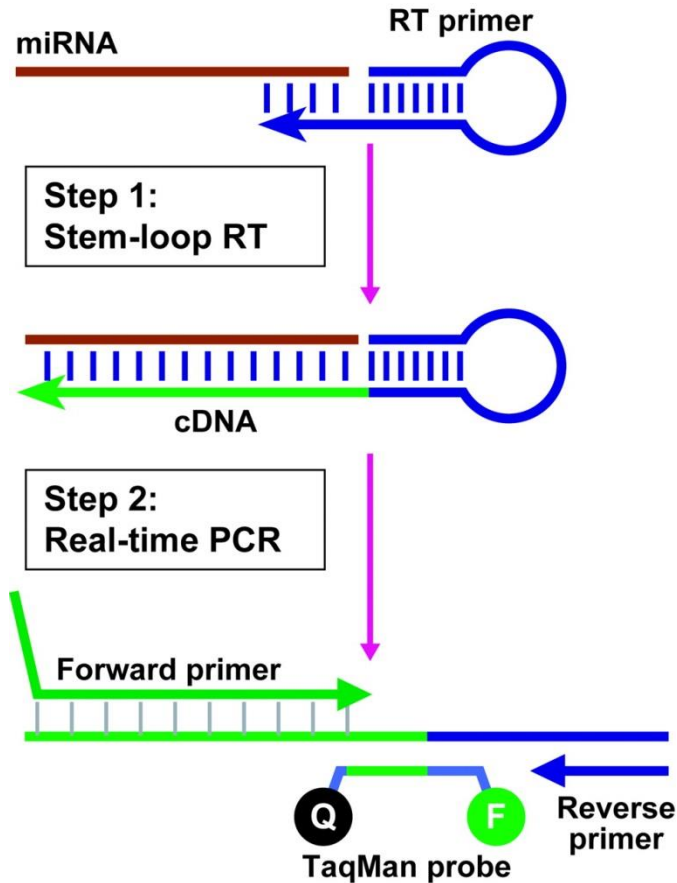

Stabilita microRNA :

Stabilita po izolaci

Stabilita v FFPE (formalin-fixed parafin-embedded tissue)

RNA

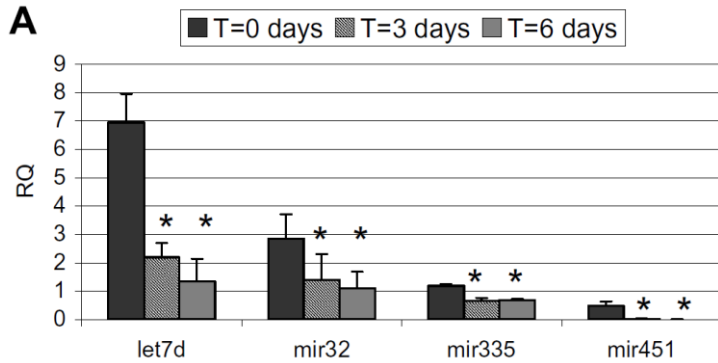

cDNA

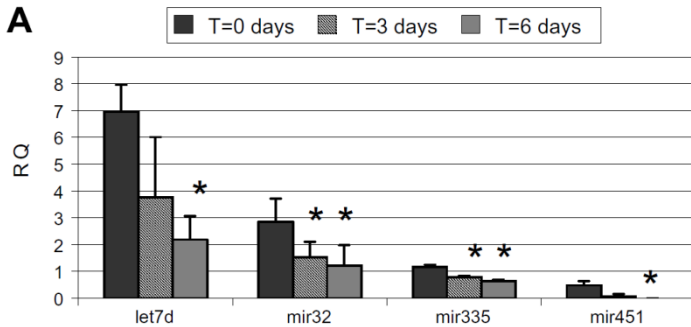

Bravo et al., 2007

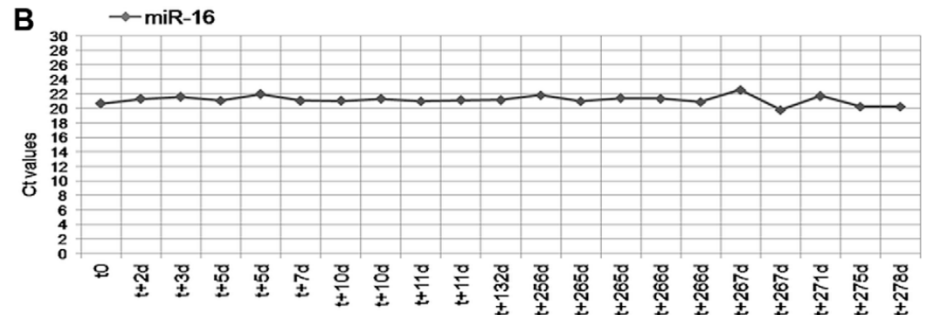
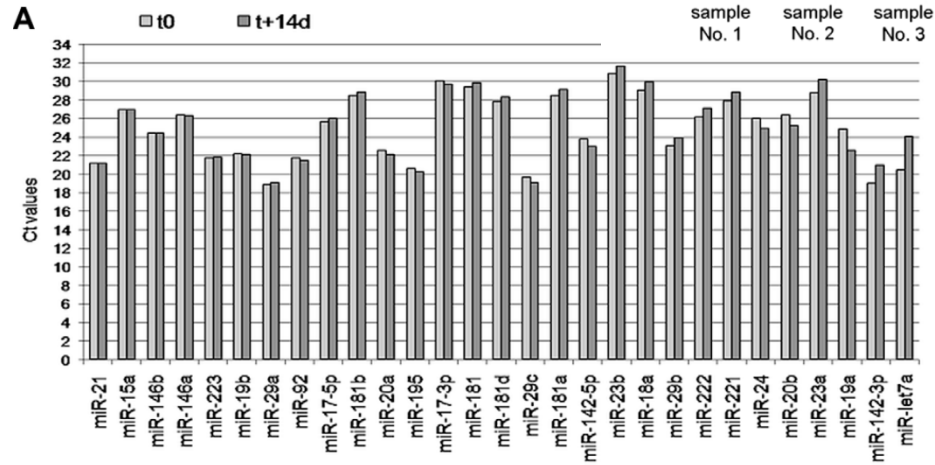
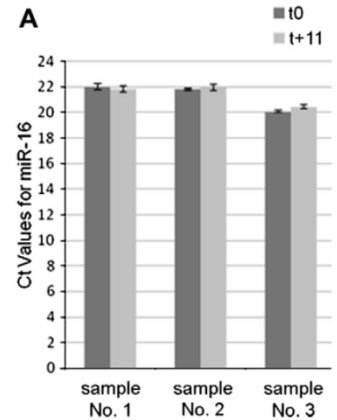

Mráz et al., 2009

Stabilita microRNA :

Stabilita v FFPE (formalin-fixed parafin-embedded tissue)

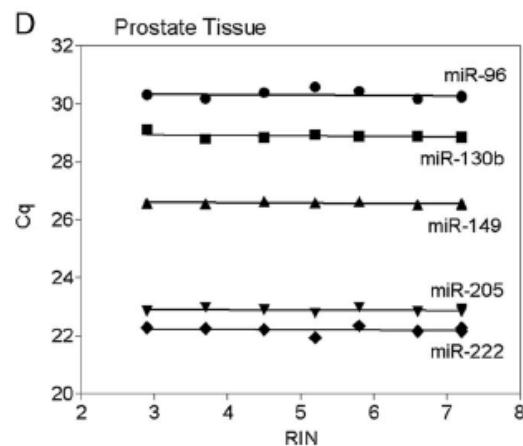
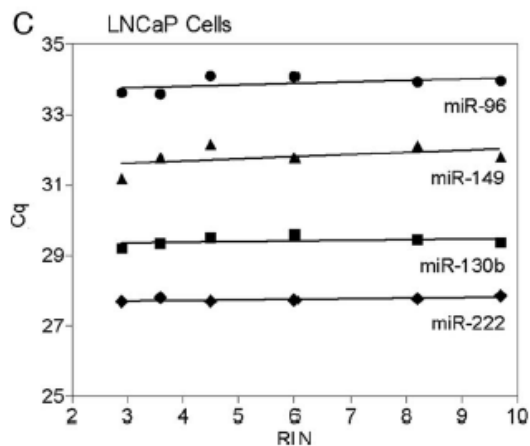
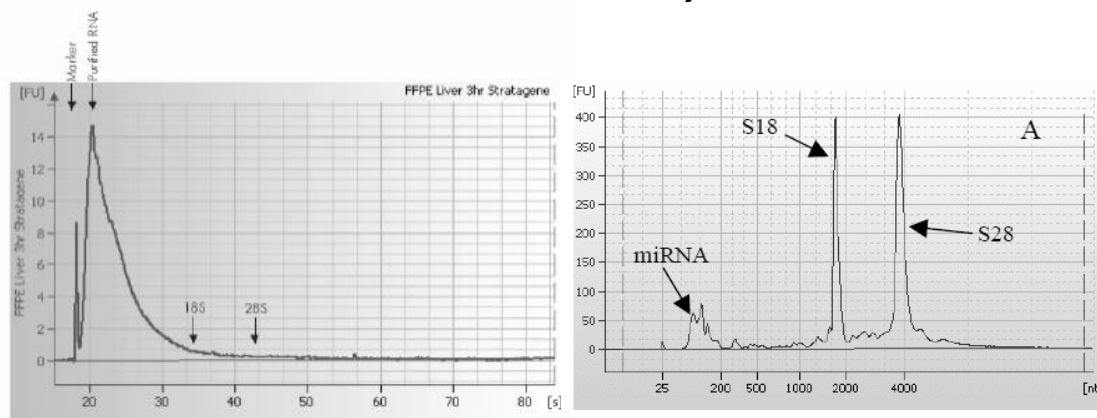
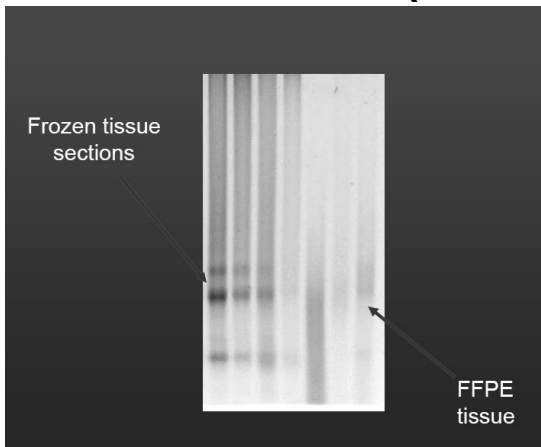

Fig. 2. Influence of RNA integrity on miRNA gene expression.

(A), miR-141, miR-155, miR-200c, and miR-210 in RNA samples from ccRCC cell line Caki-2. (B), miR-141, miR-155, miR-200c, and miR-210 in RNA samples from the renal tissue pool. (C), miR-96, miR-130b, miR-149, and miR-222 in RNA samples from PCa cell line LNCaP. (D), miR-96, miR-130b, miR-149, miR-205, and miR-222 in RNA samples from the prostate tissue pool. For further details, including regression line characteristics, 95% CIs of the slopes, and *P* values indicating significant deviations from 0, see Table 5 in the online Data Supplement.

RNA Seq

Next Generation Sequencing

- Takes advantage of miniaturization to engage in massively parallel analysis
 - Essentially carrying out millions of sequencing reactions simultaneously in each of 10 million tiny wells
- Sophisticated computer analysis of huge amounts of information allows “assembly” of a given sequence

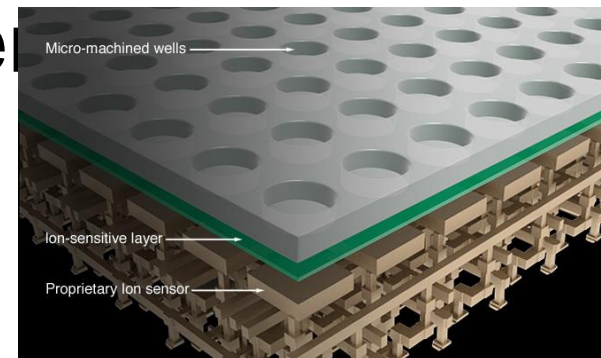

High Parallelism is Achieved in Polony Sequencing

Sanger

Polony

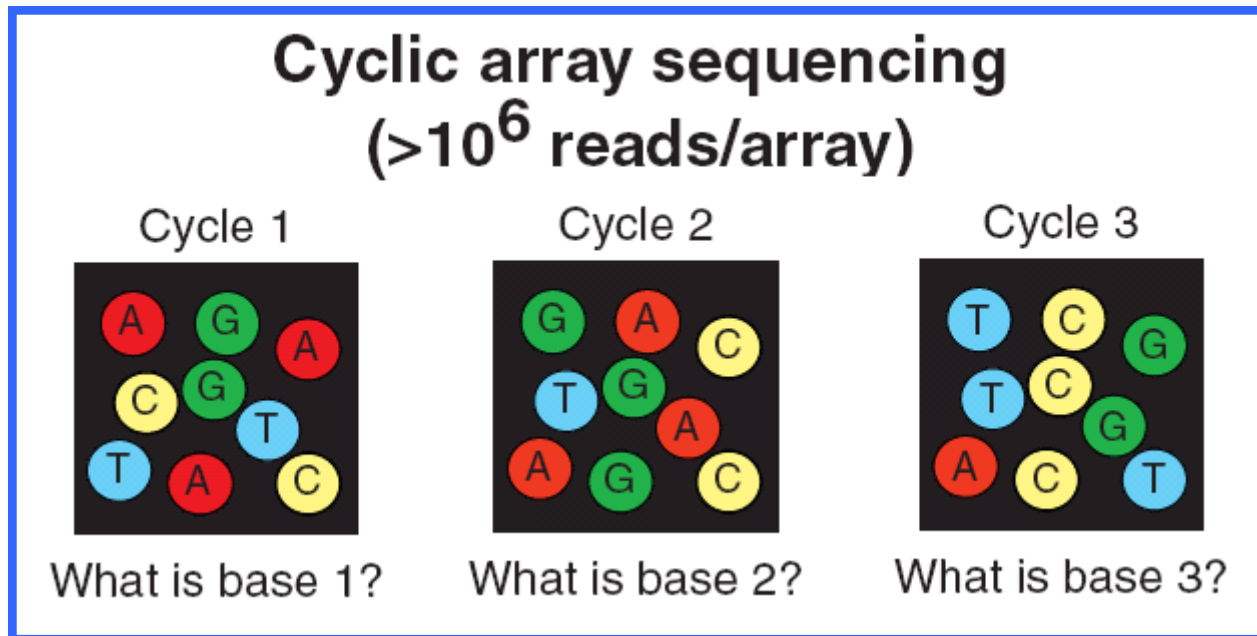

A. Library Preparation

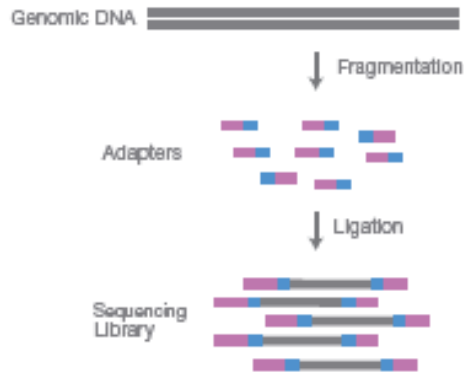

NGS library is prepared by fragmenting a gDNA sample and ligating specialized adapters to both fragment ends.

A. Cluster Amplification

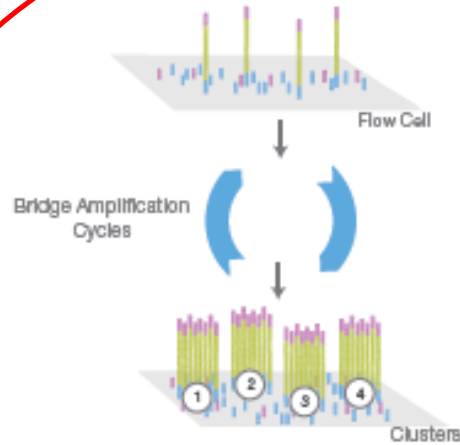

Library is loaded into a flow cell and the fragments hybridize to the flow cell surface. Each bound fragment is amplified into a clonal cluster through bridge amplification.

This is the trick

C. Sequencing

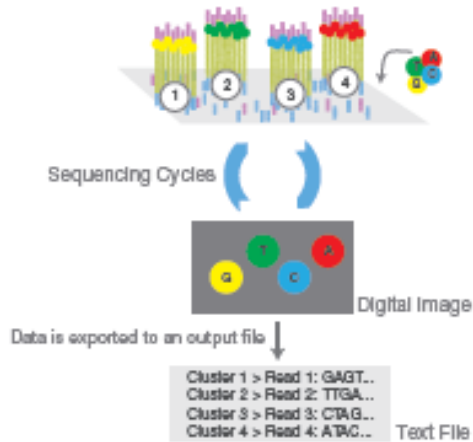

Sequencing reagents, including fluorescently labeled nucleotides, are added and the first base is incorporated. The flow cell is imaged and the emission from each cluster is recorded. The emission wavelength and intensity are used to identify the base. This cycle is repeated "n" times to create a read length of "n" bases.

D. Alignment & Data Analysis

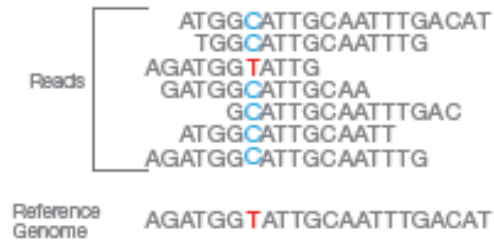

Reads are aligned to a reference sequence with bioinformatics software. After alignment, differences between the reference genome and the newly sequenced reads can be identified.

E



Two PCR primers are attached to the surface of flowcell. One of the primers has a cleavable site

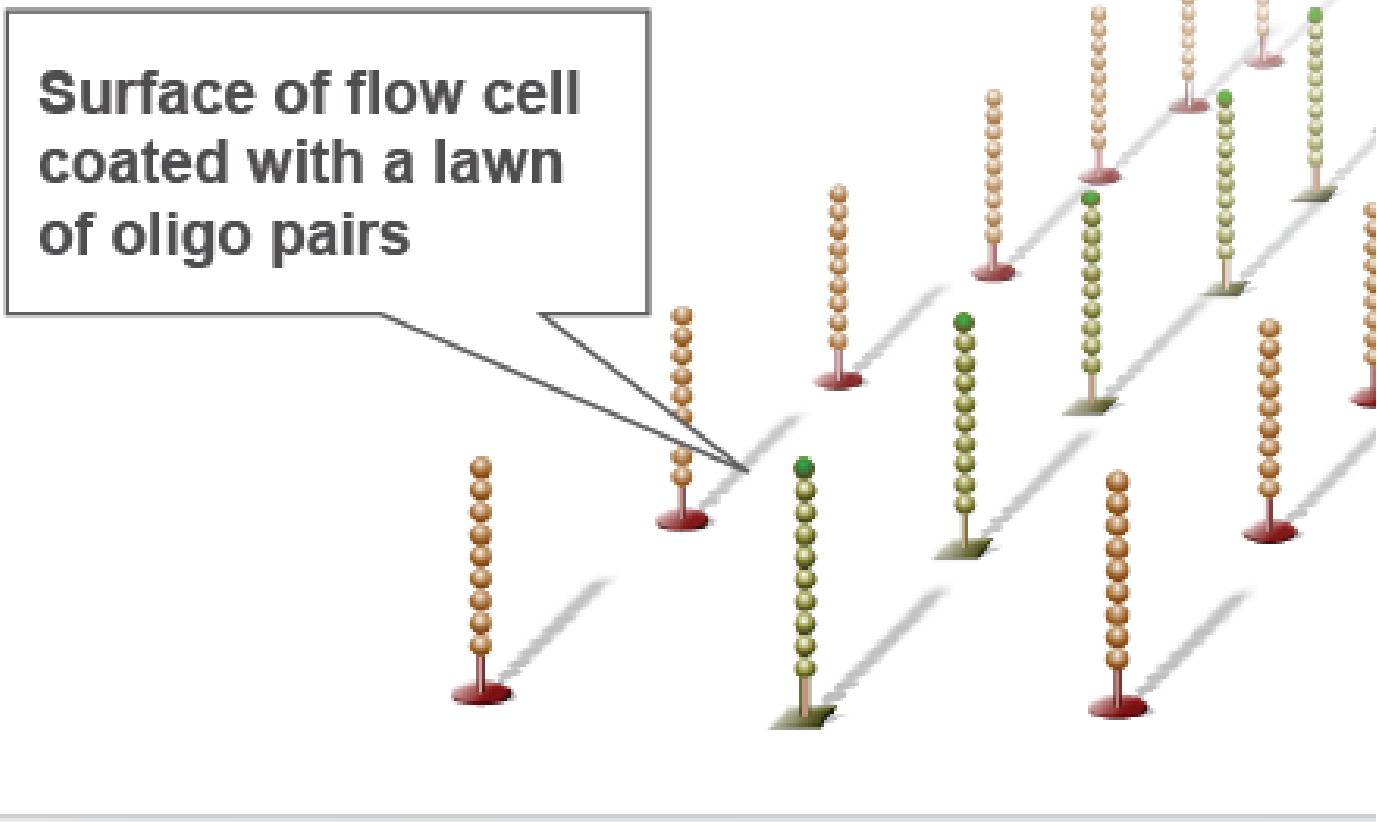

Hybridize Fragment & Extend

Single DNA libraries are hybridized to primer lawn

Bound libraries are then extended by polymerases

Surface of flow cell coated with a lawn of oligo pairs

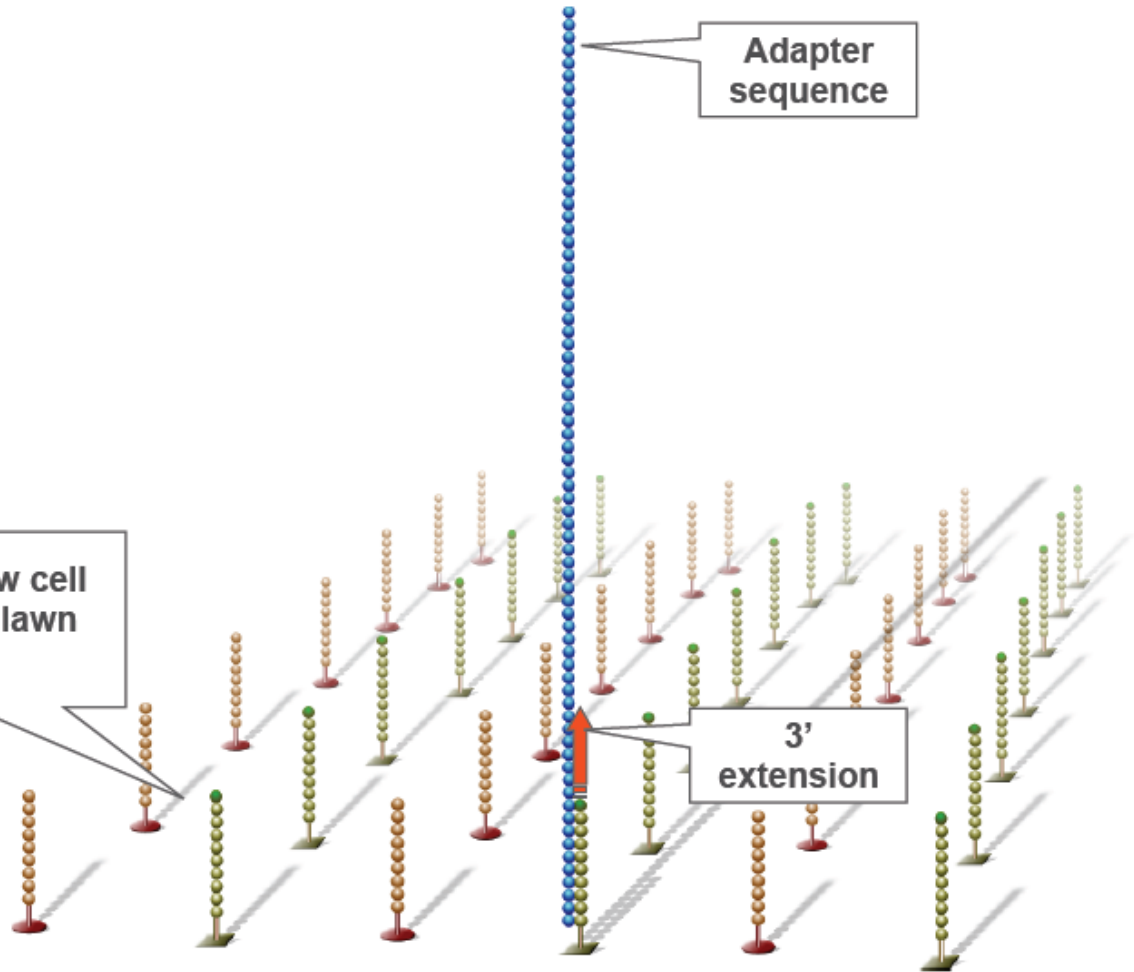

Denature Double-Stranded DNA

Double-stranded molecule is denatured

Original template washed away

Newly synthesized strand is covalently attached to flow cell surface

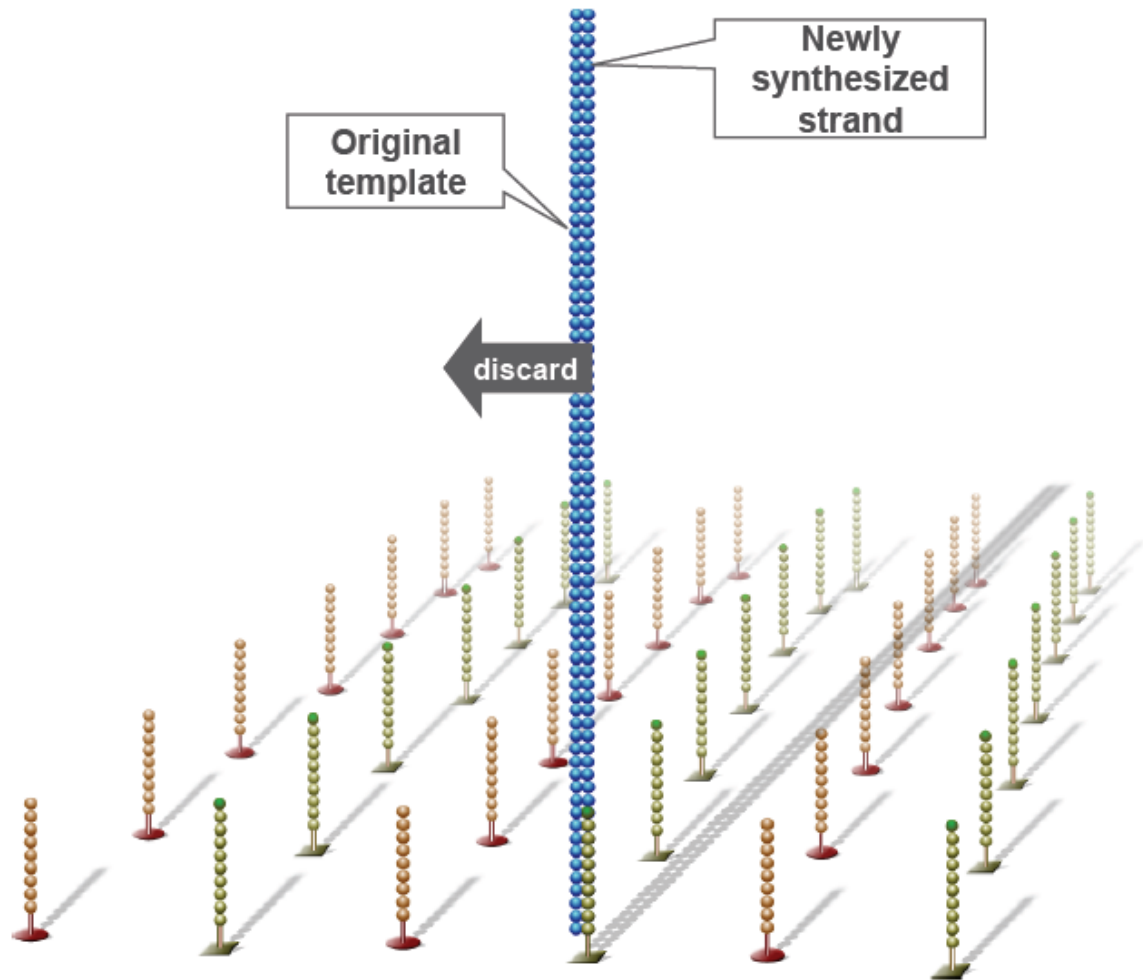

Single-Stranded DNA

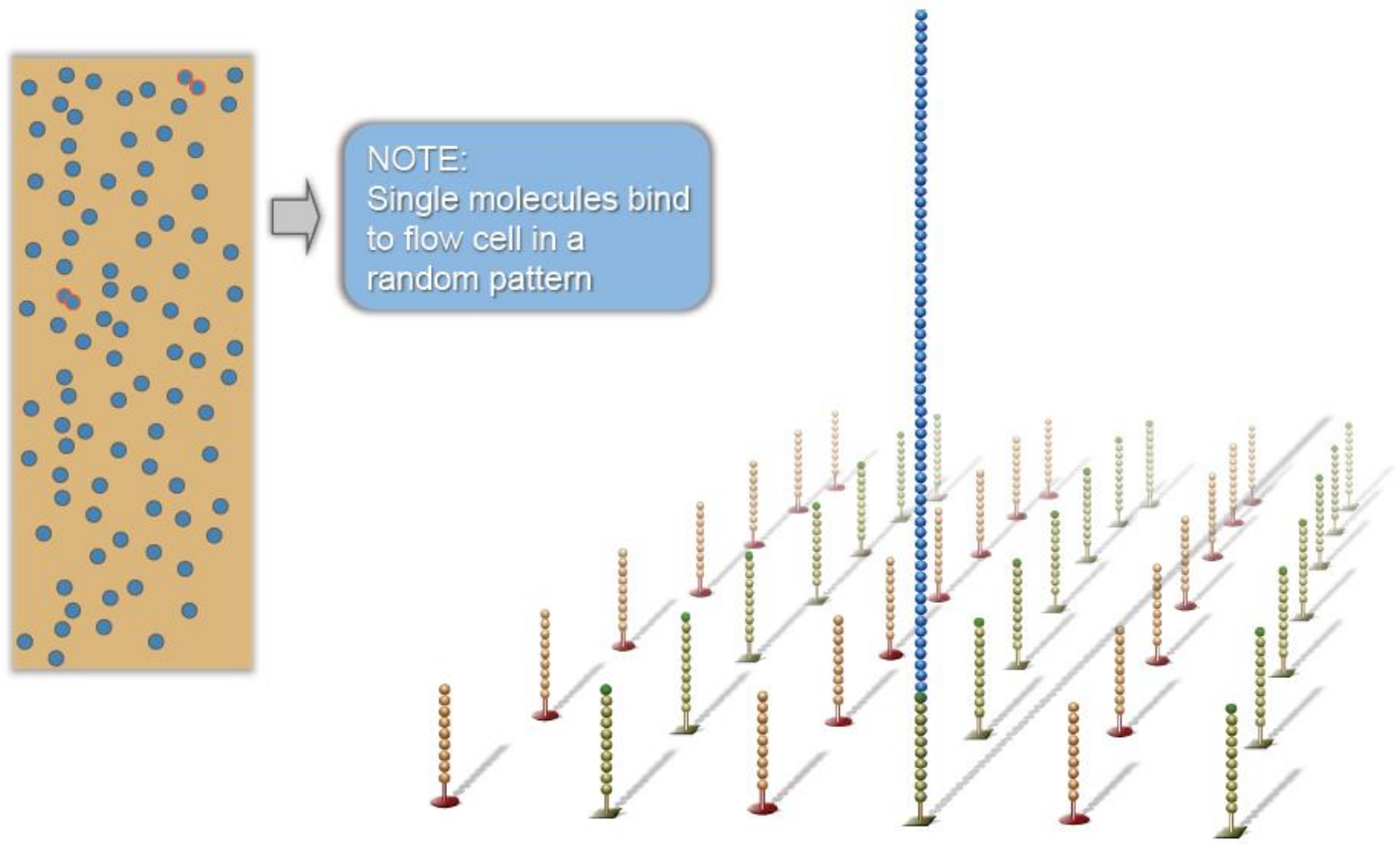

Bridge Amplification

Single-stranded molecule flips over and forms a bridge by hybridizing to adjacent, complementary primer

Hybridized primer is extended by polymerases

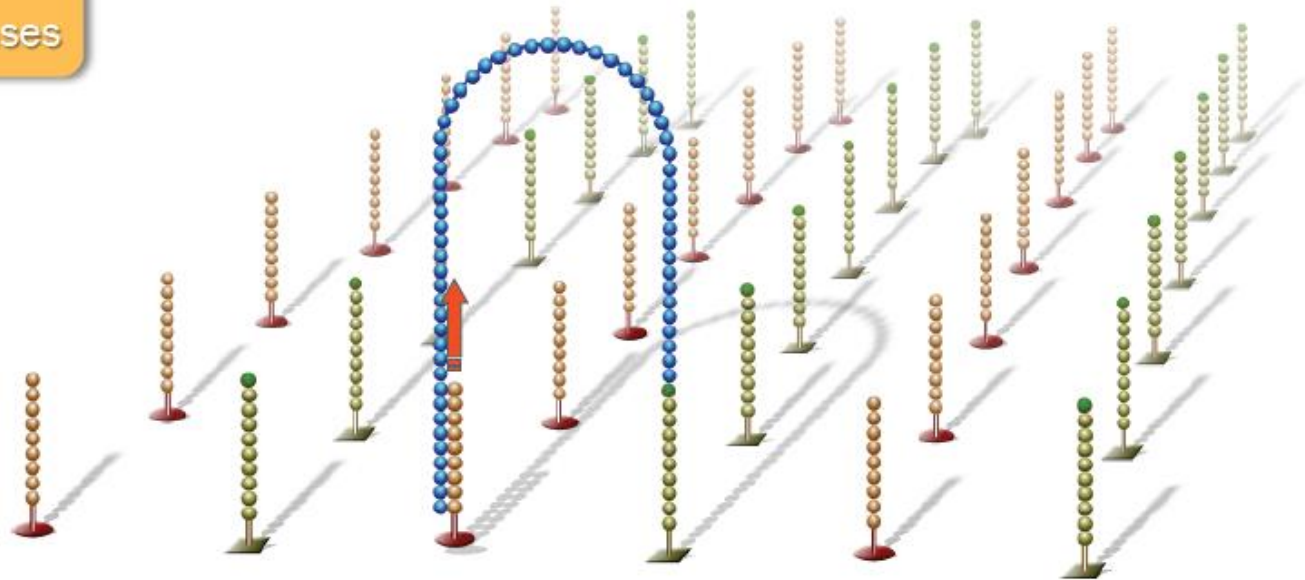

Bridge Amplification

Double-stranded bridge is formed

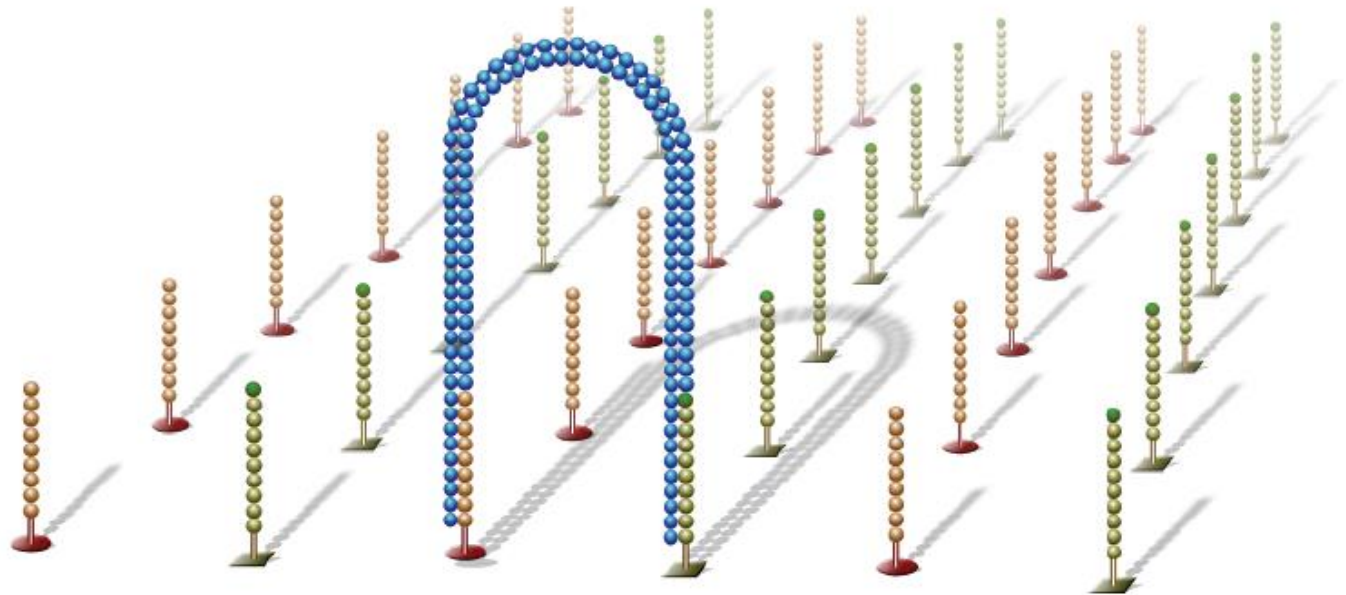

Denature Double-Stranded Bridge

Double-stranded bridge is denatured

Result:
Two copies of covalently bound single-stranded templates

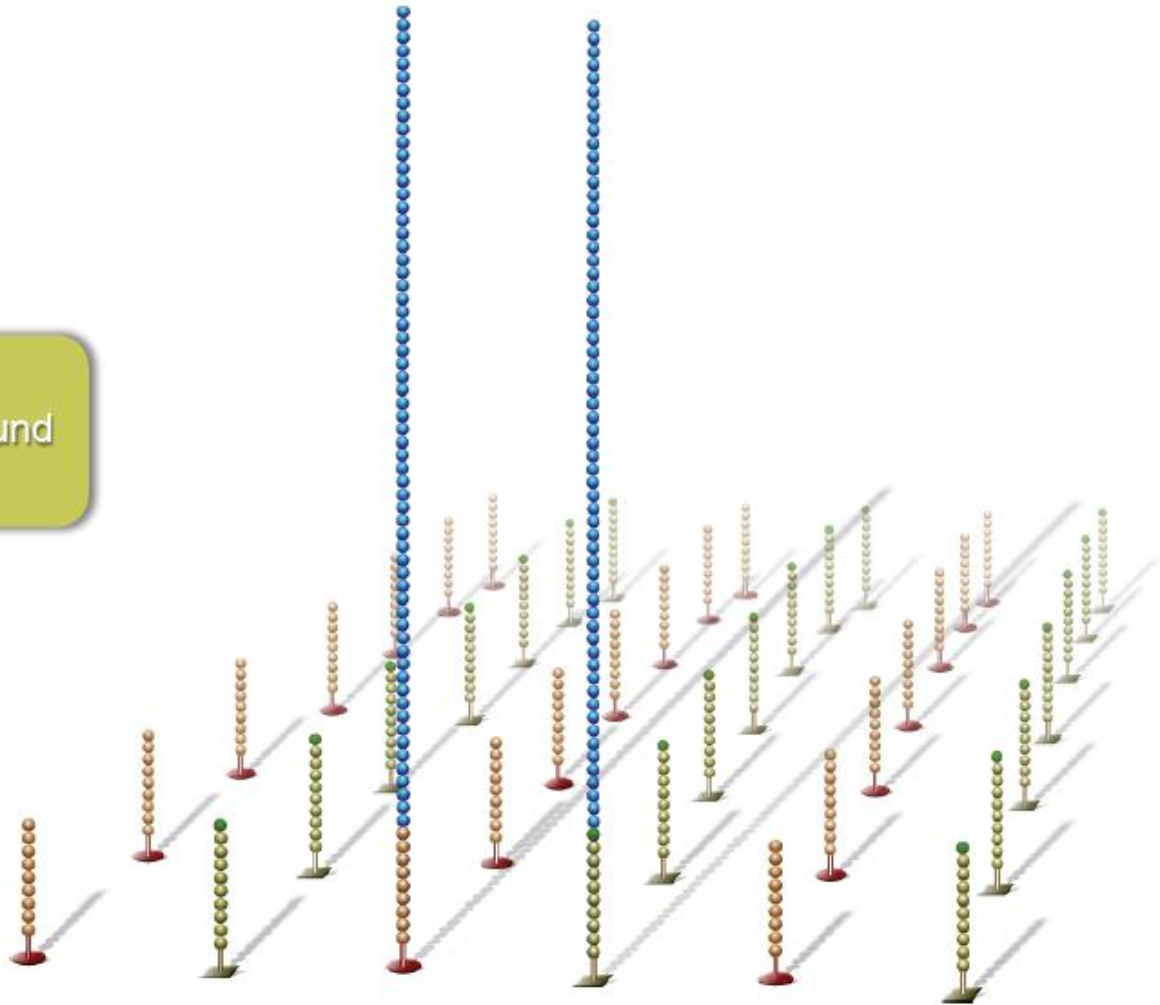

Bridge Amplification

Single-stranded molecules flip over to hybridize to adjacent primers

Hybridized primer is extended by polymerase

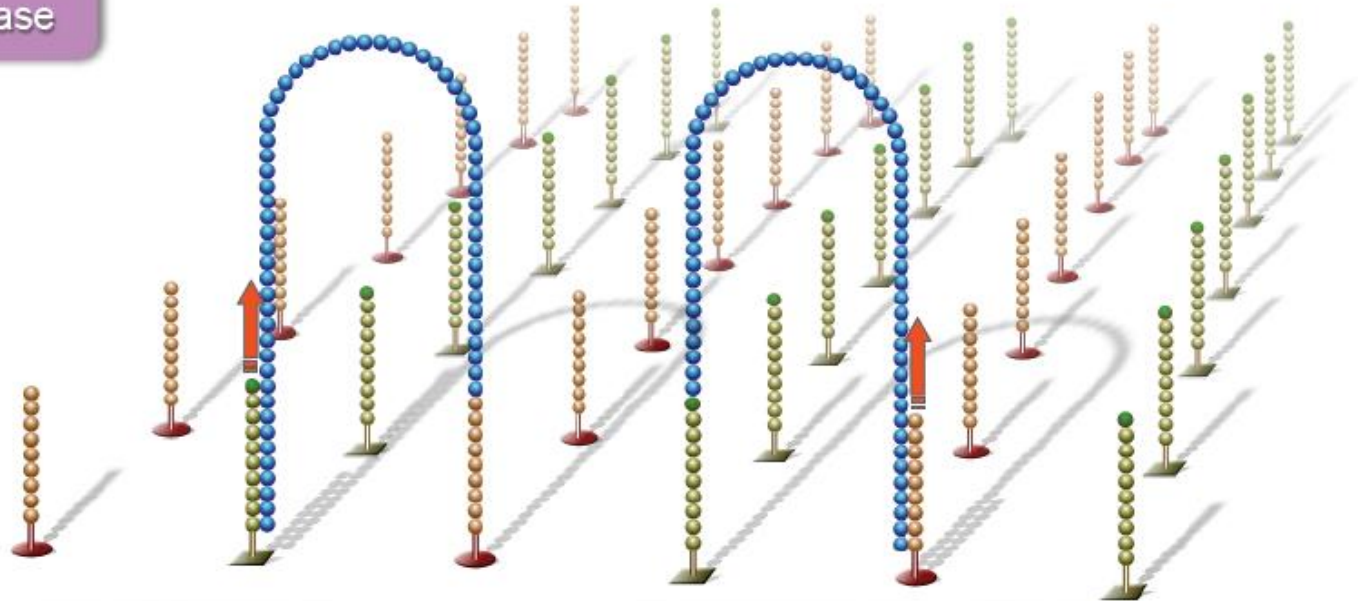

Bridge Amplification

Bridge amplification cycle is repeated until multiple bridges are formed

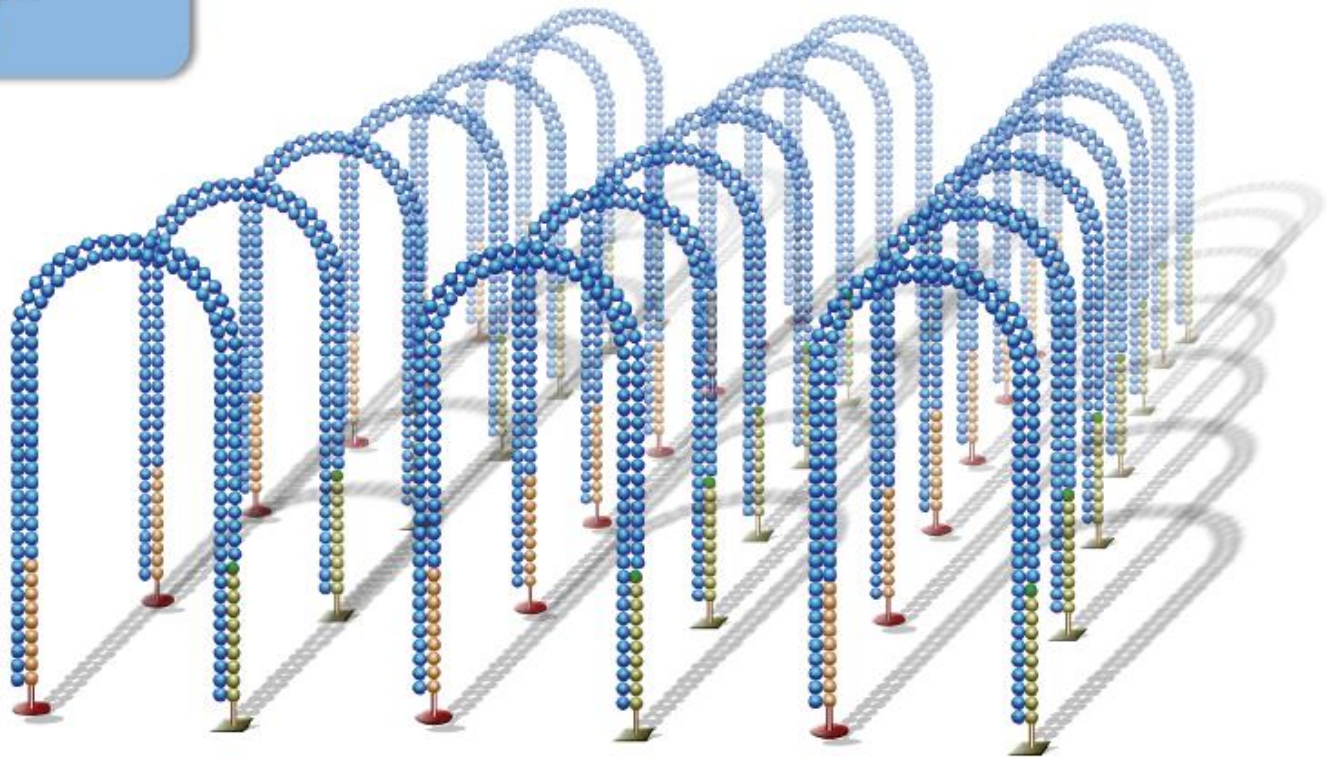

Linearization

dsDNA bridges are denatured

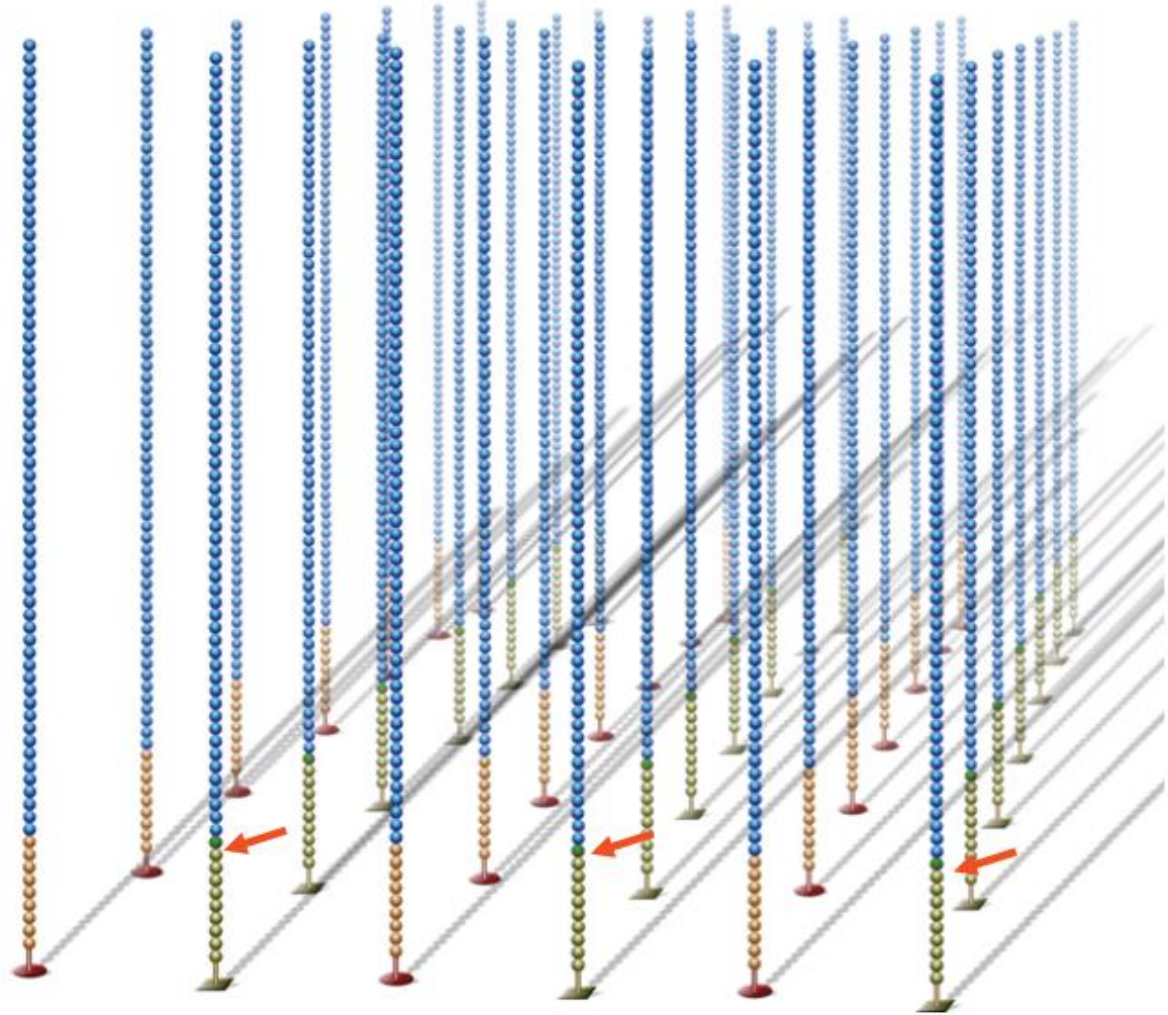

Reverse Strand Cleavage

Reverse strands are cleaved and washed away, leaving a cluster with forward strands only

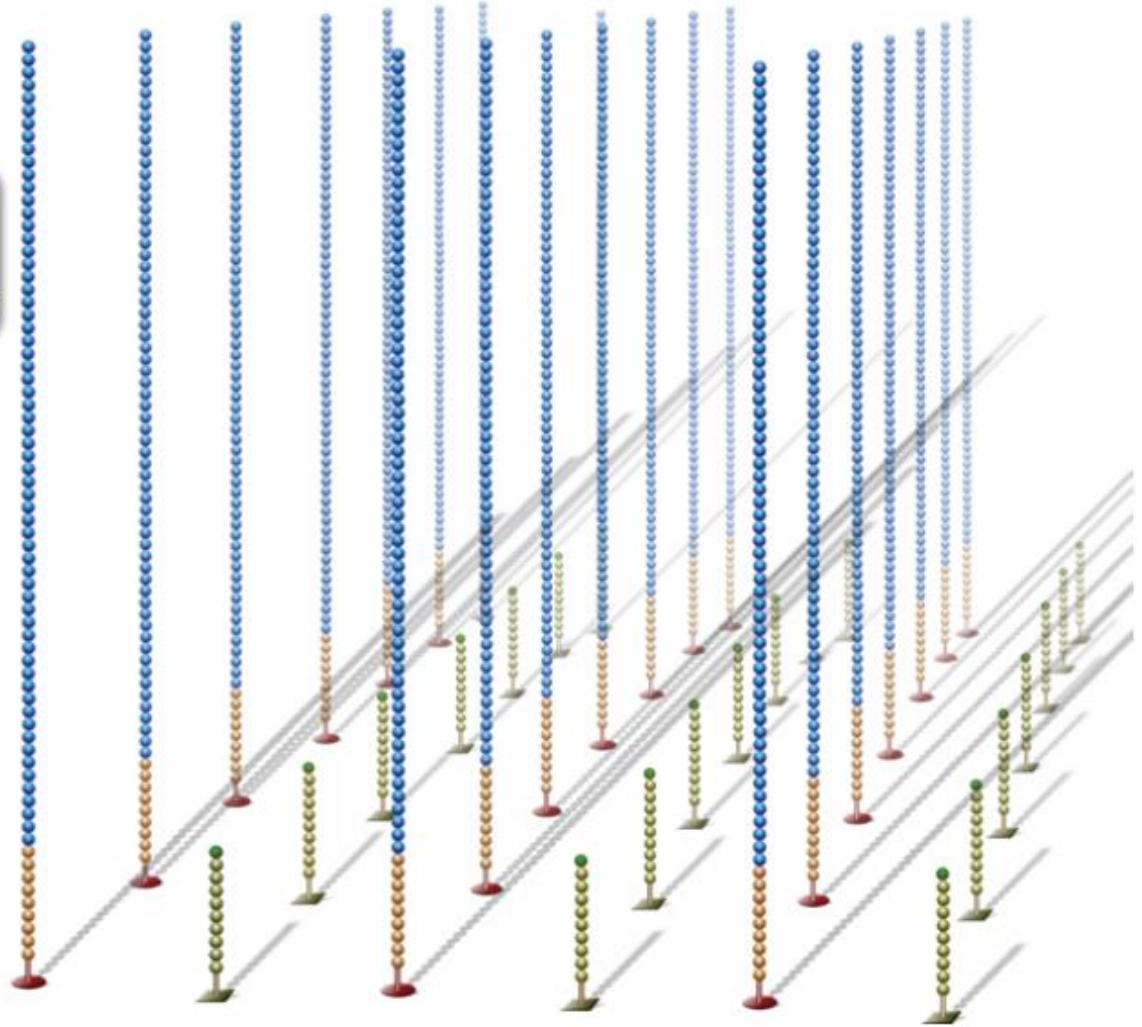

Blocking

Free 3' ends are blocked to prevent unwanted DNA priming

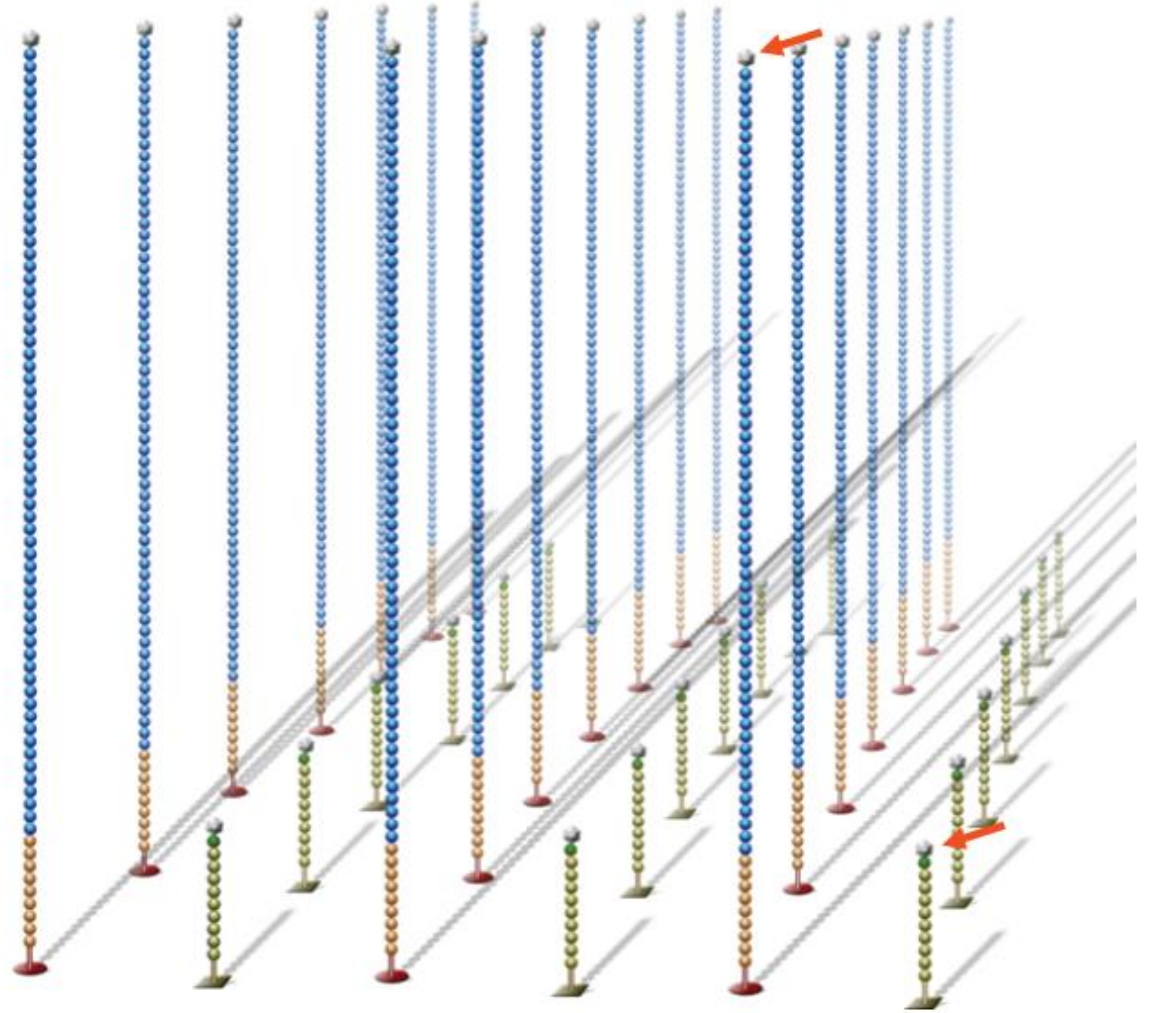

Read 1 Primer Hybridization

Sequencing primer is hybridized to adapter sequence

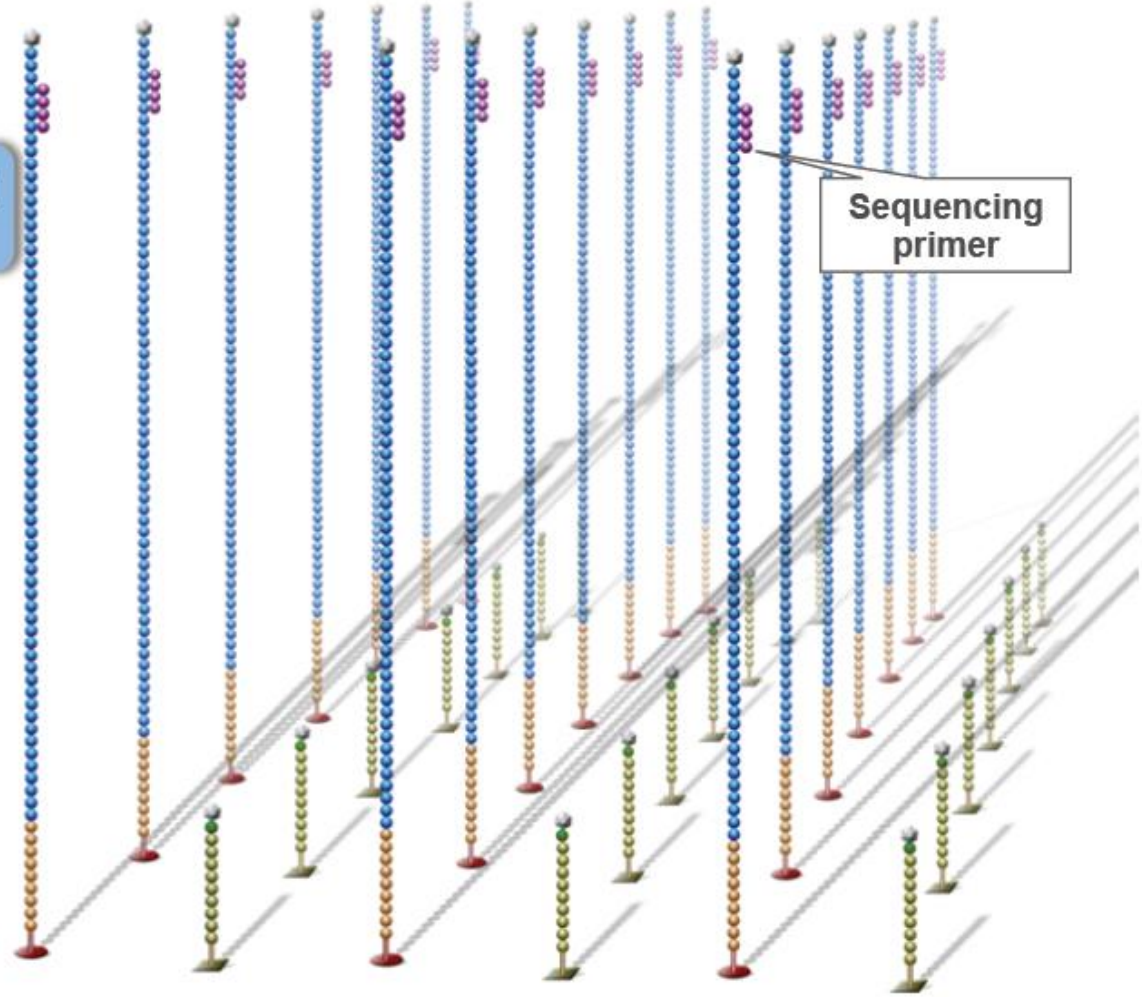

Sequencing by synthesis

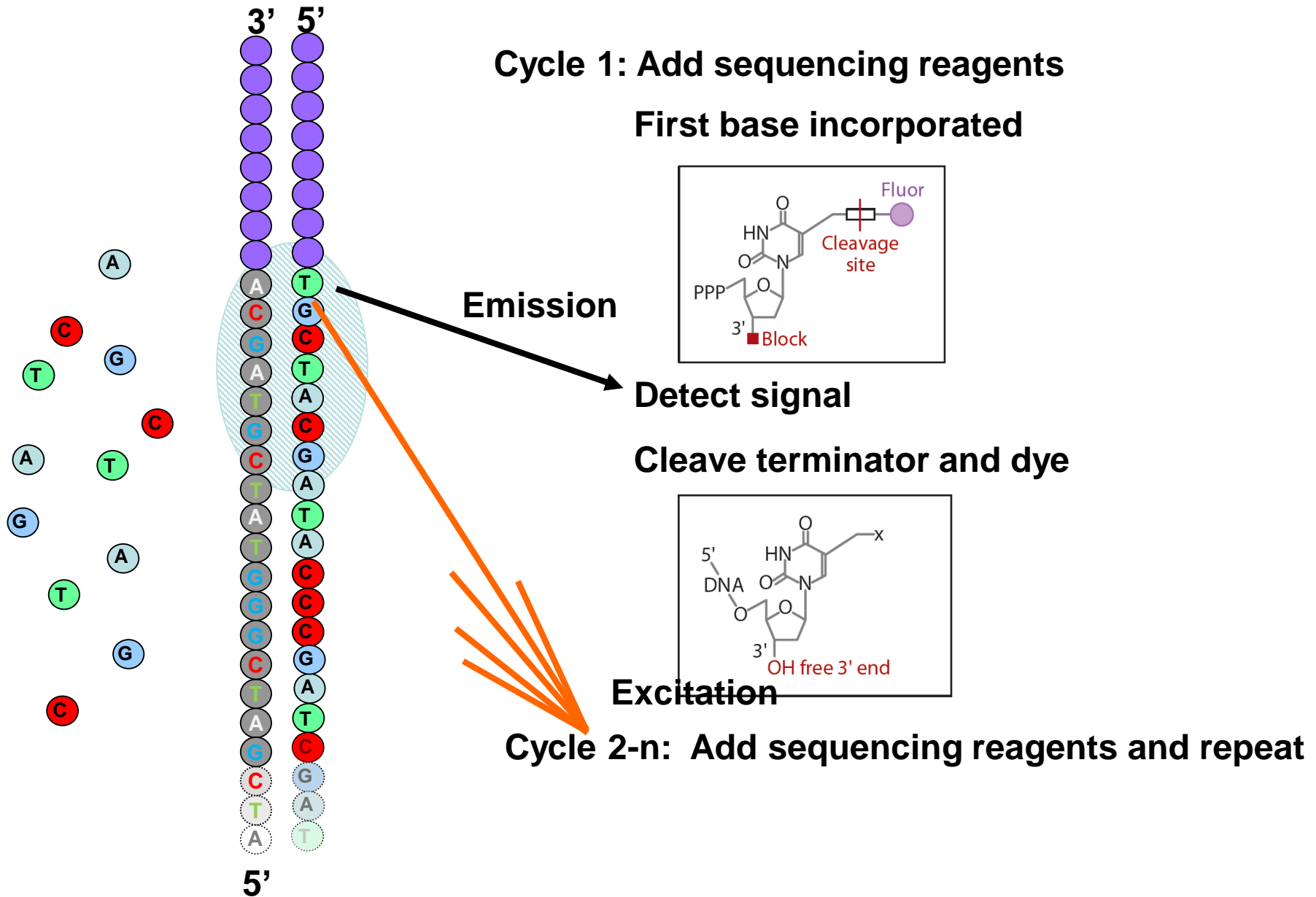

Sequencing by Synthesis - Fluorescently labeled Nucleotides (Illumina)

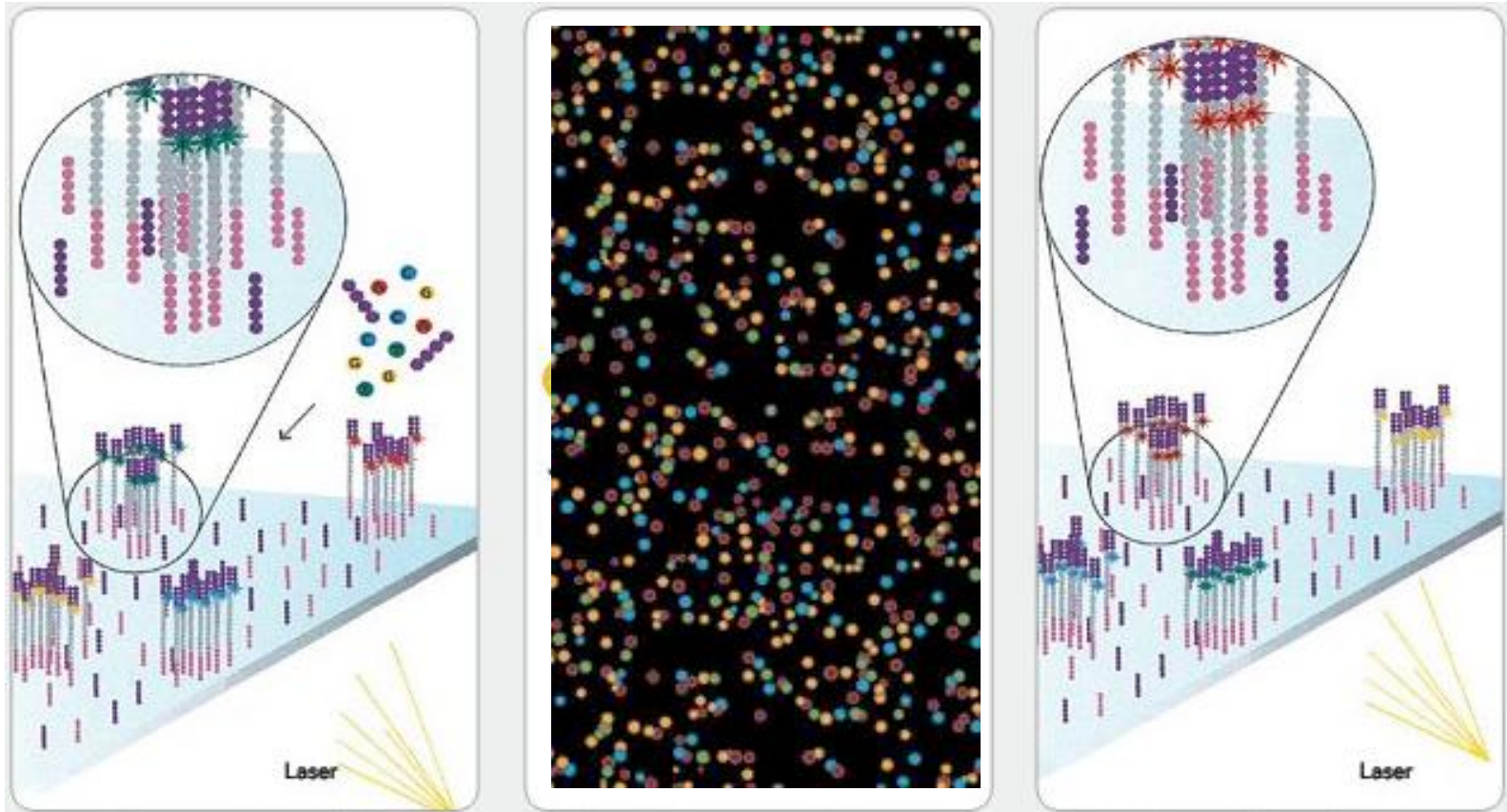

Complementary strand elongation: DNA Polymerase

video

- <https://www.youtube.com/watch?v=womKfikWlxM>

The general experimental procedure for RNA

Transcriptom =
sum of all RNA
(mRNA, rRNA,
tRNA and
noncoding RNA)

a Data generation

① mRNA or total RNA

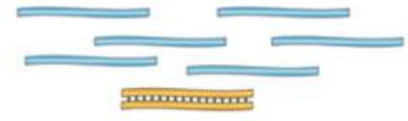

② Remove contaminant DNA



Remove rRNA?
Select mRNA?

③ Fragment RNA



④ Reverse transcribe
into cDNA

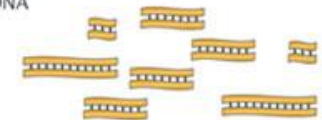

⑤ Ligate sequence adaptors

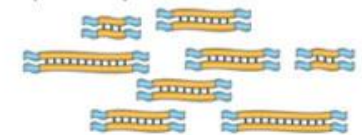

Strand-specific RNA-seq?

⑥ Select a range of sizes

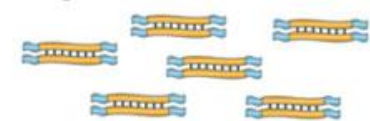

PCR amplification?

⑦ Sequence cDNA ends

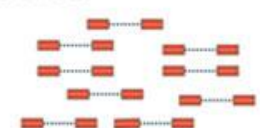

The general experimental procedure for miRNA

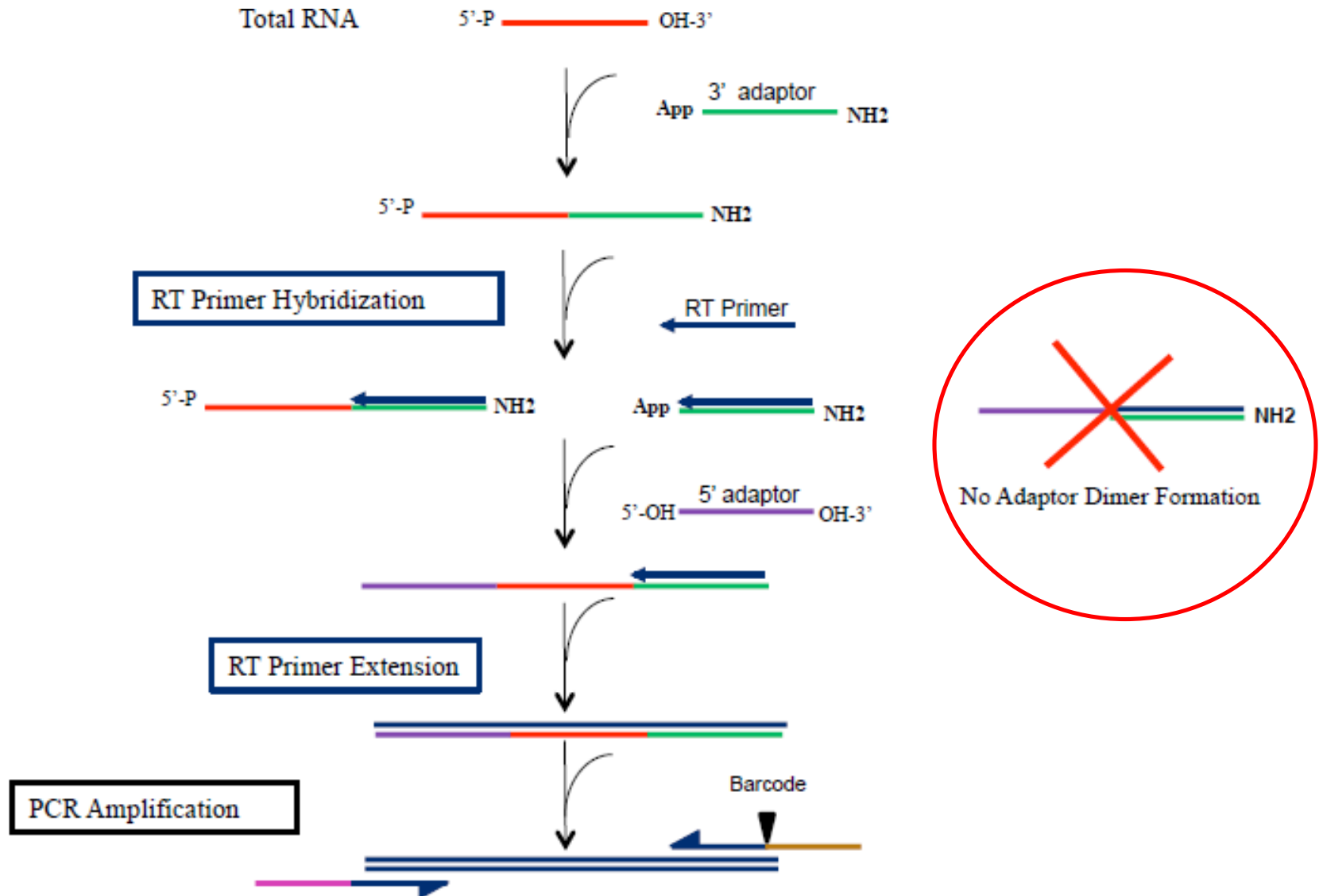

The general experimental procedure for miRNA

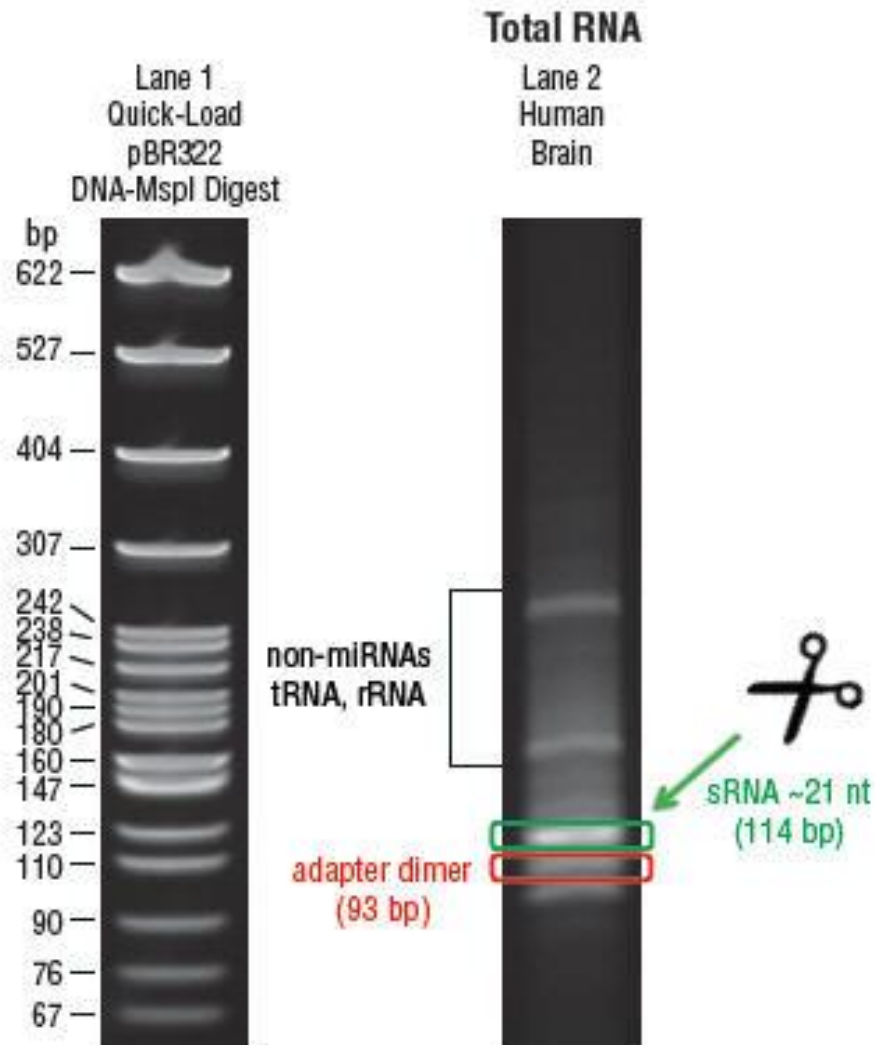

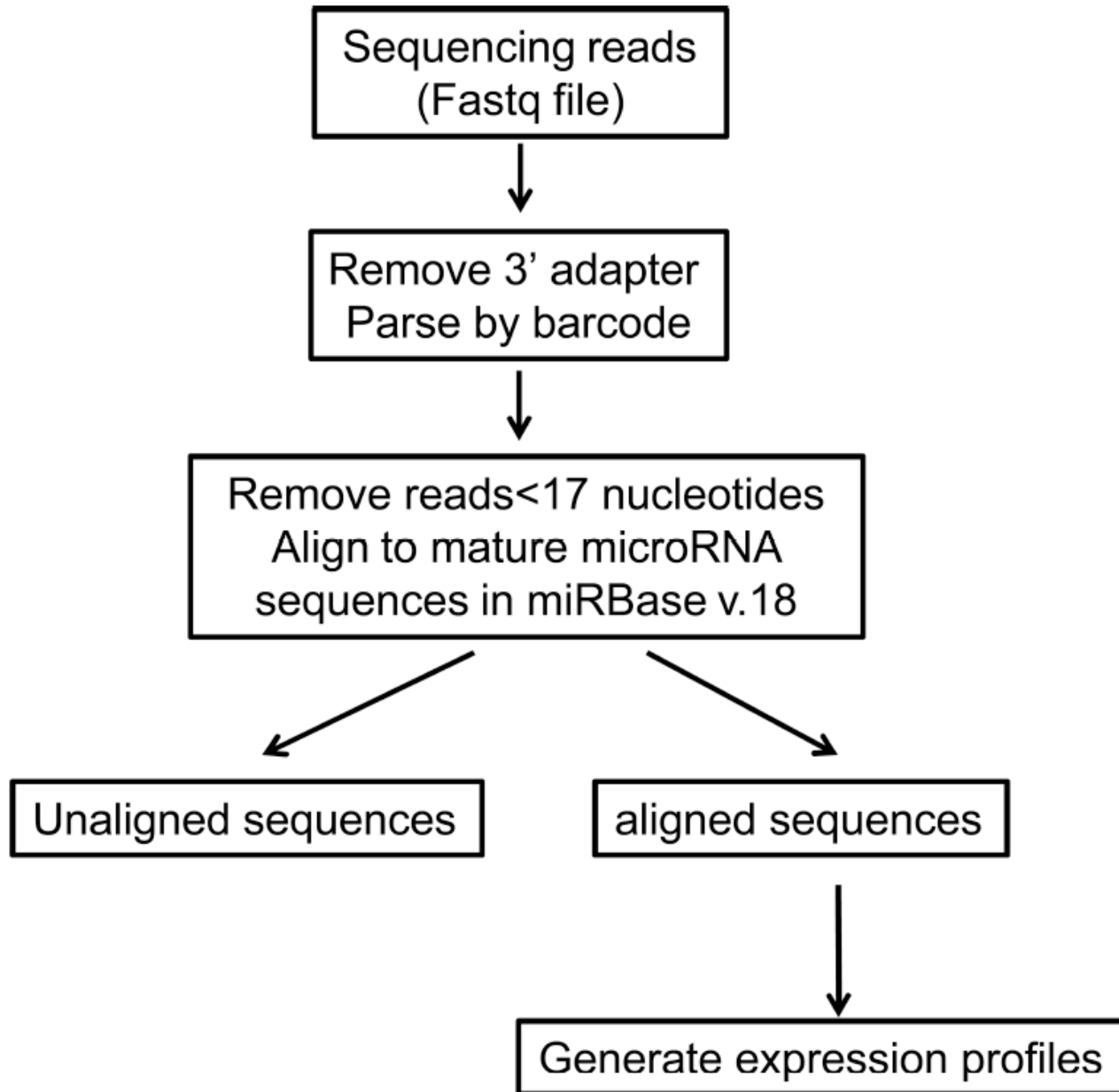

MICROARRAYS

Expression microarrays pro microRNAs:

- velmi malé molekuly – 22nt – specifikum izolace, specifické značení i design sond
- malé zastoupení ve vzorku – separace microRNA
- v lidském genomu cca 2000 genů – menší počet sond na čipu
- některé mají velmi podobnou sekvenci – rozdíl 1nt
- pre-miR, pri-miR, mature-miR
- málo se ví o jejich funkcích – obtížná interpretace výsledků
- zatím málo zkušeností a standardizace

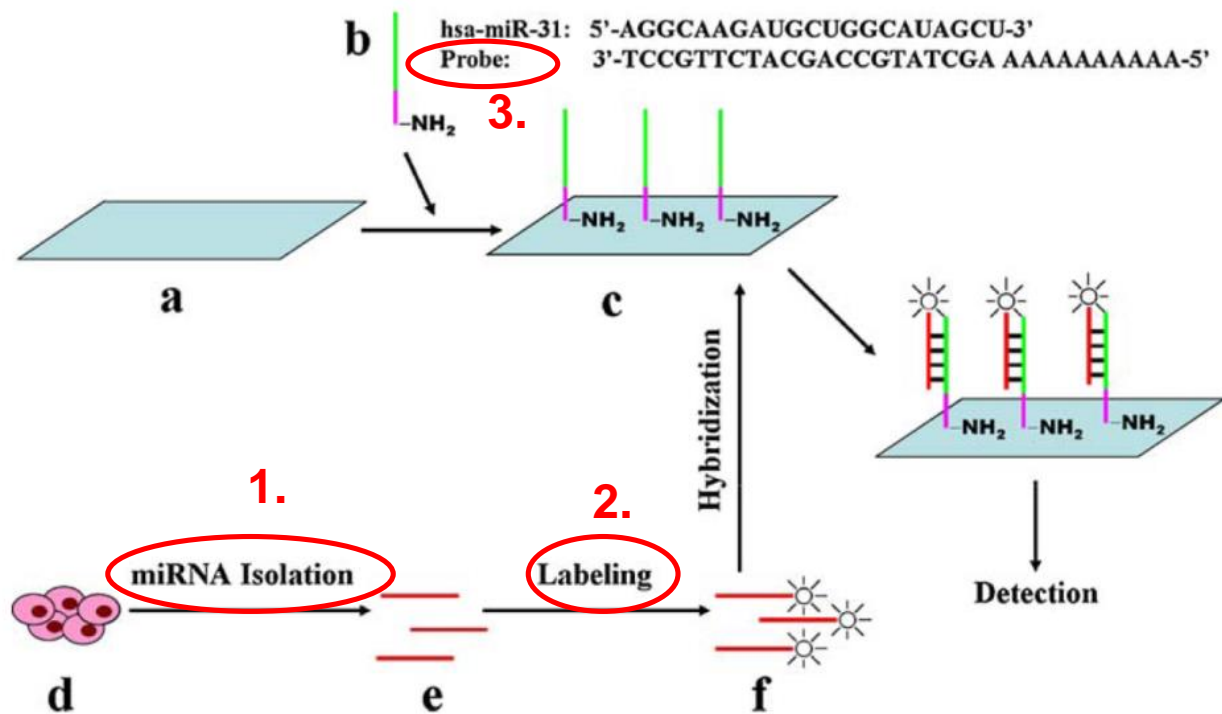

3/ Labeling – značení:

- ❑ Není možný labeling pomocí značených polyT při reverzní transkripci
- ❑ Přímé značení (direct labeling) – většinou nějaká fluorescenční barva
- ❑ Nepřímé značení (indirect labeling) – probíhá nějaká reverzní transkripce/PCR

Přímé značení:

Jednoduché, rychlé a „čím méně kroků tím méně vnesených chyb a variability“

1/ Značení guaninu v microRNA

Fluochromem vážícím se na guanin jsou označeny miRNA (Ulysis Alexa Flour 546/647)

Všechny lidské miRNA obsahují guanin, ale v různém množství

Nemožnost usuzovat na vzájemnou expresi různých miRNA (různý obsah guaninu)

(Babak et al., 2004)

2/ Značení pomocí Poly (A) polymerázy

Můžu se rozhodnout jak dlouhý bude poly(A)

a tím ovlivnit sílu signálu

(Shingara et al., 2005)

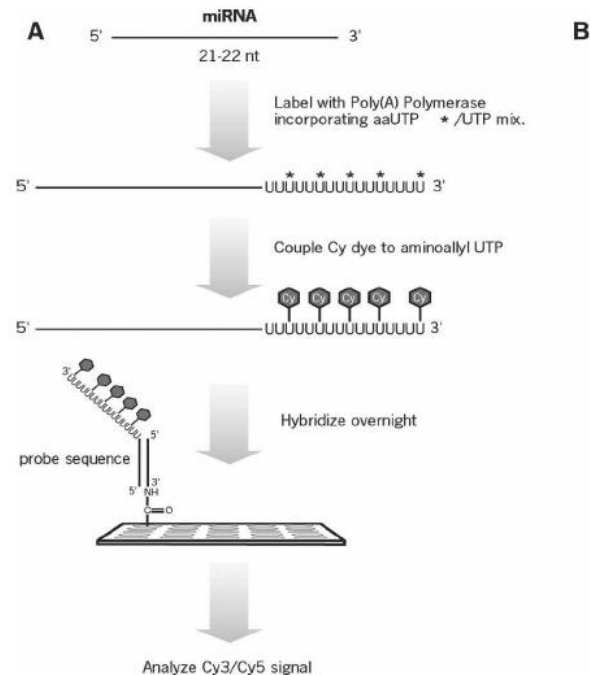

4/ značení pomocí T4 ligasy

Krátký značený oligonukleotid

je připojen T4 ligásou k 3'konci

Výhodou je přednostní vazba

na RNA o velikosti 18-30bp ->total RNA

(Thomson et al., 2004; Castoldi et al., 2007)

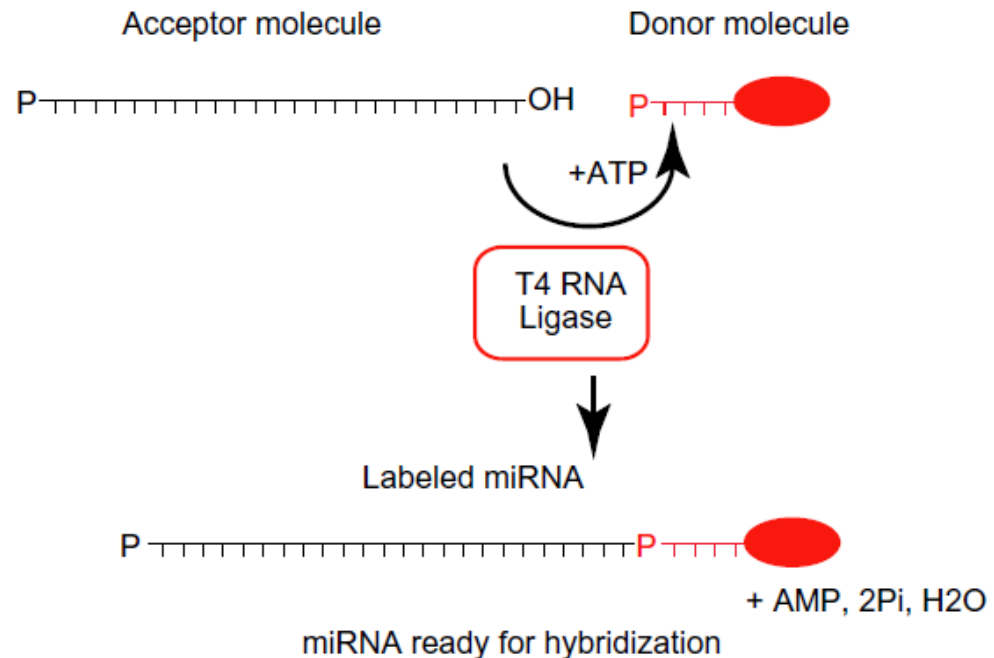

Fig. 2. Schematic representation of the miRNA labeling principle: a short Cy-dye labeled RNA-linker (donor molecule) is ligated to the single-stranded miRNA (acceptor molecule) by T4 RNA ligase in the presence of ATP.

Nepřímé značení:

Značen je produkt reverzní transkripce či PCR

Výhody: cDNA je pak stabilní a lze uchovat, Pre-amplifikace a tím snadnější detekce méně exprimovaných miRNA

1/ značení reverzního transkriptu miRNA

Reverzní transkripce pomocí náhodných 8-merů značených 2 biotiny (3'-(N)8 – (A)12-biotin-(A)12-biotin-5' (Liu et al., 2004)

Reverzní transkripce pomocí náhodných neznačených 7-merů, následně označeny s pomocí terminální transferázy a biotin-dideoxy-UTP (Sun et al., 2004)

Nebezpečí chyb z nespecifické vazby primeru

2/ značení produktu RT-PCR

Výhoda: snadná pre-amplifikace

Dva adaptory

fluorescenčně-značený primer (k adaptoru)

(Miska et al., 2004)

Nevýhoda: antisense strand přiroten při hybridizaci

Rešením je různá délka sense a antisense ->PAGE

(Baskerville, 2005)

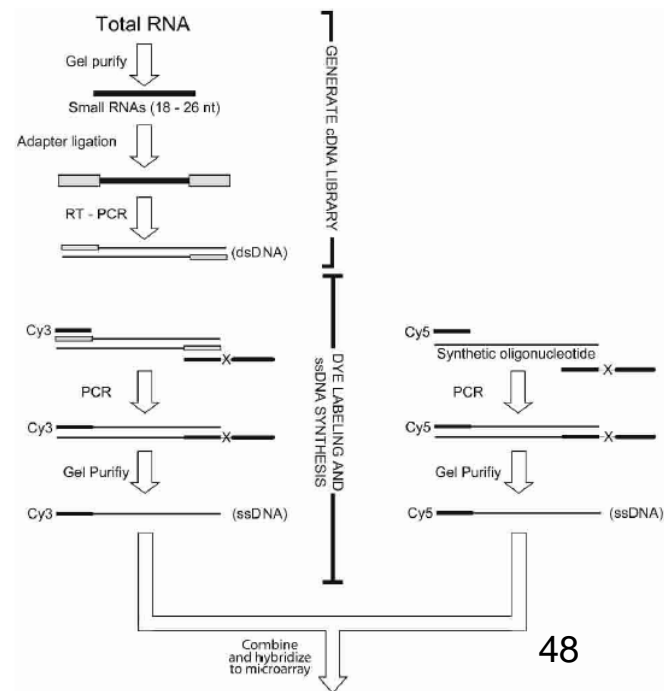

3/ Microarrays/ Próby: Problémy: krátké RNA, malé rozdíly v sekvenci, Tm

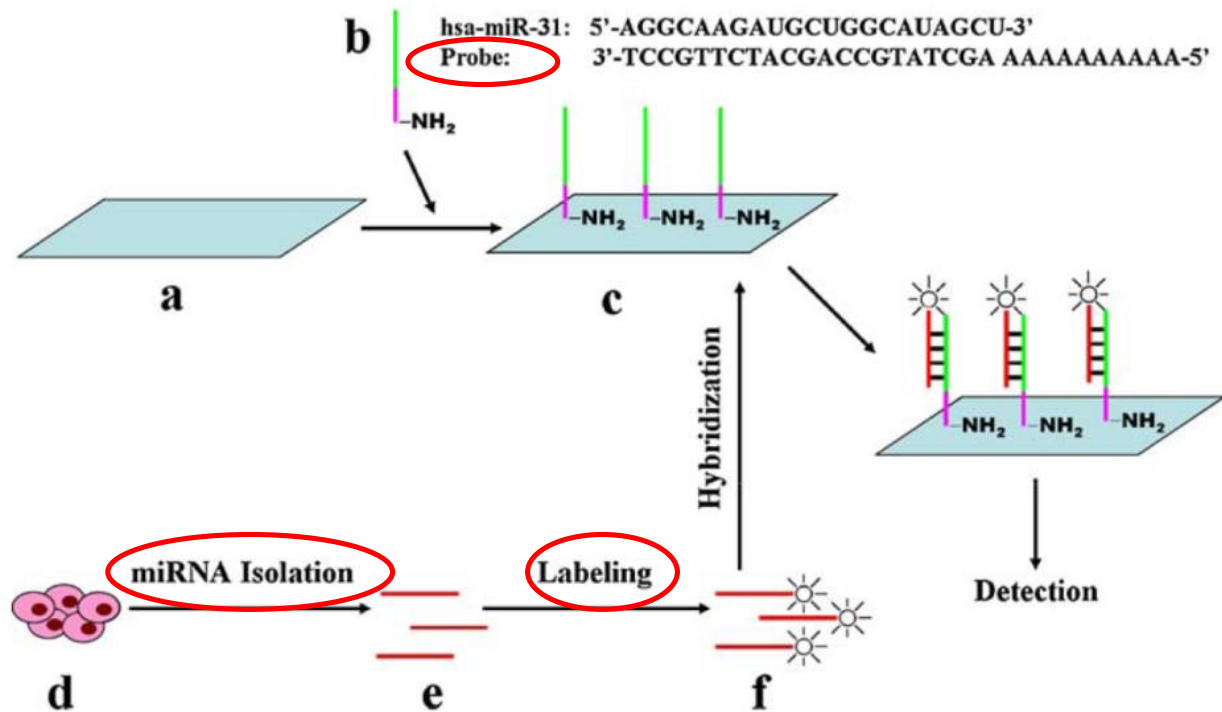

T_m – melting temperature určité próby

T – hybridizační teplota

$T_m < T$ nižší efektivita vazby miRNA

$T_m > T$ vyšší efektivita vazby miRNA

- Je třeba navrhnout próby tak, aby měly všechny podobnou T_m
- To se u „dlouhých“ mRNA řeší vhodným výběrem oblasti genu k němuž bude sonda komplementární nebo délkou sondy
- navíc některé miRNA jsou téměř sekvenčně totožné

```
let-7b : TGAGGTAGTAGGTTGTGTGGTT : 22
let-7e : TGAGGTAGGAGGTTGTATAGT- : 21
let-7d : AGAGGTAGTAGGTTGCATAGT- : 21
let-7a : TGAGGTAGTAGGTTGTATAGTT : 22
let-7f : TGAGGTAGTAGATTGTATAGTT : 22
let-7i : TGAGGTAGTAGTTTGTGCT--- : 19
let-7g : TGAGGTAGTAGTTTGTACAGT- : 21
      tGAGGTAGtAG TTGt gt
```

ÚPRAVA SÍLY VAZBY NUKLEOTIDŮ

LNA próby (Locked Nucleic Acid)

ribózový kruh je „uzamčen“ methylenovým můstkem mezi atomy 2'-O a 4'-C

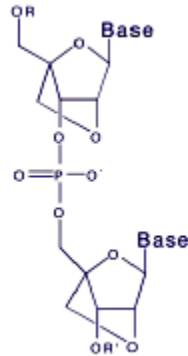

Použití LNA pro některé báze v probě

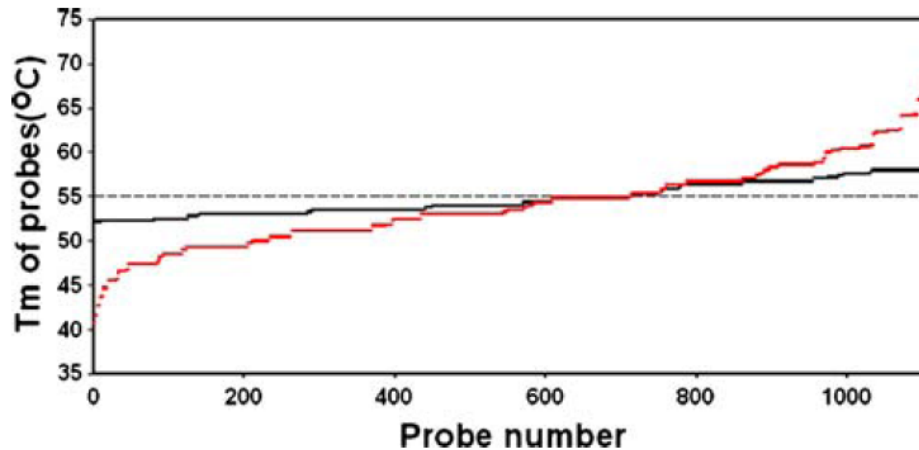

Fig. 2 T_m (melting temperature) distribution for microRNA probes for human, rat and mouse. *Red and black curves* represent the T_m distributions of the raw and normalized probes, respectively

**SÍLA VAZBY:
LNA vs DNA próba
Tm až 72°C
(Castoldi et al., 2006)**

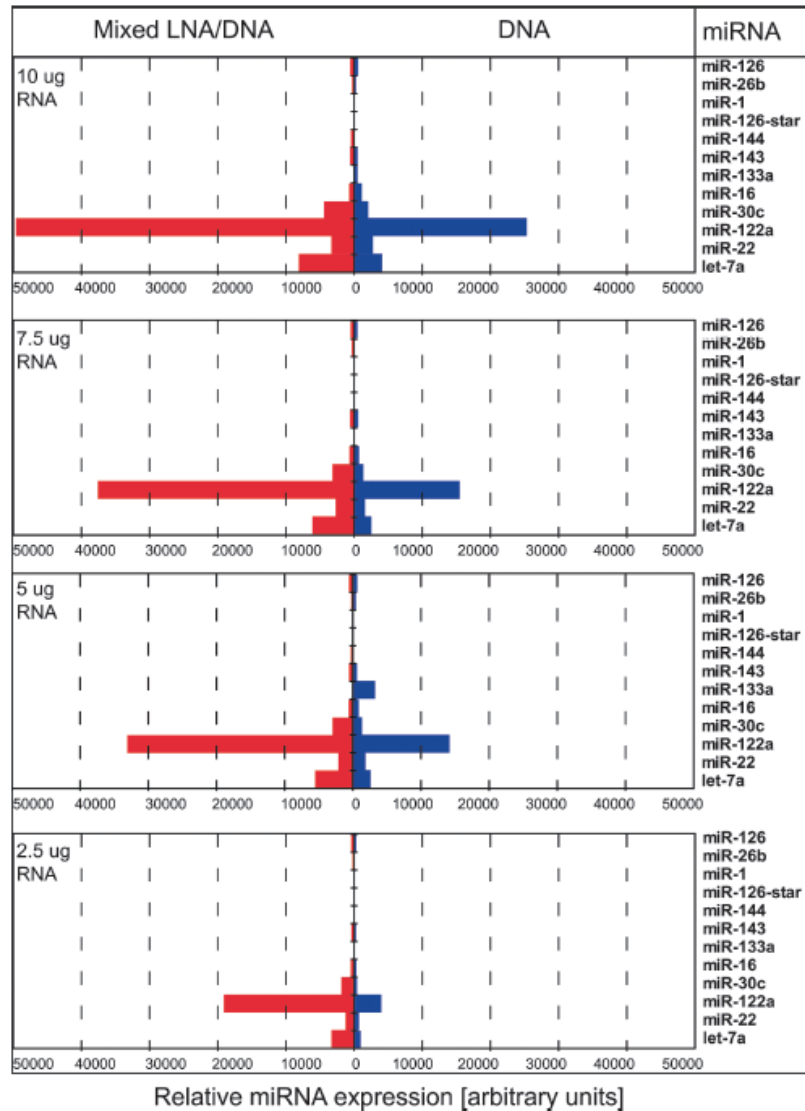
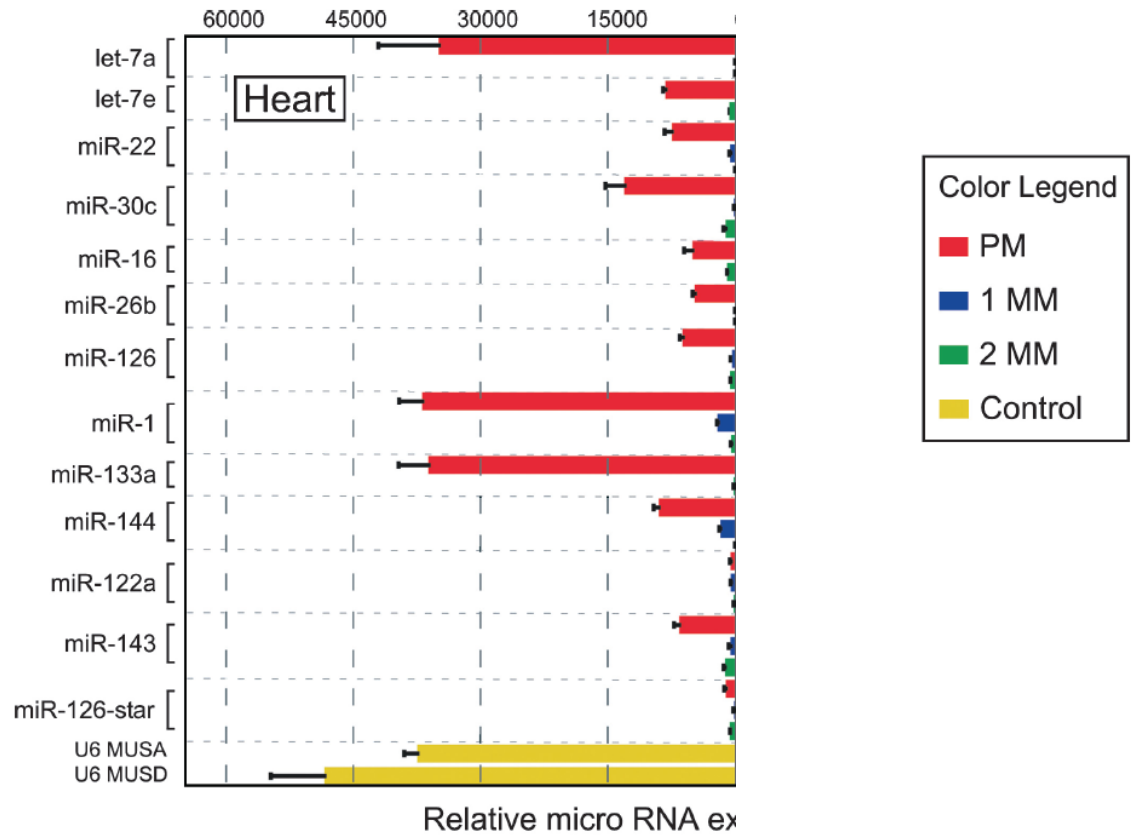

FIGURE 1. Mixed DNA/LNA capture probes display increased sensitivity for miRNA detection. miRNA expression was assessed in murine liver using a test set of LNA-modified (*left*) or unmodified DNA oligonucleotide capture probes (*right*). Decreasing amounts of total RNA were used as input material for miRNA analysis. Data are presented as median intensity (four replicas per miRNA capture probe; a representative experiment is shown).

SPECIFITA VAZBY: LNA vs DNA próba

(Castoldi et al., 2006)



miRCURY LNA Array, Exiqon : 3 dny

Protocol overview

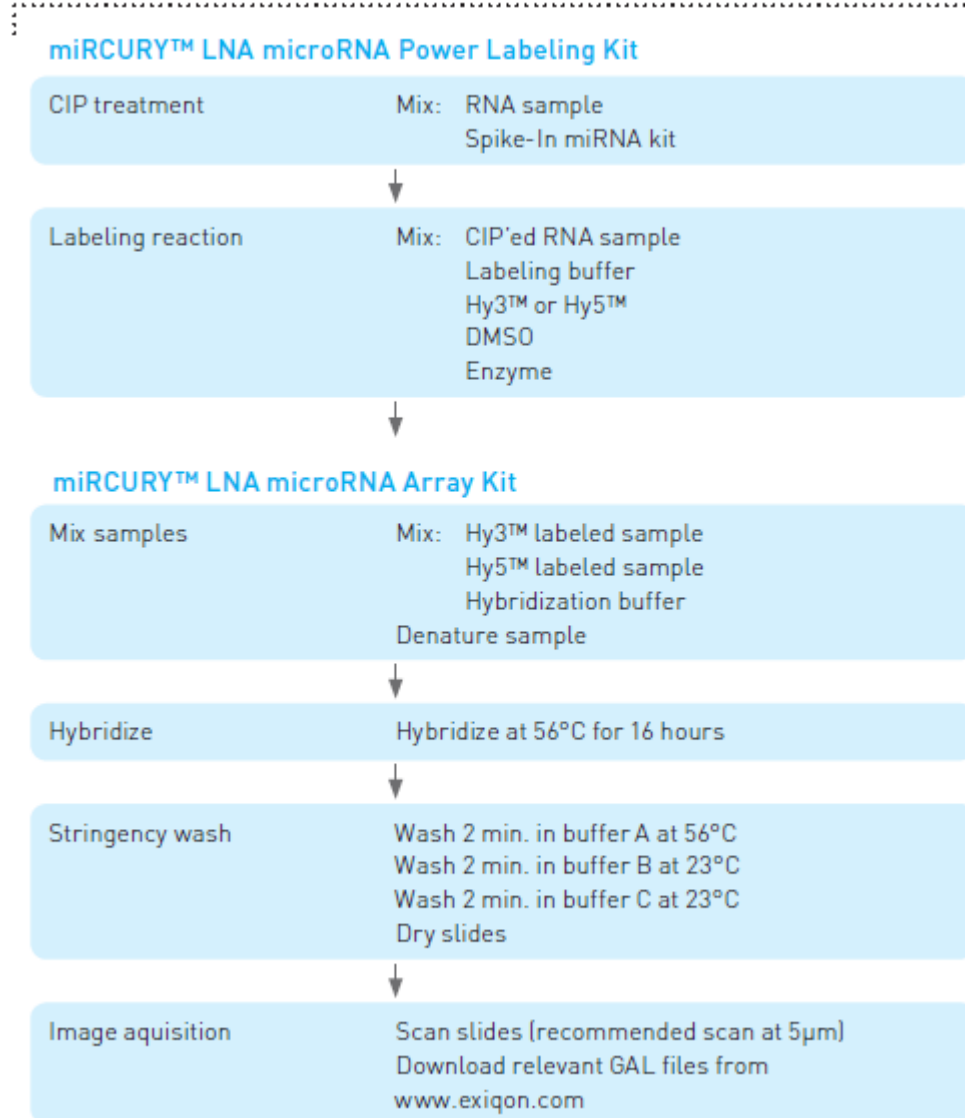

Co se nemusí podařit:

Nekvalitní RNA

Nepodaří se značení

Nepodaří se hybridizace

Nepodaří se promývání

Technická variabilita čipů je větší než ta biologická

Nepodaří se validace dat pomocí RT-PCR, atd

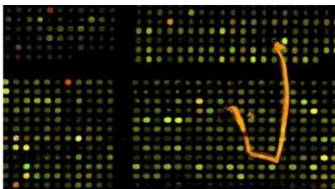

Fiber or scratch?

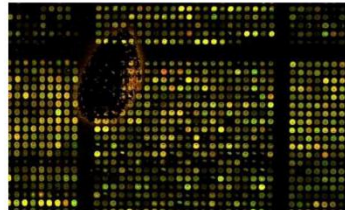

Bubble

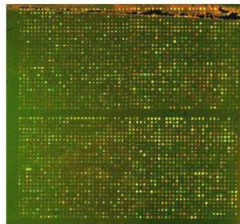

Edge effect

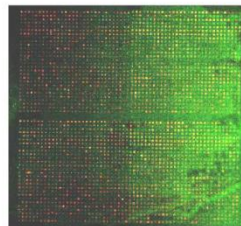

Background haze

Práce s miRNA čipy je velmi obtížná. Všeobecně nižší míra standardizace. Obtížná interpretace získaných dat z pohledu biologického smyslu např. deregulace několika miRNA (nádor vs. zdravá tkáň apod.)

ODPOČINEK?

Year 2K “Central dogma” of molecular oncology

Cancer is the GENETIC DISEASE with the most complex mechanism.
Oncogenes and Tumor-suppressors are the two types of PROTEINS deregulated in cancer cells.

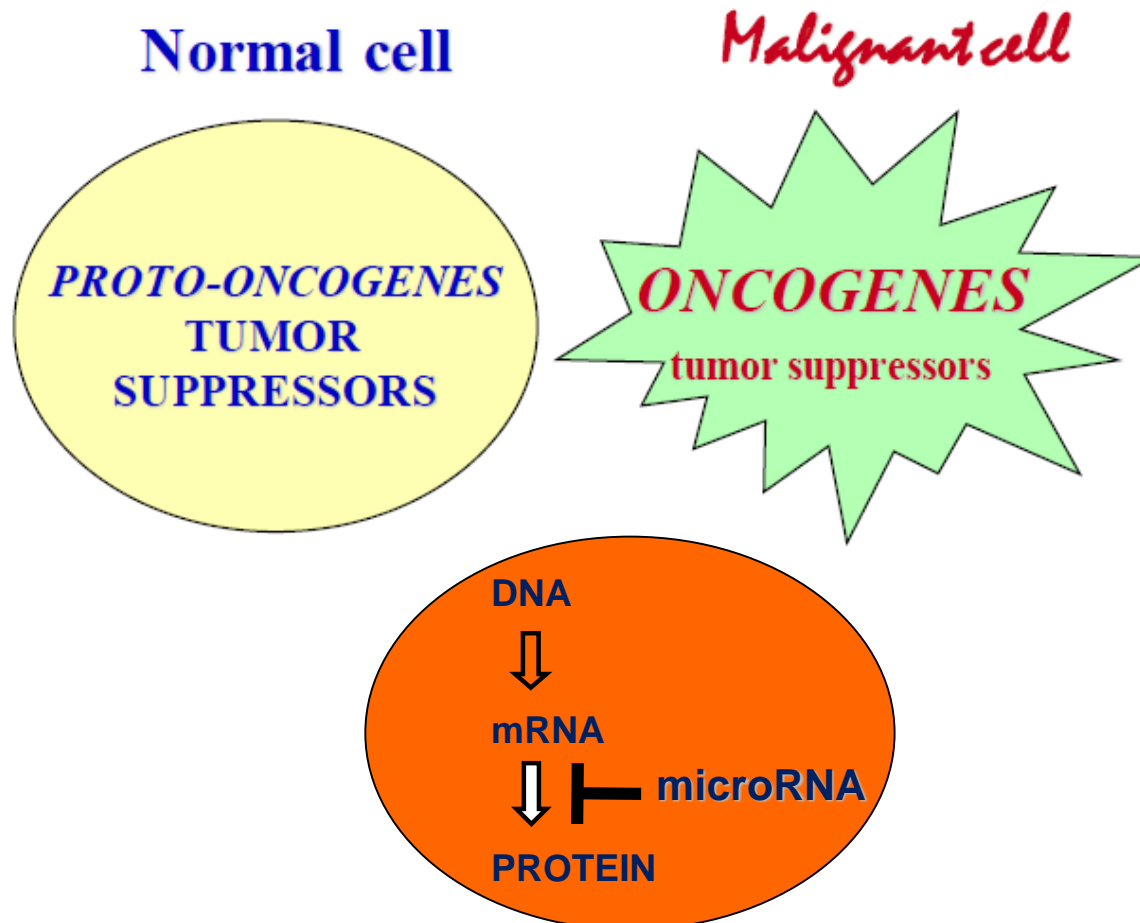

MicroRNAs were discovered by V. Ambros and G. Ruvkun in *C. elegans*

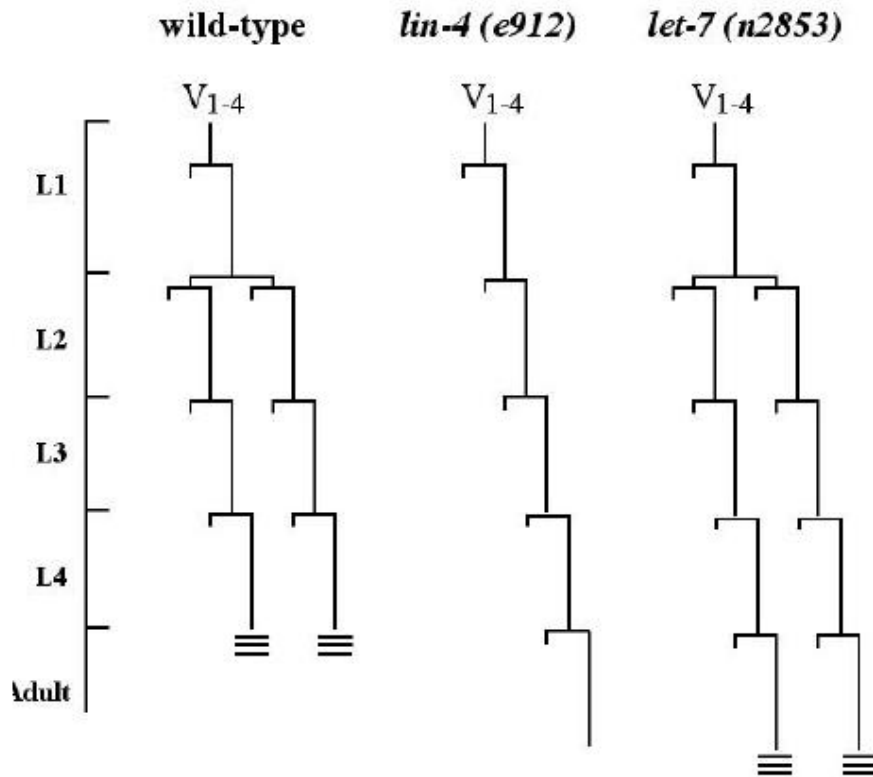

Lee et al. 1993 *Cell*

Reinhart et al. 2000 *Nature*

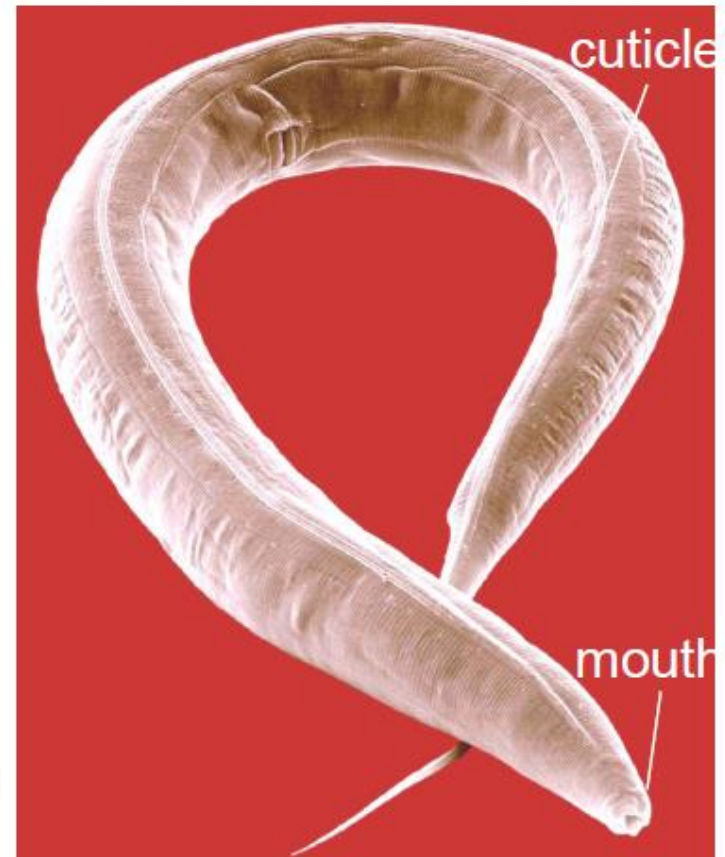

microRNA exprese je schopná rozlišit původ nádoru

a

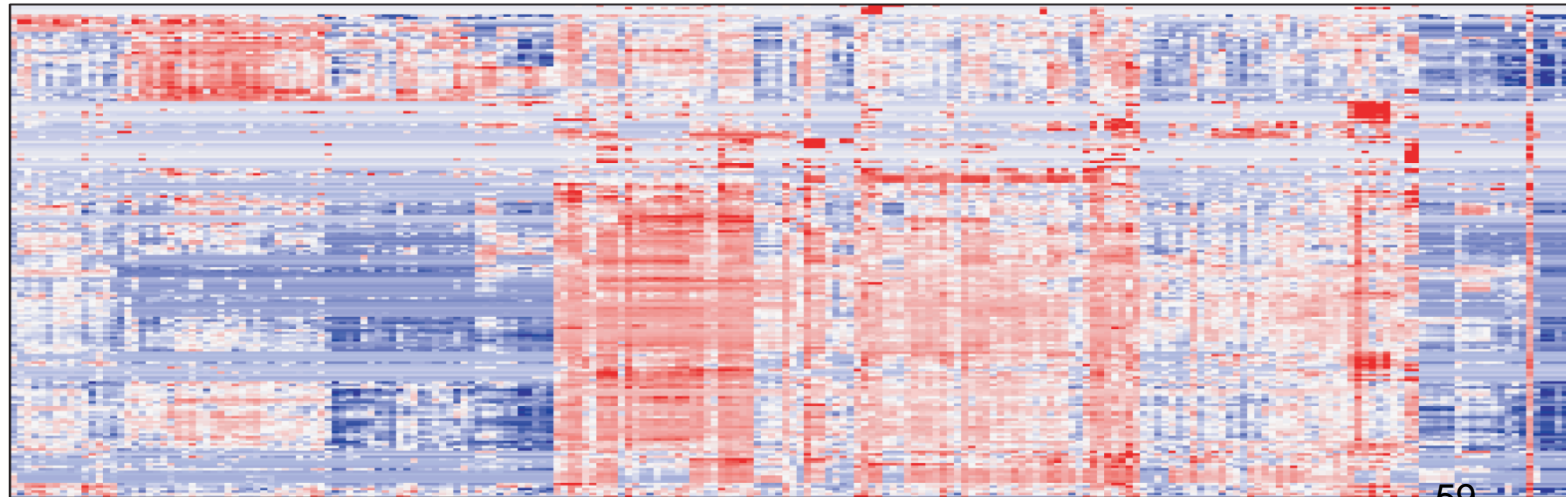
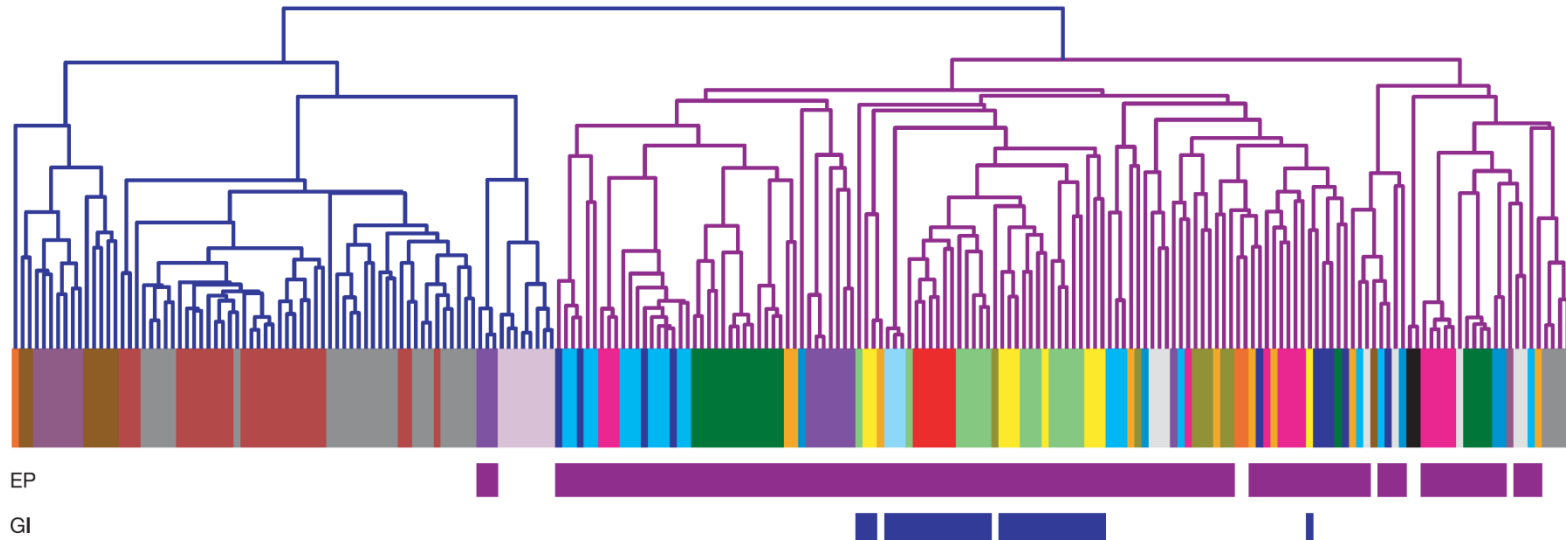

A microRNA expression signature of human solid tumors defines cancer gene targets

Stefano Volinia^{*††}, George A. Calin^{*‡}, Chang-Gong Liu^{*}, Stefan Ambs[§], Amelia Cimmino^{*}, Fabio Petrocca^{*}, Rosa Visone^{*}, Marilena Iorio^{*}, Claudia Roldo^{*}, Manuela Ferracin[¶], Robyn L. Prueitt[§], Nozumu Yanaihara[§], Giovanni Lanza[¶], Aldo Scarpa^{||}, Andrea Vecchione^{**}, Massimo Negrini[¶], Curtis C. Harris[§], and Carlo M. Croce^{*††}

^{*}Department of Molecular Virology, Immunology, and Medical Genetics and Cancer Comprehensive Center, Ohio State University, Columbus, OH 43210; [§]Laboratory of Human Carcinogenesis, Center for Cancer Research, National Cancer Institute, National Institutes of Health, Bethesda, MD 20892; [†]Telethon Facility–Data Mining for Analysis of DNA Microarrays, Department of Morphology and Embryology, and [¶]Department of Experimental and Diagnostic Medicine and Interdepartmental Center for Cancer Research, University of Ferrara, 44100 Ferrara, Italy; ^{||}Department of Pathology, University of Verona, 37100 Verona, Italy; and ^{**}Department of Histopathology, Sant'Andrea Hospital, and University of Rome "La Sapienza," 00185 Rome, Italy

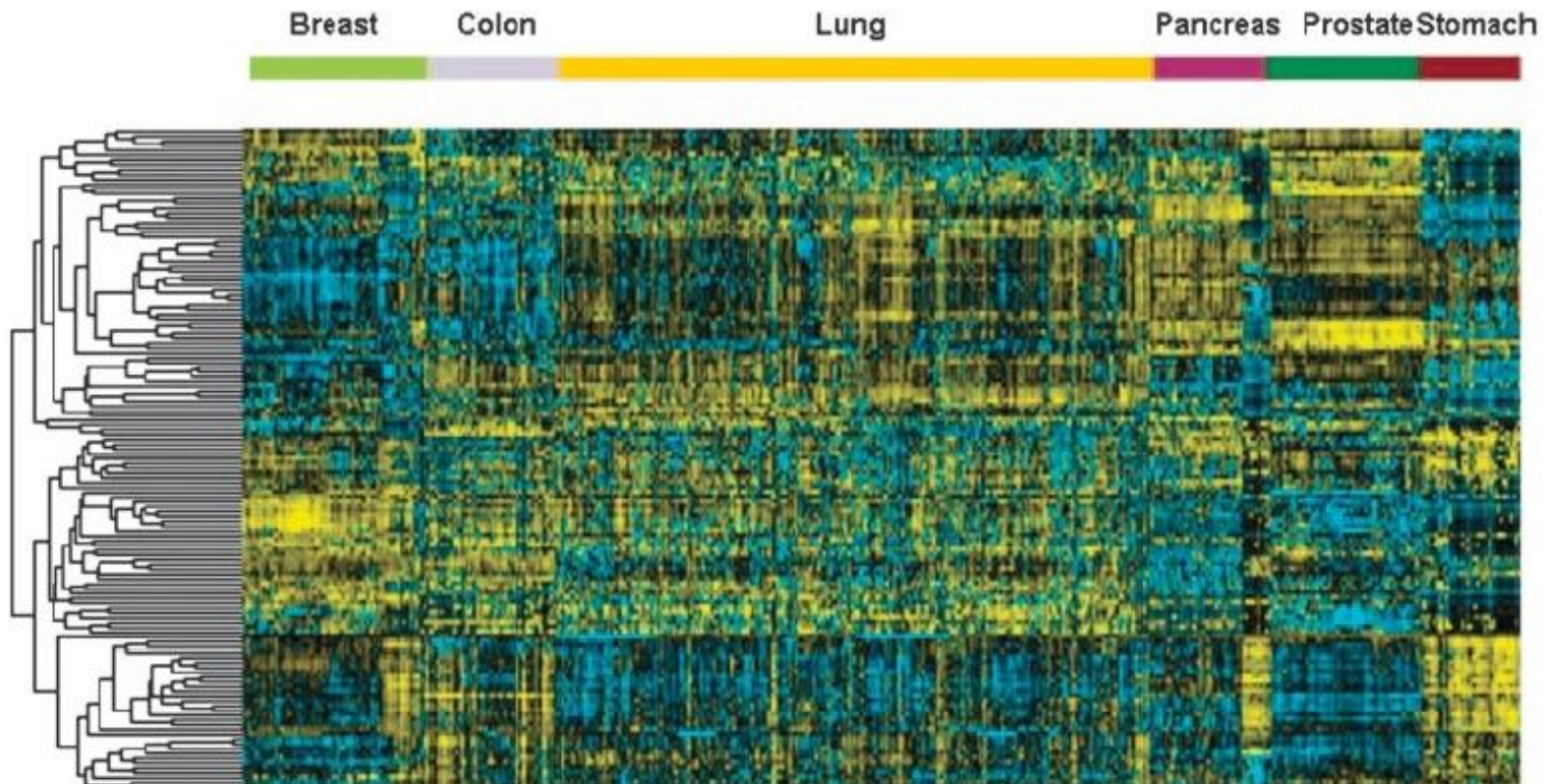
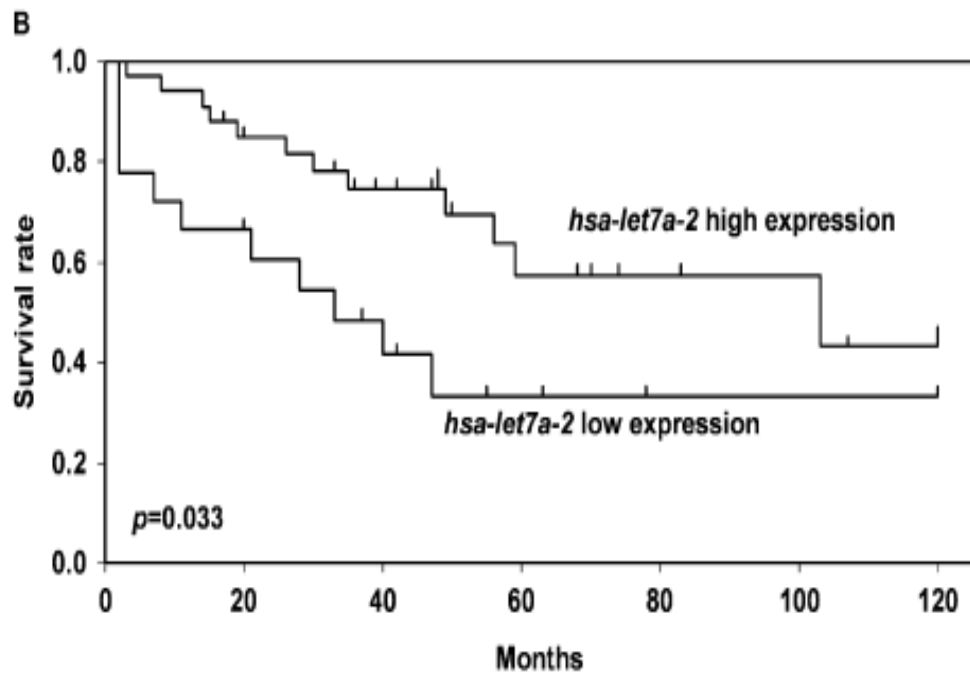
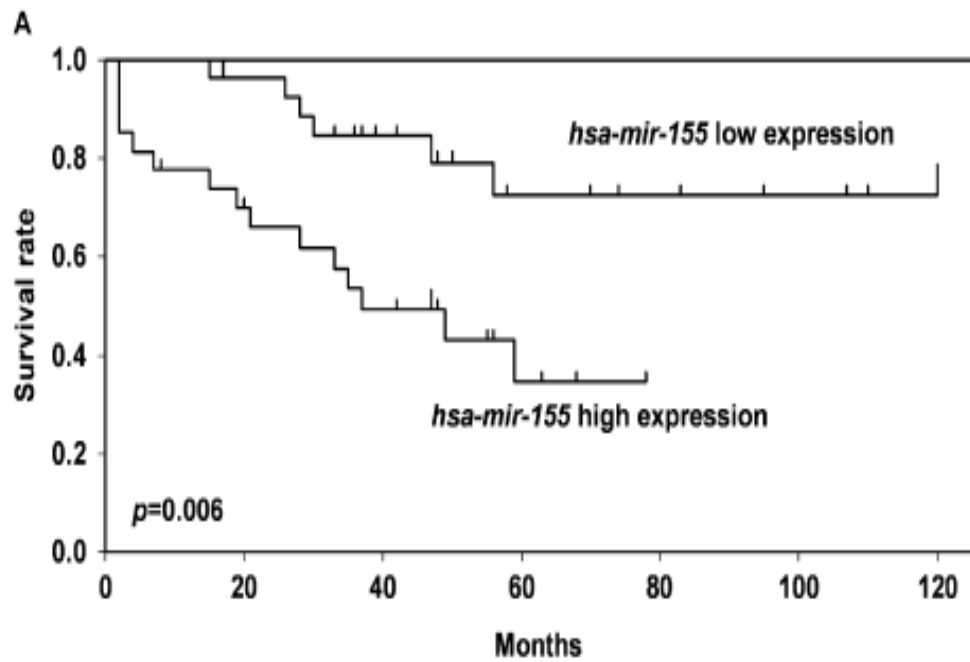

Table 2. The miRNAs shared by the signatures of the six solid cancers

miR	<i>N</i>	Tumor type
miR-21	6	Breast, colon, lung, pancreas, prostate, stomach
miR-17-5p	5	Breast, colon, lung, pancreas, prostate
miR-191	5	Colon, lung, pancreas, prostate, stomach
miR-29b-2	4	Breast, colon, pancreas, prostate
miR-223	4	Colon, pancreas, prostate, stomach
miR-128b	3	Colon, lung, pancreas
miR-199a-1	3	Lung, pancreas, prostate
miR-24-1	3	Colon, pancreas, stomach
miR-24-2	3	Colon, pancreas, stomach
miR-146	3	Breast, pancreas, prostate
miR-155	3	Breast, colon, lung
miR-181b-1	3	Breast, pancreas, prostate
miR-20a	3	Colon, pancreas, prostate
miR-107	3	Colon, pancreas, stomach
miR-32	3	Colon, pancreas, prostate
miR-92-2	3	Pancreas, prostate, stomach
miR-214	3	Pancreas, prostate, stomach
miR-30c	3	Colon, pancreas, prostate
miR-25	3	Pancreas, prostate, stomach
miR-221	3	Colon, pancreas, stomach
miR-106a	3	Colon, pancreas, prostate

The list includes 21 commonly up-regulated microRNAs in 3 or more (*N*) types of solid cancers (P value = 2.5×10^{-3}).



A unique miRNA signature is associated with lung cancer prognosis

Table 5. Postoperative survival of patients with lung adenocarcinoma in relation to clinicopathological characteristics and miRNA expression analyzed by microarray analysis

Variable	Subset	Hazard ratio (95% confidence interval)	p
→ Univariate analysis (n = 65)			
Age	age ≥ 67/age < 67	1.41 (0.67–3.06)	0.348
Sex	male/female	1.36 (0.64–2.93)	0.413
Stage	II–IV/I	2.51 (1.29–6.82)	0.010
Smoking history	current/former	1.32 (0.63–2.79)	0.456
→ hsa-mir-155 (n = 55)	high/low	3.42 (1.42–8.19)	0.006
→ hsa-let-7a-2 (n = 52)	low/high	2.35 (1.08–6.86)	0.033
→ Multivariate analysis (n = 55) ^{a,b}			
Age	age ≥ 67/age < 67	1.92 (0.71–5.17)	0.195
Sex	male/female	1.23 (0.47–3.22)	0.669
Stage	II–IV/I	3.27 (1.31–8.37)	0.013
Smoking history	current/former	1.49 (0.51–4.34)	0.457
→ hsa-mir-155	high/low	3.03 (1.13–8.14)	0.027

^aMultivariate analysis, Cox proportional hazard regression model.

^bhsa-let-7a-2 low/high was not statistically significant (p = 0.129).

A polycistronic cluster of microRNAs are overexpressed in cancer

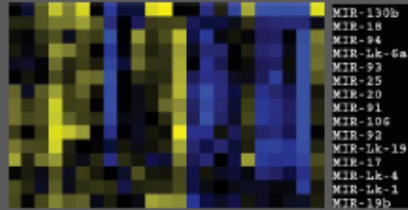

Proliferation

Angiogenesis

Apoptosis

Invasiveness



Ch13-ORF25



OncomiR-1 (Oncogenic microRNA-1)

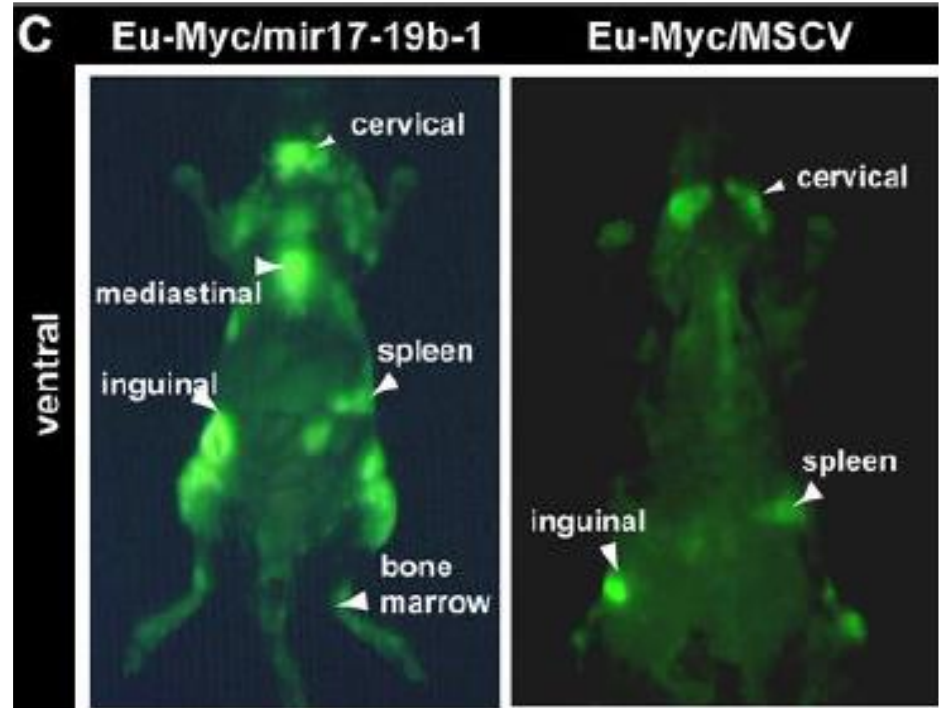
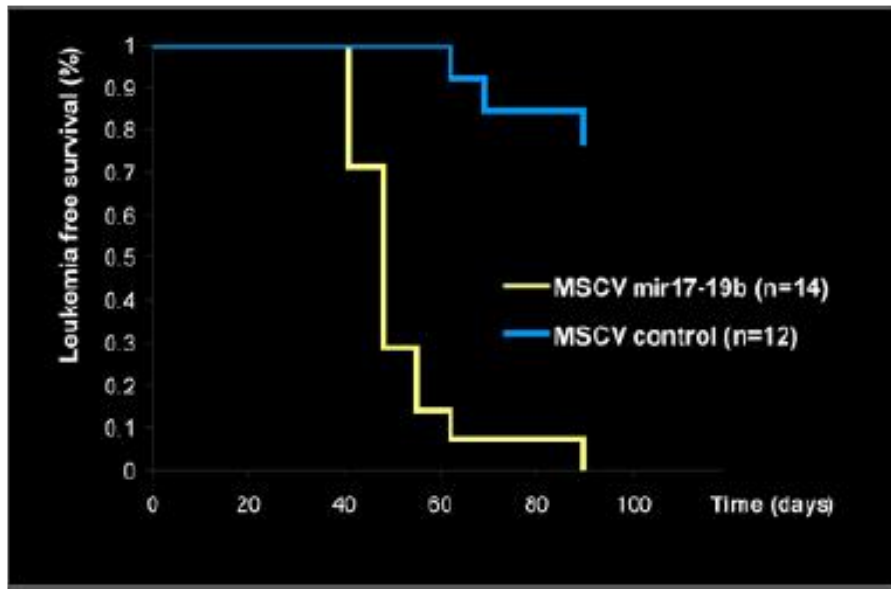

Chronická lymfatické leukémie

- ❑ Z maturovaných B lymfocytů
- ❑ Nejčastější leukémie dospělých
- ❑ Extrémně variabilní prognóza
- ❑ Nejčastější aberace del13q14 – obsahuje 2 miRNA (miR-15a, miR-16)

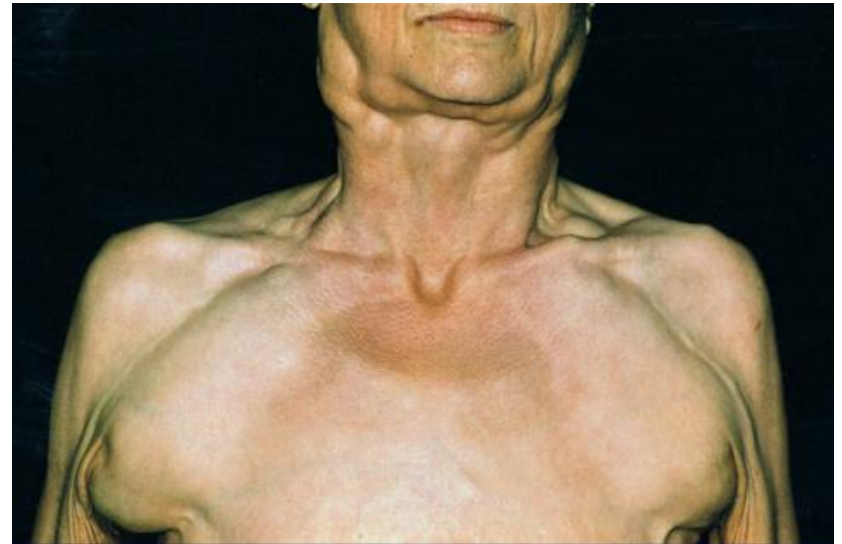
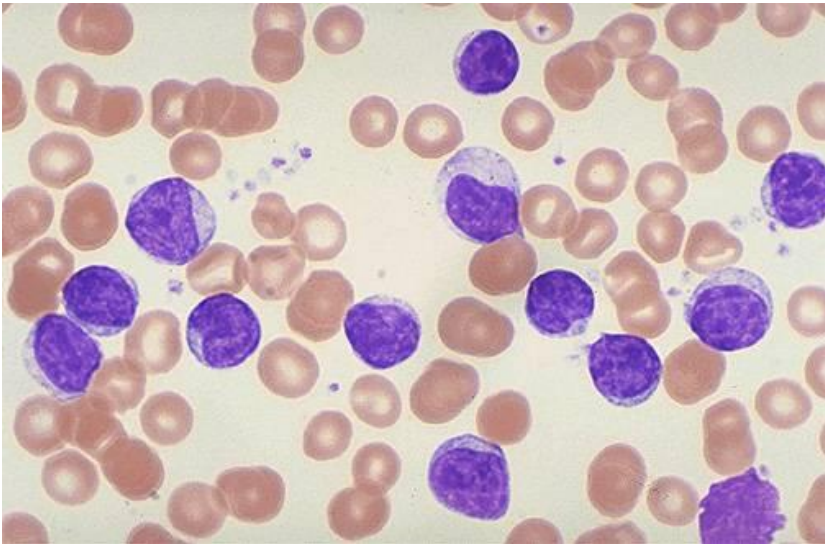

Expresse miRNA asociuje s prognostickými subtypy CLL

~ 20 miRNAs

Calin et al., 2005
Fulci et al., 2007
Zenz et al., 2009
Stamatopoulos et al., 2009
Mraz et al., 2009a, 2009b, 2012, 2014

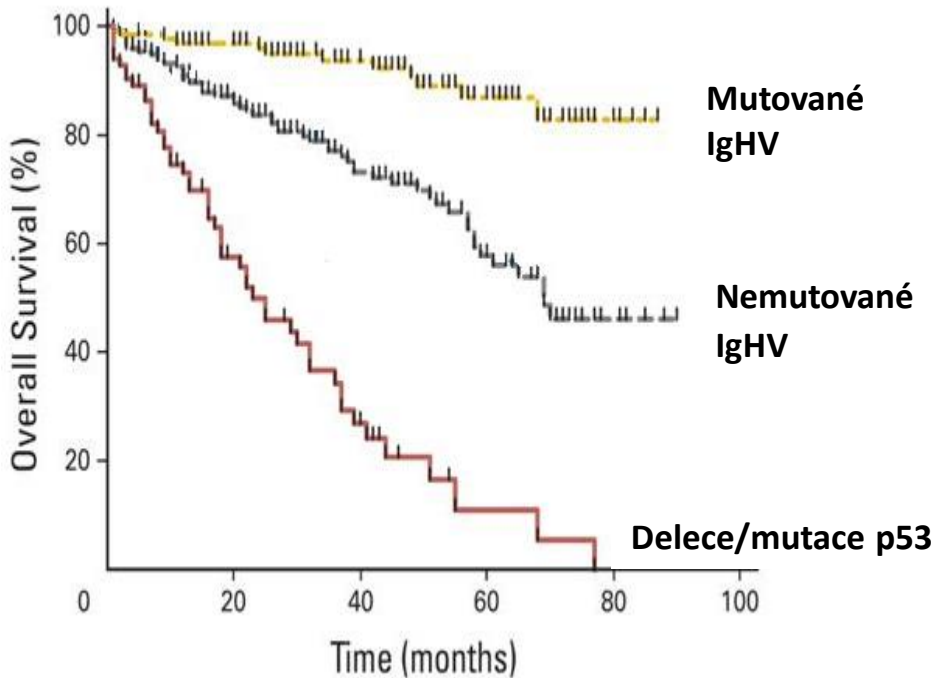

Nižší hladiny miR-150 asociují s kratším celkovým přežitím a časem do první léčby

n = 168

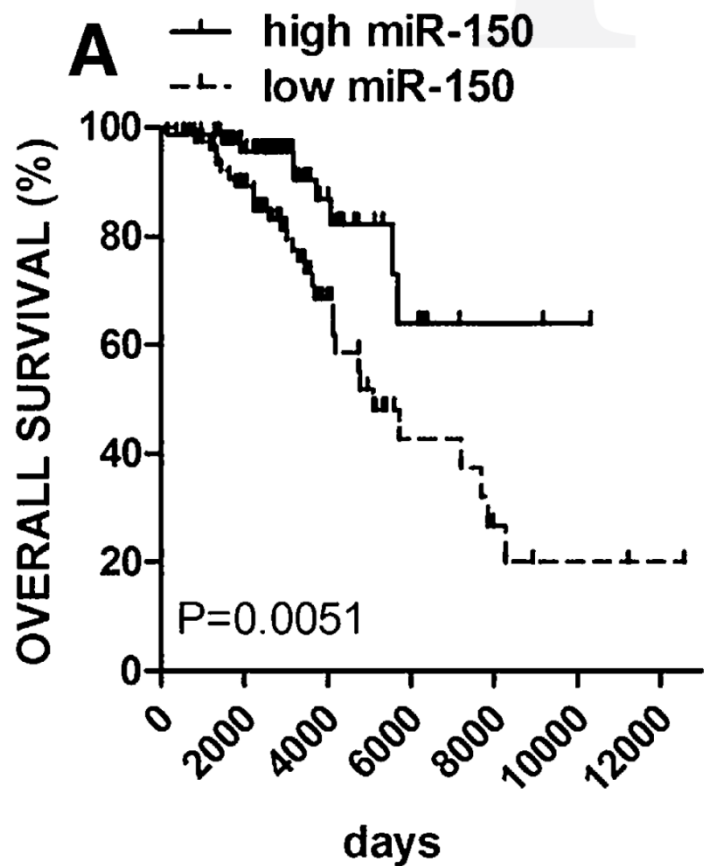

Variable ^{&}	HR [#]	CI [#]	P-val [#]	
miR-150 (\leq vs. $>$ median)	5.6	2.1-14.9	0.001	
IGHV (unmut. vs. mut.)	2.8	0.9-9.1	0.08	
ZAP-70 (pos. vs. neg.)	5.6	1.7-17.9	0.004	
CD38 (pos. vs. neg.)	1.4	0.7-2.9	0.37	
Gender (male vs. female)	2.9	1.3-6.5	0.008	
Rai stage	I vs. 0	4.9	1.4-17	0.01
	II vs. 0	6.6	1.7-25.8	0.01
	\geq III vs. 0	3.6	1-13.1	0.05
Age ($>$ vs. \leq median)	3.0	1.4-6.8	0.01	

Jak identifikovat cíle miR-150 u CLL?

(HG-U133 Plus 2.0, Affymetrix)

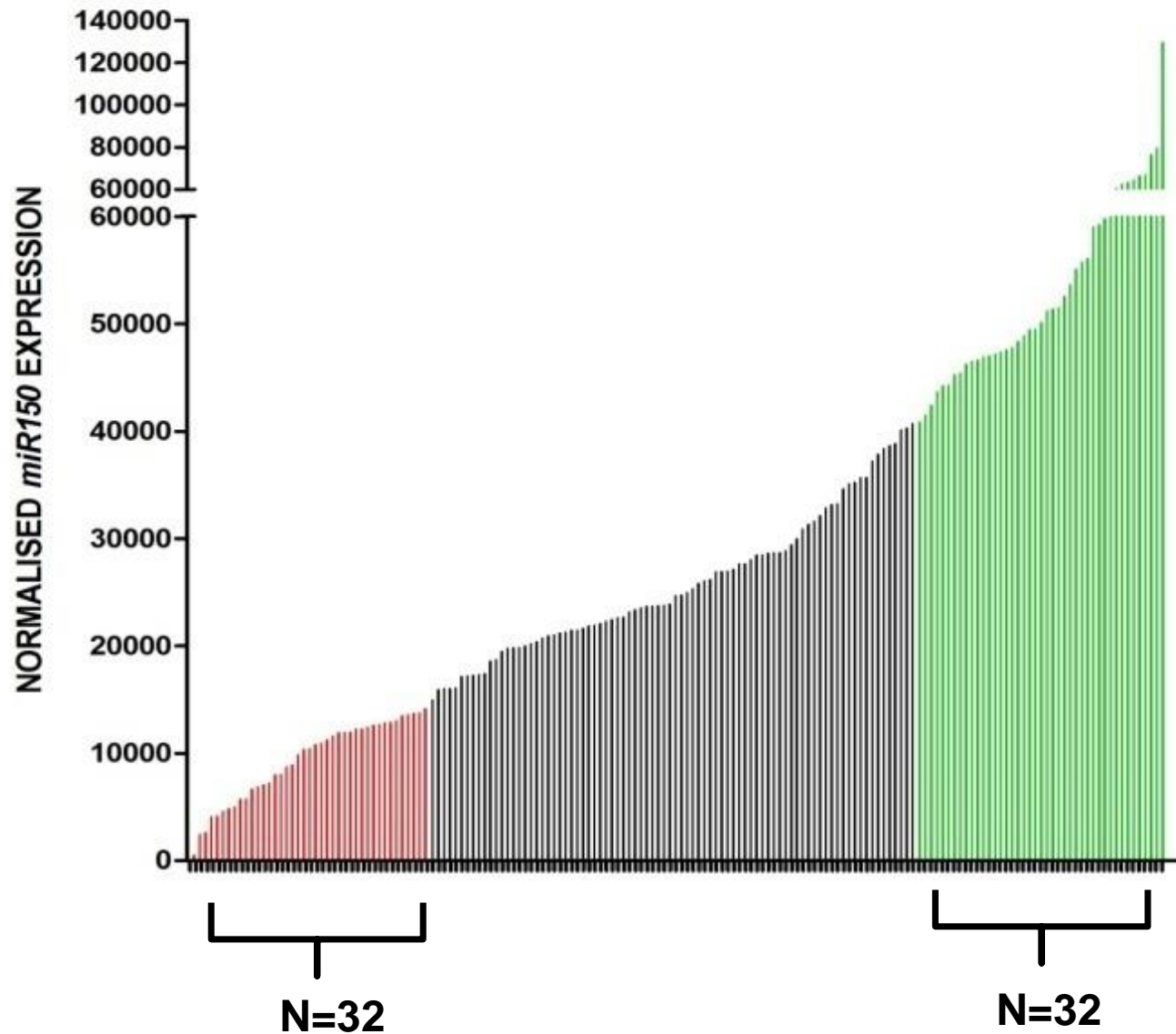

Genové expresní čipy pro CLL s nízkou vs vysokou hladinou miR-150

- 58 rozdílně exprimovaných genů
- 2 geny s evolučně konzervovanými vazebnými místy pro miR-150 – **GAB1 a FOXP1**

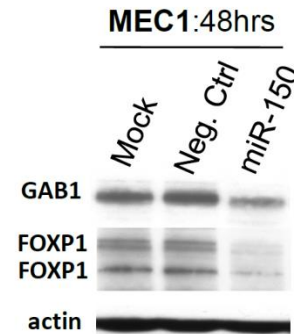
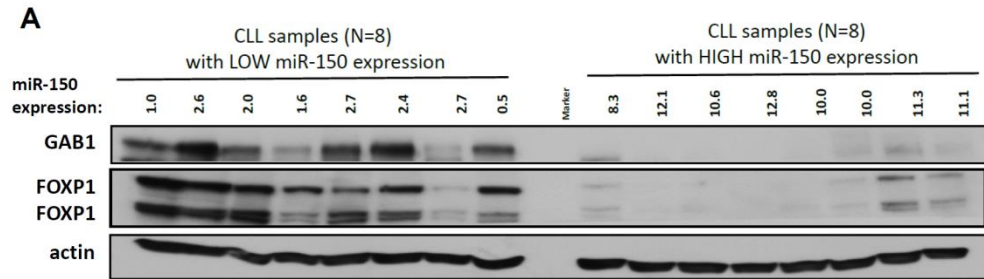
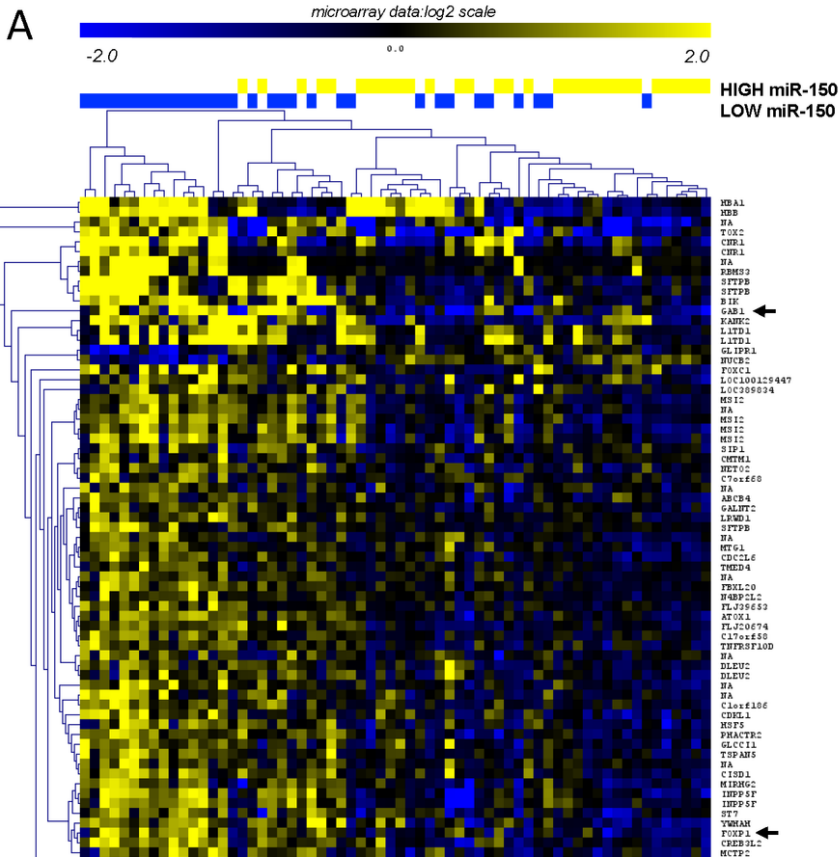

GAB1 je adaptorová molekula, která je nutná k vazbě PI3K na membránu a amplifikaci BCR signalizace (Ingham et al. JBC, 2001).

FOXP1 je transkripční faktor důležitý pro vývoj B lymfocytů a asociovaný s ABC DLBCL a progresí B buněčných lymfomů (Hu et al. Nat Immunol, 2006).

Adaptivní imunity- centrální dráha BCR

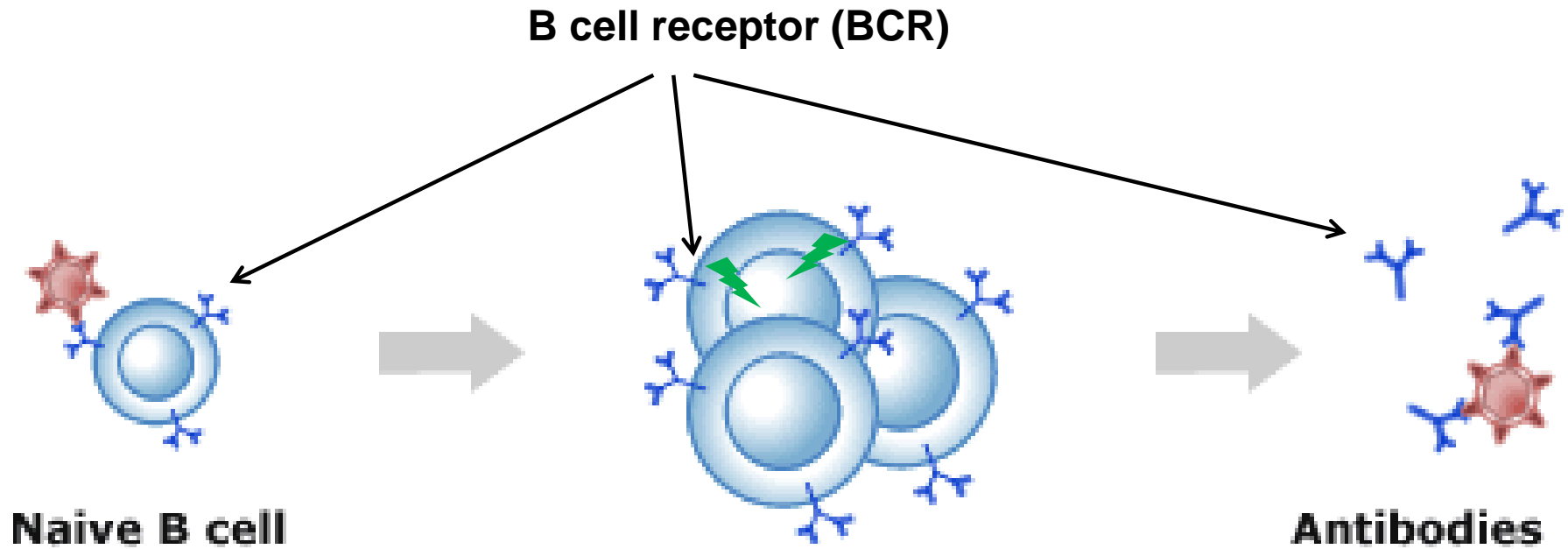

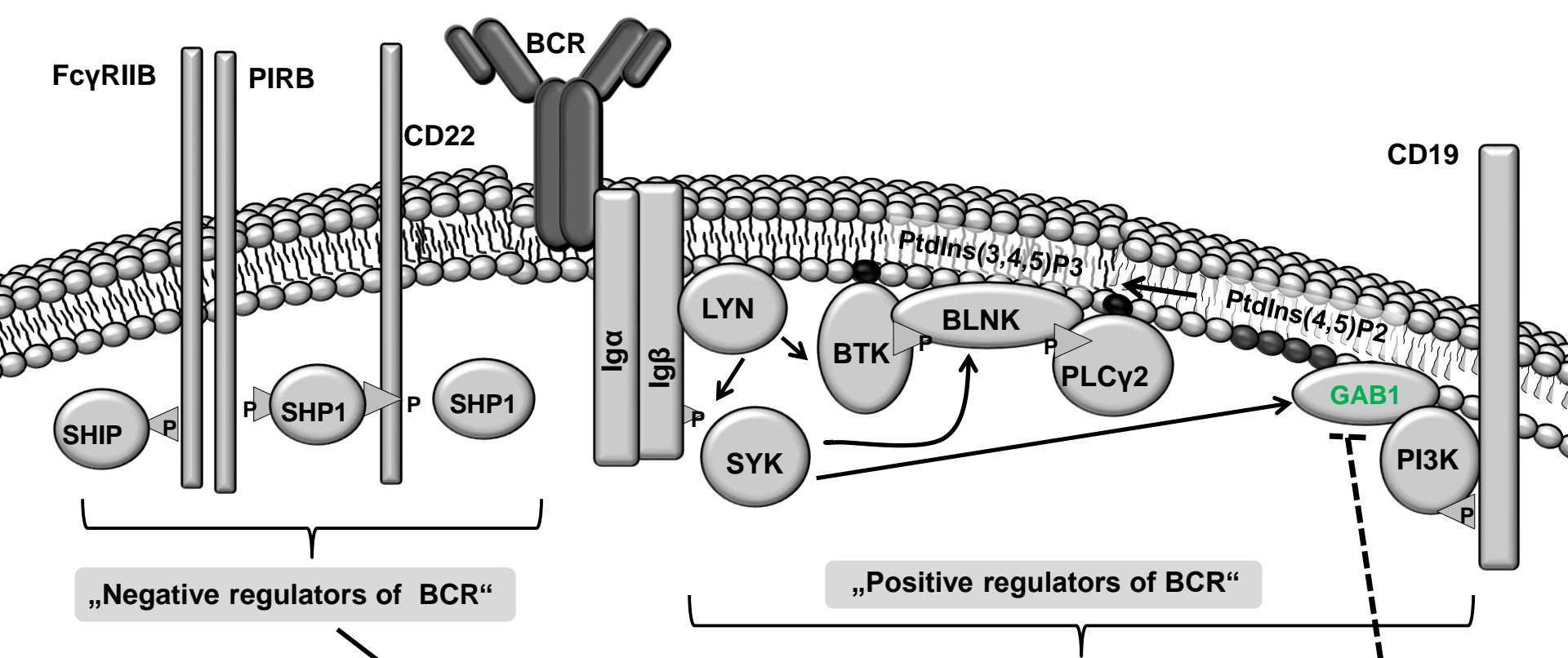

Popsali jsme první
příklad regulace BCR
signalizace
prostřednictvím
microRNA

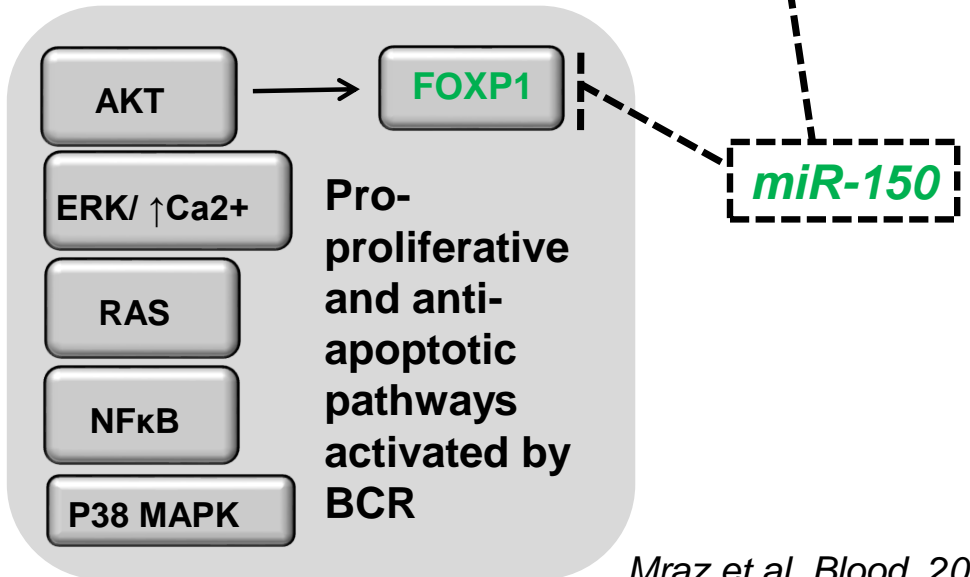

First description of miRNAs role in BCR signalling...not only in CLL

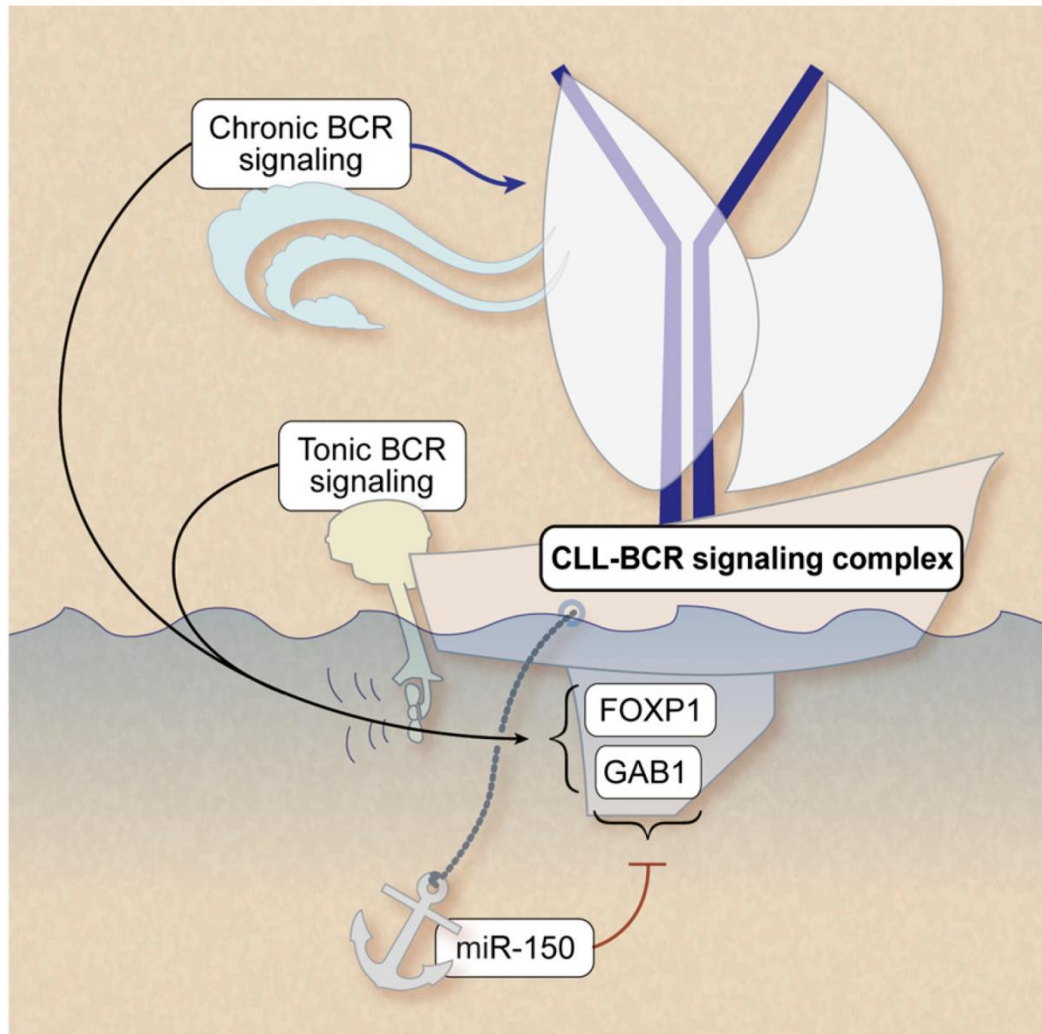

Ligand-independent ("tonic") and ligand-dependent ("chronic") BCR signaling play a pivotal role in CLL survival and growth. MiRNA-150 dampens the threshold for BCR signaling by repressing expression levels of GAB1 and FOXP1. Professional illustration by Debra T. Dartez.

- potentially useful as **therapeutic targets**

nature Vol 452 | 17 April 2008 | doi:10.1038/nature06783

LETTERS

LNA-mediated microRNA silencing in non-human primates

Joacim Elmén^{1*}, Morten Lindow^{1*}, Sylvia Schütz², Matthew Lawrence³, Andreas Petri¹, Susanna Obad¹, Marie Lindholm¹, Maj Hedtjärn¹, Henrik Frydenlund Hansen¹, Urs Berger⁴, Steven Gullans³, Phil Kearney¹, Peter Sarnow², Ellen Marie Straarup¹ & Sakari Kauppinen^{1,5}

PCR based therapeutics?!

blood

2012 120: 1678-1686
 Prepublished online July 13, 2012;
 doi:10.1182/blood-2012-02-410647

LNA-mediated anti-miR-155 silencing in low-grade B-cell lymphomas

Yong Zhang, Aldo M. Roccaro, Christopher Rombaoa, Ludmilla Flores, Susanna Obad, Stacey M. Fernandes, Antonio Sacco, Yang Liu, Hai Ngo, Phong Quang, Abdel Kareem Azab, Feda Azab, Patricia Maiso, Michaela Reagan, Jennifer R. Brown, To-Ha Thai, Sakari Kauppinen and Irene M. Ghobrial

miRNA sequestration

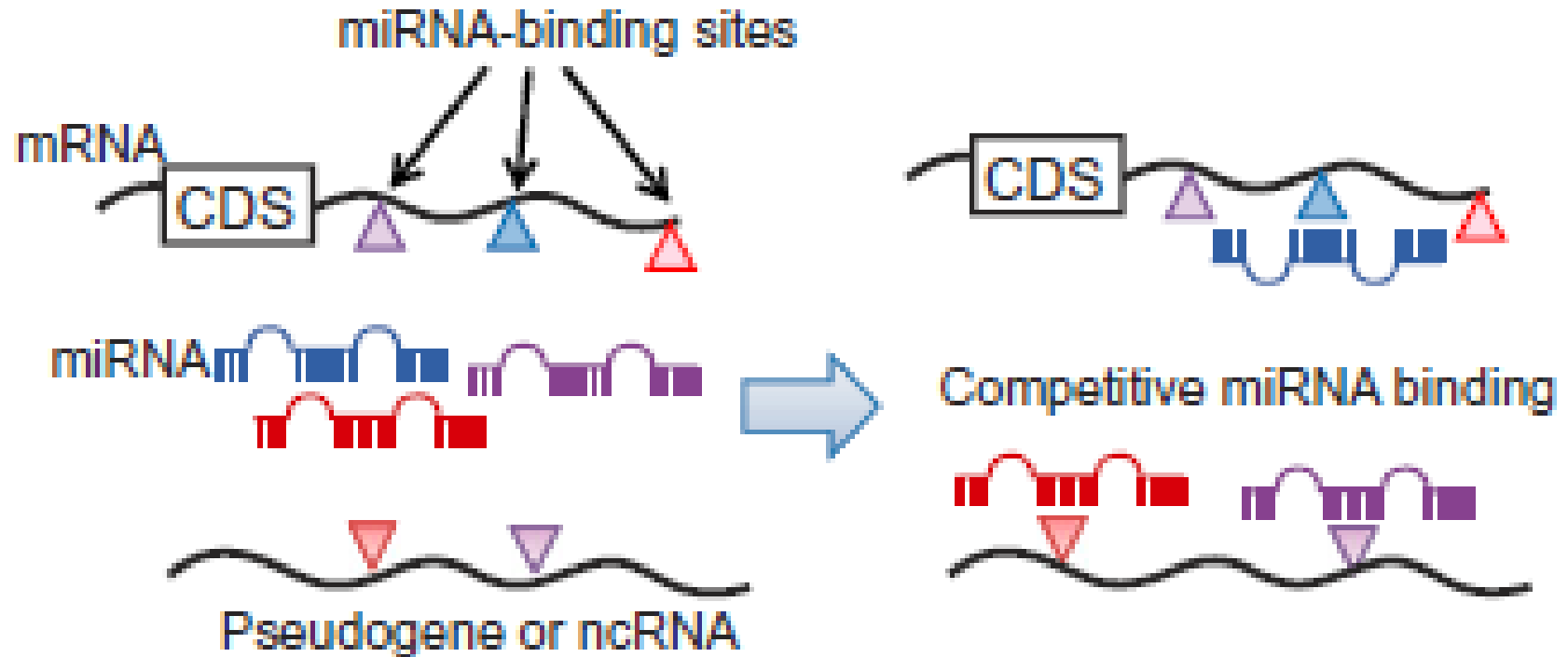

Díky za pozornost

CEITEC MU

Mraz Lab: Katerina Cerna, Katerina Musilova, Vasek Seda,
Gabriela Pavlasova, Veronika Svobodova, Sonali Sharma, Jan Oppelt

Marek.Mraz@email.cz

Ceitec.cz/mrazlab

Hledáme nadšené studenty (Bc, Mgr, PhD) a post-doky