

Skupenské stavy

Plyn

Skupenství vody	Teplota, °C (tlak 1 bar)	Hustota, g cm ⁻¹
pevné	0	0,9168
kapalné	25	0,9971
plynné	400	3,26 10 ⁻⁴



Kapalina



Molekulový krystal

Rozdíl mezi kovalentní vazbou a mezimolekulovými silami

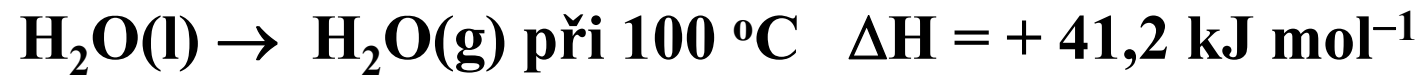
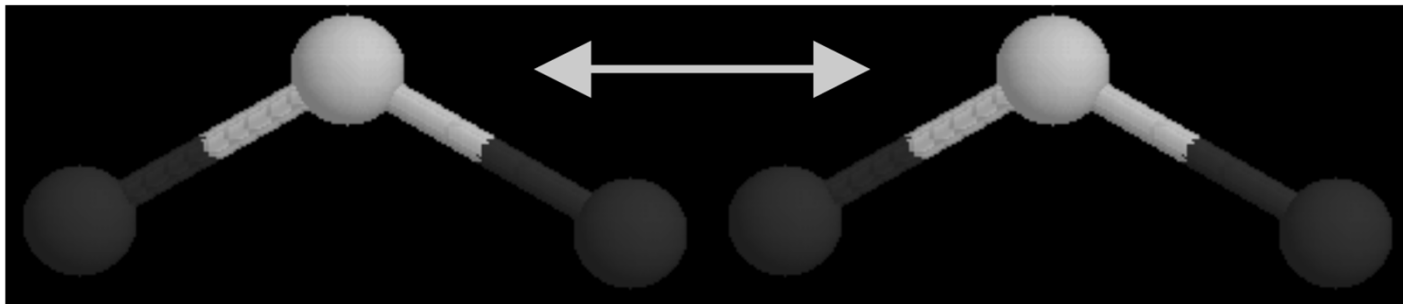
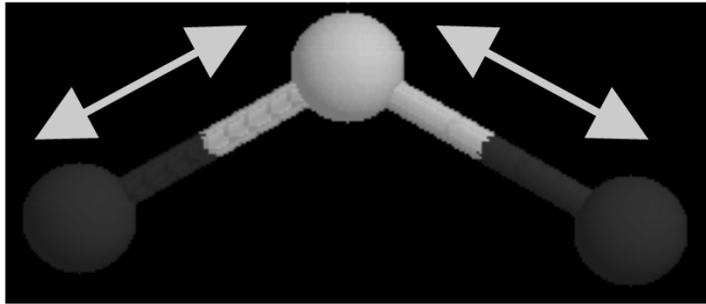

Typ vazby	Energie, kJ mol ⁻¹
Kovalentní	200 – 1000
Vodíková	10 – 50 (100)
Dipol-dipolová	2 – 10
Londonova disperzní	> 5

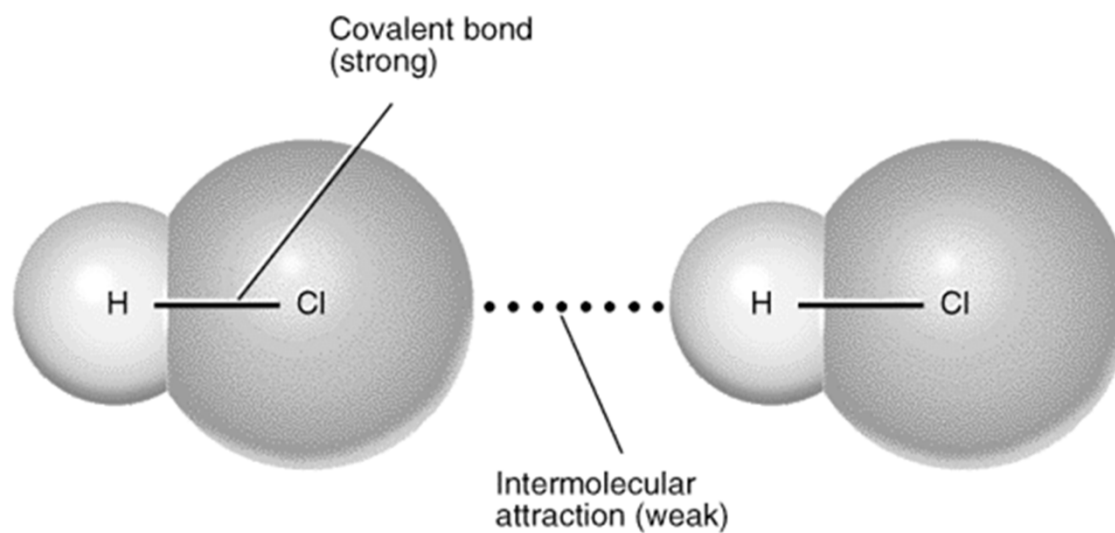

Typy mezimolekulových vazeb (van der Waalsových interakcí)

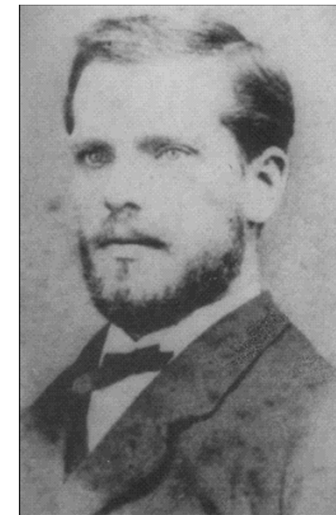

J. D. van der Waals
(1837- 1923)
NP za chemii 1910

- ion – ion Coulombické interakce
- ion – dipol
- dipol – dipol → orientační, Keesom
- dipol – indukovaný dipol → indukční, Debye
- ion – indukovaný dipol
- indukovaný dipol – indukovaný dipol → disperzní, London
- van der Waalsova repulze (odpuzování)

Interakce ion - ion

Coulombův zákon

$$E = \frac{1}{4\pi\epsilon_0} \frac{q_1 q_2}{r}$$

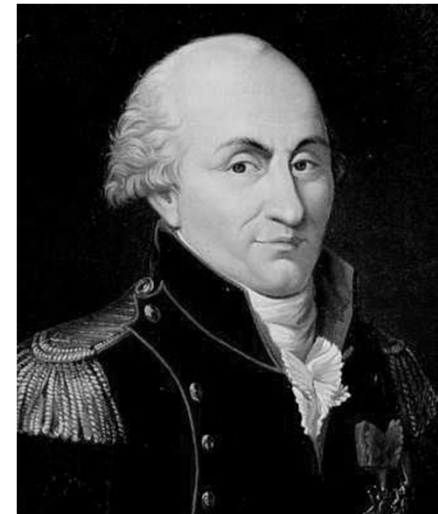

E = energie interakce
q = náboj iontu
r = meziiontová vzdálenost

Dipolový moment - μ

proton a elektron, vzdáleny 1 Å

$$\mu = q \times L = (1,60 \cdot 10^{-19} \text{ C})(1,00 \cdot 10^{-10} \text{ m})$$

$$= 1,60 \cdot 10^{-29} \text{ C m} = \mathbf{4,80 \text{ D}}$$

dipolový moment **4,80 D**

je referenční hodnota, čisté +1 a -1 náboje vzdálené 100 pm,
vazba mezi nimi je 100 % iontová

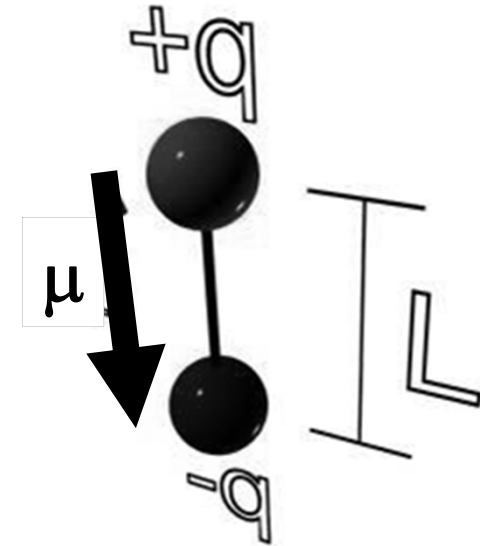

Interakce ion - dipol

$$E = -konst \frac{q^2 \mu^2}{kTr^4}$$

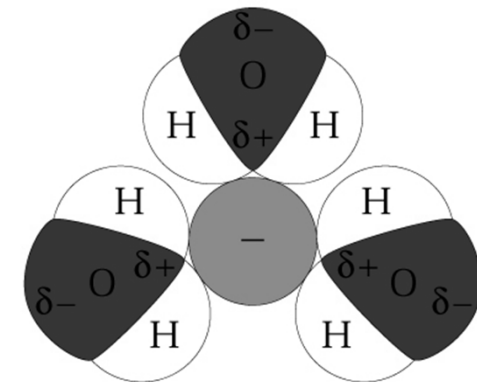
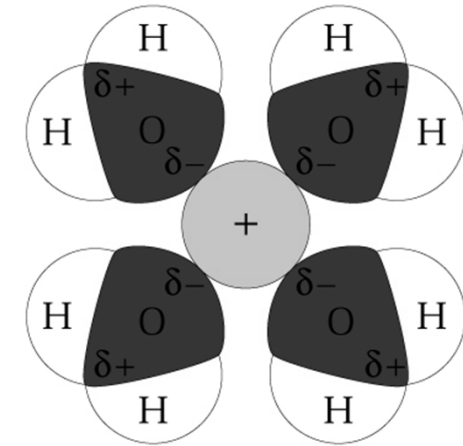
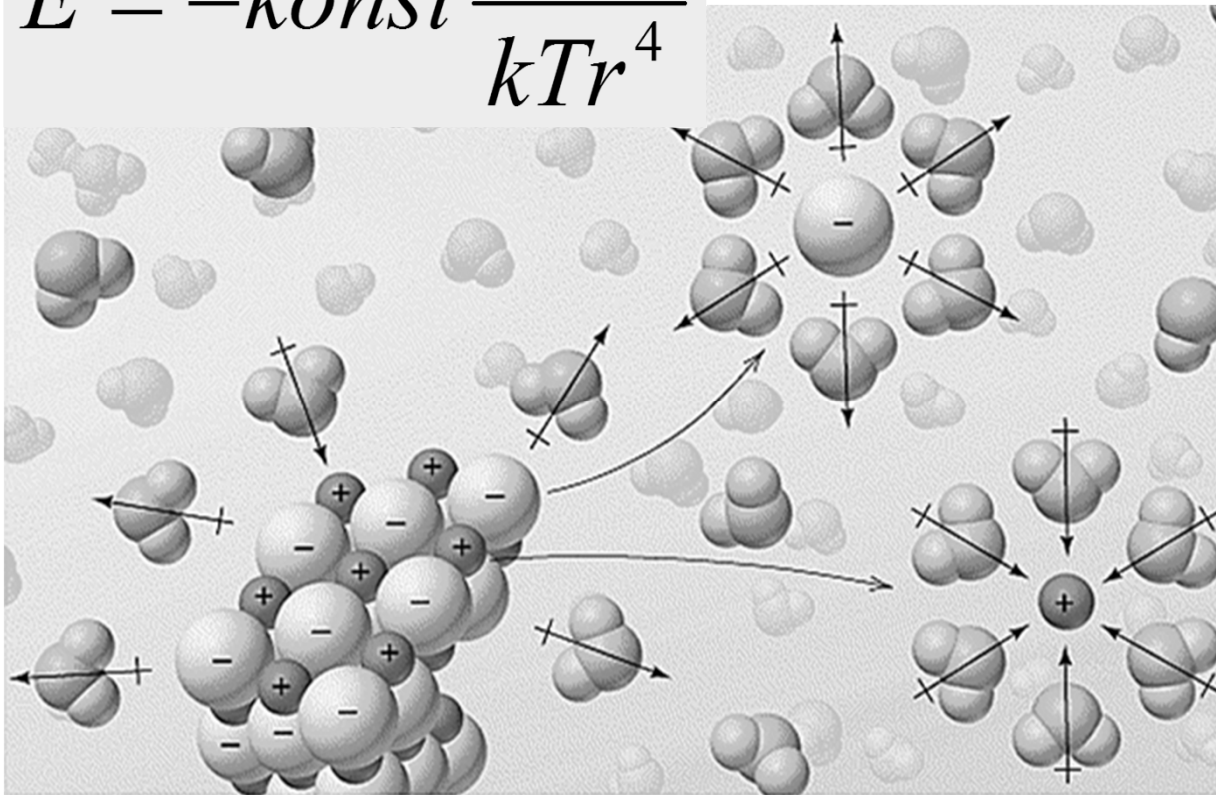

Copyright 1999 John Wiley and Sons, Inc. All rights reserved.

kT = škálovací faktor energií v molekulárních procesech
při 298 K: $kT = 4,11 \times 10^{-21}$ J

E = energie interakce
 q = náboj iontu
 μ = dipolový moment
 r = vzdálenost
 T = teplota
 k = Boltzmannova konstanta

Hydratace/solvatace iontů

Interakce klesá s rostoucí velikostí iontu

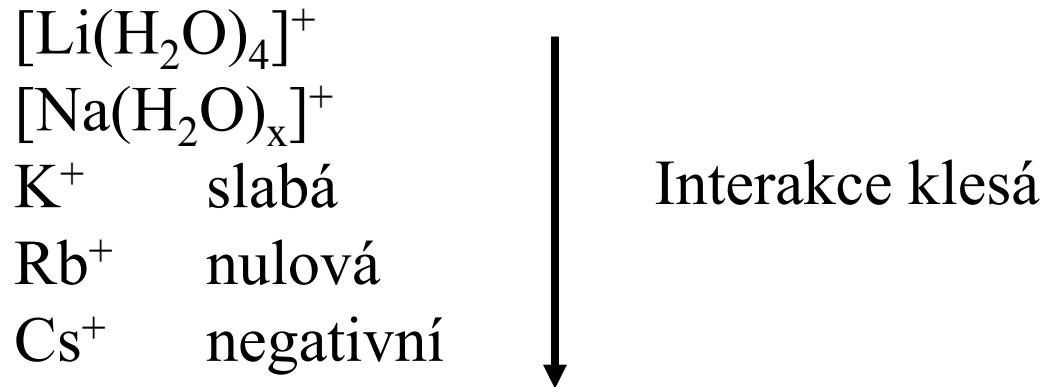

Interakce roste s rostoucím nábojem iontu

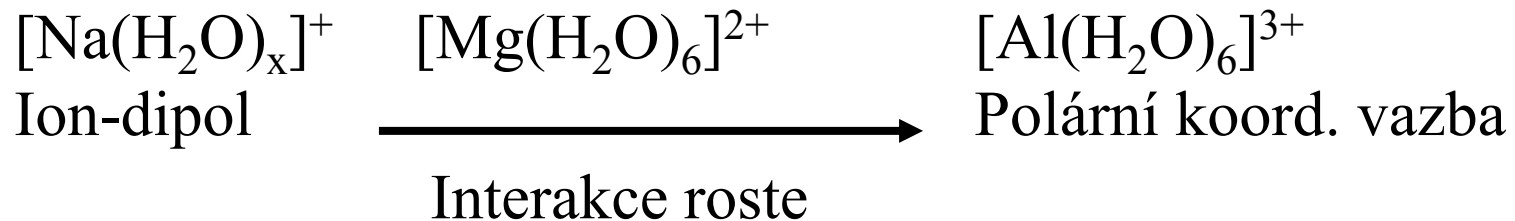

Solvatace elektronů

Sodík rozpuštěný v kapalném amoniaku

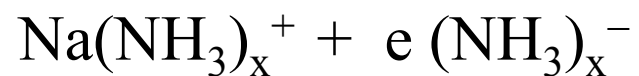

Modrý elektricky vodivý roztok, silné redukční činidlo

Solvatované elektrony (spinové páry)

Pomalá reakce

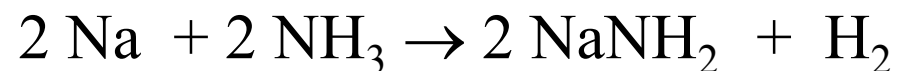

Interakce dipol - dipol

Keesom

$$E = -konst \frac{\mu_A^2 \times \mu_B^2}{kTr^6}$$

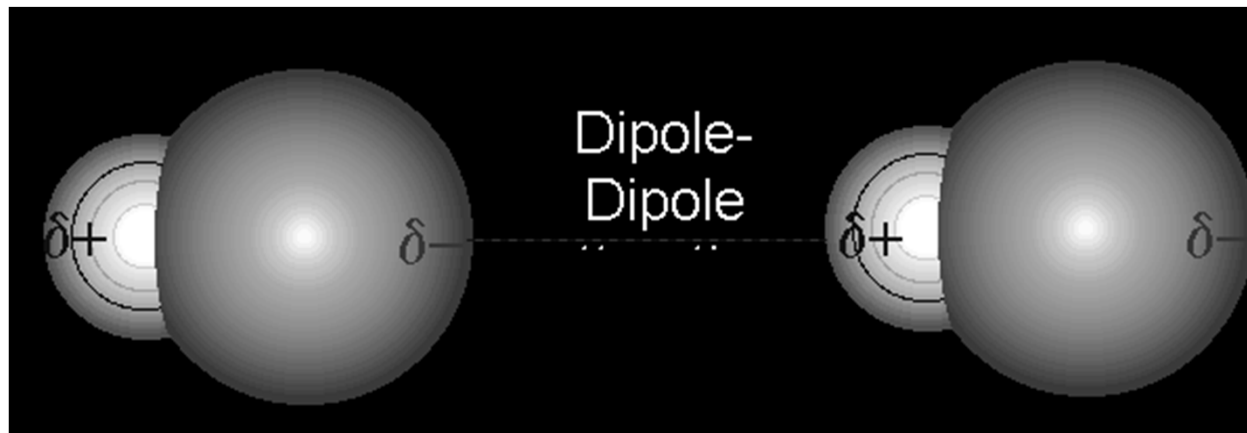
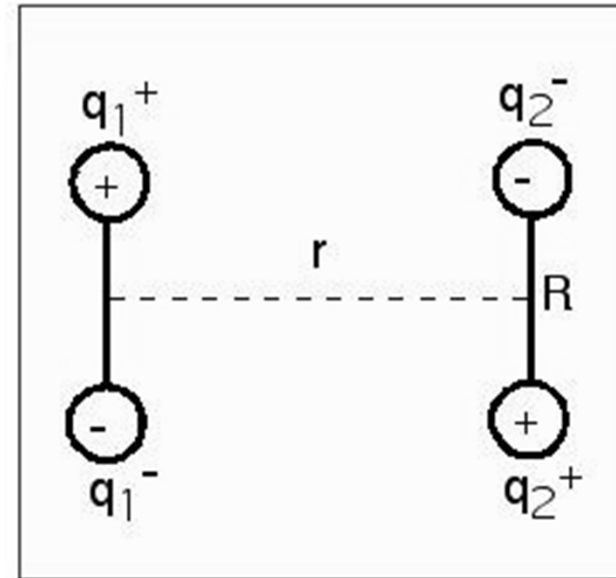

E = energie interakce
 μ = dipolový moment
r = vzdálenost
T = teplota
k = Boltzmannova konstanta

Interakce dipol - dipol

Sloučenina	Butan	Aceton
M_r	58	58
Teplota varu, °C	- 0,5	57
Dipolový moment, C m	0	$9,3 \cdot 10^{-30}$

Interakce ion – indukovaný dipol a dipol – indukovaný dipol

$$\mu(\text{indukovaný}) = \alpha E$$

α = polarizovatelnost

E = intenzita elektr. pole

ion – indukovaný dipol

$$E = -\textit{konst} \frac{q^2 \alpha}{r^4}$$

dipol – indukovaný dipol, Debye

$$E = -\textit{konst} \frac{\mu^2 \alpha}{r^6}$$

E = energie interakce

q = náboj

α = polarizovatelnost

μ = dipolový moment

r = vzdálenost

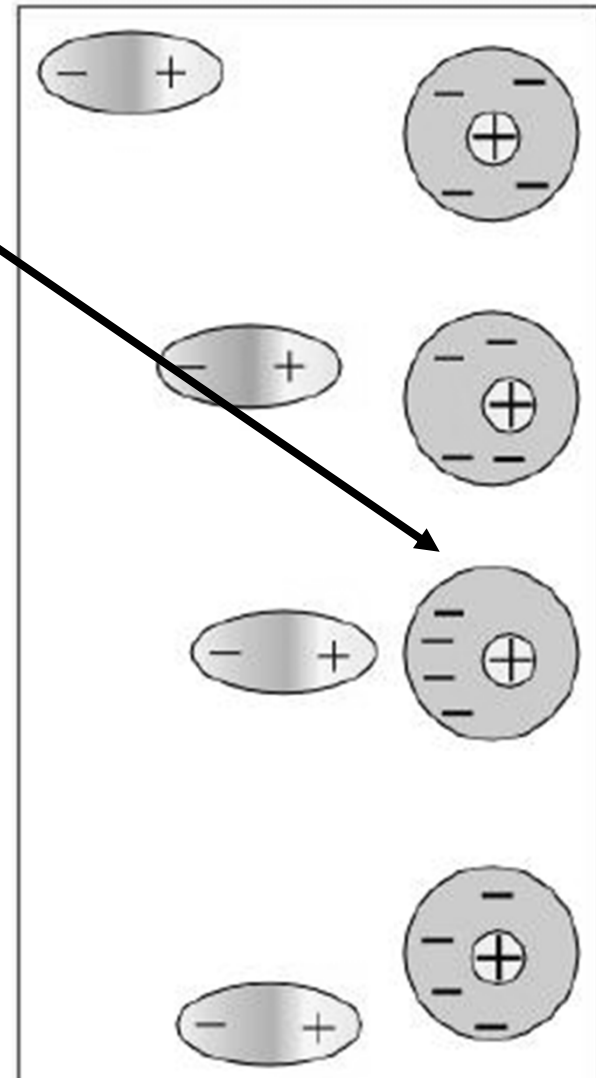

Polarizovatelnost, α , m³

Skupina	Polarizovatelnost, cm ³ 10 ²⁴	v.d.W poloměr, Å	Atomový poloměr, Å
O	0.63	1.5	0.66
CH ₂	1.80	2.0	-
S	3.00	1.8	1.04

Molekula	Polarizovatelnost (\AA^3)	T_{varu} (K)	Dipolový moment (D)
He	0.20	4.216	0
Ne	0.39	27.3	0
Ar	1.62	87.3	0
Kr	2.46	119.9	0
H ₂ O	1.48	373.15	1.85
H ₂ S	3.64	212.82	1.10
CCl ₄	10.5	349.85	0
C ₆ H ₆	25.1	353.25	0
CH ₃ OH	3.0	338	1.71
CH ₃ F	3.84	195	1.81
CHCl ₃	8.50	334.85	1.01

Interakce

indukovaný dipol – indukovaný dipol

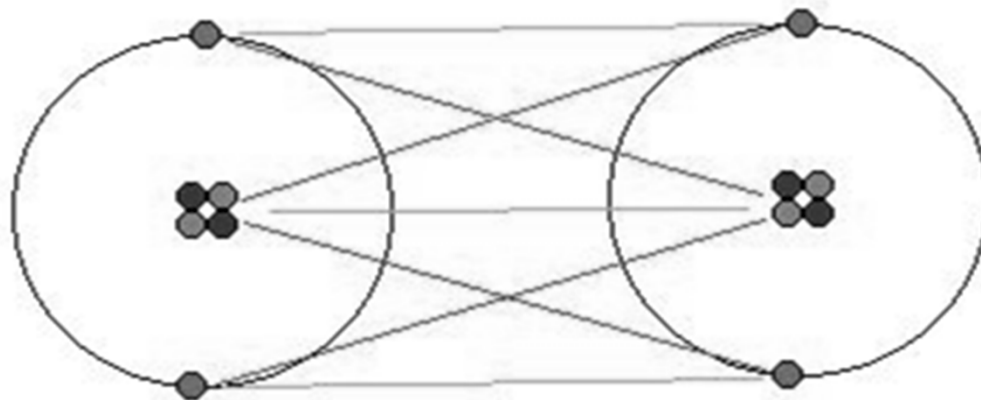

Odpudivé síly

Přitažlivé síly

Londonovy disperzní síly

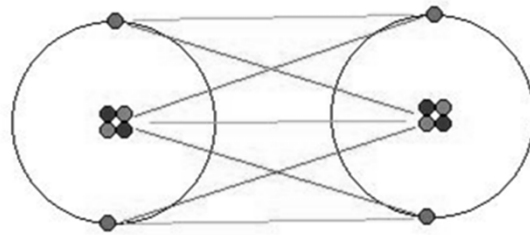

— Repulsive forces
 - - - Attractive forces

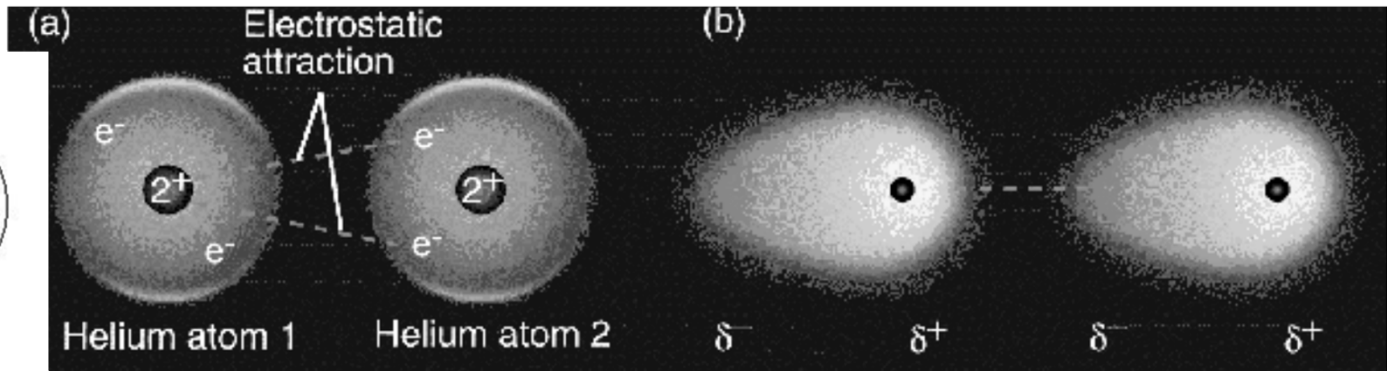

$$E = -konst \times \frac{IE \times \alpha^2}{r^6}$$

IE = ionizační energie
 α = polarizovatelnost
 r = vzdálenost

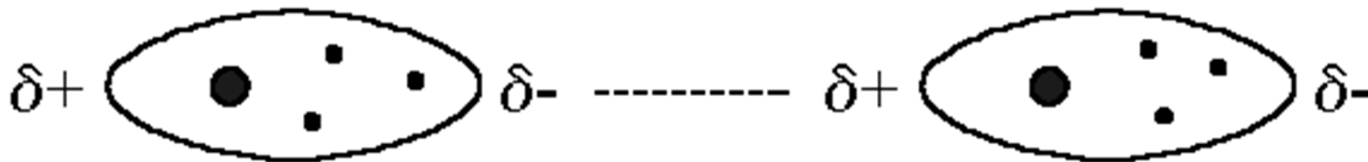

Vliv polarizovatelnosti molekuly na velikost Londonových sil

Vliv Londonových sil na
skupenství halogenů a
vzácných plynů

S velikostí molekul roste
polarizovatelnost

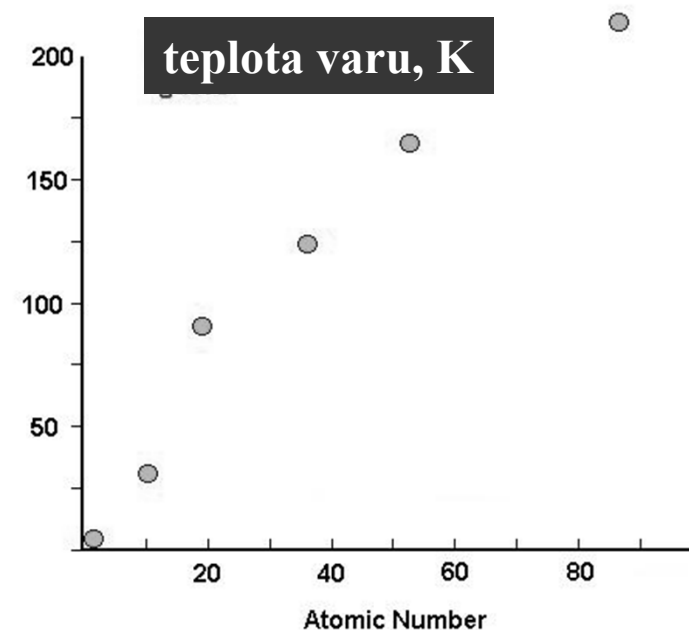

	teplota varu, K
F₂	85.1
Cl₂	238.6
Br₂	332.0
I₂	457.6

	teplota varu, K
He	4.6
Ne	27.3
Ar	87.5
Kr	120.9

Vliv velikosti molekuly na velikost Londonových sil

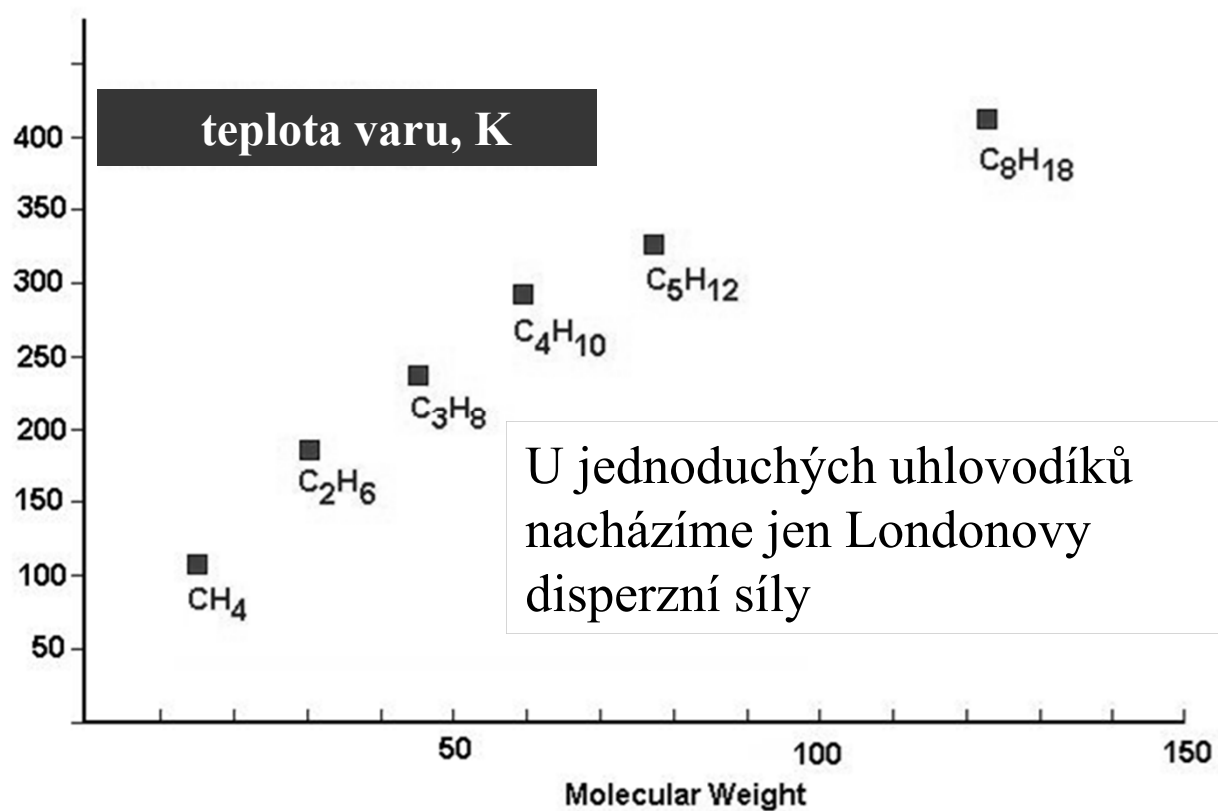

Vodíková vazba

H s elektronegativními atomy (F, O, N, C,...)

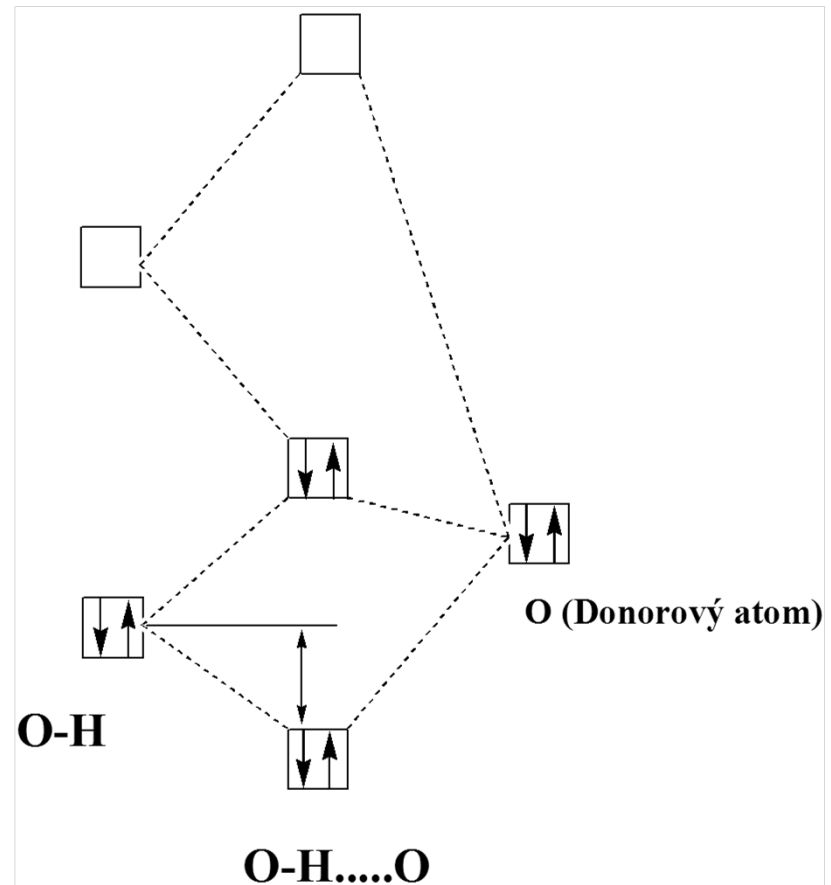
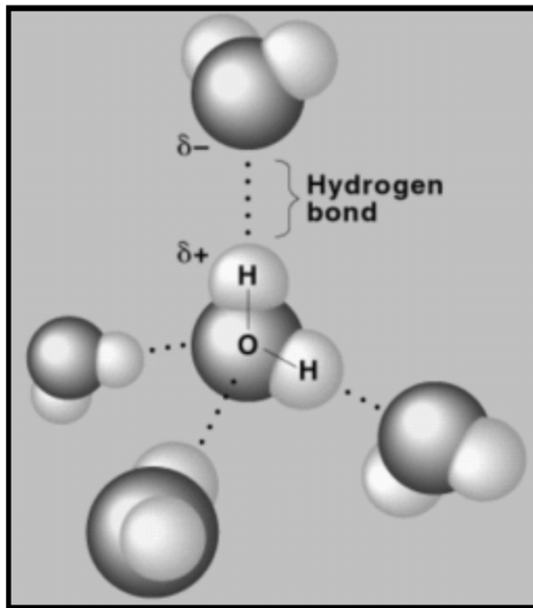

Vodíková vazba

Intramolekulární vodíková vazba

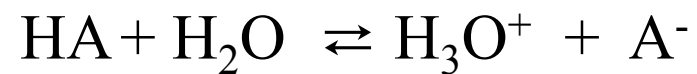
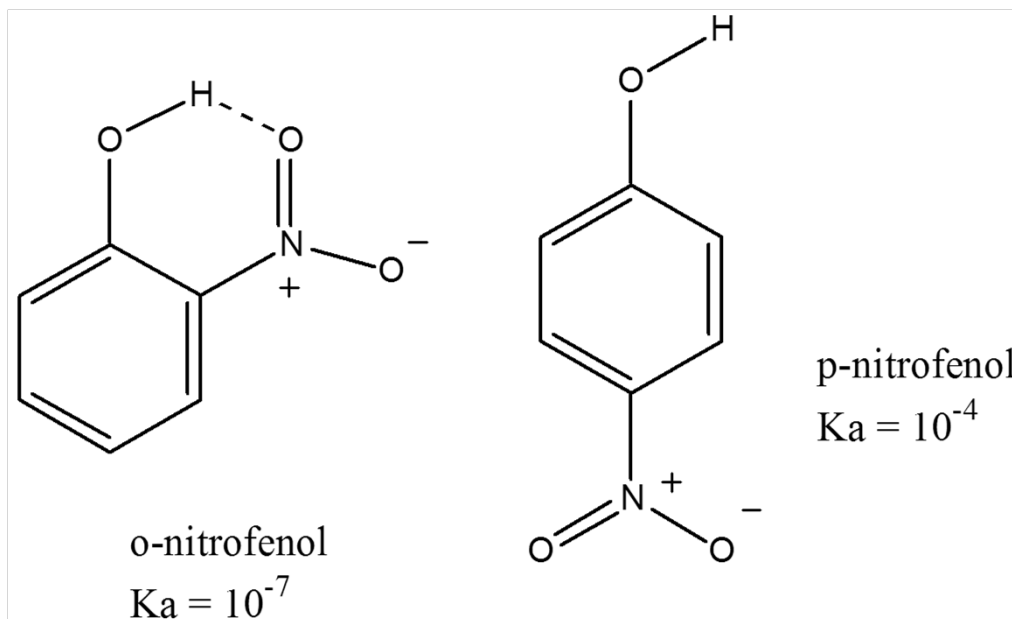

$$K_a = \frac{[\text{H}_3\text{O}^+][\text{A}^-]}{[\text{HA}]}$$

Snížená kyselost OH skupiny (konstanta kyselosti K_a)
v důsledku tvorby vodíkové vazby

Vodíková vazba

Intermolekulární

Led

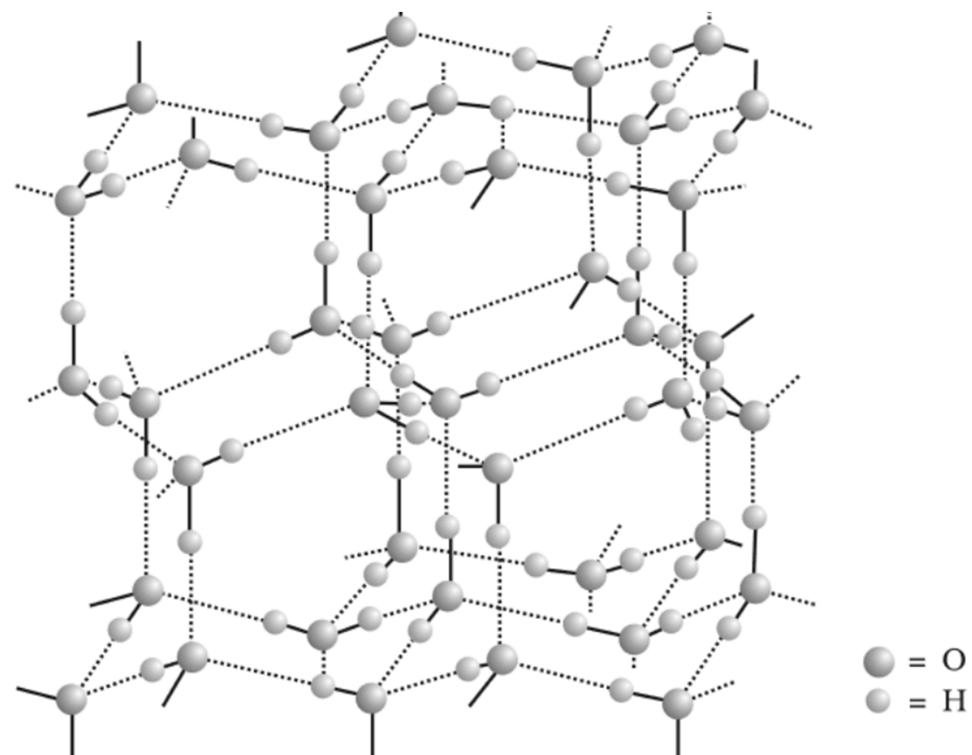
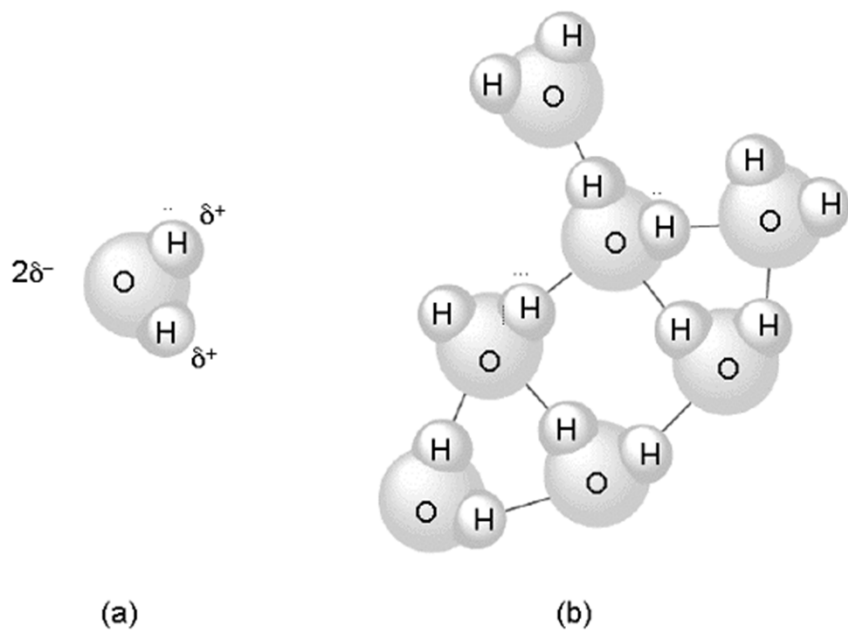

Vodíková vazba

Vazba	Vzdálenost (Å)	Rozmezí (Å)
N-H...N	3.10	2.88-3.38
N-H...O		
- Amid NH	2.93	2.55-3.04
- Amino NH	3.04	2.57-3.22
N-H...F	2.78	2.62-3.01
N-H...Cl	3.21	2.91-3.52
O-H...N	2.80	2.62-2.93
O-H...O		
- Alkohol OH	2.74	2.55-2.96
- Voda OH	2.80	2.65-2.93
O-H...Cl	3.07	2.86-3.21

Vodíková vazba

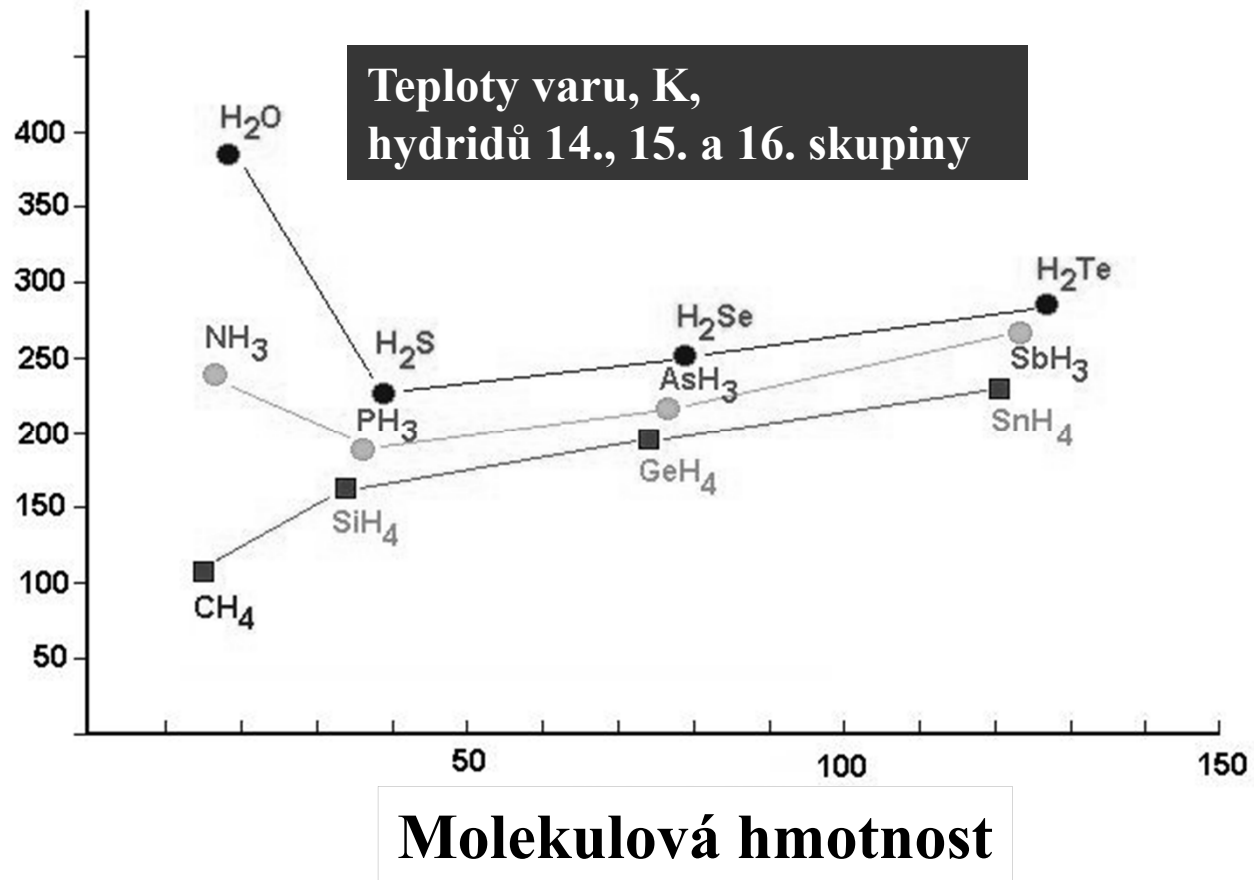

HF₂⁻ hydrogendifluorid

Nejsilnější známá H-vazba

155 kJ mol⁻¹

Symetrické rozložení
vazebných délek H-F 114 pm

Vazebný úhel
F-H-F = 180°

Autodisociace HF
 $2 \text{ HF} \leftrightarrow \text{H}_2\text{F}^+ + \text{HF}_2^-$

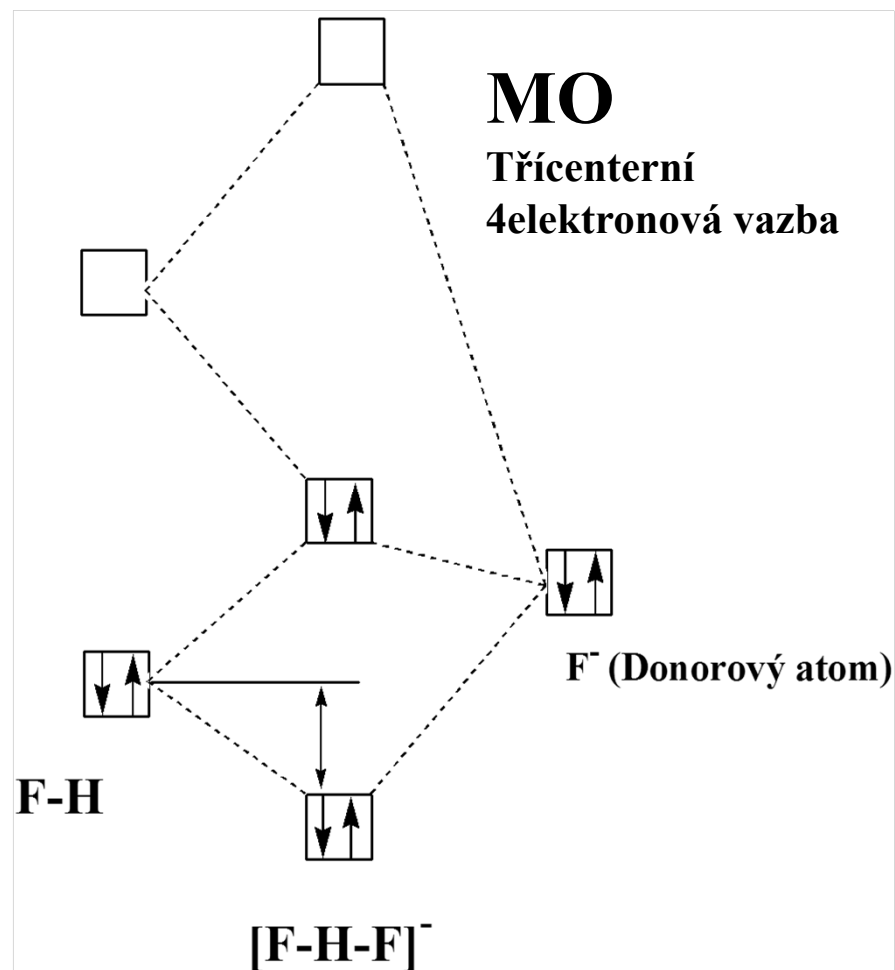

Vodíková vazba

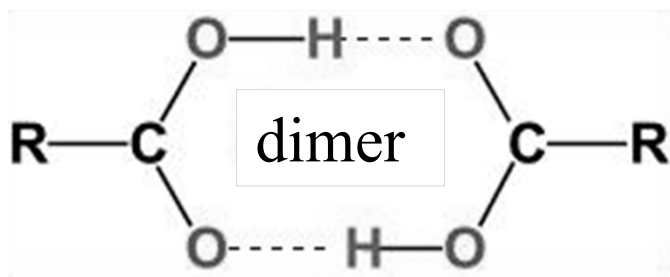

Krystalové inženýrství
Samouspořádání

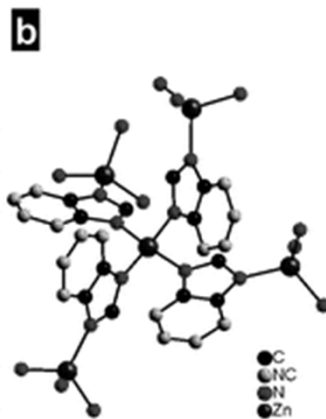
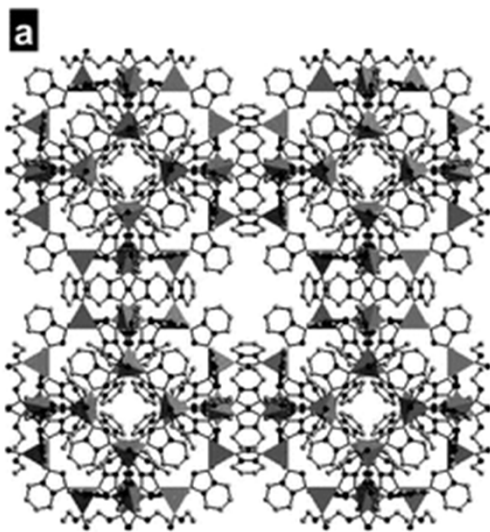
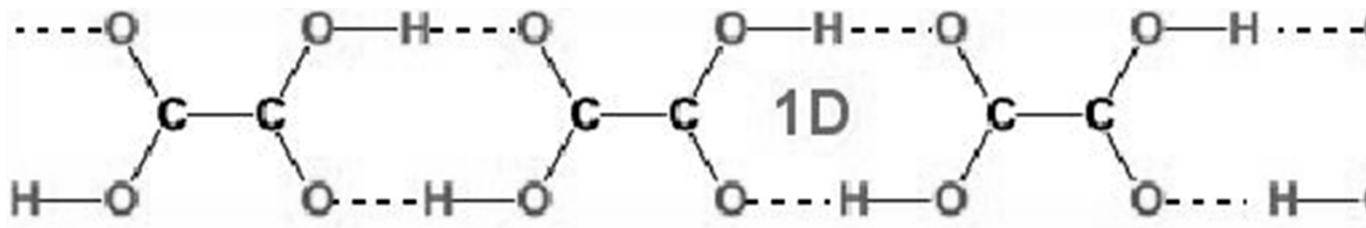

Supramolekulární
systémy

Struktura HF

1D. HF

Ortorrómbico: B mmb

a (Å) 3.42

b (Å) 4.32

c (Å) 5.41

V (Å³) 79.9

Z 4

Dx (gcm⁻³) 1.66

F-H (Å) -

F...F (Å) 2.49

H...F (Å) -

F-H...F (°) 180°

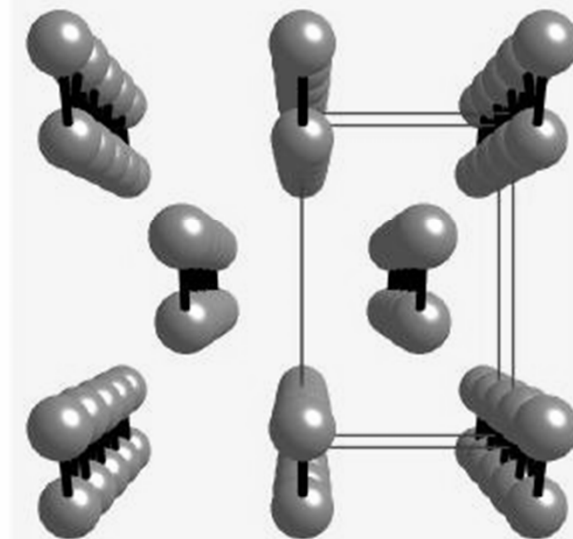
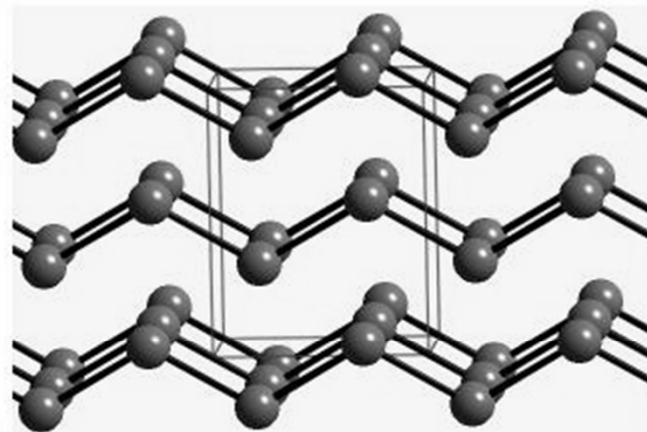
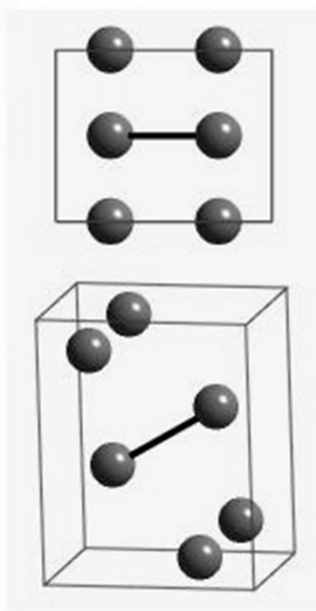

Kyselina boritá

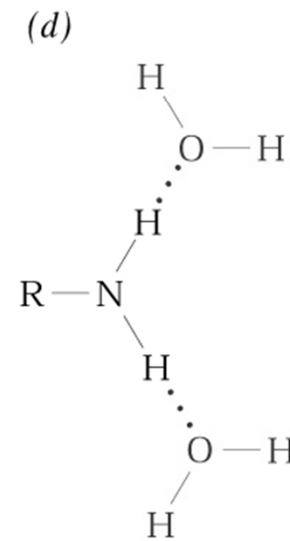
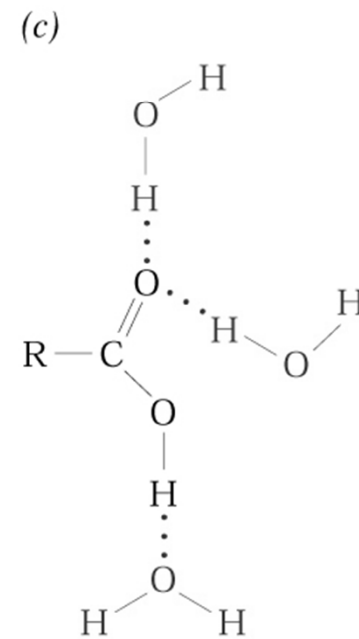
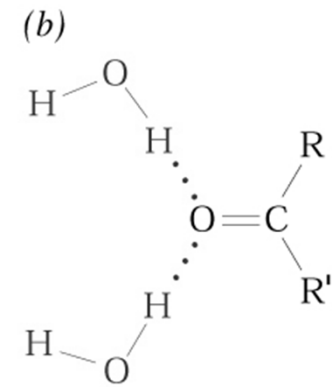
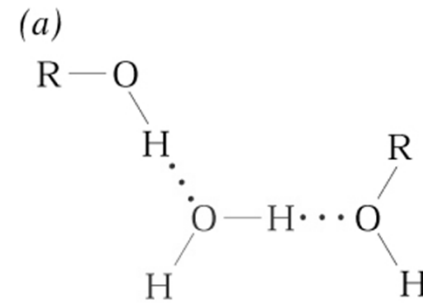
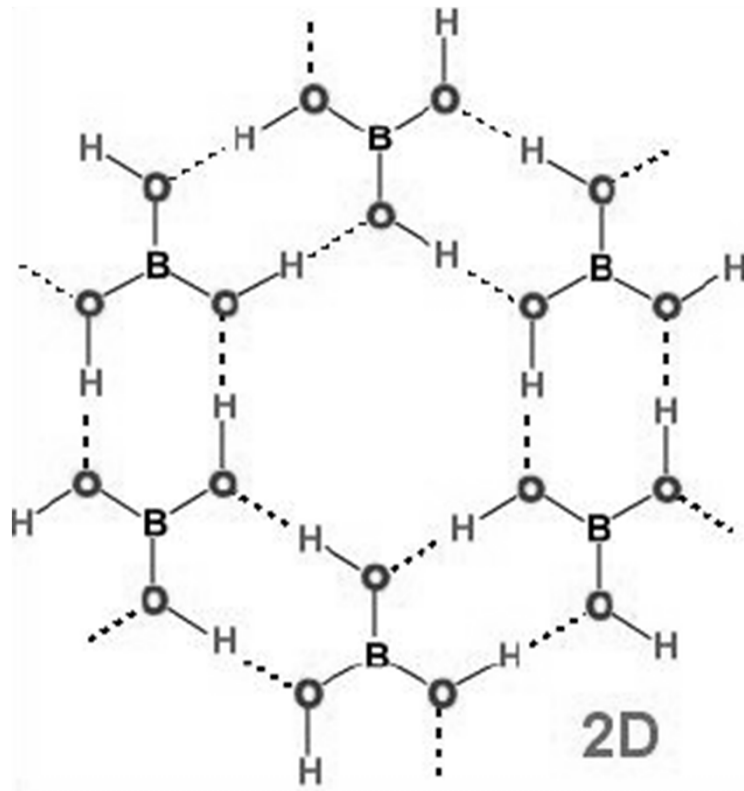

Struktura proteinů

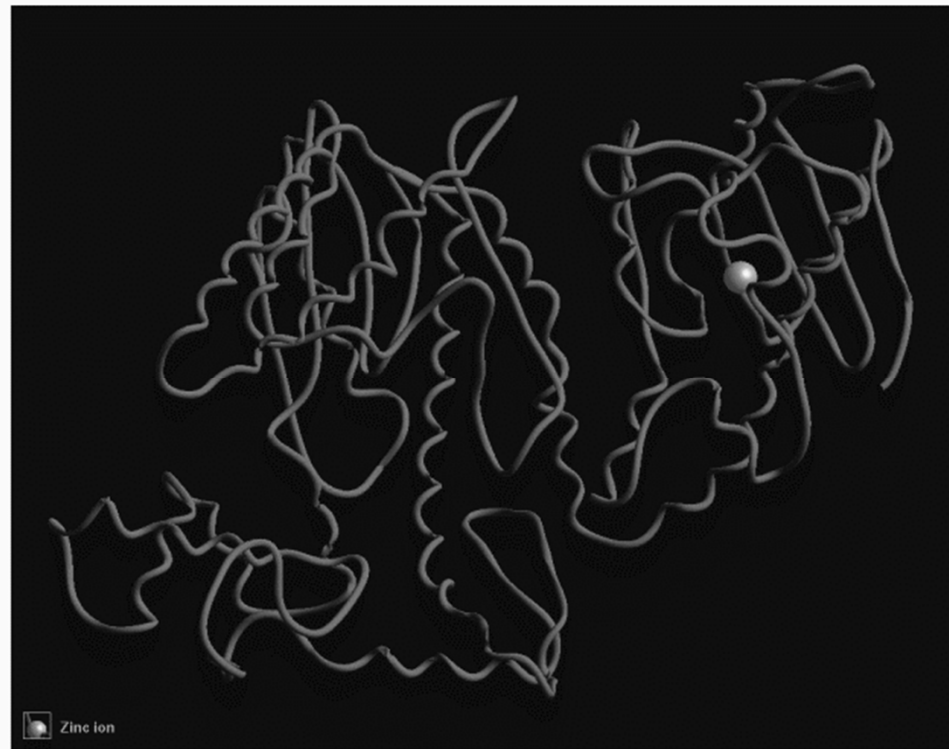
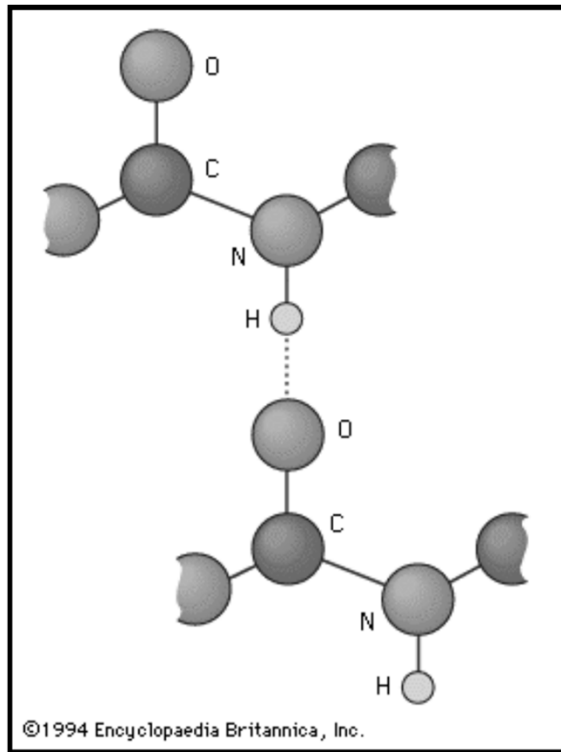

Struktura DNA

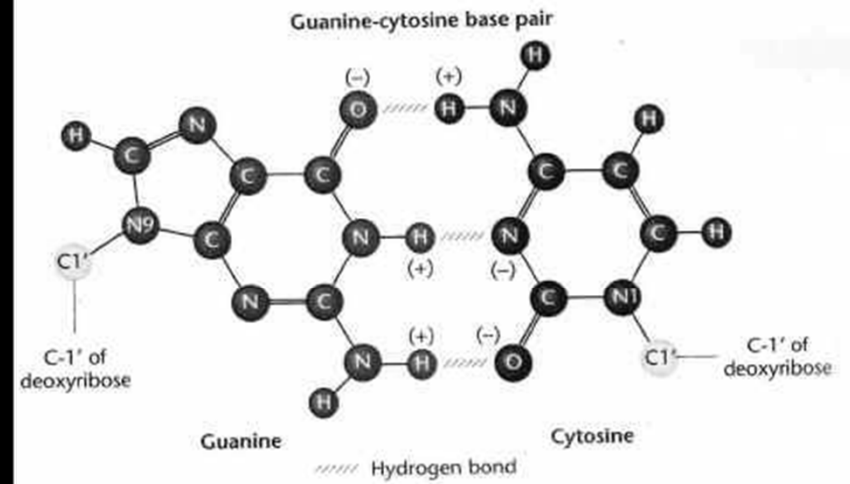
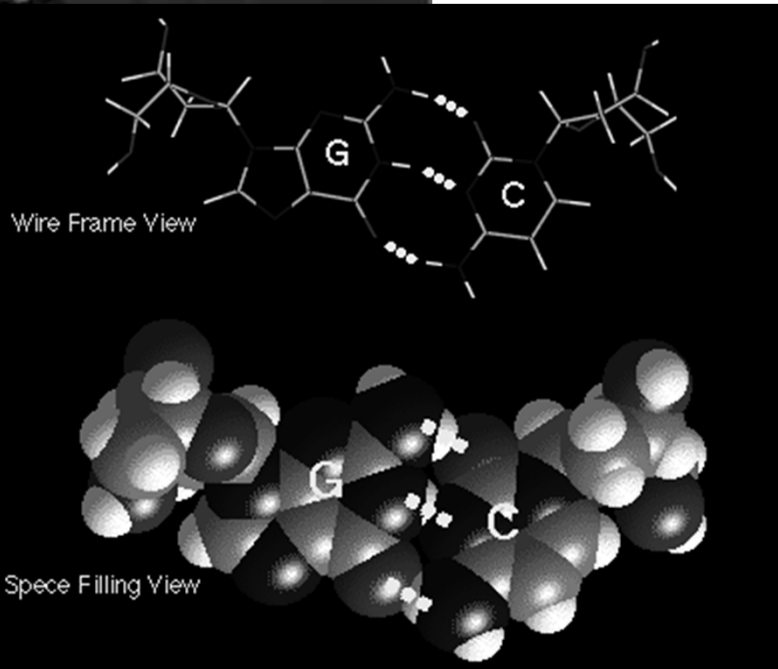
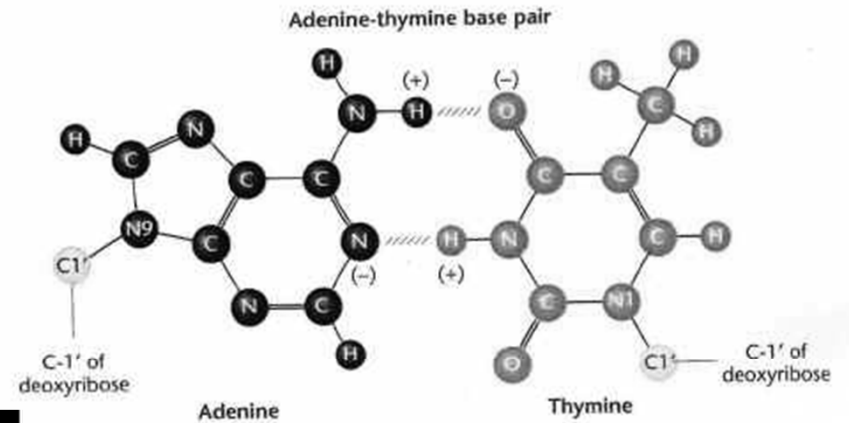

Struktura ledu

3D. H₂O

Hexagonal: P6₃/mmc

a (Å) 4.5227

c (Å) 7.3671

V (Å³) 121.9

Z 3

Dx (gcm⁻³) 0.74

O-H (Å)	0.82, 0.86
O...O (Å)	2.765, 2.773
H...O (Å)	1.91, 1.95
O-H...O (°)	180°

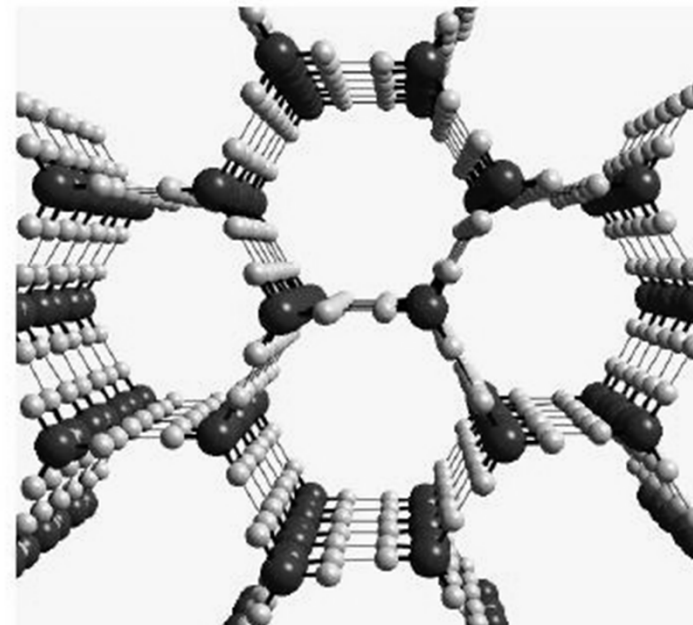
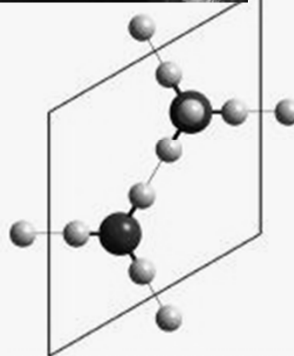
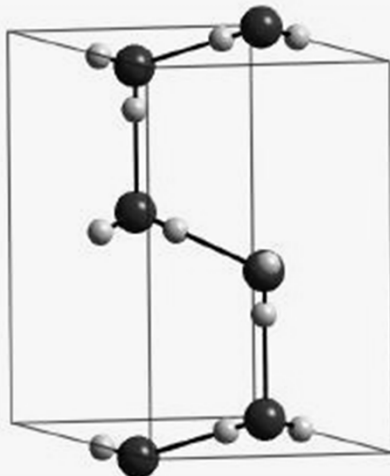
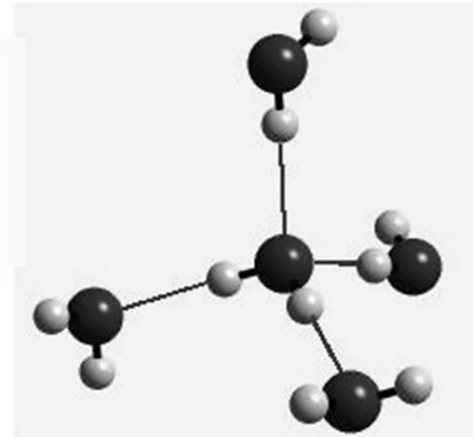

Rovnováha přitažlivých a odpudivých sil

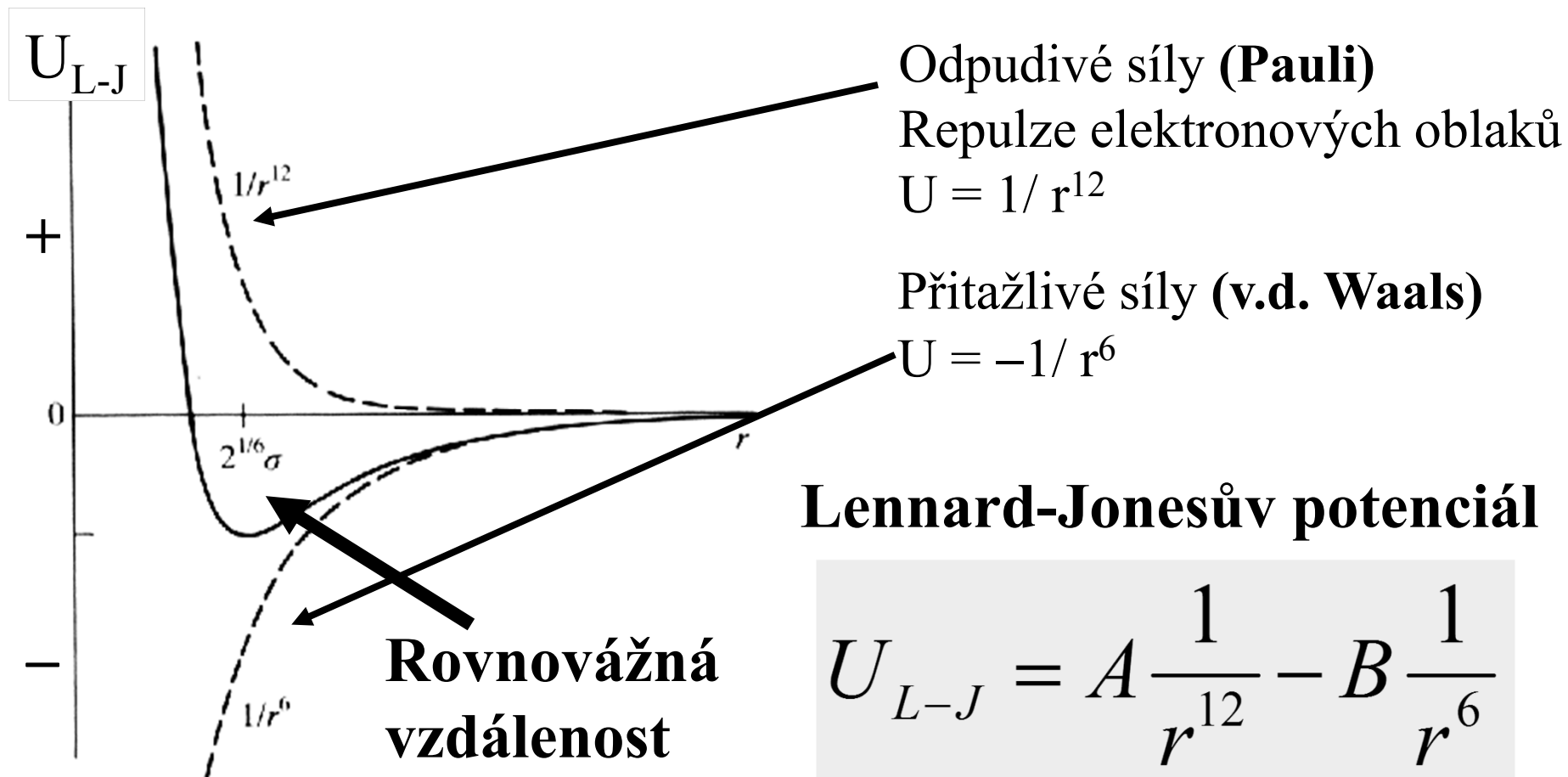

A, B = konstanty závislé na elektrických vlastnostech molekul

Lennard-Jonesův potenciál

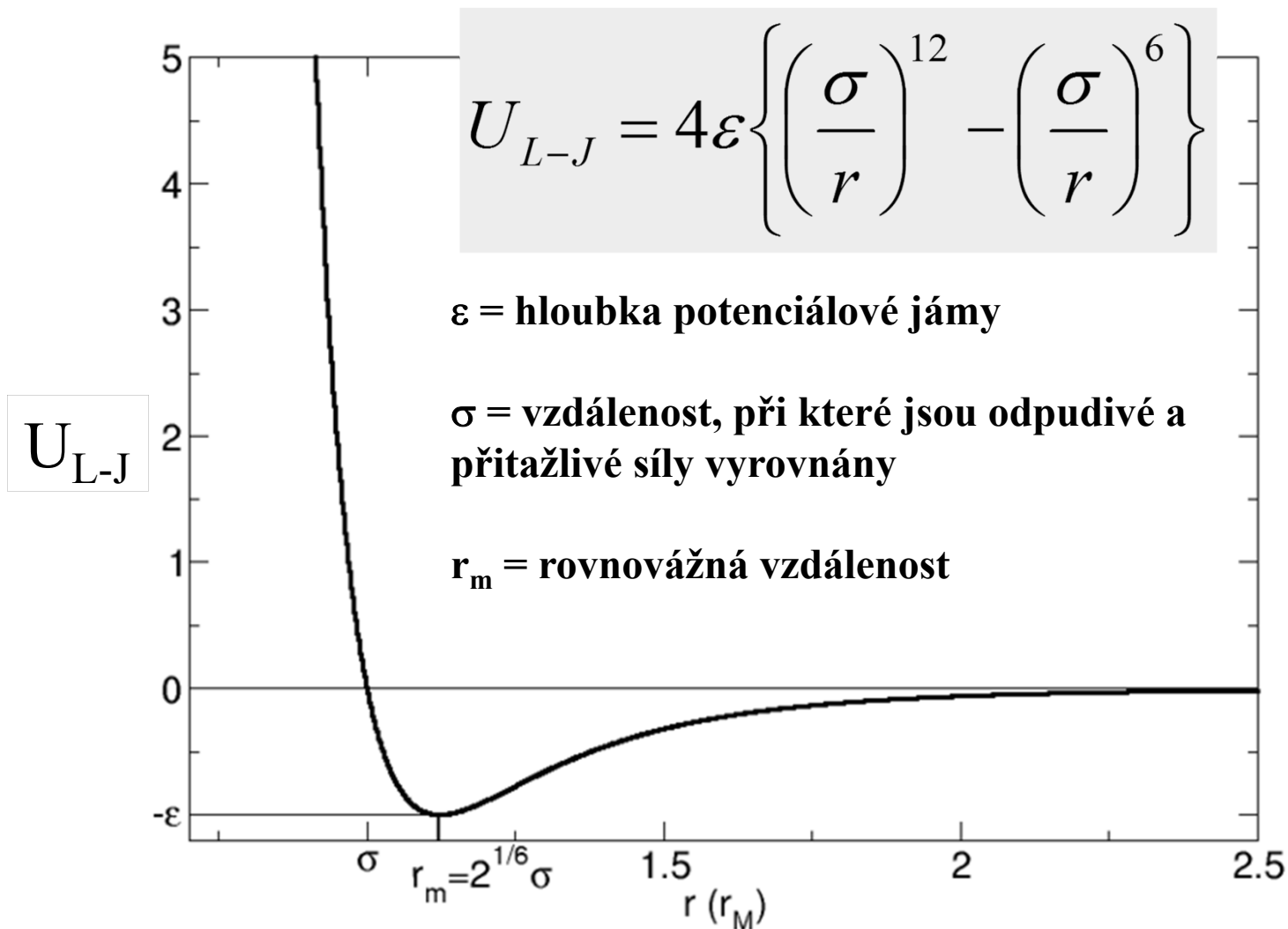

Van der Waalsovy poloměry, Å

Atomový poloměr O 0.73 Å

Iontový poloměr O²⁻ 1.40 Å

H 1.20	Ar 1.88	As 1.85	F 1.47
C 1.70	Zn 1.39	Ga 1.87	Cl 1.75
Cu 1.40	Cd 1.58	In 1.93	Br 1.85
He 1.40	Hg 1.55	Tl 1.96	I 1.98
K 2.75	Kr 2.02	Li 1.82	Mg 1.73
N 1.55	Na 2.27	Ne 1.54	Ni 1.63
O 1.52	P 1.80	Pb 2.02	Pd 1.63
Pt 1.72	S 1.80	Se 1.90	Si 2.10
Sn 2.17	Te 2.06	Xe 2.16	
Ag 1.72	Au 1.66		

Mikroskopie atomárních sil AFM

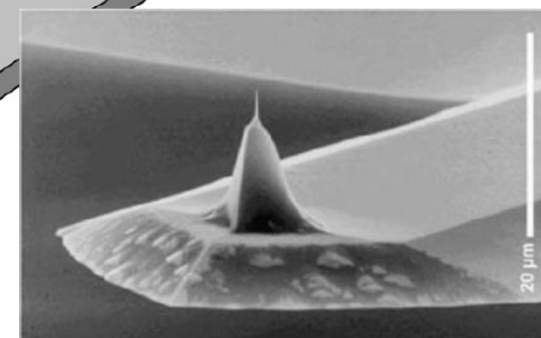
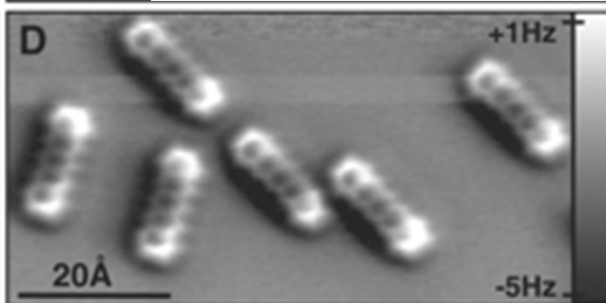
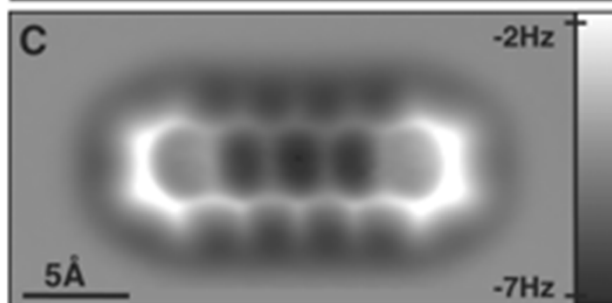
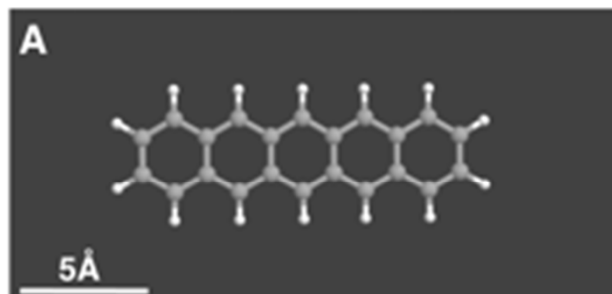
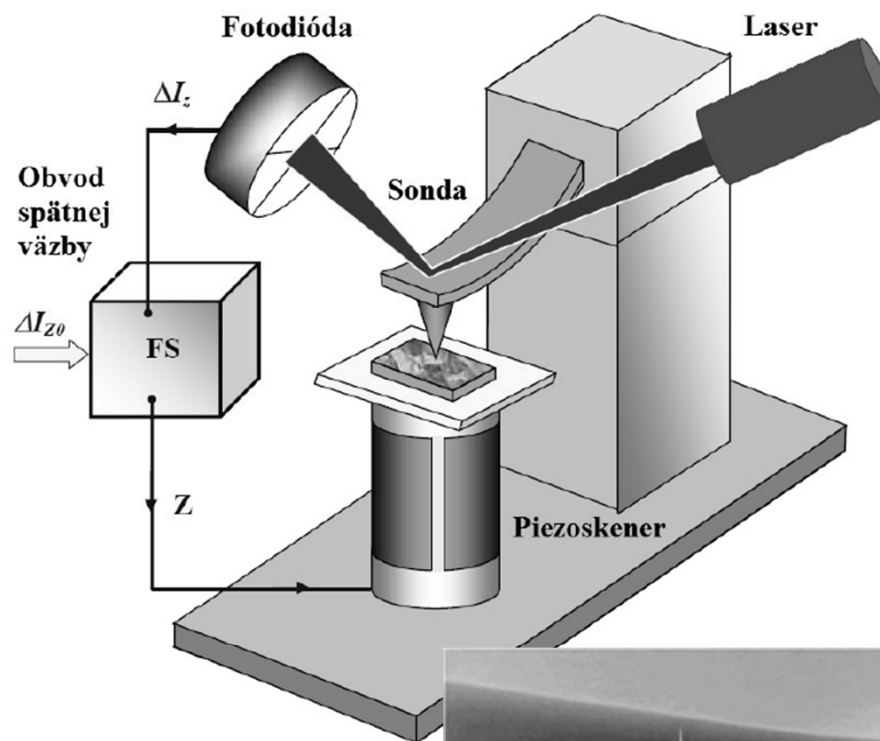
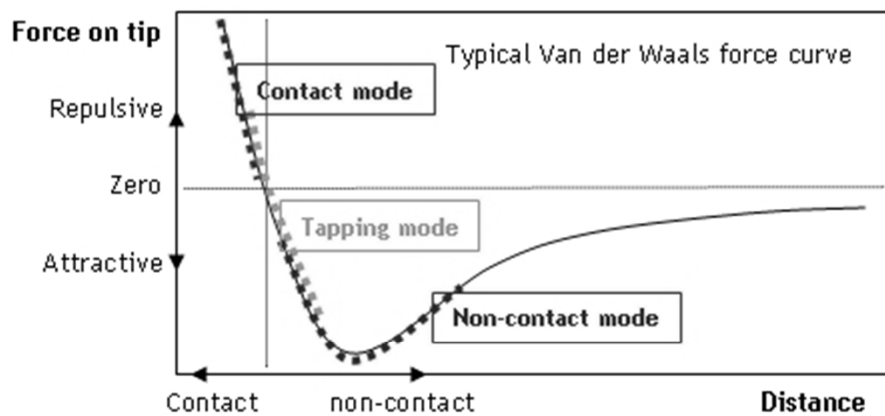

DOI: 10.1126/science.1176210

Supramolekulární chemie

Cucurbiturily

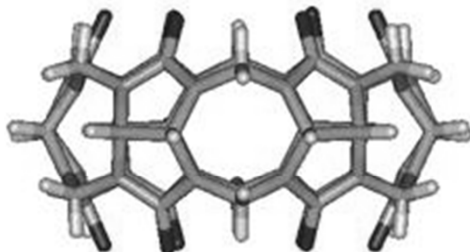
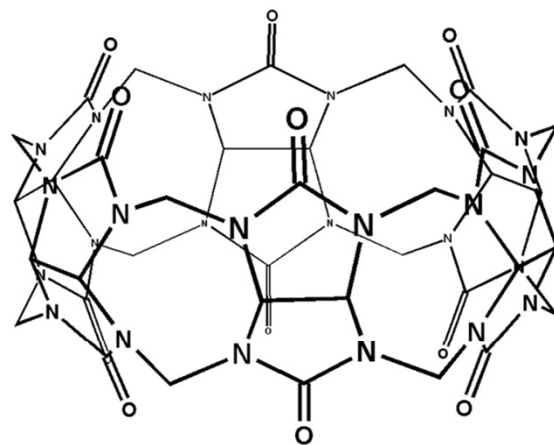
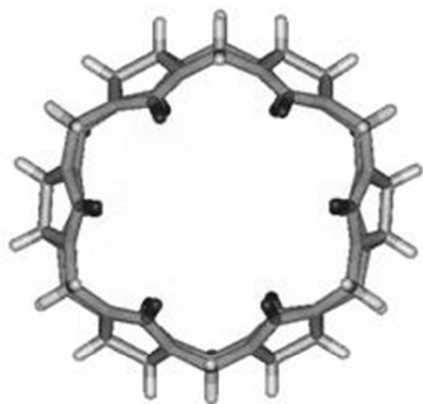

Supramolekulární chemie

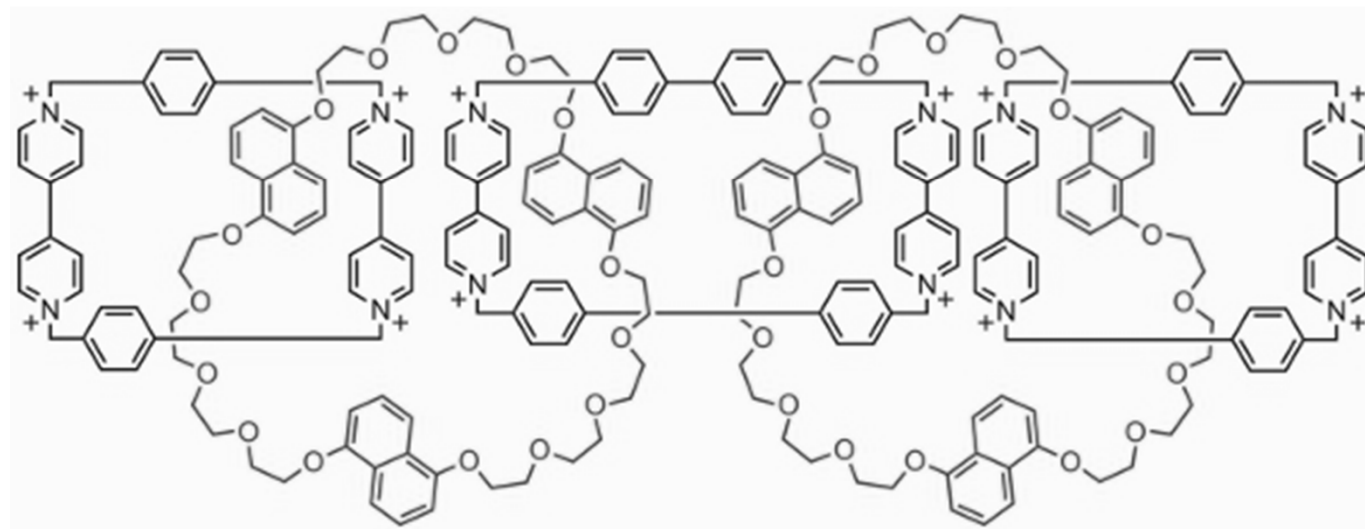
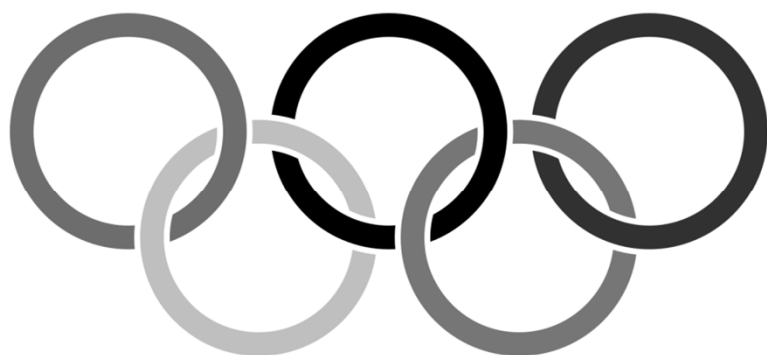

Pevné látky

Amorfní

- nepravidelné vnitřní uspořádání
- *izotropie* fyzikálních vlastností
- termodynamicky nestabilní

Krystalické

- pravidelné vnitřní uspořádání
- *anizotropie* fyzikálních vlastností = různé v různých směrech (pro symetrii nižší než kubickou)

Pevné látky

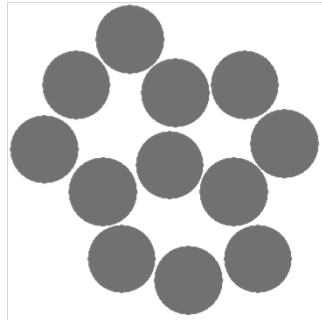

Amorfní

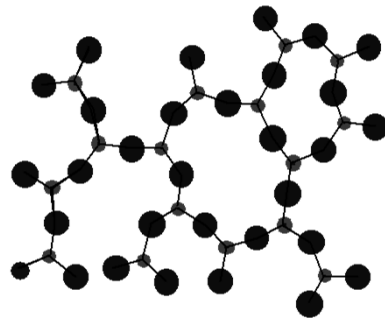

Metastabilní

Vazebná energie

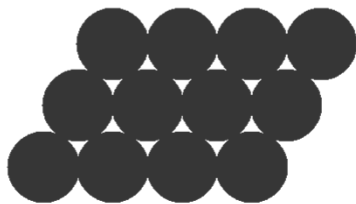
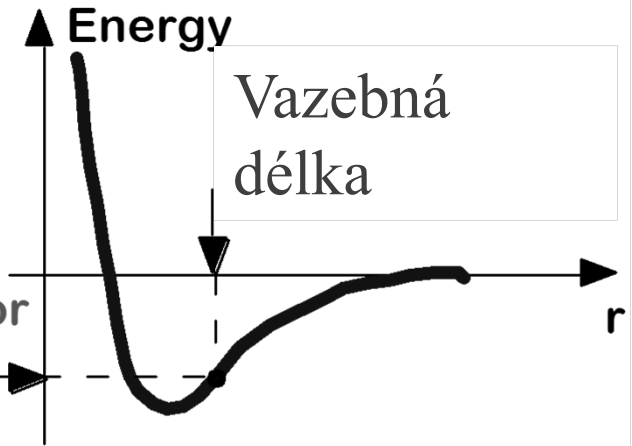

Krystalické

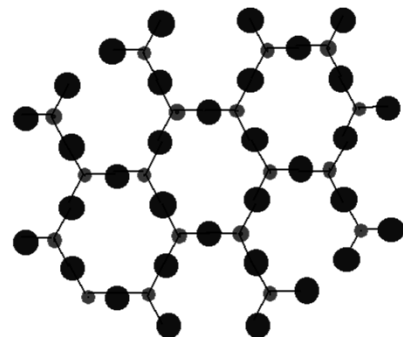

Stabilní

Vazebná energie

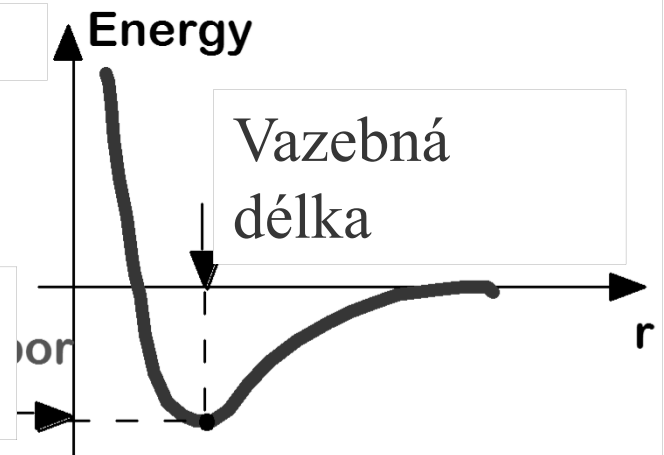

Krystalické látky

- kovové (Cu, Fe, Au, Ba, slitiny CuAu)
atomy kovu, kovová vazba
- iontové (NaCl, CsCl, CaF₂, ...)
kationty a anionty, elektrostatická interakce
- kovalentní (C-diamant, grafit, SiO₂, AlN,...)
atomy, kovalentní vazba
- molekulární (Ar, C₆₀, HF, H₂O, CO₂, organické sloučeniny, proteiny)
molekuly, van der Waalsovy a vodíkové interakce

Modely struktur

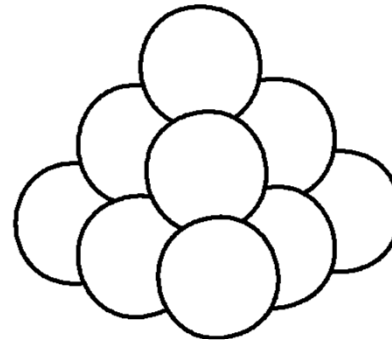
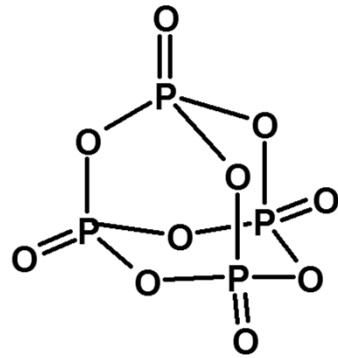
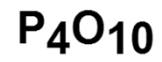

Atomy
vyplňující
prostor

Koordinální
polyedry

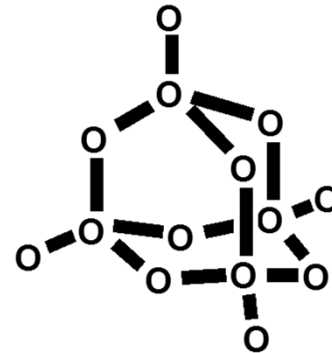
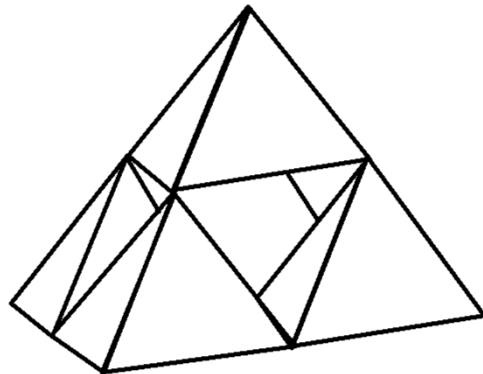

Atomy a vazby

Krystalické látky

pravidelné vnitřní uspořádání

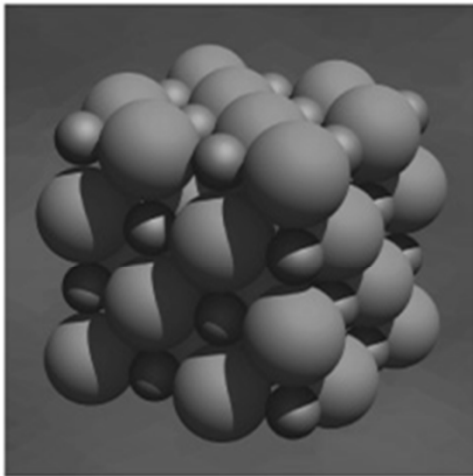

(a)

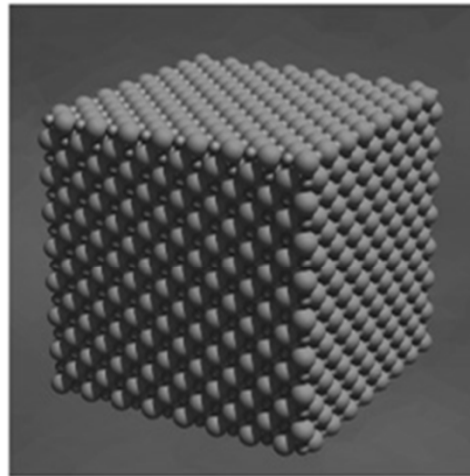

(b)



(c)

Přechod do pevného skupenství

Boltzmanovo rozdělení

– při ochlazování klesá kinetická energie

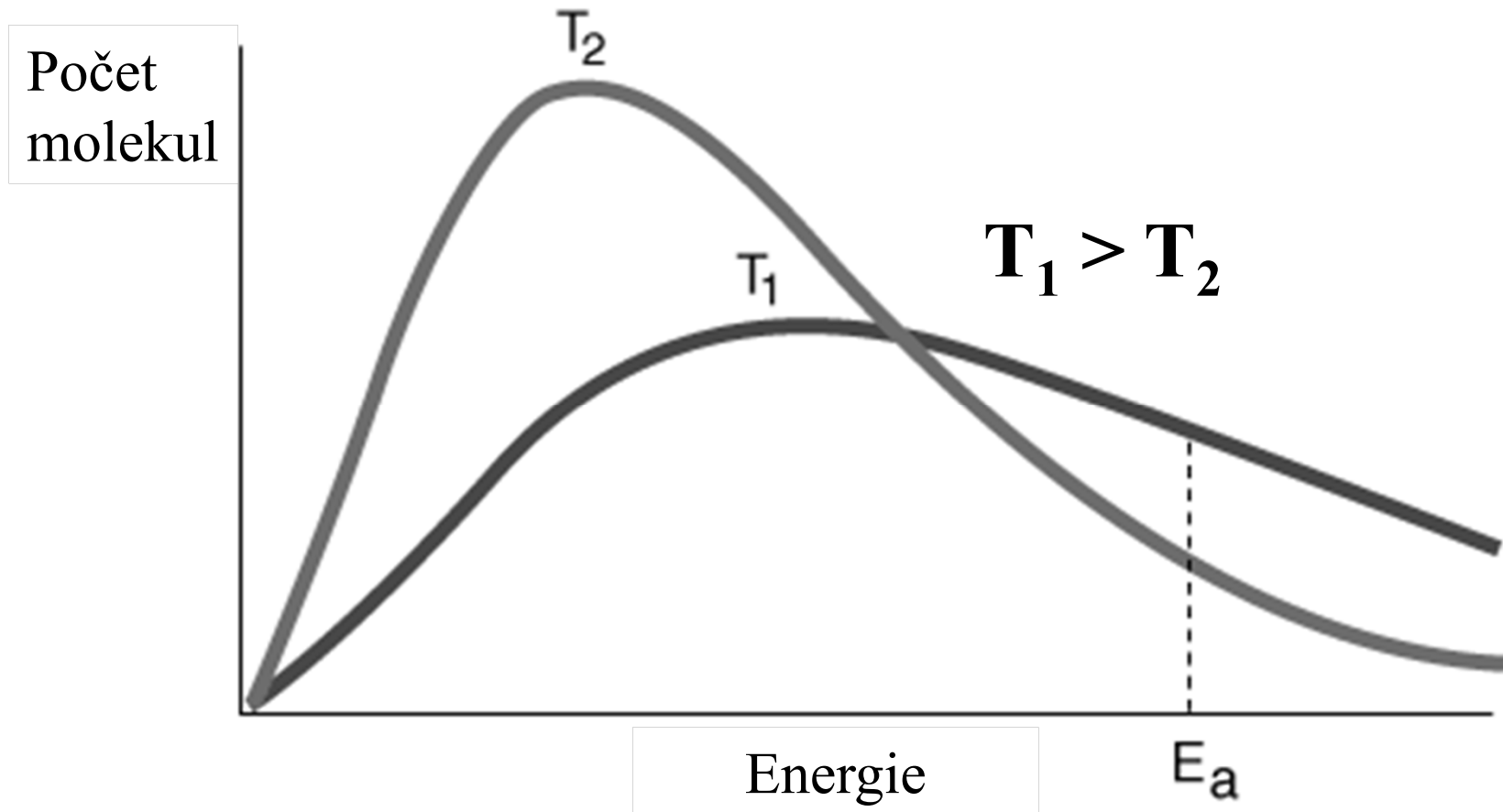

Vznik nukleačních center

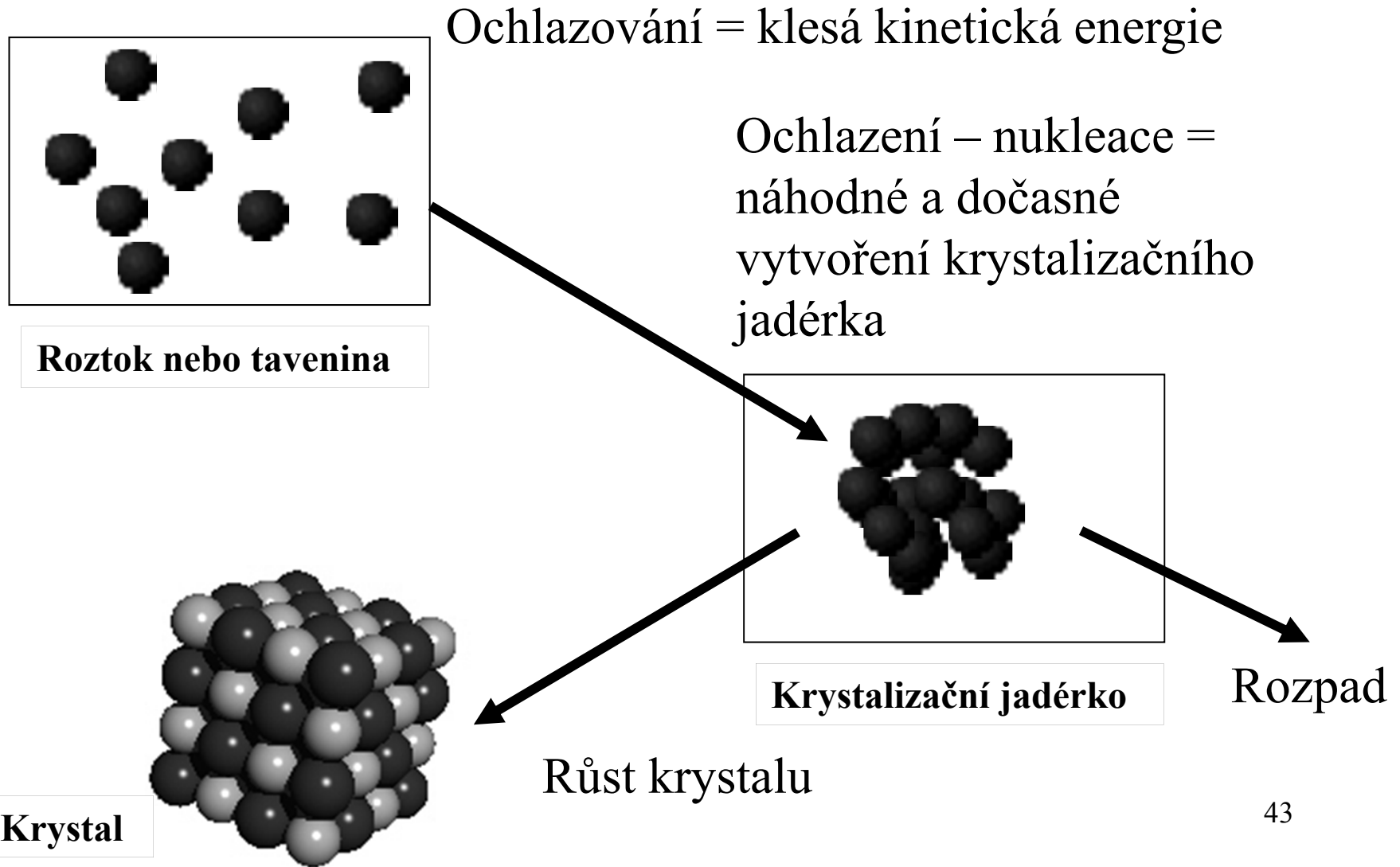

Nukleace

$\Delta G_{\text{Nukleace}}$

$$\Delta G = \frac{4}{3} \pi r^3 \Delta G_v + 4\pi r^2 \sigma$$

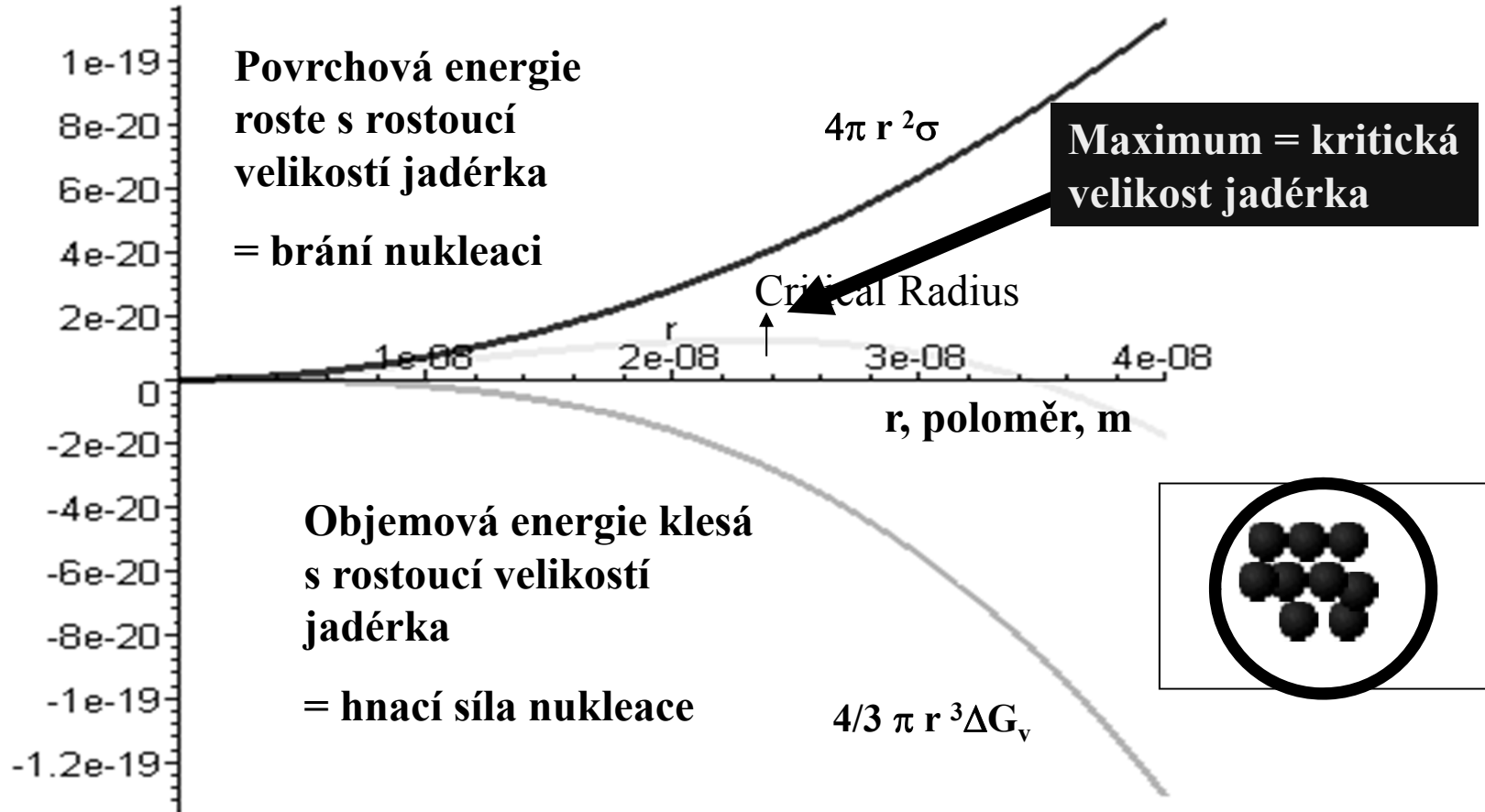

Příprava monokrystalů

Vysokoteplotní metody
Czochralski

Střední teploty
Hydrotermální metoda
Sublimace

Nízkoteplotní metody
Krystalizace z roztoku



**Jan Czochralski
(1885–1953)**

Příprava monokystalů

monokystal Si
průměr = 300 mm
délka = 2 m
m = 265 kg

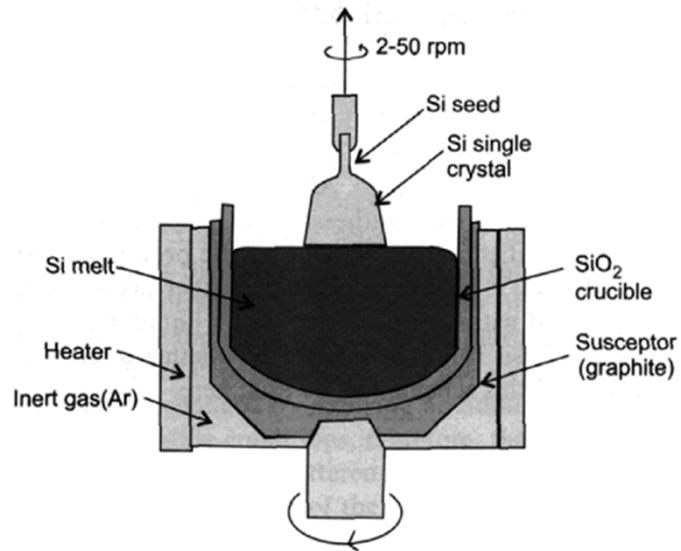

Hydrotermální metoda

Teplotní gradient
Zárodečný krystal

Jeskyně Naica, Mexiko
 $\text{CaSO}_4 \cdot 2\text{H}_2\text{O}$

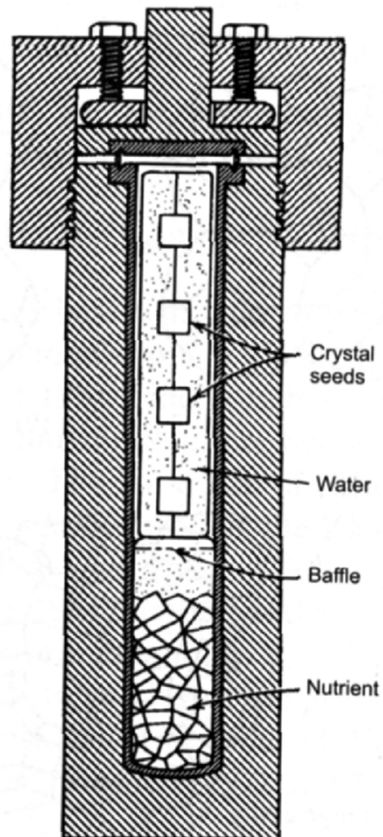

Vysokotlaký autokláv

Van Arkelova metoda

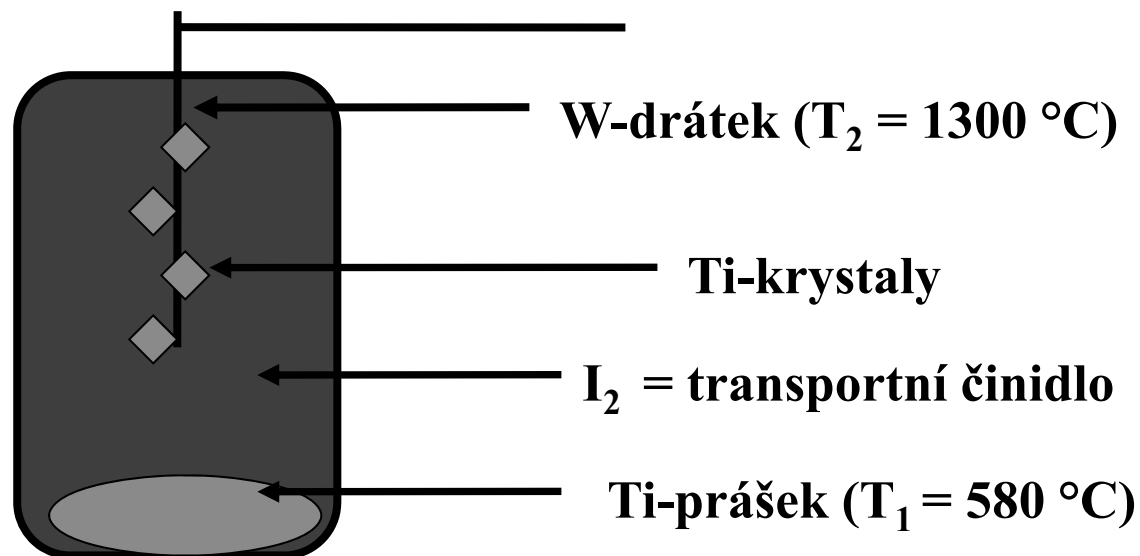

Ti
Bod tání 1668 °C

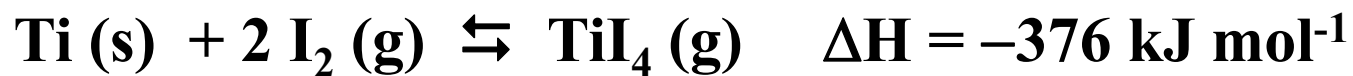

Rovnovážná reakce, exothermní:

transport z chladnějšího na horký konec

Krystalizace z roztoku

**KDP krystaly
(KH_2PO_4)**

Přesycený roztok

Očkování

Pomalé chlazení



Struktura kovů

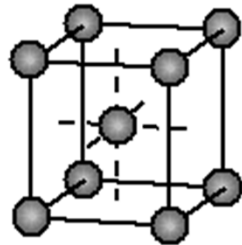
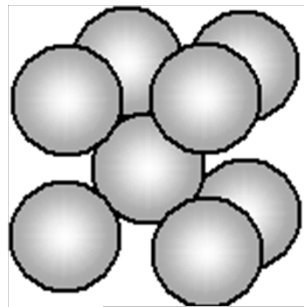

BCC

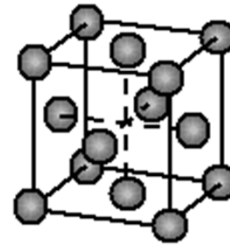
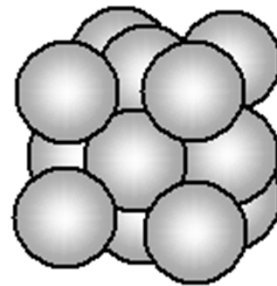

CCP = FCC

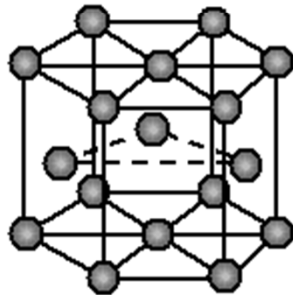
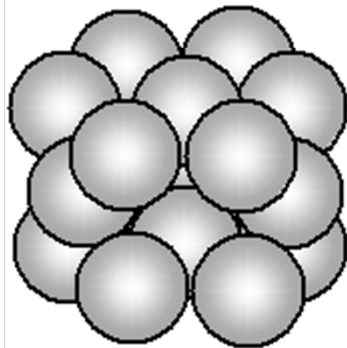

HCP

Tělesně centrovaná kubická mřížka

Nejtěsnější kubické uspořádání = Plošně centrovaná kubická mřížka

Nejtěsnější hexagonální uspořádání

Kovová vazba

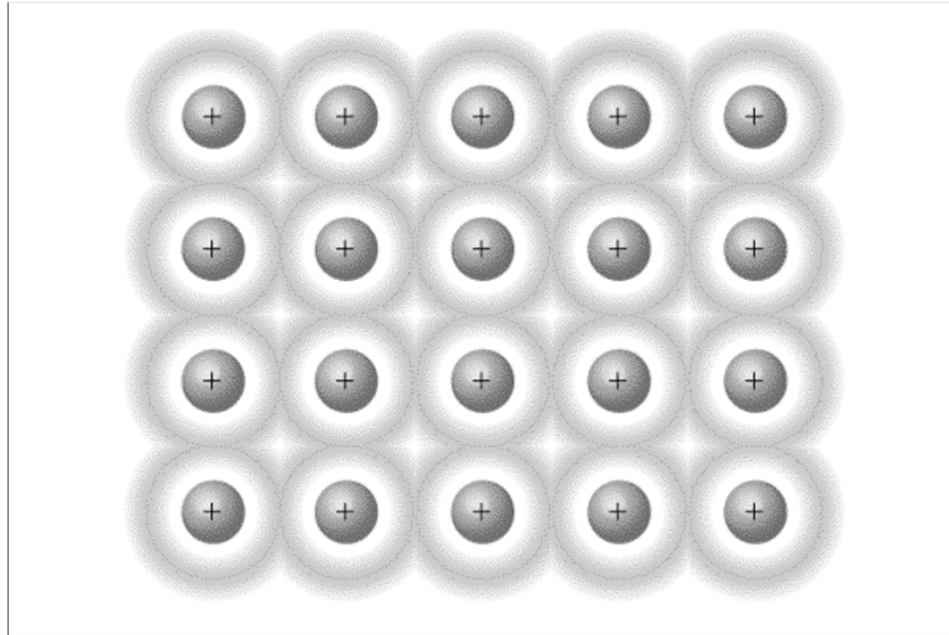

Al = 13 e

Al v krystalu = 10.2 e

Řez elektronovou hustotou podél spojnice Al - Al v krystalu hliníku

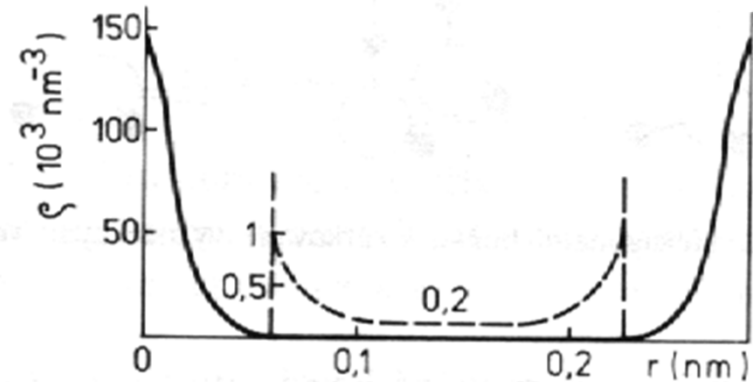

Elektronový plyn

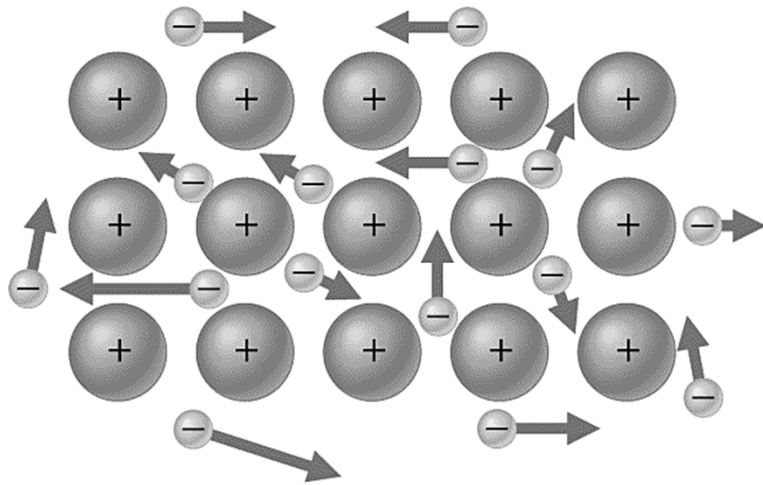

Tepelná vodivost:
Přenos energie elektrony

Elektrická vodivost:

Elektrony se pohybují volně v poli kladných nábojů jader

Elektrický odpor kovu roste s teplotou – větší kmity atomů

Elektrický odpor kovu roste s koncentrací nečistot – překážky pohybu elektronů

$$R = \frac{1}{\Sigma}$$

Elektrická vodivost Σ a odpor R

σ , S cm

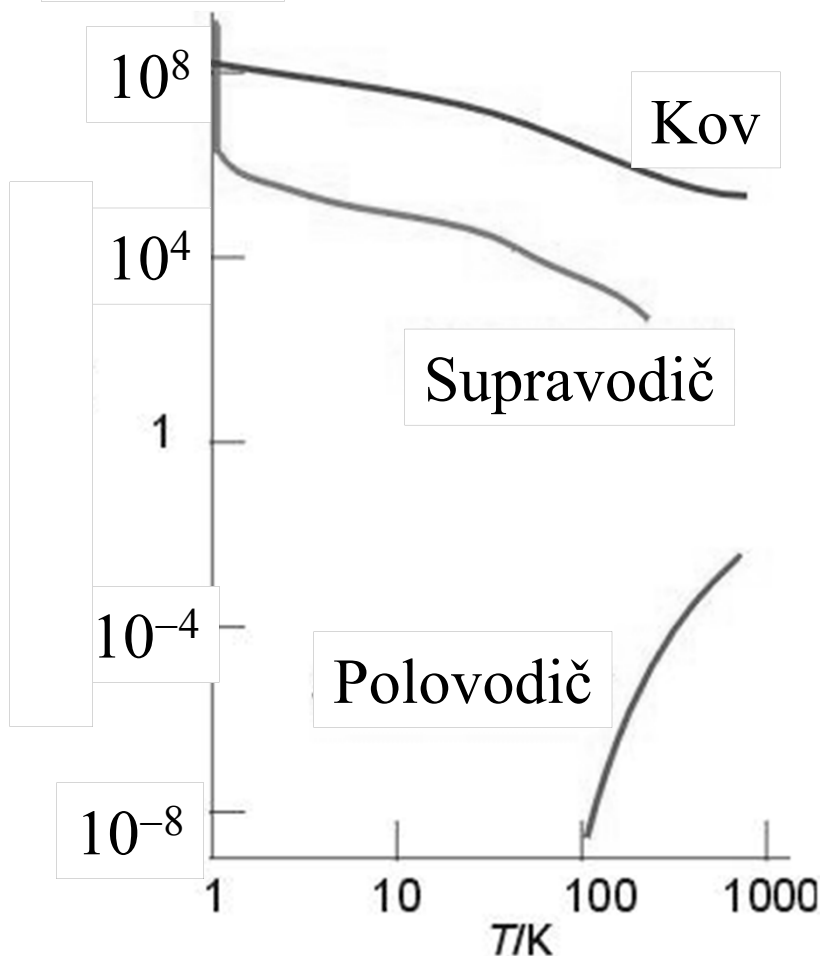

Specifická elektrická vodivost, σ

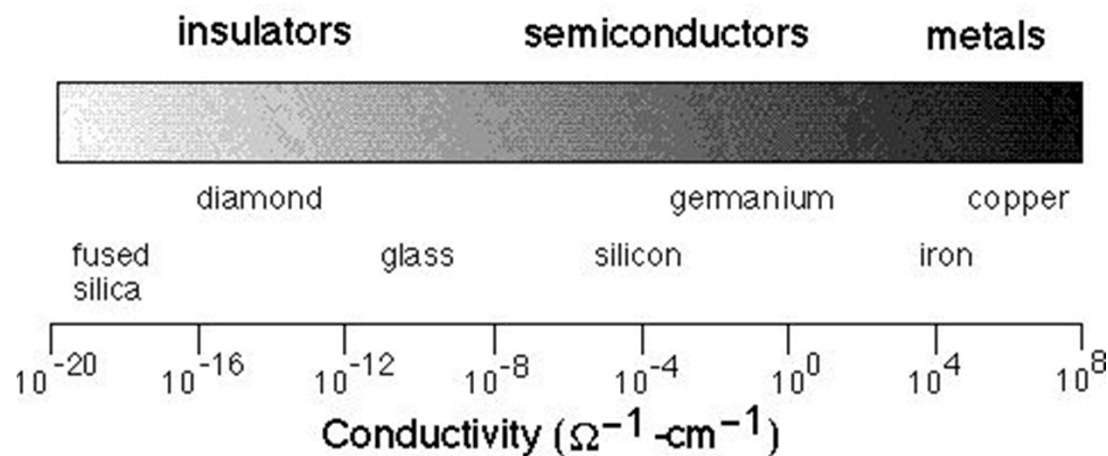

$$R = \rho \frac{l}{A}$$

$$\rho = \frac{1}{\sigma}$$

R = elektrický odpor, Ω

ρ = specifický elektrický odpor, $\Omega \text{ m}$

l = délka vodiče, m

A = průřez vodiče, m^2

Pásová teorie

MO pro 2, 3, 4, ..., N_A atomů

Protivazebné orbitaly = **vodivostní pás**

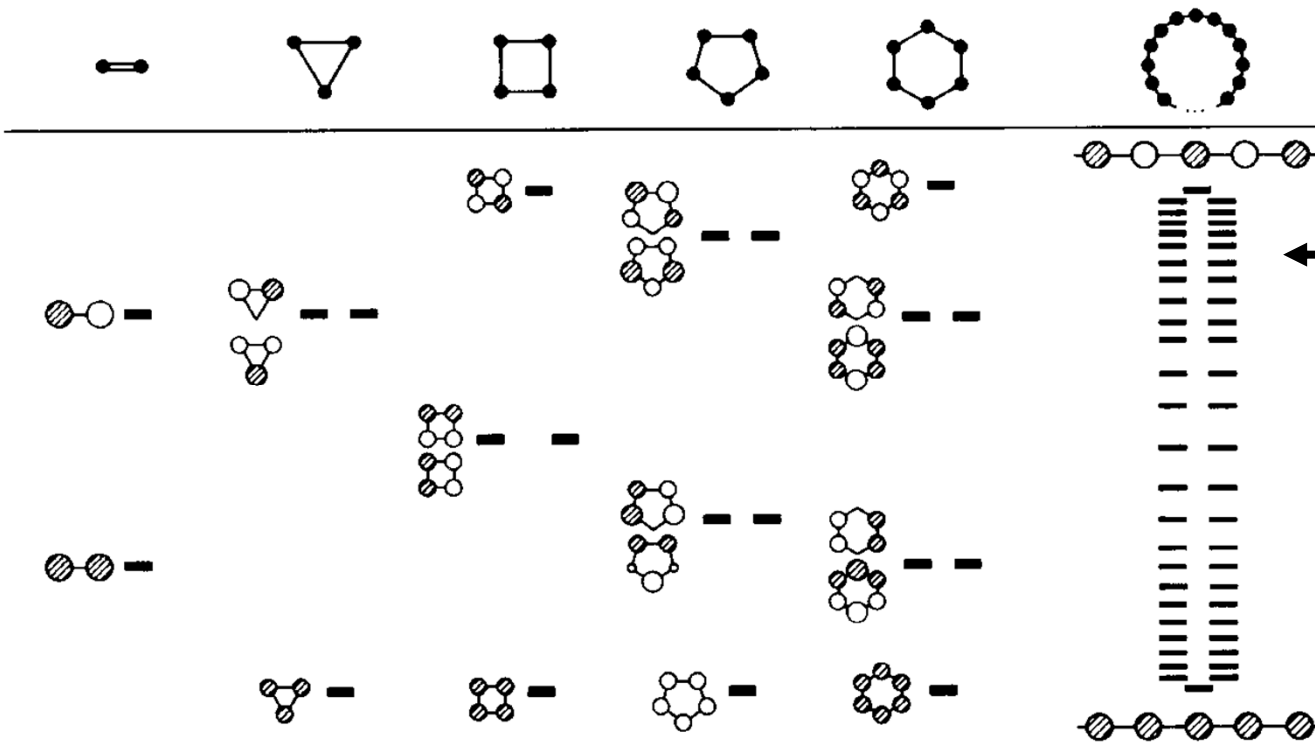

Mnoho hladin
s velmi
blízkou energií
splyne a
vytvoří pás

Vazebné orbitaly = **valenční pás**

Pásová teorie

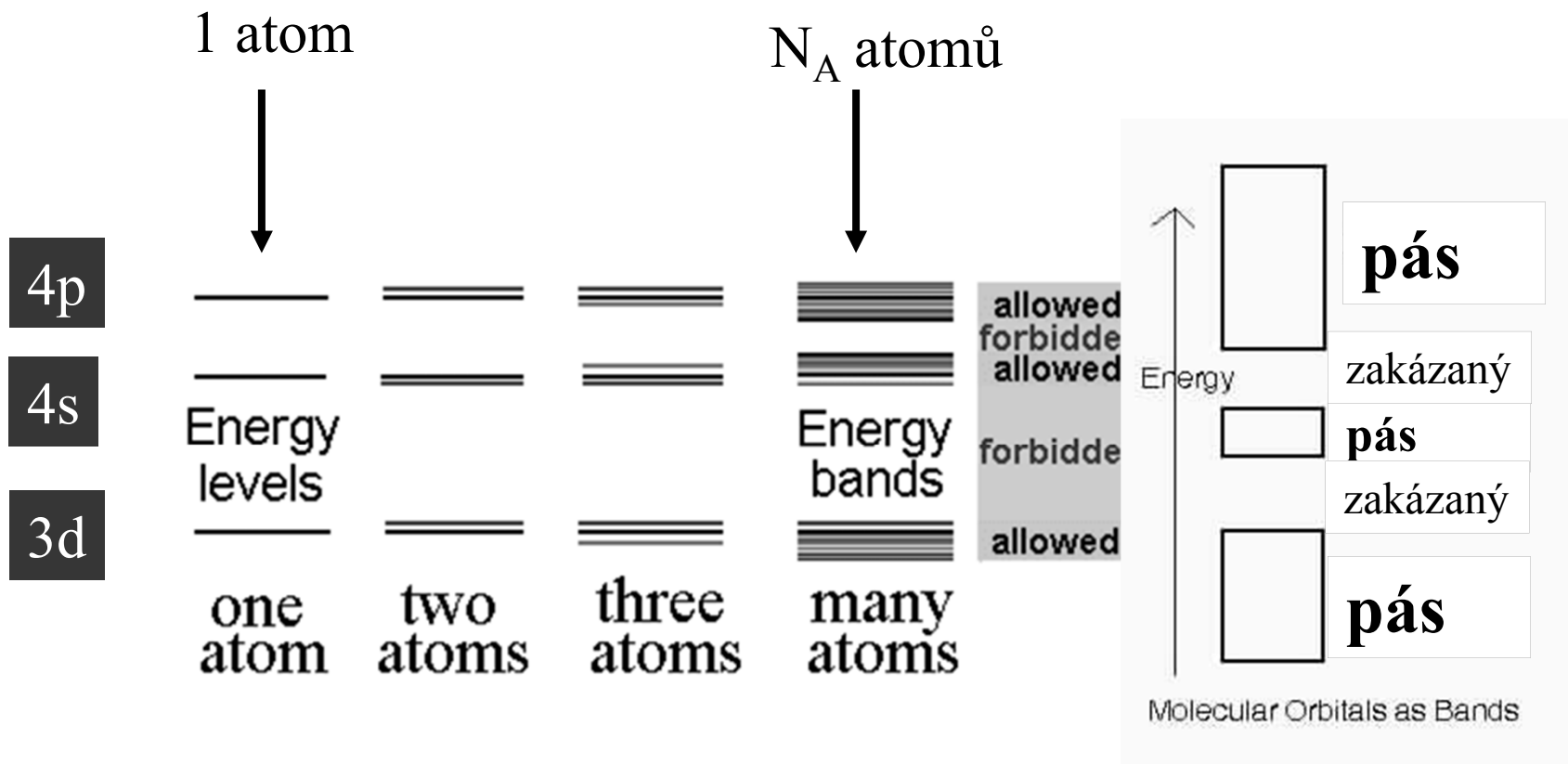

Energie elektronů je kvantována = mohou mít jen určité hodnoty energie, obsazovat jen povolené hladiny, nesmí se vyskytovat v zakázaných pásech.

Zaplňování pásů elektrony

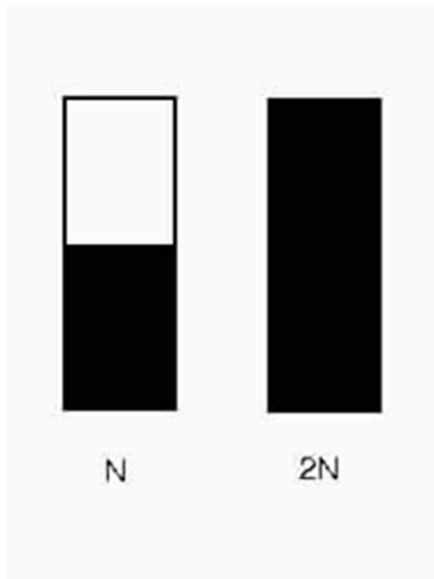

N atomů, každý s 1 elektronem

N hladin v pásu

obsazují se dvojicemi elektronů

$N/2$ hladin zaplněno

$N/2$ hladin neobsazeno

Síla kovové vazby = Molární objemy přechodných kovů

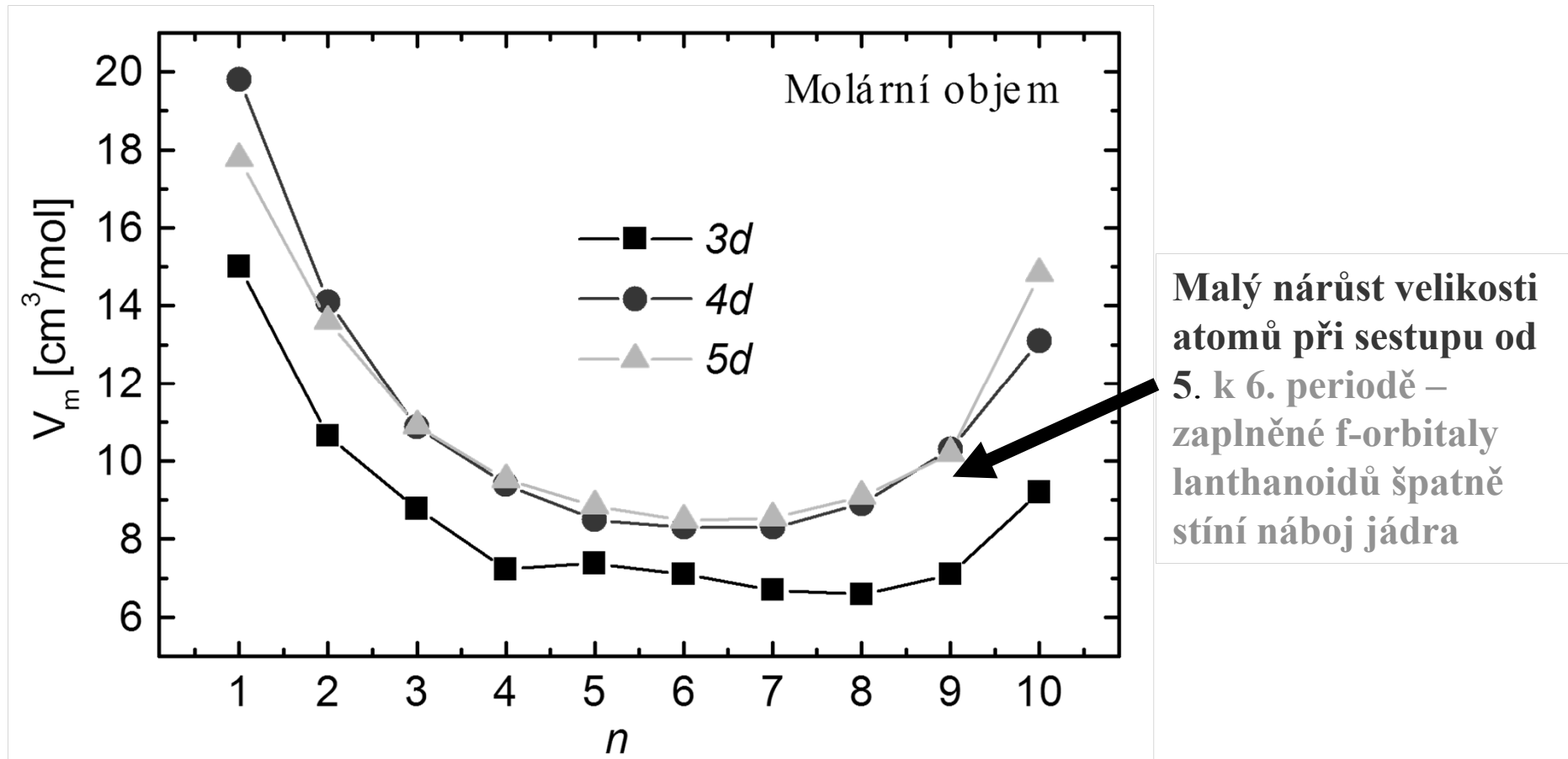

Hustoty a teploty tání přechodných kovů

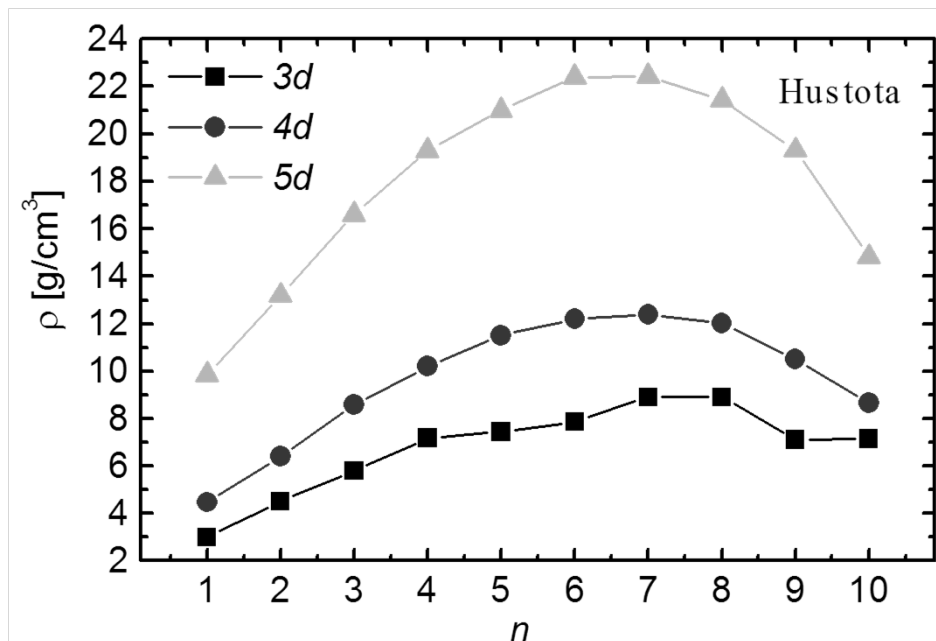

Os 22.5 g cm⁻³

Ir 22.4 g cm⁻³

Teplota tání = Síla kovové vazby

Zaplnování vazebných orbitalů t_{2g} (pásů)

Zaplnování protivazebných orbitalů e_g (pásů)

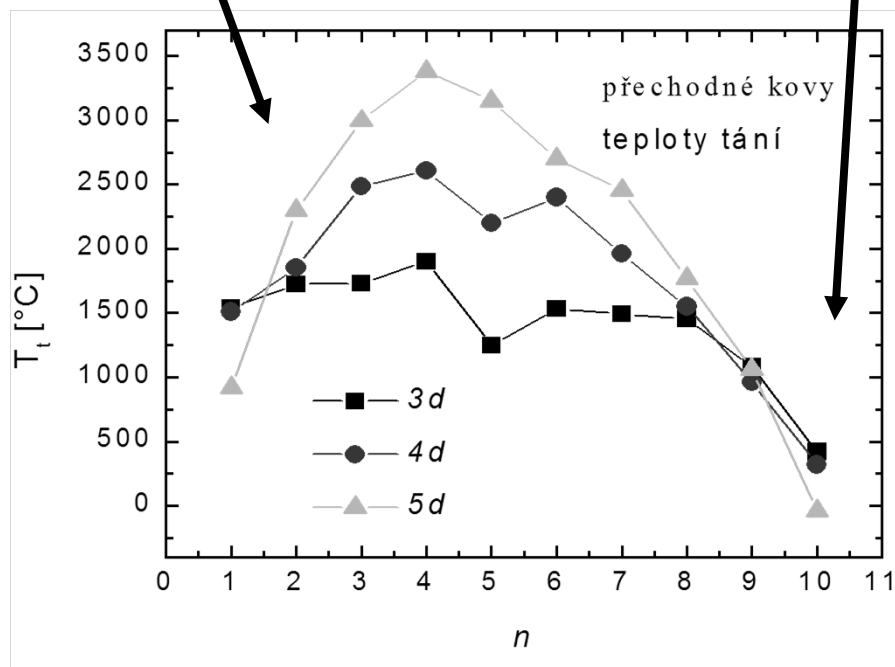

Kapalná rtuť

Kov	El. konf.	T. tání, °C	$\Delta H_{\text{tání}}, \text{kJ mol}^{-1}$
Au	$5d^{10} 6s^1$	1064	12,8
Hg	$5d^{10} 6s^2$	-39	2,3

Lanthanidová kontrakce, sníží se energie pásu 6s, vzdálí se od 6p pásu.

$6s^2$ inertní pár

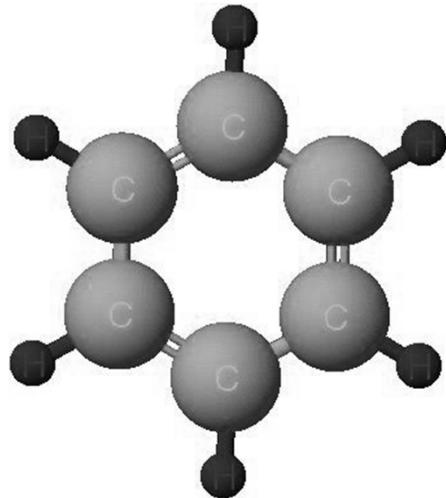

Pásky v grafitu

Grafit je elektrický vodič
 Vodivost ve vrstvách vysoká
 Kolmo na vrstvy nízká
 Anisotropie

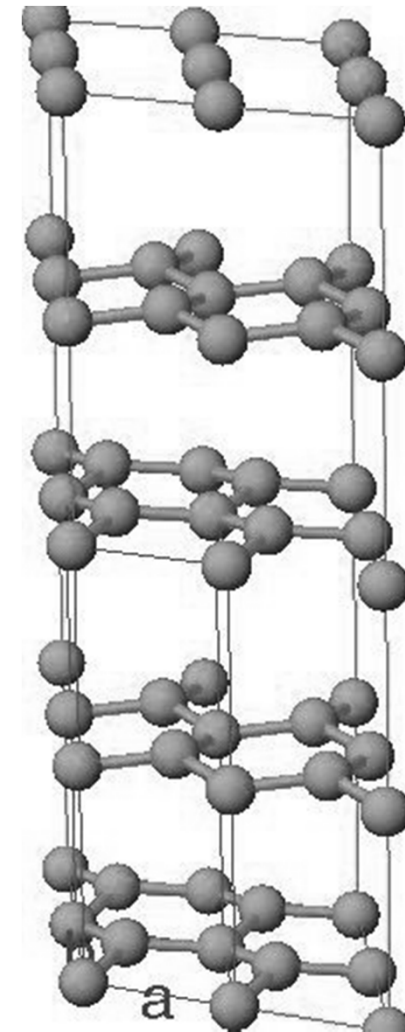
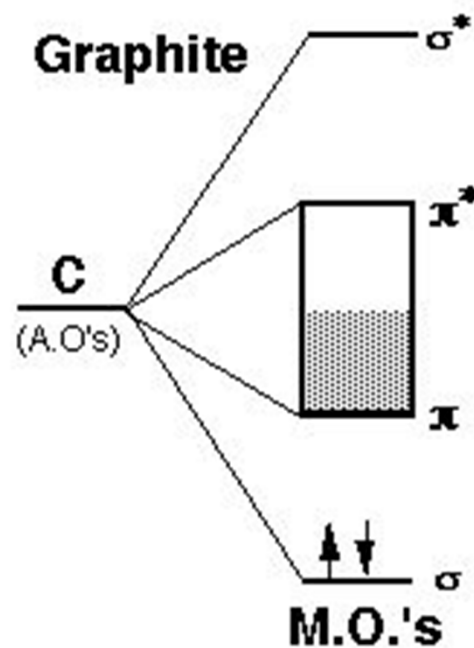
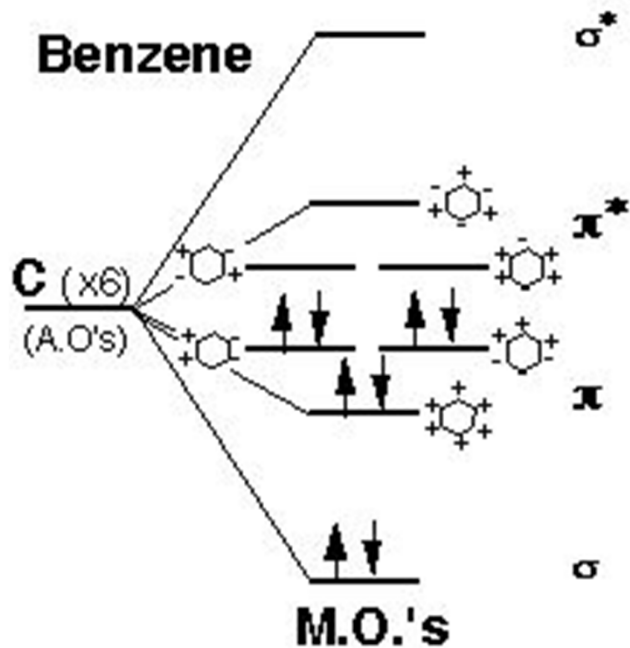

Pásky v diamantu

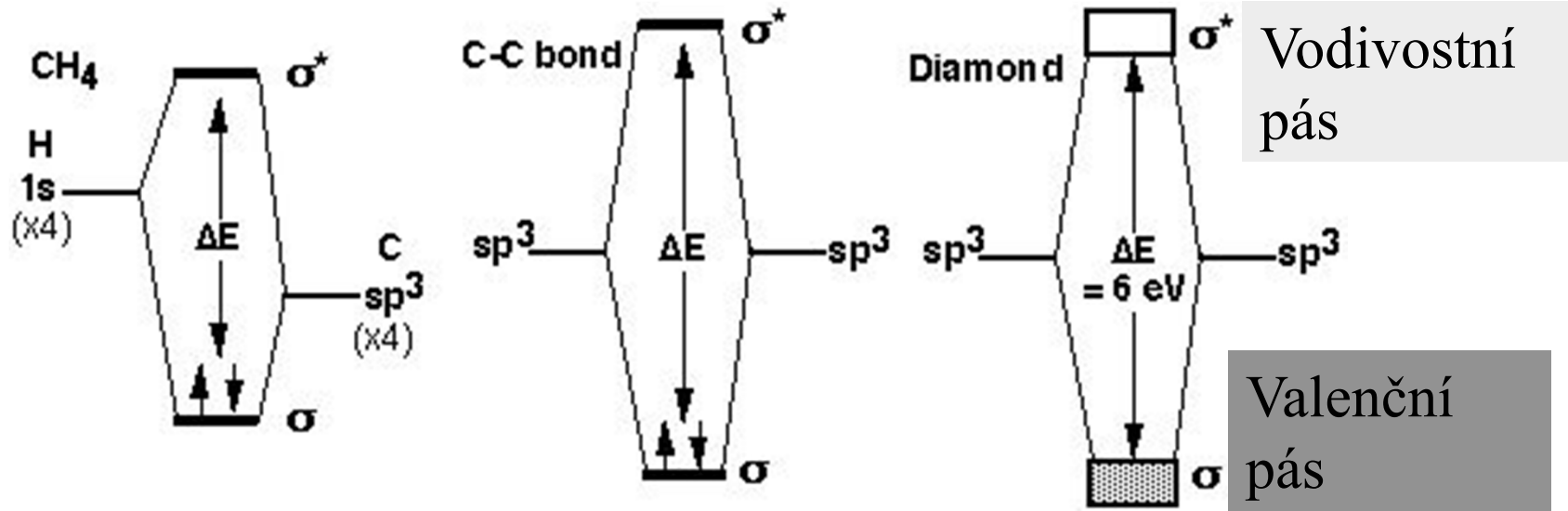

Diamant je elektricky nevodivý
= **izolátor**

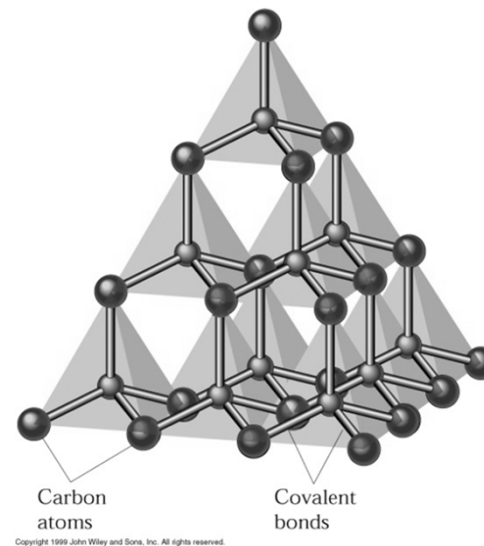

Fermiho hladina

E_f hladina má pravděpodobnost obsazení $1/2$

hladiny

$E < E_f$ obsazené

$E > E_f$ prázdné

$$P = \frac{1}{e^{(E-E_f)/kT} + 1}$$

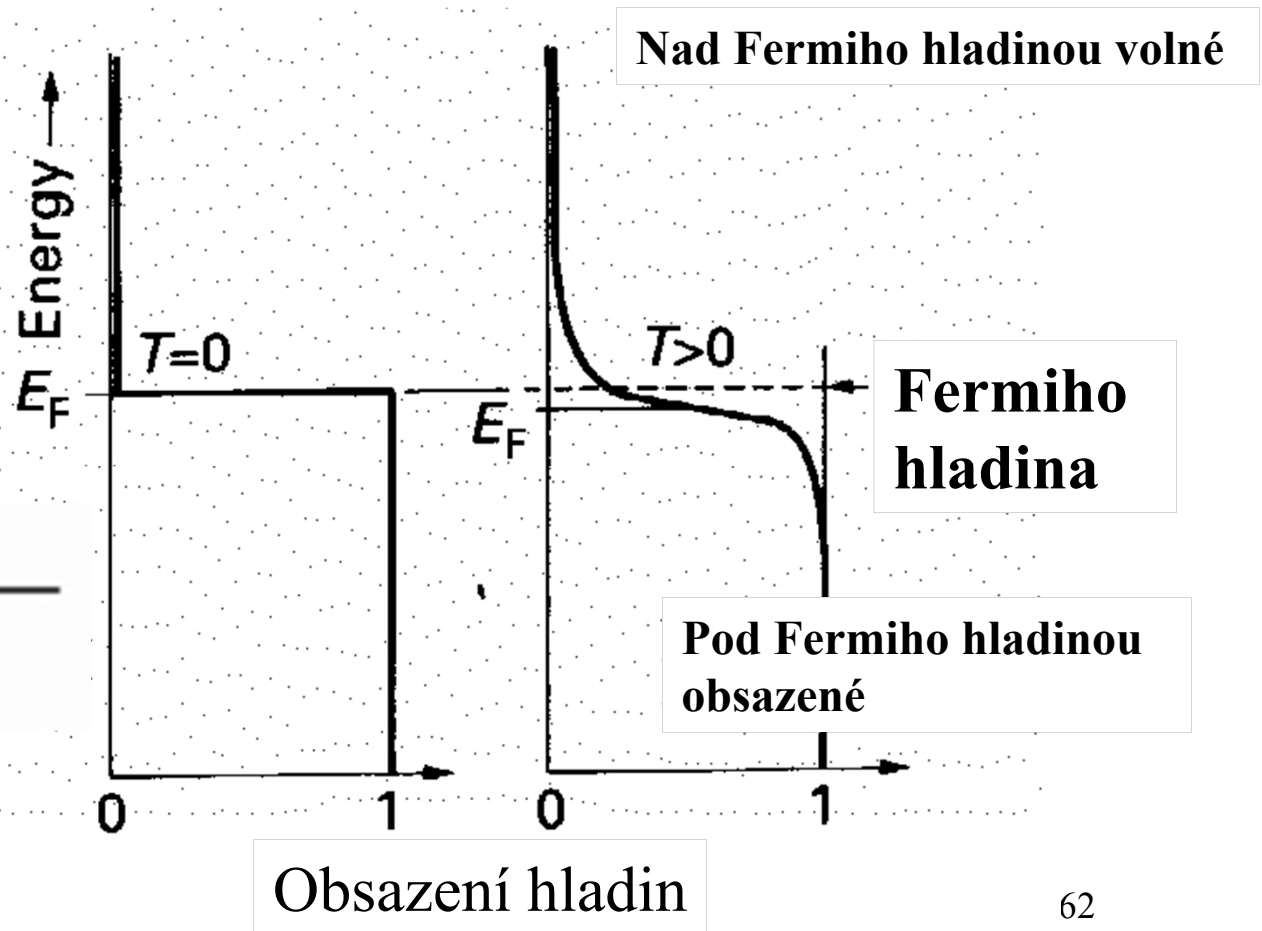

Kovy, vlastní polovodiče, nevodiče

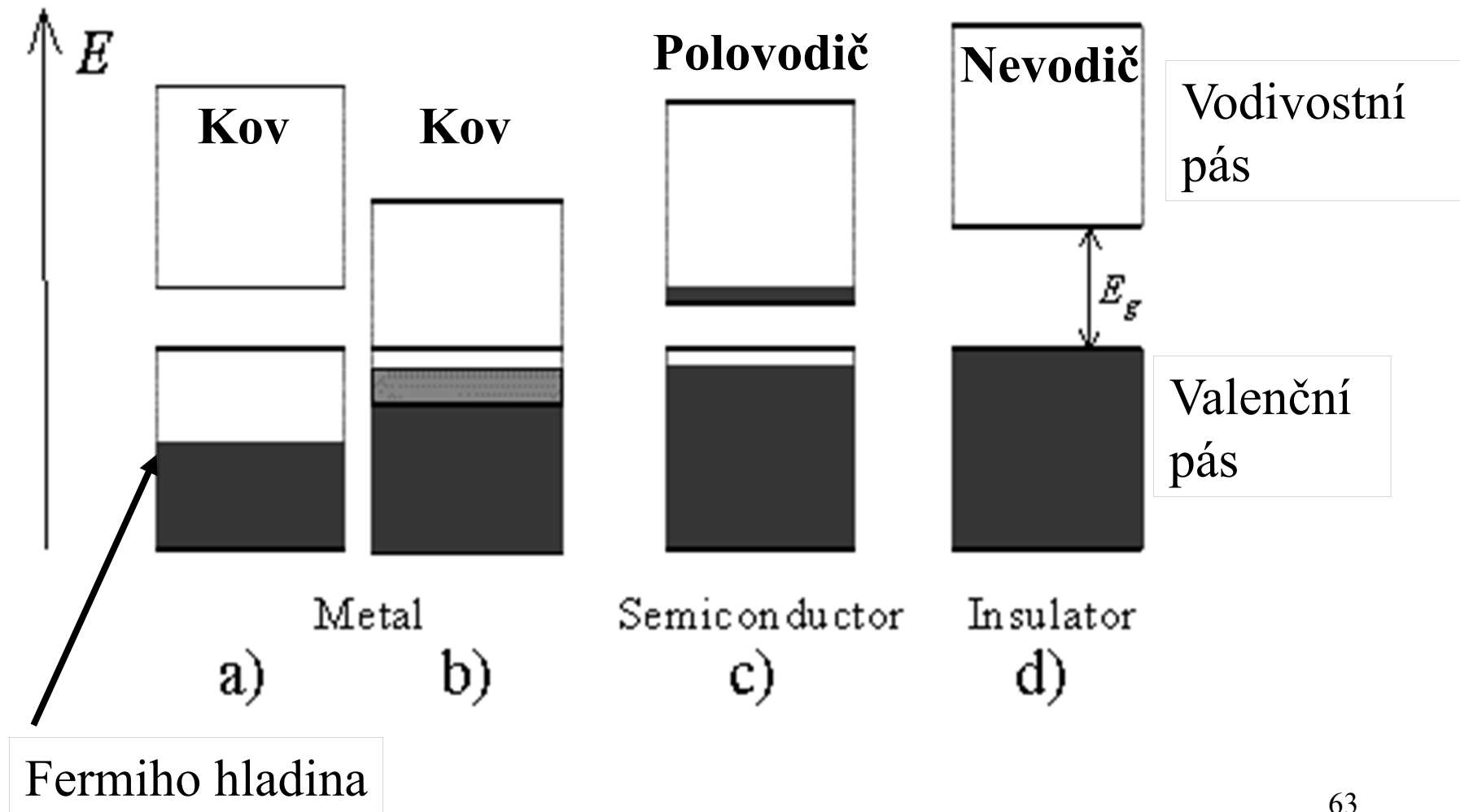

Dopované polovodiče

Křemíkové polovodiče typu n a p

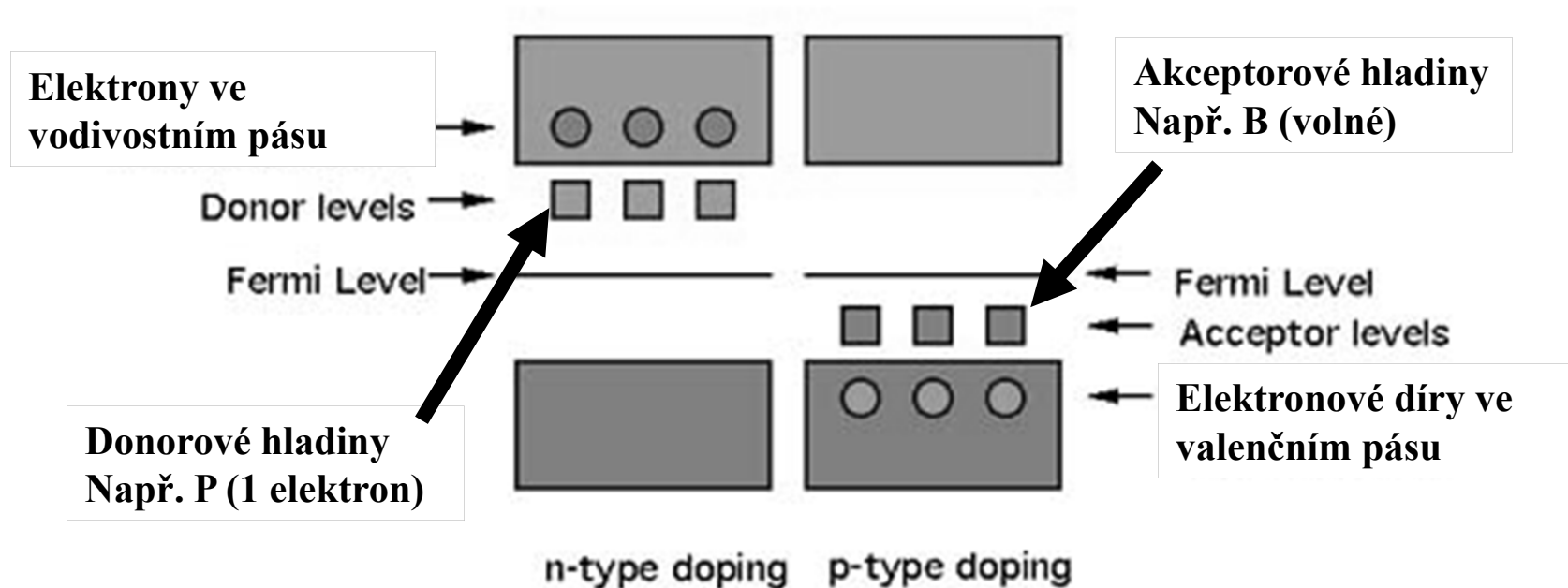

Slitiny

Substituční

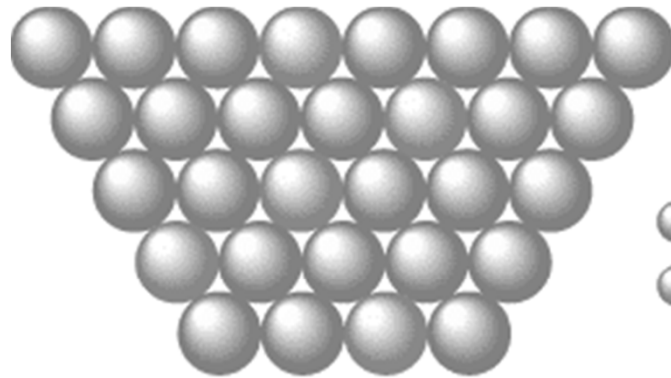

● copper
● zinc

Brass

(a)

Tuhý roztok
Podobná velikost atomů

Intersticiární

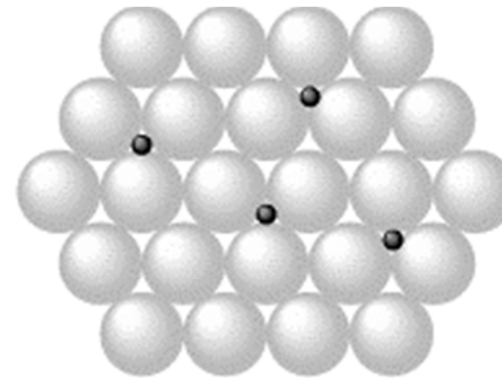

● iron
● carbon

Steel

(b)

Zaplnění mezer malými atomy
(C, N, H)
Pokud stálý poměr kov/nekov
Intersticiární sloučenina (Fe_3C)

Koordinální číslo

Koordinální číslo = počet nejbližších sousedů

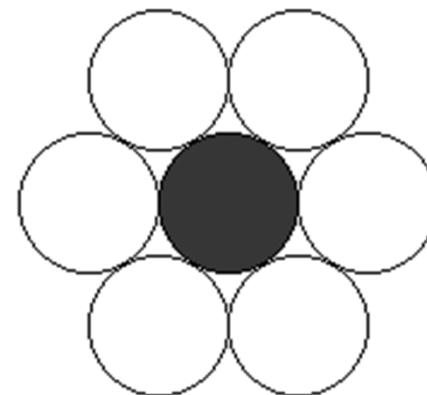
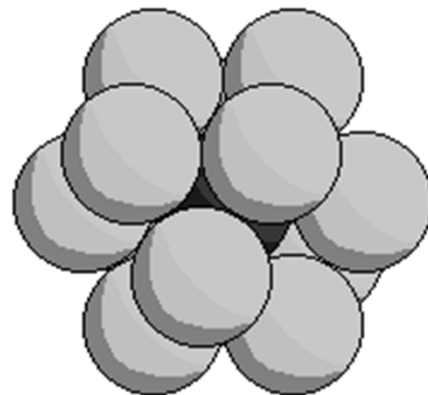
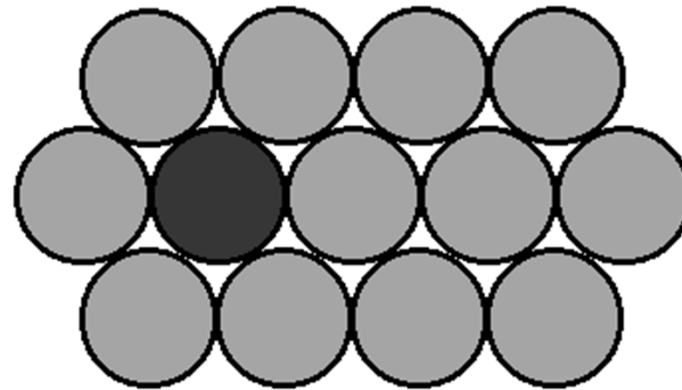
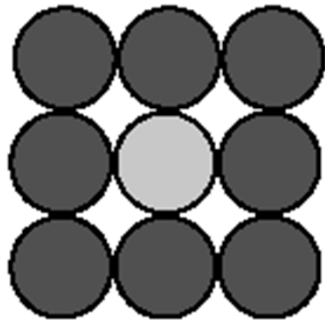

Velikost atomů a iontů

Kovová

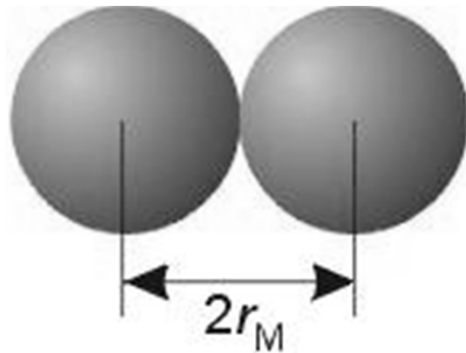

1 Metallic radius

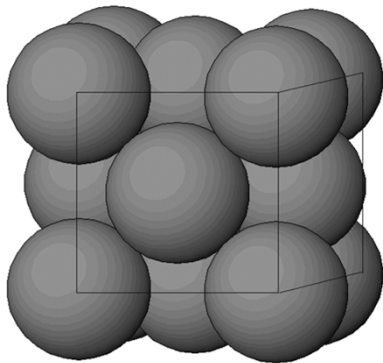

Kovalentní

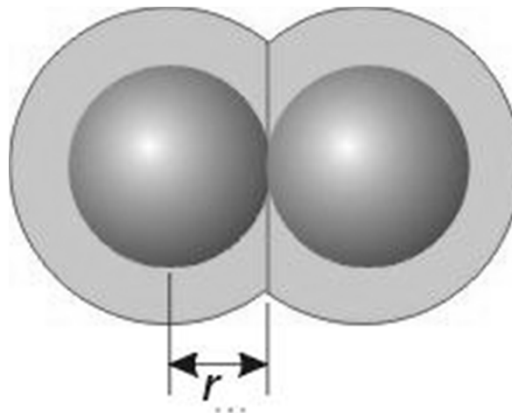

2 Covalent radius

Iontová

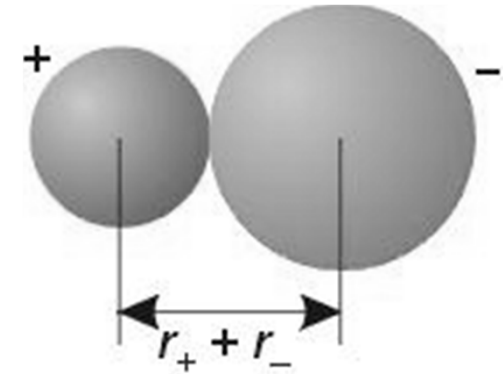

3 Ionic radius

$r(\text{O}) = 140 \text{ pm}$

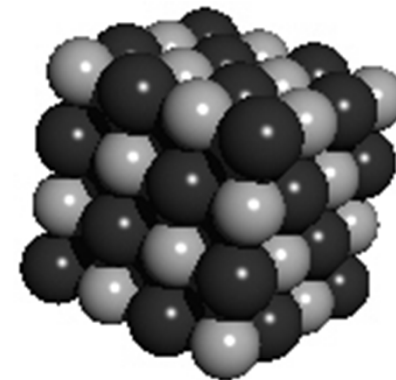

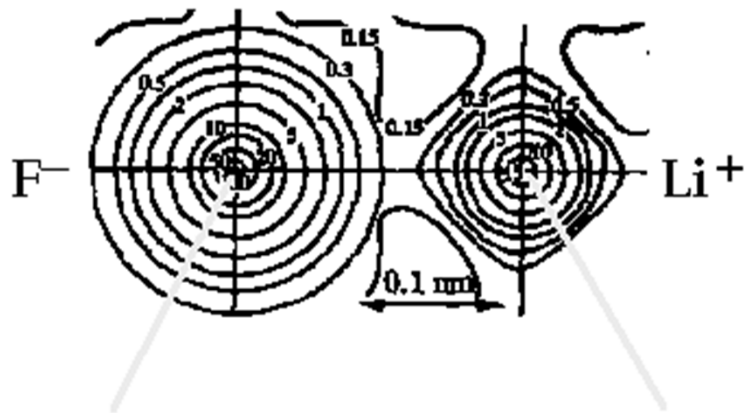

Průběh
elektronové
hustoty

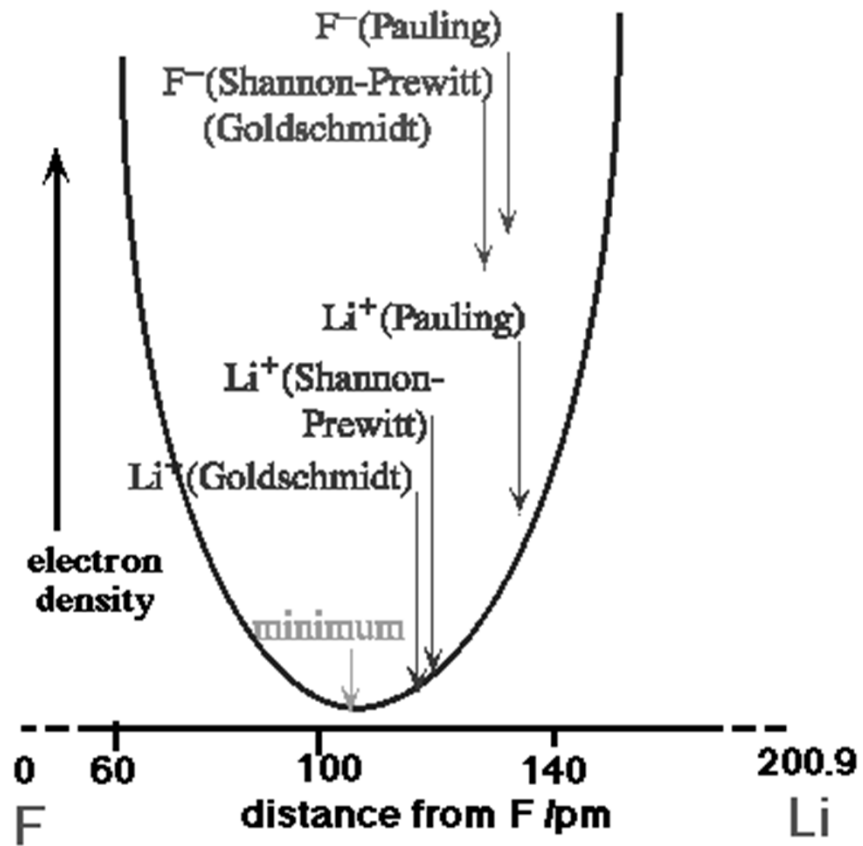

Iontový poloměr

Iontový poloměr roste s rostoucím koordinačním číslem

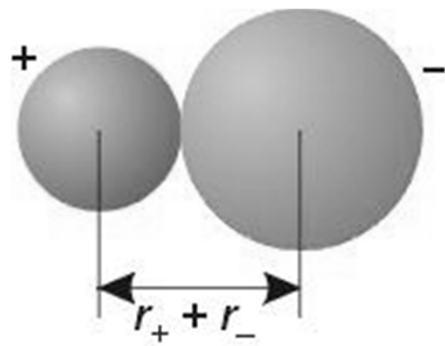

3 Ionic radius

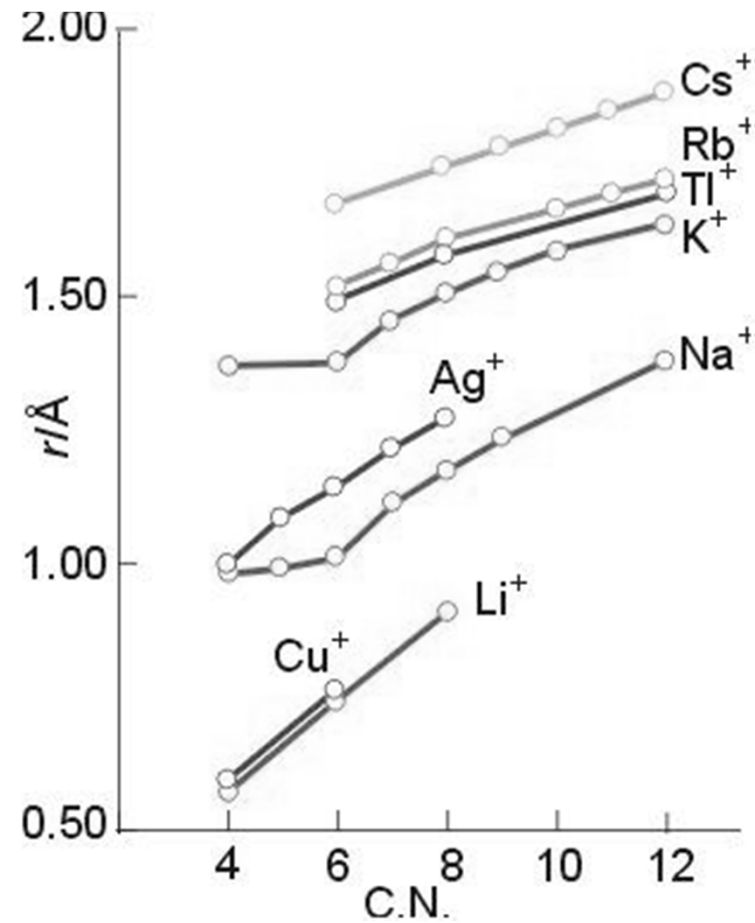

Koordinační číslo