

Bayer – Villigerova oxidace

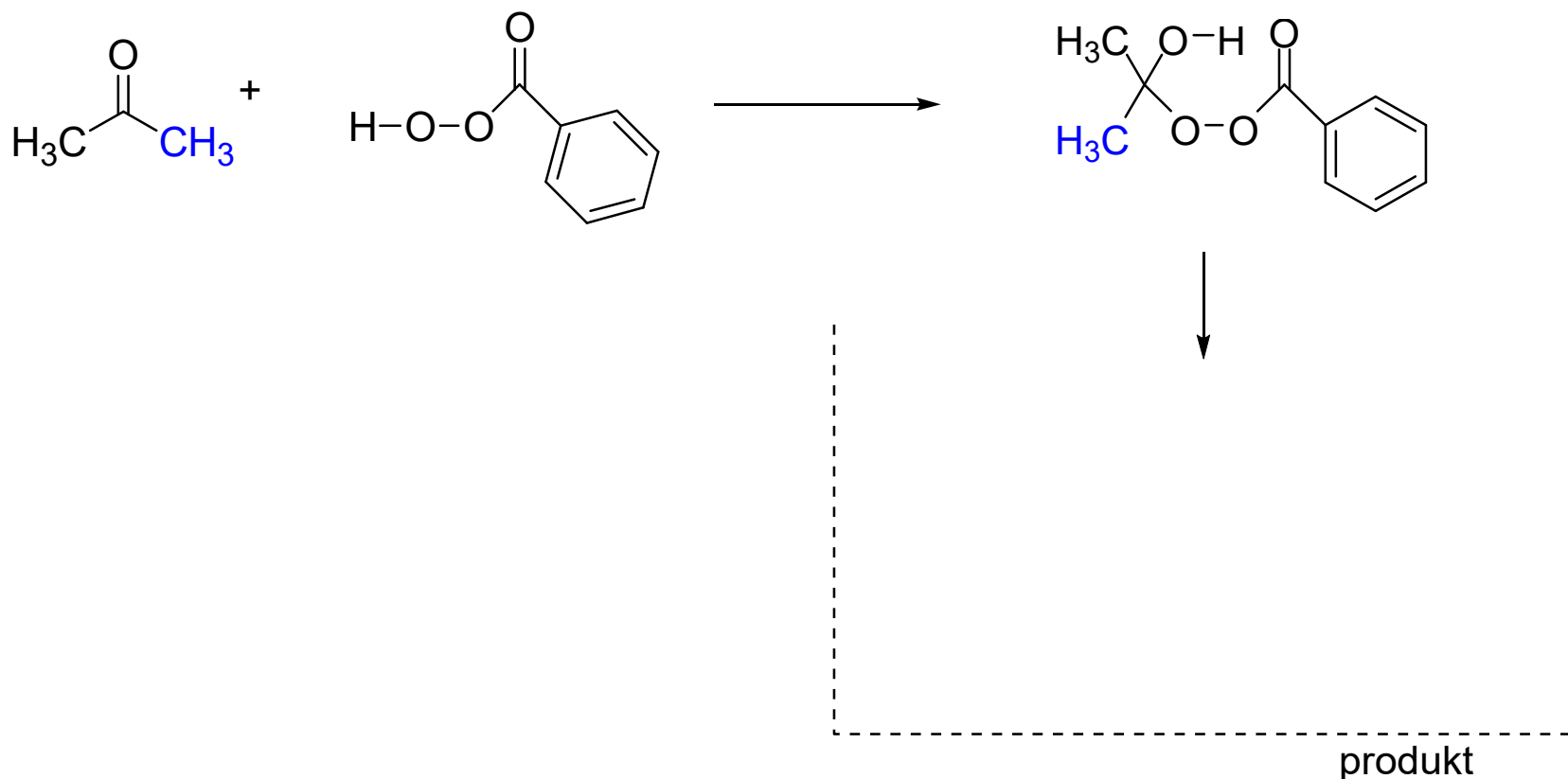

Pomůcka: migrační schopnost skupin
methyl < primární < fenyloxy = sekundární < terciární < H



Bayer – Villigerova oxidace

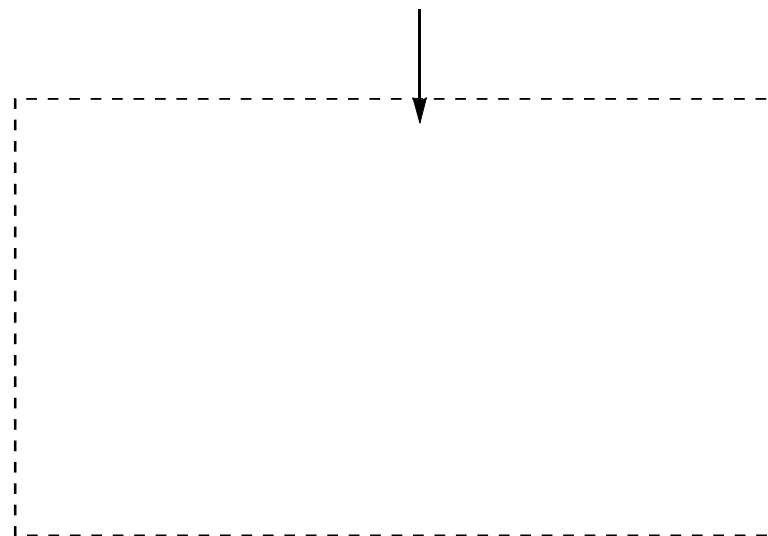
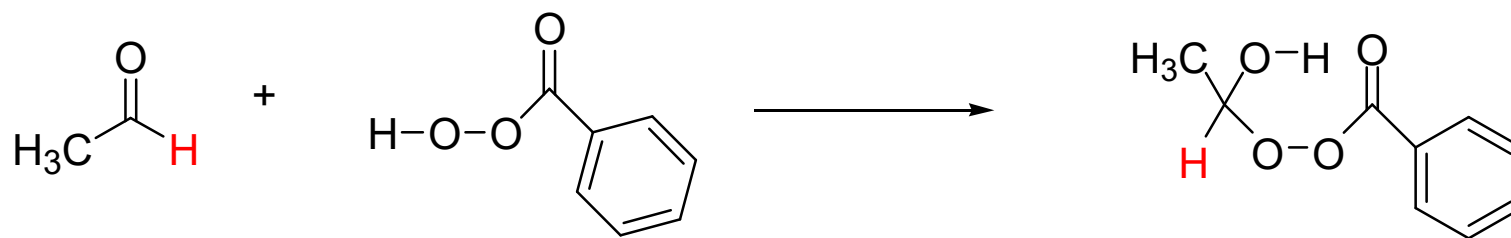

Pomůcka: migrační schopnost skupin
methyl < primární < fenyloxy = sekundární < terciární < H



Bayer – Villigerova oxidace

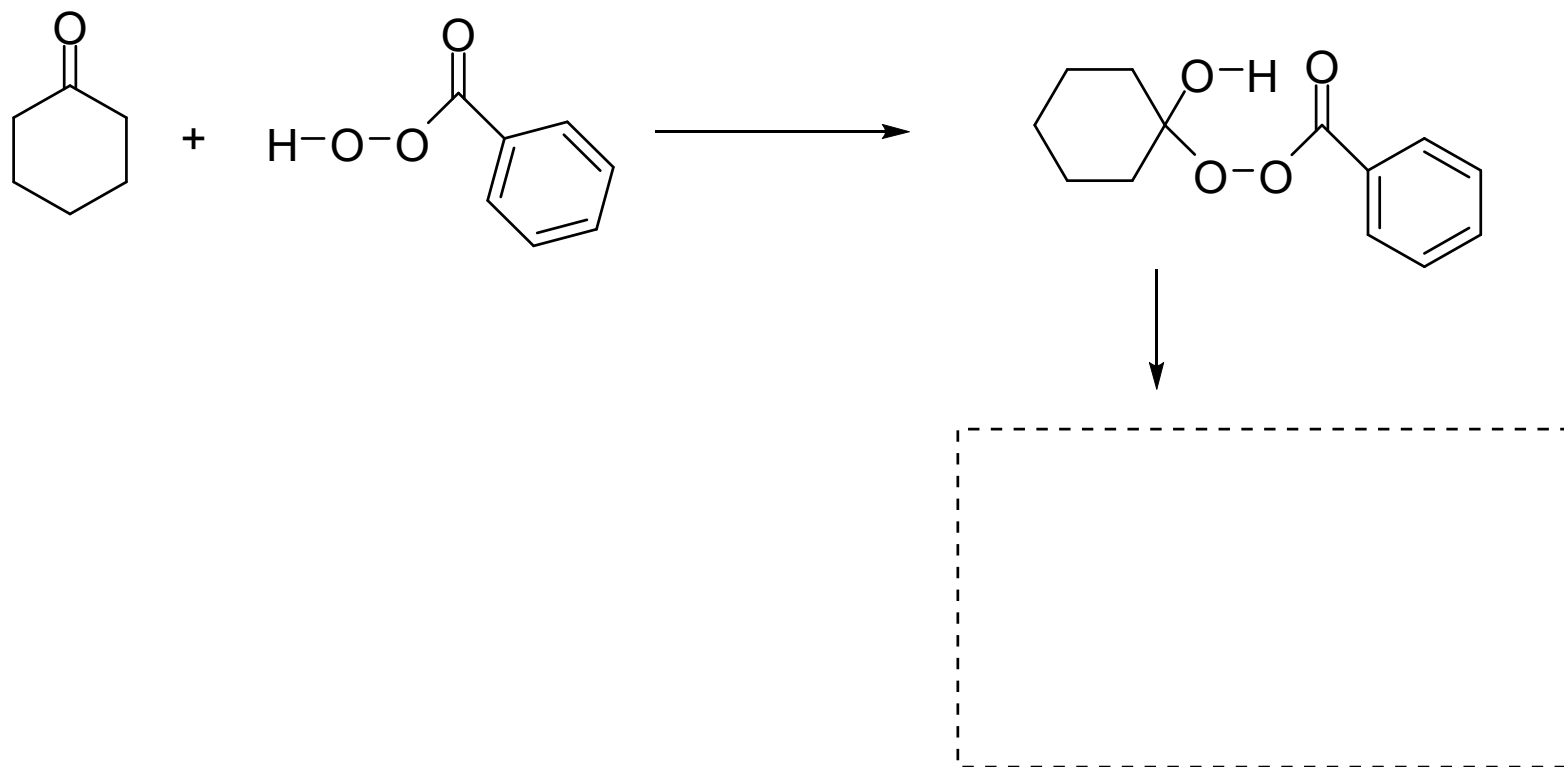

Pomůcka: migrační schopnost skupin
methyl < primární < fenyl = sekundární < terciární < H



Bayer – Villigerova oxidace

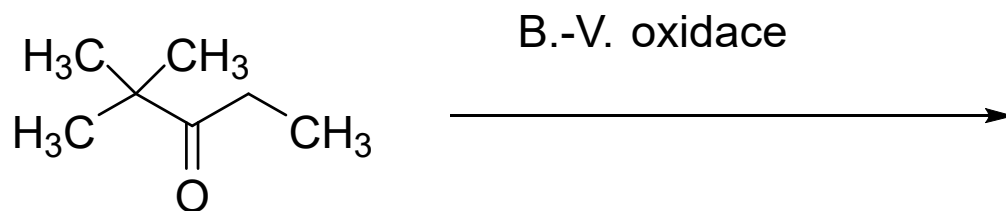

Pomůcka: migrační schopnost skupin
methyl < primární < fenyl = sekundární < terciární < H



Bayer – Villigerova oxidace

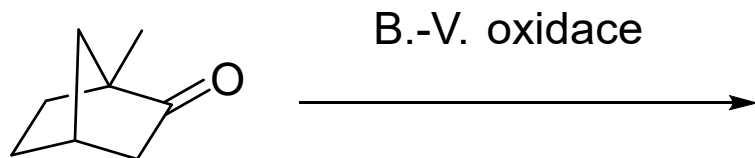

Pomůcka: migrační schopnost skupin
methyl < primární < fenyl = sekundární < terciární < H



ENOLY A ENOLÁTY



	pK_a		pK_a
$R-CH_2-C(=O)-NH_2$	30		
$R-CH_2-C(=O)-OR^1$	25	$RO-C(=O)-CH_2-C(=O)-OR$	13
$R-CH_2-C(=O)-R'$	20	$R-C(=O)-CH_2-C(=O)-OR^1$	11
$R-CH_2-C(=O)-H$	17	$R-C(=O)-CH_2-C(=O)-R$	9
$R-CH_2-C(=O)-Cl$	16	$H-C(=O)-CH_2-C(=O)-H$	5

Keto – enol tautomerie kyselá katalýza

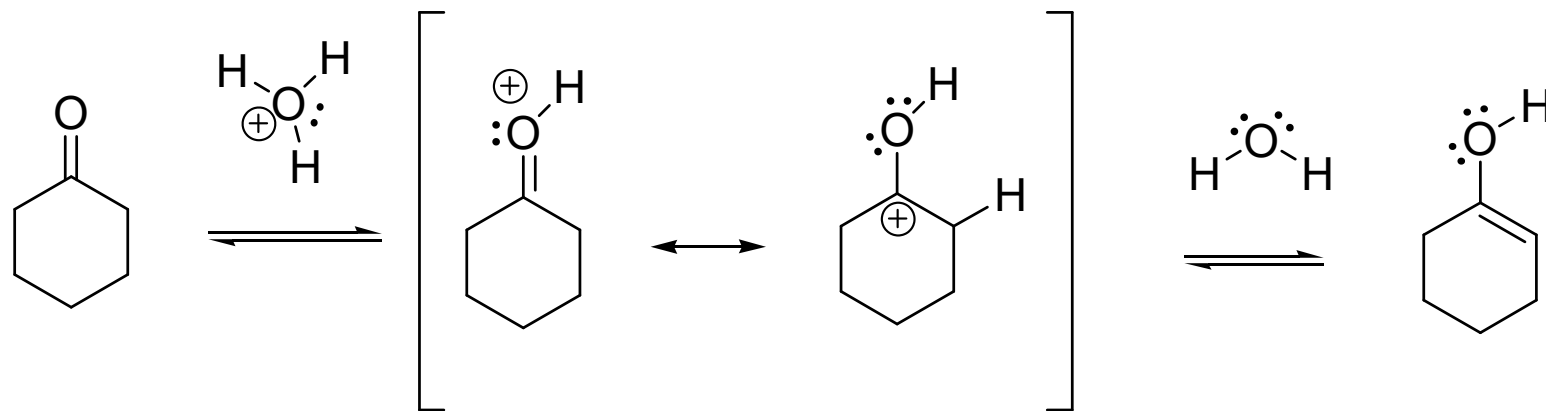

Keto – enol tautomerie bazická katalýza

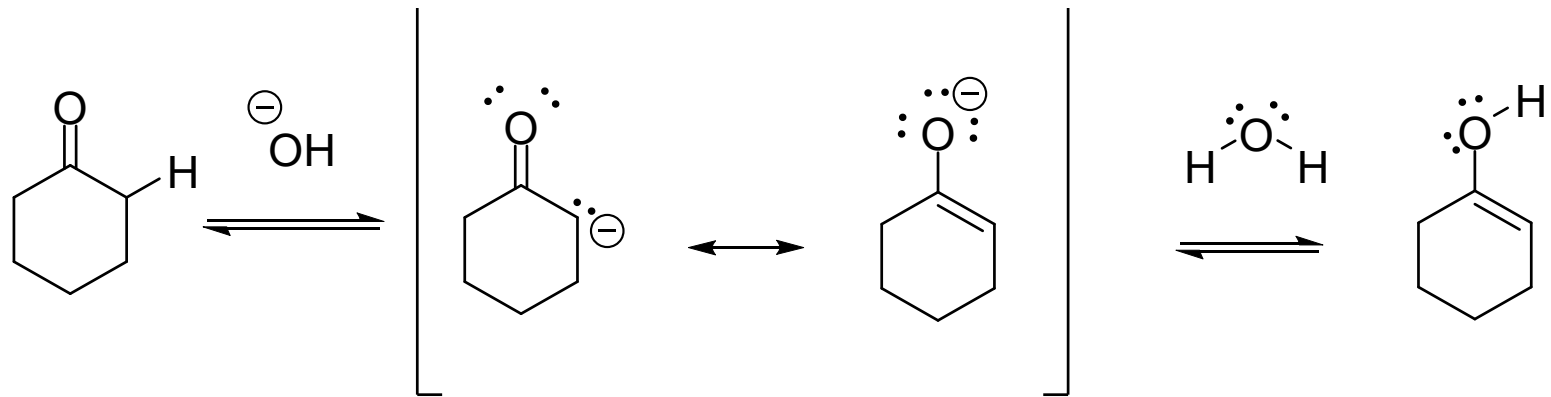

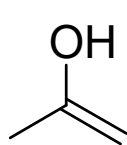

kyselá nebo
bazická katalýza

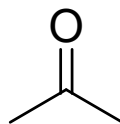

silná báze
aprotické rozpouštědlo THF

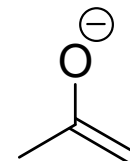

kompletní "nevratná" deprotonace



EtO^-
 EtOH

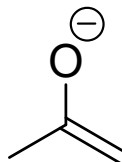

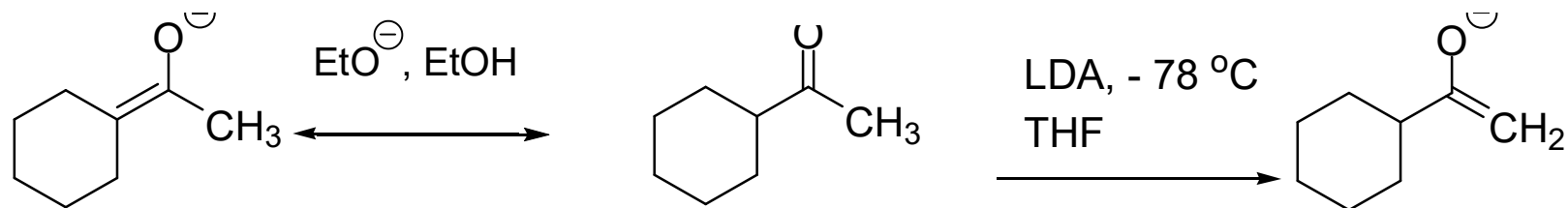

O- versus C-alkylace

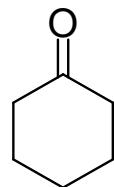

LDA

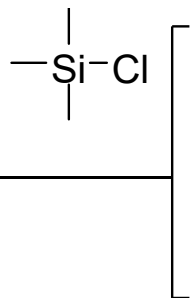

H_3O^+

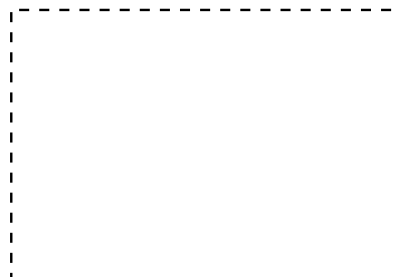
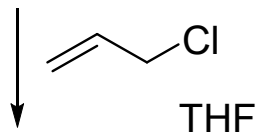
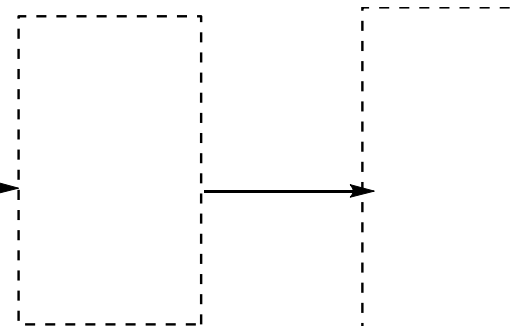

Navrhněte následující syntézu

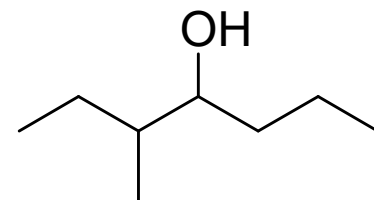
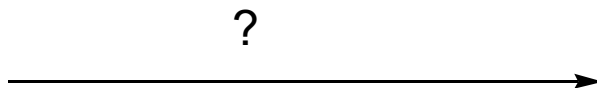
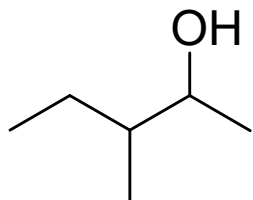

Bazicky katalyzovaná izomerace na alfa-substituovaném ketonu

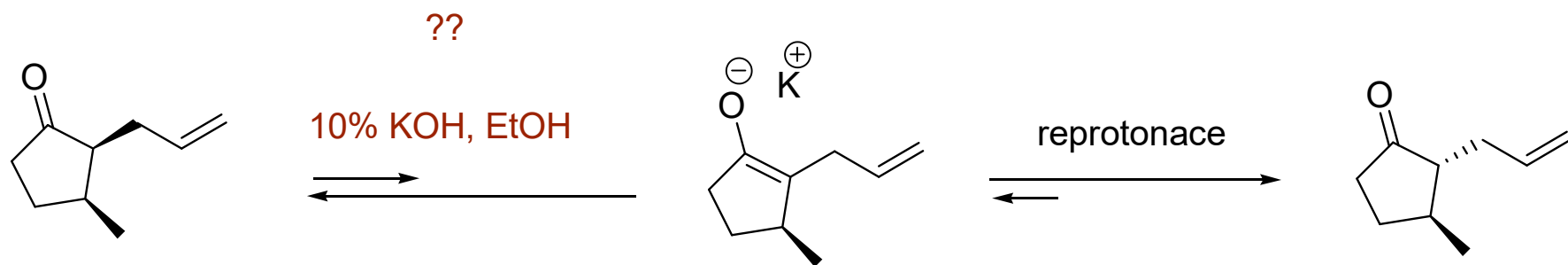

Racemizace opticky aktivního 3-fenylbutan-2-onu

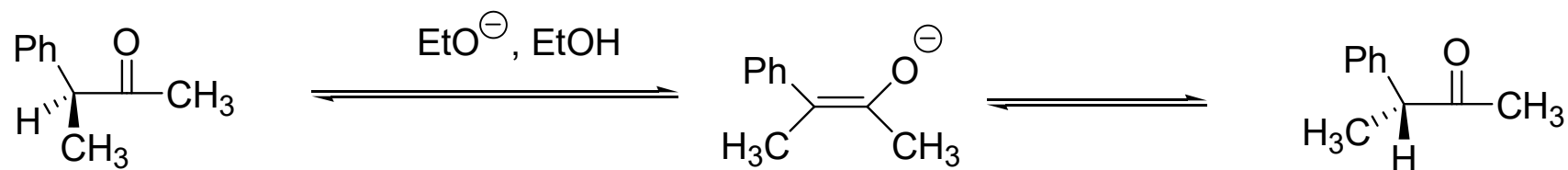

Doplňte produkty uvedených reakcí

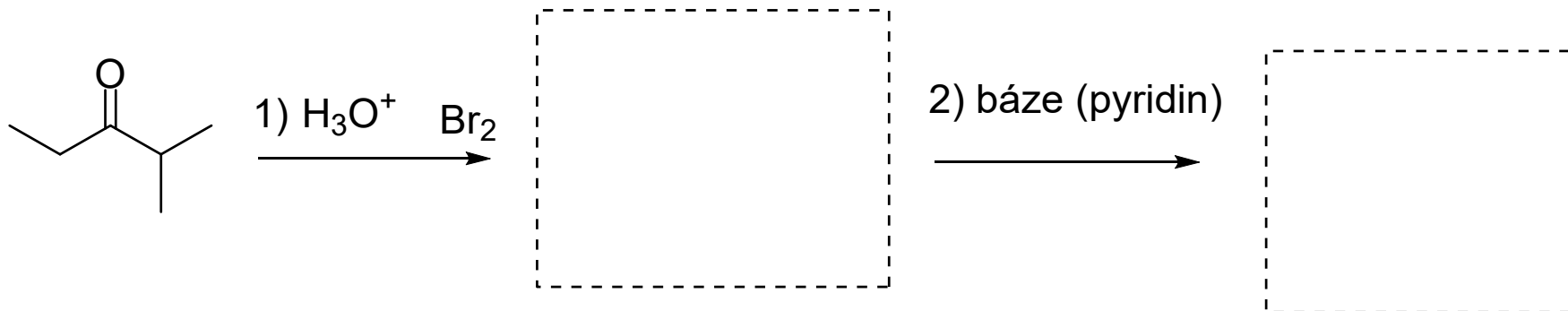

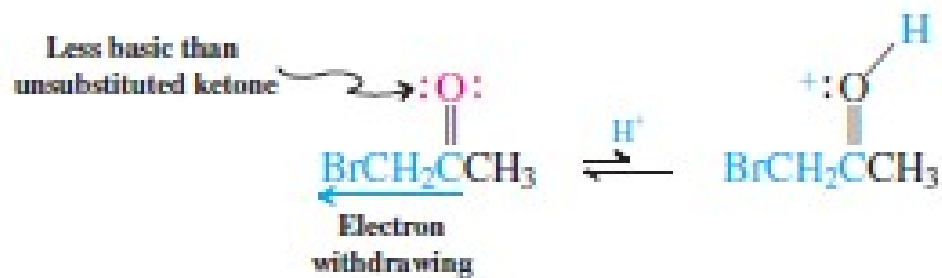
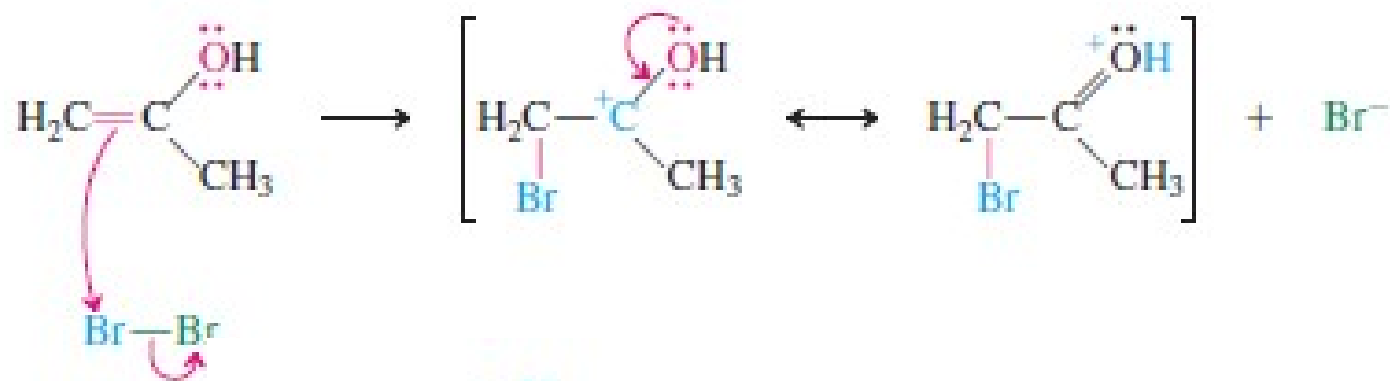
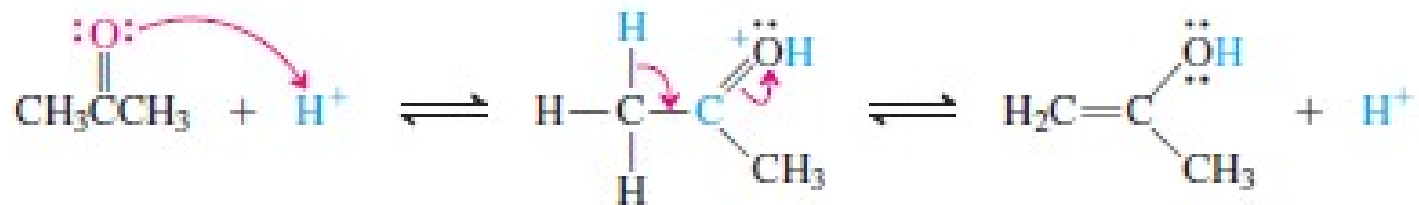

Mechanism of Halogenation of an Enolate Ion

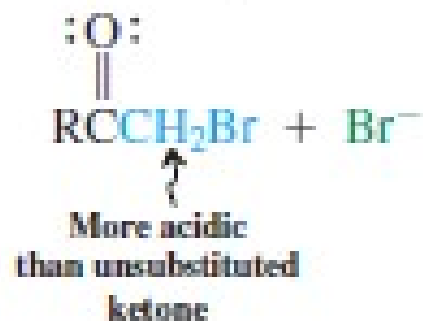
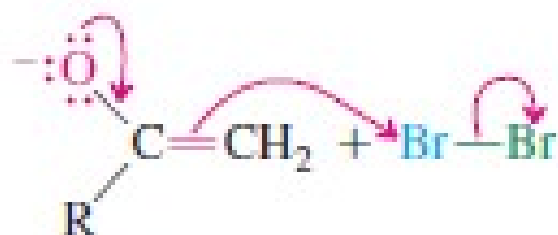

Doplňte produkty uvedených reakcí

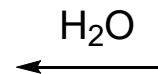
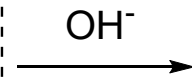
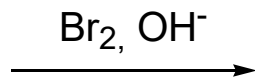
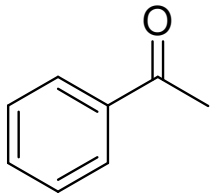
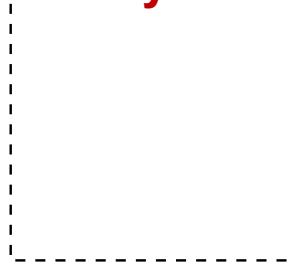
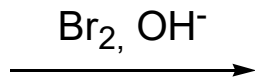
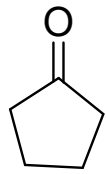

Navrhněte syntézu

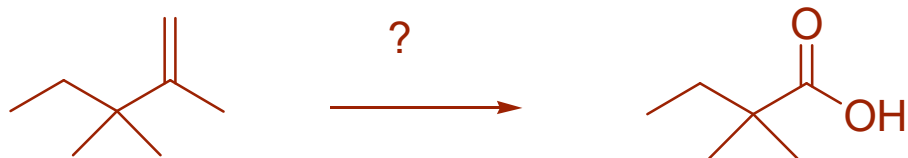

Navrhněte podmínky pro uvedenou syntézu

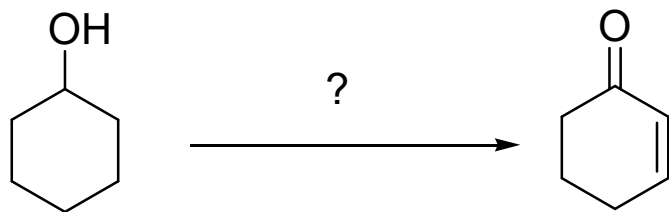

Doplňte produkty reakcí

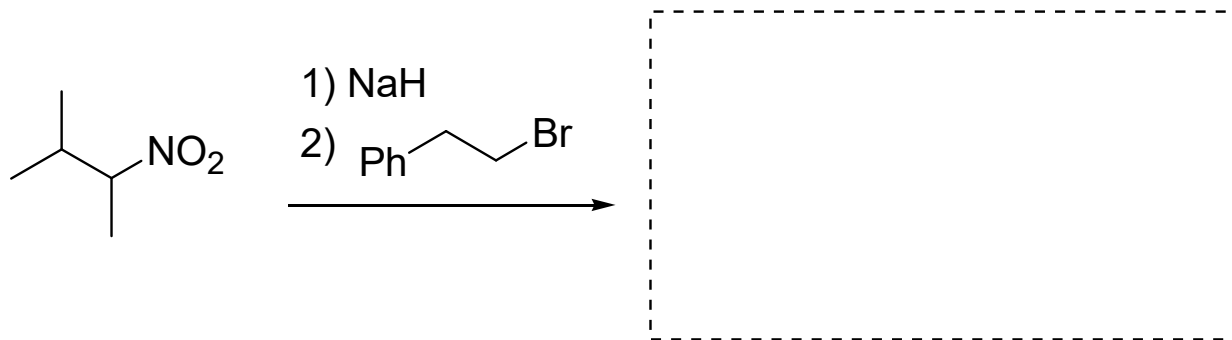

Doplňte produkty reakcí

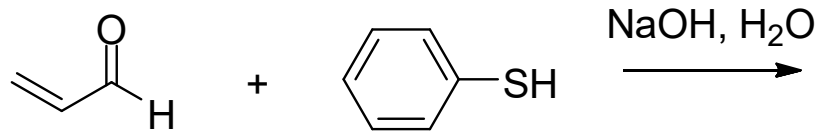

Doplňte produkty reakcí

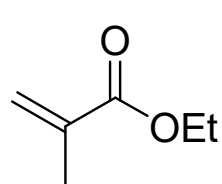

+

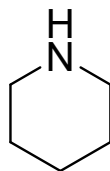



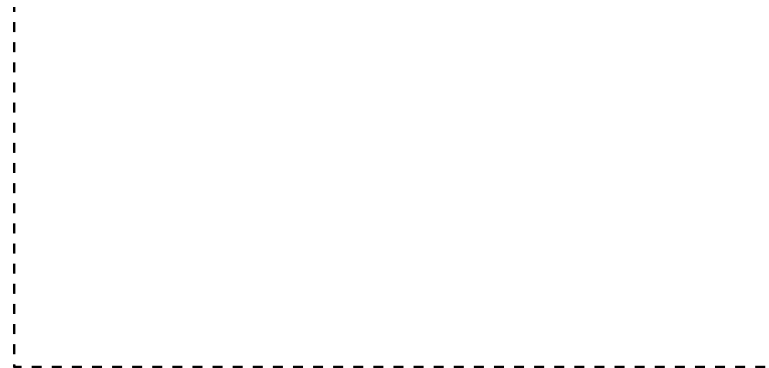

100 °C

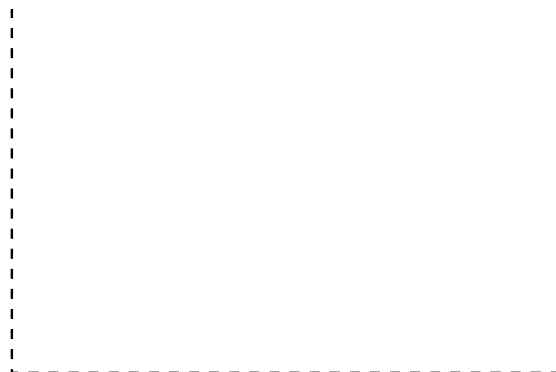
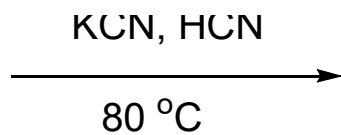
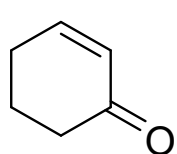

Doplňte produkty reakcí

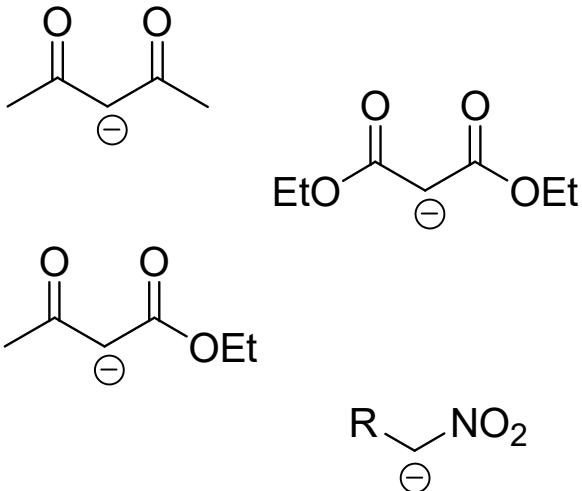

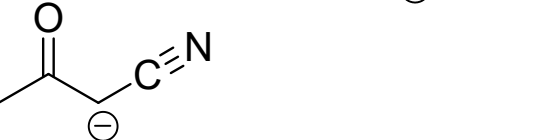
Michaelova adice

Michaelovy donory	Michaelovy akceptory
	
	



Michaelova adice

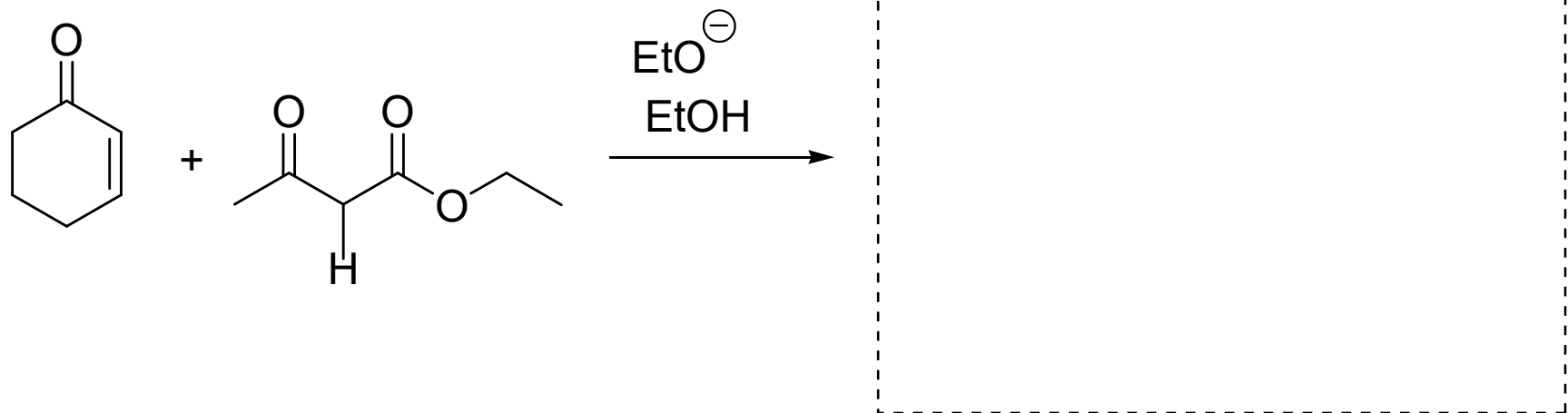

Michaelova adice
navrhněte syntézu uvedené sloučeniny

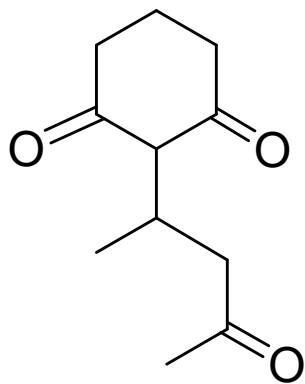

Aldolová reakce a aldolová kondenzace

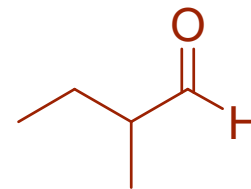
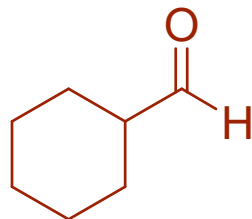
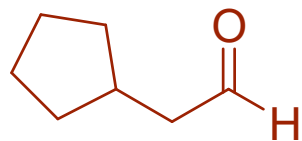

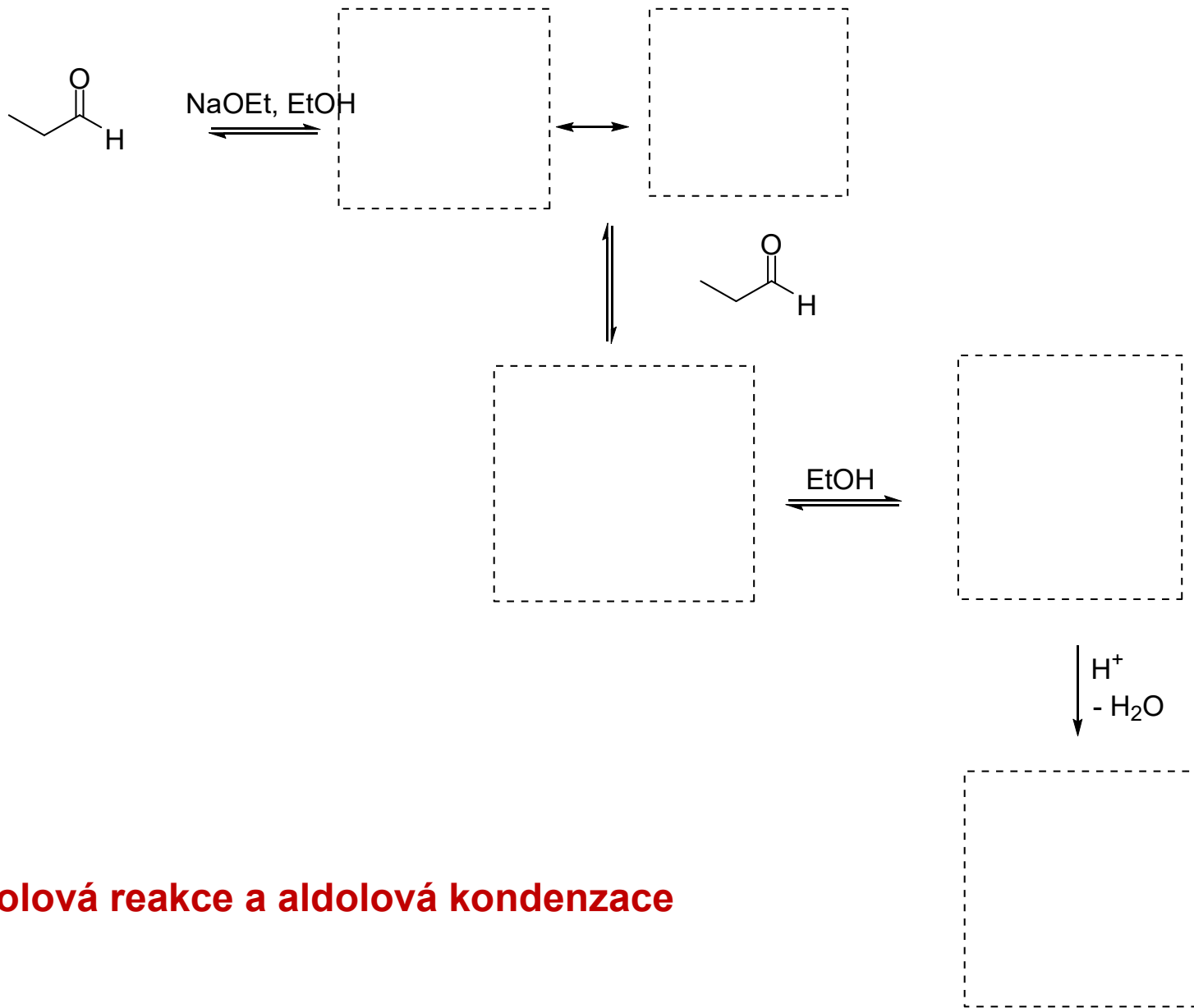

Aldolová reakce a aldolová kondenzace



Aldolová reakce a aldolová kondenzace

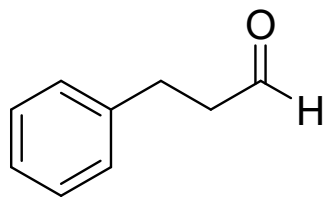

NaOEt, EtOH

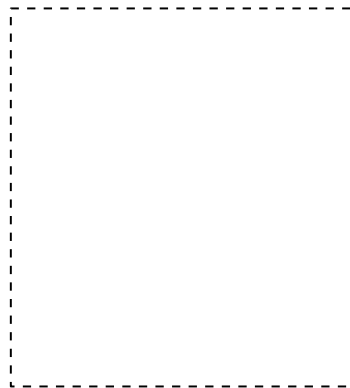
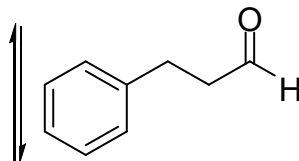
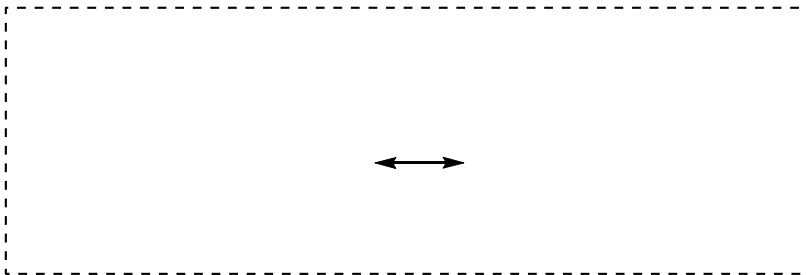

EtOH

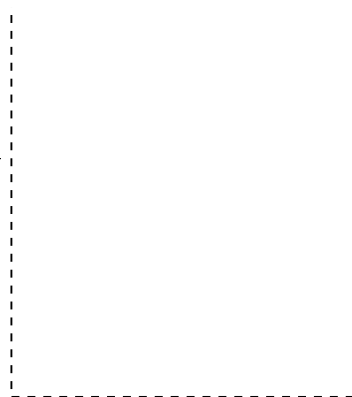
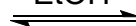

\downarrow H⁺
- H₂O



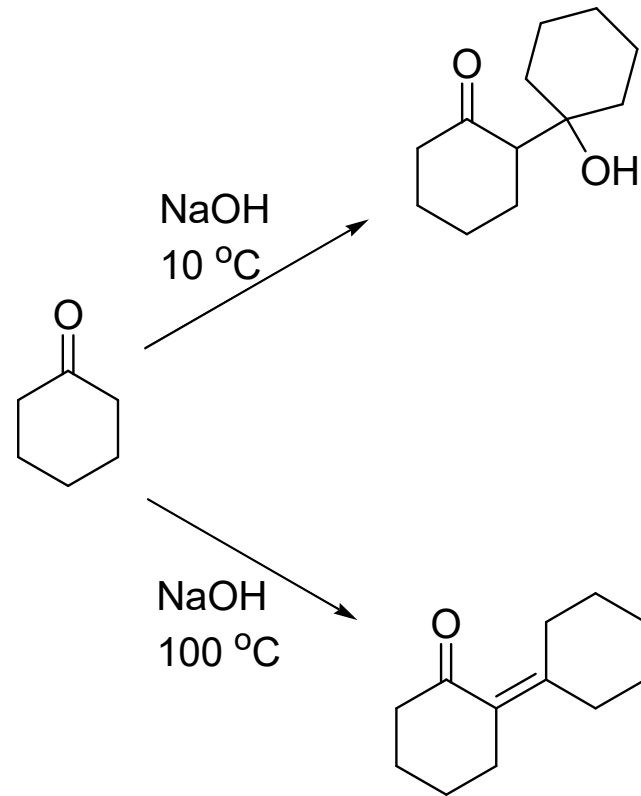

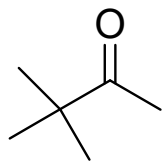

? produkt aldolové kondenzace

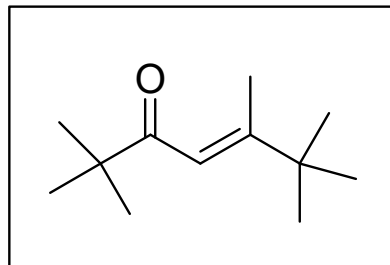

+

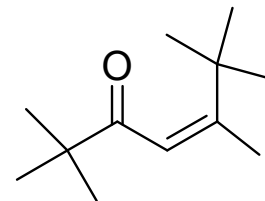

prevládá
menší sterická zábrana



Identifikujte reagenty, které poskytly následující sloučeniny

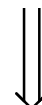
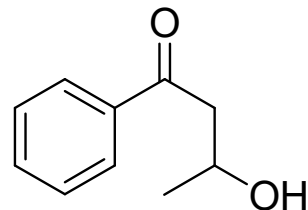
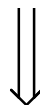
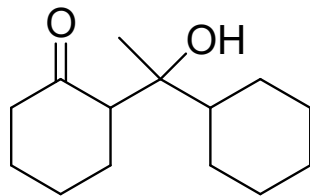
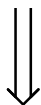
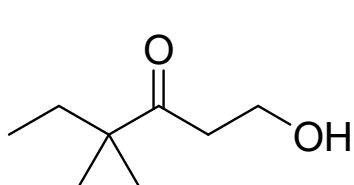

Identifikujte reagenty, které poskytly následující sloučeninu

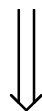
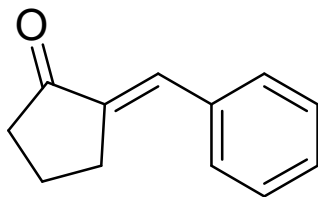

Aldolová kondenzace - retrosyntéza

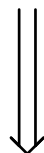
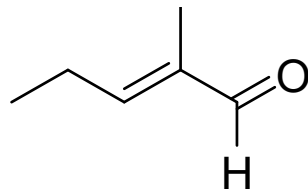

Aldolová kondenzace - retrosyntéza

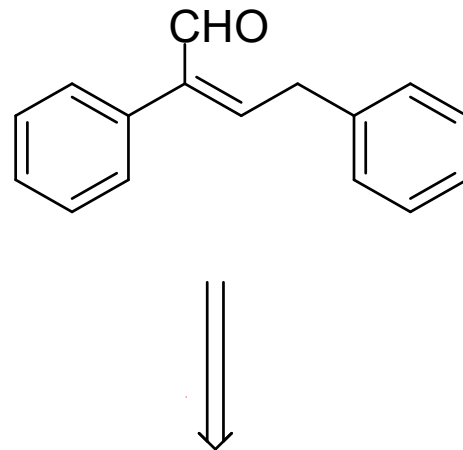

Aldolová kondenzace - retrosyntéza

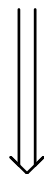
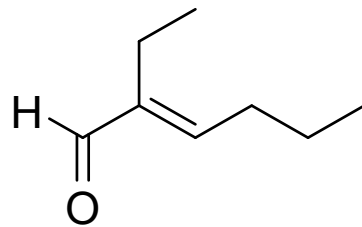

Zkřížená aldolová reakce

- 1) Jeden z aldehydů nemá v alfa pozici vodíky
- 2) LDA – 100% tvorba enolátu a potom přidavek další komponenty

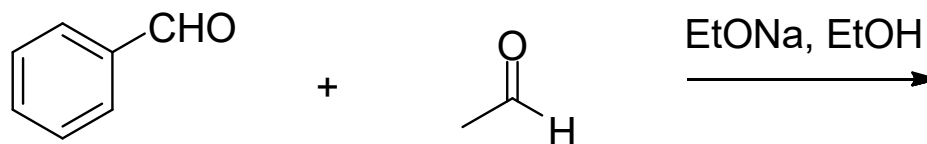

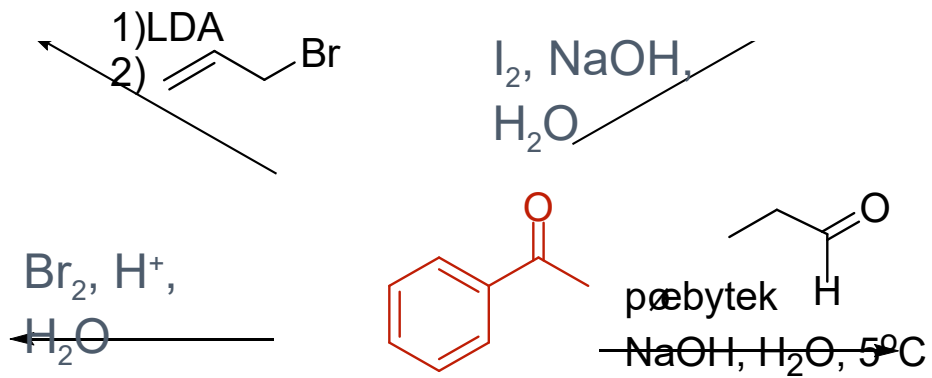

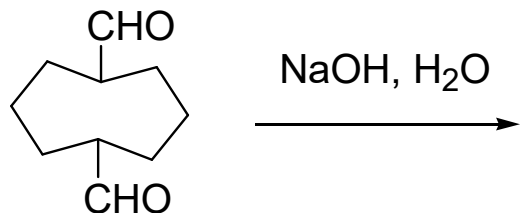

Mannichova reakce - aminomethylační reakce v alfa pozici ke karbonylu

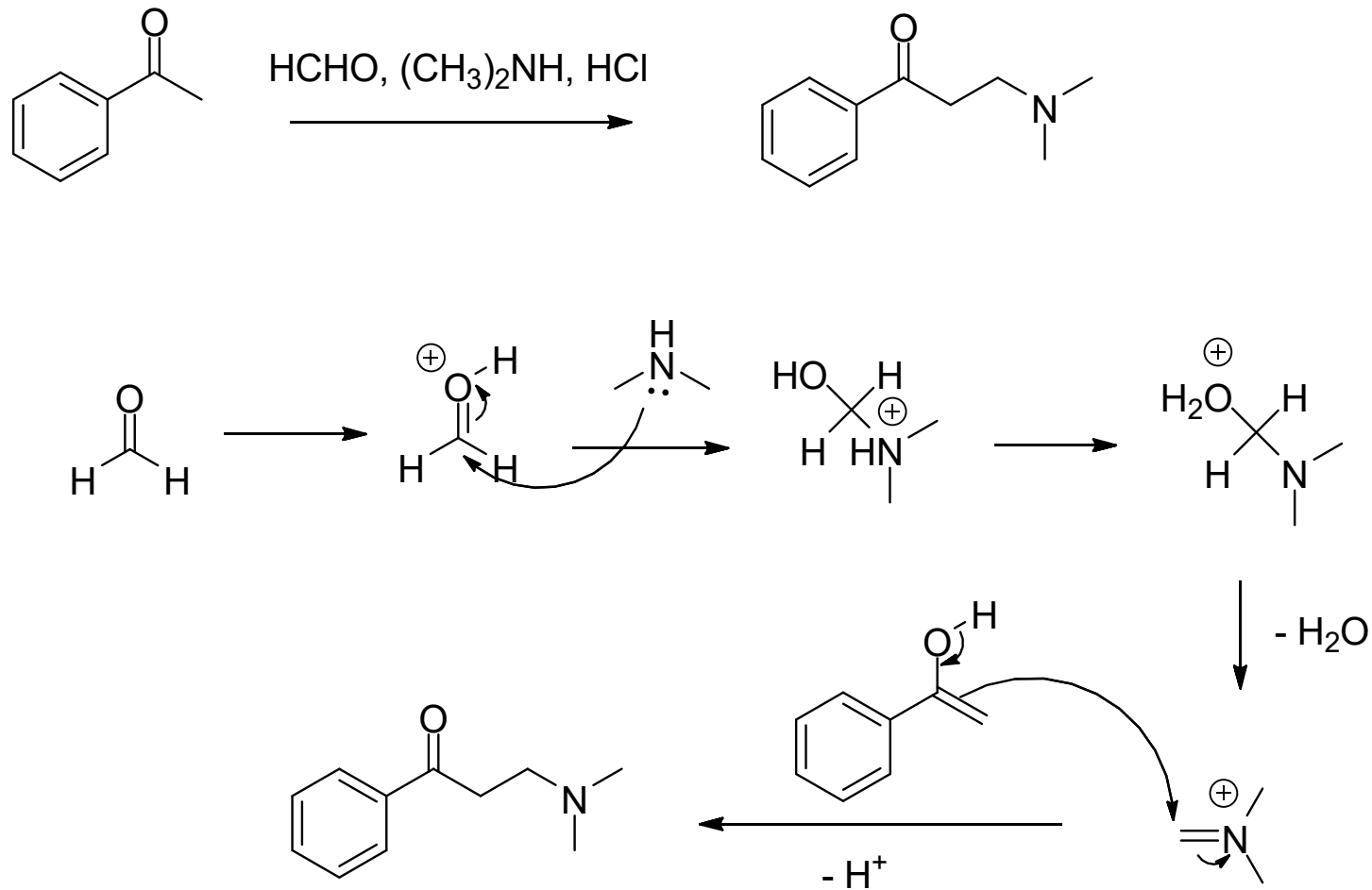

Identifikujte reagenty, které poskytly následující sloučeninu

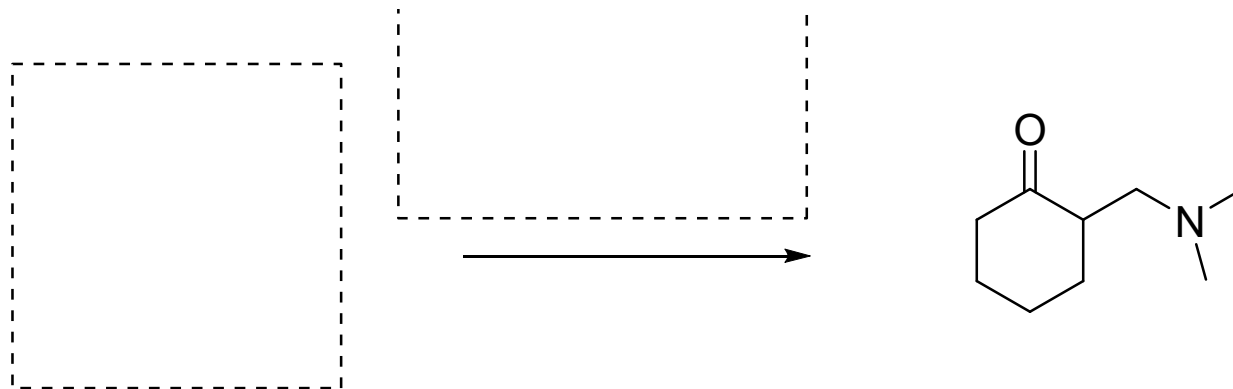

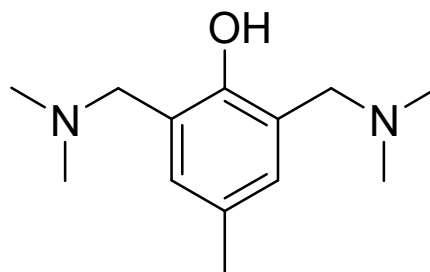
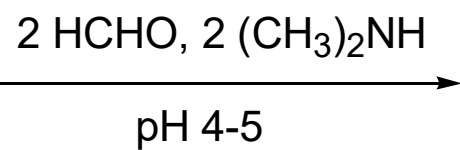
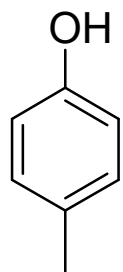

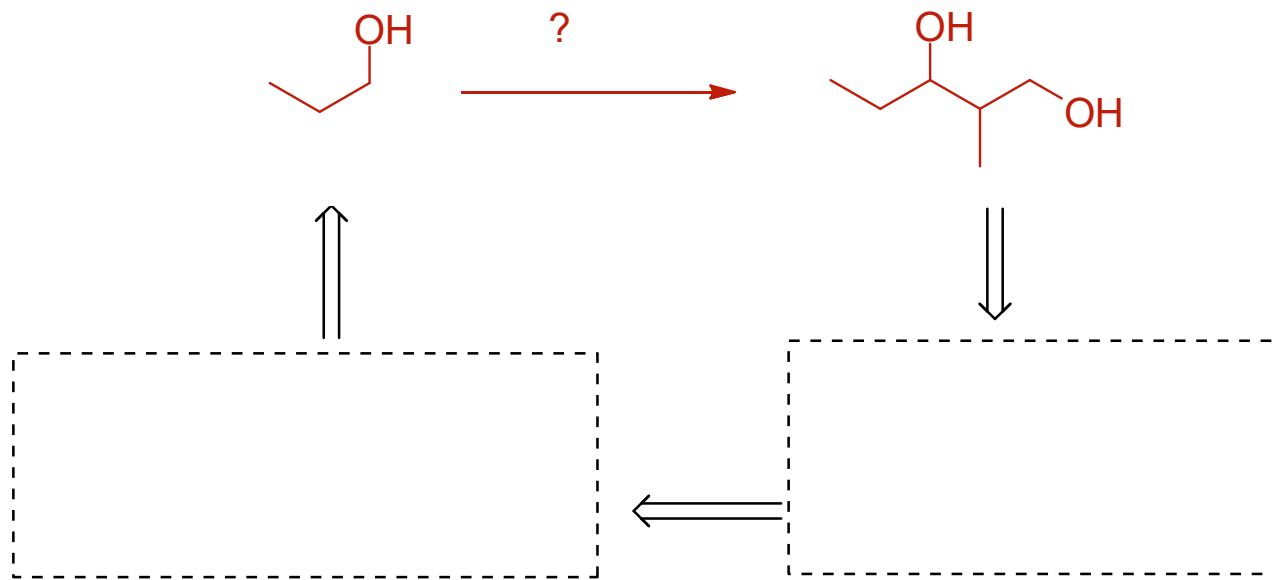

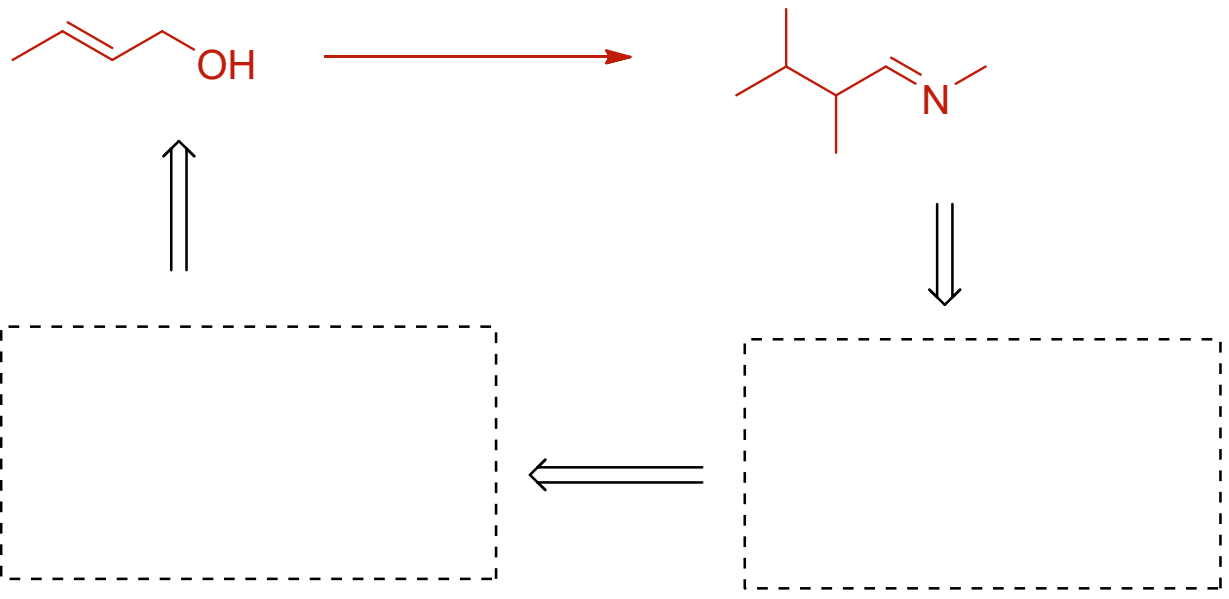

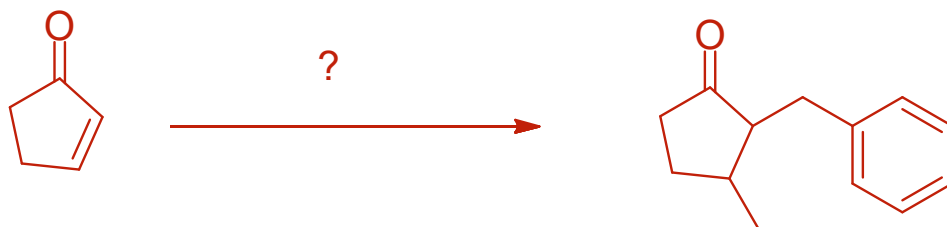

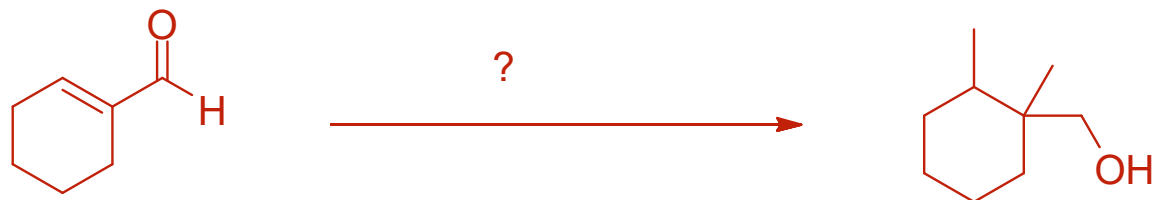

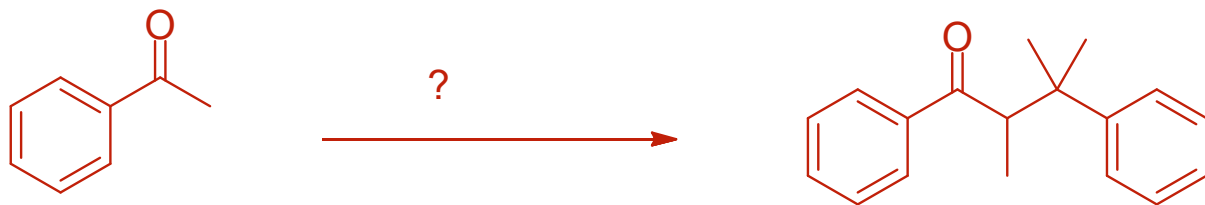

Identifikujte reagenty, které poskytly následující sloučeninu

Robinsonova anelace

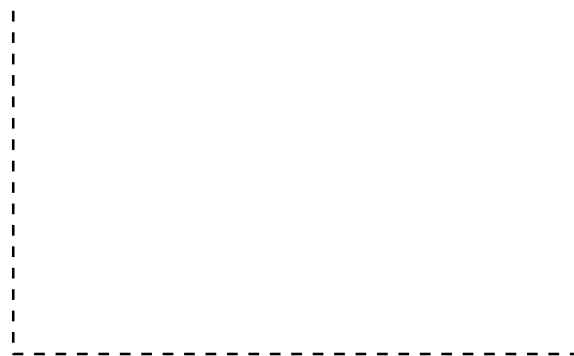
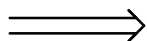
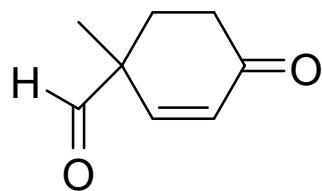

Identifikujte reagenty, které poskytly následující sloučeninu

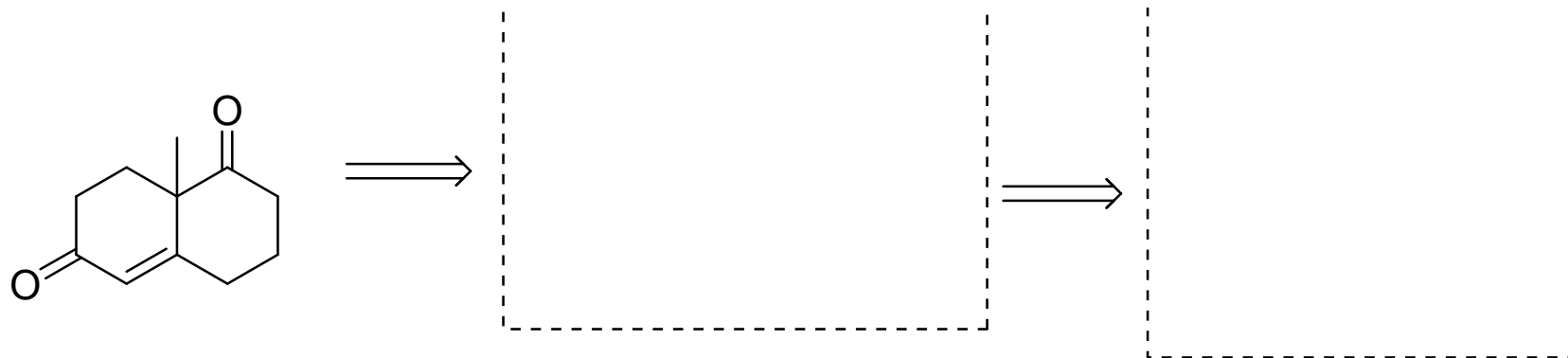

Robinsonova anelace

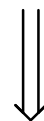
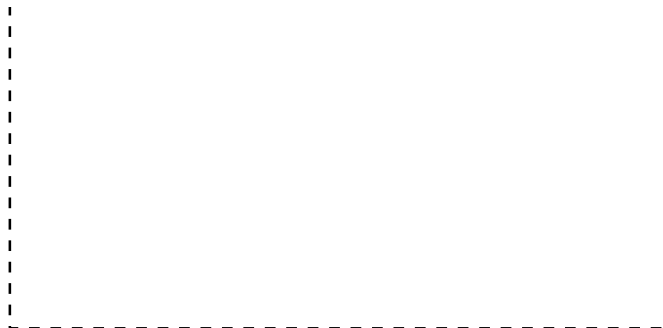
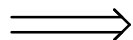
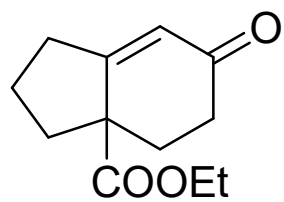

Robinsonova anelace

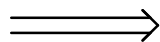
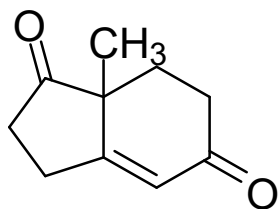

Robinsonova anelace

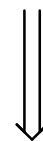
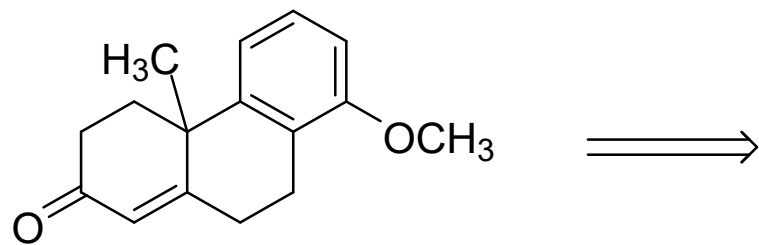

Identifikujte reagenty, které poskytly následující sloučeninu

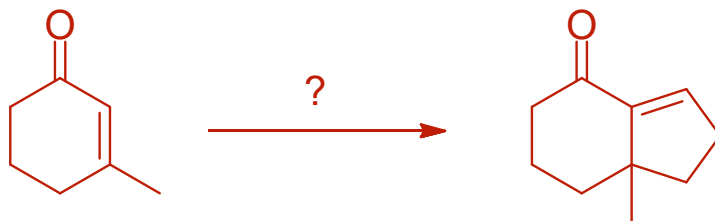

Malonesterová syntéza

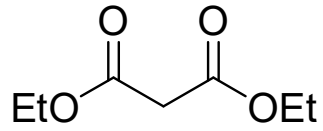

1) EtONa, EtOH

2) EtBr

3) H₃O⁺, ΔT



produkt

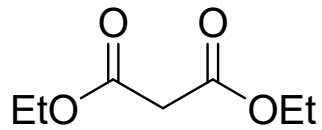

EtONa, EtOH



EtBr



H₃O⁺

tautomer

- CO₂

produkt



Využití malonesterové syntézy

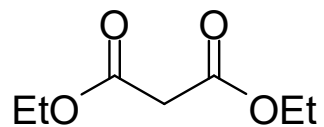

EtONa, EtOH



Ph-CH₂-Br



EtONa, EtOH



CH₃Br



H₃O⁺, ΔT

- CO₂



S využitím malonesterové syntézy naplánujte přípravu uvedených sloučenin

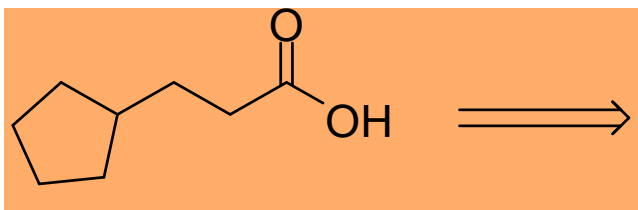

S využitím malonesterové syntézy naplánujte přípravu uvedených sloučenin

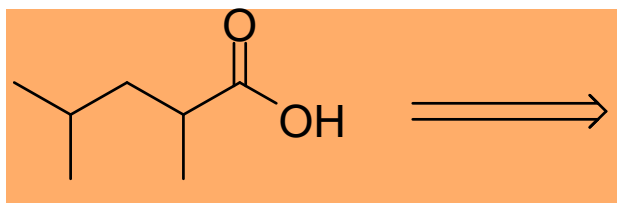

Acetocanová syntéza

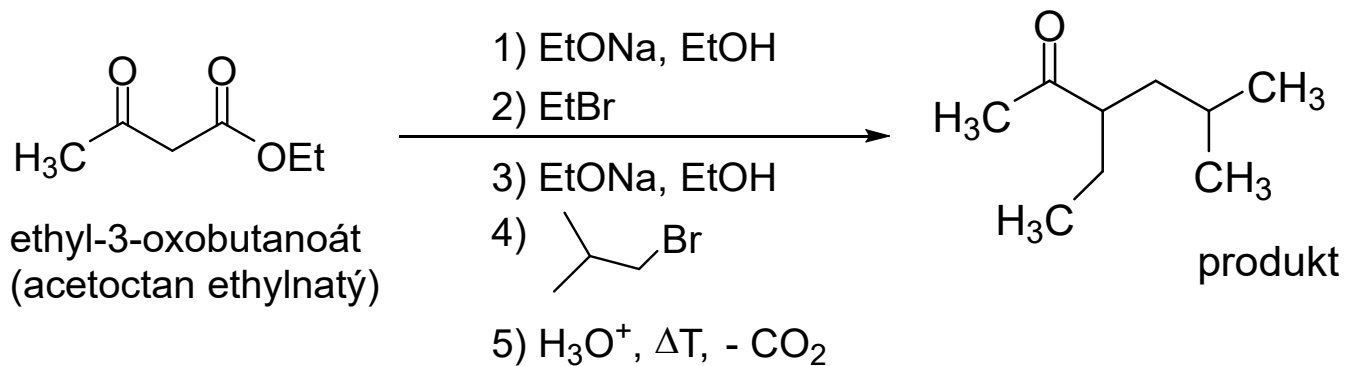

Acetocetanová syntéza dílní kroky

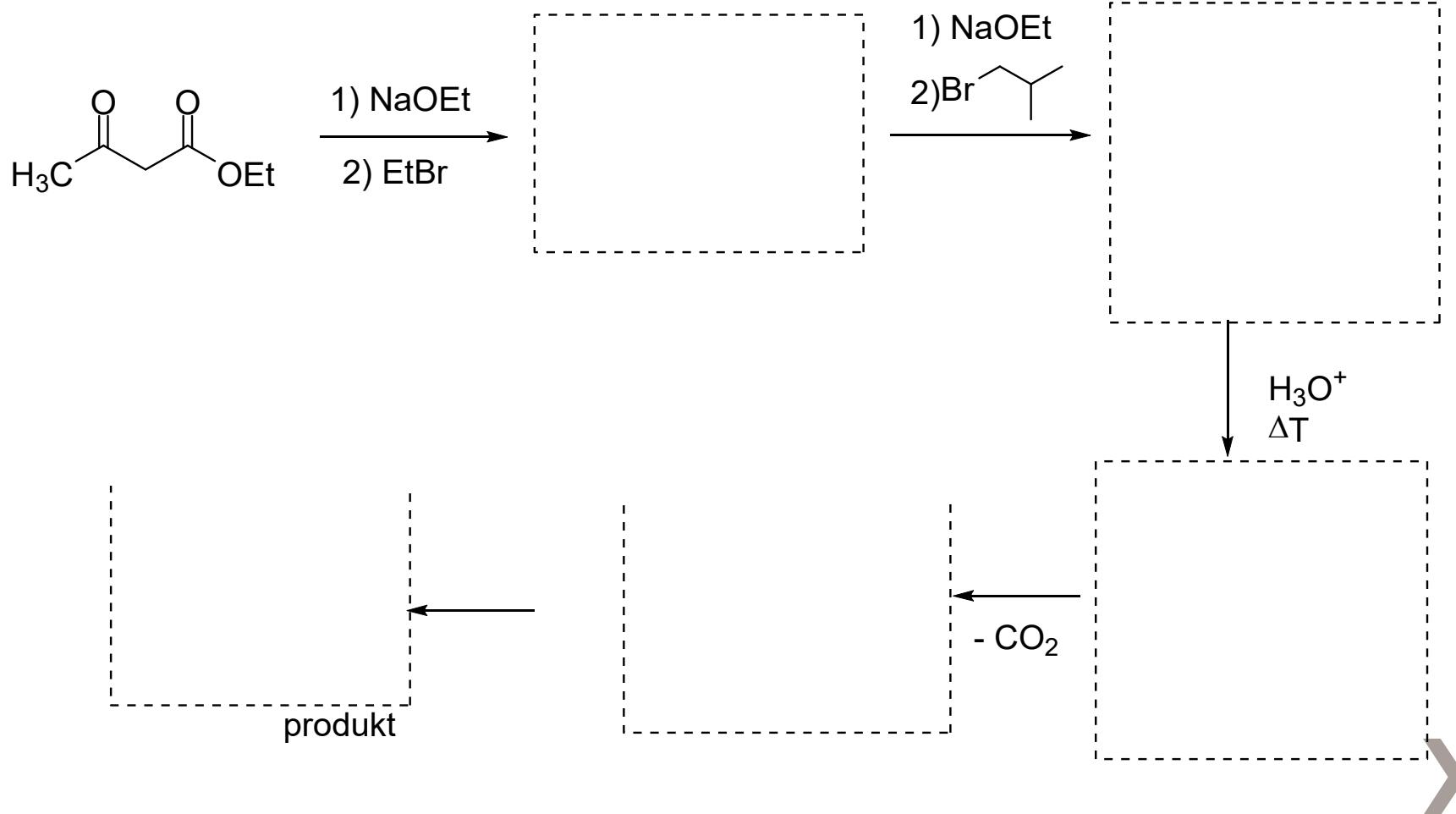

Acetocetanová syntéza

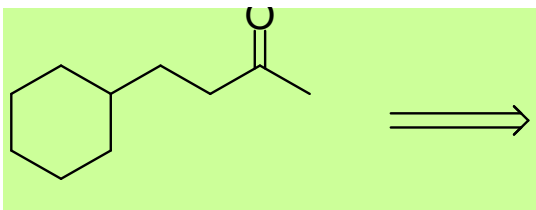

Acetoctanová syntéza

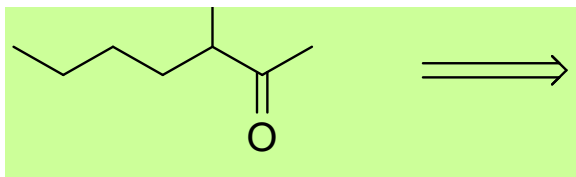

Acetocetanová syntéza

