

Direct Reactions of Solids

"HEAT-AND-BEAT" or "SHAKE-AND-BAKE"

Solid state reactions

At least one of the reactants and one of the products are *solid*

Reactions in a lattice of atoms

Atomic mobility

No mobility without defects – perfect crystal = no chemistry

High temperatures

Reactions on the interphase between phases

Microstructure - crystallite size, shape, defects

Diffusion controls the reaction rate

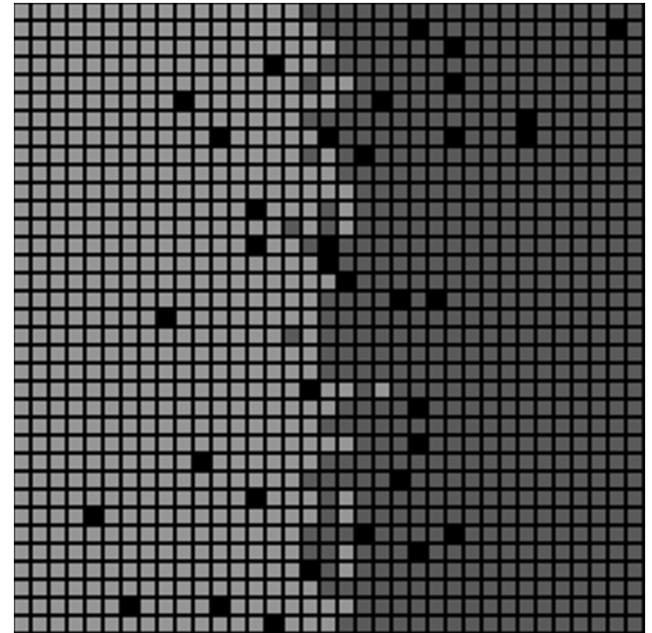

Reaction Types

Solid - solid synthesis - addition

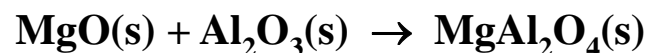

Solid - solid synthesis – exchange, metathesis

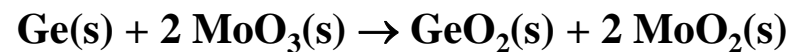
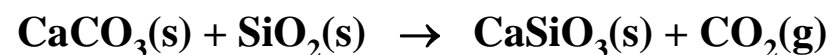
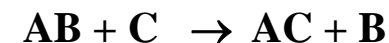

Solid - solid synthesis – exchange and addition

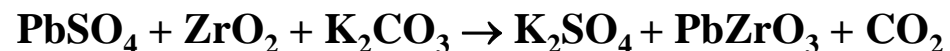

Solid - solid synthesis - dissociation

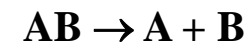

Reaction Types

Solid - solid synthesis - addition

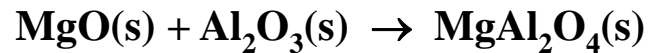
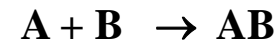

Solid - solid synthesis – exchange, metathesis

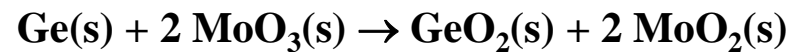
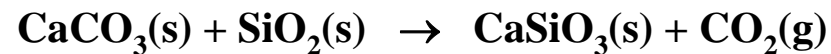
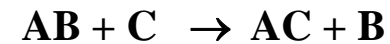

Solid - solid synthesis - dissociation

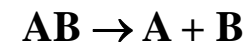

Reaction Types

Solid – gas synthesis **A + B → AB**

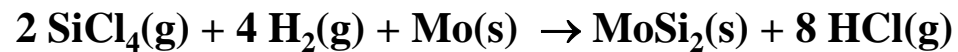
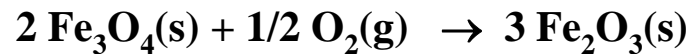

High temperature corrosion of metals in air

Solid – gas dissociation **AB → A + B**



Reaction Types

Other Examples

Oxides



873 K



dust = radiological hazard, milling, sintering to UO_2 pellets

YBCO 123 Superconductor (1987)

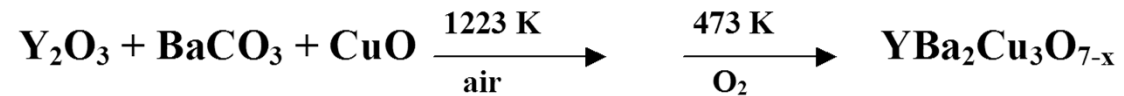

1130 K



Reaction Types

Other classes than oxides

Pnictides



Metals



Reaction Types

Chlorides

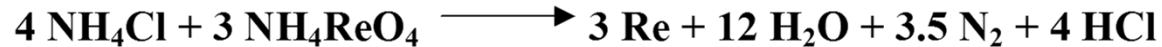
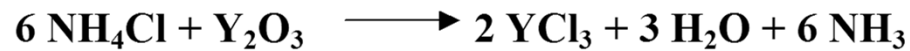
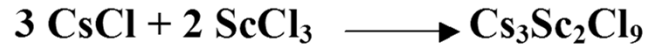

Aluminosilicates

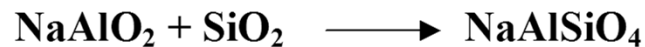

Chalcogenides

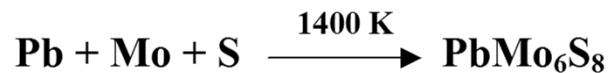

Chevrel phases

($\text{M}_x\text{Mo}_6\text{X}_8$, $\text{M} = \text{RE}, \text{Sn}, \text{Pb}, \text{Cu}$,
 $\text{X} = \text{S}, \text{Se}, \text{Te}$)

Experimental Considerations

Powder Mixing Method

Precise weighing for exact stoichiometry

Mixing (components, dopants, additives)

Milling or grinding (ball mill, mortar)

Compaction (pelleting, organic binders)

Calcination @ high temperature (> 1000 °C)

Firing/grinding cycles

Milling

Planetary ball mill

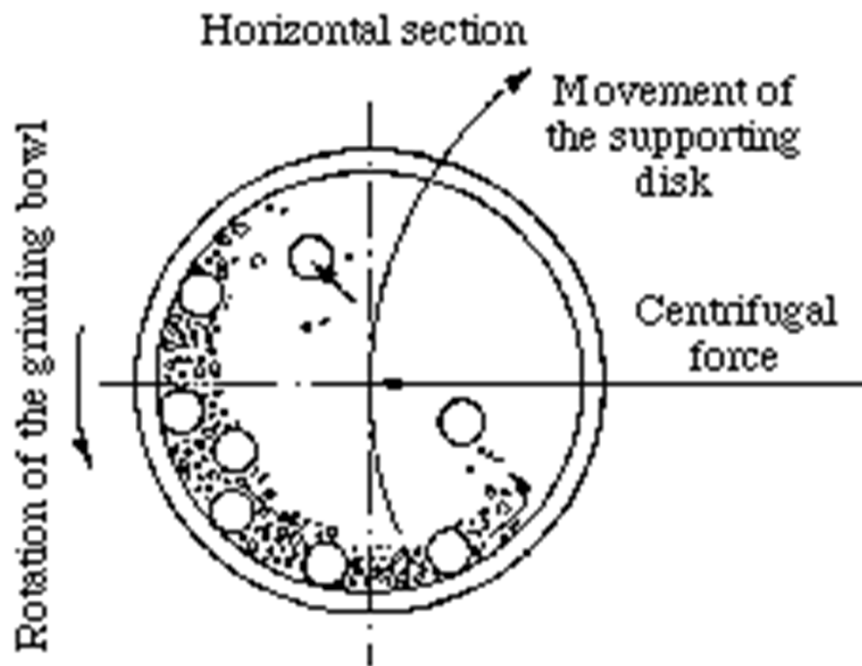

Rotation speed: up to 400 rpm
Milling jars: alumina, YSZ, tungsten carbide, agate

Planetary ball mill

Rotation and counter-wise spinning



Milling

Atritor mill

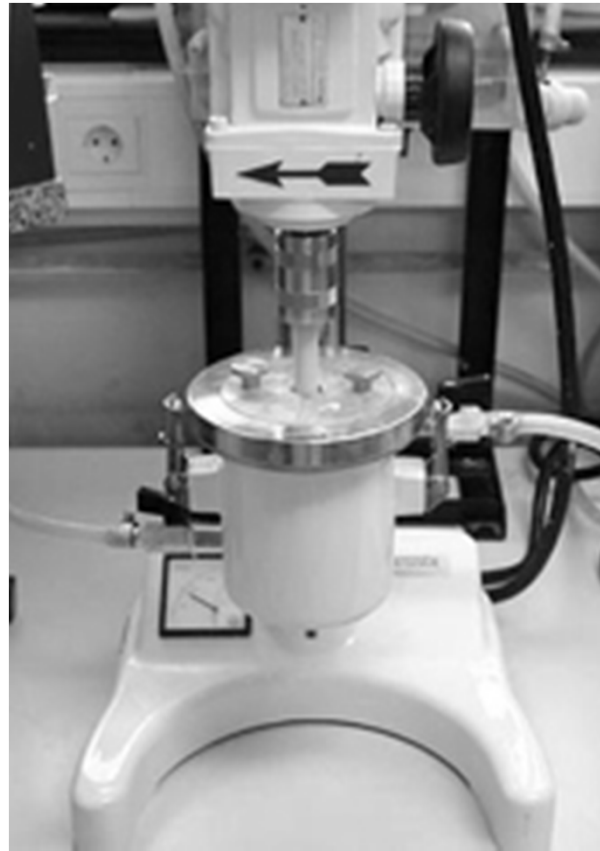

Compaction - Pressing



Hydraulic Uniaxial Press
Maximum pressure: 120 MPa



Warm Isostatic Press
Max. pressure: 400 MPa
Max. temperature: 80 °C
Volume: 2,5 l



Hot press
Max. temperature: 1250 °C
Max. pressure: 100 MPa
Max. diameter: 25 mm

Calcination



Tube Furnace

in air and in controlled atmosphere

Maximum temperature: 1450 °C or 1600 °C

Furnace-tube diameter: up to 75 mm



Vacuum Furnace

in vacuum or Ar, N₂, O₂ atmosphere

Maximum temperature: 1200 °C

Chamber Dimensions: 150x200x250 mm³

Direct Reactions of Solids

Advantages

- simple equipment
- low cost and easily accessible starting materials
- well studied

Disadvantages

- impurities from grinding (Fe, Cr, ...)
- broad particle size distribution
- some phases unstable @ high T, decomposition
- formation of undesirable phases
- slow formation, diffusion, long reaction times
- large grain size
- poor chemical homogeneity:
 - poor mixing of large crystallites
(milling lower limit ~ 100 nm)
 - volatility of some components (Na₂O, PbO, ...)
 - uptake of ambient gas (O₂ in superconductors)

Experimental Considerations

Reagents

Drying, fine grain powders for maximum SA, surface activation ($\text{Mo} + \text{H}_2$), in situ decomposition (CO_3^{2-} , OH^- , O_2^{2-} , $\text{C}_2\text{O}_4^{2-}$) for intimate mixing, precursor reagents, homogenization, organic solvents, grinding, ball milling, ultrasonication

Prior decomposition

Initial cycle at lower temperature to prevent spillage or volatilization, frequent cycles of heating, cooling, grinding, boost SA. Overcoming sintering, grain growth, fresh surfaces. Pelleting, hot pressing, enhanced contact area increases rate and extent of reaction

Container Materials

Chemically inert crucibles, boats, ampoules (open, sealed, welded)

Noble metals: Au, Ag, Pt, Ni, Rh, Ir, Nb, Ta, Mo, W

Refractories: alumina, zirconia, silica, BN, graphite

Reactivities with containers at high temperatures needs to be carefully evaluated for each system, pelleting minimizes contact with container, sacrificial pellet

Properties of Common Container Materials

Material	Maximum Working Temp., K	Thermal Shock Resistance	Thermal Conductivity, $W\ m^{-1}\ K^{-1}$	Coefficient of Linear Expansion $\times 10^6, K^{-1}$	Other Properties
Pyrex	770	GOOD	1.13	3.2	Permeable to air at high T
CaF ₂	1420	FAIR	-	24	-
SiO ₂	1530	VERY GOOD	1.38 - 2.67	0.4 - 0.6	Permeable to air at high T, devitrification above 1670 K
Si ₃ N ₄	1770	FAIR	10 - 33	6.4	-
Pt	1950	VERY GOOD	73	9.11	Plastic at high T
BN	1970	VERY GOOD	5.02	0.2-3	Oxidizes in air above 970 K
Vitreous C	2070	GOOD	4.19 - 8.37	2-3.5	Oxidizes in air above 900 K
Al ₂ O ₃	2170	FAIR	35 - 39	8	Reacts with metals above 1800 K
AlN	2270	FAIR	50 - 170	5.7	-
BeO	2570	GOOD	230	8.4	Reacts with metals above 1800 K
ZrO ₂	2570	GOOD	1.97	4.5	-
Ir	2600	VERY GOOD	148	6.8	-
MgO	2870	FAIR	37.7	25	High vapor pressure
ThO ₂	3070	FAIR	4.19	6	Reacts with C above 2290 K



Experimental Considerations

💣 Heating Program

Slow or fast heating, cooling, holding at a set point temperature. Furnaces, RF, microwave, lasers, ion or electron beam

Tammann's rule: $T_r > 2/3 T_m$

💣 Controlled atmosphere

oxidizing, reducing, inert or vacuum.

Unstable oxidation states, preferential component volatilization if T is too high, composition dependent atmosphere (O_2 , NH_3 , H_2S , ...)

Fuel and Oxidizer type	Temperature (Celsius)
Fluorescent light	60-80
Incandescent light	100-300
Cigarettes - unventilated conditions	288
Cigarettes - ventilated	400-780
Cigarettes - insulated and smoldering	510-621
Stove element	>550
Match	600-800
Tungsten halogen light	600-900
Candle flame	600-1,400
Electrical spark	1,316
Bunsen burner	1,570
Methanol/air	1,910
Methane/air	1,920-1,949
Butane/air	1,977
Propane/air	1,977
Wood/air (most organics are about here))	~1977
MAPP Gas/air	
Hydrogen/air	2,210
Carbon monoxide/air	2,468
Acetylene/air	2,632
Acetylene/Oxygen	3,300
Hydrogen/Oxygen	
Electrical arcing	<3,750
Plasma torch	~4,700
Lightning	30,000

Factors Influencing Direct Reactions of Solids

CONTACT AREA

- ★ Surface area of reactants
- ★ Particle size
- ★ Pelleting, pressing, precursors

DIFFUSION RATE

- ★ Diffusion rates of atoms, ions, molecules in solids
- ★ Reaction temperature, pressure, atmosphere
- ★ Diffusion length, particle size
- ★ Defect concentration, defect type
- ★ Reaction mechanism

NUCLEATION RATE

- ★ Nucleation of product phase within the reactant with similar crystal structure
- ★ Epitactic and topotactic reactions
- ★ Surface structure and reactivity of different crystal planes/faces

Direct Reactions of Solids

KEY FACTORS IN SOLID STATE SYNTHESIS

CONTACT AREA and surface area (SA) of reacting solids control:

→ Rates of diffusion of ions through various phases, reactants and products

→ Rate of nucleation of the product phase

Reaction rate is greatly influenced by the SA of precursors as contact area depends roughly on SA of the particles

Surface Area (SA) of Precursors

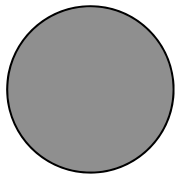

spherical particles, radius r [nm], density ρ [g/cm³]

$$SA = A/m = \frac{4\pi r^2}{\frac{4}{3}\pi r^3 \cdot \rho} = 3000/r\rho \quad [m^2/g]$$

Direct Reactions of Solids

Consider 1 g of a material, density 1.0 g/cm^3 , cubic crystallites

number of cubes	edge length	SA, m^2/g
1	1 cm	$6 \cdot 10^{-4}$
10^3	1 mm	$6 \cdot 10^{-3}$
10^{12}	1 μm	6
10^{21}	1 nm	6000

Silica

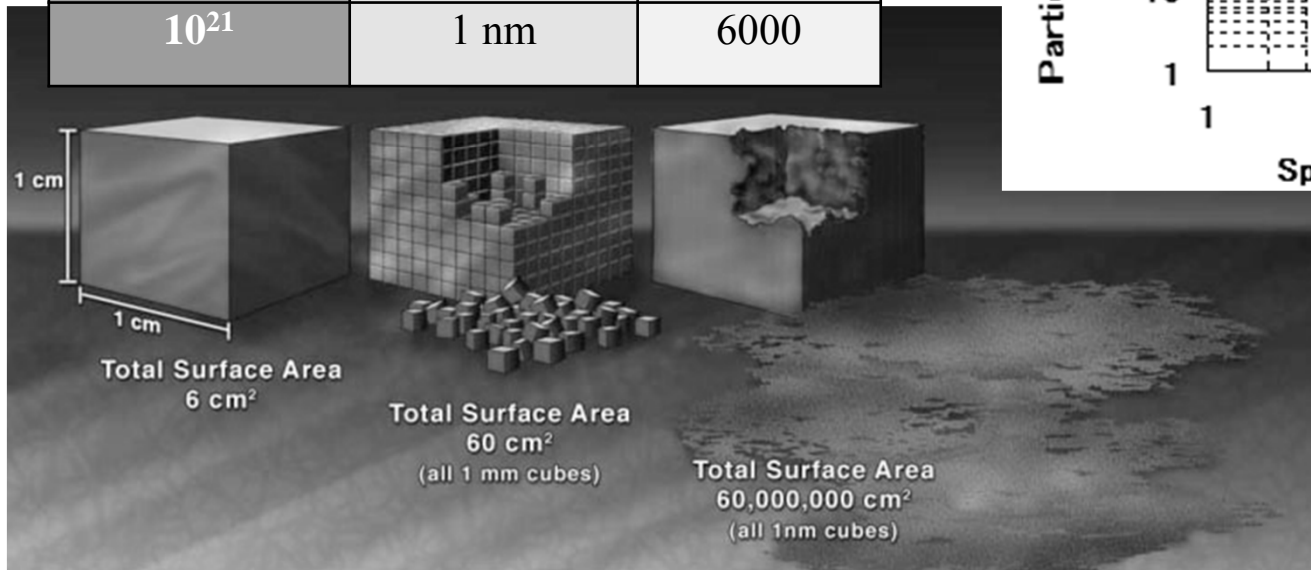
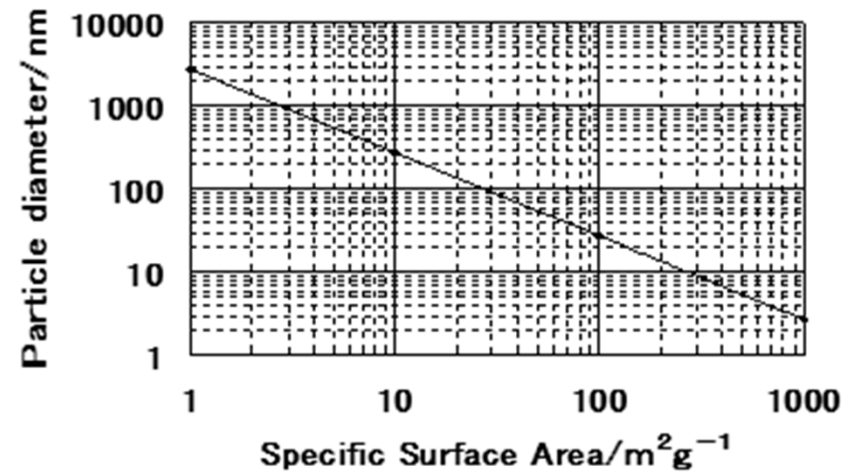

Direct Reactions of Solids

Contact area
not in reaction rate expression
for product layer thickness, x ,
versus time:

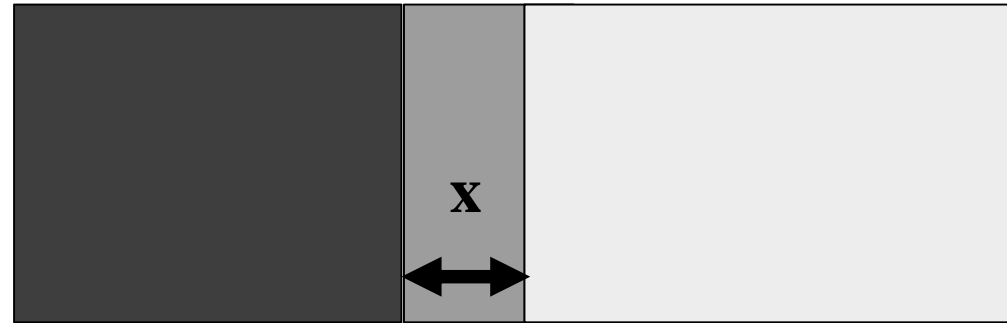

$$\frac{dx}{dt} = k/x$$

But for a constant product volume ($V = x A$): $x \sim 1/A_{\text{contact}}$

and furthermore $A_{\text{contact}} \sim 1/d_{\text{particle}}$

Thus particle sizes and surface area inextricably connected and obviously

$$x \sim d$$

and SA particle size affect the interfacial thickness

Direct Reactions of Solids

These relations suggest some strategies for rate enhancement in direct reactions:

→ Hot pressing densification of particles

High pressure squeezing of reactive powders into pellets (700 atm)
Pressed pellets still 20-40% porous. Hot pressing improves densification

→ Atomic mixing in composite precursor compounds

→ Coated particle mixed component reagents, corona/core precursors

→ Decreasing particle size, nanocrystalline precursors

Aimed to increase interfacial reaction area A and decrease interface thickness x , minimizes diffusion length scales

$$dx/dt = k/x = k'A = k''/d$$

Direct Reactions of Solids

DIFFUSION RATE

Fick's law $J = -D(dc/dx)$

J = flux of diffusing species, $\#/cm^2s$

(dc/dx) = concentration gradient, $\#/cm^4$

D = diffusion coefficient, cm^2/s , for good reaction rates $> 10^{-12}$

$$D = D_{\infty} \exp\left(-\frac{Q}{RT}\right)$$

D increases with temperature, rapidly as you approach the melting point

Tammann's rule: Extensive reaction will not occur until the temperature reaches at least 2/3 of the melting point of one or more of the reactants.

Factors influencing cation diffusion rates:

→ Charge, mass and temperature

→ Interstitial versus substitutional diffusion

→ Number and types of defects in reactant and product phases

All types of defects enhance diffusion of ions

(intrinsic or extrinsic, vacancies, interstitials, lines, planes, dislocations, grain boundaries)

Reaction Paths between Two Solids

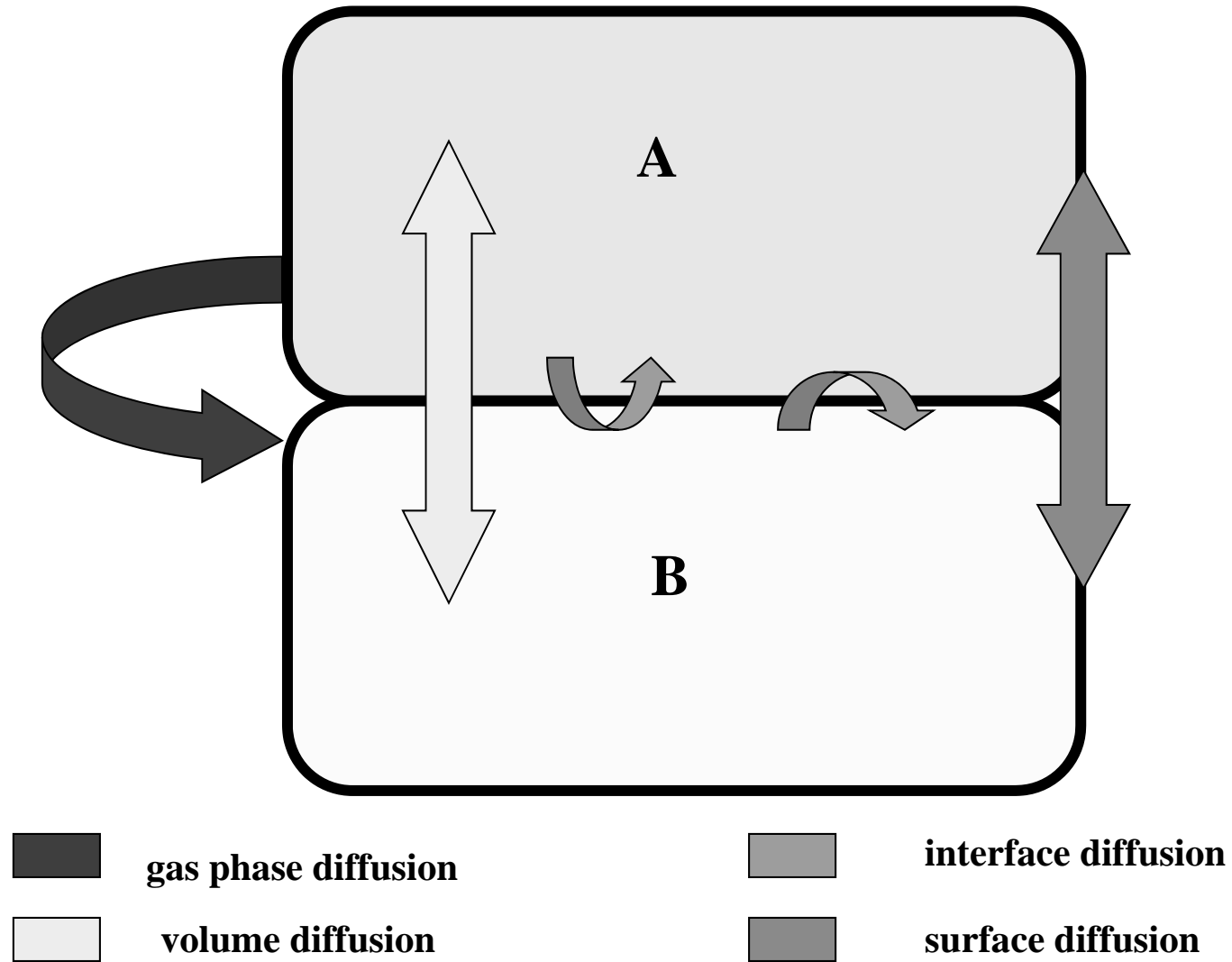

Direct Reactions of Solids

$(A)_x[B_y]O_z$ Stoichiometric formula of spinel

(A) occupy $1/8 T_d$

[B] occupy $1/2 O_h$

ccp array of O^{2-}

Derive the stoichiometric formula of spinel



The Spinel Structure: $(A)[B_2]O_4$

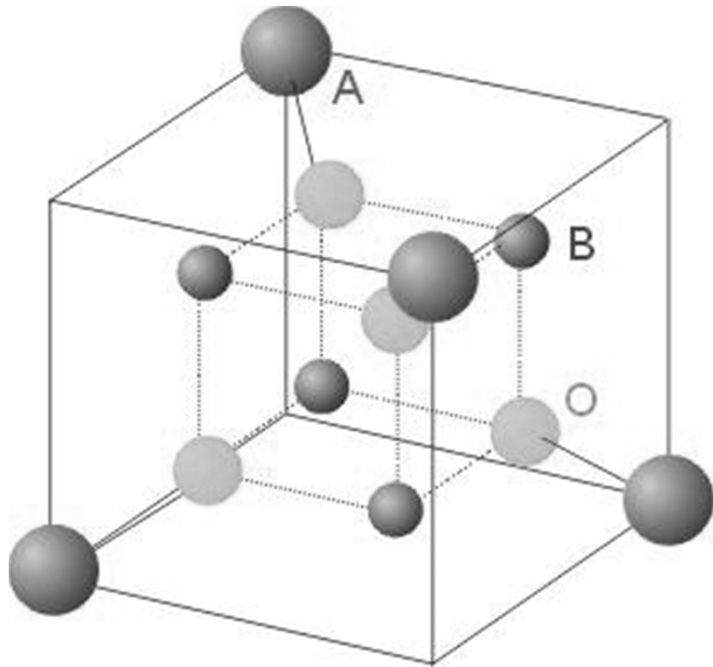

fcc array of O^{2-} ions, A occupies 1/8 of the tetrahedral and B 1/2 of the octahedral holes

→ normal spinel: AB_2O_4

Co_3O_4 , $GeNi_2O_4$, WNa_2O_4

→ inverse spinel: $B[AB]O_4$

Fe_3O_4 : $Fe^{3+}[Fe^{2+}Fe^{3+}]O_4$, $TiMg_2O_4$, $NiLi_2F_4$

→ basis structure for several magnetic materials

The Spinel Structure: MgAl_2O_4

(A)[B_2] O_4

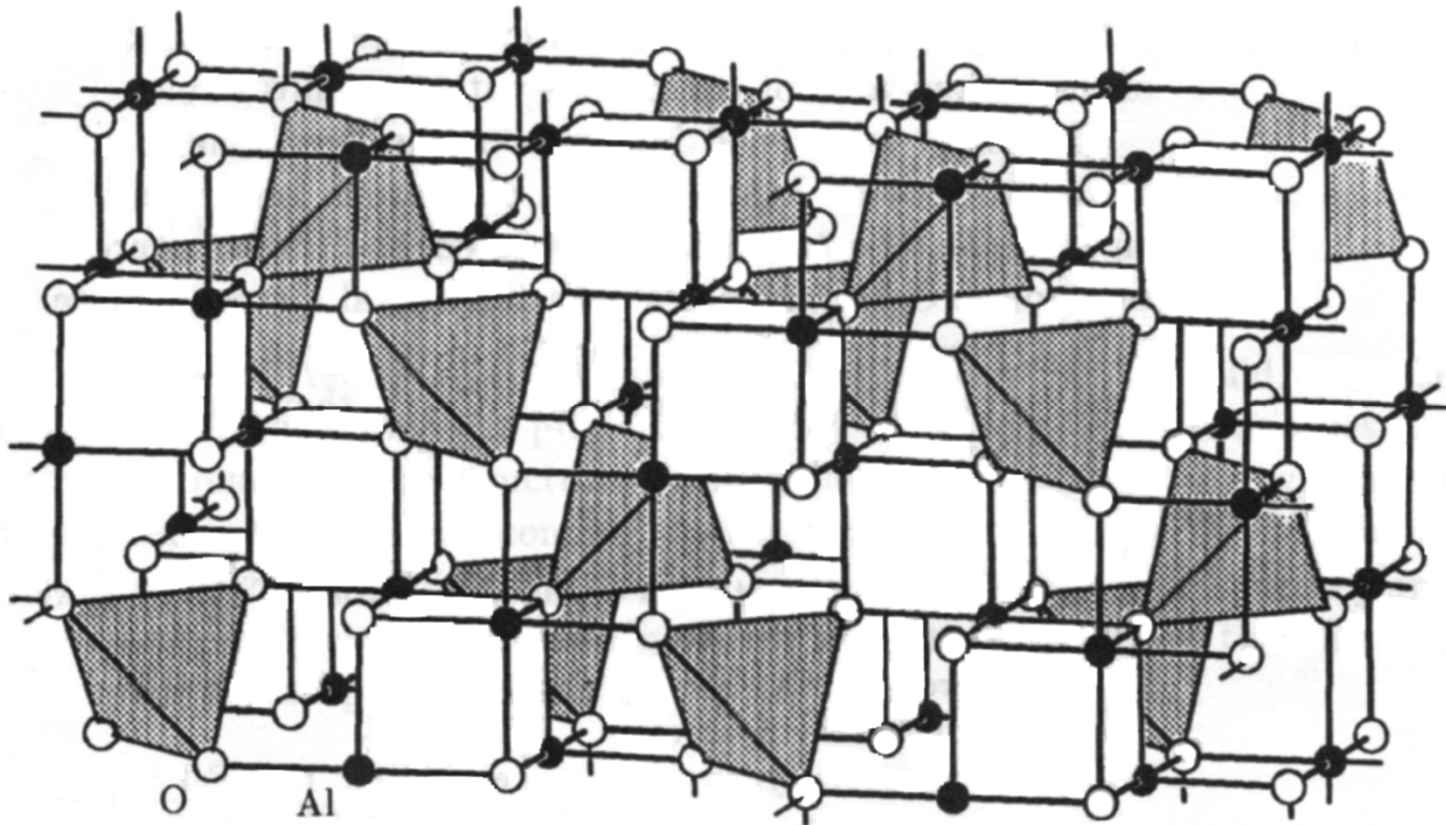

The Spinel Structure: MgAl_2O_4



I

II

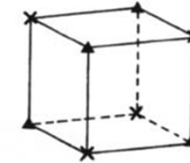
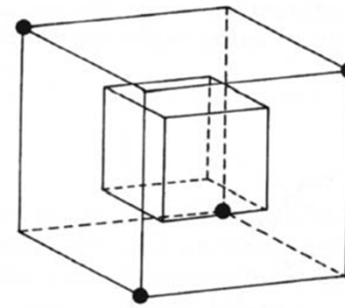
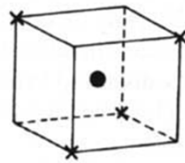
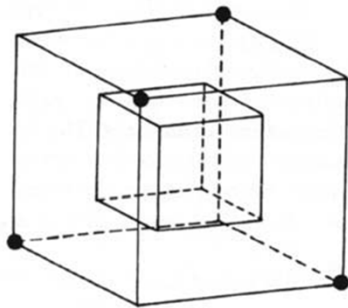

I

II

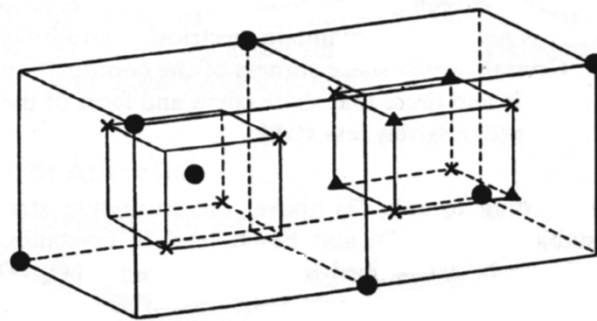
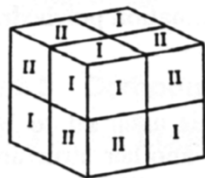

• = Mg

x = O

▲ = Al

Direct Reactions of Solids

Model reaction, well studied:

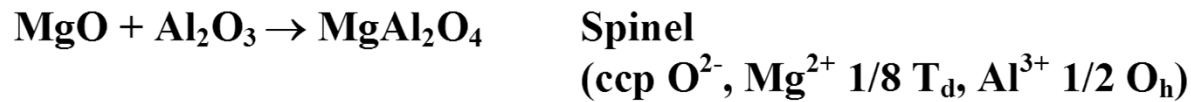

Single crystals of precursors, interfaces between reactant grains

On reaction, new reactant-product $\text{MgO}/\text{MgAl}_2\text{O}_4$ and $\text{Al}_2\text{O}_3/\text{MgAl}_2\text{O}_4$ interfaces are formed

Free energy negative, favors reaction but extremely slow at normal temperatures (several days at 1500 °C)

Interfacial growth rates 3 : 1



Linear dependence of interface thickness x^2 versus t

Easily monitored rates with colored product at interface, T and t

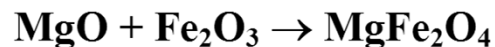
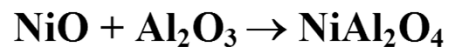

Direct Reactions of Solids

Model for a classical solid-solid reaction (below melting point !):
Planar interface between two crystals



Phase 1:
nucleation

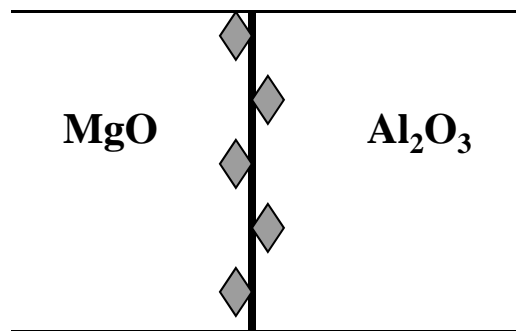

Phase 2:
growth of nuclei

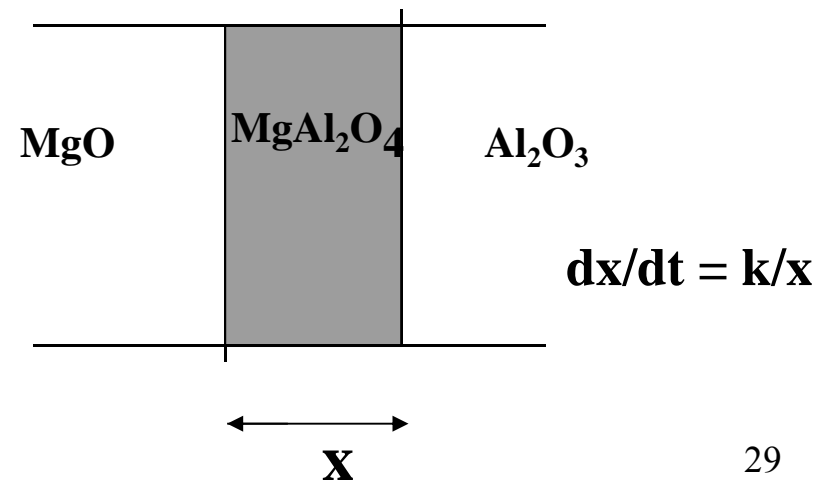

Direct Reactions of Solids

☛ Structural differences between reactants and products, major structural reorganization in forming product spinel

MgO ccp O²⁻, Mg²⁺ in O_h sites

Al₂O₃ hcp O²⁻, Al³⁺ in 2/3 O_h sites

MgAl₂O₄ ccp O²⁻, Mg²⁺ 1/8 T_d, Al³⁺ 1/2 O_h

☛ Making and breaking many strong bonds (mainly ionic), high temperature process as D(Mg²⁺) and D(Al³⁺) large for small highly charged cations

☛ Long range counter-diffusion of Mg²⁺ and Al³⁺ cations across interface, usually RDS (= rate determining step), requires ionic conductivity, substitutional or interstitial hopping of cations from site to site to effect mass transport

☛ Nucleation of product spinel at interface, ions diffuse across thickening interface, oxide ion reorganization at nucleation site

☛ Decreasing rate as spinel product layer thickens

Parabolic rate law: $dx/dt = k/x$

$$x^2 = kt$$

Direct Reactions of Solids

Kinetics:

Linear x^2 vs. t plots observed

$\ln k$ vs. $1/T$ experiments provide Arrhenius activation energy E_a for the solid-state reaction

Reaction mechanism requires charge balance to be maintained in the solid state interfacial reaction:



MgO/MgAl₂O₄ Interface:



MgAl₂O₄/Al₂O₃ Interface:



Overall Reaction:

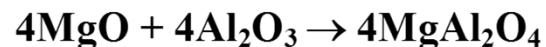

the Kirkendall Effect : RHS/LHS growth rate of interface = 3/1

Reaction Mechanism

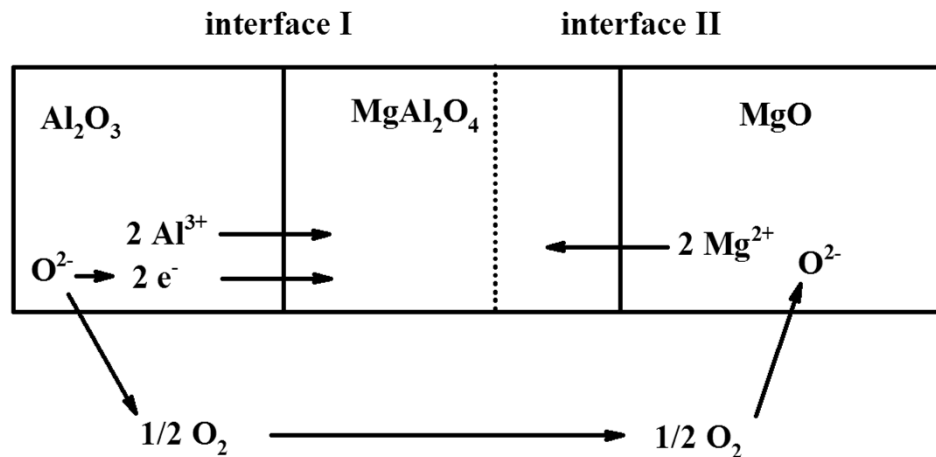
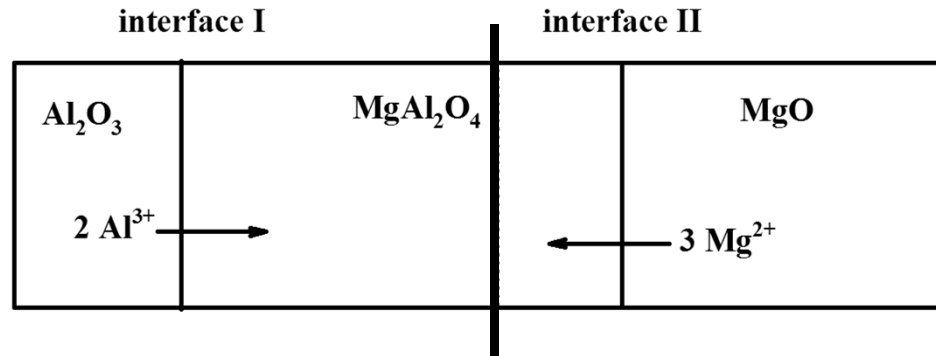

Direct Reactions of Solids

General kinetic expression

Reaction rate

Rate constant

Reaction order

$$\frac{d\alpha}{dt} = k(T)f(\alpha)$$

$$\int \frac{d\alpha}{f(\alpha)} = g(\alpha) = \int k(T)dt$$

α – the molar fraction of the reacted product at a time t

$k(T)$ – the rate constant of the process

Experimentally evaluate α at different t

Fit data into a $g(\alpha) = k(T) \times t$ expression to obtain $k(T)$ and the type of mechanism model

$$\alpha = \frac{P_t - P_0}{P_e - P_0}$$

P_t = the value of a property at time t

P_0 = the value of a property at the beginning

P_e = the value of a property at the end

$$\alpha = 0 - 1$$

e.g. P_t = mass loss, x ,

Direct Reactions of Solids

$$\frac{d\alpha}{dt} = k(T)f(\alpha)$$

$$\int \frac{d\alpha}{f(\alpha)} = \int k(T)dt$$

$$g(\alpha) = \int k(T) dt$$

$$g(\alpha) = k(T) t$$

Decreasing reaction rate as spinel product layer (x) thickens

Here $\alpha = x$

$$\alpha = \frac{P_t - P_0}{P_e - P_0}$$

Parabolic rate law:

$$\alpha = 0-1$$

$$dx/dt = k/x$$

$$x^2 = kt$$

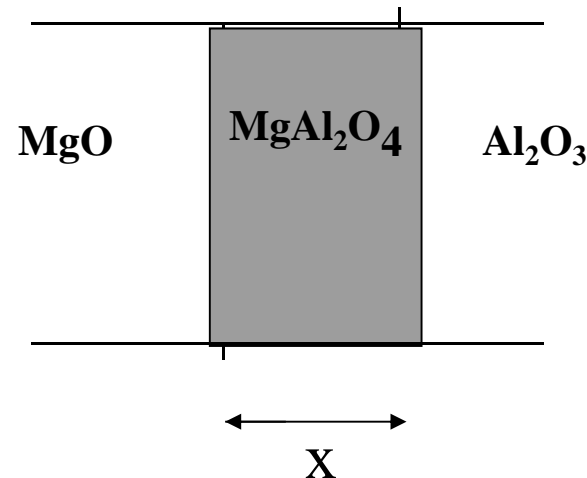

Mechanism model	$g(\alpha)$
Diffusion controlled	
One-dimensional	α^2
Two-dimensional	$\alpha + (1 - \alpha) \ln (1 - \alpha)$
Three-dimensional, Jander	$[1 - (1 - \alpha)^{1/3}]^{2/3}$
Three-dimensional, Ginstling	$(1 - 2/3\alpha) - (1 - \alpha)^{2/3}$
Three-dimensional, Carter	$(1 + \alpha)^{2/3} + (1 - \alpha)^{2/3}$
Growth controlled	
General	$[1 - (1 - \alpha)^{1-n}]$
First order, $n = 1$	$[- \ln (1 - \alpha)]$
Nucleation controlled	
Power law	$\alpha^{1/n}$
Nucleation-Growth controlled	
Avrami	$[- \ln (1 - \alpha)]^{1/2}$
Erofeev	$[- \ln (1 - \alpha)]^{1/3}$
Planar boundary	$1 - (1 - \alpha)^{1/2}$
Spherical boundary	$1 - (1 - \alpha)^{1/3}$

$$g(\alpha) = \int k(T) dt$$

$$g(\alpha) = k(T) t$$

Avrami Plot

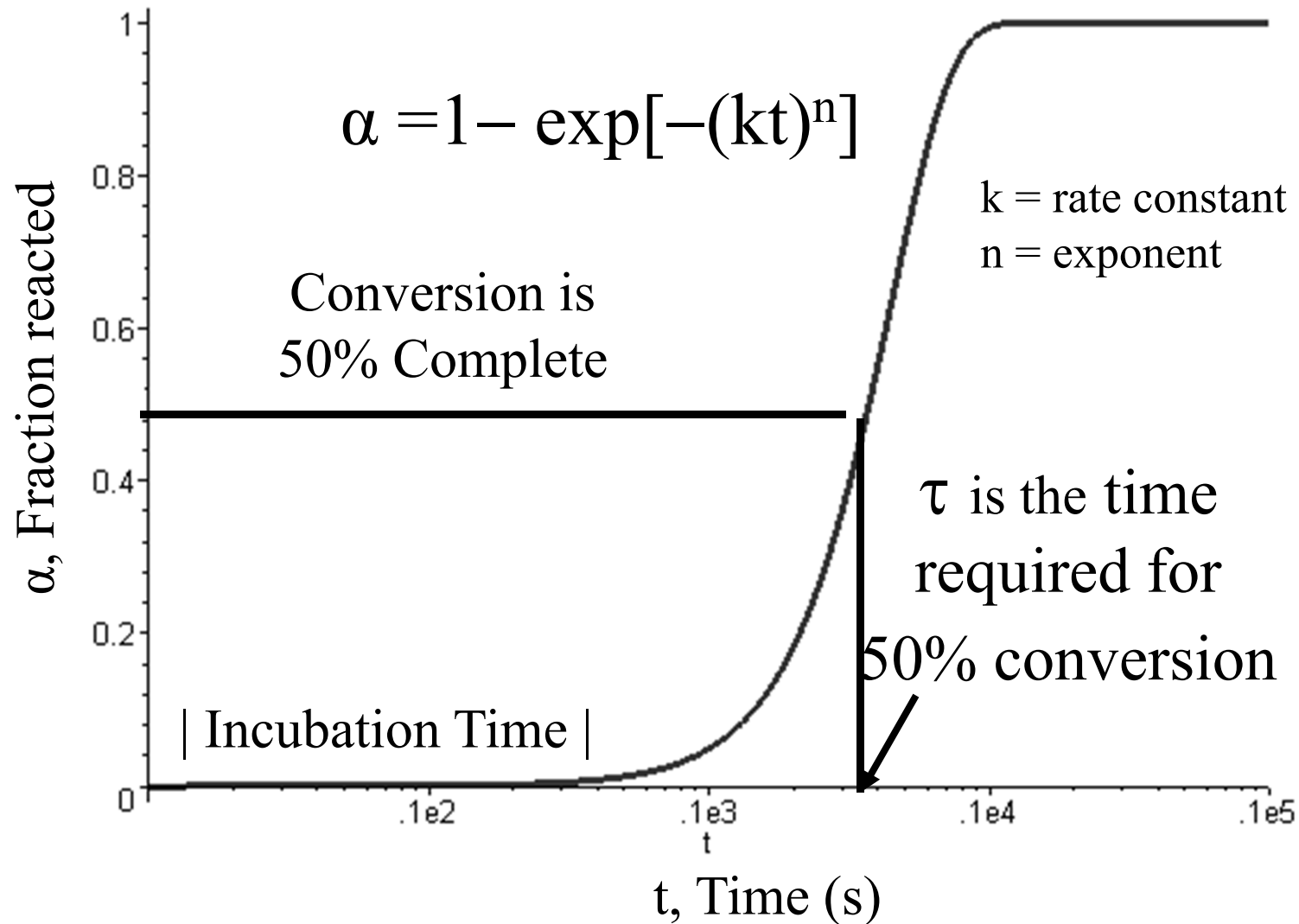

Direct Reactions of Solids

Perform the measurements in a range of temperatures T
use Arrhenius equation to evaluate the activation energy E_a

$$k(T) = k_0 \exp(-E_a/RT)$$

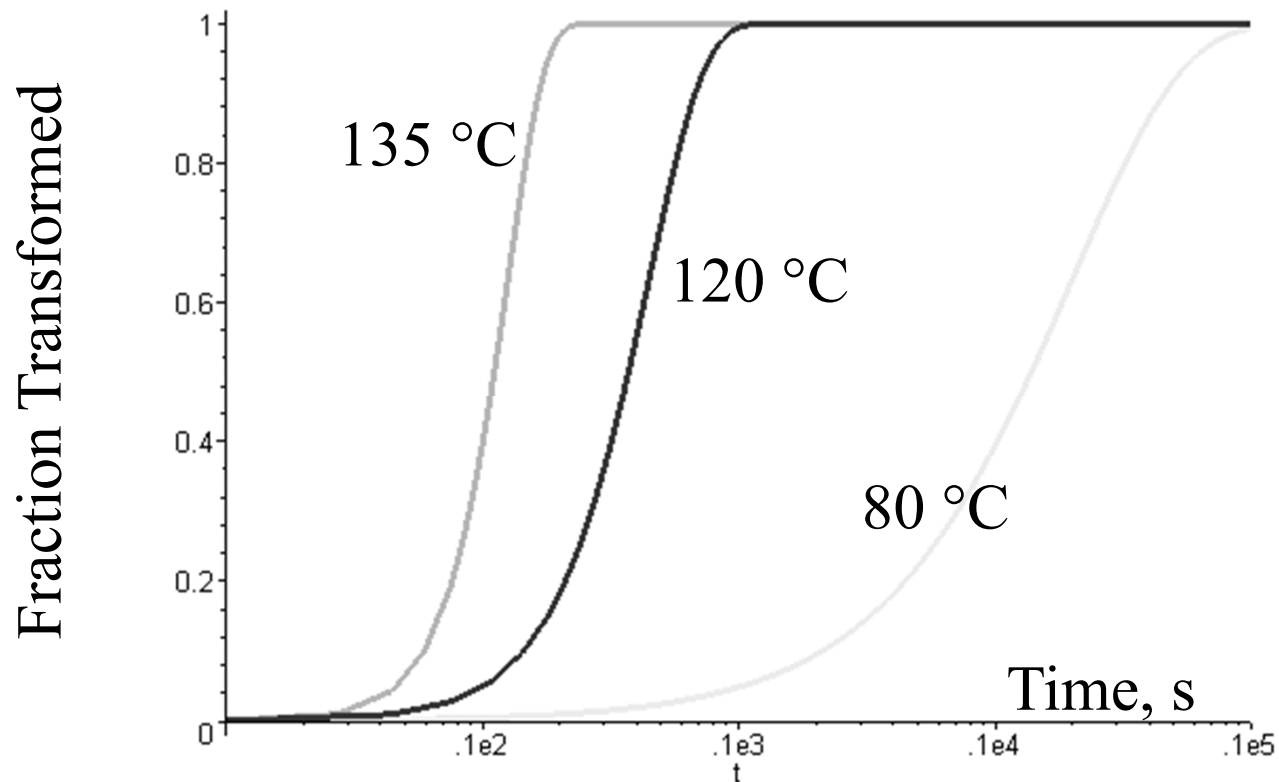

Cation Diffusion in LaCoO_3

Marker experiments

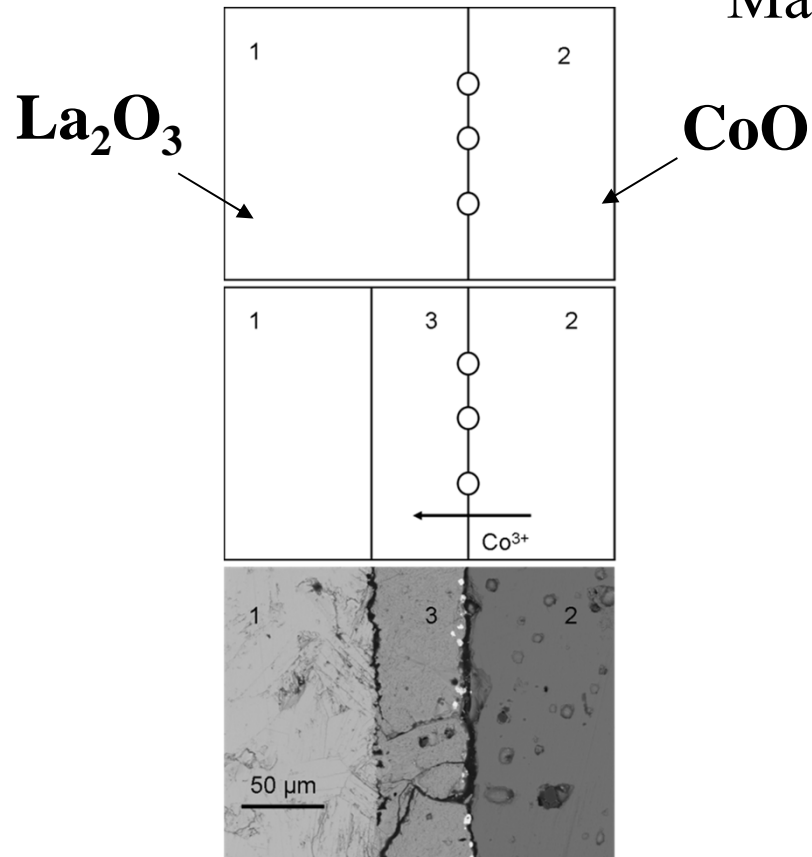

$$D_{\text{Co}} \gg D_{\text{La}}$$

Rate-determining step:

Diffusion of Co cations

LaCoO_3

Growth Kinetics of LaCoO₃

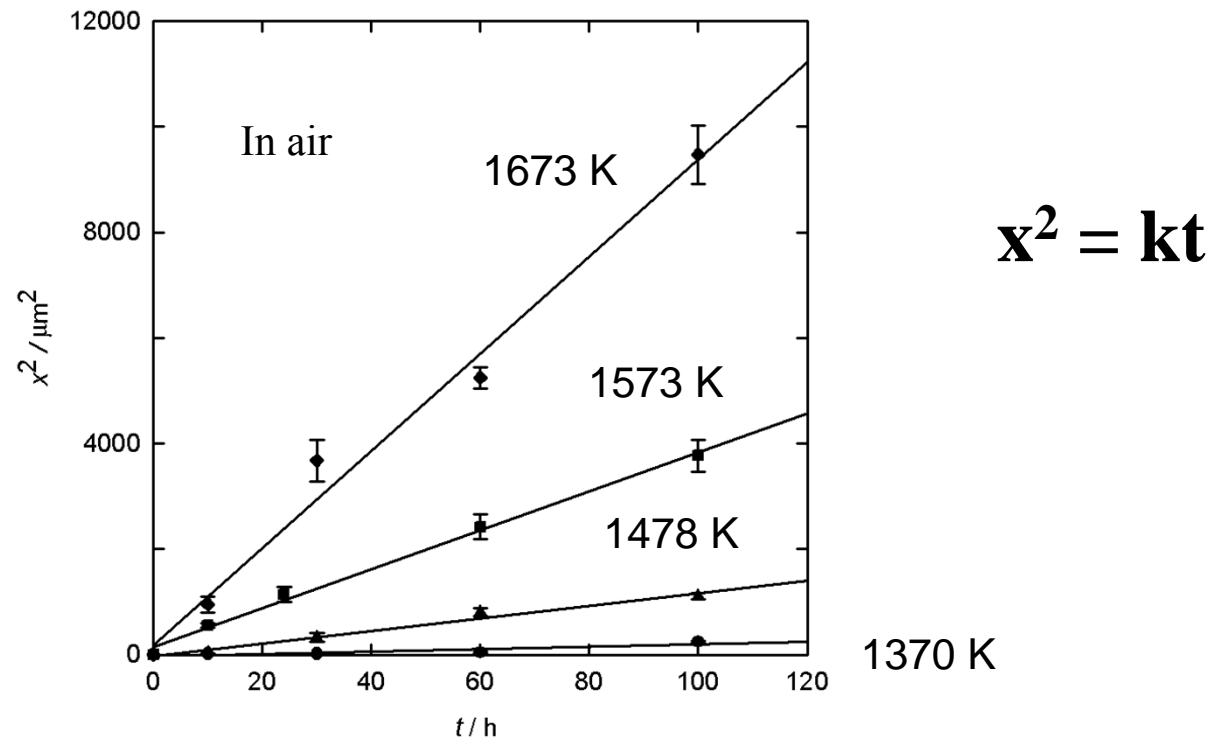

Parabolic rate law valid = diffusion controlled process

Growth Kinetics of LaCoO₃

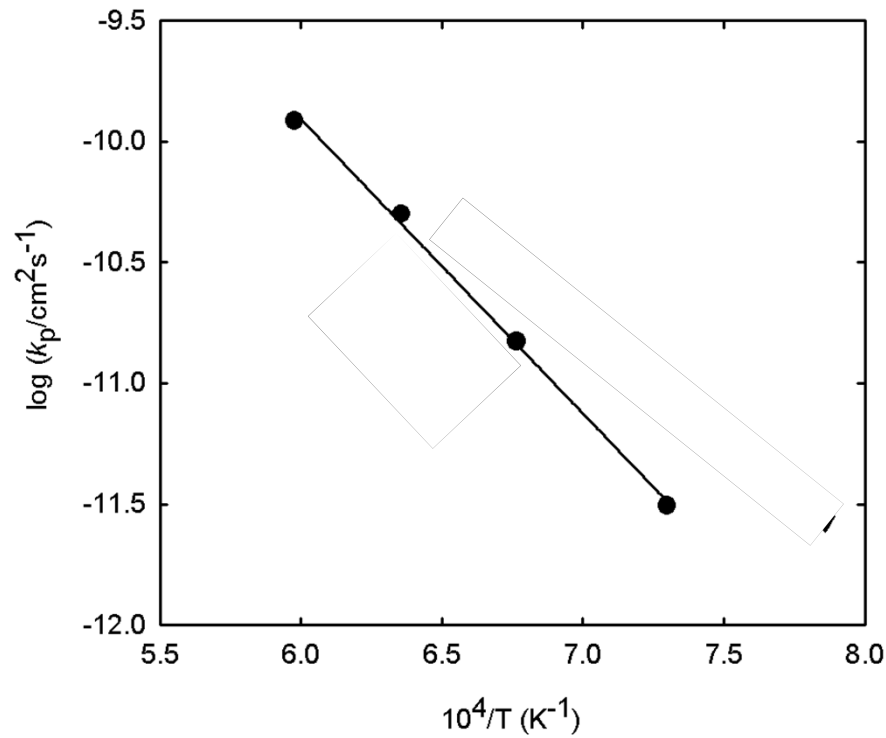

T/K	$k_p \text{ cm}^2\text{s}^{-1}$	$D \text{ cm}^2\text{s}^{-1b}$
1370	$(3.11 \pm 0.69) \times 10^{-12}$	3.02×10^{-12}
1478	$(1.49 \pm 0.14) \times 10^{-11}$	1.40×10^{-11}
1573	$(5.01 \pm 0.16) \times 10^{-11}$	4.55×10^{-11}
1673	$(1.22 \pm 0.22) \times 10^{-10}$	1.05×10^{-10}

$$k(T) = k_0 \exp(-E_a/RT)$$

$$\log k = \log k_0 - E_a/RT$$

$$E_A = (250 \pm 10) \text{ kJ mol}^{-1}$$

Nucleation

Homogeneous nucleation

Liquid melt to crystalline solid

Cluster formation

ΔG_v = driving force for solidification (negative)

below the equilibrium melting temperature, T_m

ΔT = undercooling, ΔH_v = enthalpy of solidification (negative)

$$\Delta G_v = \frac{\Delta H_v \Delta T}{T_m}$$

Small clusters of crystallized solid form in a melt because of the random motion of atoms within the liquid

Driving force is opposed by the increase in energy due to the creation of a new solid-liquid interface

γ_{SL} = the solid/liquid interfacial energy

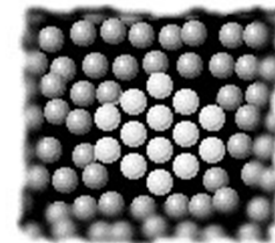

Nucleation

ΔG

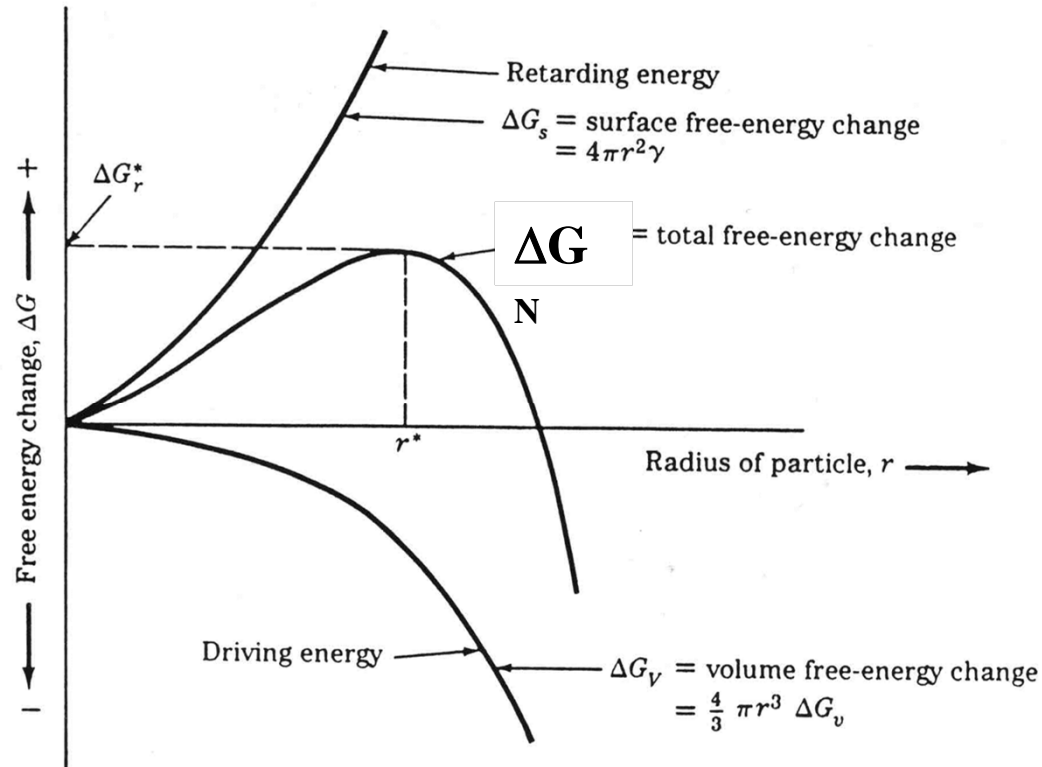

r: radius of spheric seed

r*: critical radius

ΔG_N : total free energy change

ΔG_s : surface free energy change

ΔG_v : volume free energy change

$$\Delta G_N = 4\pi r^2 \gamma_{SL} + \frac{4}{3} \pi r^3 \Delta G_v$$

Critical Radius r^*

The critical radius r^* = the radius at which ΔG_N is maximum

$$r^* = \frac{-2\gamma_{SL}}{\Delta G_v} = \frac{-2\gamma_{SL} T_m}{\Delta H_v \Delta T}$$

The energy barrier to homogeneous nucleation

$$\Delta G^* = \frac{16\pi\gamma_{SL}^3}{3\Delta G_v^2} = \frac{16\pi\gamma_{SL}^3 T_m^2}{\Delta H_v^2 \Delta T^2}$$

The temperature-dependence

$$r^* = 1/\Delta T$$

$$\Delta G^*_r = 1/\Delta T^2$$

Nucleation

a sub-critical cluster
unstable for $r < r^*$
the cluster re-dissolves

a nucleus
stable for $r > r^*$
the stable nucleus continues to grow

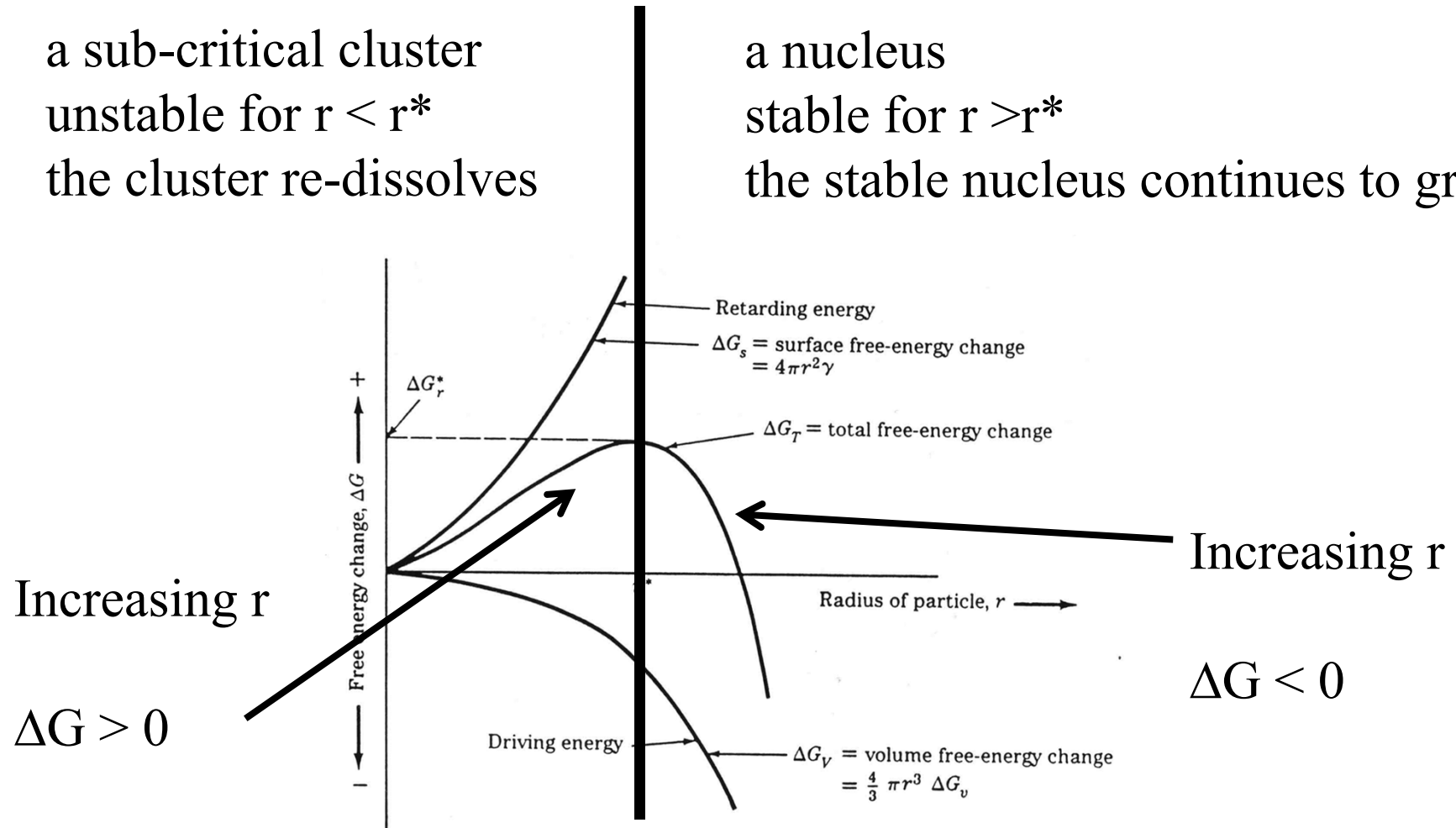

Nucleation rate n

Nucleation rate n

Liquid to solid

$$n = n_0 \exp\left(-\frac{(\Delta G_N + \Delta G_D)}{kT}\right)$$

ΔG_N = thermodynamic barrier to nucleation

ΔG_D = kinetic barrier to diffusion across the liquid/nucleus interface

Assume, that solid phase nucleates as spherical clusters of radius r

ΔG_N = the net (excess) free energy change for a single nucleus

$$\Delta G_N = \Delta G_S + 4/3\pi r^3 \Delta G_V$$

$\Delta G_S = 4\pi r^2 \gamma_{SL}$ surface free energy change positive

$4/3\pi r^3 \Delta G_V$ volume free energy change negative, l to s lowers the energy

Heterogeneous Nucleation

Nuclei can form at preferential sites:
flask wall, impurities, catalysts,

The energy barrier to nucleation, ΔG^* , is substantially
reduced

The critical nucleus size, r^* is the same for both
heterogeneous and homogeneous nucleation

Heterogeneous Nucleation

a solid cluster forming on a wall:

- the newly created interfaces (i.e. solid-liquid and solid-wall)
- the destroyed interface (liquid-wall)

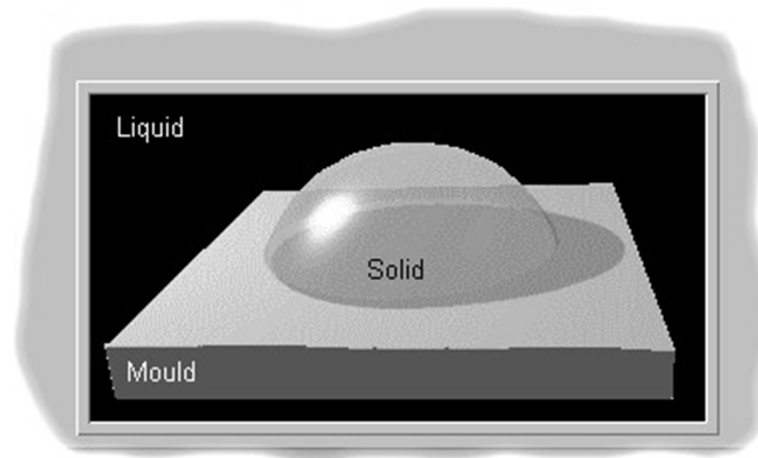

Heterogeneous Nucleation

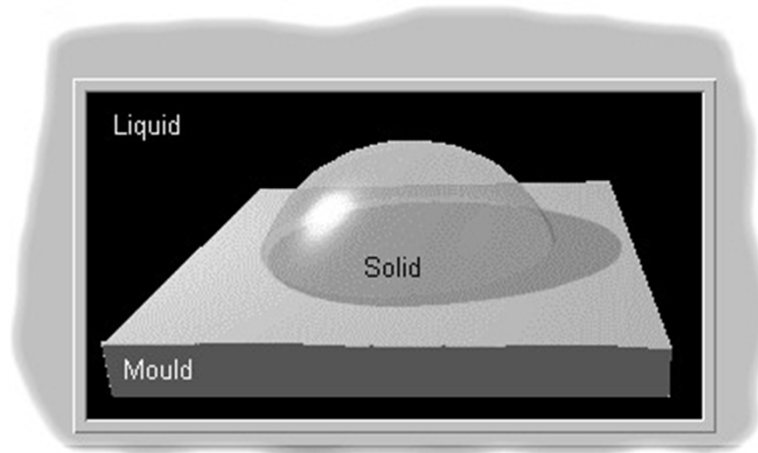

$$\cos \theta = \frac{\gamma_{WL} - \gamma_{WS}}{\gamma_{SL}}$$

θ = wetting angle

Shape factor $S(\theta)$

$$S(\theta) = \frac{(2 + \cos \theta)(1 - \cos \theta)^2}{4}$$

$$r_{\text{het}}^* = \frac{-2\gamma_{SL}}{\Delta G_v^*} = r_{\text{hom}}^*$$

$$\Delta G_{\text{het}}^* = \frac{16\pi\gamma_{SL}^3}{3\Delta G_v^{*2}} S(\theta) = \Delta G_{\text{hom}}^* S(\theta)$$

Wetting Angle

Force equilibrium

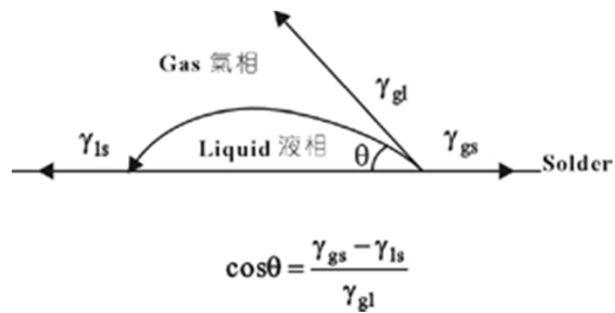

$$\gamma_{GS} = \gamma_{GL} \cos \theta + \gamma_{SL}$$

$$\cos \theta = \frac{\gamma_{GS} - \gamma_{SL}}{\gamma_{GL}}$$

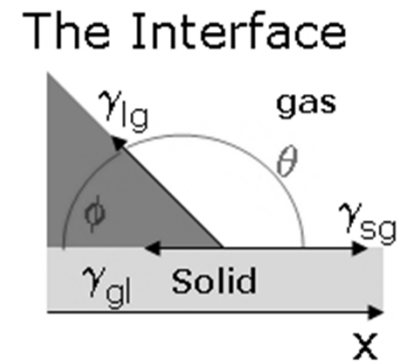
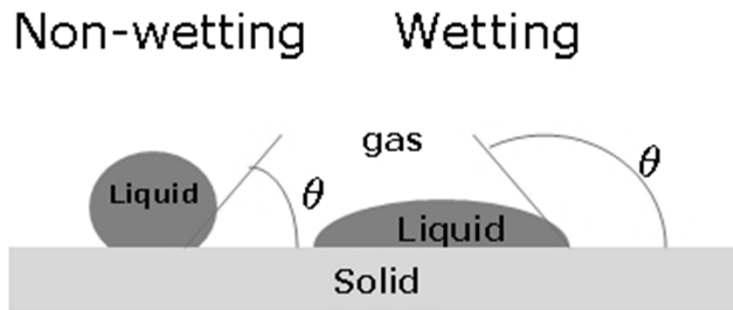

Heterogeneous Nucleation

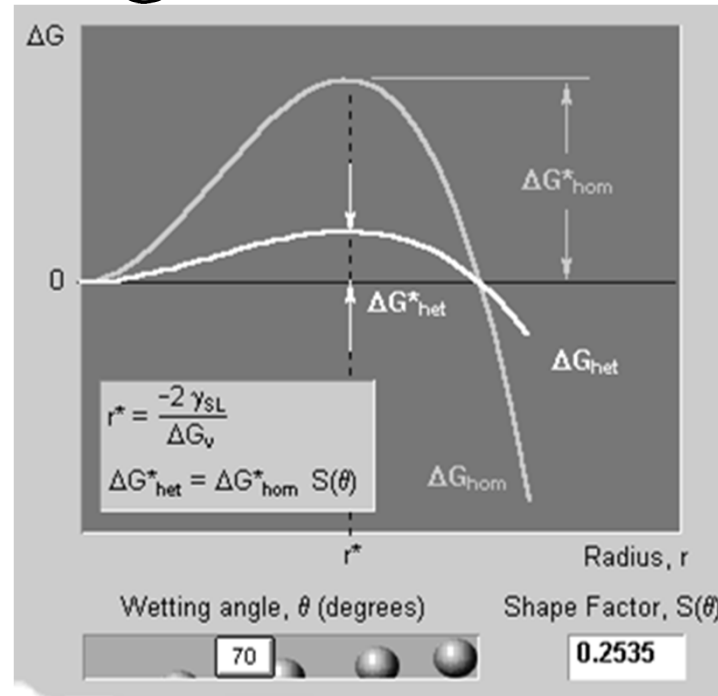

The critical radius r^* is the same for both homogeneous and heterogeneous nucleation

The volume of a critical nucleus and ΔG^* can be significantly smaller for heterogeneous nucleation due to the shape factor, depending on the wetting angle, θ

Direct Reactions of Solids

Solidification

$$\Delta G = \frac{4}{3} \pi r^3 \Delta G_v + 4 \pi r^2 \gamma_{SL}$$

- Volume free energy + surface energy

One solid phase changing to another

$$\Delta G = \frac{4}{3} \pi r^3 \Delta G_v + 4 \pi r^2 \gamma_{SL} + \frac{4}{3} \pi r^3 \varepsilon$$

- Volume energy + surface energy + strain energy
- the new solid does not take up the same volume as the old solid
- a misfit strain energy term, $\Delta G_s = V \varepsilon$

$$r^* = \frac{-2\gamma_{\alpha\beta}}{(\Delta G_v^* + \Delta G_s^*)} \quad \Delta G^* = \frac{16\pi\gamma_{\alpha\beta}^3}{3(\Delta G_v^* + \Delta G_s^*)^2}$$

$\gamma_{\alpha\beta}$ = the α/β interfacial energy

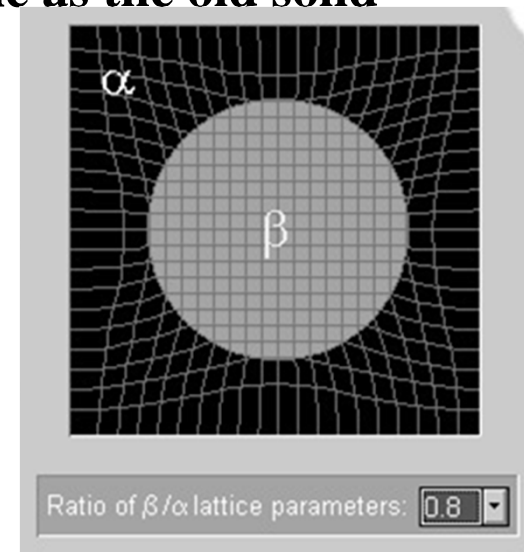

Nucleation

Transformation from liquid to solid phase requires:

- Nucleation of new phase
- Growth of new phase

Nucleation depends on:

- driving force toward equilibrium – cooling of a melt
increases as we move to lower temperatures
- diffusion of atoms into clusters
increases at higher temperatures

Combination of these two terms (multiplication)
determines the total nucleation rate

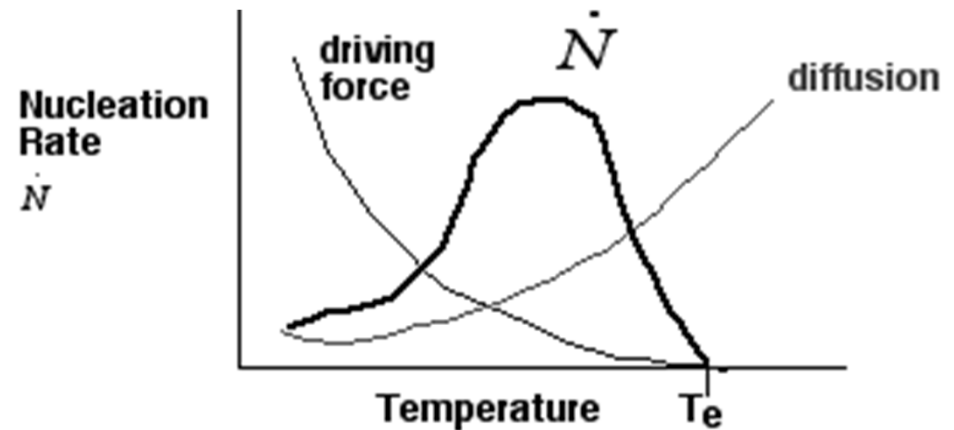

Nucleation rate I

Nucleation rate [$\text{m}^{-3} \text{s}^{-1}$] $I = \beta n^*$

n^* = the steady-state population of critical nuclei (m^{-3})

$$n^* = n_0 \exp\left(-\frac{\Delta G^*}{kT}\right)$$

n_0 = the number of potential nucleation sites per unit volume
 ΔG^* = the critical free energy of nucleation

β = the rate at which atoms join critical nuclei (s^{-1}), thereby making them stable, a diffusion-dependent term

$$\beta = \omega \exp(-Q/kT)$$

ω = temperature independent term incorporating vibrational frequency and the area to which atoms can join the critical nucleus

Q = an activation energy for atomic migration

Nucleation rate I

n^* = the steady-state population of critical nuclei (m^{-3})

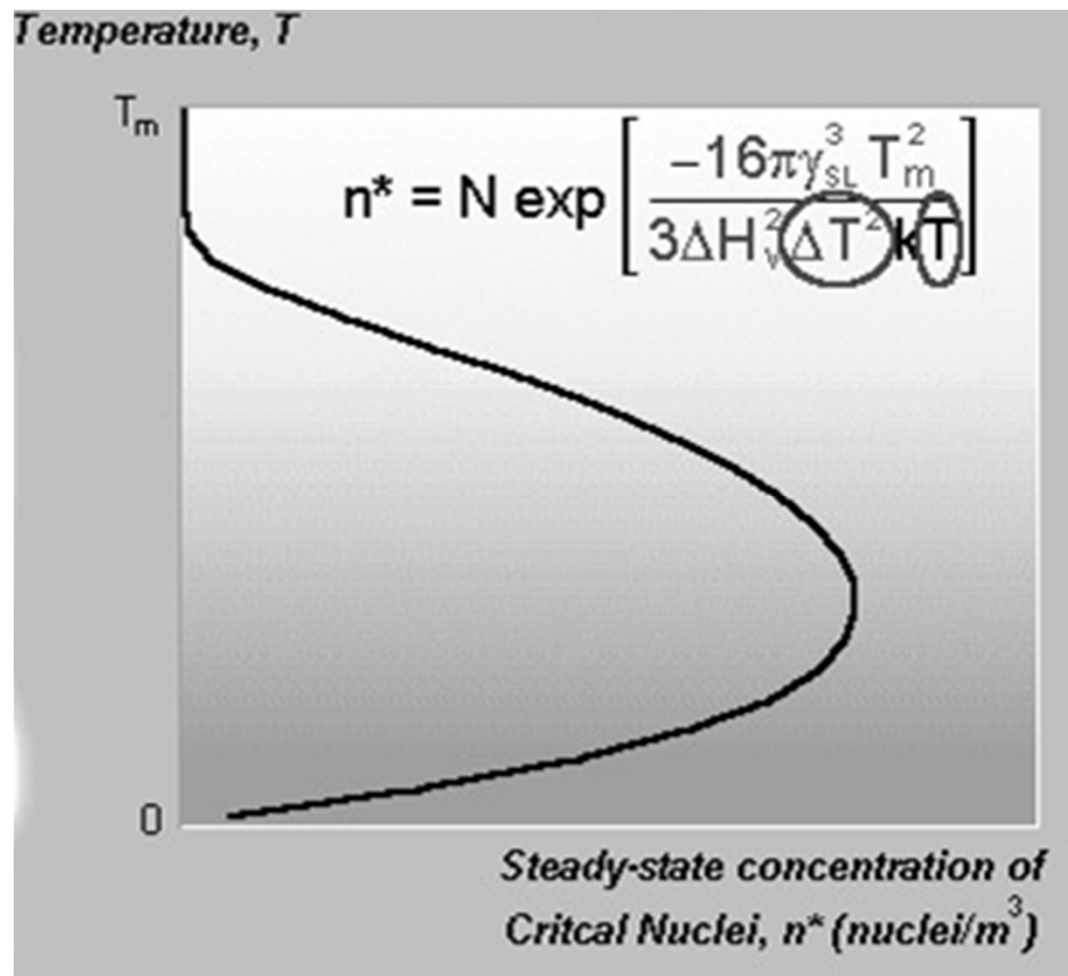

Nucleation

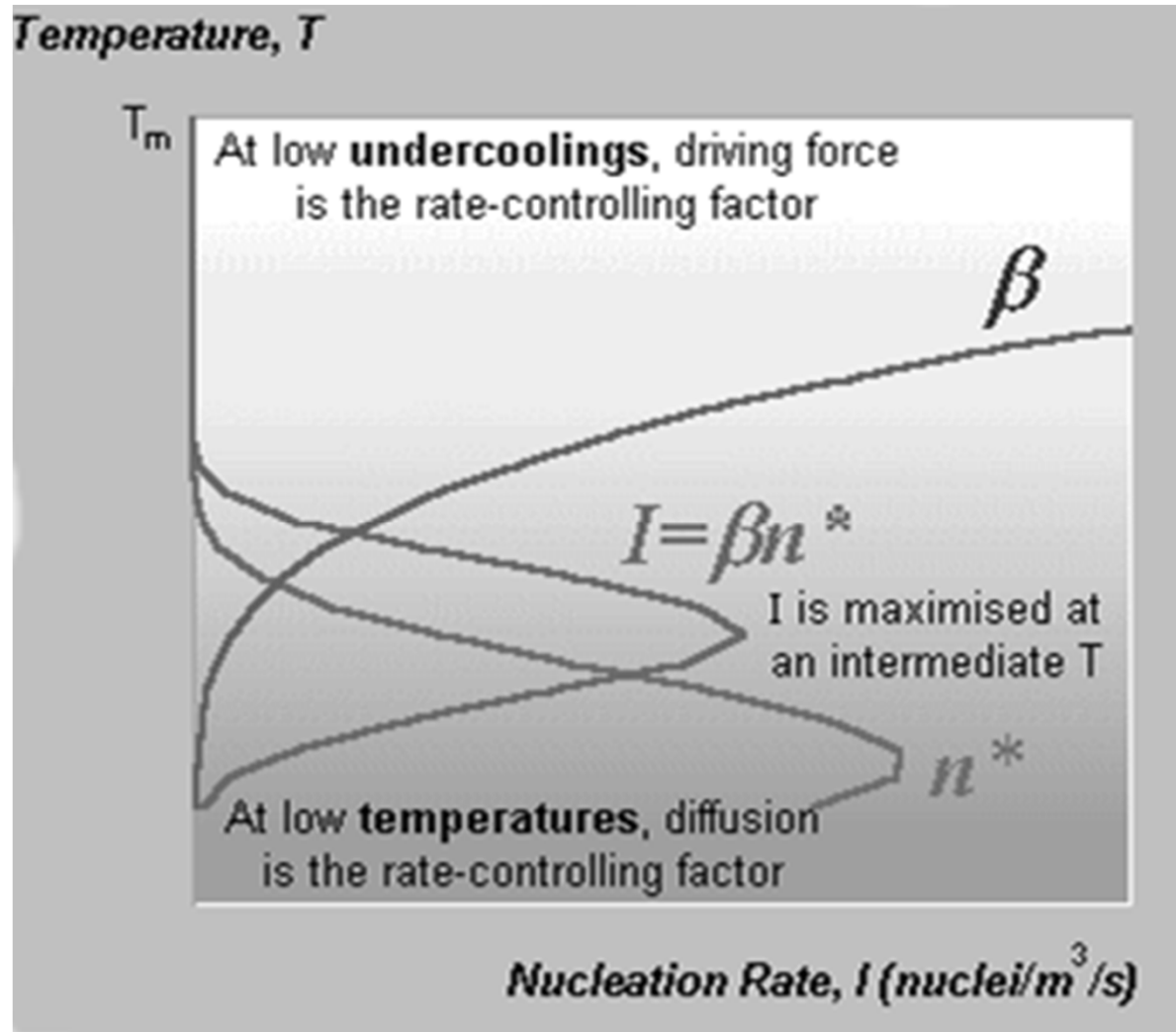

Nucleation vs. Growth

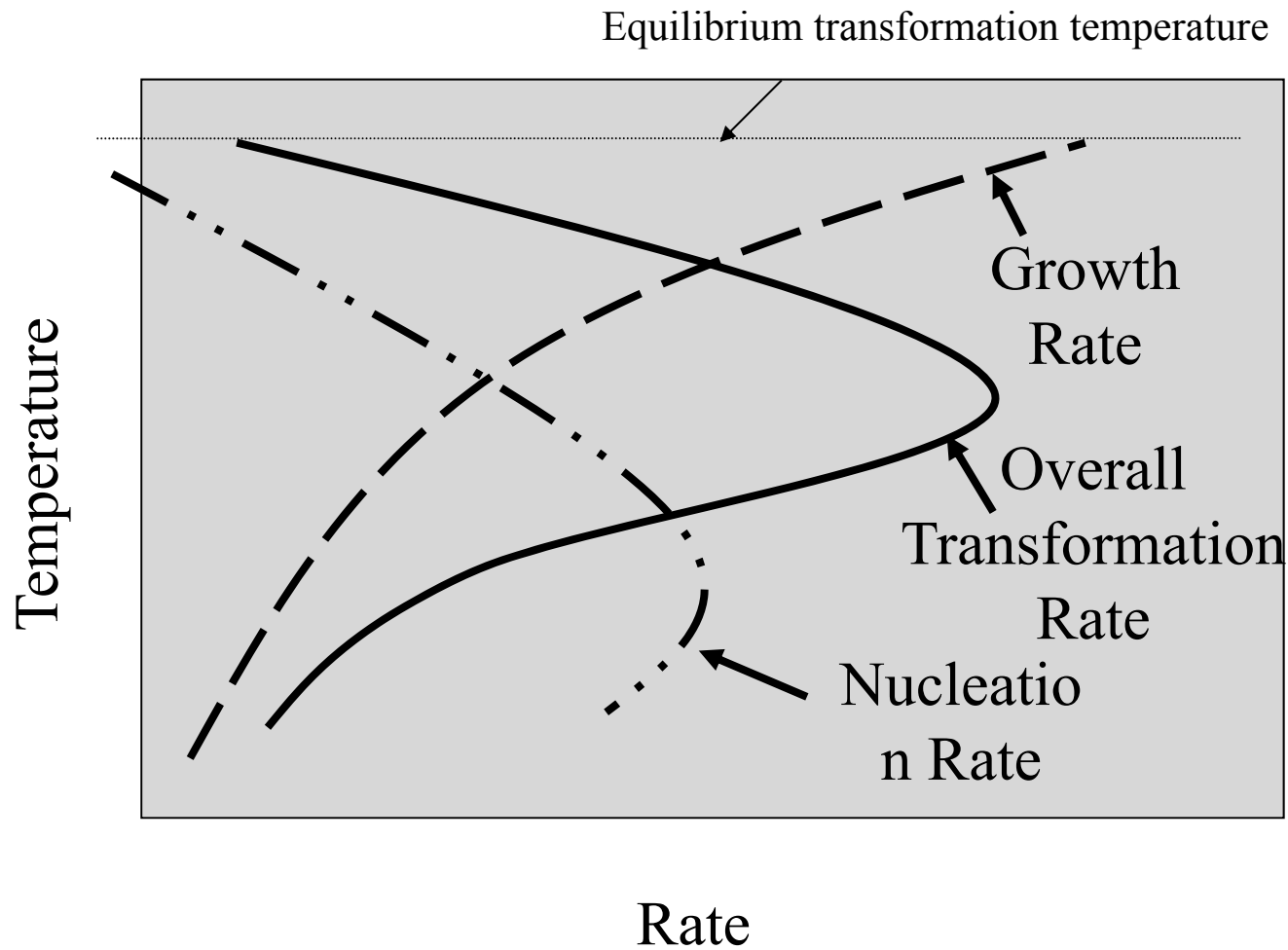

Nucleation vs. Crystal Growth (solution or melt)

Undercooling – cooling below the melting point

relations between undercooling, nucleation rate and growth rate of the nuclei

**large undercooling: many small nuclei
(spontaneous nucleation)
growth rate small - high viscosity, slow diffusion**

**small undercooling: few (evtl. small) nuclei
growth rate high – fast diffusion close to the m.p.**

Nucleation vs. Crystal Growth

Rate of nucleation

Rate of growth

T_a = small undercooling, slow cooling rate

Fast growth, slow nucleation = Few coarse crystals

T_b = larger undercooling, rapid cooling rate

Rapid nucleation, slow growth = many fine-grained crystals

T_c = very rapid cooling

Nearly no nucleation = glass

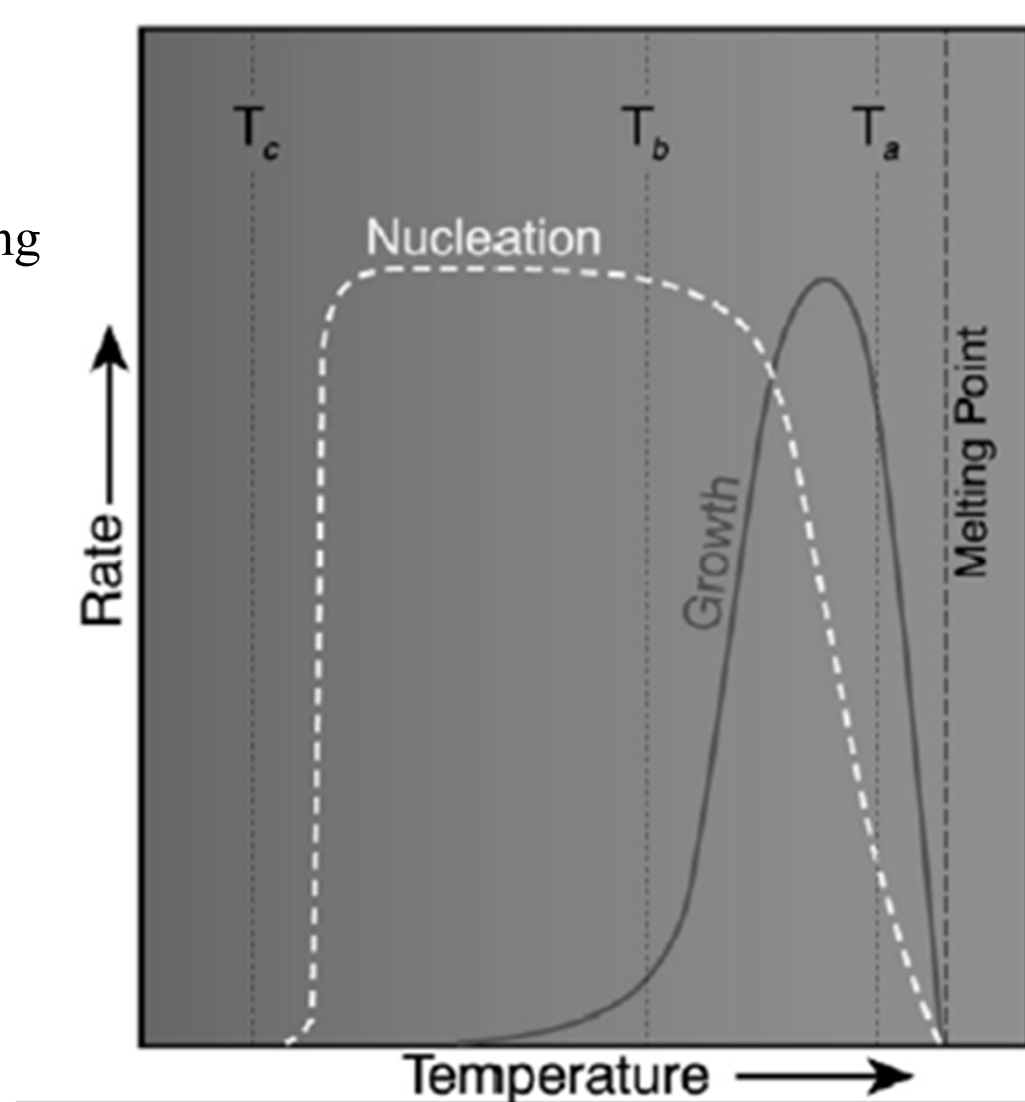

DIRECT REACTION OF SOLIDS

NUCLEATION RATE

**Nucleation requires structural similarity of reactants and products
less reorganization energy = faster nucleation of product phase
within reactants**

MgO, Al₂O₃, MgAl₂O₄ example

**MgO (rock salt) and MgAl₂O₄ (spinel) similar ccp O²⁻
but distinct to hcp O²⁻ in Al₂O₃ phase**

Spinel nuclei, matching of structure at MgO interface

**Oxide arrangement essentially continuous across MgO/MgAl₂O₄
interface**

**Bottom line: structural similarity of reactants and products
promotes nucleation and growth of one phase within another**

Lattice of oxide anions, mobile Mg²⁺ and Al³⁺ cations

Topotactic and epitactic reactions

Orientation effects in the bulk and surface regions of solids

Implies structural relationships between reagent and product

Topotaxy occurs in bulk, 1-, 2- or 3-D

Epitaxy occurs at interfaces, 2-D

DIRECT REACTION OF SOLIDS

Epitactic reactions

require 2-D structural similarity, lattice matching within 15% to tolerate oriented nucleation otherwise mismatch over large contact area, strained interface, missing atoms

Example: MgO/BaO, both rock salt lattices, cannot be lattice matched over large contact area

Lattice matched crystalline growth

Best with less than 0.1% lattice mismatch. Causes elastic strain at interface

Slight atom displacement from equilibrium position.

Strain energy reduced by misfit-dislocation

Creates dangling bonds, localized electronic states, carrier scattering by defects, luminescence quenching, killer traps, generally reduces efficacy of electronic and optical devices, can be visualized by HR-TEM imaging

Direct Reactions of Solids

Topotactic reactions

More specific, require interfacial and bulk crystalline structural similarity, lattice matching

Topotaxy: involves lock-and-key ideas of self-assembly, molecule recognition, host-guest inclusion, clearly requires available space or creates space in the process of adsorption, injection, intercalation etc.

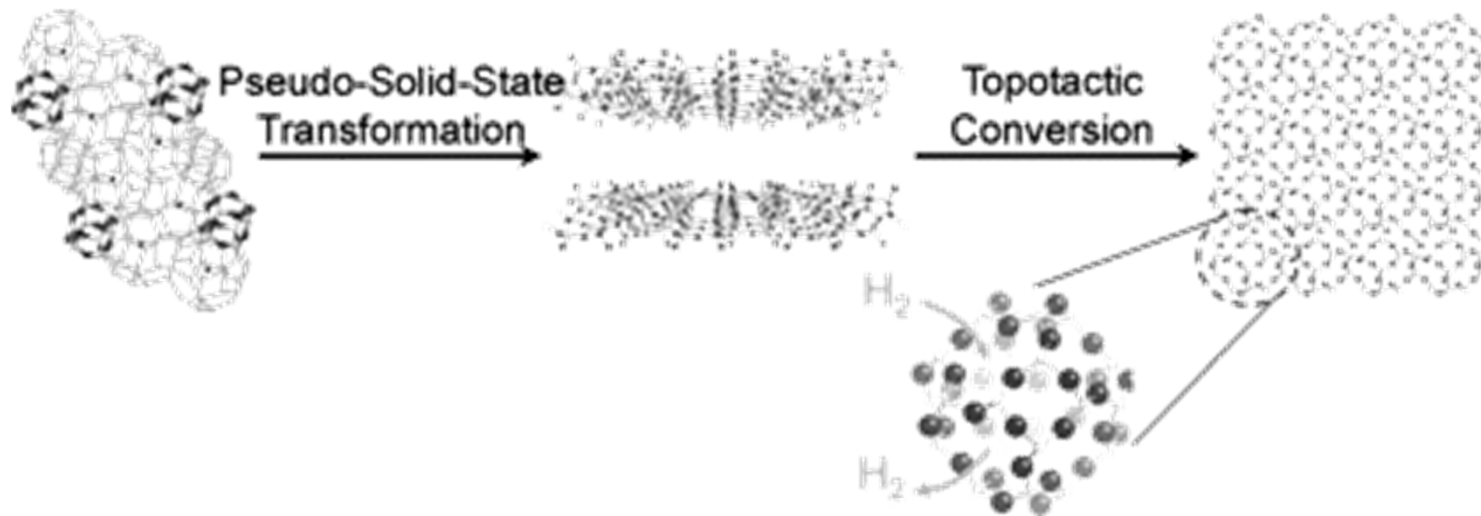

Direct Reactions of Solids

Surface structure and reactivity

Nucleation depends on actual surface structure of reacting phases.

Different Miller index faces exposed, atom arrangements different, different surface structures, implies distinct surface reactivities.

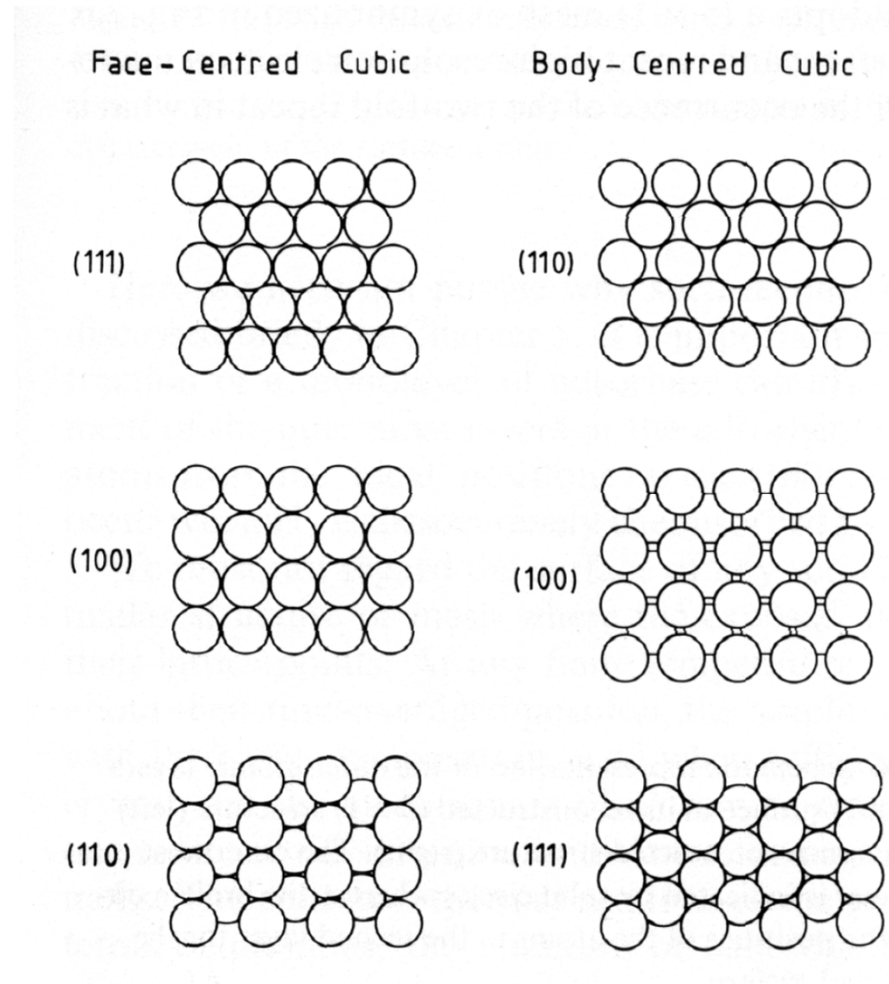

Direct Reactions of Solids

Example: MgO (rock salt)

{100} MgO alternating Mg^{2+} , O^{2-} at corners of square grid

{111} MgO, Mg^{2+} or O^{2-} hexagonal arrangement

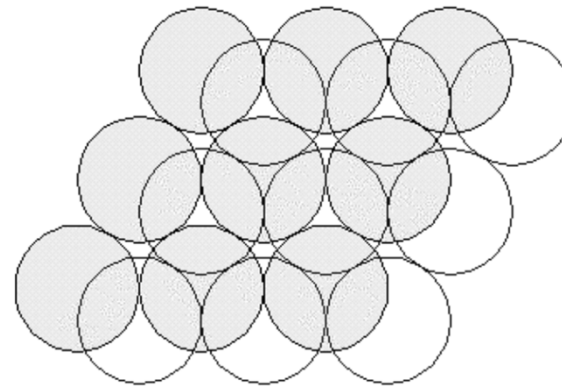
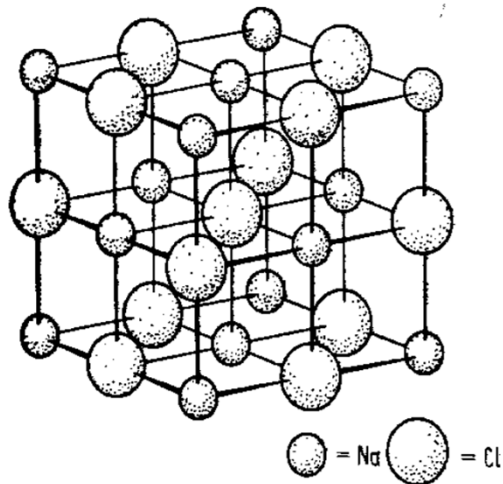

Direct Reactions of Solids

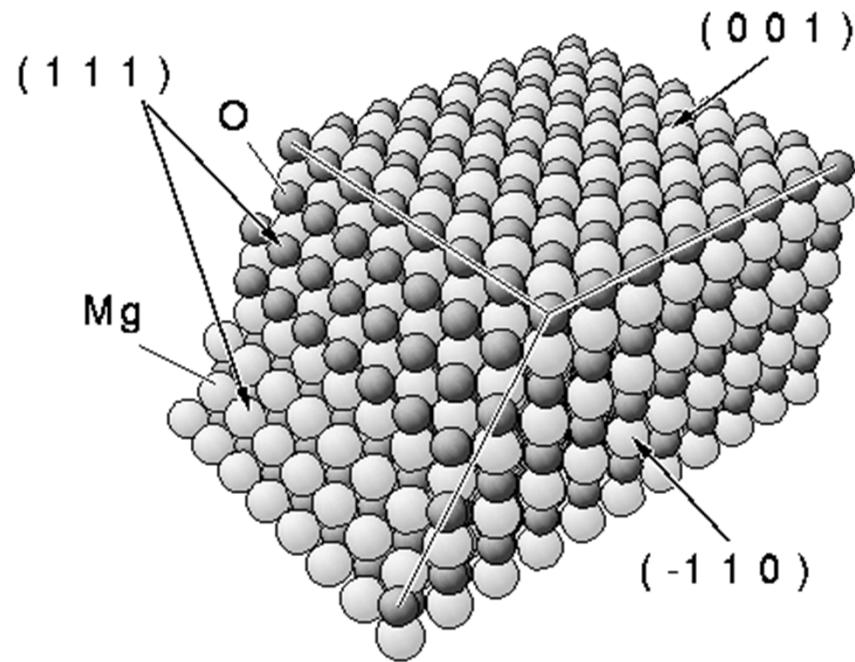

Cubic (rocksalt) MgO crystal: different netplanes

Direct Reactions of Solids

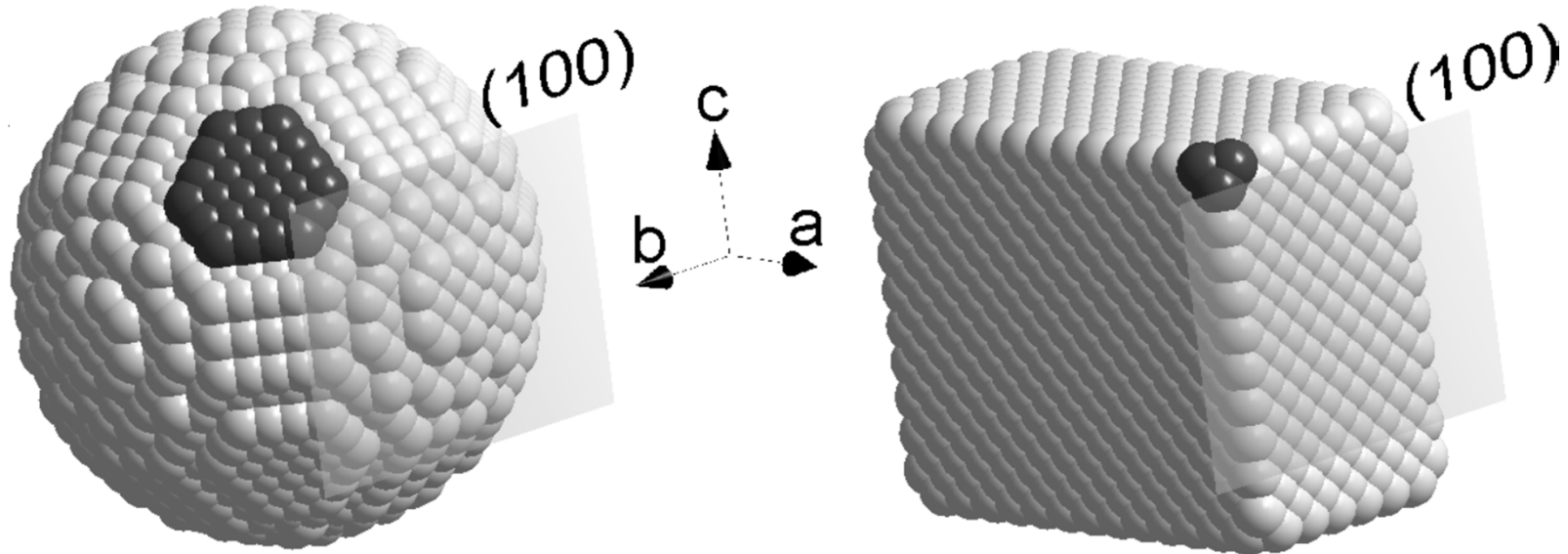

Atoms located in (111) and (100) crystal planes for spherical and cuboid particles

Model particles = fcc structure of Pt 4 nm size

Dark grey = atoms located in (111)-surface

Light orange = the (100) face

Surface Facet Reactivity

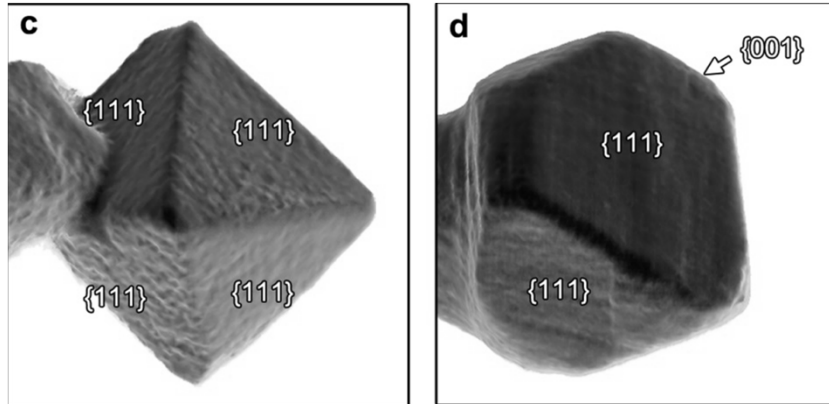

Electron tomography and electron energy loss spectroscopy (EELS) map the valency of the Ce ions in CeO_{2-x} nanocrystals in 3D. A facet-dependent reduction shell at the surface; {111} facets show a low surface reduction, whereas at {001} surface facets, the cerium ions are more reduced.

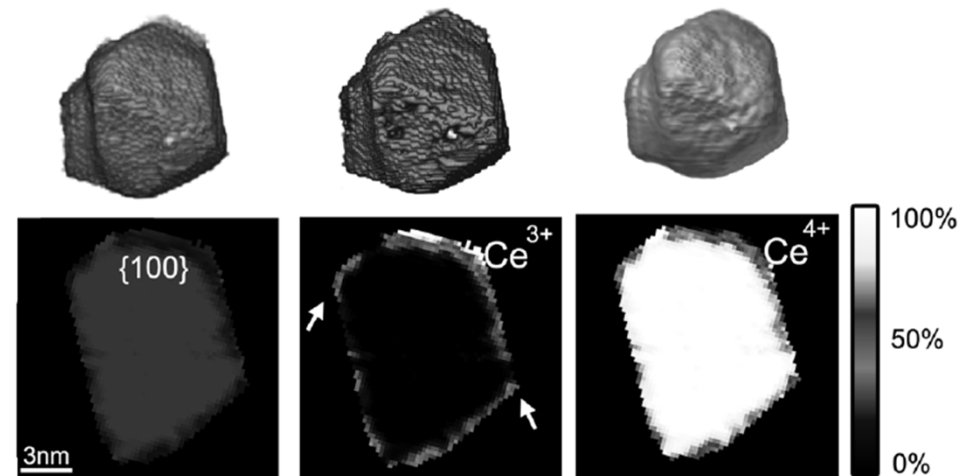
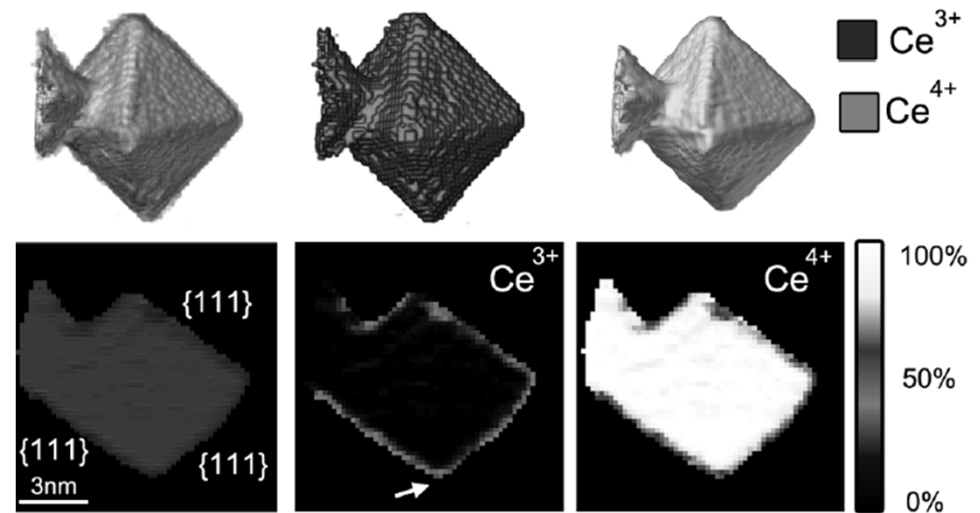

Work function of different crystal planes

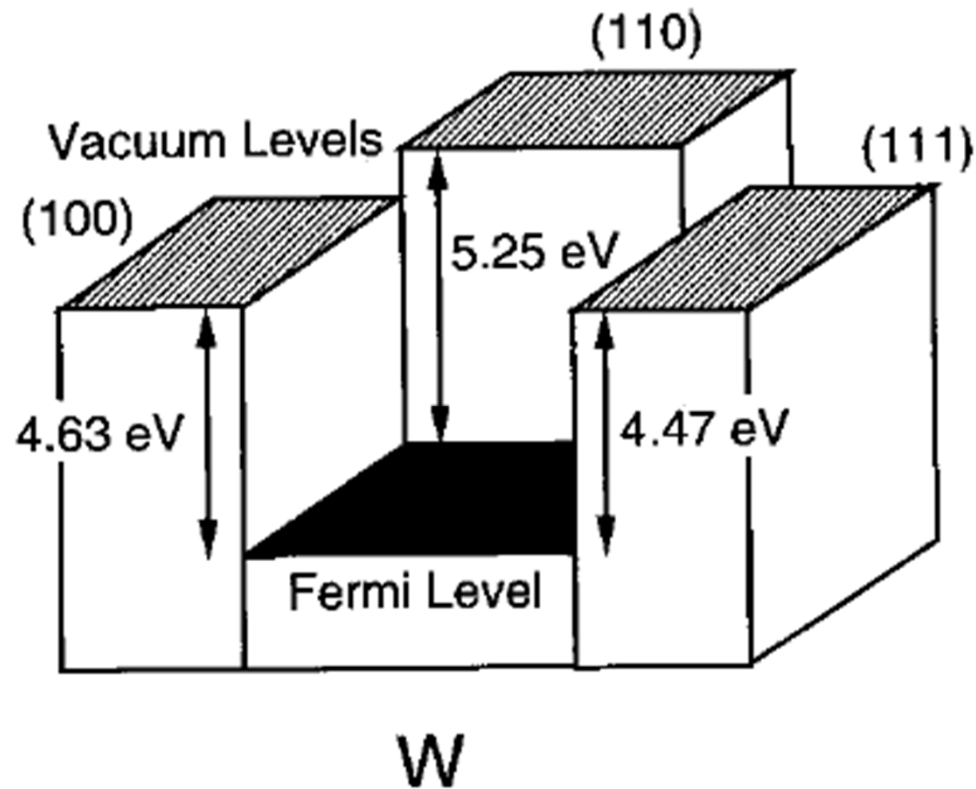

Planar density on (111) plane in a Simple Cubic Structure:

- Number of atoms on (111) plane is $1/6 \times 3 = 0.5$

- Area of (111) plane (triangle DEF) is $1/2 \times (\sqrt{2}a) \times (0.866 \times \sqrt{2}a) = 0.866a^2$

$$PD = 0.5 \text{ atom} / 0.866a^2 = 0.577 / a^2$$

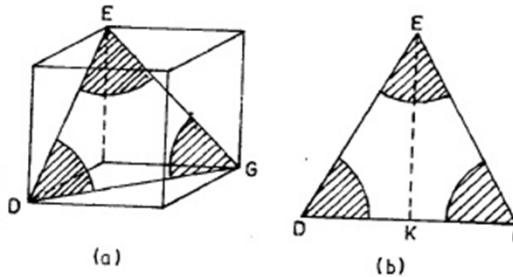

Planar density on (100) plane in a Body Centred Cubic Structure:

- Number of atoms on (100) plane is 1

- Area of (100) plane (square section) is $a \times a = a^2$

$$PD = 1 \text{ atom} / a^2 = 1 / a^2$$

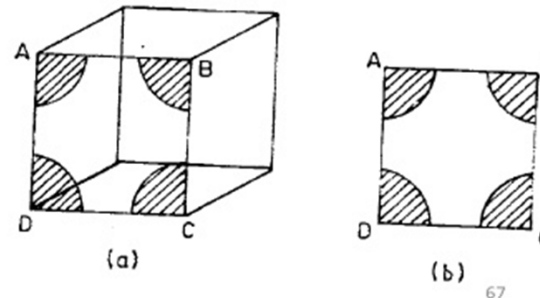

ly

/4

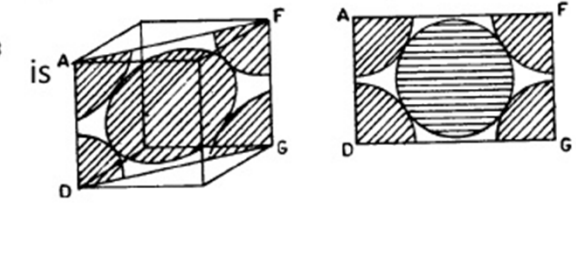

Body Centered Cubic Structure:

- Number of atoms on (111) plane is $1/6 \times 3 + 1 = 1.5$

- Area of (111) plane (triangle DEG) is $1/2 \times \sqrt{2}a$

$$\sqrt{2}a \sin 60^\circ = 0.866 a^2$$

$$PD = 1.5 \text{ atoms} / 0.866a^2 = 1.732 / a^2$$

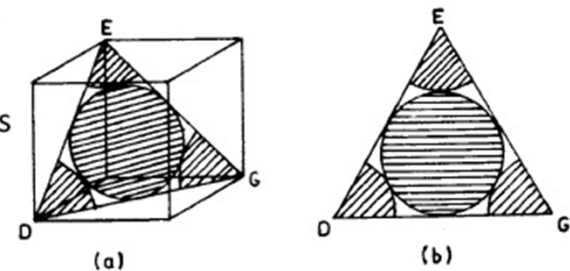

Direct Reactions of Solids

Different crystal habits possible, depends on rate of growth of different faces, octahedral, cubooctahedral, cubic possible and variants in between

CRYSTAL GROWTH

Most prominent surfaces, slower growth

Growth rate of specific surfaces controls morphology

Depends on area of a face, structure of exposed face, accessibility of a face, adsorption at surface sites, surface defects

Play major role in reactivity, nucleation, crystal growth, materials properties (electronic, optical, magnetic, charge-transport, mechanical, thermal, acoustical etc)

DIRECT REACTION OF SOLIDS

Azide Method

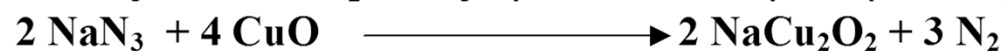
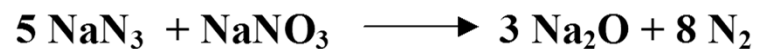
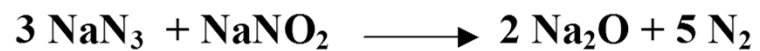

Self-Sustained High-Temperature Synthesis (SHS)

Mixing

Metal powders (Ti, Zr, Cr, Mo, W,) + other reactants

Pressing into pellets

Ignition by energy pulse (W wire)

S.S. reactor, under Ar

Exothermic reaction

Byproduct removal

DIRECT REACTION OF SOLIDS

SHS reactions:

- * heterogeneous
- * exothermic, high temperatures, $T_f = 1500 - 3000 \text{ }^\circ\text{C}$
- * high thermal gradients
- * redox
- * frontal mode, reaction wave velocity $u = 1 - 10 \text{ mm.s}^{-1}$
- * metastable phases

State of the substance in the reaction front:

solid ($T_f < T_m$, $p < p_0$) „solid flame“

liquid, melt ($T_f > T_m$)

gaseous

Thermite reaction

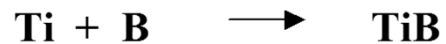
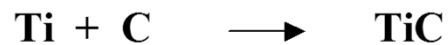

Self-Propagating Metathesis

**Grinding of components in a glove box
addition of NaCl, KCl or NH₄Cl as a heat sink,
S.S. vessel, ignition by a resistively heated wire, reaction time 1 s,
washing products with MeOH, water, drying**

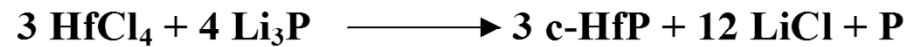
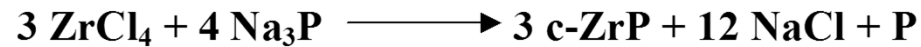

**c-ZrP and c-HfP hard and chemically inert materials,
hexagonal to cubic transitions: ZrP 1425 °C, HfP 1600 °C**

DIRECT REACTION OF SOLIDS

Self-Propagating Metathesis

Silicon production

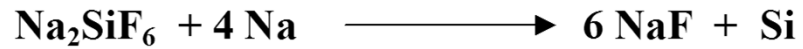

Hard materials production

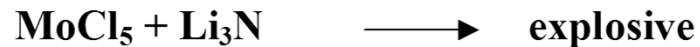
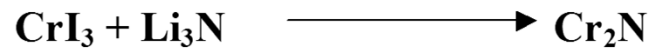
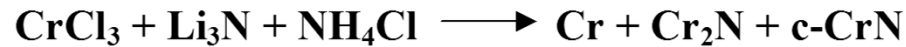
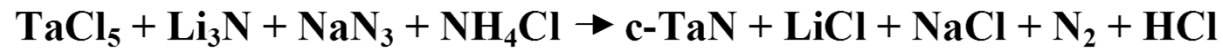

Combustion Synthesis

**Oxidizing reagents (metal nitrates) mixed with fuel (urea, glycine) by melting or in solution
drying
combustion ignited at 300-500 °C
exothermic self-propagating non-explosive reaction (excess of fuel)
reaction time 1 min, flame temperature 1000 °C
product dry foam, crumbles to a fine powder.**



Combustion Synthesis

Examples

ZnO(90%) - Bi₂O₃ - Sb₂O₃

Non-Ohmic behavior $I = (U/C)^a$ C, a = constants, a = 50
Voltage stabilization, surge absorption

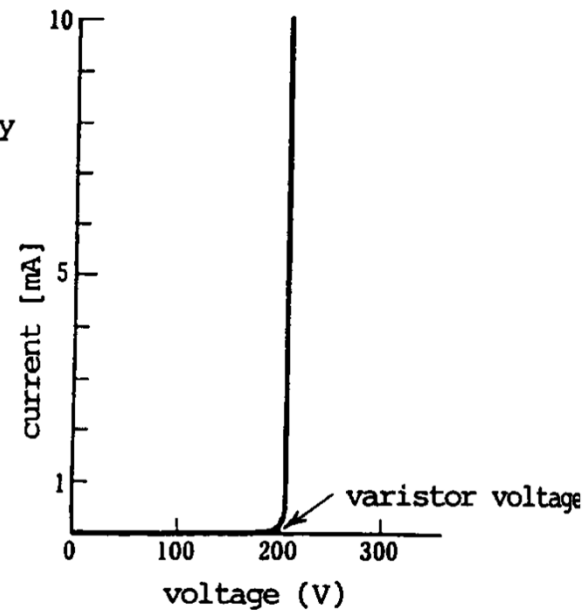
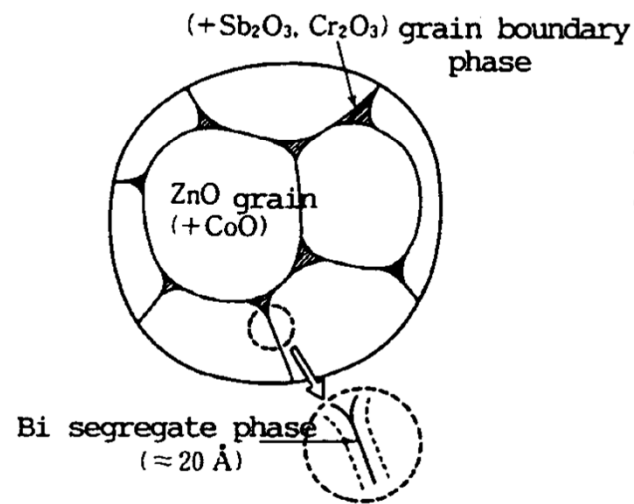

Reaction front propagation: glycine-iron nitrate

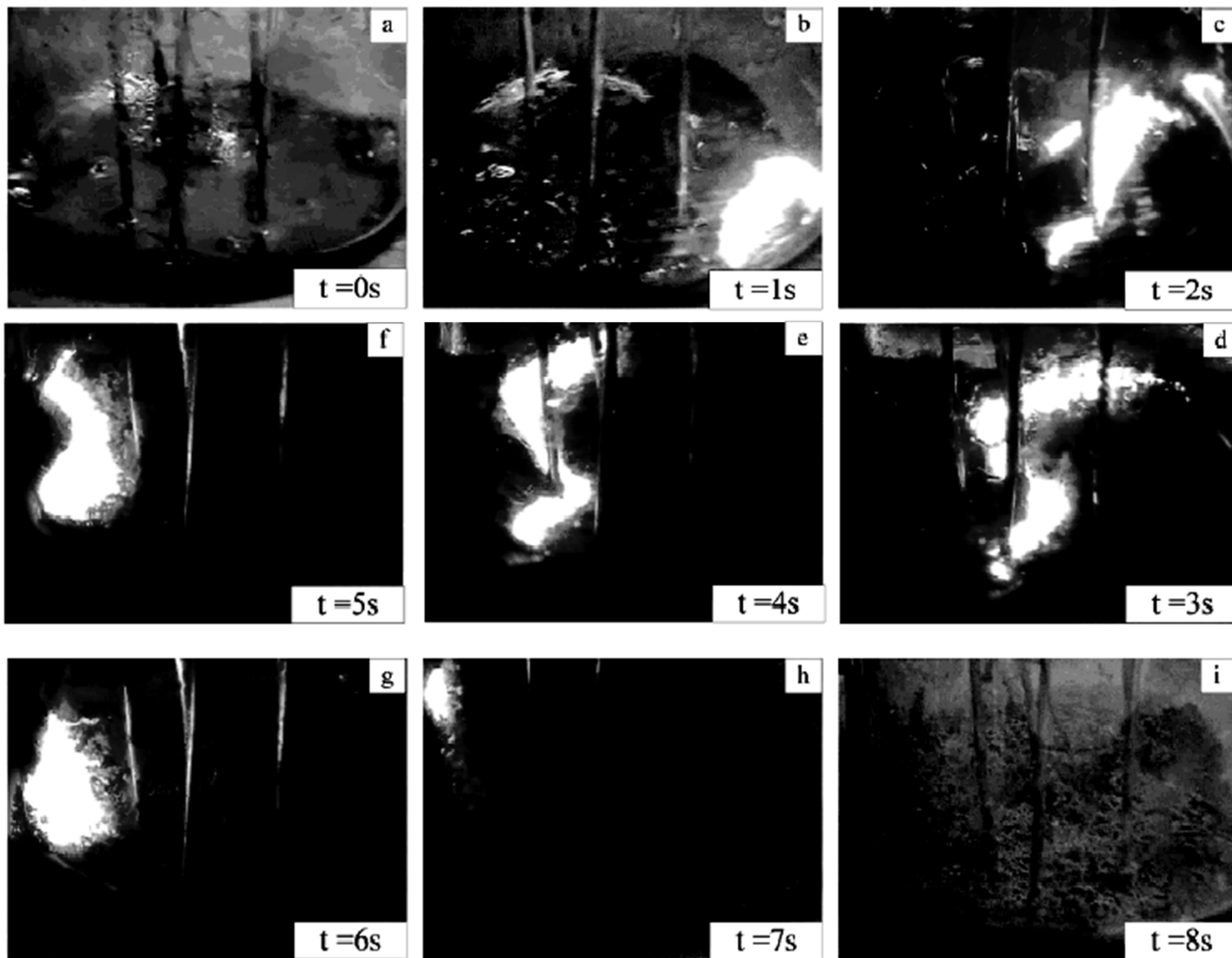

Self-Propagating Metathesis

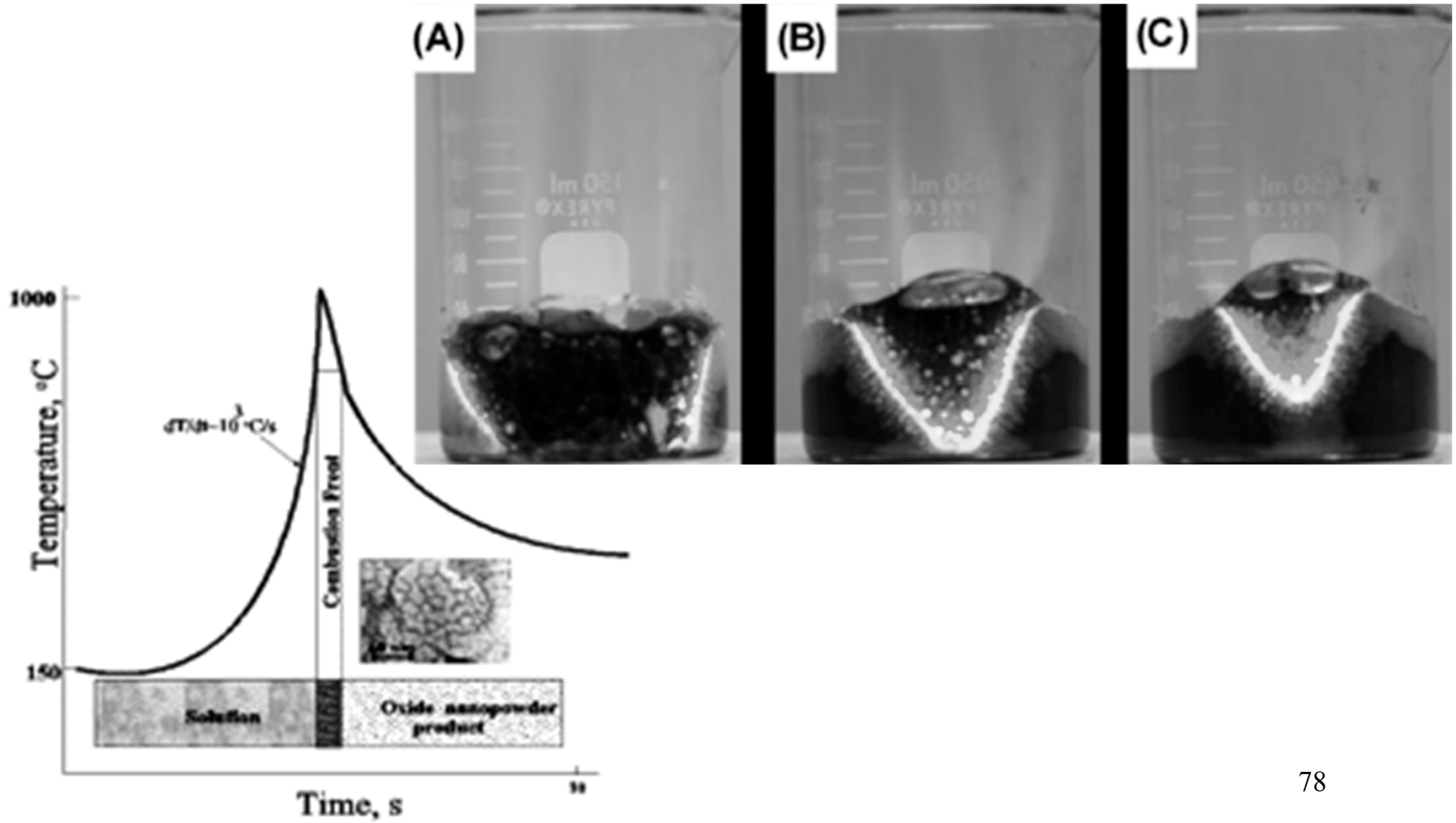

Combustion Synthesis

Examples



mixing 1:1:1 in aqueous solution, drying at 90 °C

combustion at 250 °C

calcination to LiVMoO_6 cathode material for Li-ion

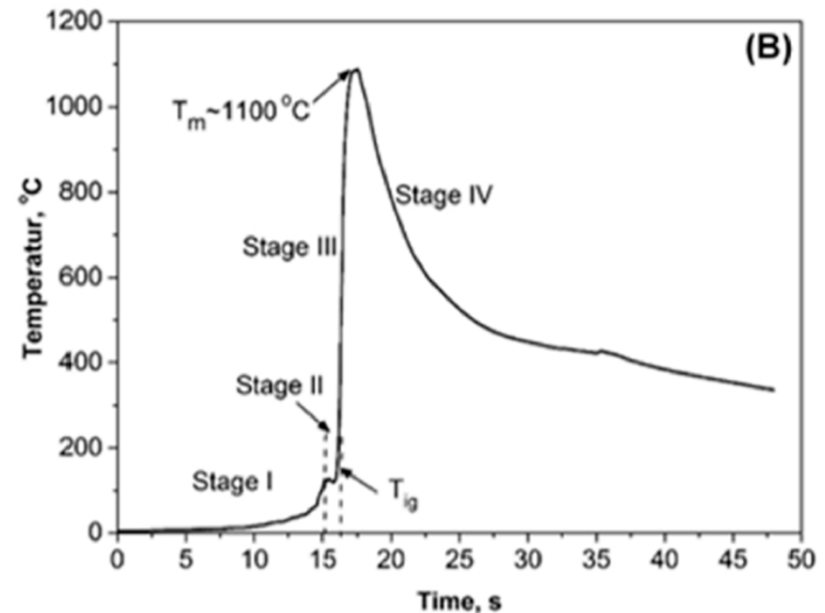
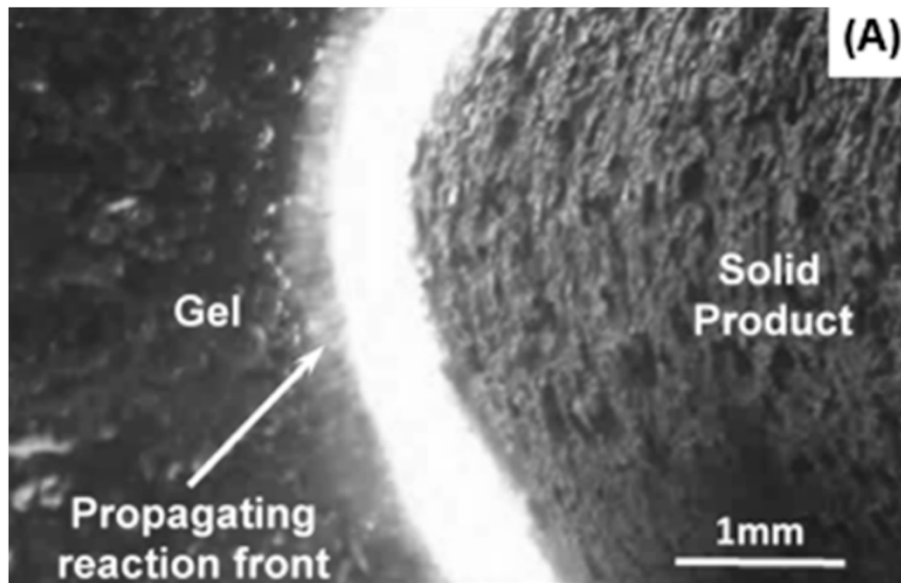

Solution Combustion Synthesis

Yttrium Iron Garnet (YIG) $Y_3Fe_5O_{12}$

Metal nitrates (MN) = oxidants

- $Y(NO_3)_3 \cdot 6H_2O$
- $Fe(NO_3)_3 \cdot 9H_2O$

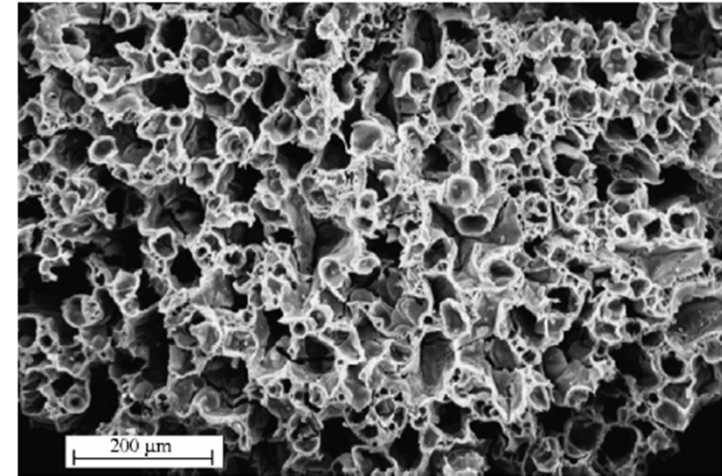

Citric acid monohydrate (CA) = fuel

Solution in water $Y:Fe = 3:5$

The solution evaporated at $85\text{ }^\circ\text{C}$

stirred until viscous gel

Increasing the temperature up to $250\text{ }^\circ\text{C}$

ignition of the gel

MN/CA ratio controls the size

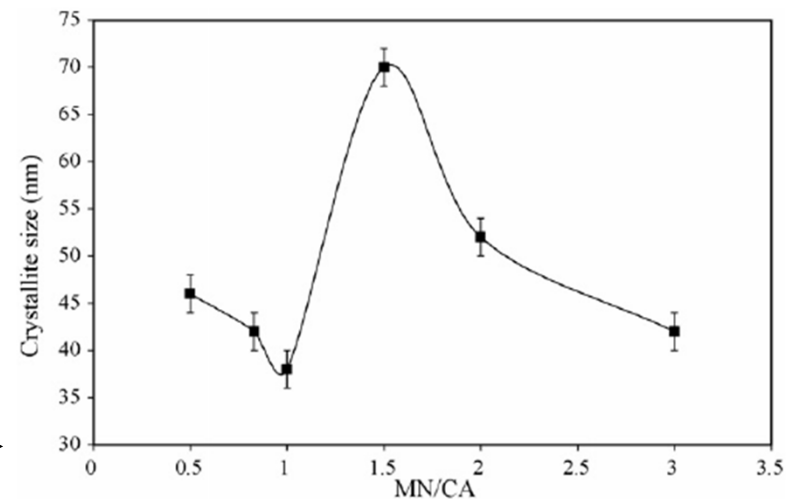

DIRECT REACTION OF SOLIDS

Carbothermal Reduction

Acheson

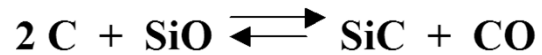
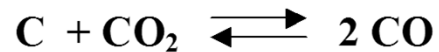
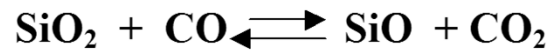
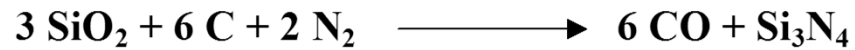
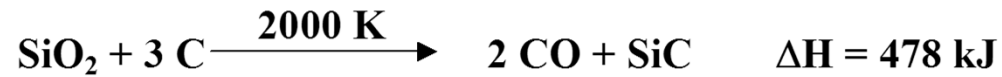

DIRECT REACTION OF SOLIDS

Carbothermal Reduction

Borides

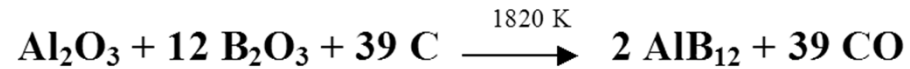
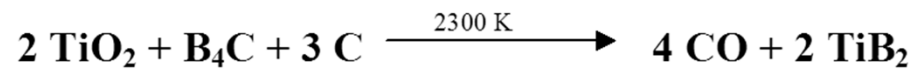
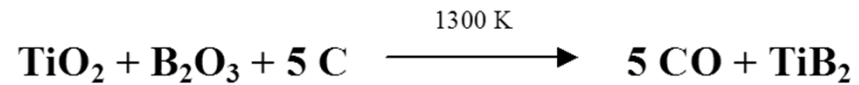

Carbides

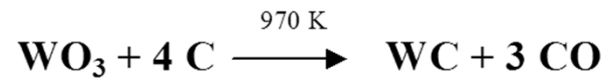
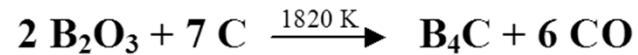
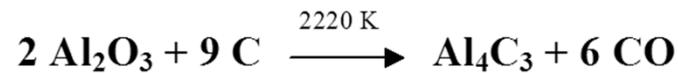

Nitrides

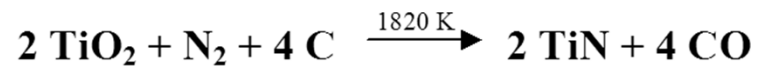
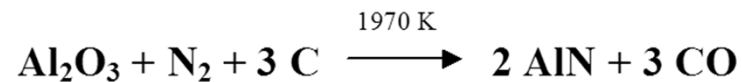

DIRECT REACTION OF SOLIDS

Fusion-Crystallization from Glass

Glass is a non-equilibrium, non-crystalline condensed state of matter that exhibits a glass transition. The structure of glasses is similar to that of their parent supercooled liquids (SCL), and they spontaneously relax toward the SCL state. Their ultimate fate, in the limit of infinite time, is to crystallize.

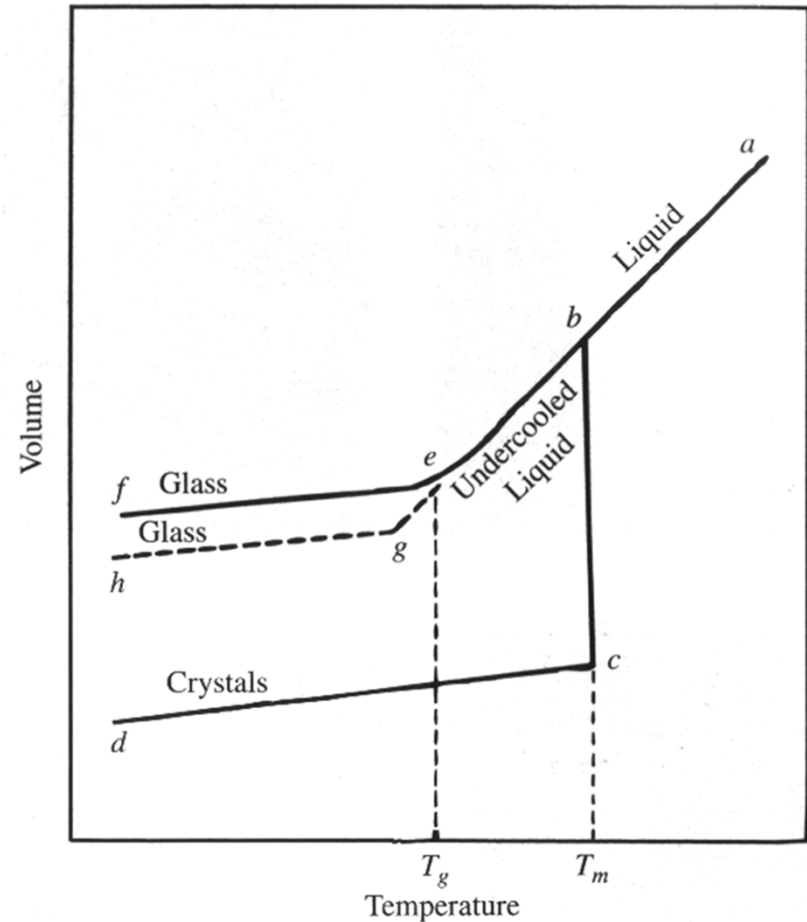

DIRECT REACTION OF SOLIDS

Fusion-Crystallization from Glass

Mixing powders

Melting to glass: single phase, homogeneous
(T, C), amorphous

Temperature limits:

- mp of reagents
- volatility of reagents

Nucleation agent

Homogeneous nucleation, few crystal seeds

Slow transport of precursors to seed

Lowest possible crystallization temperature

Crystallizing a glass above its glass
transition

Metastable phases accessible, often
impossible to prepare by other methods

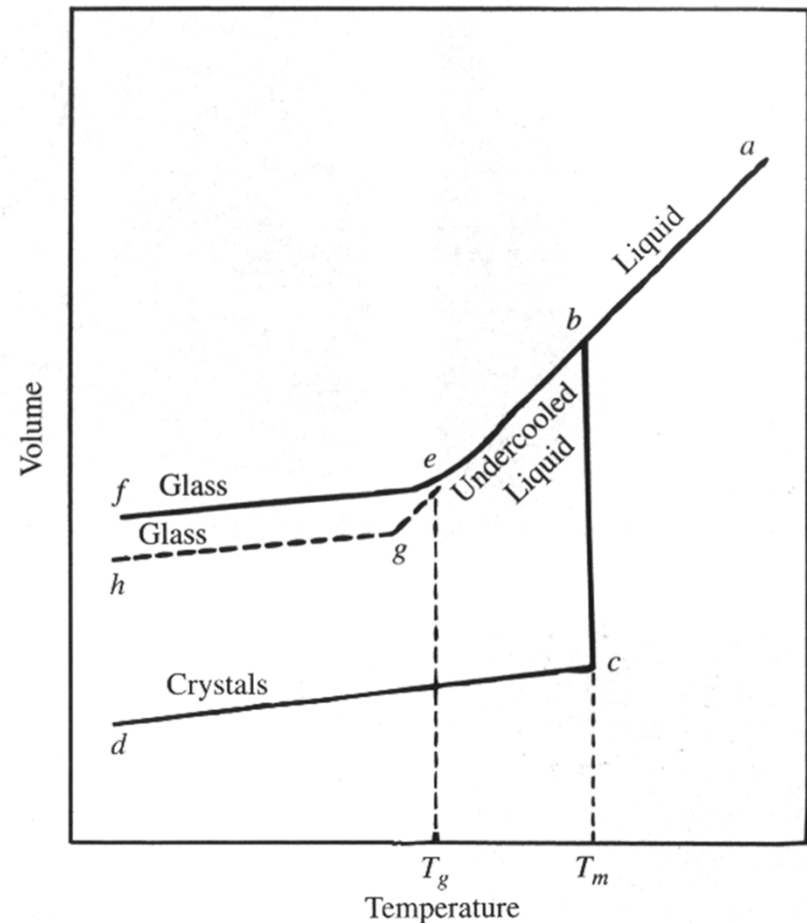

DIRECT REACTION OF SOLIDS

Fusion-Crystallization from Glass

Fusion-Crystallization from Glass

Production of window glass

Abrasive grains



Crystallizing an inorganic glass, lithium disilicate

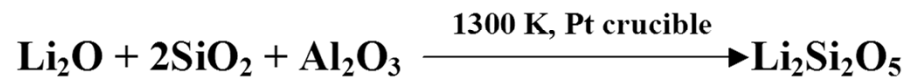

$\text{Li}_2\text{Si}_2\text{O}_5$ forms as a melt. Hold at 1100°C for 2-3 hrs. Homogeneous, rapid cooling, fast viscosity increase, quenches transparent glass

$\text{Li}_2\text{Si}_2\text{O}_5$, glass $500\text{-}700^\circ\text{C}$, $T_g \sim 450^\circ\text{C}$ from DSC \rightarrow $\text{Li}_2\text{Si}_2\text{O}_5$, crystals in 2-3 hrs., principle of crystallizing a glass above its glass transition

DIRECT REACTION OF SOLIDS

Fusion-Crystallization from Glass

Fusion-Crystallization from Glass

Glass Ceramics

polyxtalline materials made by controlled xtallization of glasses

Cooking utensils

$\text{Li}_2\text{O}/\text{SiO}_2/\text{Al}_2\text{O}_3(>10\%)$ nucl. TiO_2 β -spodumene

Vacuum tube components

$\text{Li}_2\text{O}/\text{SiO}_2/\text{Al}_2\text{O}_3(<10\%)$ nucl. P_2O_5 Li-disilicate, quartz

Missile radomes

$\text{MgO}/\text{SiO}_2/\text{Al}_2\text{O}_3$ nucl. TiO_2 cordierite, cristobalite

Cements

5600 BC - the floor of a villa in Serbia, a red lime binder (calcium oxide). Lime obtained by burning gypsum, limestone or chalk

2589-2566 BC - Egypt, the Great Pyramid of Cheops, gypsum-derived binders

800 BC the Greeks, 300 BC the Romans, limestone-derived cements became widespread

Vitruvius, *De Architectura*

the Appian Way, the Coliseum, the Pantheon

cements based on a mixture of natural and synthetic aluminosilicates with lime - pozzolan

1756 John Smeaton, lighthouse, a pozzolanic binder from lime, volcanic ash and copper slag, able to withstand the harsh coastal environment

1824 Joseph Aspdin, Leeds, England, developed and patented Portland cement.

Portland cement - made by heating at 1450°C chalk, shale, and clay or **limestone** in a kiln to form a partially fused mixture – clinker, which is then finely ground with gypsum

Cements

Hydraulic cements - materials that set and harden by reacting with water, produce an adhesive matrix, combined with other materials, are used to form structural composite materials.

Non-hydraulic cements - lime and gypsum plasters, set by drying out, must be kept dry, gain strength slowly by absorption of CO₂ to form calcium carbonate through carbonation

Concrete - a mixture of cement (binding agent) and water with aggregate (varying amounts of coarse and fine sand and stone). Consumption of concrete - 2.5 tonnes per person per year.

Mortar - used to bind bricks together, made from cement but with finer grade of added materials.

Portland cement

Component	Formula	Phase	wt%
Tricalcium silicate	C3S Ca_3SiO_5	Alite	50-70
B-dicalcium silicate	C2S Ca_2SiO_4	Belite	15-30
Tricalcium aluminate	C2A $\text{Ca}_3\text{Al}_2\text{O}_6$	Aluminate	5-10
Tetracalcium aluminoferrite	C4AF $\text{Ca}_2(\text{Al/Fe})\text{O}_5$	Ferrite	5-15

Chemical Cement Nomenclature

S	SiO_2	C	CaO
A	Al_2O_3	F	Fe_2O_3
T	TiO_2	M	MgO
K	K_2O	N	Na_2O
H	H_2O		
$\bar{\text{C}}$	CO_2		
S	SO_3		

