

CG920 Genomics

Lesson 4 Forward Genetics

Jan Hejátko

Functional Genomics and Proteomics of Plants,
Mendel Centre for Plant Genomics and Proteomics,
Central European Institute of Technology (CEITEC), Masaryk University, Brno
hejatko@sci.muni.cz, www.ceitec.muni.cz



INVESTICE DO ROZVOJE VZDĚLÁVÁNÍ

Tato prezentace je spolufinancována
Evropským sociálním fondem
a státním rozpočtem České republiky

Outline

- Forward vs. Reverse Genetics
- Use of Libraries of Insertional Mutants in Forward Genetics
 - Searching in Libraries of Insertional Mutants According to:
 - anatomically or morphologically detectable phenotype
 - metabolic profile
 - expression of genes of interest
 - Identification of the Mutated Locus
 - plasmid rescue
 - iPCR
- Use of Libraries of Point Mutants in Forward Genetics
 - Positional Cloning

Outline

- Forward vs. Reverse Genetics



INVESTICE DO ROZVOJE VZDĚLÁVÁNÍ

Tato prezentace je spolufinancována
Evropským sociálním fondem
a státním rozpočtem České republiky

„Classical“ genetics *versus* „reverse genetics“ approaches in functional genomics

RANDOM MUTAGENESIS

„Classical genetics“ approach

1. IDENTIFICATION OF PHENOTYPE

2. GENE MAPPING

3. GENE IDENTIFICATION
- position cloning

EMS



$h \times n$



T-DNA



„Reverse genetics“ approach

1. ISOLATION OF SEQUENCE-SPECIFIC MUTANT

2. IDENTIFICATION OF PHENOTYPE

3. PROOF OF CAUSAL RELATIONSHIP BETWEEN INSERTION AND PHENOTYPE

(retro)transposons



Outline

- Forward vs. Reverse Genetics
- Use of Libraries of Insertional Mutants in Forward Genetics
 - Searching in Libraries of Insertional Mutants According to:
 - anatomically or morphologically detectable phenotype



INVESTICE DO ROZVOJE VZDĚLÁVÁNÍ

Tato prezentace je spolufinancována
Evropským sociálním fondem
a státním rozpočtem České republiky

Insertional mutagenesis in forward genetics approaches

- Use of insertional mutagenesis for study of carcinogenesis
 - Infection of EμMyc mice by MoMuLV retrovirus leads to **lymphomas formation**, which arose due to **activation of Pim kinases** (40 % activation of Pim1, 15 % activation of Pim2), molecular targets of these kinases were unknown

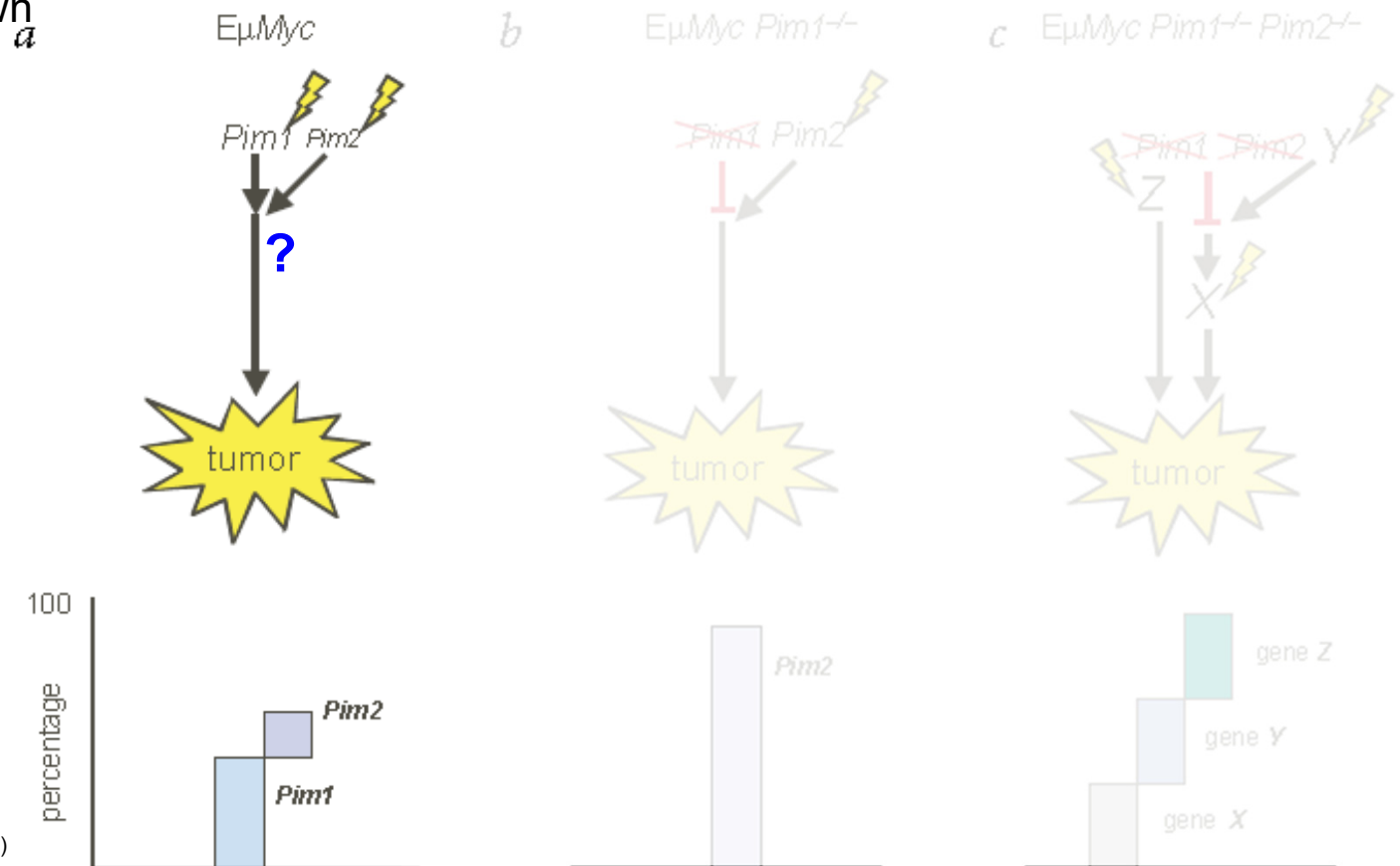

Insertional mutagenesis in forward genetics approaches

- Use of insertional mutagenesis for study of carcinogenesis
 - Infection of EμMyc *pim1* mutants by MoMuLV retrovirus leads to lymphomas formation, which in 90 % contain insertion nearby (activation) *Pim2*

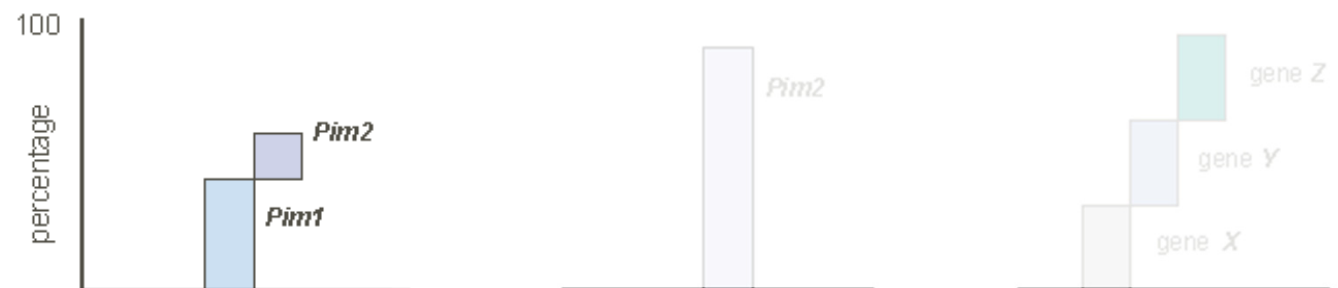
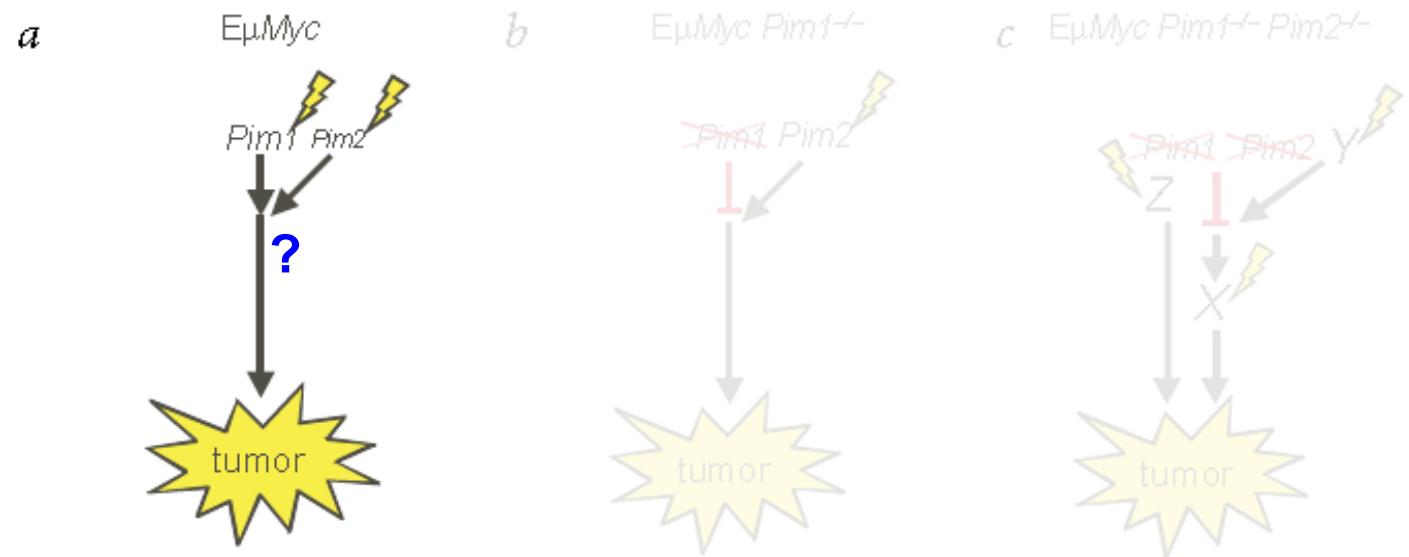

Insertional mutagenesis in forward genetics approaches

- Use of insertional mutagenesis for study of carcinogenesis
 - Infection of EμMyc double mutants *pim1*, *pim2* by MoMuLV retrovirus leads to lymphomas formation, which can be expected to activate either one of the signalling partner of Pim proteins (Y), one of the downstream proteins of Pim signalling pathway (X) or to activate some of the related pathways leading to lymphomagenesis (Z).

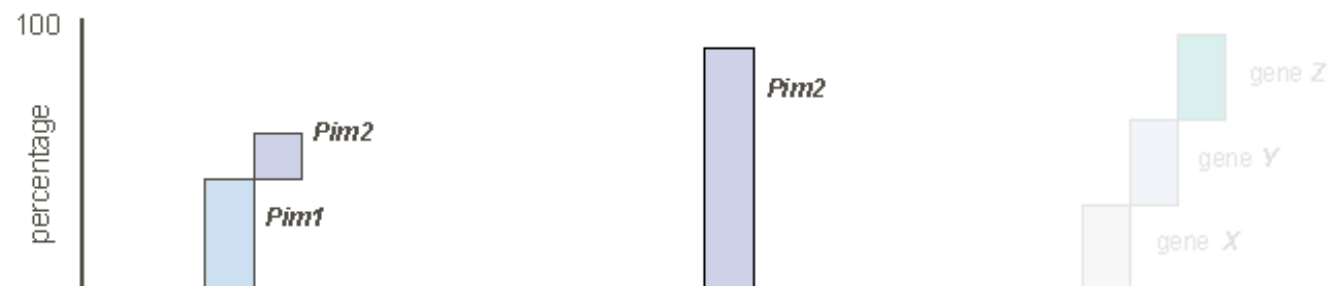
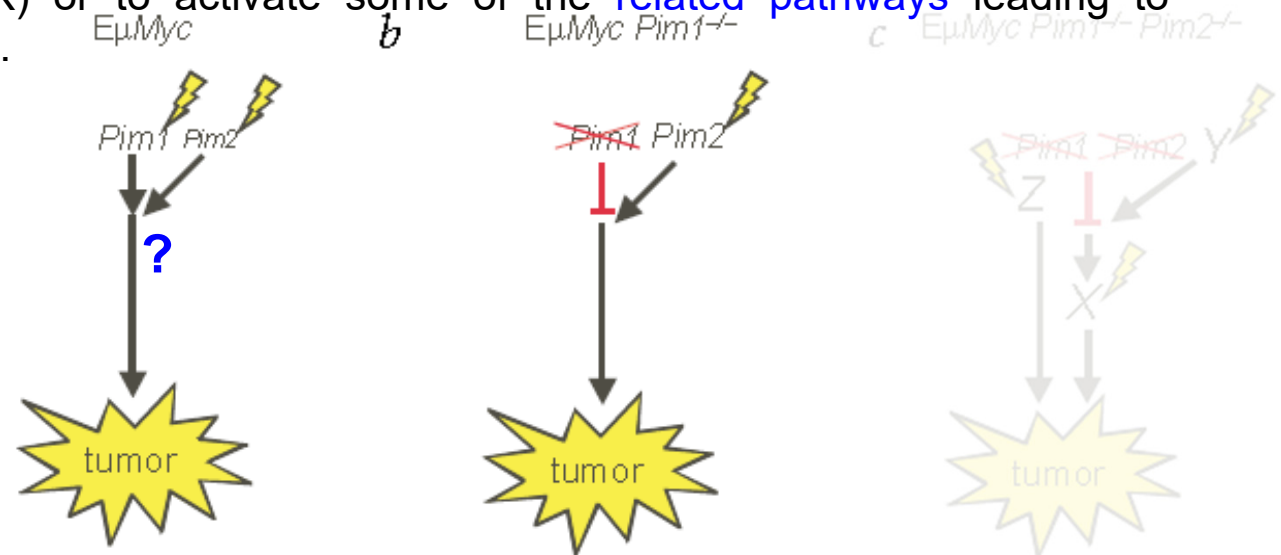

Insertional mutagenesis in forward genetics approaches

- Isolation of genomic regions adjacent to the insertion site of the provirus
 - Cleavage of genomic DNA and ligation of special linkers, so-called *splinkerettes* (increasing the specificity of amplification)

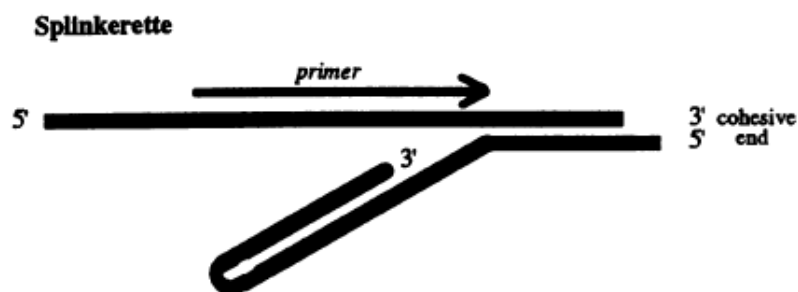

Devon et al., Nucl Acid Res (1994)

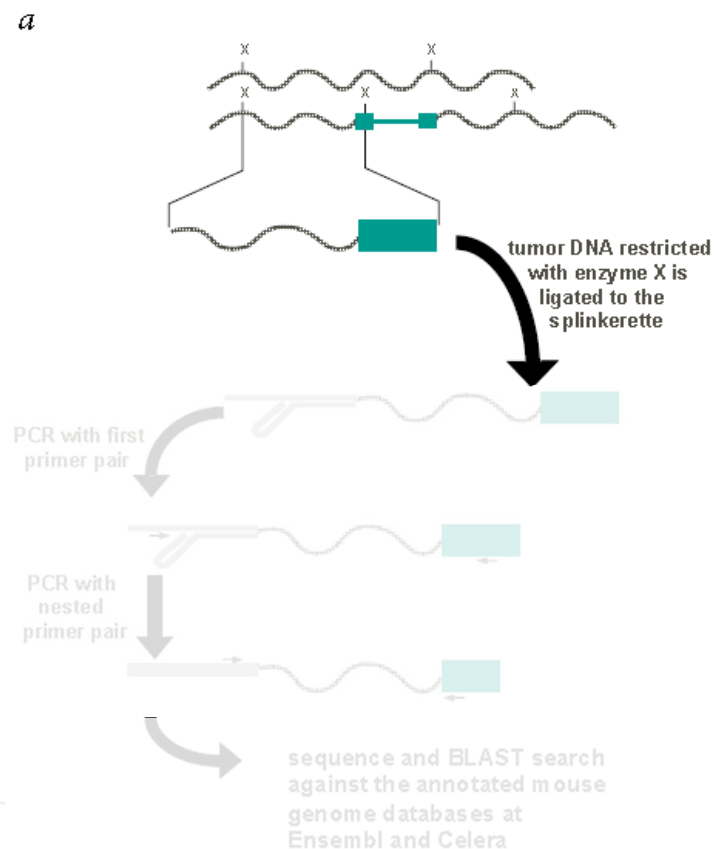

Mikkers et al., Nature Gen (2002)

Insertional mutagenesis in forward genetics approaches

- Isolation of genomic regions adjacent to the insertion site of the provirus
 - First amplification using specific primers

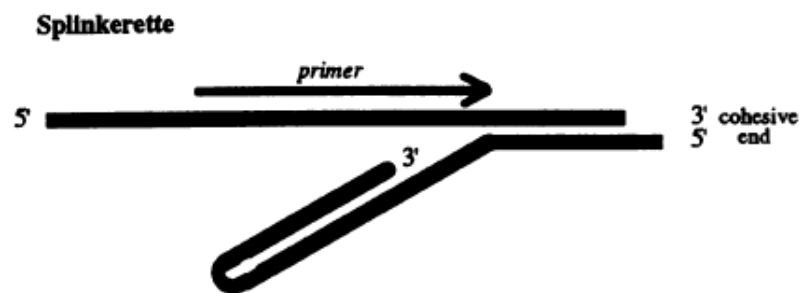

Devon et al., Nucl Acid Res (1994)

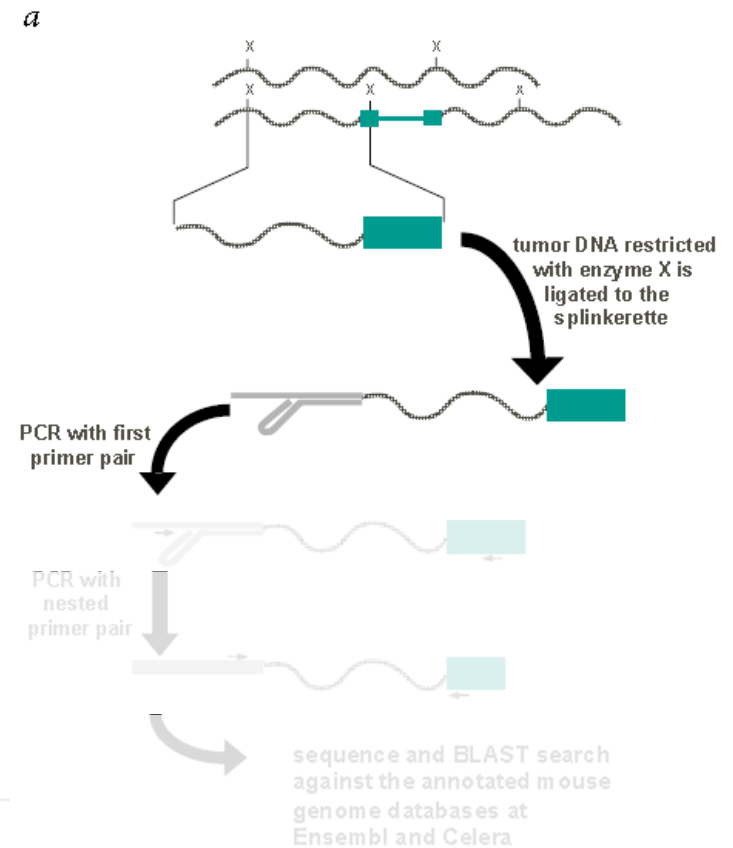

Mikkers et al., Nature Gen (2002)

Insertional mutagenesis in forward genetics approaches

- Isolation of genomic regions adjacent to the insertion site of the provirus
 - Second amplification using **nested primers** (increasing the specificity)

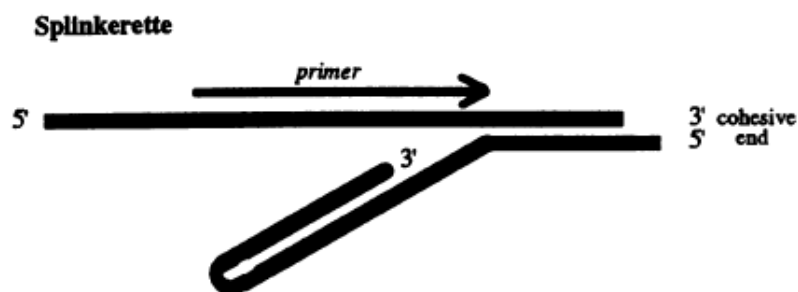

Devon et al., Nucl Acid Res (1994)

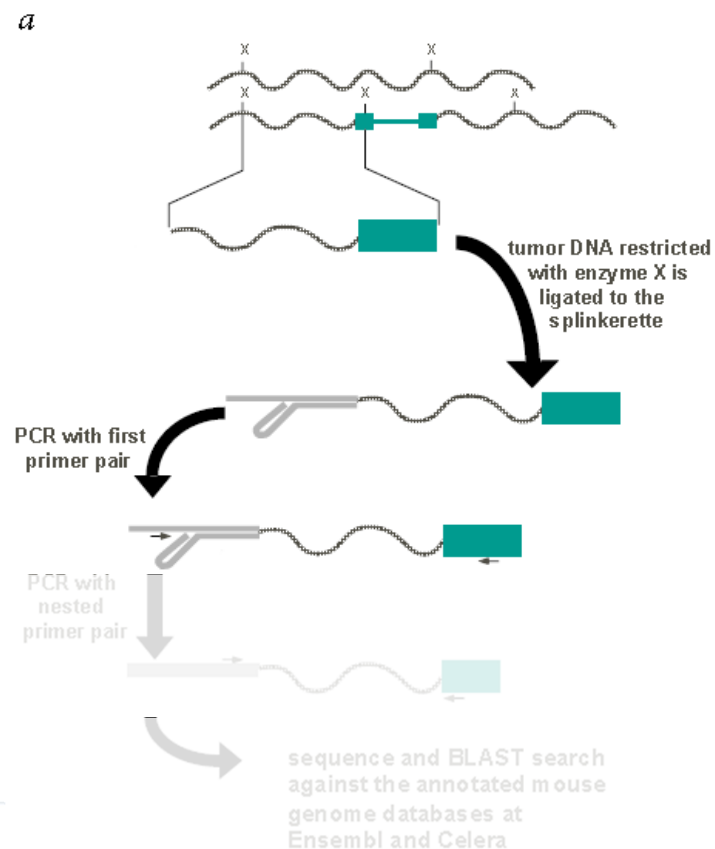

Mikkers et al., Nature Gen (2002)

Insertional mutagenesis in forward genetics approaches

- Isolation of genomic regions adjacent to the insertion site of the provirus
 - Sequencing and localization of regions adjacent to provirus by searching in annotated databases of mouse genome

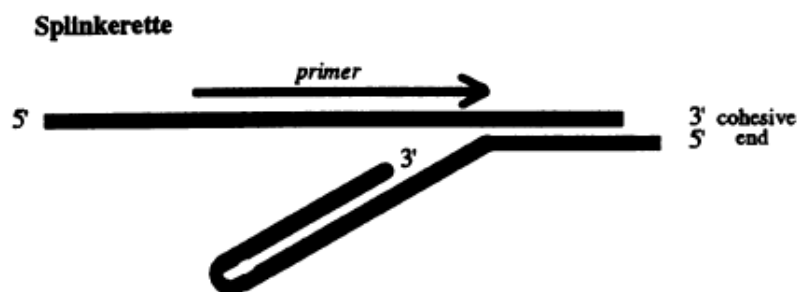

Devon et al., Nucl Acid Res (1994)

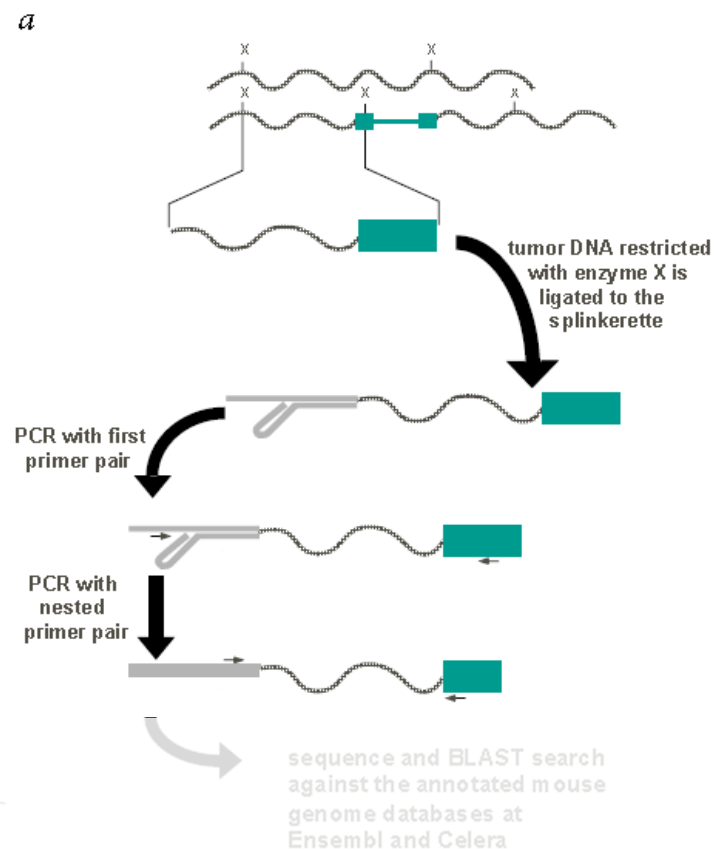

Mikkers et al., Nature Gen (2002)

Outline

- Forward vs. Reverse Genetics
- Use of Libraries of Insertional Mutants in Forward Genetics
 - Searching in Libraries of Insertional Mutants According to:
 - anatomically or morphologically detectable phenotype
 - metabolic profile



INVESTICE DO ROZVOJE VZDĚLÁVÁNÍ

Tato prezentace je spolufinancována
Evropským sociálním fondem
a státním rozpočtem České republiky

Metabolic profiling

- Metabolic profiling of plants
 - Automated analysis of metabolites (up to 25.000) by GC-MS techniques in libraries of T-DNA mutants
 - Identification of interesting (even commercially interesting) mutants

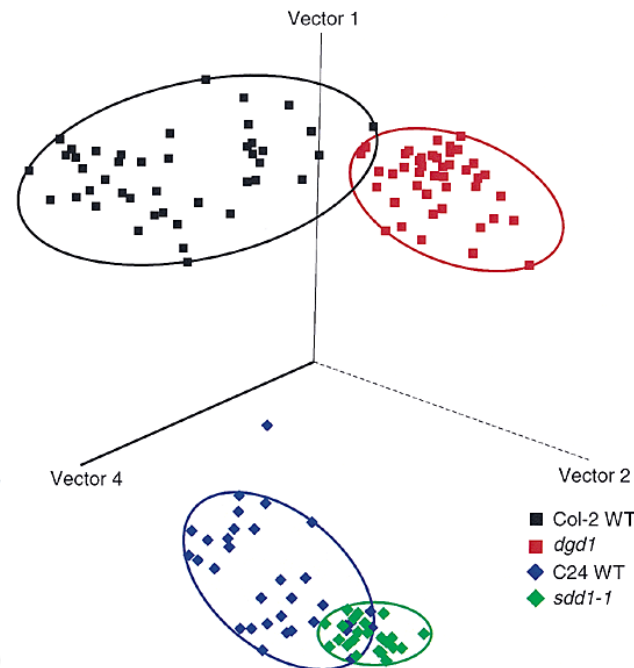

Metabolic profiling

- Metabolic profiling of plants
 - Automated analysis of metabolites (up to 25.000) by GC-MS techniques in libraries of T-DNA mutants
 - Identification of interesting (even commercially interesting) mutants
 - Fast and easy isolation of genes through identification of sequences adjacent to T-DNA



Metabolic profiling

- Metabolic profiling of plants
 - Possibility to use special techniques, e.g. [microdissection](#)

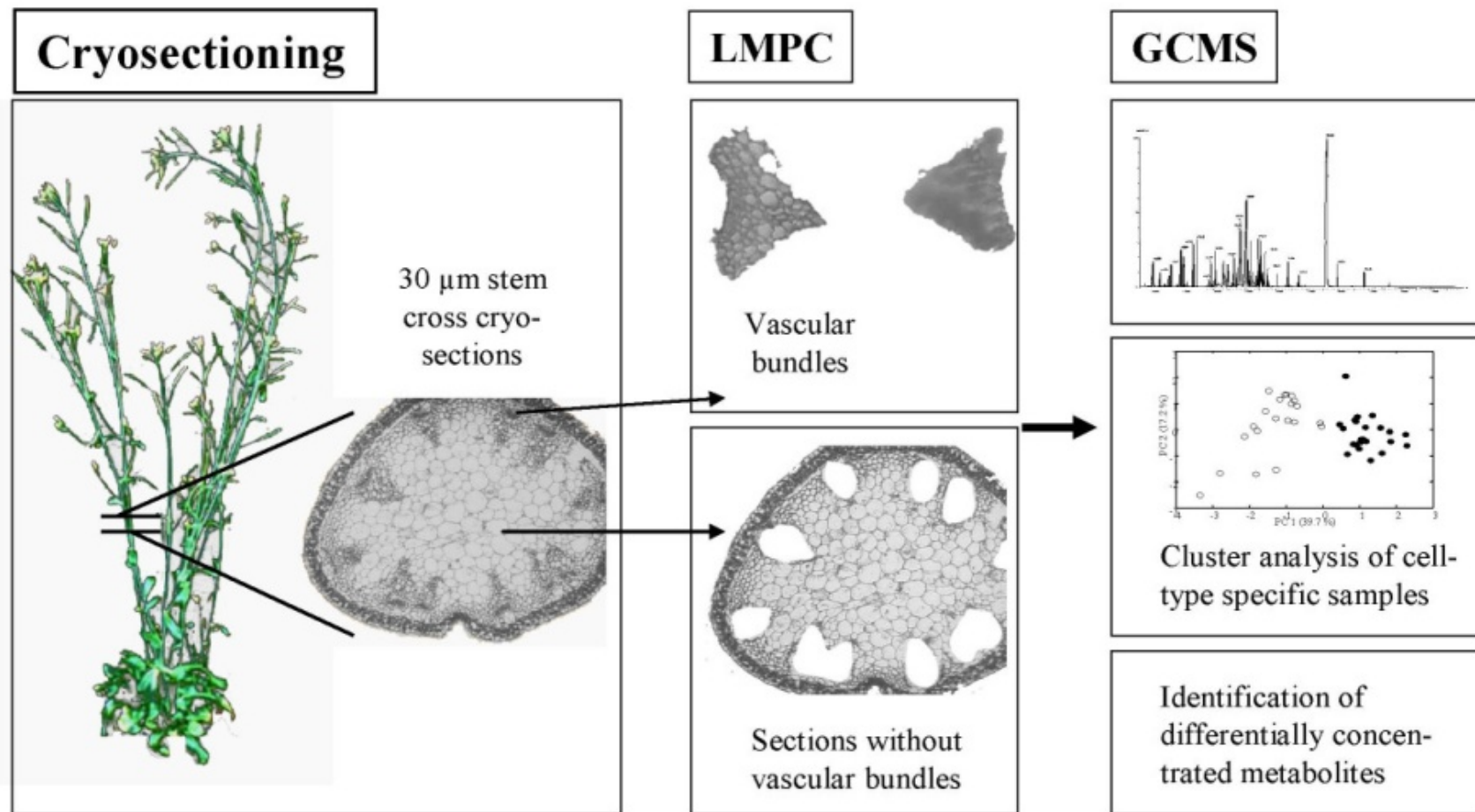

Outline

- Forward vs. Reverse Genetics
- Use of Libraries of Insertional Mutants in Forward Genetics
 - Searching in Libraries of Insertional Mutants According to:
 - anatomically or morphologically detectable phenotype
 - metabolic profile
 - expression of genes of interest

Expression profile

- Identification of mutants with a change in the expression profile
 - Analysis of *expression profile (pattern)* of the gene and identification of mutants with altered expression pattern

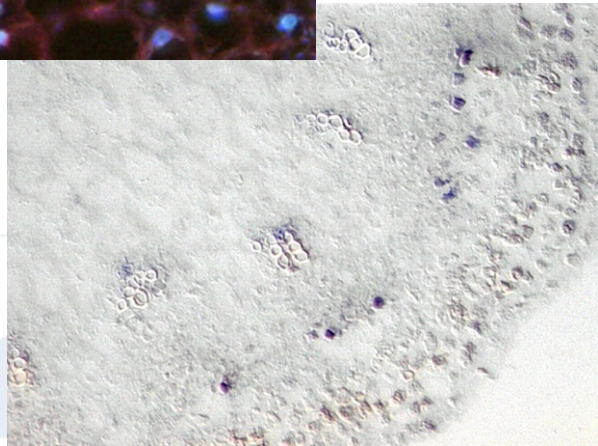
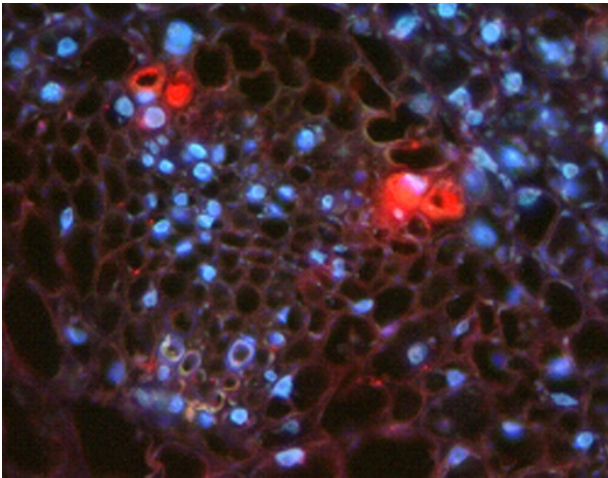

Expression profile

- Identification of mutants with a change in the expression profile
 - Analysis of *expression profile* (*pattern*) of the gene and identification of *mutants with altered expression pattern*
 - Possibility of *partial automation* (virtual digital microscopy)

Automated Microscopy Screening

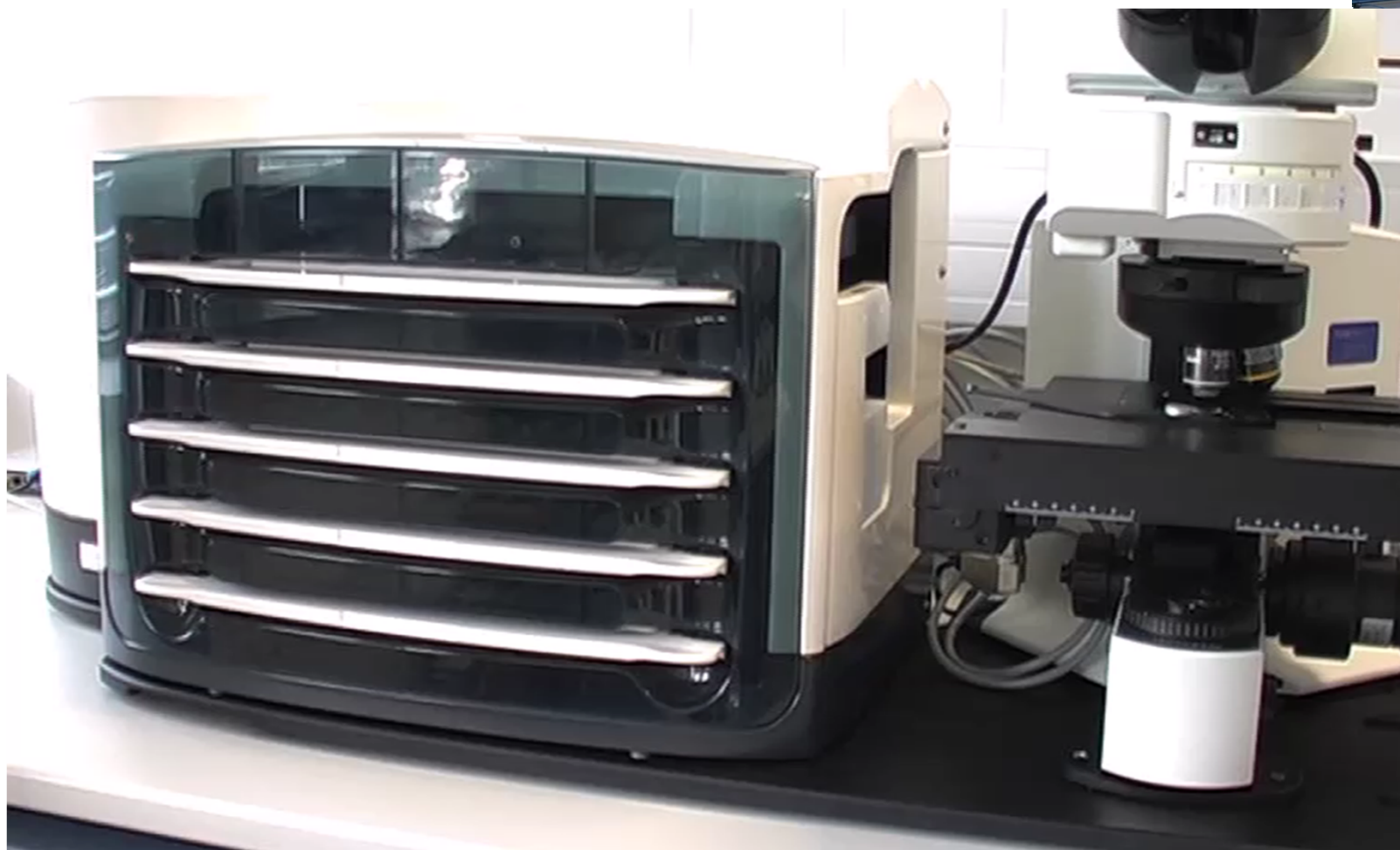

Expression profile

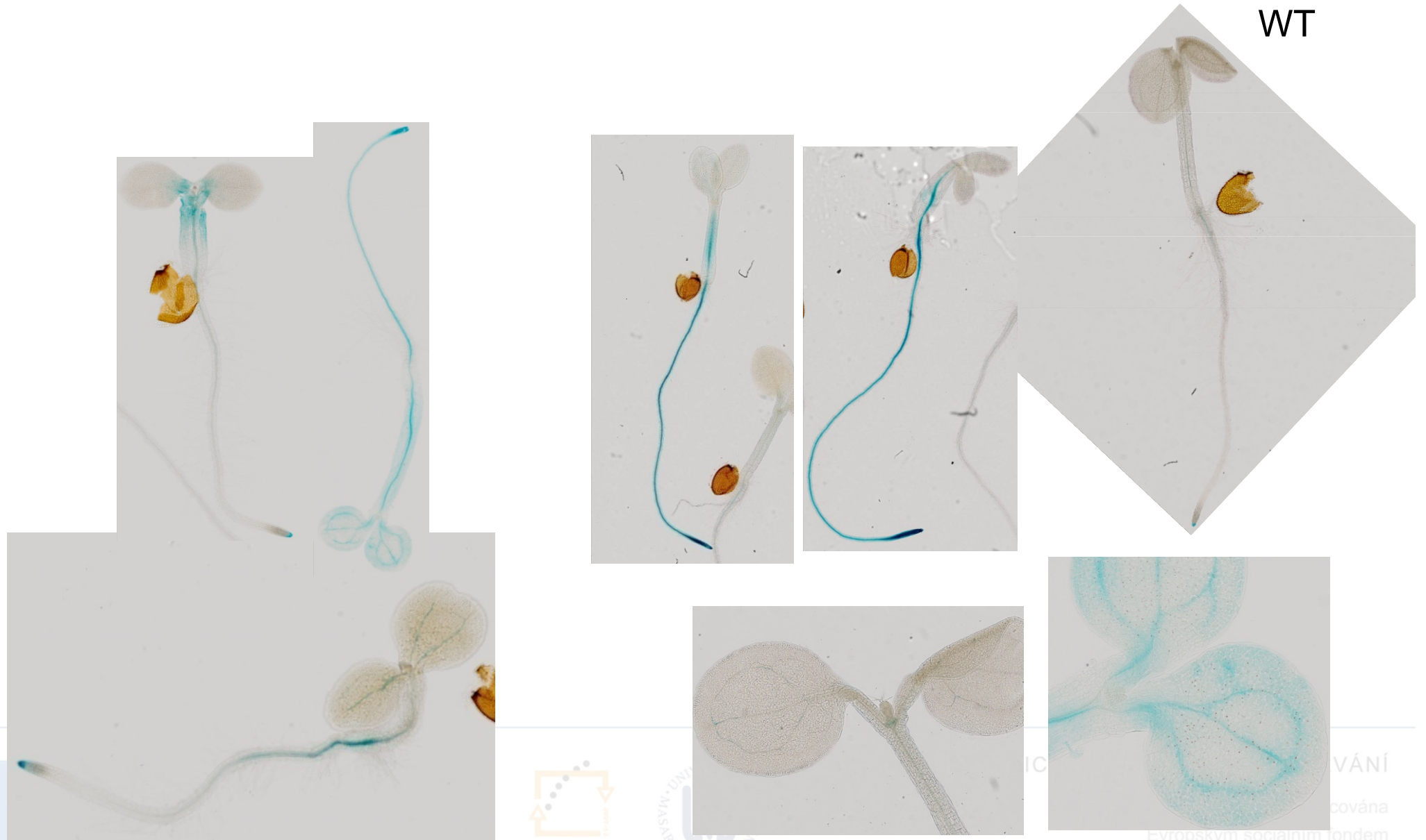

Outline

- Forward vs. Reverse Genetics
- Use of Libraries of Insertional Mutants in Forward Genetics
 - Searching in Libraries of Insertional Mutants According to:
 - anatomically or morphologically detectable phenotype
 - metabolic profile
 - expression of genes of interest
 - Identification of the Mutated Locus
 - plasmid rescue
 - iPCR

Identification of mutated locus

- Identification of chromosomal rearrangements responsible for bushy phenotype of *Arabidopsis*
 - Description of phenotype



INVESTICE DO ROZVOJE VZDĚLÁVÁNÍ

Tato prezentace je spolufinancována
Evropským sociálním fondem
a státním rozpočtem České republiky

Identification of mutant

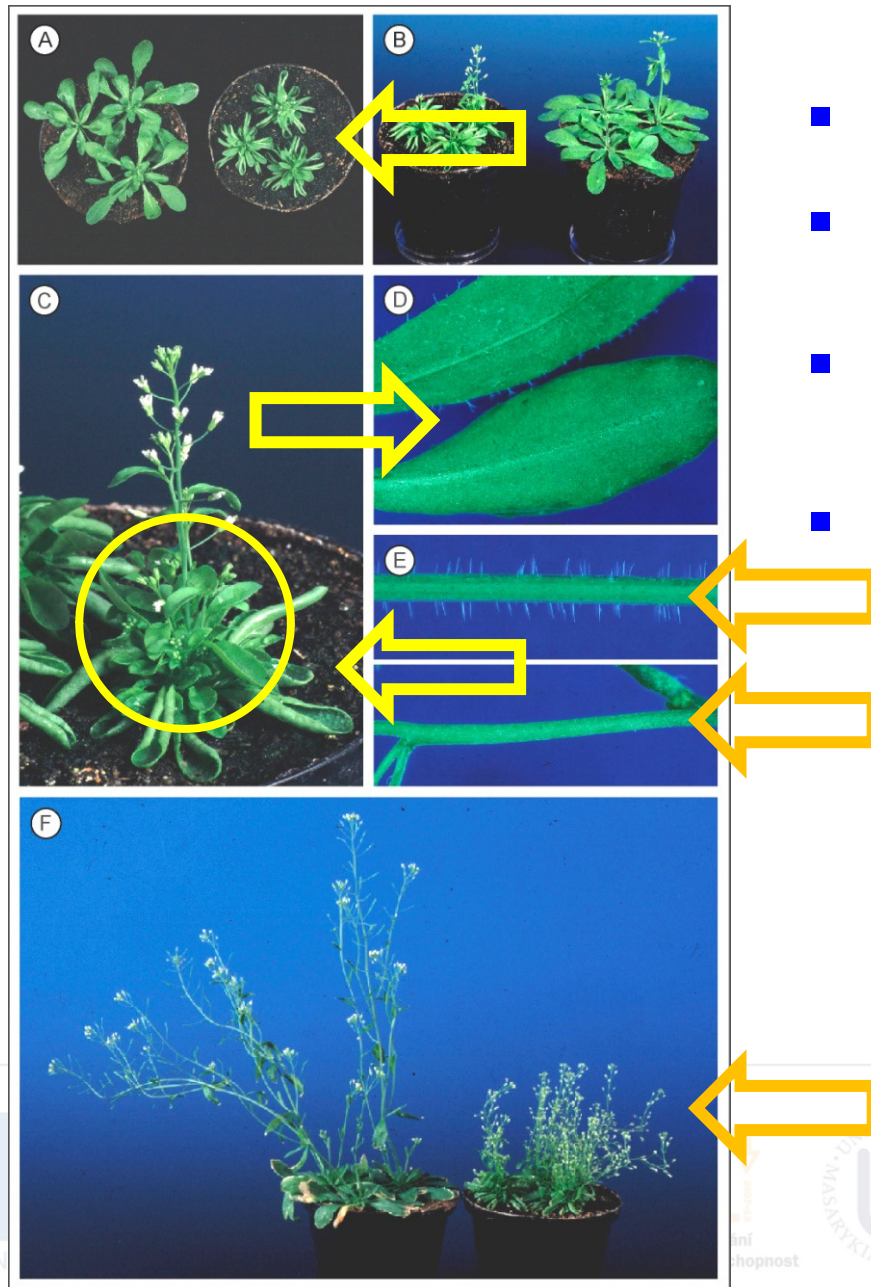

- Crinkled leaves
- Bushy phenotype (branching defective)
- No trichomes on leaves and stems
- Late senescence

Identification of mutant

- Male sterility, defects in stamen filament elongation (A,B)
(compare with wild type C)

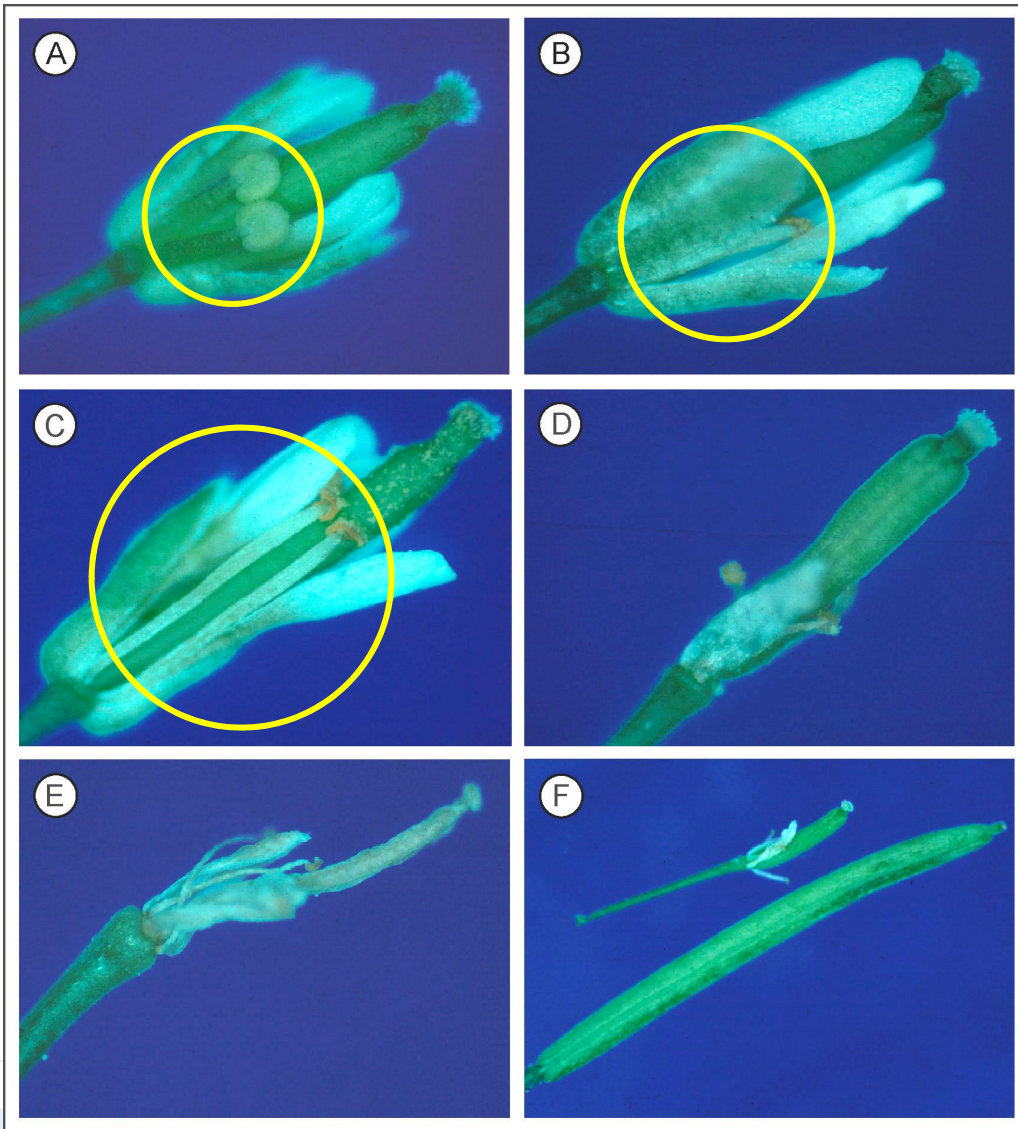

Identification of mutated locus

- Identification of chromosomal rearrangements responsible for bushy phenotype of *Arabidopsis*
 - Description of phenotype
 - Identification of T-DNA mutated region

Identification of mutated locus

1. Identification of region of genomic DNA adjacent to the *left border* using *plasmid rescue*

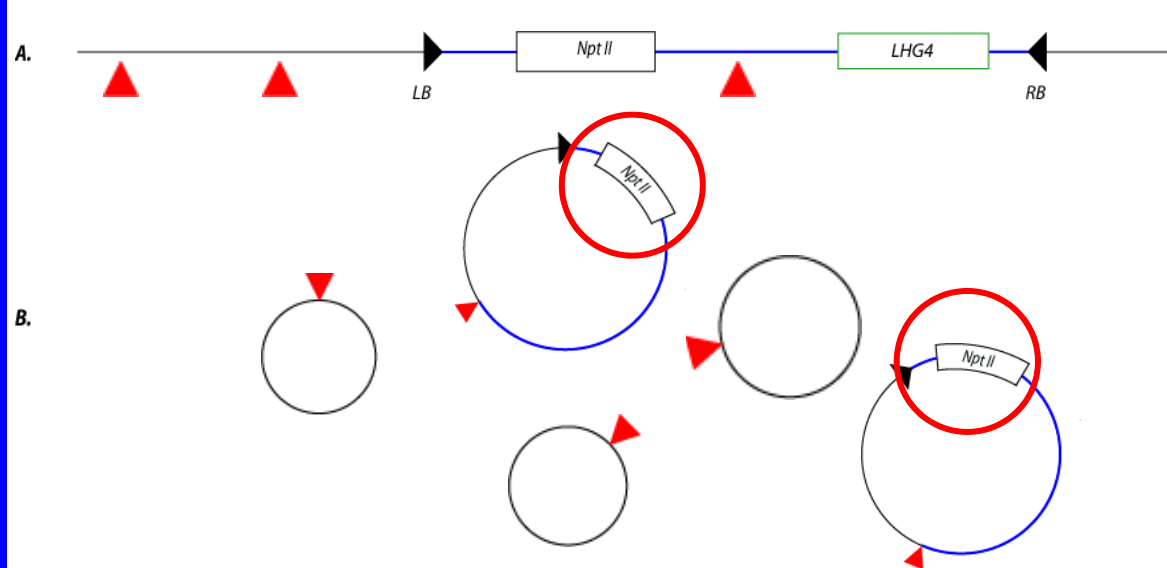

- Restriction digestion (*EcoRI*) of mutant genomic DNA
- Religation and transformation of *E. coli*
- Isolation of plasmid DNA from positively selected clones
- Identified sequence was identical to gene for *NAD7* coded by mtDNA

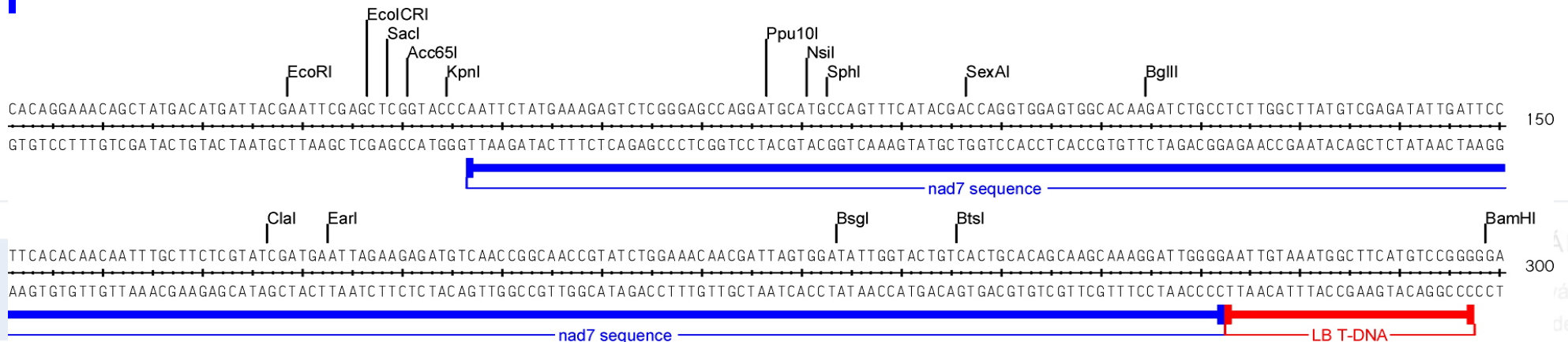

Identification of mutated locus

2. Identification of region of genomic DNA adjacent to the *right border* using *inversion PCR* (iPCR)

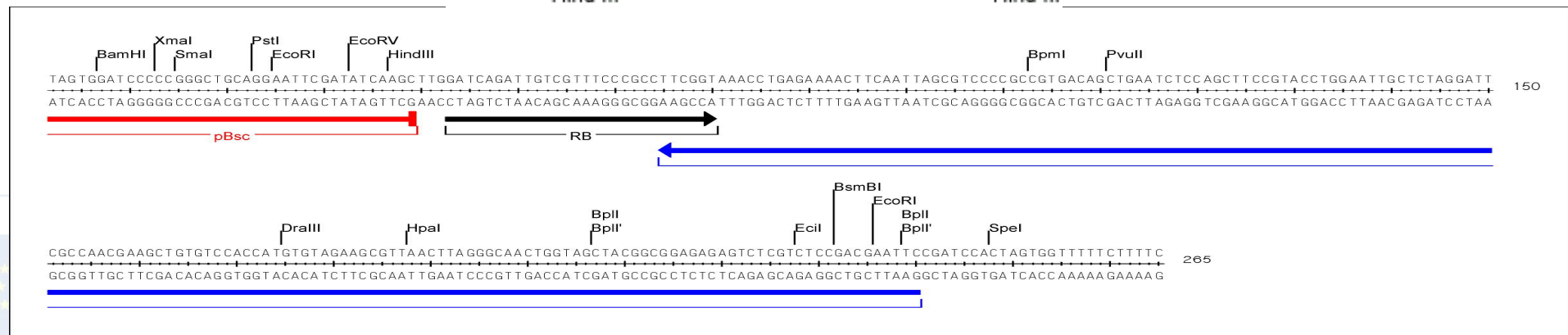
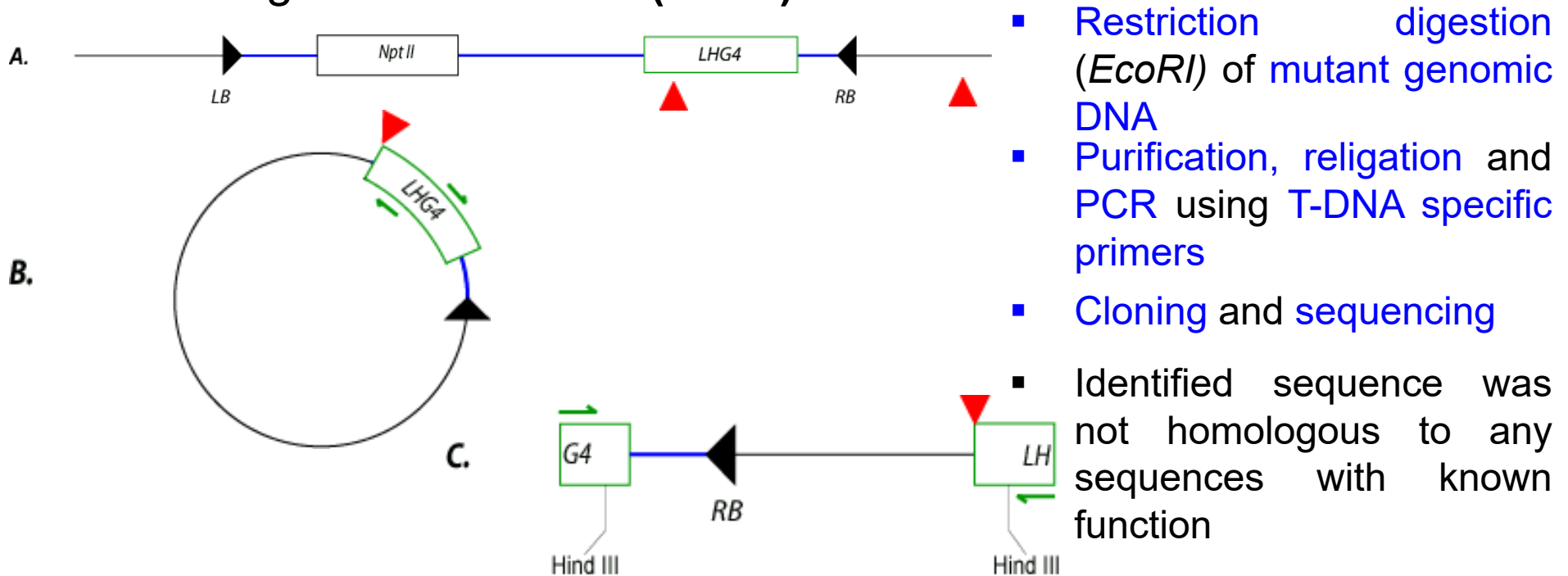

Identification of mutated locus

- Identification of chromosomal rearrangements responsible for bushy phenotype of *Arabidopsis*
 - Description of phenotype
 - Identification of T-DNA mutated region
 - Localization of T-DNA insertion site in *Arabidopsis* genome



INVESTICE DO ROZVOJE VZDĚLÁVÁNÍ

Tato prezentace je spolufinancována
Evropským sociálním fondem
a státním rozpočtem České republiky

Searching in library IGF-BAC

- Genome library containing 10.752 clones with an average size of an insert of 100 kb
- Bacterial clones arranged in the microtiter plates
- Library loaded onto nylon filters for hybridization with the radiolabeled probe

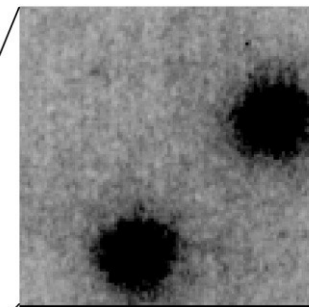
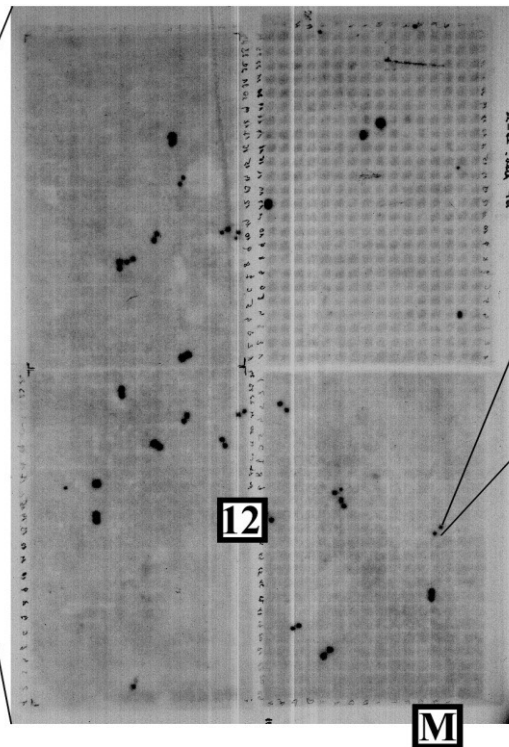

F12M5

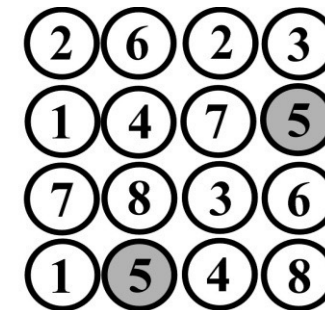

Mapping with IGF-BAC database

I. Sequences adjacent to the left border of T-DNA

- 28 positively hybridizing clones in total
- 19 of them located on chromosome 2
- 18 of them similar with mtDNA

II. Sequences adjacent to the right border of T-DNA

- 6 positively hybridizing clones in total
- all of them located on chromosome 2

Localization of genomic T-DNA adjacent to both left and right T-DNA borders on chromosome 2

Sequences adjacent to *right* and *left* border of T-DNA

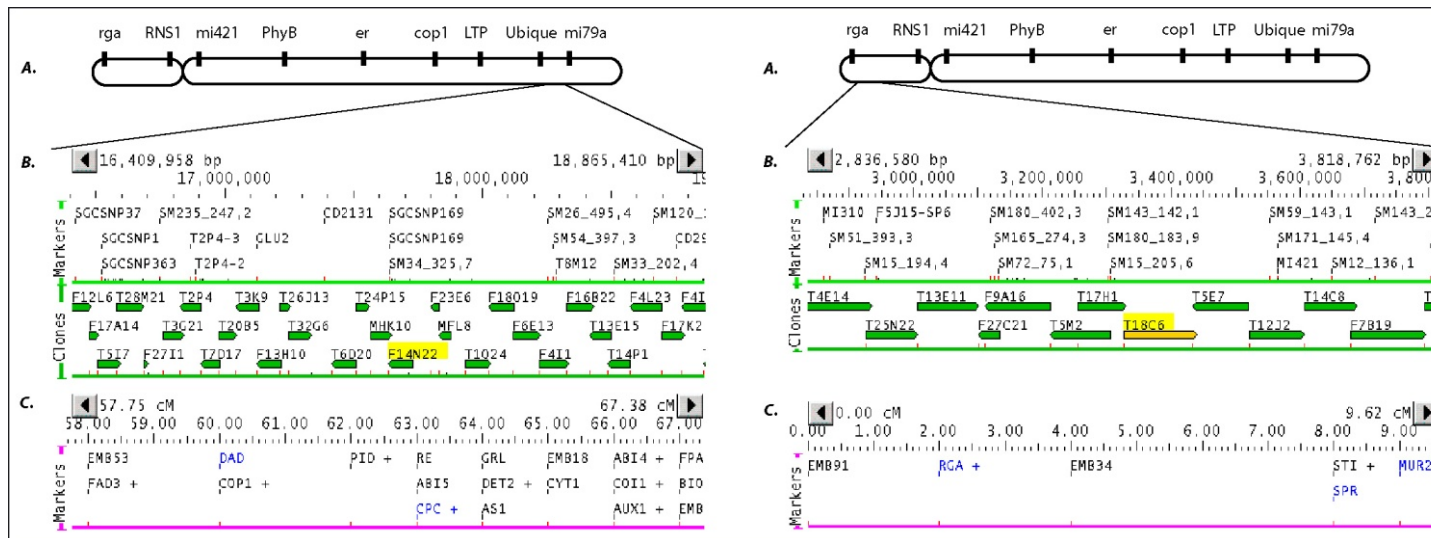

- There was probably an inversion of almost entire chromosome 2

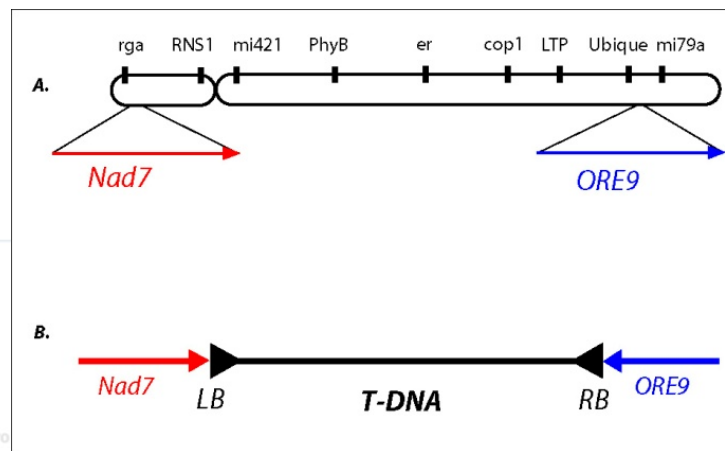

Outline

- Forward vs. Reverse Genetics
- Use of Libraries of Insertional Mutants in Forward Genetics
 - Searching in Libraries of Insertional Mutants According to:
 - anatomically or morphologically detectable phenotype
 - metabolic profile
 - expression of genes of interest
 - Identification of the Mutated Locus
 - plasmid rescue
 - iPCR
- Use of Libraries of Point Mutants in Forward Genetics
 - Positional Cloning

Identification of mutated locus

■ Positional cloning

- Principle: **co-segregation analysis** of **segregating population** (mostly of offspring of backcrosses) with **molecular markers**
- **SSLP** (**S**imple **S**equences **L**ength **P**olymorphism)
 - Polymorphism of genome (PCR products) length, amplified using specific primers
- **RFLP** (**R**estriction **F**ragment **L**ength **P**olymorphism)
 - Detection by Southern blot (PCR after digestion of the genomic DNA and ligation of adapters)
- **CAPS** (**C**leaved **A**mplified **P**olymorphic **S**equences)
 - Restriction fragment length polymorphism, genome segments amplified by PCR
- **RAPD** (**R**andomly **A**mplified **P**olymorphic **D**NA)
 - Polymorphism of length of randomly amplified genome segments, using short 8-10bp primers

Positional cloning

Preparation of mapping population

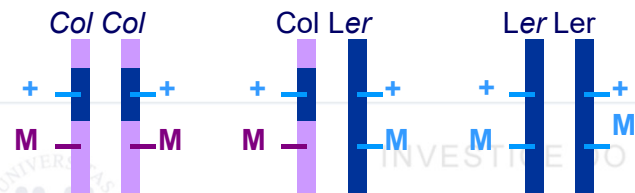
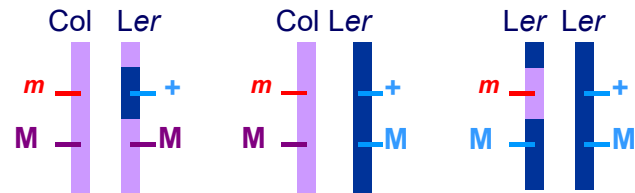
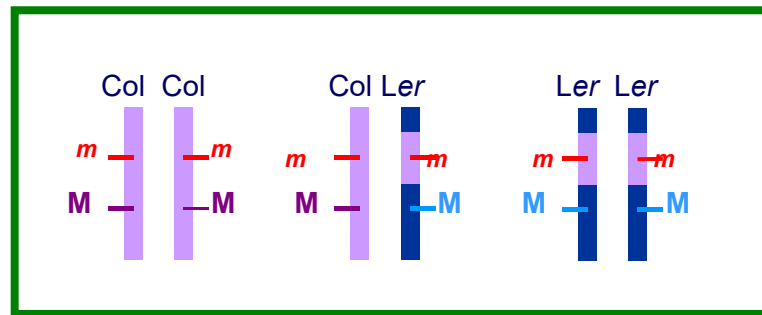
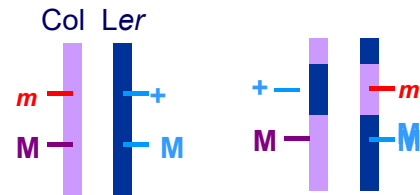
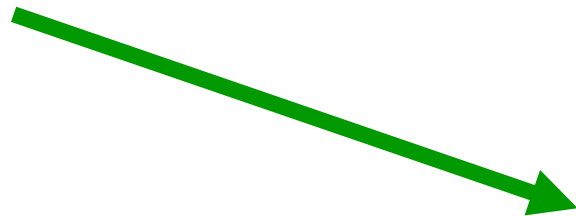

Recombinant analysis – determining the percentage of recombination between mutation and molecular marker

$$r [\%] = \frac{\text{number of chromosomes of Col}}{\text{number of all the chromosomes}} \times 100$$

F2 mutants

Ler Col

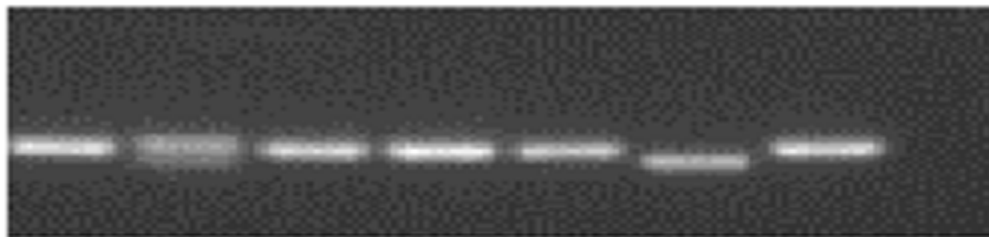

marker I – linked
5 mutants
 $1/10 \times 100 = 10\%$

F2 mutants

Ler Col



marker II - no linkage
6 mutants
 $7/12 \times 100 = 58\%$

- Analysis of approximately 2000 mutant plants
- Determining the closest (still segregating) marker
- Identification of mutation by sequencing

Map of DNA molecular markers

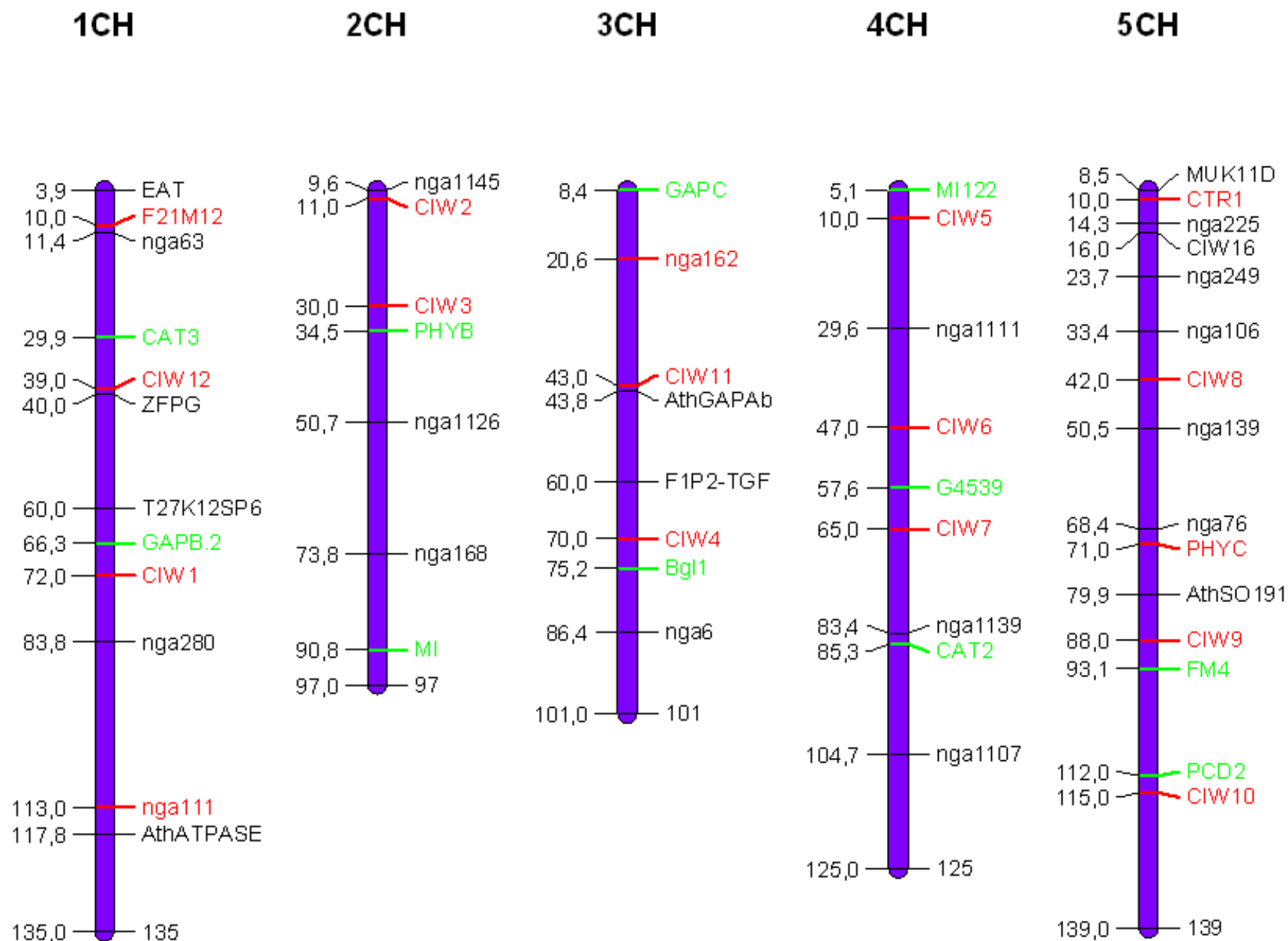

Markers for fine mapping

- AGI Map
- Lister & Dean RI
- Classical
- mi-RFLP
- Goodman
- GoodmanBAC
- TIGR
- Finkelstein
- Altmann

Maps for Chromosome 2

for all Maps: [Search Options:](#)



[MapViewer Home](#)

[Release Note](#)

[View Print-Version](#)

AGI Map

0 1,000,000 2,000,000

Search by name (e.g. UFO)

Select range (e.g. 1500-2000)

[AGI Map color key](#)

Lister & Dean RI

0.00 5.00 10.00

Search by name (e.g. UFO)

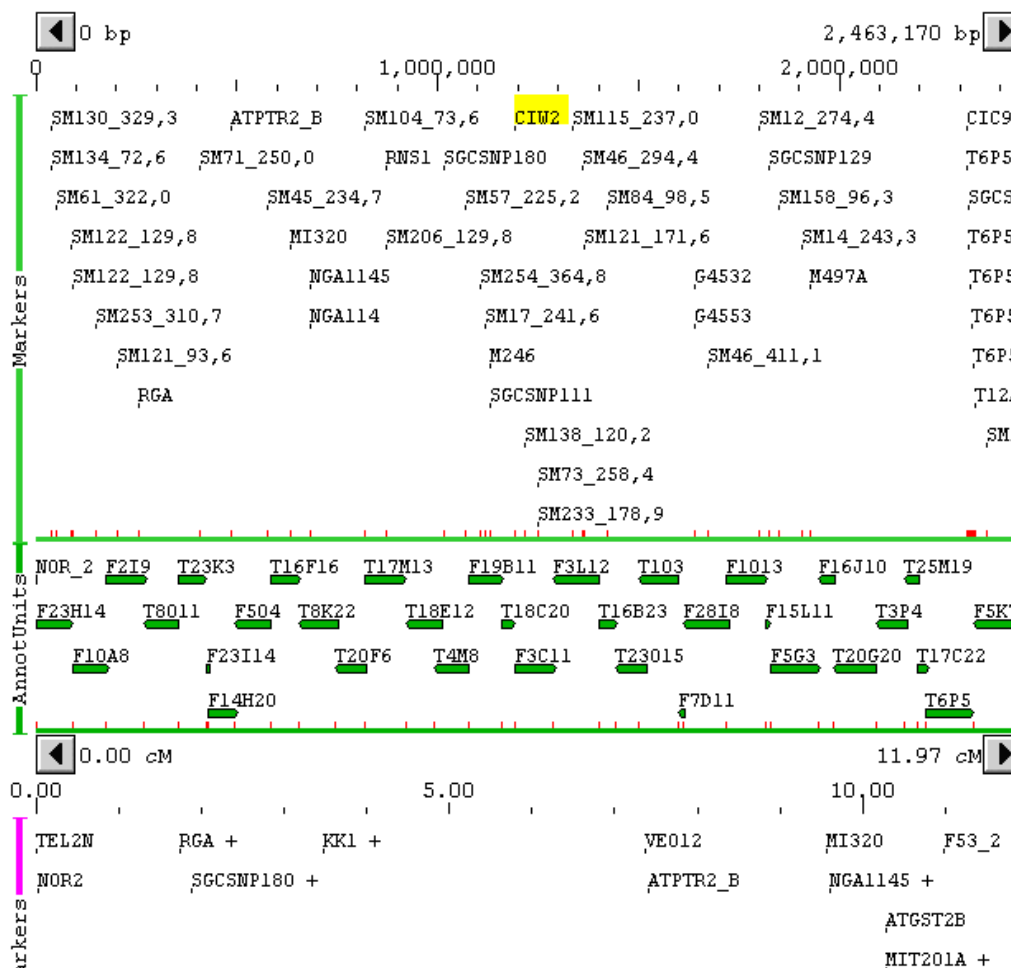

Summary

- Forward vs. Reverse Genetics
- Use of Libraries of Insertional Mutants in Forward Genetics
 - Searching in Libraries of Insertional Mutants According to:
 - anatomically or morphologically detectable phenotype
 - metabolic profile
 - expression of genes of interest
 - Identification of the Mutated Locus
 - plasmid rescue
 - iPCR
- Use of Libraries of Point Mutants in Forward Genetics
 - Positional Cloning

Discussion



INVESTICE DO ROZVOJE VZDĚLÁVÁNÍ

Tato prezentace je spolufinancována
Evropským sociálním fondem
a státním rozpočtem České republiky