

# Chemical properties, structure and interactions of nucleic acids

- DNA structure – basics, Watson-Crick and Hoogsteen base pairing, double helix, alternative structures, DNA superhelicity
- Chemical reactivity of DNA, DNA damage, chemical modification of DNA as a tool for structure/interactions studies
- Non-covalent interactions of DNA, outer-sphere electrostatic interactions, groove binding, intercalation, fundamentals of DNA-protein interactions
- Enzymatic processing of nucleic acids, application of enzymes in structure/interactions studies
- Molecular principles of epigenetic regulations.
- Optical spectroscopic methods - general introduction
- Principles of circular dichroic (CD) spectroscopy
- Advantages and drawbacks of the use of CD spectroscopy to proteins and nucleic acids studies
- Characteristic CD spectra of particular nucleic acids types
- Structural properties of nucleic acids - fresh findings
- Electrochemistry of nucleic acids, electrochemical methods – general introduction, electrochemical activity of DNA, DNA structure at electrically charged surfaces, electrochemical sensing of DNA damage, modification and nucleotide sequences.
- Electrochemistry of proteins – basics and applications

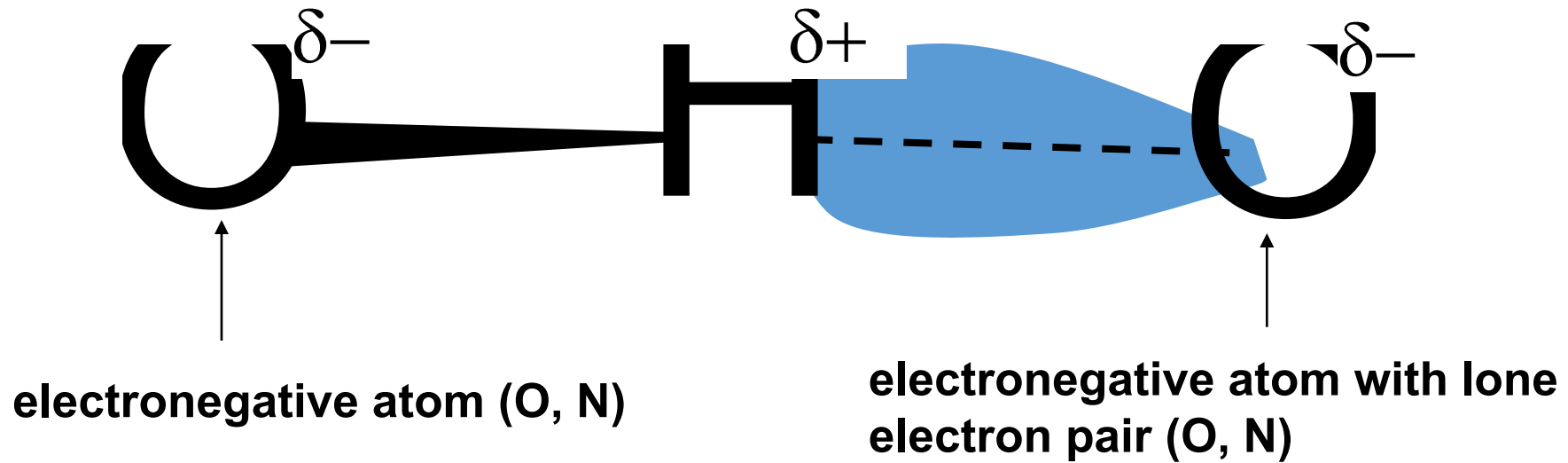
You and chemistry? 😊

# Some basic terms

- hydrogen bond
- ionic interactions
- hydrophobic interactions, stacking
- ester bond
- N-glycosidic bonds
- condensation, hydrolysis
- oxidation, reduction
- electrophile, nucleophile
- tautomers, enol-keto, amino-imino

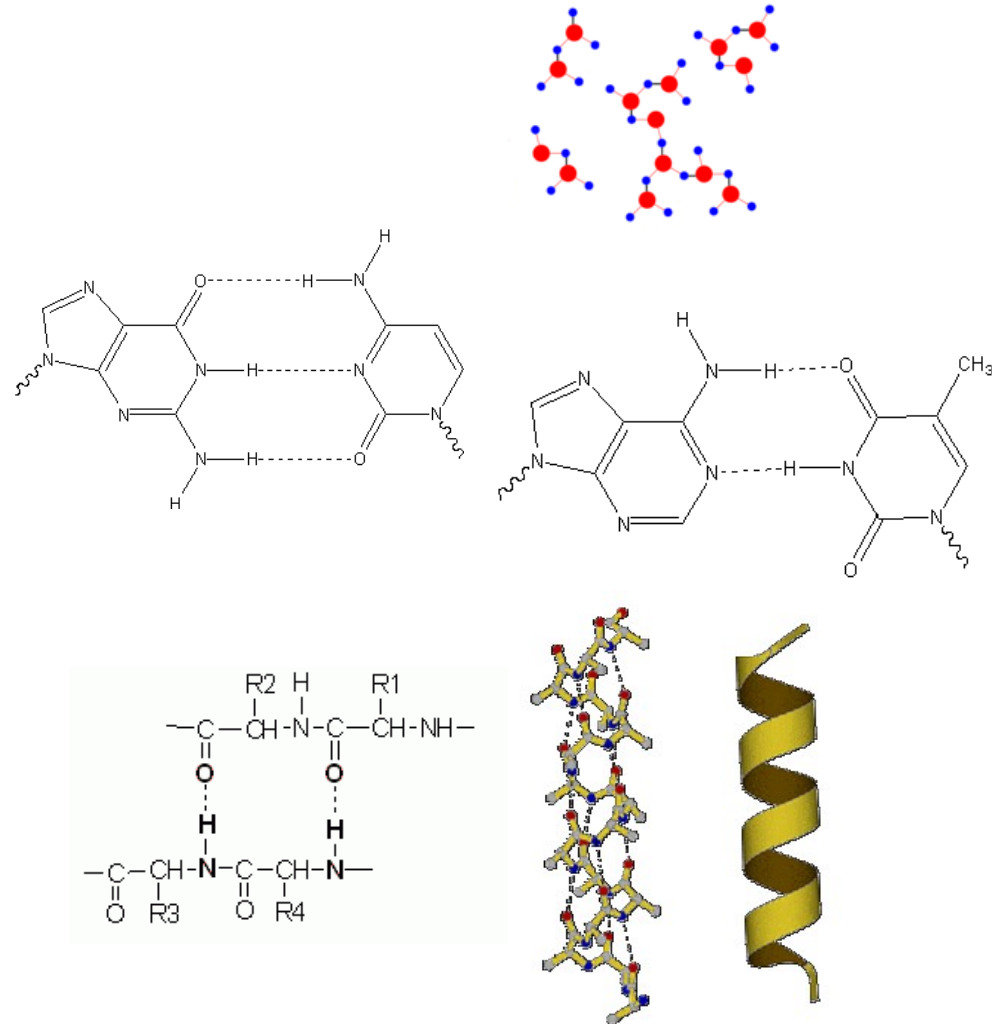
# Hydrogen bond

									4.00		
									He	2	1s
									2		
0.81	He	12.01	He	14.01	He	16.00	He	19.00	He	20.18	He
B	2	C	2	N	2	O	2	F	2	Ne	2
5	1	6	95	7	14	8	25.5	9	10	10	6
											2s
											2p
6.98	Ne	28.09	Ne	30.97	Ne	32.07	Ne	35.45	Ne	39.95	Ne
Al	2	Si	2	P	2	S	2	Cl	2	Ar	2
13	1	14	2	15	0.22	16	0.05	17	0.03	18	6
											3s
											3p

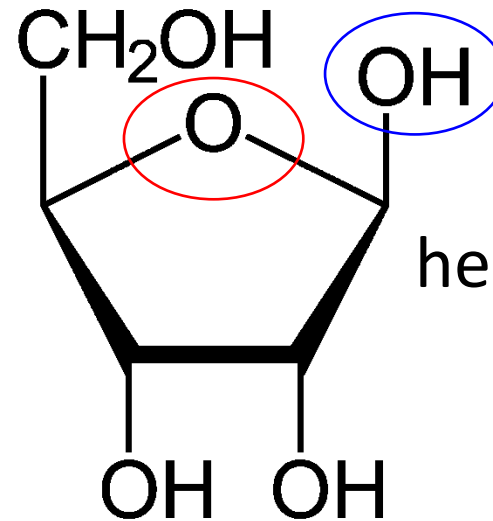
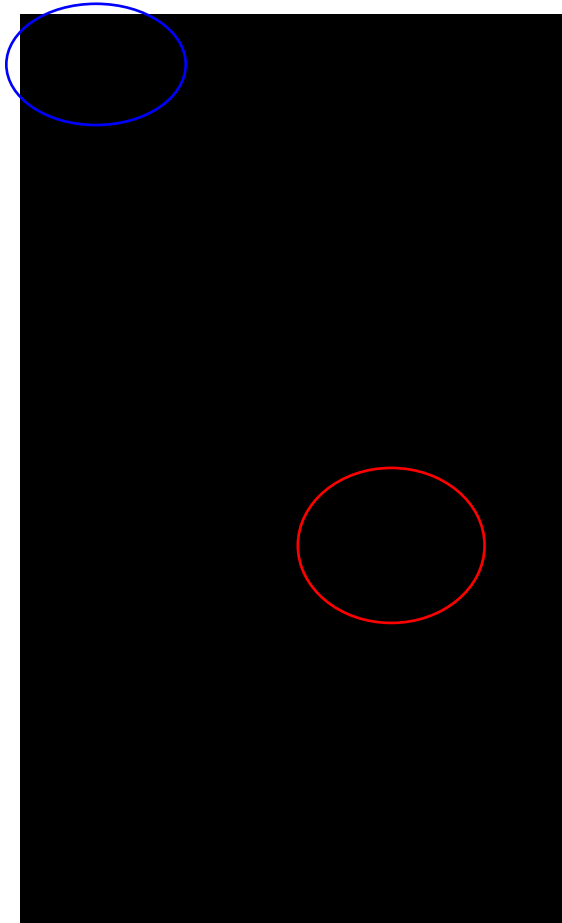


# Hydrogen bond

- crucial importance for biology
- properties of water
- nucleobase pairing
- protein structures
- protein-DNA interactions
- many others



# N-glycosidic bond



anomers:

α (hemiacetal hydroxyl „down“)

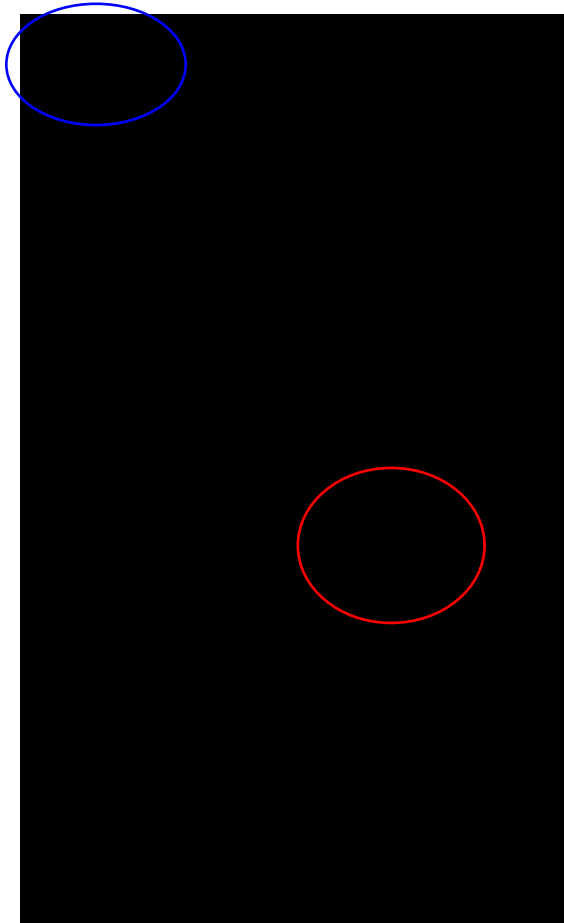
β („up“ as here)

hemiacetal

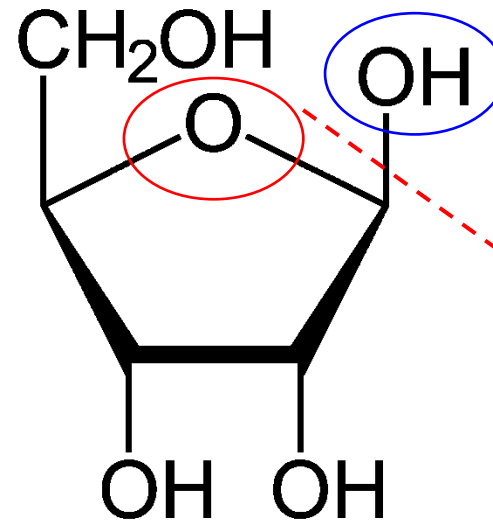
(more exactly: in β anomer the hemiacetal hydroxyl is on the same side of the furanose ring as the -CH<sub>2</sub>OH group)

β-D-ribofuranose

# N-glycosidic bond



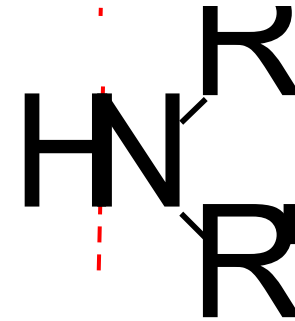
substitution of hemiacetal OH  
(condensation reaction)



$\beta$ -D-ribofuranose

HO-R

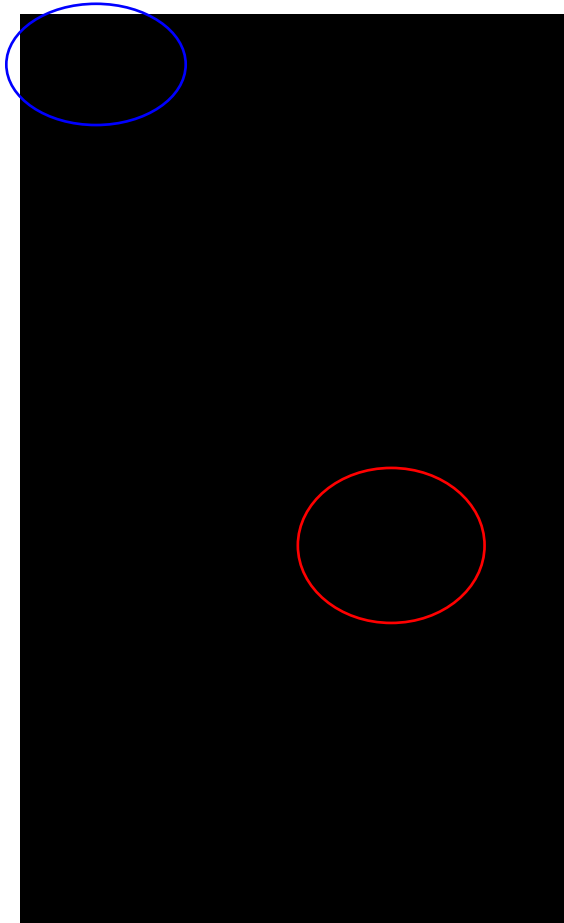
O-glycosides



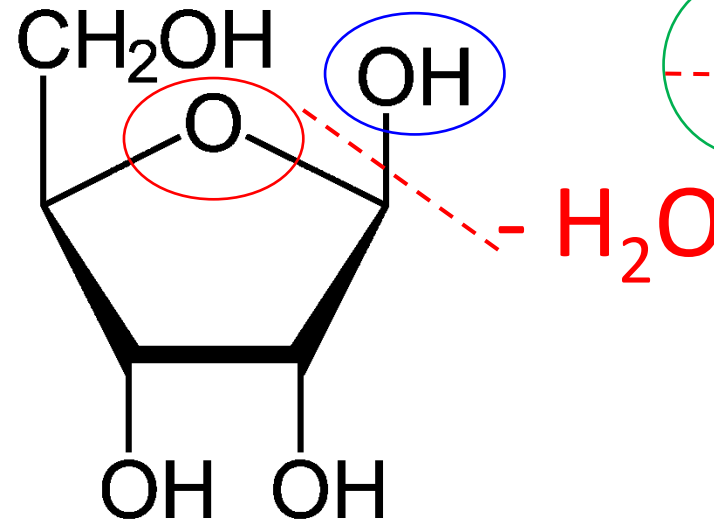
N-glycosides

- H<sub>2</sub>O

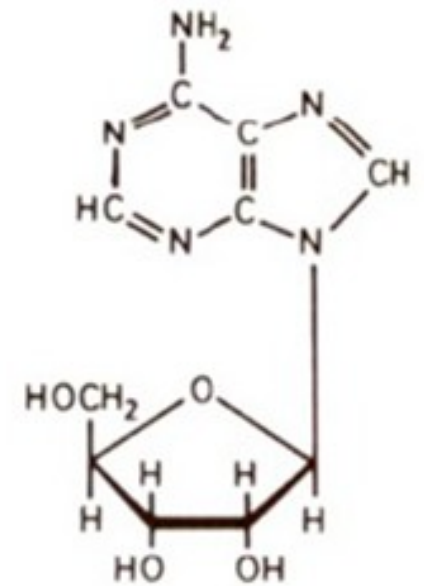
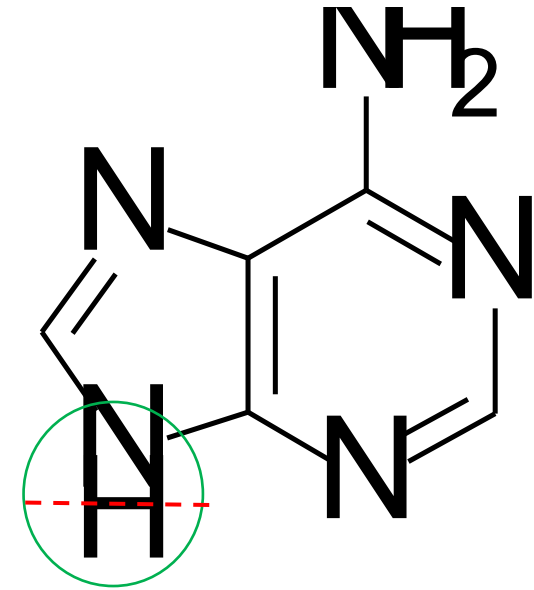
# N-glycosidic bond



nucleoside formation



$\beta$ -D-ribofuranose



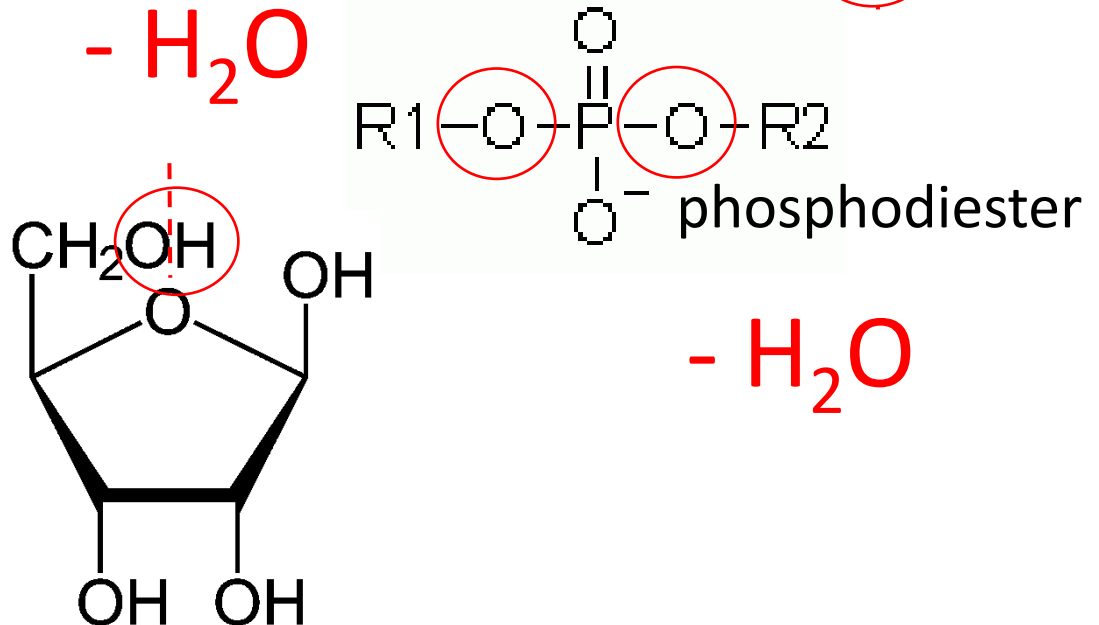
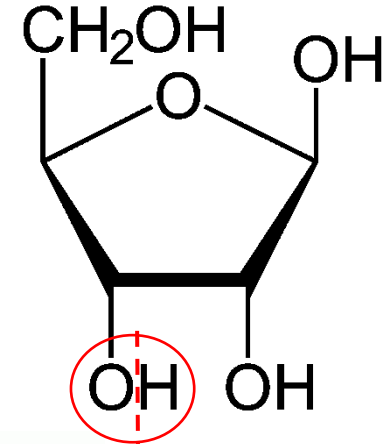
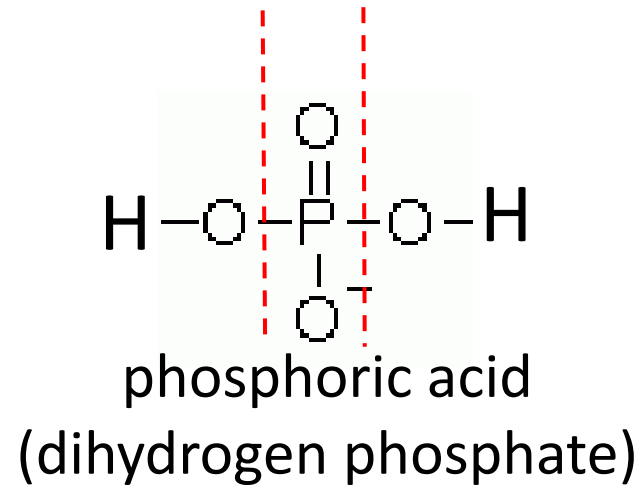
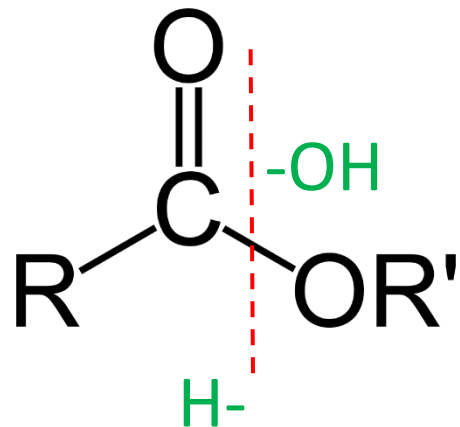
nucleoside

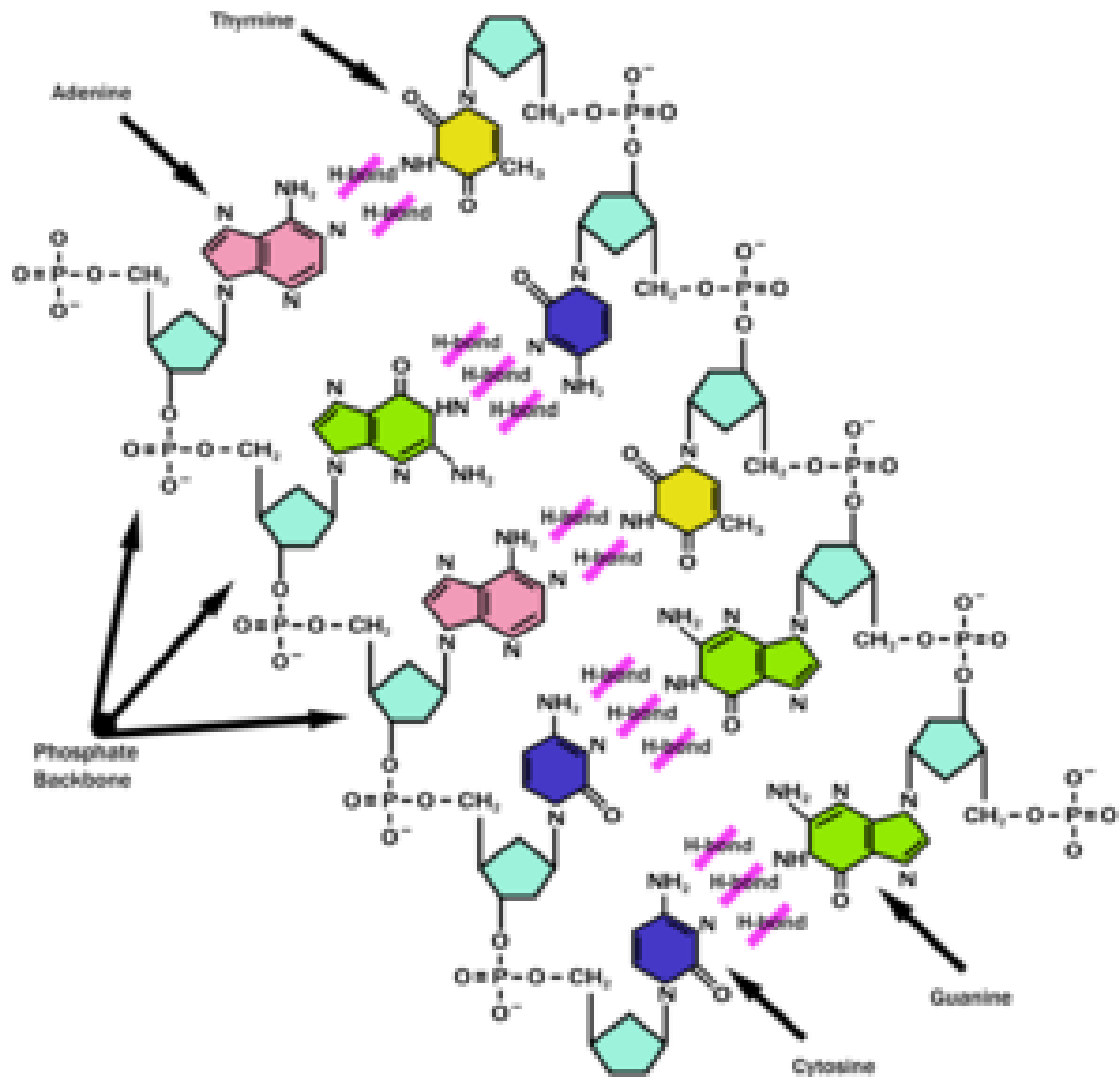


# Ester bonds

- esters: products of condensation of acids with alcohols
- substitution of  $-OH$  of the acid with  $-OR$

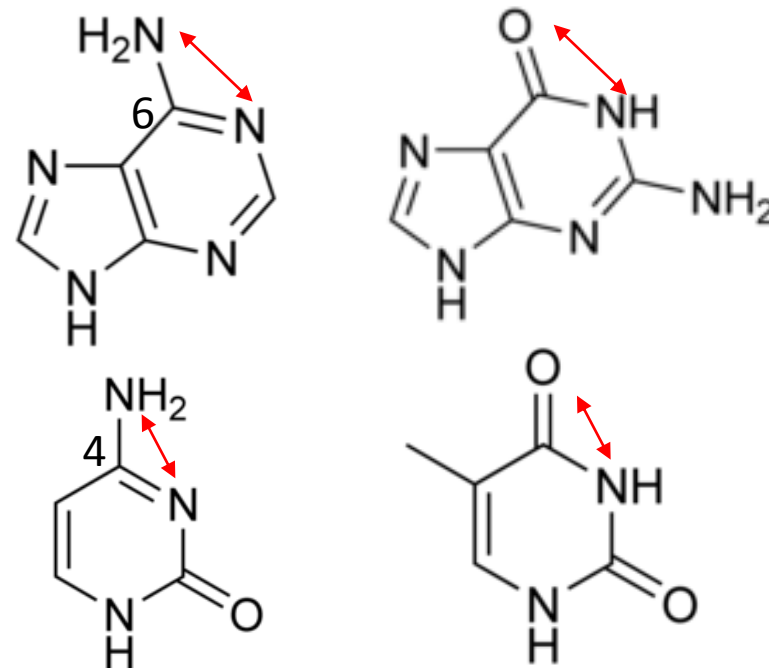
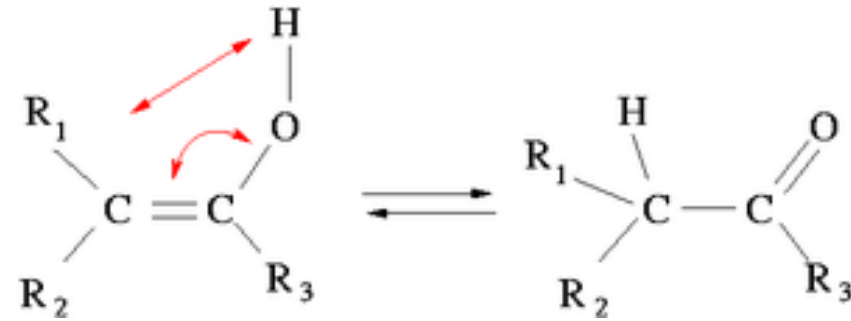
carboxy ester





# Tautomers

- isomers enol-keto, amino-imino
- double bond switch plus hydrogen/proton migration
- in nucleobases: critical effect on pairing properties
- 6-substituents in purines + 4-substituents in pyrimidines: oxygenous=keto, nitrogenous=amino
- hydrogen yes or not on the neighboring ring nitrogen
- relation to chemical mutagenesis

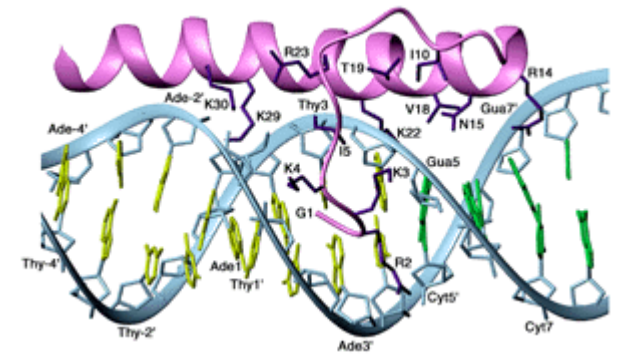
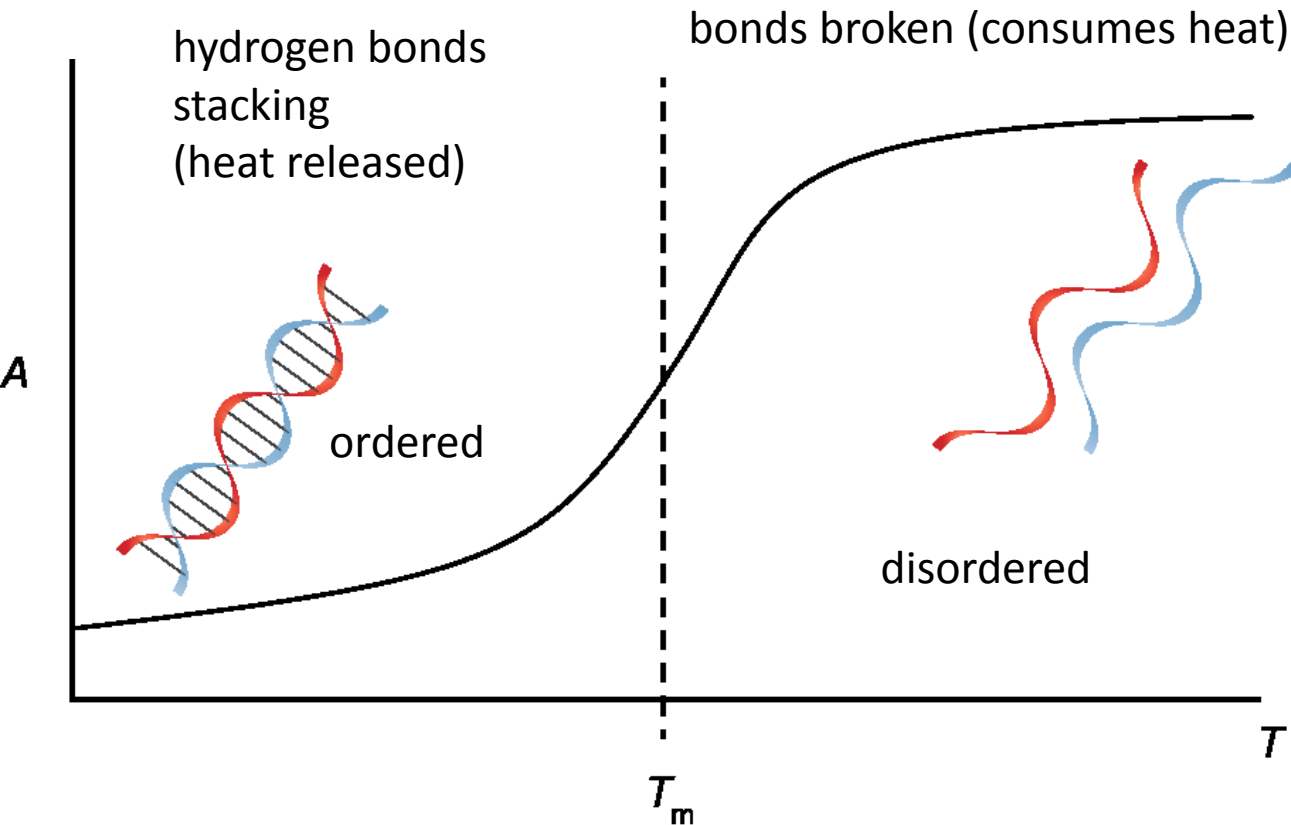
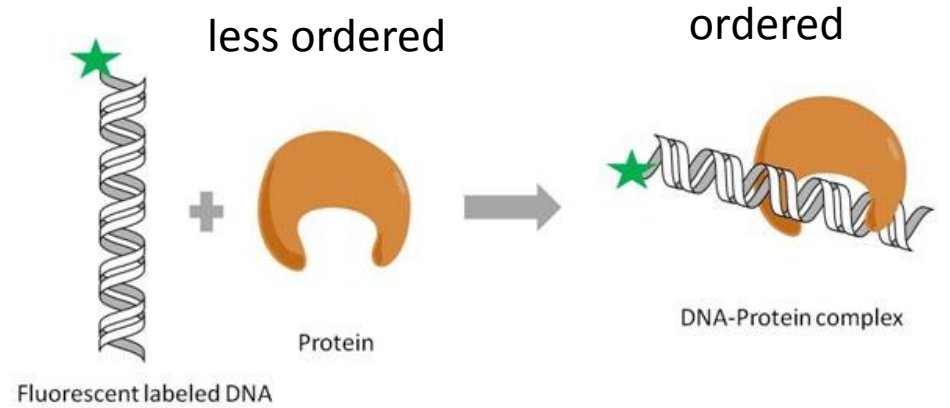


# Energetics of interactions (including structure)

$$\Delta G = \Delta H - T \cdot \Delta S < 0$$

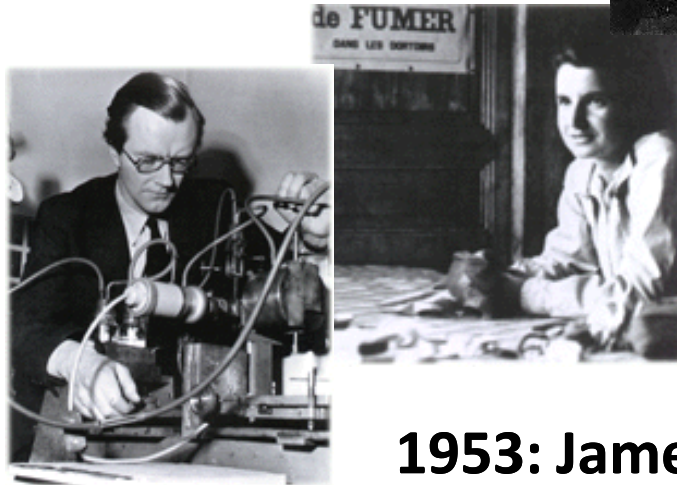
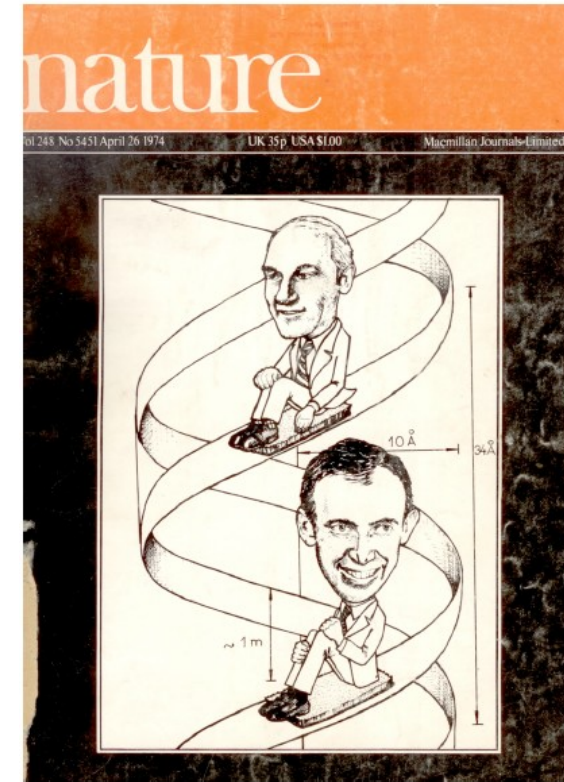
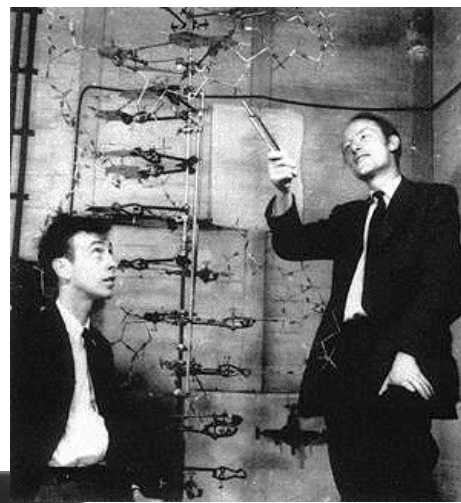
absolute temperature

Gibbs energy      enthalpy (reaction heat)      entropy (disorder)



network of „weak“ bonds– released heat (H-bonds, electrostatic...)

# DNA structure



**1953: James Watson, Francis Crick, Rosalind Franklin, Maurice Wilkins: the DNA double helix**

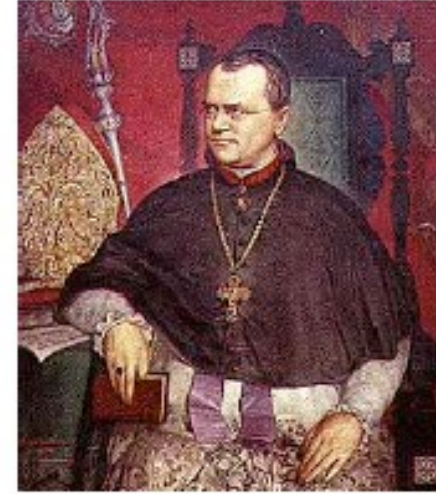
**1962: Nobel Prize (JW, FC, MW)**

**basic principle of the preservation, transfer and expression of genetic information explained**

# Mendel 1864: „elements of heredity“, Mendel laws



Mendel's Medal,  
Moravian Museum, Brno



Abbot G. Mendel



Teachers of Brno gymnasium (High School)

G J MENDEL, priest,  
teacher, scientist and abbot  
in BRNO

# Miescher 1871: discovered „nuclein“, a substance occurring in cell nuclei

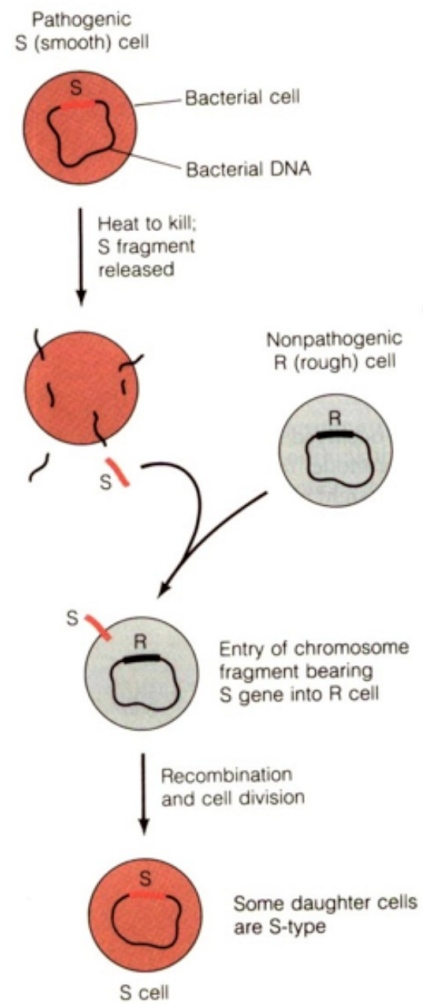


Fig. 5. Glass vial containing nuclein isolated from salmon sperm by Friedrich Miescher while working at the University of Basel. The faded label reads Nuclein aus Lachssperma, F. Miescher (Nuclein from salmon sperm, F. Miescher). Possession of the Interfakult-res Institut fqr Biochemie (Interfaculty Institute for Biochemistry), University of Tübingen, Germany; photography by Alfons Renz, University of Tübingen.



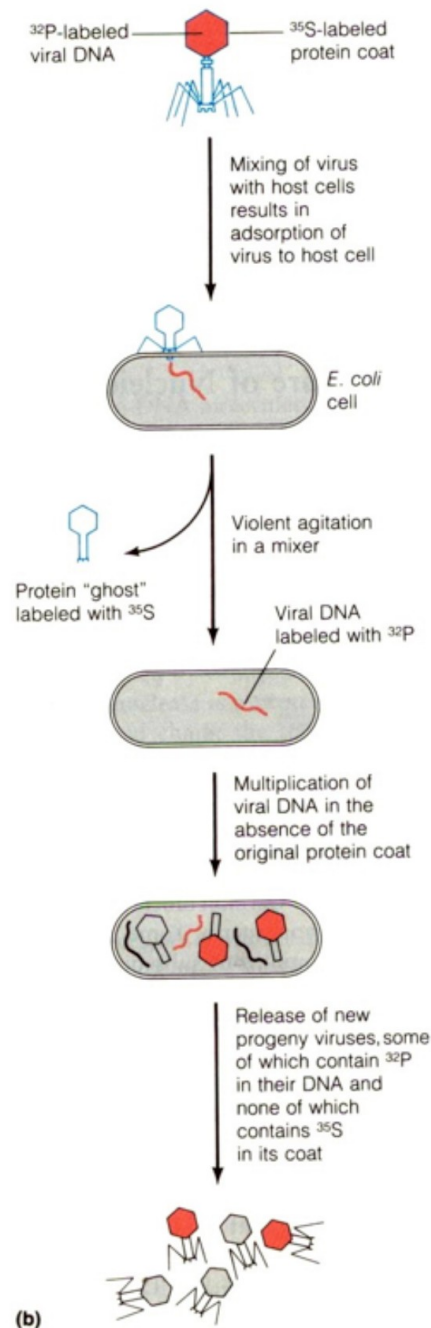


# DNA is the genetic material (1944 Avery, 1952 Hershey)



(a)

**Figure 4.8**  
Crucial experiments that demonstrated DNA as the genetic substance. (a) The experiment of Avery et al. showing that nonpathogenic pneumococci could be made pathogenic by transfer of DNA from a pathogenic strain. (b) The experiment of Hershey and Chase showing that it is transfer of the DNA from a bacteriophage to a bacterium that gives rise to new bacteriophages.



(b)

(a) 1944: Oswald T. **Avery**, Colin **MacLeod**, and **Maclyn McCarty** demonstrate that Griffith's **transforming principle is not a protein, but rather DNA**, suggesting that DNA may function as the genetic material

(b) 1952: Alfred **Hershey** and Martha **Chase** use viruses (bacteriophage T2) to confirm DNA as the genetic material by demonstrating that **during infection viral DNA enters the bacteria while the viral proteins do not and that this DNA can be found in progeny virus particles.**

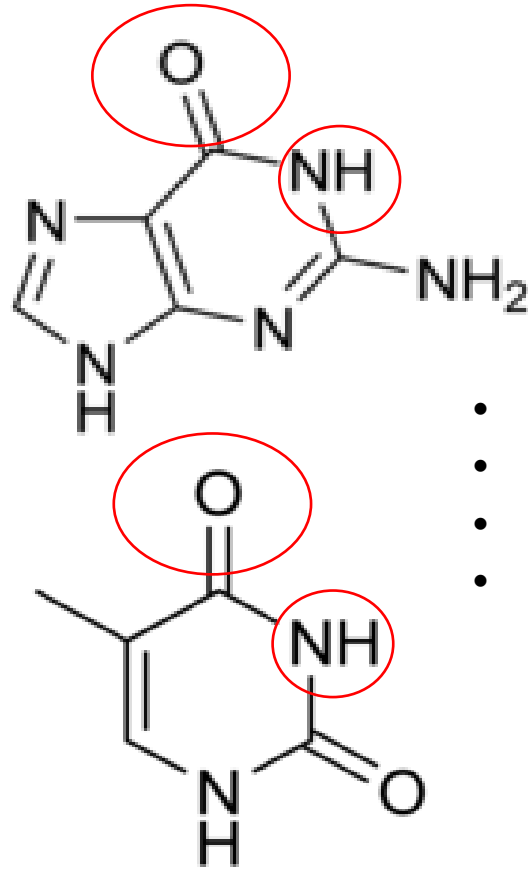
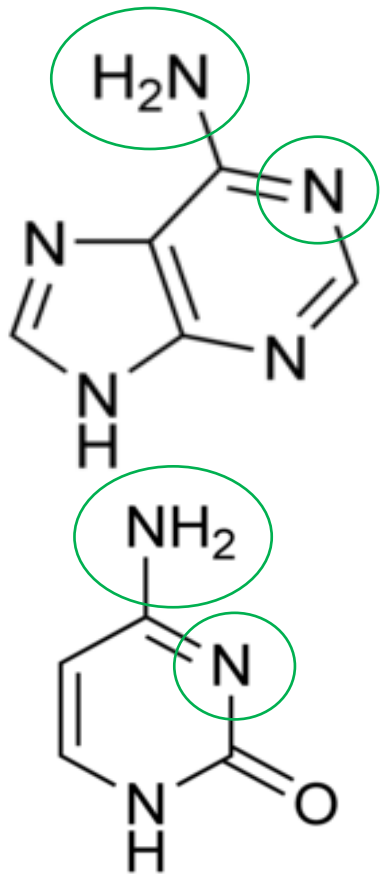
## Chargaff's Rules

Tetranucleotide hypothesis originated in 1906: DNA is a "statistical tetranucleotide".

During the 1950's E. Chargaff showed a number of DNAs, which differ in their base content.

**Chargaff's rules:** 1. amino residues = keto-residues; in another expression  $A+C = G+T$ ;

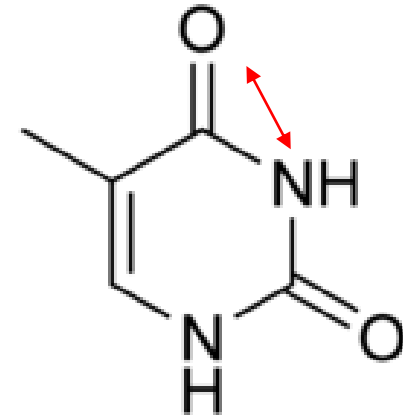
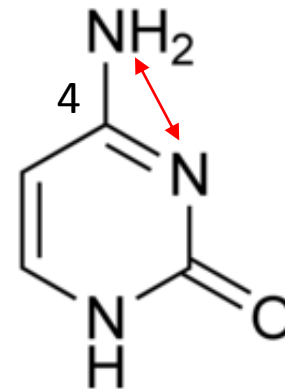
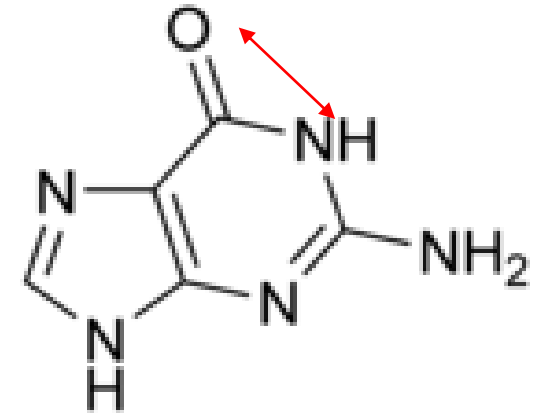
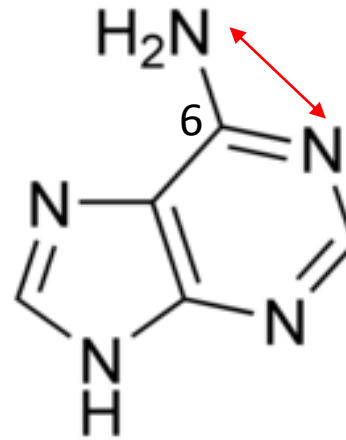
2.  $py = pu$ ;  $C+T = G+A$  3.  $A/T = G/C = 1$  (consequence of combining equations 1 and 2)

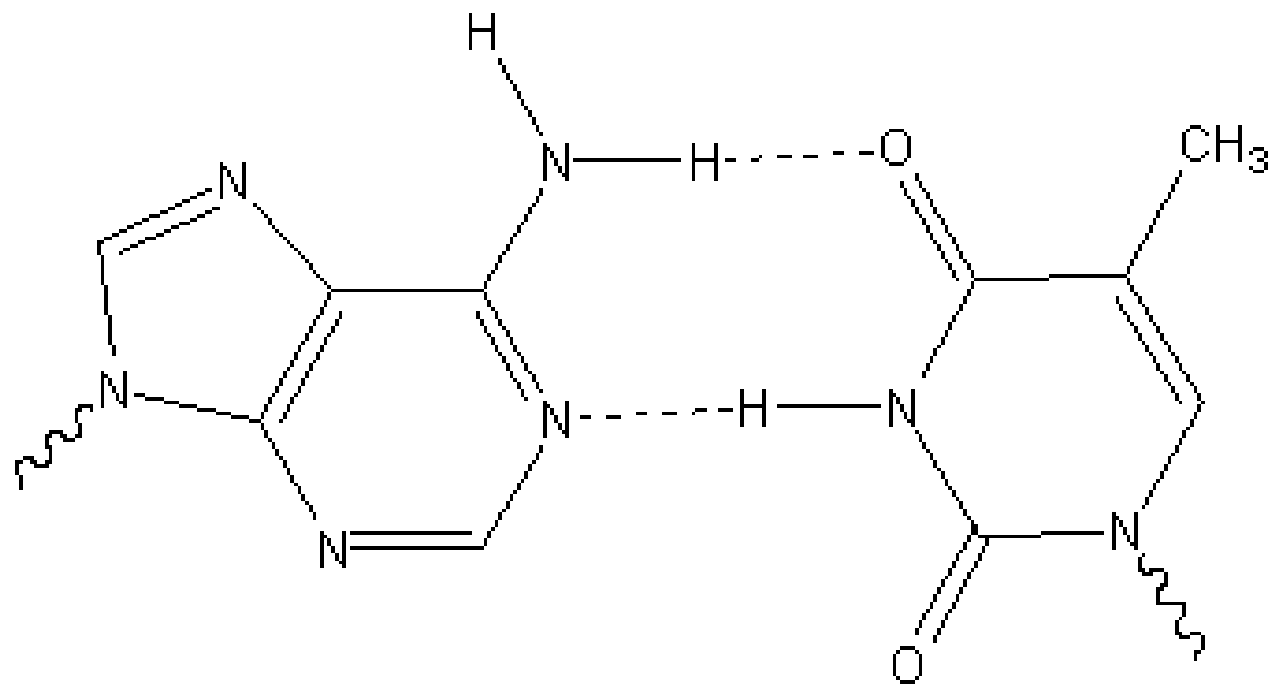
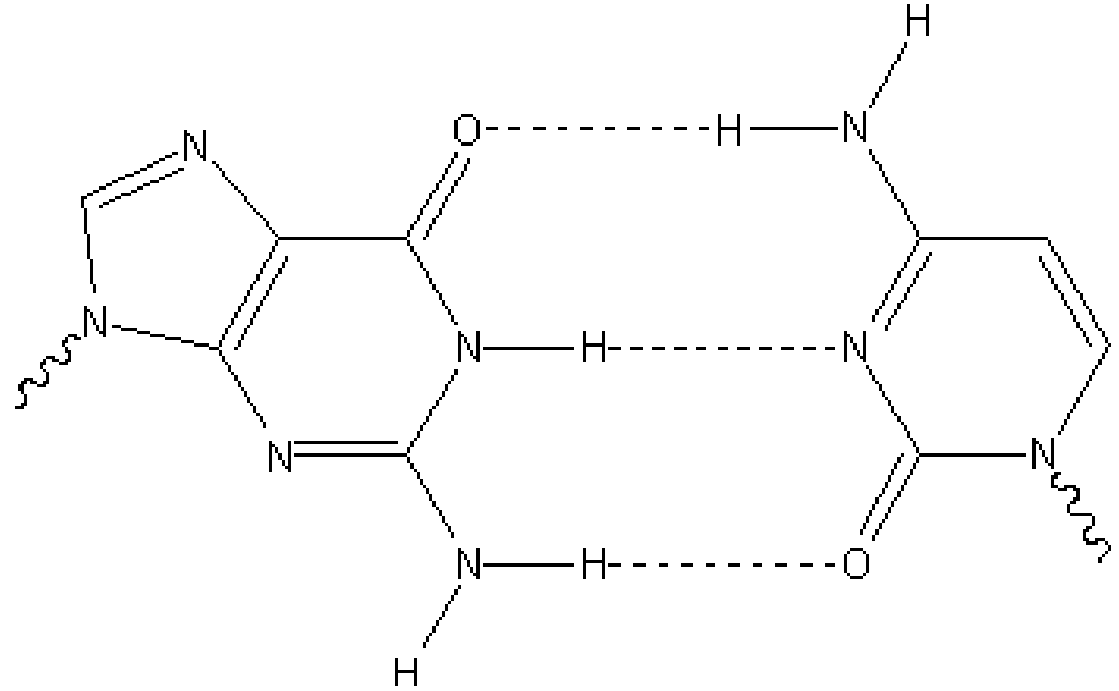


- amino pairs with keto
- purine pairs with pyrimidine
- consequently, A pairs with T and G with C
- nitrogen in the ring: donor or acceptor of H bond

# Tautomers

- isomers enol-keto, amino-imino
- double bond switch plus hydrogen/proton migration
- in nucleobases: critical effect on pairing properties
- 6-substituents in purines + 4-substituents in pyrimidines: oxygenous=keto, nitrogenous=amino
- hydrogen yes or not on the neighboring ring nitrogen





Watson and Crick (1953) proposed their famous double-helical structure of B-form of DNA on the ground of Chargaff's rules

- X-ray diffraction of DNA fibers obtained by Maurice Wilkins and Rosalind Franklin
- Construction of molecular models

This structure consists of two antiparallel helical strands. One turn contains 10 residues in every strand, the distance between bases is 3.4 Å, the bases are almost perpendicular to the axis, the phosphate group is 9 Å from the axis. Bases are specifically paired through hydrogen bonds - AT and GC. The strands are complementary - hydrogen bonds between two strands, the bases are inside the structure. Difference from  $\alpha$ -helix in polypeptides. Further forms A and C (besides B): dependence on humidity. The differences are principally in the tilt of bases and in the number of residues per turn, strands are commonly antiparallel, bases are stacked and base pairs located in one plane. It seems that the B-form is the prevalent one in solution as well as in cells and viral particles.

**Crick, Watson and Wilkins: Nobel Prize 1962**

"The structure is produced like a rabbit out of a hat, with no indication as to how we arrived at it"

F. Crick, NATURE 248(1974) 766- on the occasion of the 21st anniversary of the discovery (commenting their first paper in NATURE). What experimental evidence was available to W+C in 1953?

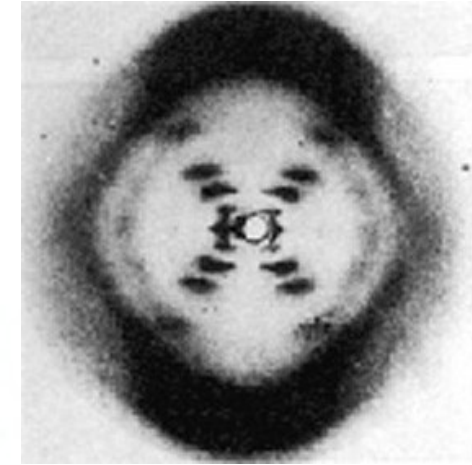
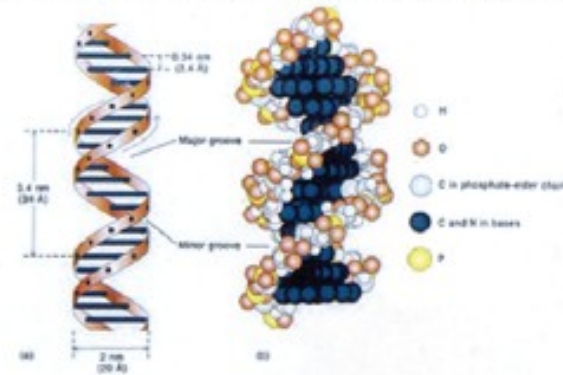
# X-RAY FIBER ANALYSIS OF DNA

represented the main evidence for the Watson-Crick double helix model

This method enabled analysis of high-molecular DNA, but provided only few basic parameters of the helix such as

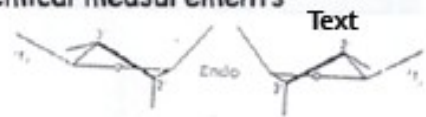
distance between base pairs

number of base residues per turn



Further data were derived from model building considering the laws of structural chemistry

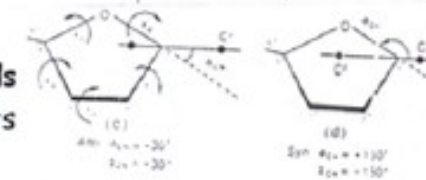
Base pairing from physical-chemical measurements



Sugar configuration (PUCKER)

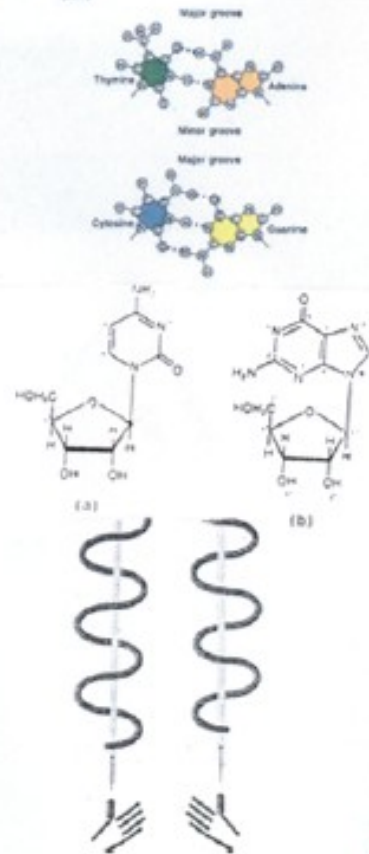


Angles of the glycosidic bonds were fixed within certain limits



Handedness of the helix

The direction of rotation was guessed and then subjected to testing



Linus Pauling – suggested triple helix structure with bases outside - INCORRECT

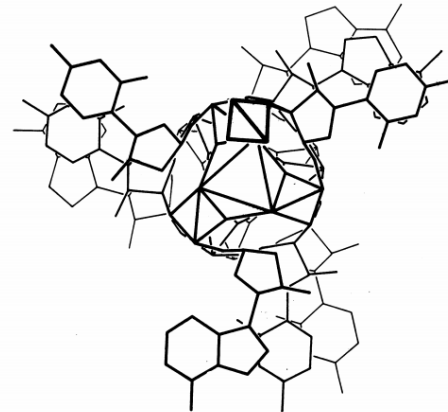
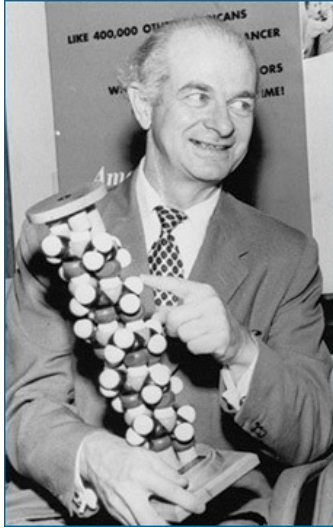
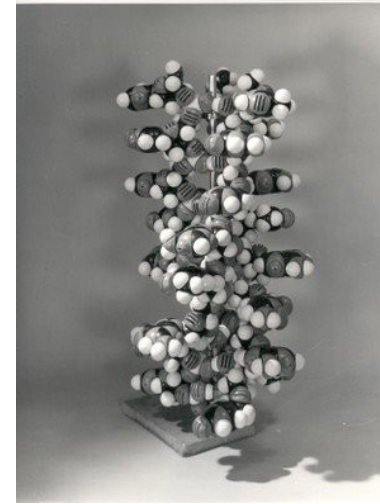
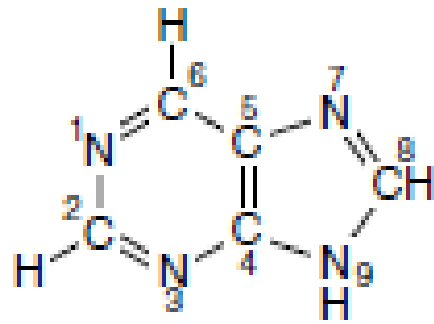


FIGURE 6  
Plan of the nucleic acid structure, showing several nucleotide residues.

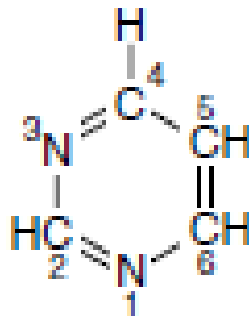


Other concepts: ladder (not interwound) structure (to overcome topological problems with unwinding the double helix)

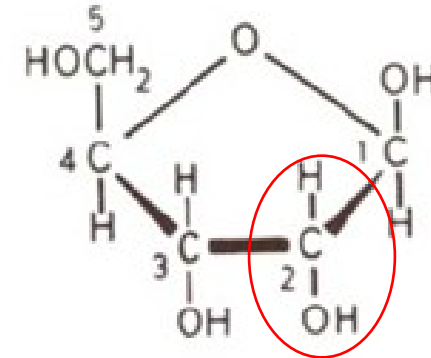
# Building blocks of nucleic acids: bases and pentoses



Purine



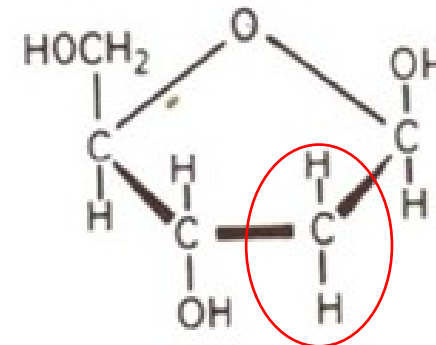
Pyrimidine



$\beta$ -D-ribofuranose

RNA

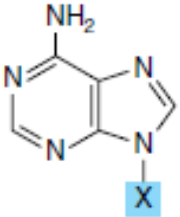
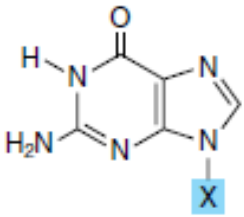
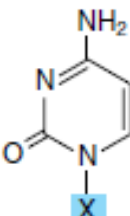
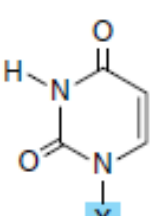
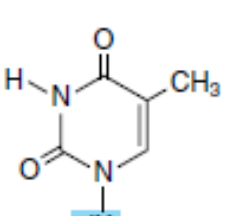
Sugar pucker in nucleosides: 1', 2'....5'

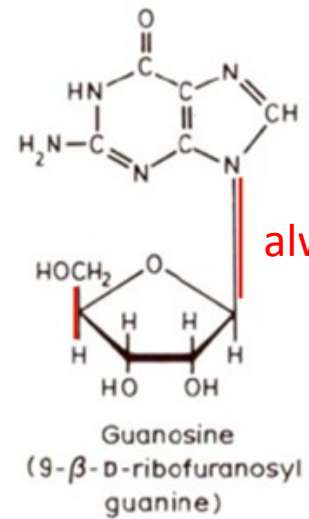
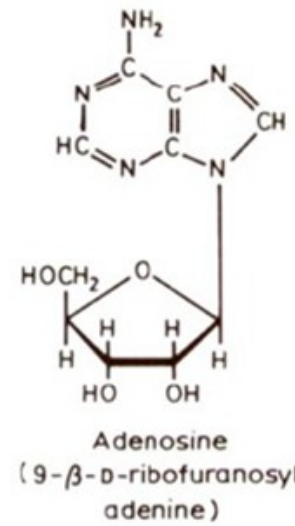


$\beta$ -D-2-deoxyribofuranose

DNA



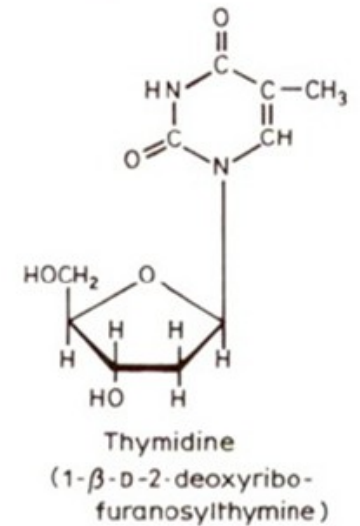
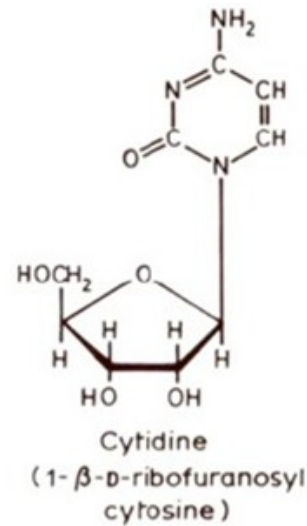
Base Formula	Base X = H	Nucleoside X = Ribose or Deoxyribose	Nucleotide, Where X = Ribose Phosphate
	Adenine A	Adenosine A	Adenosine monophosphate AMP
	Guanine G	Guanosine G	Guanosine monophosphate GMP
	Cytosine C	Cytidine C	Cytidine monophosphate CMP
	Uracil U	Uridine U	Uridine monophosphate UMP
	Thymine T	Thymidine T	Thymidine monophosphate TMP



always β anomer

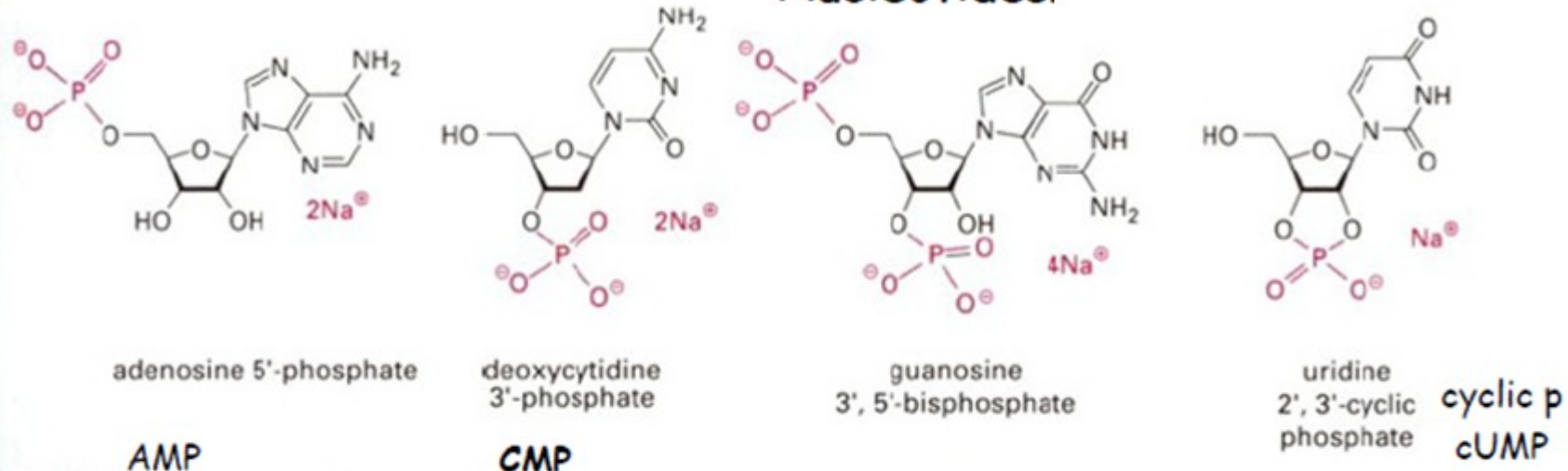
Nucleosides

Guanine riboside  
Guanosine



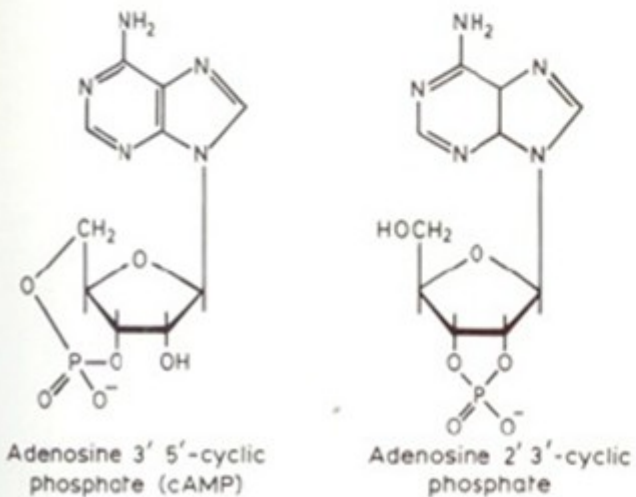
Thymine deoxyriboside

## Nucleotides.



**Fig. 2.4** Structures of some common nucleotides. All are presented as their sodium salts in the state of ionization observed at neutral pH.

*snorinana notation*



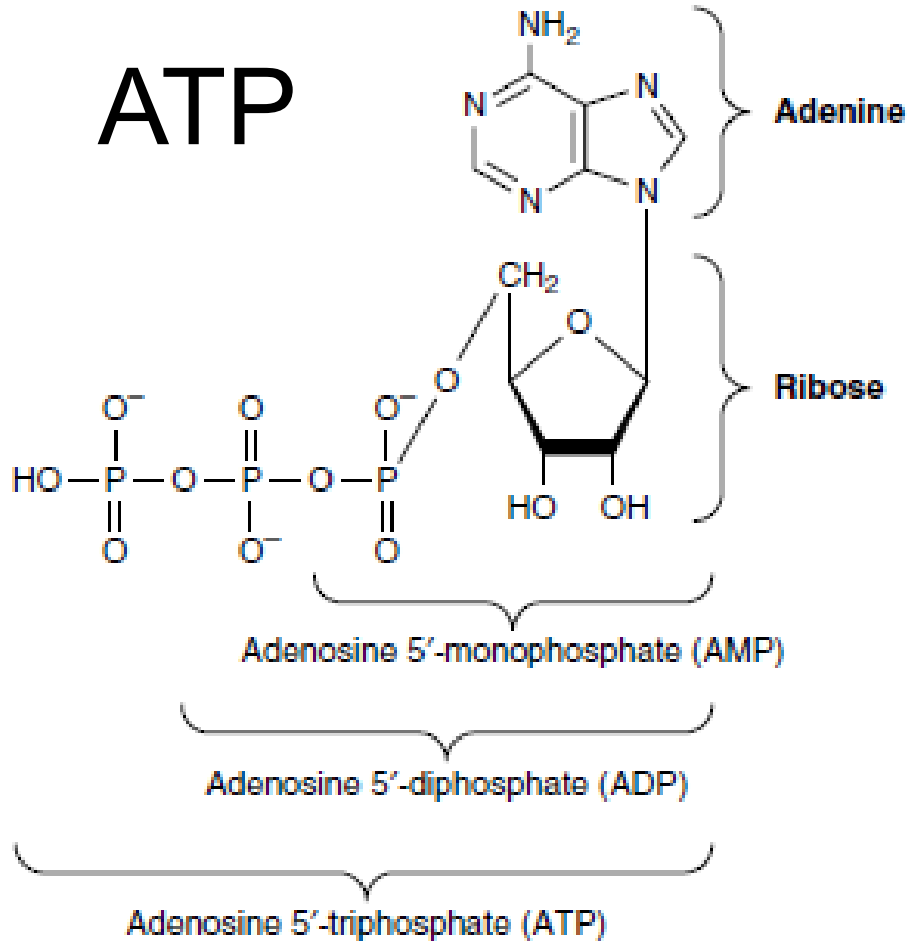
**Fig. 2.11**

bis- x di-phosphates (e.g. ADP)

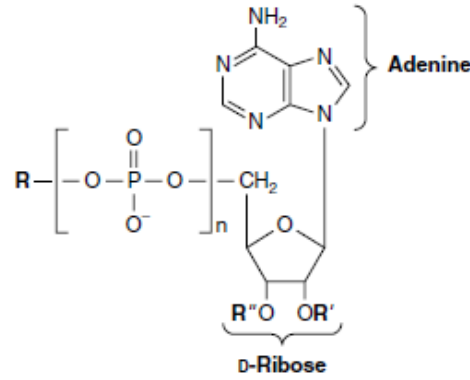
Cp (C-3') x pC (C-5')  
UpUp   U-Up   UpU

5'-TAGGTCGA-3'  
3'-ATCCAGCT-5'

# ATP

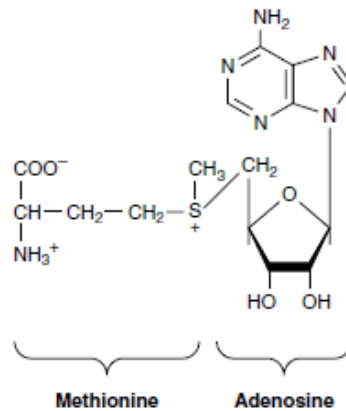


**Table 33-2.** Many coenzymes and related compounds are derivatives of adenosine monophosphate.

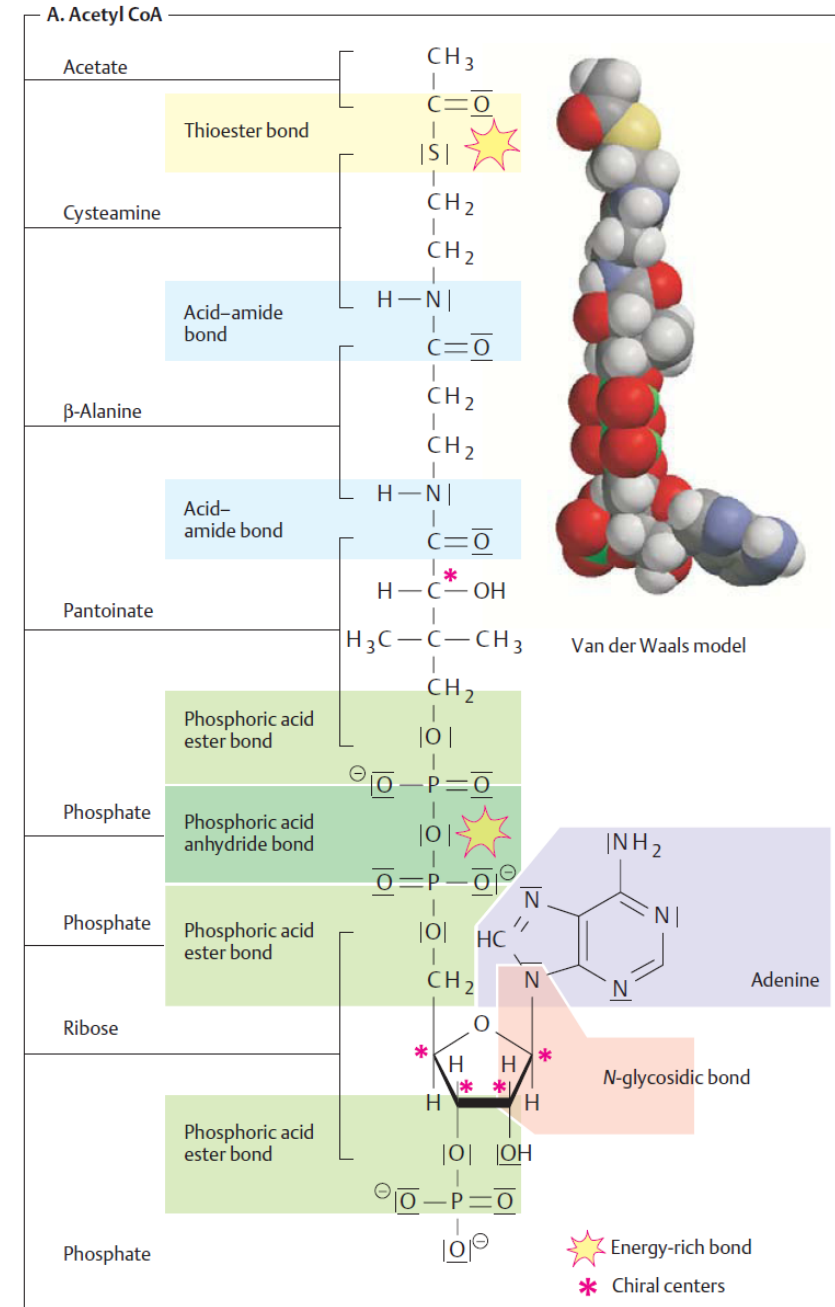


Coenzyme	R	R'	R''	n
Active methionine	Methionine*	H	H	0
Amino acid adenylates	Amino acid	H	H	1
Active sulfate	SO <sub>3</sub> <sup>2-</sup>	H	PO <sub>3</sub> <sup>2-</sup>	1
3',5'-Cyclic AMP		H	PO <sub>3</sub> <sup>2-</sup>	1
NAD*	†	H	H	2
NADP*	†	PO <sub>3</sub> <sup>2-</sup>	H	2
FAD	†	H	H	2
CoASH	†	H	PO <sub>3</sub> <sup>2-</sup>	2

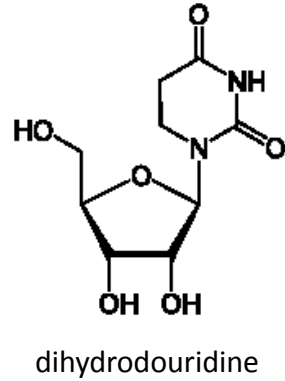
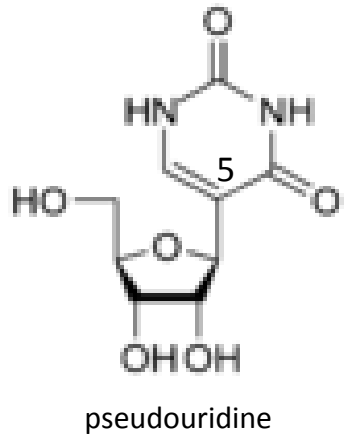
\*Replaces phosphoryl group.



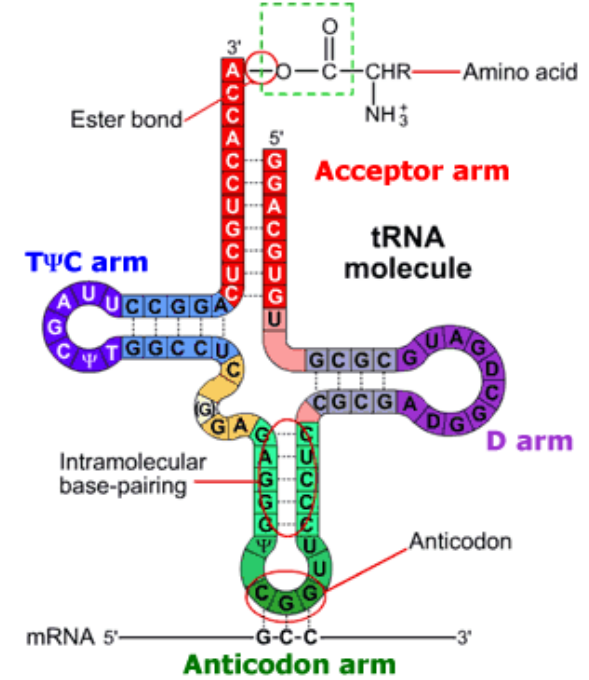
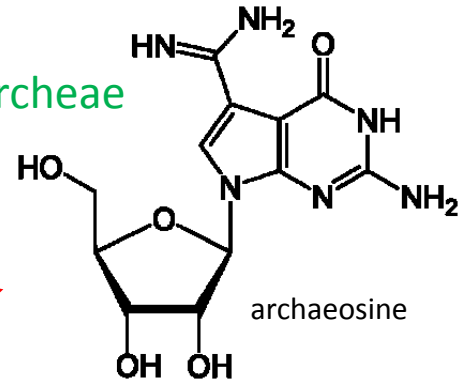
**Figure 33-11.** S-Adenosylmethionine. methyl donor for methylation reactions



# Unusual bases and nucleosides



in archaeae



in tRNA

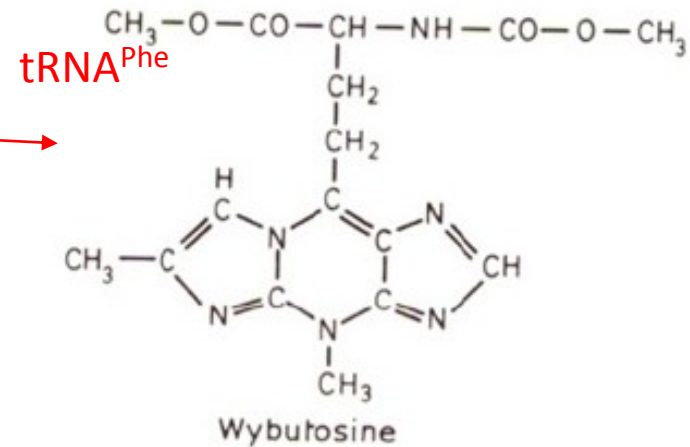
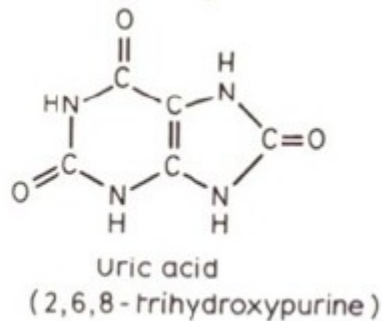
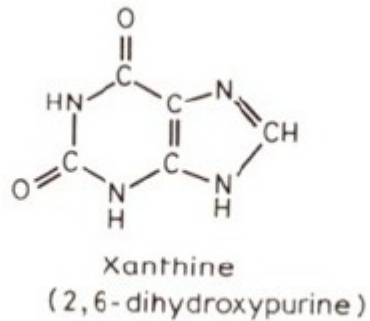
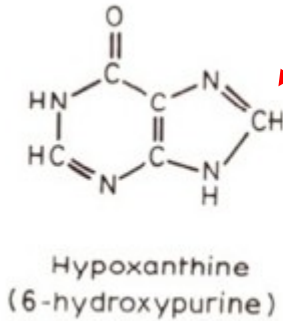


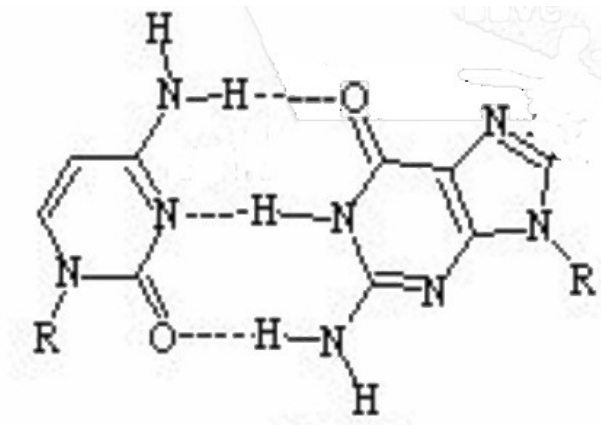
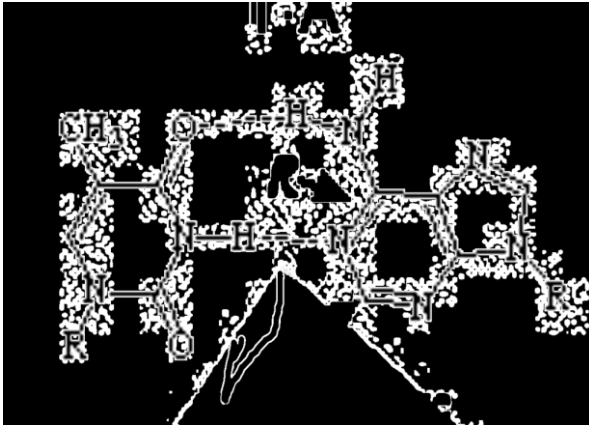
Fig. 2.5

tRNA<sup>Phe</sup>

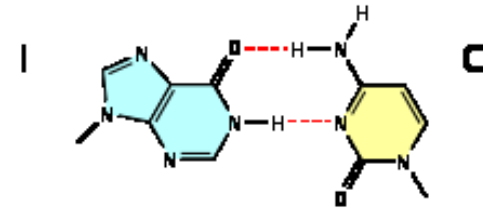
adenine demethylation    guanine demethylation    catabolism of purines

nucleoside=inosine (I)

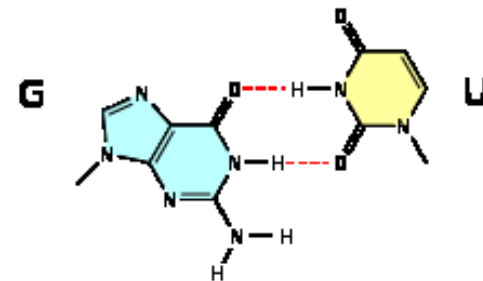
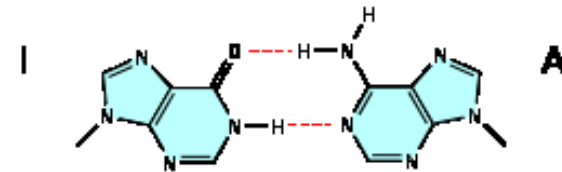
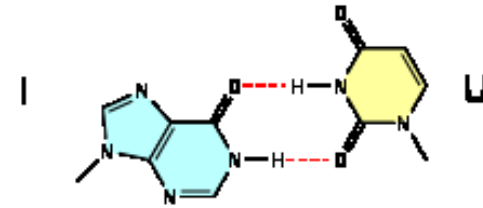
# Watson-Crick base pairs („canonical“)



# wobble pairs (examples)



(in fact canonical)



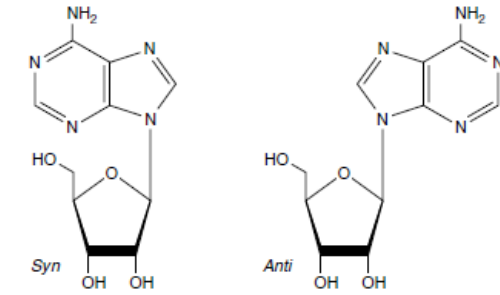
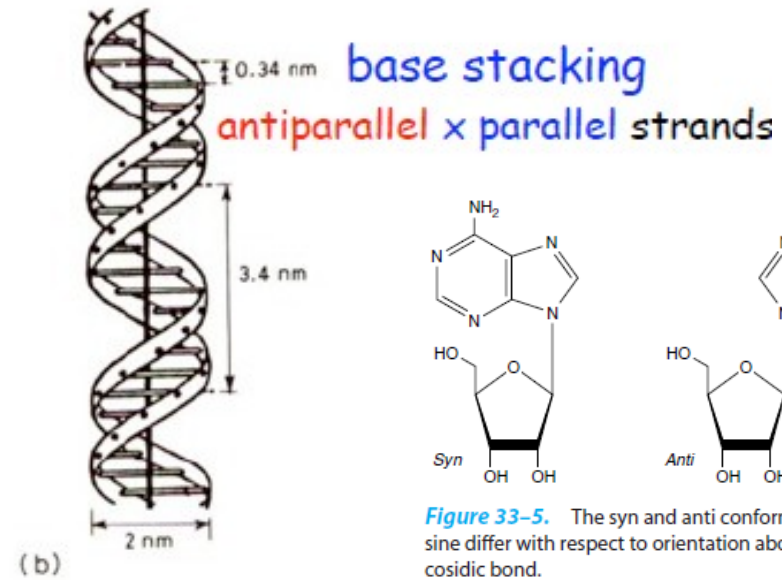
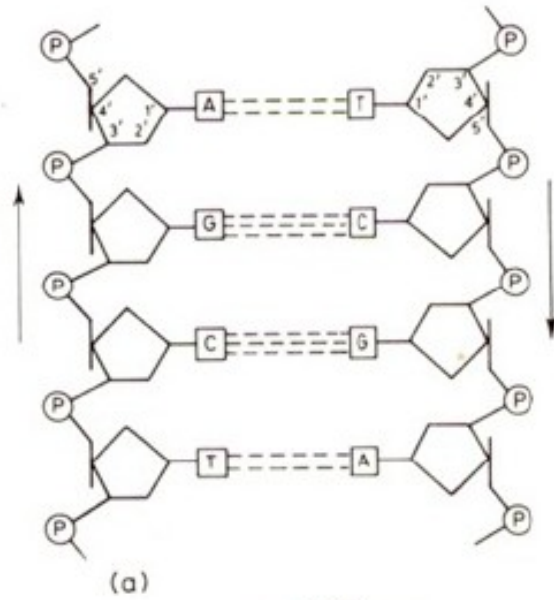


Figure 33-5. The syn and anti conformers of adenosine differ with respect to orientation about the N-glycosidic bond.

Between pH 5 and 9  
DNA is a polyanion  
with a single negative  
charge per nucleotide

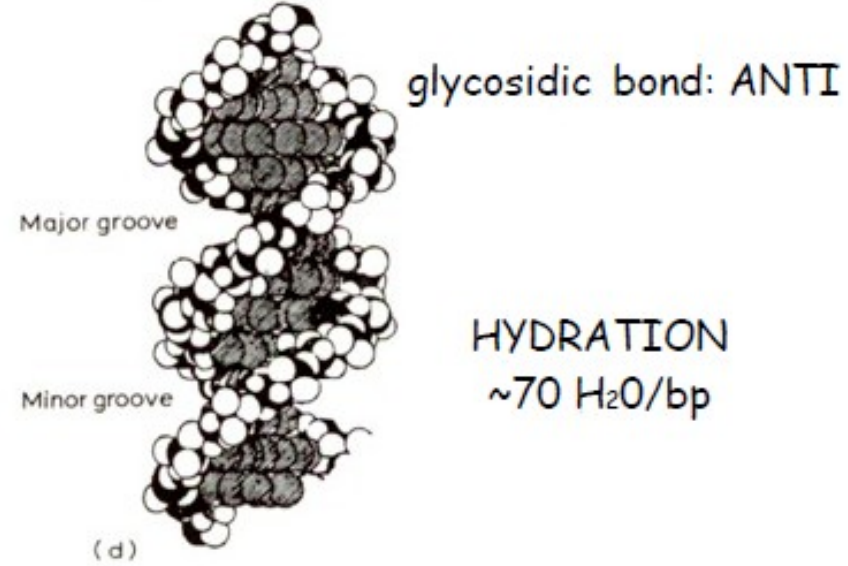


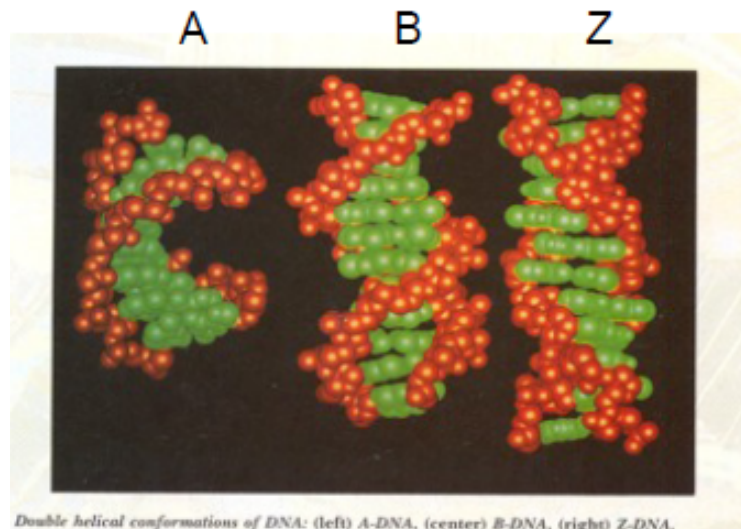
Fig. 2.15 Various diagrammatic ways of representing DNA: (a) showing polarity and base pairing but no helical twist; (b) showing helical twist and helix parameters but not base pairs; (c) showing helix and base pairs; (d) space-filling representation showing major and minor grooves.

## MICROHETEROGENEITY OF THE DNA DOUBLE HELIX FORMS

Studies of the detailed relationships between nucleotide sequence and DNA structure became feasible by the end of the 70s, when organic synthesis had been developed to the point where oligodeoxynucleotides (ODN) could be produced in the purity and quantity necessary for the preparation of single crystals for X-ray diffraction (and NMR) studies. Three main families of DNA forms were identified by crystallographic analysis of ODN: right-handed A and B-forms and the left-handed Z-form.

### B-, A- and Z-helices

The A-, B- and Z-helices have distinctly different shapes which are due to the specific positioning and orientation of the bases with respect to the helix axis. In A-DNA, the base pairs are displaced from the helix axis, the major groove is very deep, and the minor groove is very shallow. In B-DNA the major and minor grooves are of similar depths and the helix axis is close to the base pair center. In Z-DNA the minor groove is deep and the major groove is convex. In A- and B-DNA a single nucleotide can be considered as the repeat unit, while in Z-DNA the repeat unit is a dinucleotide.



Double helical conformations of DNA: (left) A-DNA, (center) B-DNA, (right) Z-DNA.

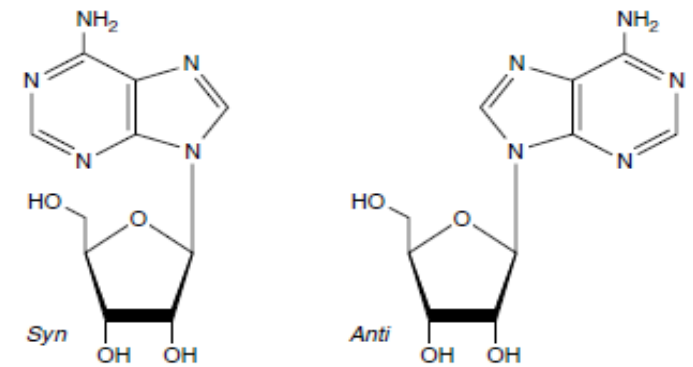
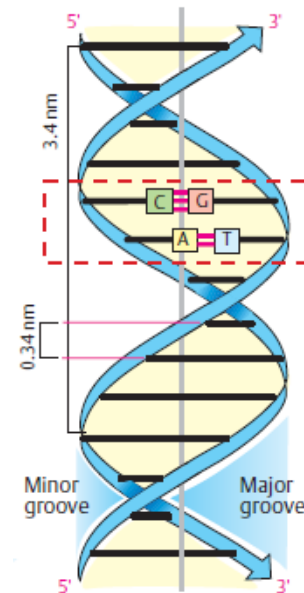
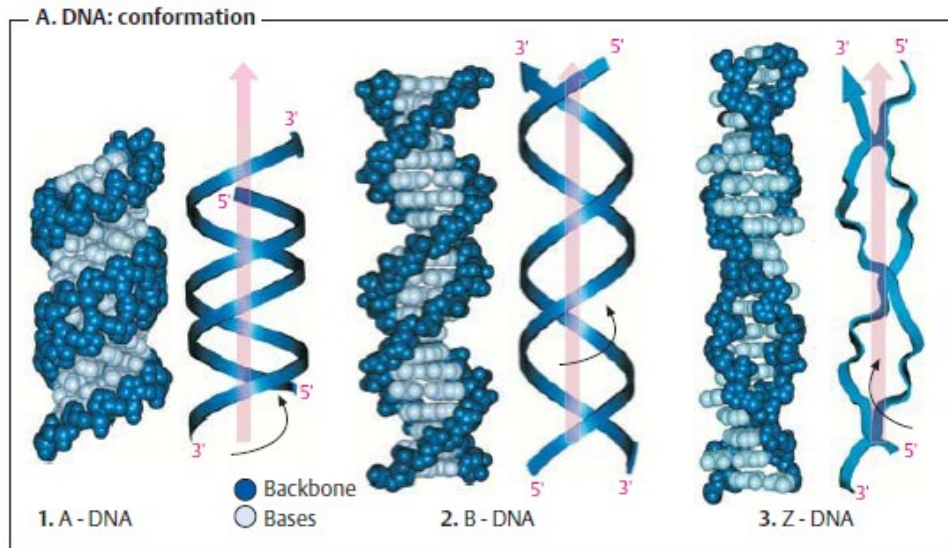
In A-duplexes base pairs are heavily tilted in contrast to base pairs in B-duplexes which are almost perpendicular to the helical axis. (Table 1). Many of the structural differences between the helices arise from the puckering of the sugar ring; C3'-endo is typical for A-DNA, while in Z-DNA C3'-endo alternates with C2'-endo. In B-DNA sugar pucker tends to favor the C2'-endo or C1'-exo, but the distribution of conformations is much broader than in A- and Z-DNA.

The right-handed **A- and B-forms** have the **anti** glycosidic bond, whereas in the **left-handed Z-helix** the orientation **alternates between syn (for purines) and anti (for pyrimidines)**. In the latter structure the orientation around the **C4'-C5' bond with respect to the C3' atom** alternates between **gauche+** and **trans** conformations for cytidine and guanosine, respectively. The **alternating features of Z-DNA** result in the **zig-zag shape of its sugar-phosphate backbone**, from which the **name was derived**. The changes in the backbone and glycosidic-bond conformations are accompanied by **substantial variations in the stacking interactions between successive base pairs in Z-DNA**. **Methylation or bromination of cytosines** at position 5 (studied mainly in ODNs with alternating C-G sequence) **stabilizes Z-DNA**. Under certain conditions even non-alternating sequences of purines and pyrimidines can assume the conformation of Z-DNA with thymines in a syn orientation. The outer surface features of such a Z-helix are different at the non-alternating sites but the backbone is similar to that observed with alternating sequences.

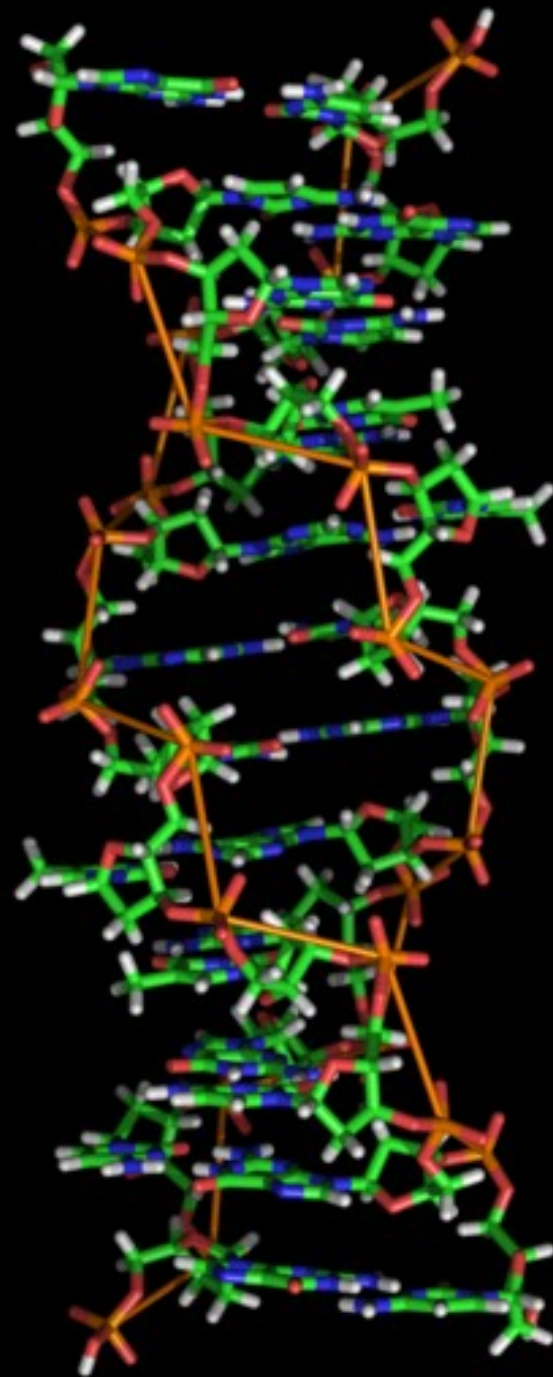
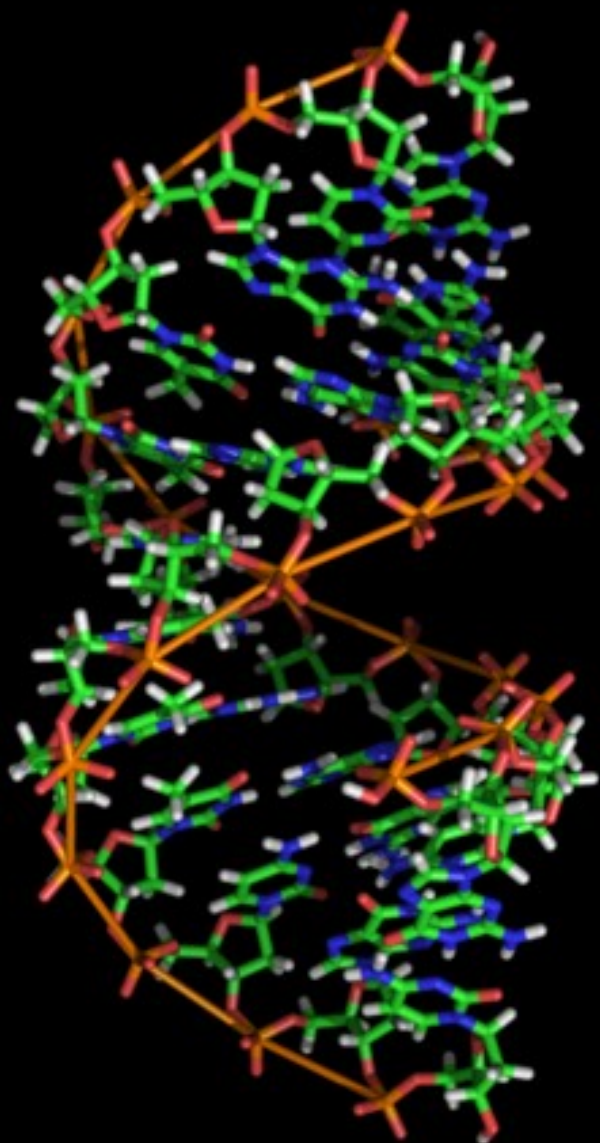


**TABLE 1**  
**Comparison of A-, B-, and Z-DNA**

Helix sense	A-DNA <sup>a</sup> right-handed	B-DNA <sup>a</sup> right-handed	B'-DNA <sup>b</sup> right-handed	Z-DNA <sup>c</sup> left-handed
Base pairs per turn	11	10	10	12 (6 dimers)
Helix twist (°)	32.7	36.0	34.1, 36.8	-10, -50
Rise per base pair (Å)	2.9	3.4	3.5, 3.3	3.7
Helix pitch (Å)	32	34	34	45
Base pair tilt (°)	13	0	0	-7
P distance from helix axis (Å)	9.5	9.3	9.1	6.9, 8.0
Glycosidic orientation	<i>anti</i>	<i>anti</i>	<i>anti</i>	<i>anti, syn</i>
Sugar conformation	<i>C3'-endo</i>	Wide range	<i>C2'-endo</i>	<i>C2'-endo, C3'-endo<sup>d</sup></i>



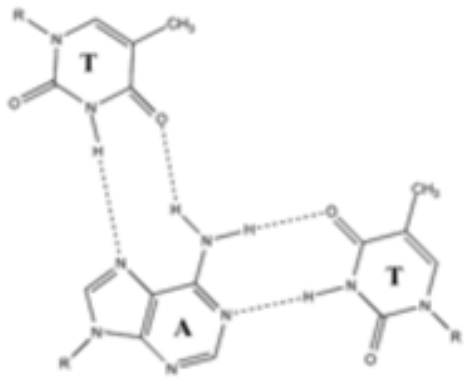
**Figure 33-5.** The *syn* and *anti* conformers of adenosine differ with respect to orientation about the N-glycosidic bond.



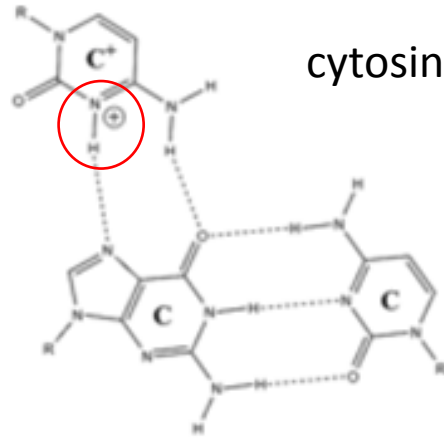
# Multistranded DNA structures

- triplexes
- tetraplexes (quadruplexes)

# Hoogsteen base pairs (triads)

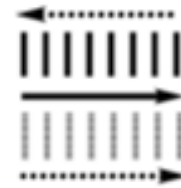


TA<sup>\*</sup>T

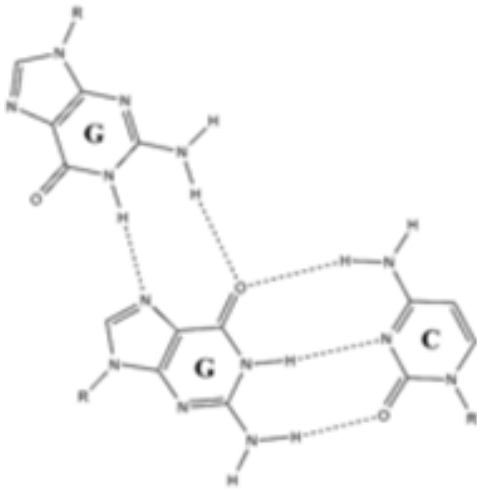


cytosine protonation

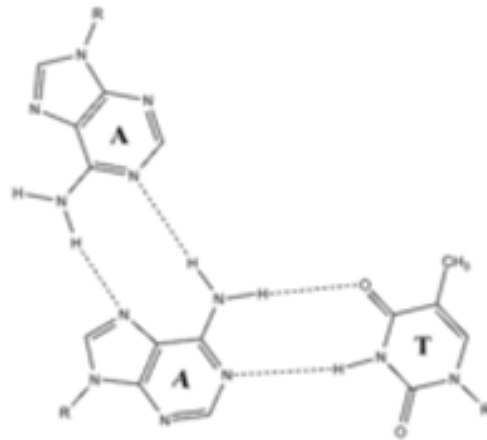
CG<sup>\*</sup>C<sup>\*</sup>



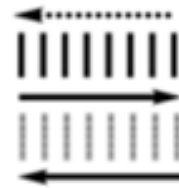
YR<sup>\*</sup>Y



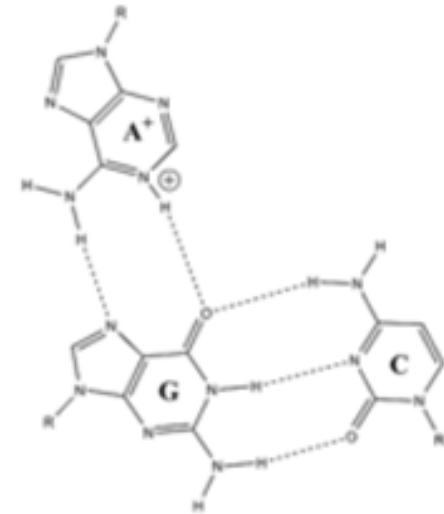
CG<sup>\*</sup>G



TA<sup>\*</sup>A



YR<sup>\*</sup>R



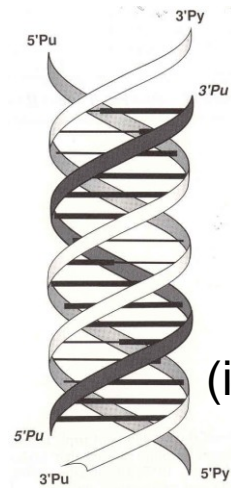
CG<sup>\*</sup>A<sup>\*</sup>

# Triplex DNA

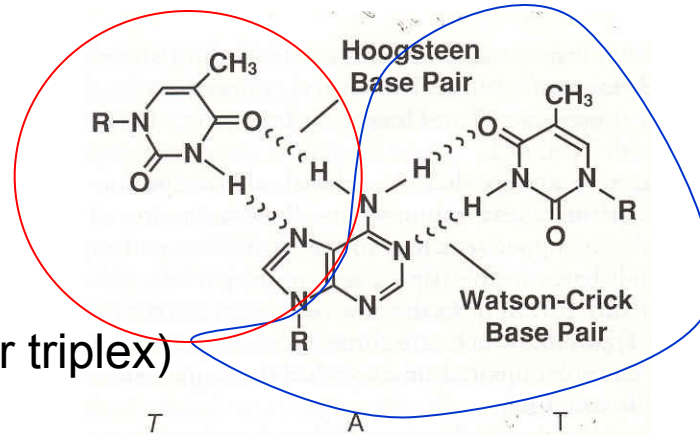
(homopurine·homopyrimidine stretch of suitable sequence)

e.g.

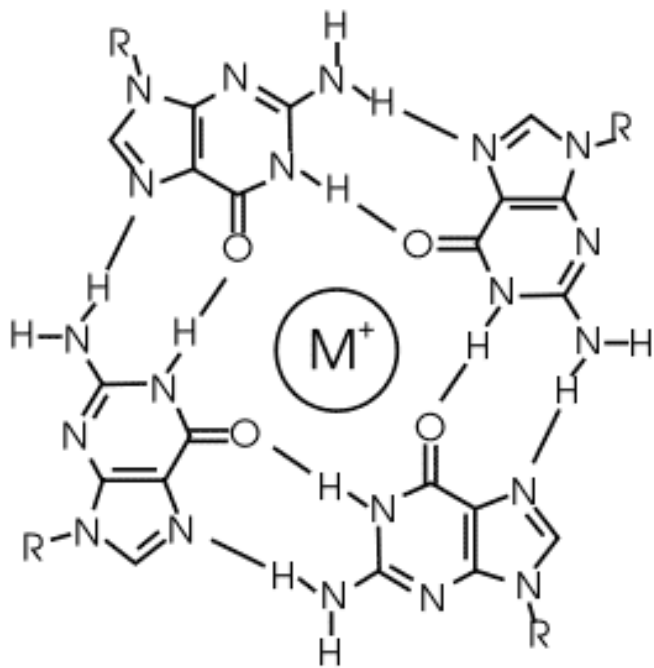
TTT  
AAA  
TTT



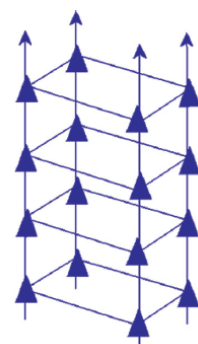
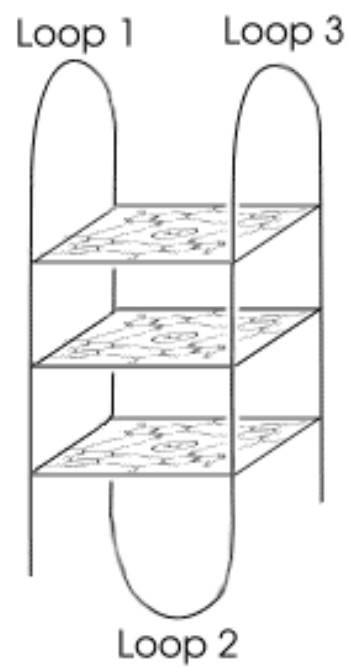
(intermolecular triplex)



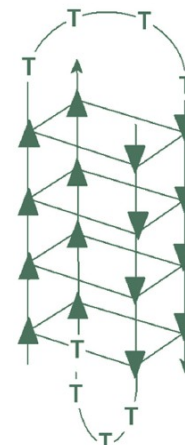
Guanine tetrad



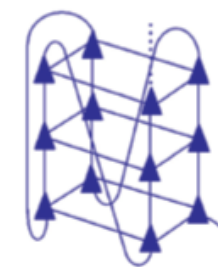
Guanine tetraplex



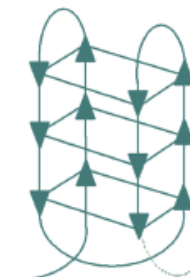
tetramolecular  
parallel



bimolecular  
antiparallel

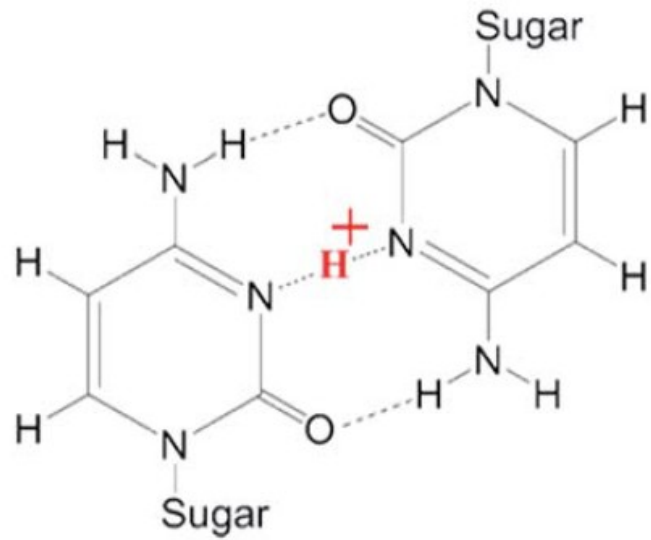


intramolecular  
parallel

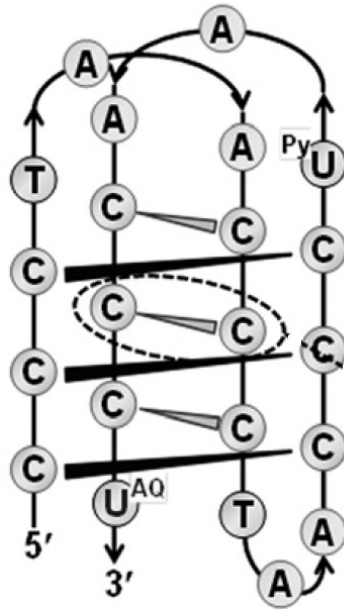


intramolecular  
antiparallel

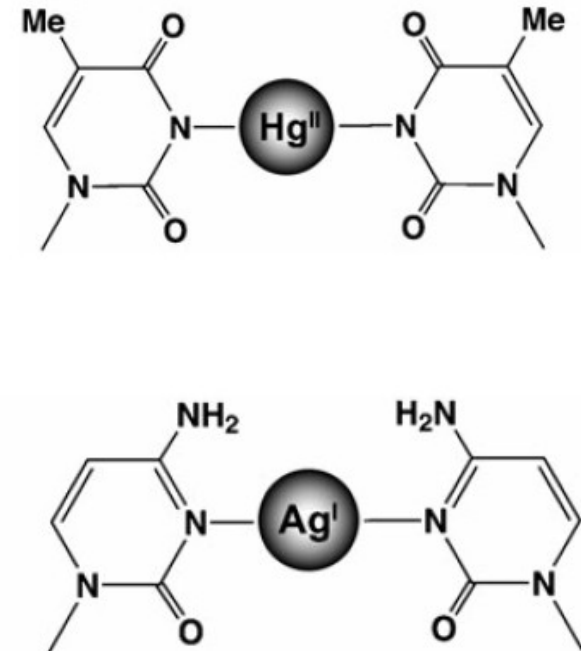
hemiprotonated C<sup>+</sup>•C pair



cytosine tetraplex (i-motif)



metal ion-mediated pairing  
(non-physiological)

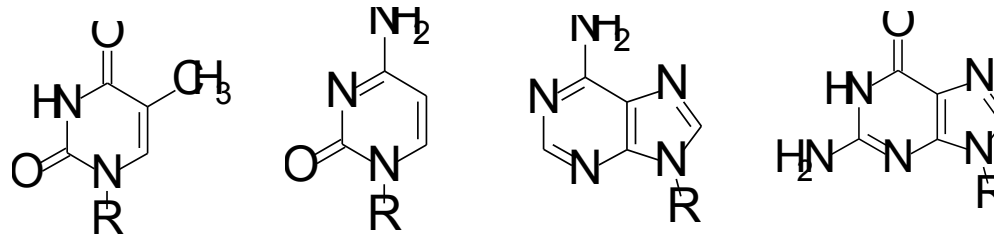
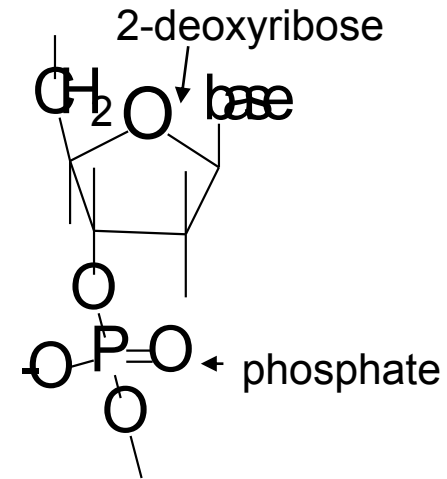


# Chemical reactivity of DNA



# Chemical reactivity of DNA

- DNA chemistry is derived from chemistry of its constituents
- phosphodiester bonds
- N-glycosidic bonds
- deoxyribose
- nitrogenous bases

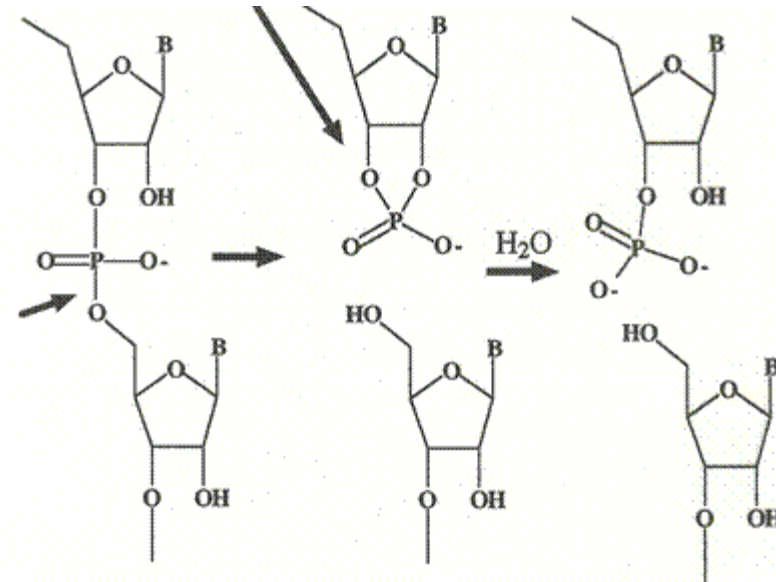


## Chemical modification of DNA:

- damage to the genetic material
- analytical use

# DNA hydrolysis

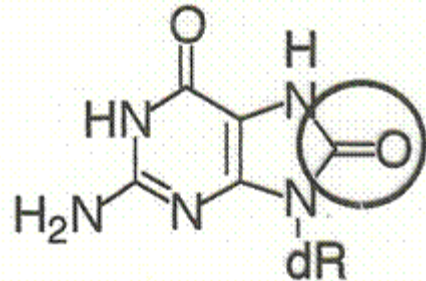
- both phosphodiester and N-glycosidic bonds susceptible to acid hydrolysis
- N-glycosidic bond more stable toward hydrolysis in pyrimidine than in purine nucleosides (and more in ribo- than in deoxynucleosides)
- stable in alkali (unlike RNA)
- alkali-labile sites: upon DNA damage
- enzymatic hydrolysis (N-glycosylases, nucleases)



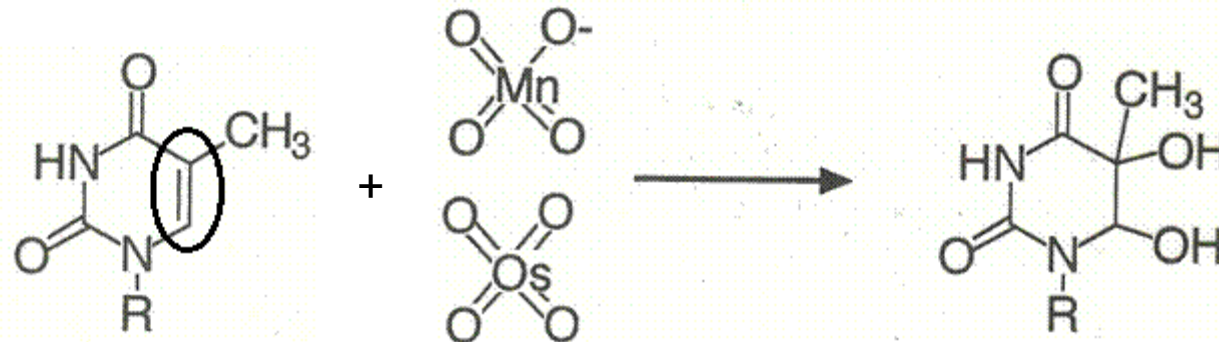
# Oxidation

- two main sites susceptible to oxidation attacks:

- C8 of purines (ROS)

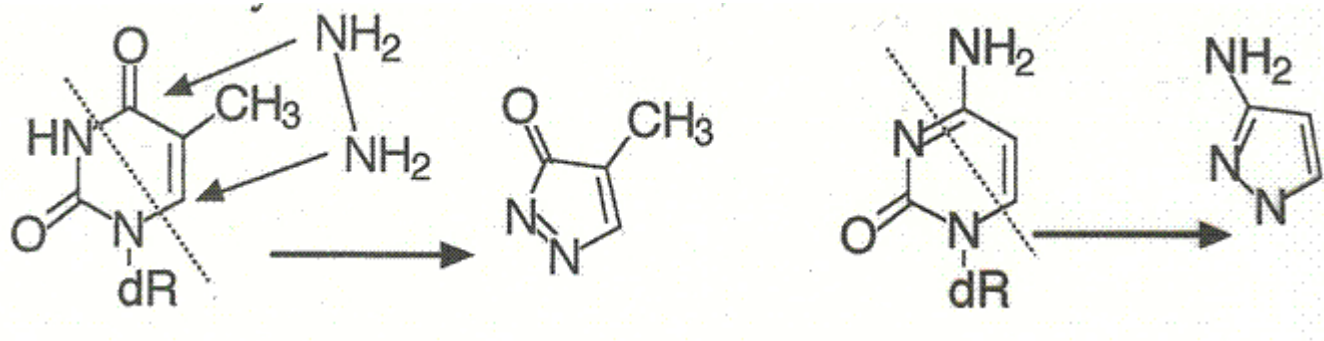


- C5-C6 of pyrimidines



# reactions with nucleophiles

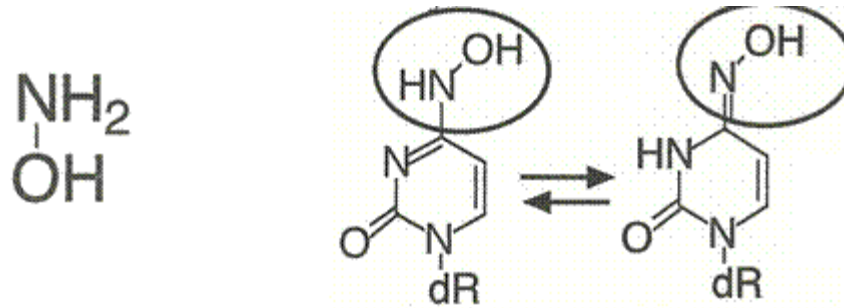
- C4 and C6 are centres of electron deficit in pyrimidine moieties (electrophile centres)



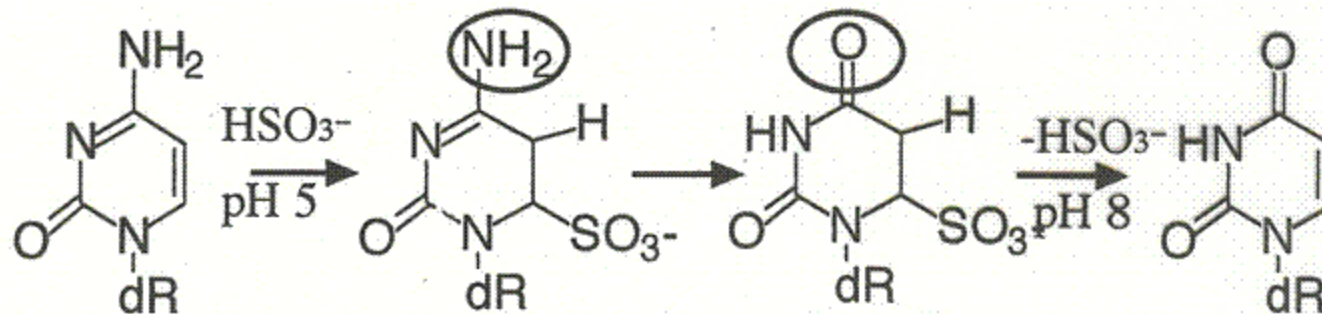
- reaction with hydrazine: pyrazole derivative and urea residue bound to the sugar
- with T the reaction is disfavored in high salt: Maxam-Gilbert sequencing technique

# reactions with nucleophiles

- **hydroxylamine:** cytosine modification
- the products' preferred tautomer pairs with adenine → mutagenic

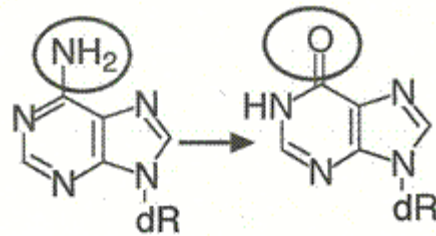


- **bisulphite:** cytosine modification inducing its deamination to uracil → mutagenic
- 5-methyl cytosine does not give this reaction: genomic sequencing of 5<sup>m</sup>C

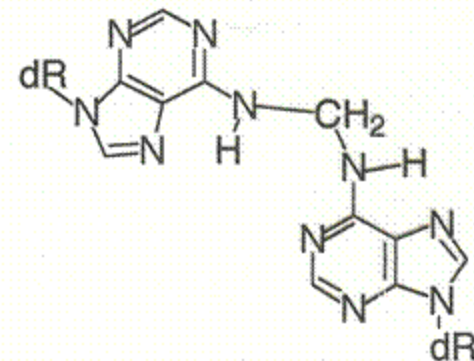
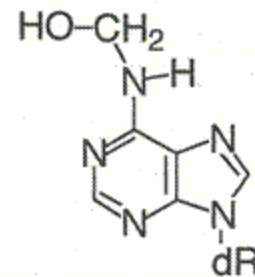
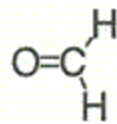


# reactions with electrophiles

- attacking N and/or O atoms
- nitrous acid ( $\text{HNO}_2$ ) causes base deamination ( $\text{C} \rightarrow \text{U}$ ,  $\text{A} \rightarrow \text{I}$ ) – affecting base pairing, mutagenic

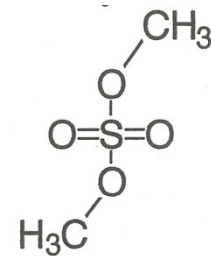


- aldehydes: reactions with primary amino groups
- formaldehyde: two step reaction

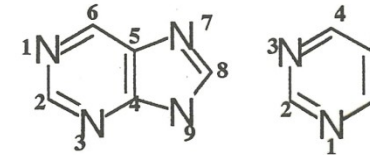


# DNA alkylation

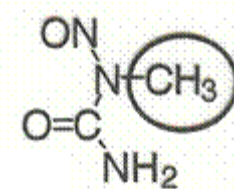
- hard or soft alkylating agents
- hard ones attack both N and O atoms, soft only N
- dimethyl sulfate: typical soft alkylating agent



G-N7 > A-N1 > C-N3 > T-N3



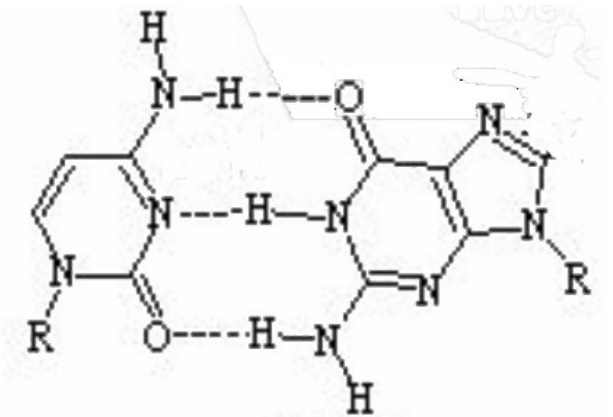
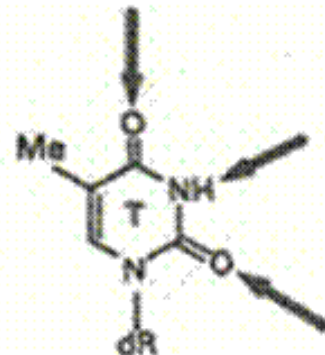
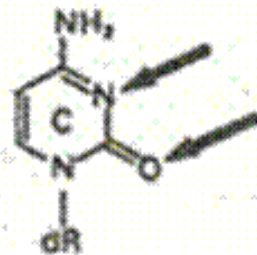
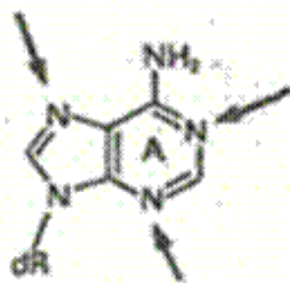
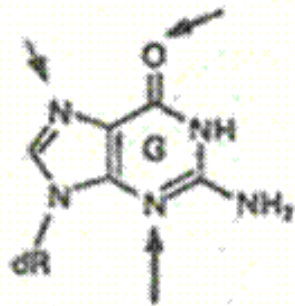
- N-alkyl-N-nitroso urea: typical hard alkylating agent
- modifies all N + O in bases as well as phosphate groups (forming phosphotriesters)
- analytical use (sequencing, footprinting)



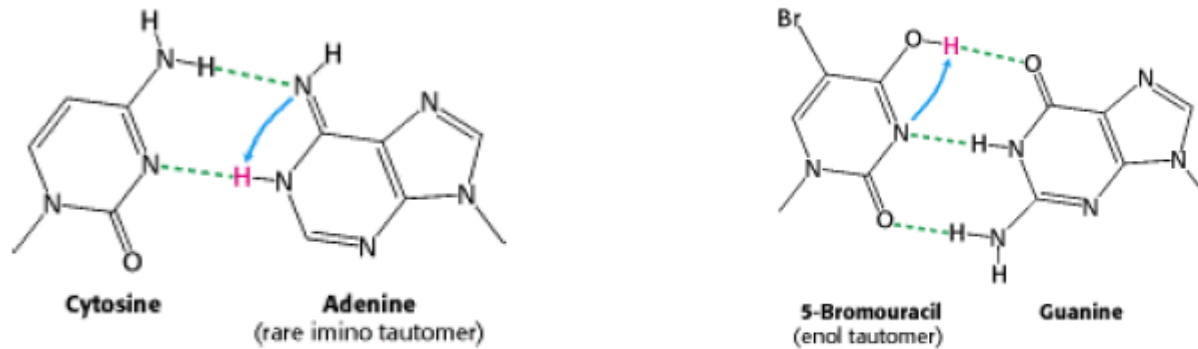


# Biological consequences of base alkylation

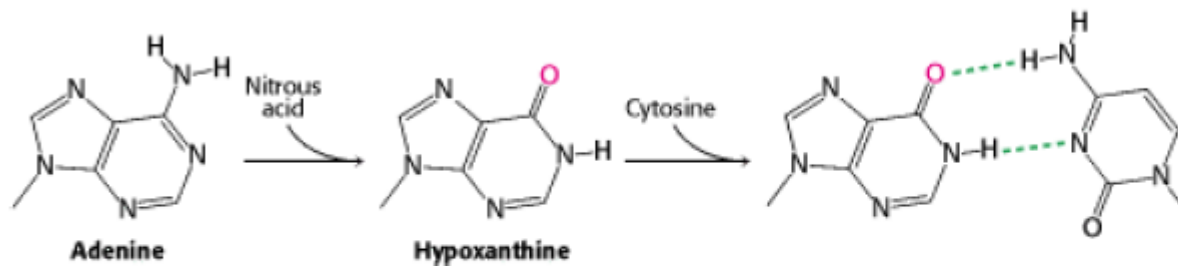
- **N-alkylation:** the primary site = N7 of guanine (accessible in both ss and dsDNA)
  - does not change base pairing; easily repairable
- N3 of adenine or guanine: located in minor groove
  - cytotoxic modification (DNA/RNA polymerization blocked)
- N1 of guanine: interferes with base pairing
- **O-alkylation (G-O6, T-O6)** the bases „locked“ in enol forms → improper base pairing → mutagenic



# Tautomerization, base pairing and chemical mutagenesis



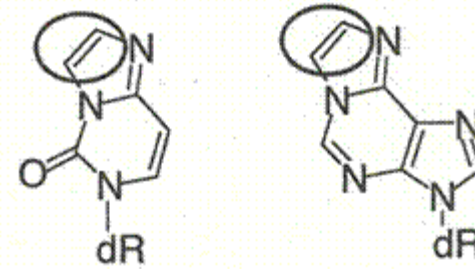
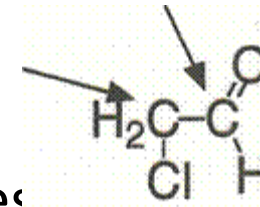
**Figure 27.41. Base Pair with Mutagenic Tautomer.** The bases of DNA can exist in rare tautomeric forms. The imino tautomer of adenine can pair with cytosine, eventually leading to a transition from A-T to G-C.



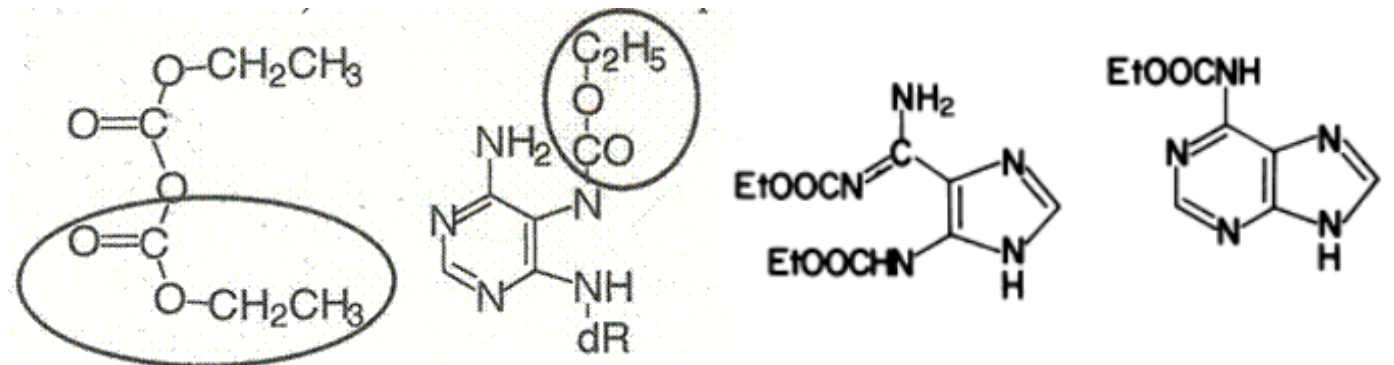
**Figure 27.43. Chemical Mutagenesis.** Treatment of DNA with nitrous acid results in the conversion of adenine into hypoxanthine. Hypoxanthine pairs with cytosine, inducing a transition from A-T to G-C.

similarly uracil is deamination product of cytosine

- **chloro- (bromo-) acetaldehyde**: two reactive centres (aldehyde and alkylhalogenide)
- reaction with C or A
- chemical probes (react only with unpaired bases,



- **diethyl pyrocarbonate**: acylation of purines (primarily A) or C
- modification leads to opening of the imidazole ring
- chemical DNA probing

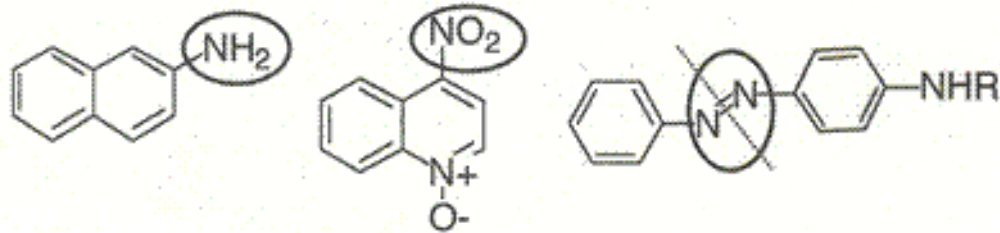


# Metabolically activated carcinogens

- some substances became toxic after their metabolic conversion
- **detoxifying** machinery of the organism acts here as a bad fellow
- microsomal hydroxylase complex, **cytochrome P450**
- the role of this system is to introduce suitable reactive groups into xenobiotics enabling their conjugation with other molecules followed by removal from the organism
- **but....**

# Metabolically activated carcinogens

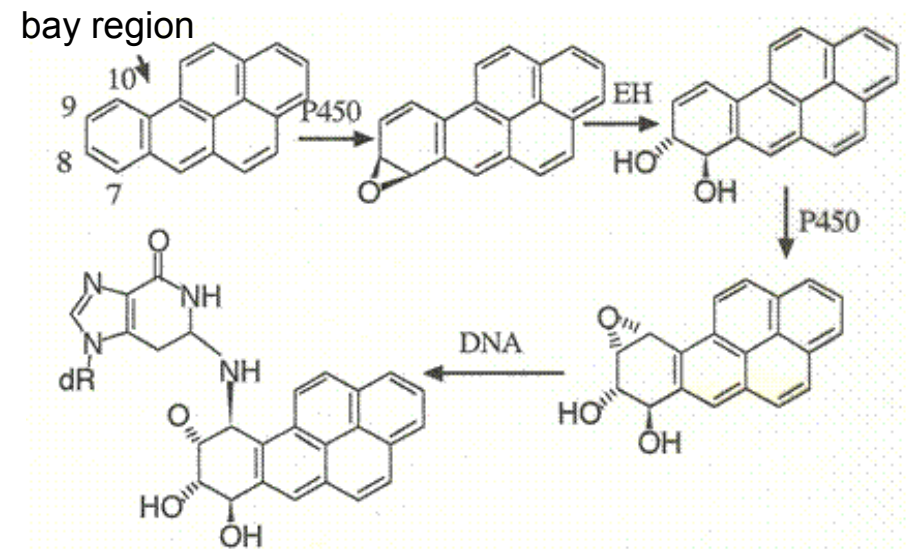
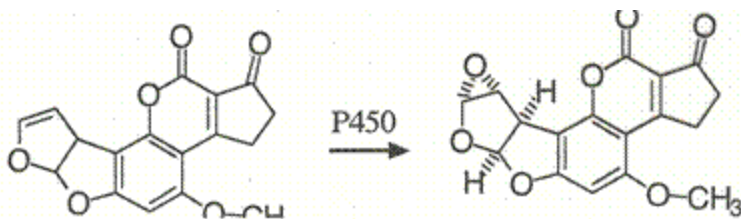
- aromatic nitrogenous compounds (amines, nitro- or azo- compounds):



- aromatic amines are converted into either (safe) phenols, or (dangerous) hydroxylamine derivatives
- azo- compounds: „cleaved“ into amines
- nitro- compounds: reduced into hydroxylamines

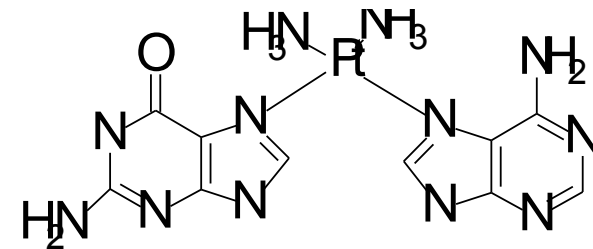
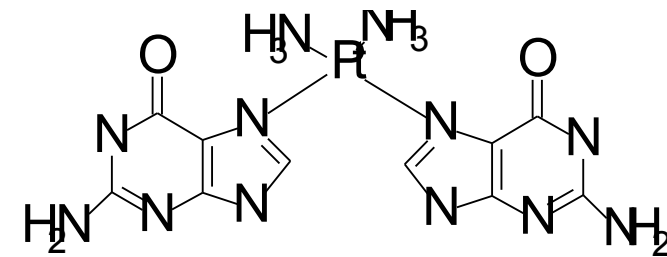
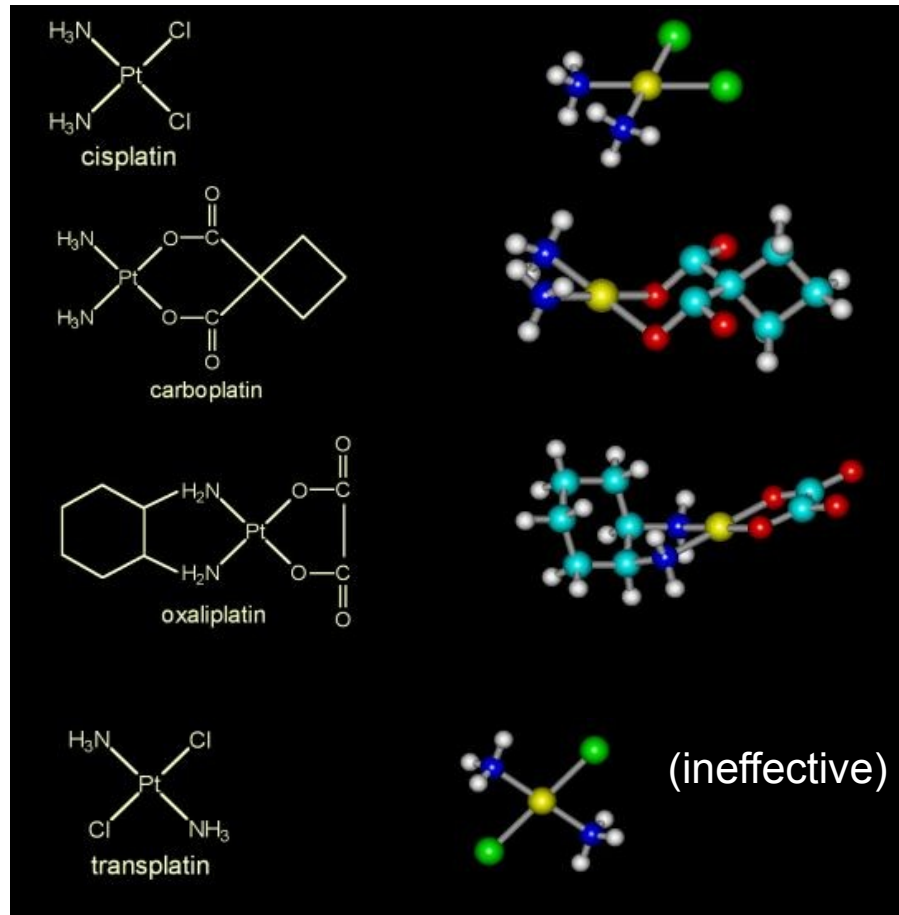
# Metabolically activated carcinogens

- polycyclic aromatic hydrocarbons like benzo[ $\alpha$ ]pyrene: three-step activation
  - P450 introduces epoxy group
  - epoxide hydrolase opens the epoxide circle
  - P450 introduces second epoxy group
- DNA adduct formation (primarily -NH<sub>2</sub> of guanine, then G-N7, G-O6 and A-N6)
- similar pathway of aflatoxin activation



# anticancer drugs

- some types of antineoplastic agents act via formation of DNA adducts
- metallodrugs: mainly platinum complexes

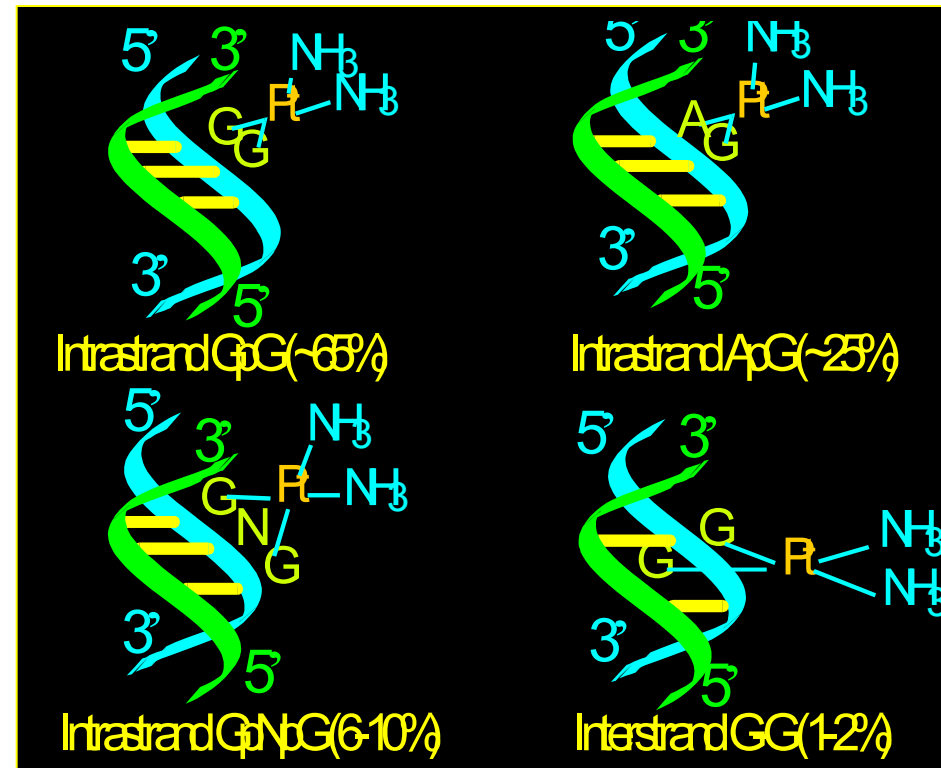


# cisplatin: reaction with DNA in certain sequence motifs



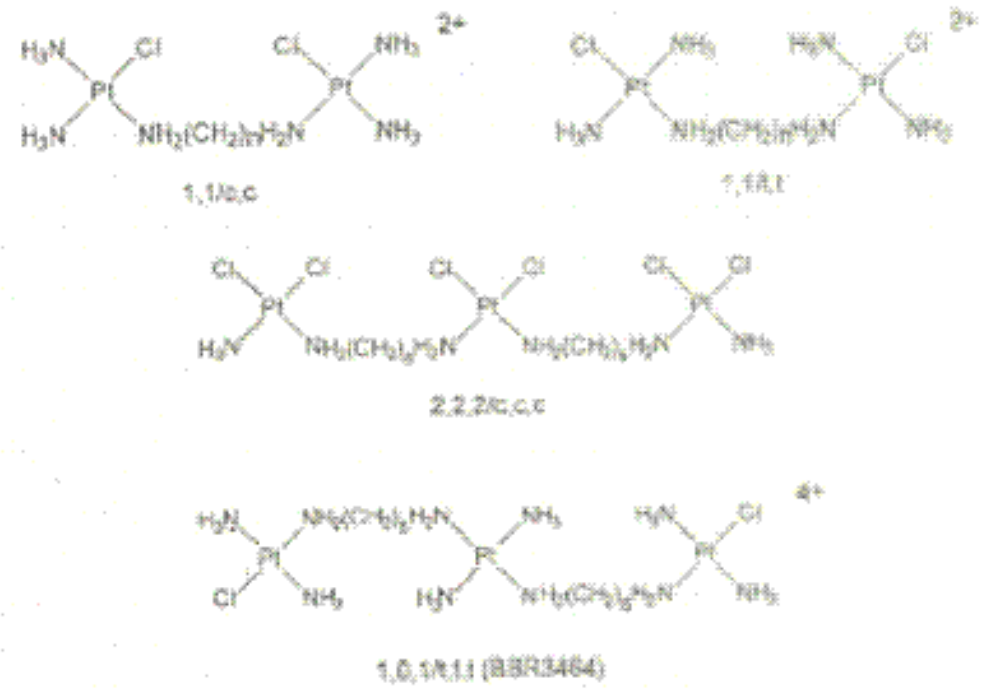
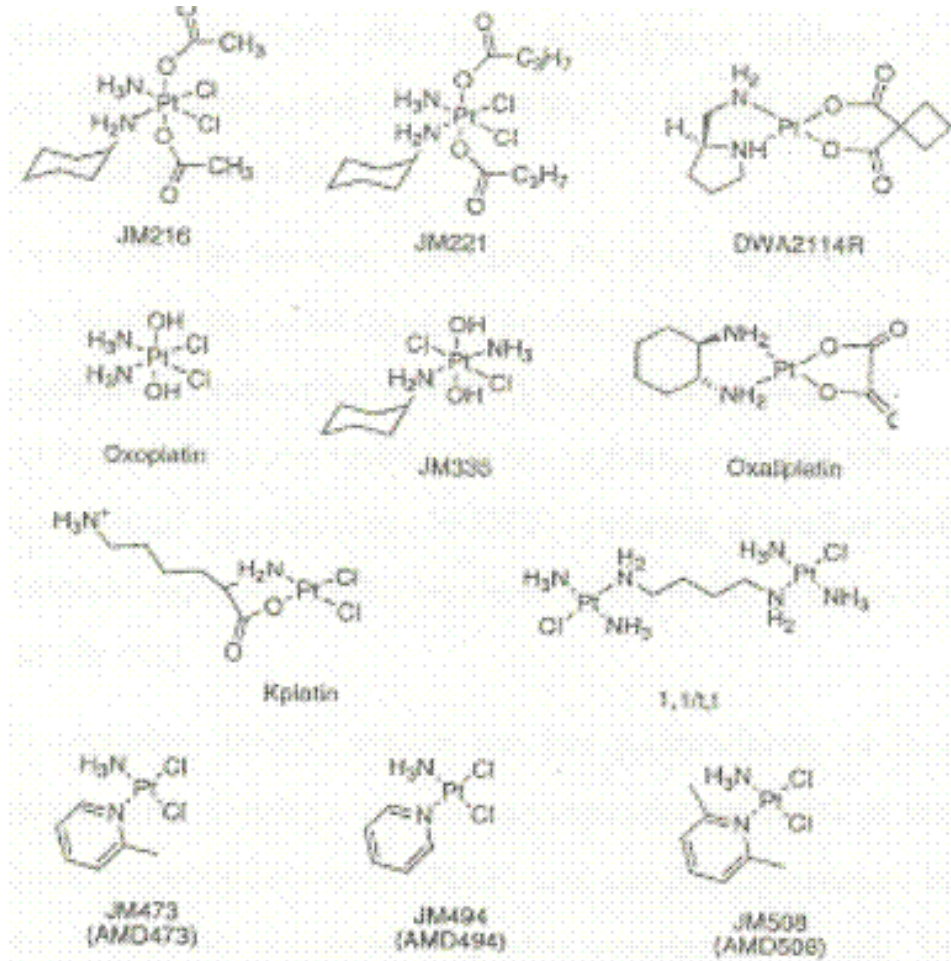
some adduct types preferred  
(and/or more stable than  
others)

1,2-GG and 1,2-AG IACs =  
the main cytotoxic lesions



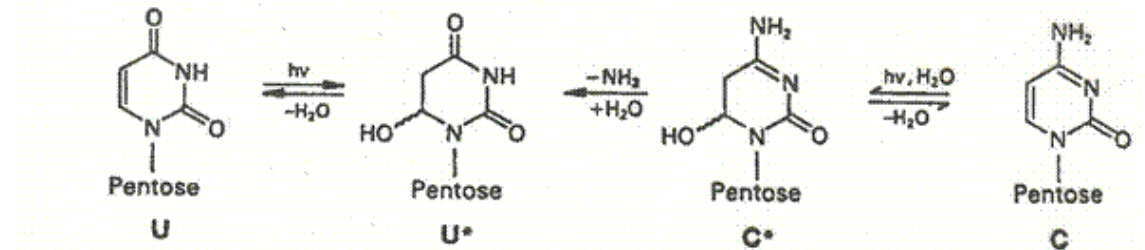


# other platinum complexes tested as cytostatics

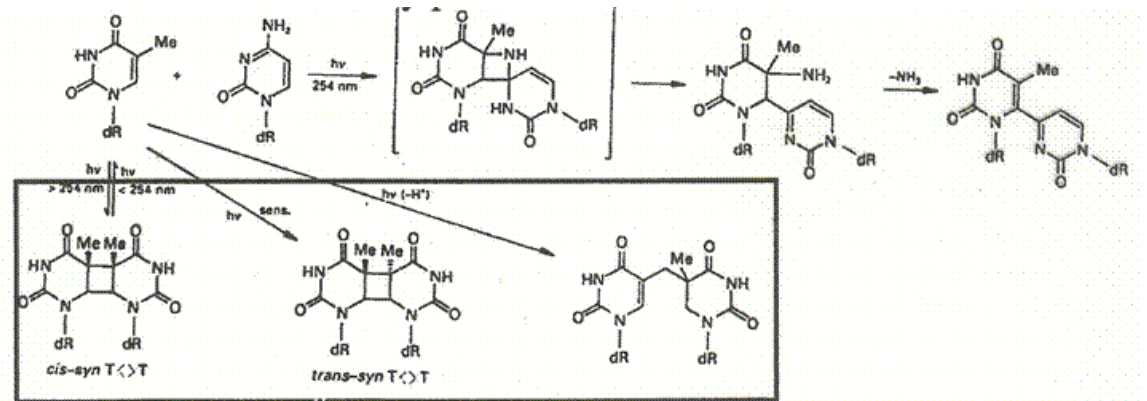


# Photochemical DNA modifications

- mainly pyrimidines
- excitation at 240-280 nm: reactive singlet state
- water addition at C5-C6



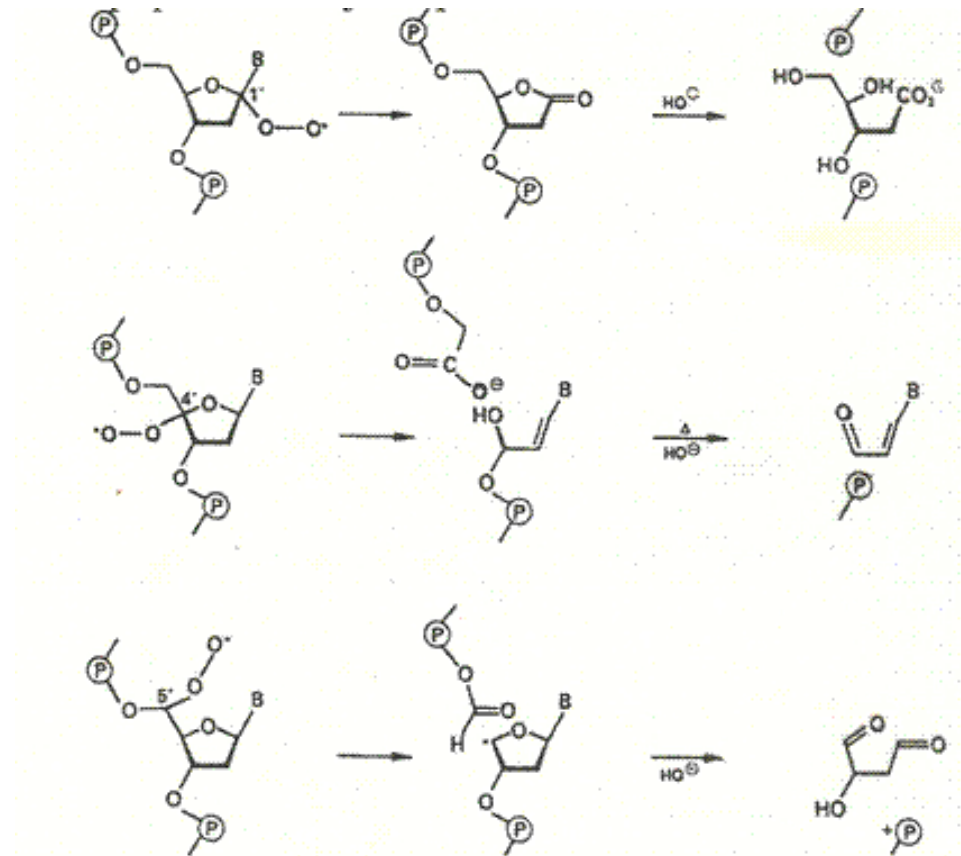
- excitation at 260-280 nm: photodimerization of pyrimidines



- photoproducts of C can deaminate to U (mutagenic effects)

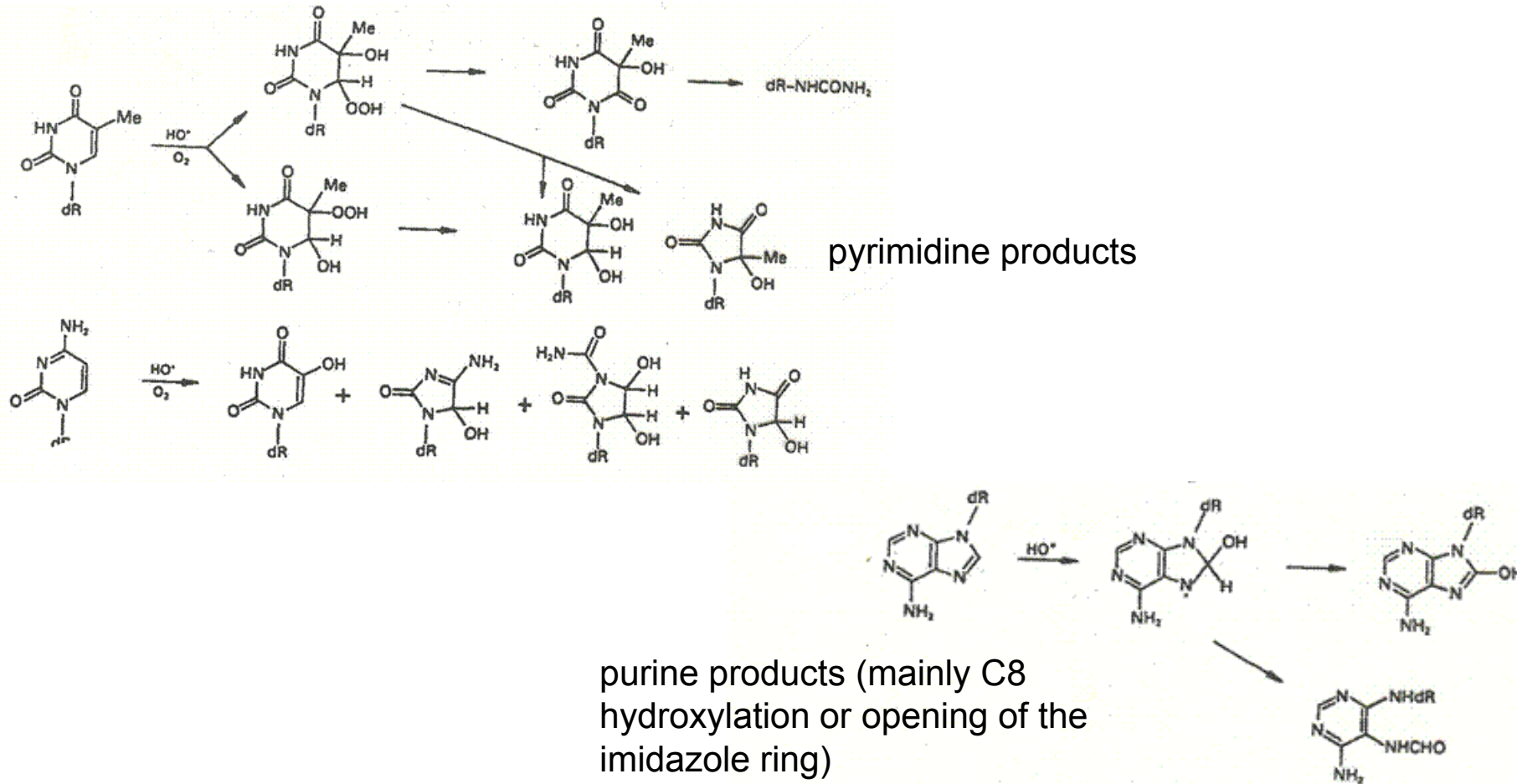
# effects of ionizing radiation

- mostly indirect – through water radiolysis
- each 1,000 eV produces  $\sim 27$   $\bullet\text{OH}$  radicals that attack DNA
- sugar damage: abstraction of hydrogen atoms from C-H bonds
- a series of steps resulting in strand breakage



# effects of ionizing radiation

- base damage: hydroxylation and/or (under aerobic conditions) peroxylation



purine products (mainly C8 hydroxylation or opening of the imidazole ring)

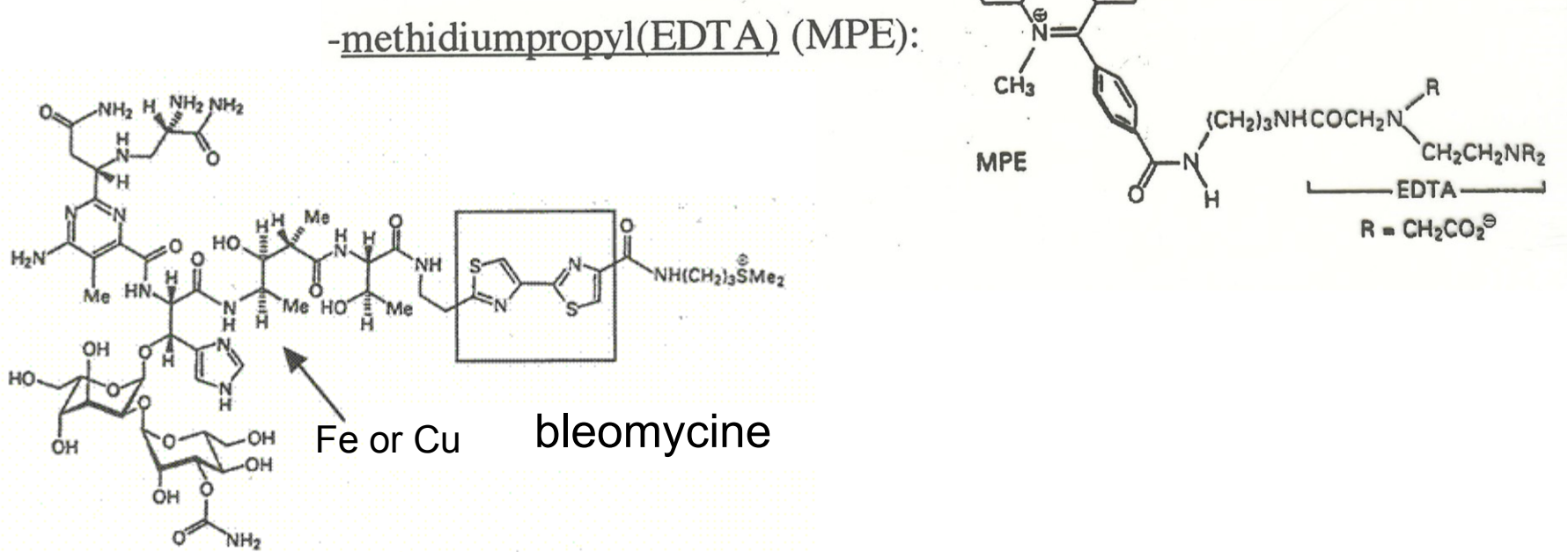
# chemical nucleases

species containing redox active metal ions mediating production of hydroxyl radicals (or other reactive oxygen species) via Fenton and/or Haber-Weiss processes



iron/EDTA complex

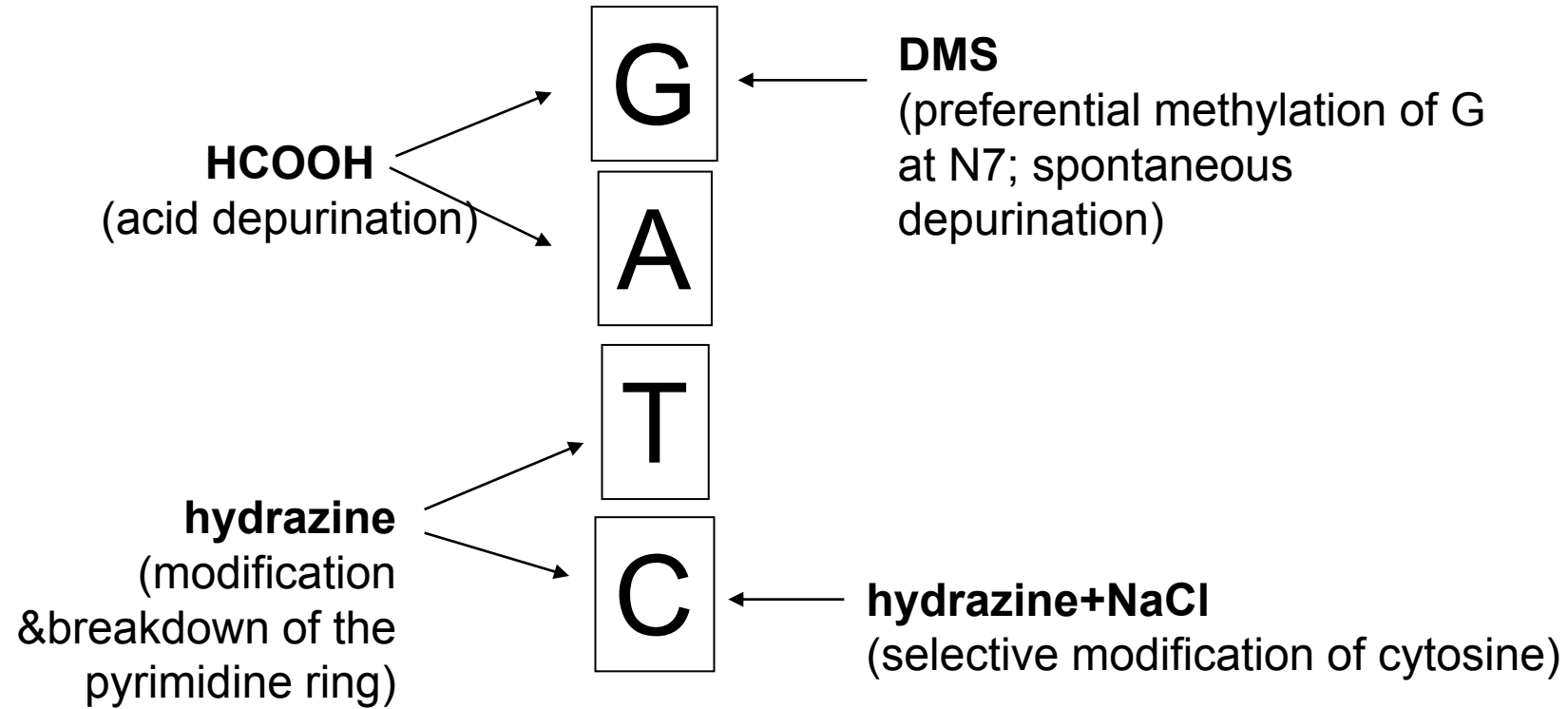
Cu(phen)<sub>2</sub> complex



# Chemical approaches in DNA studies

(several examples)

# Maxam and Gilbert method of DNA sequencing



at sites of base modification (removal) the sugar-phosphate backbone is labile towards alkali

treatment with hot piperidine → cleavage at such sites



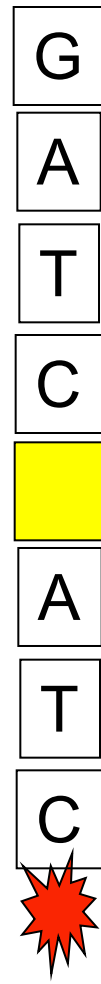
- DNA fragment is end-labeled (radionuclide, fluorophore)
- the sample is divided into four reactions (HCOOH, DMS, hydrazine, hydrazine + NaCl)
- the conditions are chosen to reach only one modification event per DNA molecule



or

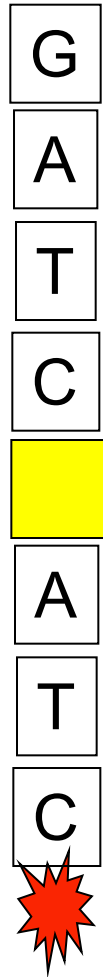


or

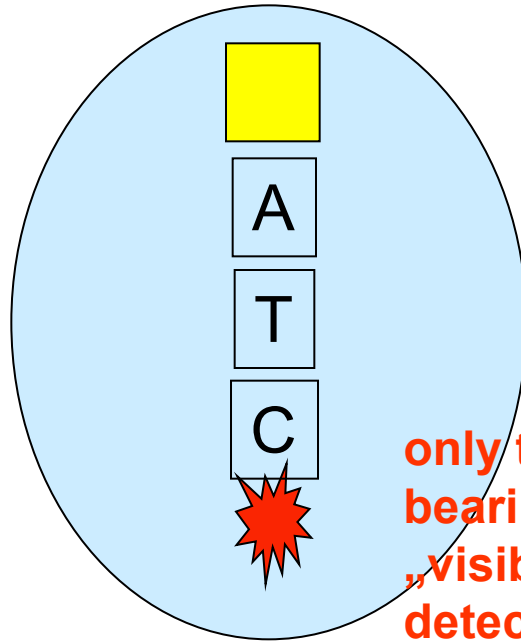


or





piperidine  
→



only the „subfragment“  
bearing the label is  
„visible“ in the following  
detection step

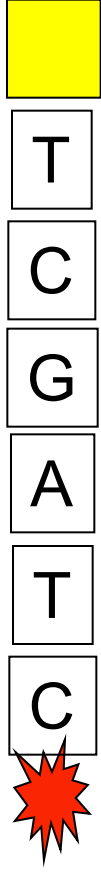


HCOOH

piperidine



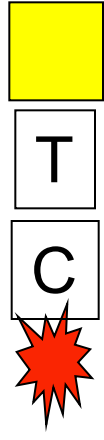
or



or

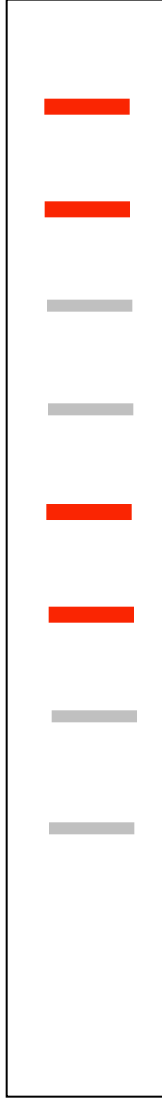


or

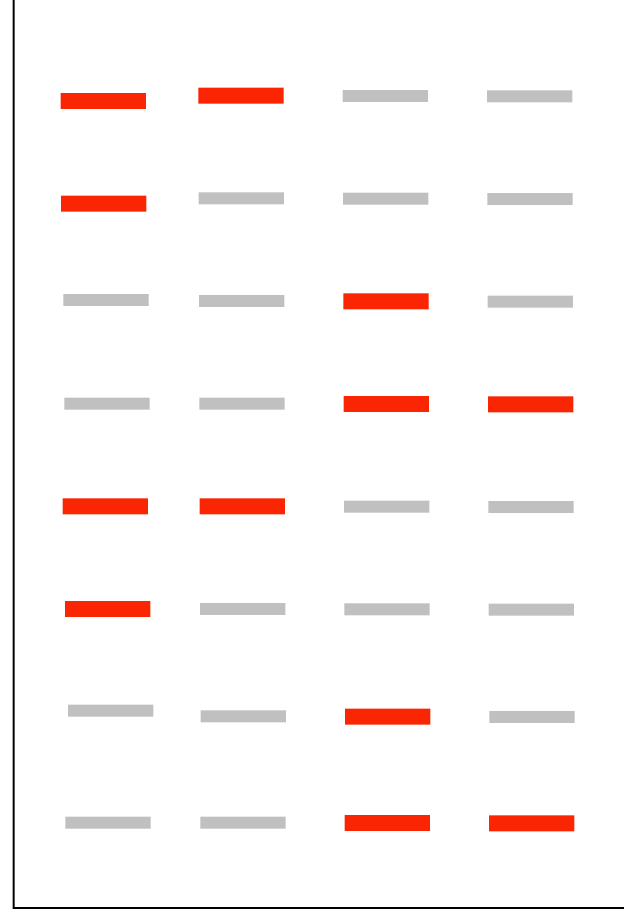


PAGE

autoradiography



G  
A  
T  
C  
G  
A  
T  
C



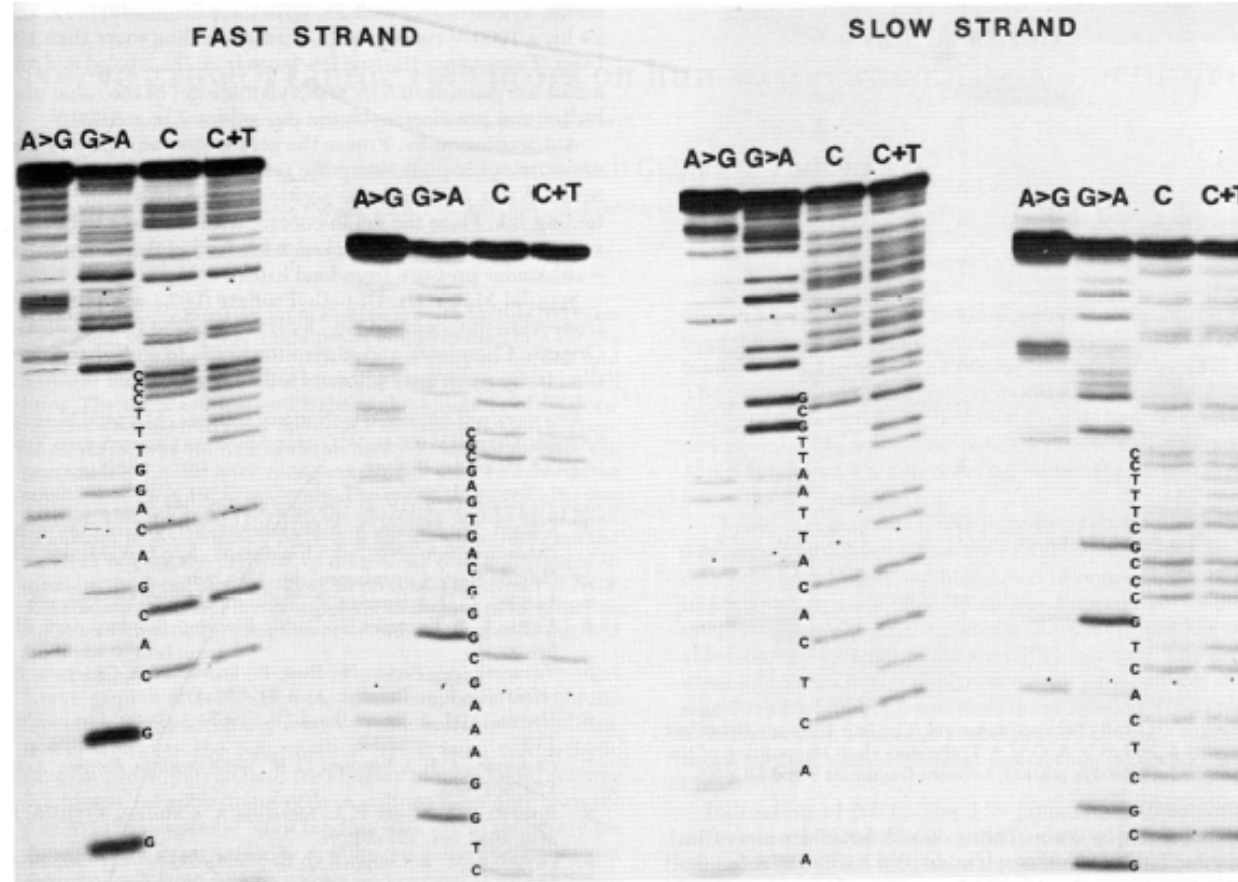
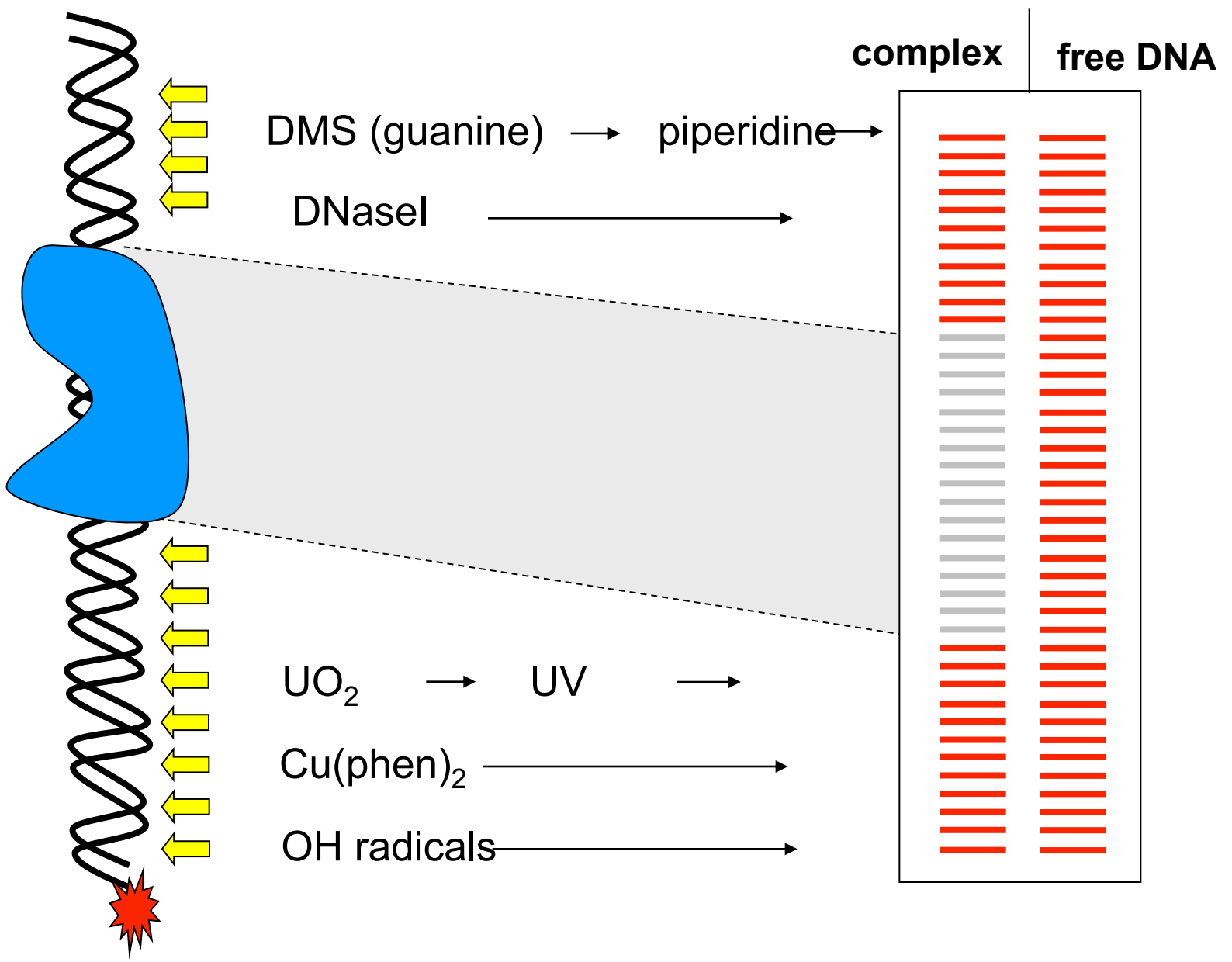


FIG. 2. Autoradiograph of a sequencing gel of the complementary strands of a 64-base-pair DNA fragment. Two panels, each with four reactions, are shown for each strand; cleavages proximal to the 5' end are at the bottom on the left. A strong band in the first column with a weaker band in the second arises from an A; a strong band in the second column with a weaker band in the first is a G; a band appearing in both the third and fourth columns is a C; and a band only in the fourth column is a T. To derive the sequence of each strand, begin at the bottom of the left panel and read upward until the bands are not resolved; then, pick up the pattern at the bottom of the right panel and continue upward. One-tenth of each strand, isolated from the gel of Fig. 1, was used for each of the base-modification reactions. The dimethyl sulfate treatment was 50 mM for 30 min to react with A and G; hydrazine treatment was 18 M for 30 min to react with C and T and 18 M with 2 M NaCl for 40 min to cleave C. After strand breakage, half of the products from the four reactions were layered on a 1.5 x 330 x 400 mm denaturing 20% polyacrylamide slab gel, pre-electrophoresed at 1000 V for 2 hr. Electrophoresis at 20 W (constant power), 800 V (average), and 25 mA (average) proceeded until the xylene cyanol dye had migrated halfway down the gel. Then the rest of the samples were layered and electrophoresis was continued until the new bromphenol blue dye moved halfway down. Autoradiography of the gel for 8 hr produced the pattern shown.

DNA „footprinting“: determination of binding sites  
of other molecules (e.g. proteins)  
at the DNA sequence level



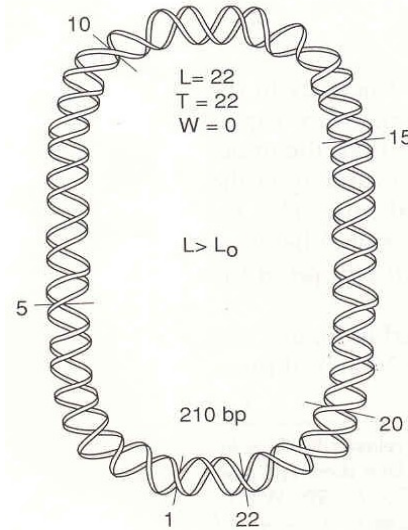


single strand-selective chemical  
probes

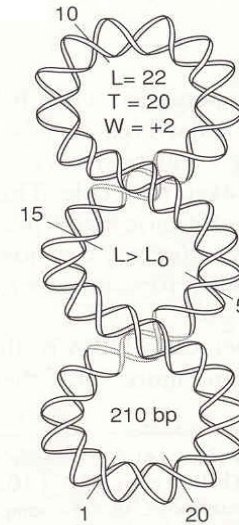
# Open local structures in negatively supercoiled DNA



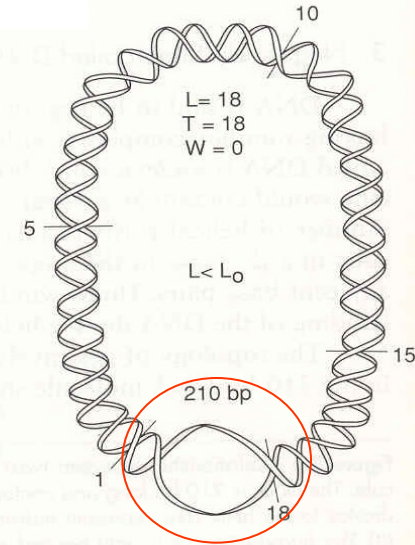
Figure 3.2 Electron micrograph of two forms of DNA. The tangled, twisted molecule is supercoiled DNA, originally called Form I DNA. When circular molecules are relaxed (or nicked) (Form II DNA), they lose the twists. A linear molecule (not shown) is called Form III. The plasmid molecules shown are 9000 bp in length. Courtesy of Jack D. Griffith.



relaxed circular DNA



negatively supercoiled DNA (linking deficit)

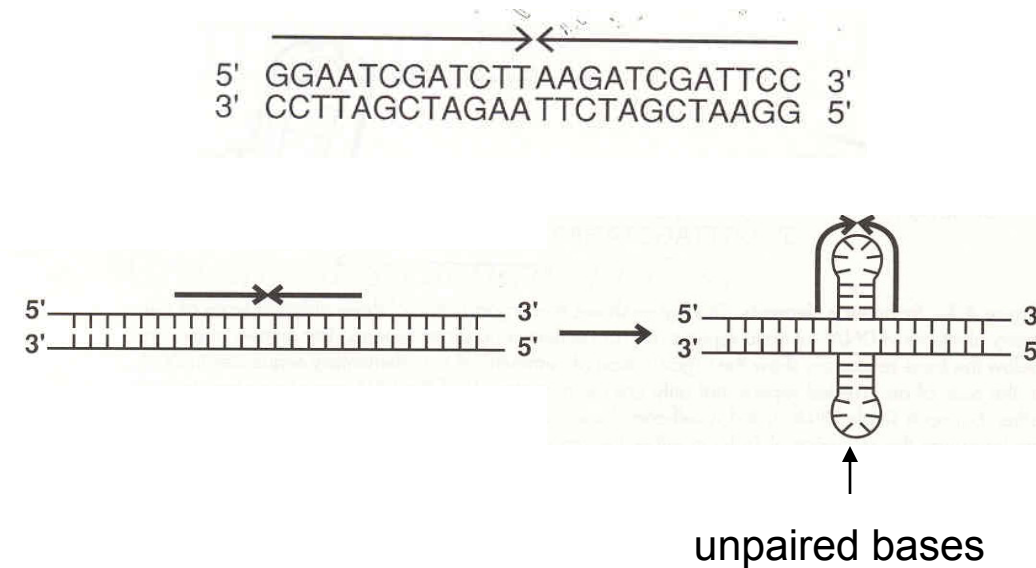


stress related to the negative superhelicity (the linking deficit) can be absorbed in local open structures

# Open local structures in negatively supercoiled DNA

DNA segments of specific sequence can adopt „alternative“ local structures

**cruciform DNA** (inverted repeat)

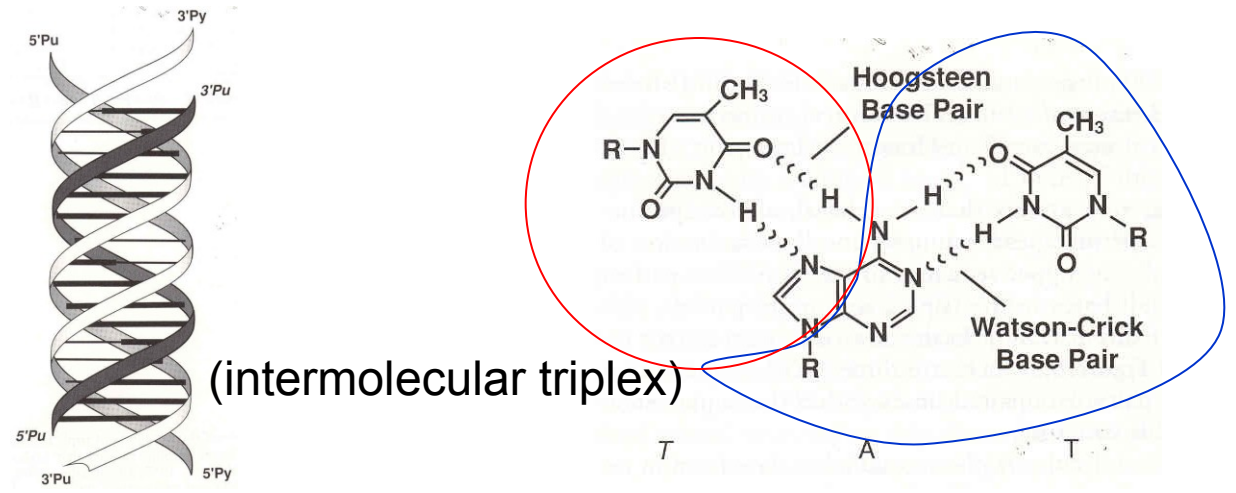


# Open local structures in negatively supercoiled DNA

## Triplex DNA

(homopurine·homopyrimidine stretch with mirror symmetry)

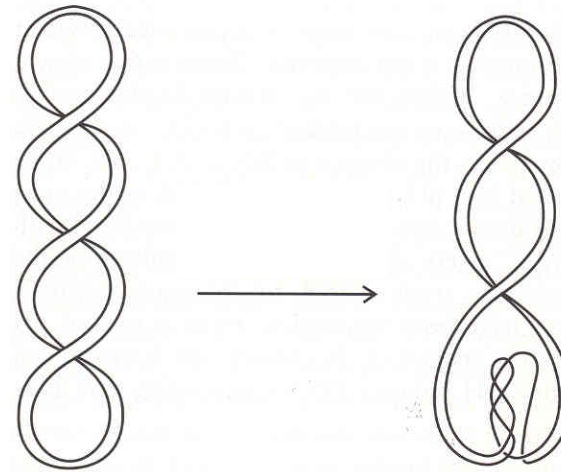
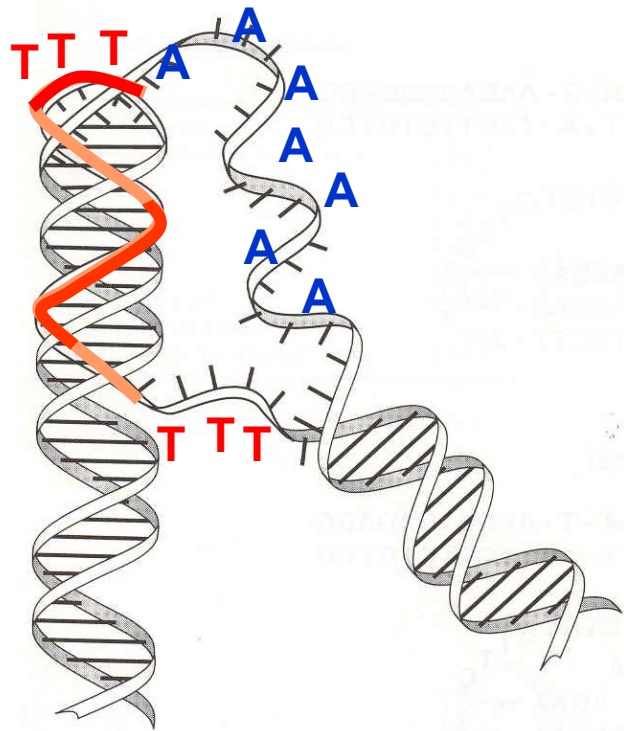
e.g. TTT  
AAA  
TTT



# Otevřené lokální struktury v negativně nadšroubovicové (sc) DNA

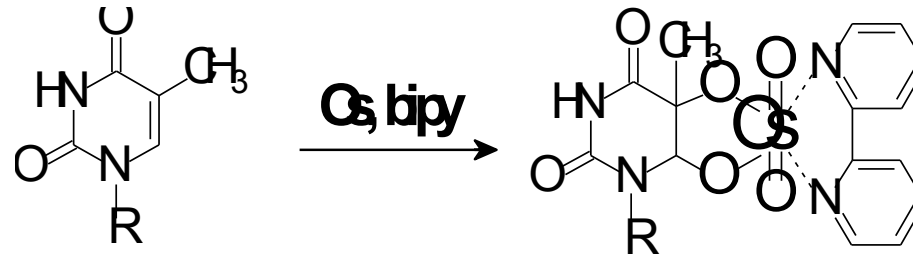
## Intramolecular triplex

(homoPu•homoPy segment within negatively supercoiled DNA)

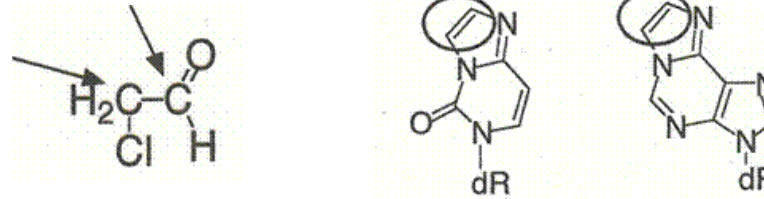


# Chemicals selectively reacting with unpaired bases:

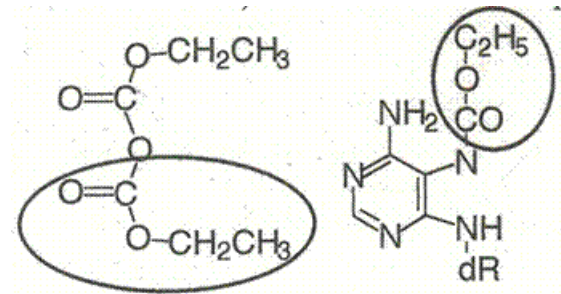
osmium tetroxide complexes  
(Os,L)  
(T, more slowly C)

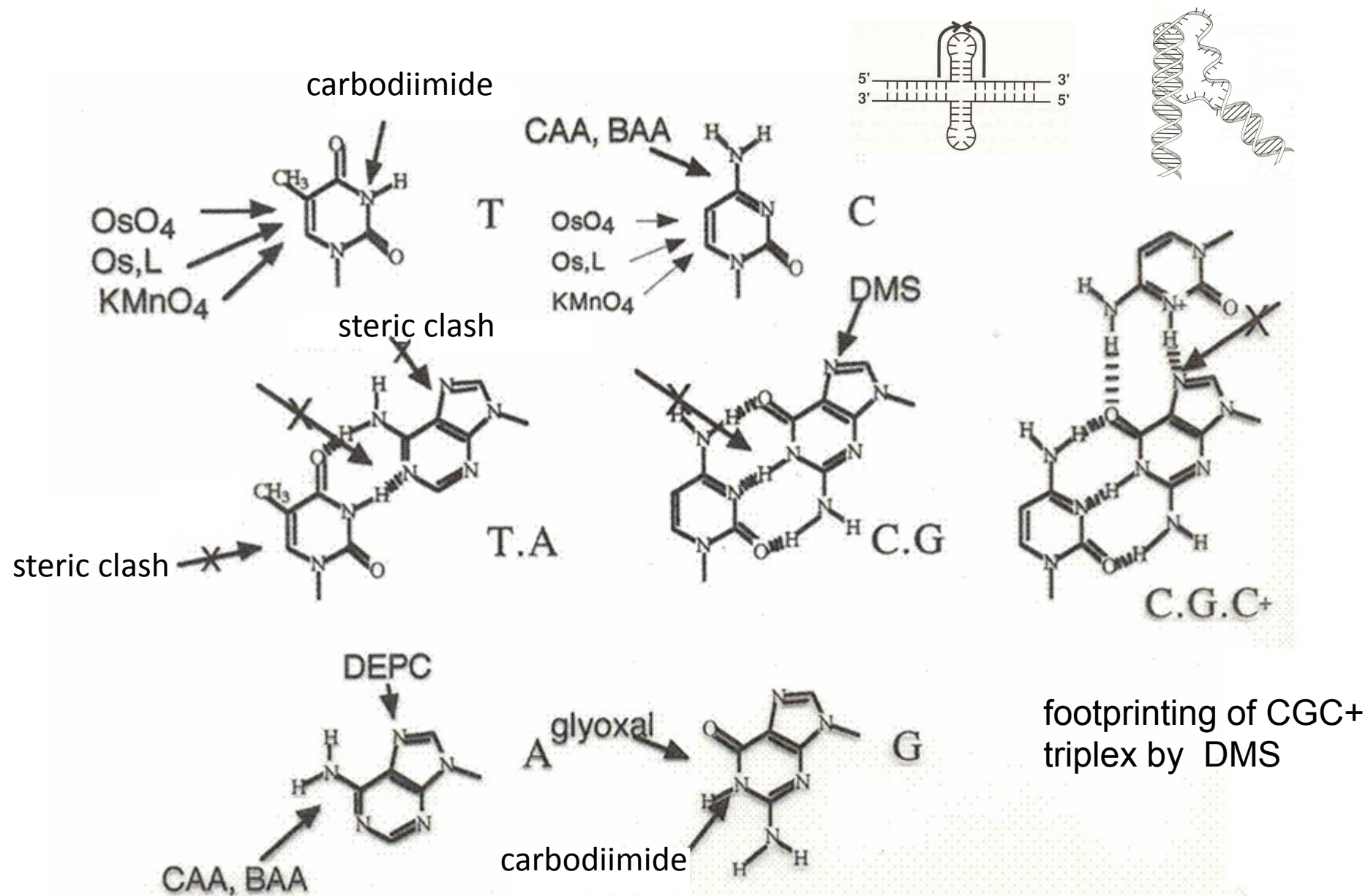


chloroacetaldehyde  
(CAA)  
(A, C)



diethyl pyrocarbonate  
(DEPC)  
(A, G)

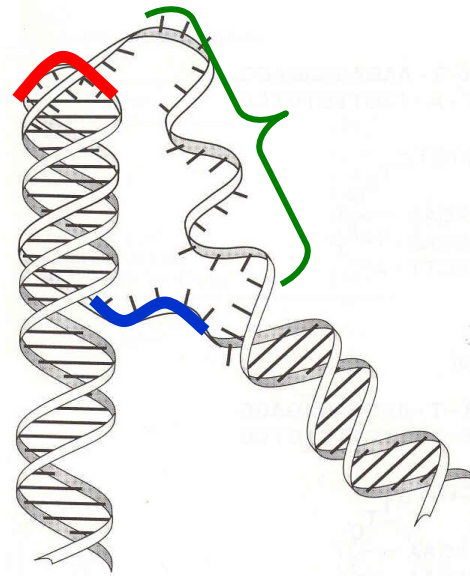




Using the Maxam-Gilbert technique, it is possible to determine with a high preciseness which nucleotides are forming the local structure

- modification of supercoiled DNA
- restriction cleavage, radioactive labeling
- hot piperidine
- sequencing PAGE

the structure can be deduced from the modification pattern



TTTTTTTTTTTTTTTTTTTTTTTTTTTTTTT  
AAAAAAAAAAAAAAAAAAAAAAAAAAAAAAAA

(Note: In the original image, the 11th-15th 'T's in the top strand are red, and the 11th-15th 'A's in the bottom strand are crossed out with a hatched pattern. A pink box highlights the first 10 'T's, a green bracket is under the last 10 'A's, and a pink arrow points from the pink box to the hatched region.)

