

S4001 International Performance Course

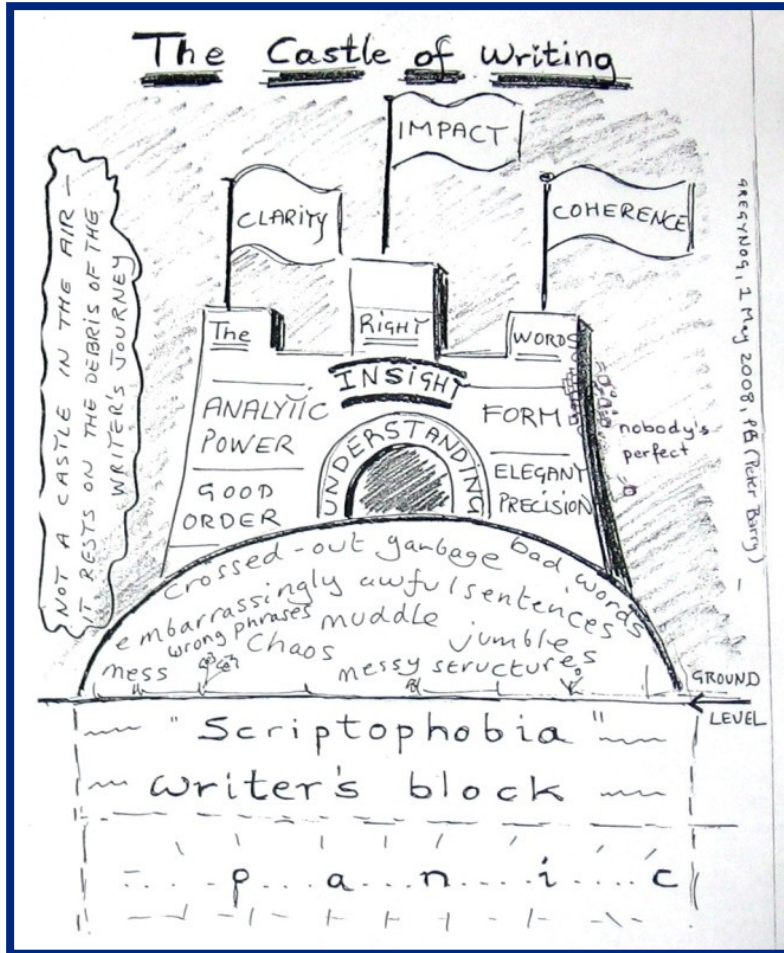

Autumn Term 2019

Academic Writing Introduction

What

Who

Why

Academic Writing Introduction

What is the writing about?

Academic Writing Introduction

Who is writing? Who is the audience?

Academic Writing Introduction

Why is the writing done?



expert

scientific

student

general

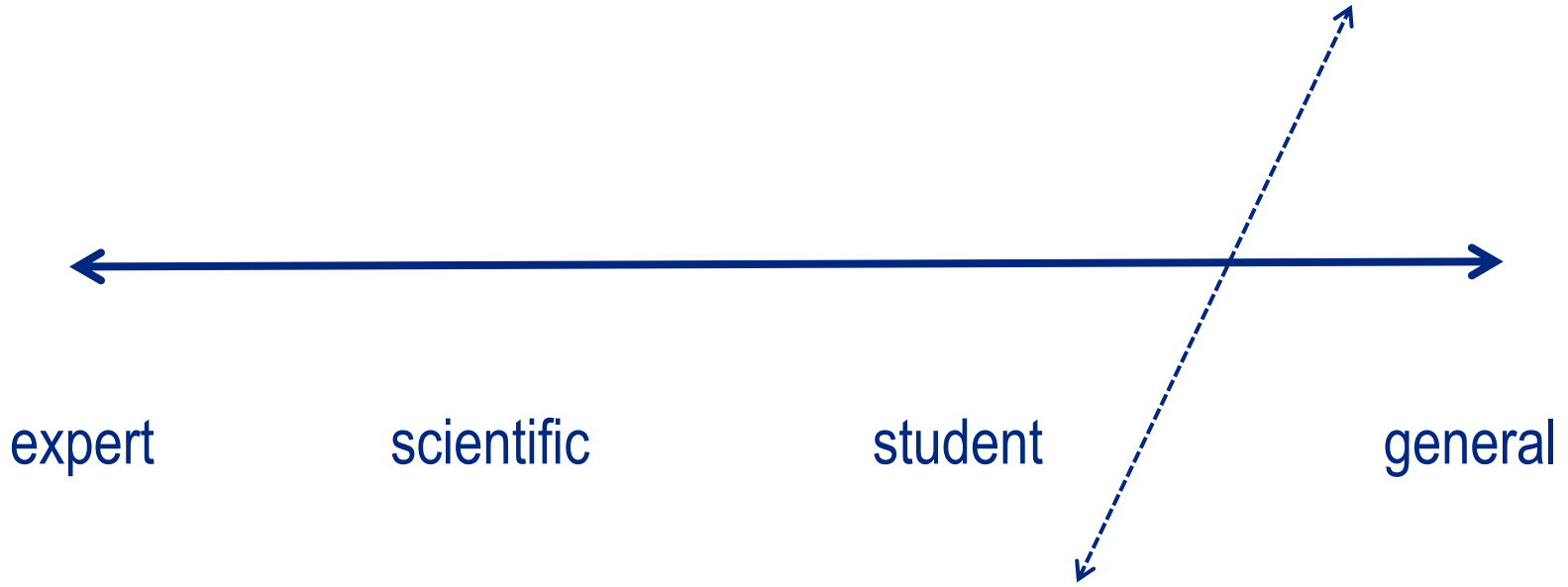

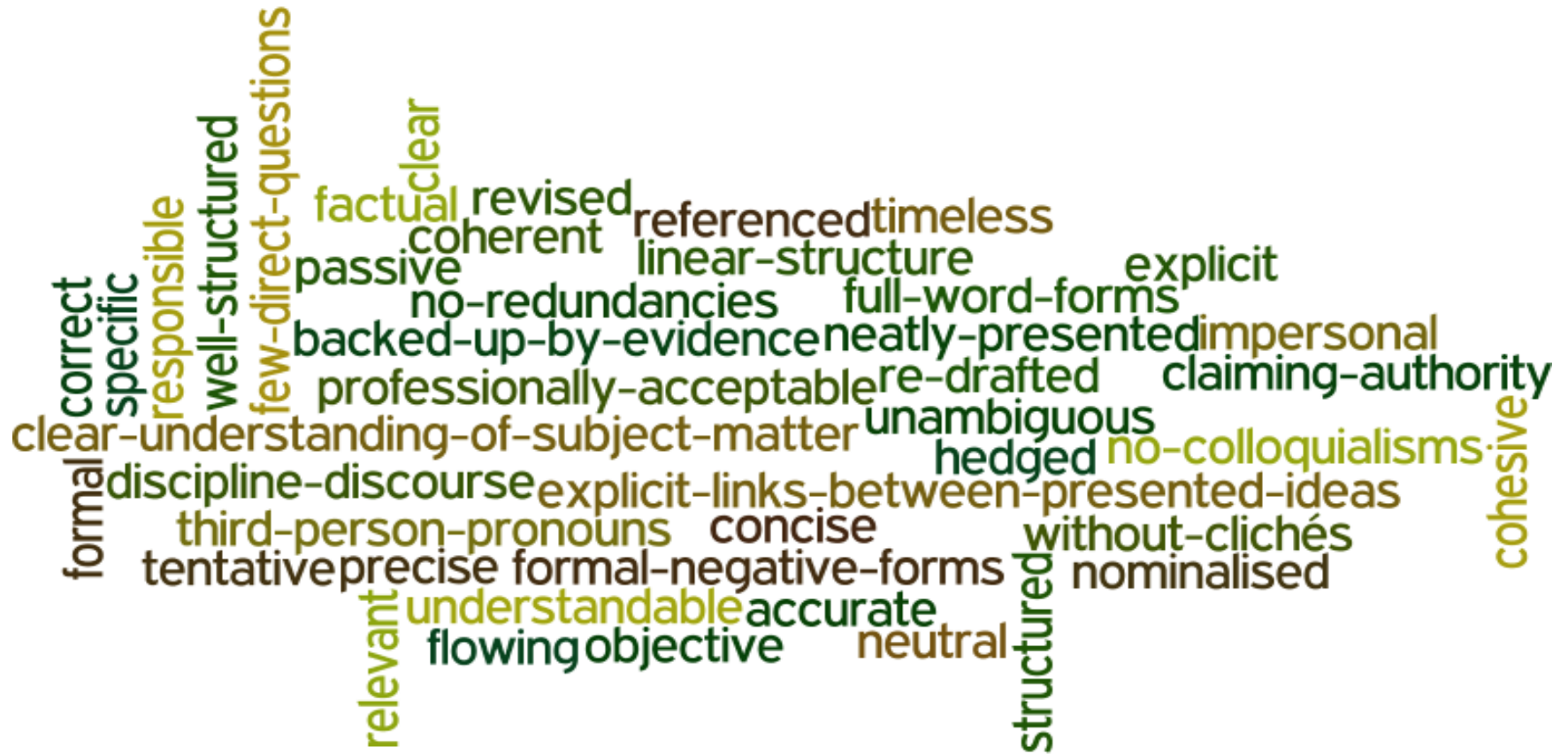

neatly presented

objective

explicit

hedged

frequent third person pronouns

well structured

professionally acceptable

linear structure

without colloquialisms

precise

claiming authority

more frequent passive voice

with explicit links between presented ideas

with clear understanding of the subject matter

relevant within the discourse of your discipline

cohesive

correct

factual

unambiguous

accurate

neutral

revised

timeless

re-drafted

clear

formal

impersonal

with full forms of words

without redundancies

with flowing structure

without clichés

responsible

backed up by evidence

understandable

specific

referenced

nominalised

tentative

no negative forms

coherent

concise

style



(Adapted from: <http://www.chemistry-blog.com/category/fun/page/2/>)

a) It rained cats and dogs yesterday, didn't it?

b) What a downpour last night!

c) The UK Meteorology Office monitored a heavy rainfall with the rate of precipitation reading 46 millimetres per hour on 24th March 2011 in North Cumbria.

d) She was standing there in the storm waiting for deafening thunder to come, feeling the water cooling the air and thinking of how heavy the drops of water must be so that they could fall down from the dark clouds and make her feel refreshed and so light that she could fly, and make her full of energy, make her appreciate the eternal life it delivers, when finally she realised this precipitation was indeed a friend, her only true friend.

style



It rained cats and dogs yesterday, didn't it?

style

What a downpour last night!



style

The UK Meteorology Office monitored a heavy rainfall with the rate of precipitation reading 46 millimetres per hour on 24th March 2011 in North Cumbria.

style

She was standing there in the storm waiting for deafening thunder to come, feeling the water cooling the air and thinking of how heavy the drops of water must be so that they could fall down from the dark clouds and make her feel refreshed and so light that she could fly, and make her full of energy, make her appreciate the eternal life it delivers, when finally she realised this precipitation was indeed a friend, her only true friend.



concise writing

concise writing

Concise writing presents information that is important to the reader.

There are no unnecessary words, sentences or paragraphs.

Redundant expressions and structures are eliminated or replaced wordy with more concise words or phrases that have the same meaning.

Chromatography is an experimental technique used by chemists as a means to help them separate different compounds in experimental samples using the affinity of the compound for the mobile phase as well as the affinity of the compound for the stationary phase.

[42 words]

Chromatography is an experimental technique used by chemists as a means to help them separate different compounds in experimental samples using the affinity of the compound for the mobile phase as well as the affinity of the compound for the stationary phase.

[42 words]

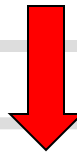

Chromatography is an experimental technique used by chemists to separate compounds in experimental samples using the affinity of the compound for the mobile phase as well as the affinity of the compound for the stationary phase.

[36 words]

Chromatography is an experimental technique used by chemists as a method to separate compounds *in experimental samples* using the affinity of the compound for the mobile phase as well as the affinity of the compound for the stationary phase. [36 words]

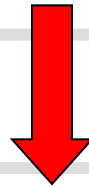

Chromatography is used to separate compounds using the affinity of the compound for the mobile phase as well as the affinity of the compound for the stationary phase. [28 words]

[42 words]

Chromatography is an experimental technique used by chemists as a
r Chromatography is an experimental technique used by chemists to
s separate compounds *in experimental samples* using the affinity of the
a Chromatography is used to separate compounds using the
c affinity of the compound for the mobile phase as well as the
affinity of the compound for the stationary phase. [28 words]



Chromatography separates compounds based on the affinity of the
compound for the mobile phase relative to the stationary phase.

[19 words]

formality

formality

- a) Essential measures should be undertaken at the earliest opportunity.
- b) You should do whatever you have to as soon as you can.
- c) One should undertake any necessary measures at the earliest opportunity.

de-personalisation

On self-mention in academic articles: Frequency of self-mention forms per discipline (Ø per 10,000 words).

Discipline	Total	Citation	I	Me	My	We	Us	Our	Other
Physics	64,6	8,7	0,0	0,1	0,0	39,3	0,6	14,4	1,4
Marketing	61,3	6,9	1,6	0,0	0,7	31,0	1,1	18,9	0,6
Biology	56,2	22,6	0,0	0,1	0,1	24,0	1,1	7,2	0,7
Philosophy	52,7	3,1	35,6	2,5	7,7	1,4	0,2	0,6	0,0
Electronic eng.	44,4	10,7	0,0	0,0	0,0	23,3	0,4	8,6	0,5
Mechanical eng.	17,8	9,6	0,0	0,0	0,0	5,5	0,0	1,4	0,4
Overall	50,5	8,3	11,2	0,8	2,4	17,8	0,8	8,3	1,1

Adapted from: K. Hyland/English for Specific Purposes 20 (2001) 207-226

All manuscripts must...be written in objective third person point of view throughout (Use "the authors" or "the researchers" NOT "I" or "we")...

(Adapted from: <http://www.igi-global.com/publish/contributor-resources/before-you-write/>)

passive vs active

Percentages of voice per section in the processes of three types of sciences in 21 research articles.

	Introduction		Method		Results		Discussion	
	A	P	A	P	A	P	A	P
Physical sciences	63,0	37,0	26,0	74,0	72,0	28,0	71,0	29,0
Biological sciences	74,0	26,0	38,0	61,05	68,0	32,0	79,0	21,0
Social sciences	84,0	16,0	46,0	54,0	77,0	23,0	85,0	15,0

A=active, P=passive

Source: I.A.Martinez/English for Specific Purposes 20 (2001) 227-247)

NOTE: *To read more on passive: Lilita Rodman: The passive in technical and scientific writing; <http://www.jaconlinejournal.com/archives/vol2/rodman-passive.pdf>*

Percentages of voice per section in the processes of three types of sciences in 21 research articles.

	Introduction		Method		Results		Discussion	
	A	P	A	P	A	P	A	P
Physical sciences	63,0	37,0	26,0	74,0	72,0	28,0	71,0	29,0
Biological sciences	74,0	26,0	38,0	61,05	68,0	32,0	79,0	21,0
Social sciences	84,0	16,0	46,0	54,0	77,0	23,0	85,0	15,0

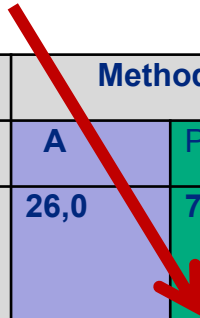

A=active, P=passive

Source: I.A.Martinez/English for Specific Purposes 20 (2001) 227-247)

NOTE: *To read more on passive: Lilita Rodman: The passive in technical and scientific writing; <http://www.jaconlinejournal.com/archives/vol2/rodman-passive.pdf>*

We **should reject** this conclusion for two reasons.

VS

This conclusion **should be rejected** for two reasons.

...

It is unclear at this time as to what extent cremophore is responsible for these side effects, but similar hypersensitivity **reactions** in dogs **have been attributed** to histamine release by cremophore EL.

Experts **presented** and **discussed** a total of ten innovative papers during the two-day workshop sessions.

VS

A total of ten innovative papers
were presented and discussed
during the two-day workshop sessions.

To measure the number of gene copies the **cellular DNA is broken** into small pieces, **the double strands are denatured** (**separated** into single strands) by boiling, and **a small amount of the radioactively labeled complementary DNA is added** to the mixture under experimental conditions.

nominalisation

You can understand something better if it is repeated.

You can understand something better if it is repeated.



Comprehension is aided by repetition.

This can serve as a template,
thanks to which proteins can be synthesised.



This can serve as a template
for the synthesis of proteins.

The body temperature rose suddenly,
as a consequence, the invading pathogen
grew less quickly.



The sudden rise in body temperature may also have
caused the inhibition of the growth
of the invading pathogen.

The body temperature rose suddenly,
as a consequence, the invading pathogen
grew less quickly.



The **sudden rise** in body temperature **may also have**
caused the **inhibition** of the **growth**
of the invading pathogen.

Incomplete implementation of strategized programmatic was designated to maximize acquisition of awareness and utilization of communication skills pursuant to standardized review and assessment of linguistic development.

Incomplete implementation of strategized
programmatics was designated to maximize acquisition
of awareness and utilization of communication skills
pursuant to standardized review and assessment
of linguistic development.

Adapted from: http://stevenpinker.com/files/pinker/files/why_academics_stink_at_writing.pdf

coherence and cohesion

Original version

Some of the on-going methods are used to prevent the transmission of the mutant mitochondria; of these methods, the pre-implantation genetic diagnostic and the prenatal diagnostic tests, they are used to analyse cells obtained from the embryo but both techniques are inefficient in predicting the exact level of heteroplasmy in the whole embryo (Chiaratti *et al.*, 2011). With the use of maternal spindle transfer, the expected outcome is the delivery of off-springs that are genetically related to both of their parents, as

Reformulated version

A number of methods are used to prevent the transmission of mitochondria. For example, the pre-implantation genetic diagnostic and the prenatal diagnostic test are used to analyse cells obtained from the embryo. Neither method, however, is able to predict the exact level of heteroplasmy in the embryo (Chiaratti et al 2011). By using the maternal spindle transfer, we can expect the delivery of off-springs that are genetically related to both of their parents.

Adapted from: Ellwood, C.(2011)

Original version	Reformulated version
<p>Some of the on-going methods are used to prevent the transmission of the mutant mitochondria; of these methods, the pre-implantation genetic diagnostic and the prenatal diagnostic tests, they are used to analyse cells obtained from the embryo but both techniques are inefficient in predicting the exact level of heteroplasmy in the whole embryo (Chiaratti <i>et al.</i>, 2011). With the use of maternal spindle transfer, the expected outcome is the delivery of off-springs that are genetically related to both of their parents, as</p>	<p>A number of methods are used to prevent the transmission of mitochondria. For example, the pre-implantation genetic diagnostic and the prenatal diagnostic test are used to analyse cells obtained from the embryo. Neither method, however, is able to predict the exact level of heteroplasmy in the embryo (Chiaratti et al 2011). By using the maternal spindle transfer, we can expect the delivery of off-springs that are genetically related to both of their parents.</p>

Adapted from: Ellwood, C.(2011)

A number of methods are used to prevent the transmission of mitochondria. For example, the pre-implantation genetic diagnostic and the prenatal diagnostic test are used to analyse cells obtained from the embryo. Neither method, however, is able to predict the exact level of heteroplasmy in the embryo (Chiaratti et al 2011). By using the maternal spindle transfer, we can expect the delivery of off-springs that are genetically related to both of their parents.

hedging language of caution tentative language

Academic writing might give the impression that it is factual, conveying precise, accurate and objective facts and information. “However, it is now recognised that an important feature of academic writing is the concept of cautious language, often called *hedging*.” In other words, it is necessary to make decisions about your stance on a particular subject, or the strength of the claims you are making.”

Hedge Class	Function
<p>Shields Devices that take responsibility for the claim made away from the author. They function as a tool protecting the author from any criticism. The writer aims at not being on record with regard to the propositions expressed in the text.</p>	<p>Responsibility shifting e.g. ...([1], [2], [3],)..., ...it is shown in [3]..., Romanowska found..., ...we refer reader to [3, 4]..., ...see [10]...</p>
	<p>Speaking facts The writer shields his/her claims through stating “the commonly accepted” view. e.g. Definition 1..., A map is..., ...is defined to be..., ...space is said to be...</p>
<p>Mitigators The author admits his/her responsibility for the claims made. The writer takes stance while using mitigators, but decides to weaken his/her propositions for various reasons.</p>	<p>Approximation e.g. ...some..., ...more..., Several, ...similar...</p>
	<p>Possibility e.g. ...may..., ...can..., ...possible...</p>
	<p>Understatement By using these devices, authors lessen the importance and the validity of their claims. e.g. ...notions..., ...concept...</p>
	<p>Admitting incompleteness e.g. ...briefly..., however,...</p>

Introductory verbs	e.g. seem, tend, look like, appear to be, think, believe, doubt, be sure, indicate, suggest
Modal verbs	e.g. would, may, might, could
Frequency adverbs	e.g. often, sometimes, usually
Modal adverbs / adjectives	e.g. probably, possibly / probable, possible
Modal nouns	e.g. assumption, possibility, probability
“That” clauses	e.g. It could be the case that.... It might be suggested that...
“To”-clause + adjective	e.g. It may be possible to obtain

In addition, **to the best of our knowledge**,
there is no facile and practical method for
the synthesis of this compound in the literature.

This system prevents attacks on both server and client sides.



According to simulation studies, under some circumstances this system may reduce certain types of attacks on both server and client sides.



It could be concluded that some evidence seems to suggest that this system might, under some circumstances, have the tendency to reduce at least certain types of attacks on both server and client sides

The fluorescence lifetime measurement of the diol/carbonate pair **will be complete** in two months.

The fluorescence lifetime measurement of the diol/carbonate pair **is expected to be complete** in two months.

It is estimated that in the next fifty years the world's population **might again grow** 40-50% and if we continuously **used** the amount of water that we are currently using the water supply **may** significantly diminish.

In the next fifty years the world's population **will again grow** 40-50% and if we continuously **use** the amount of water that we are currently using the water supply **will** significantly diminish.

accuracy and precision

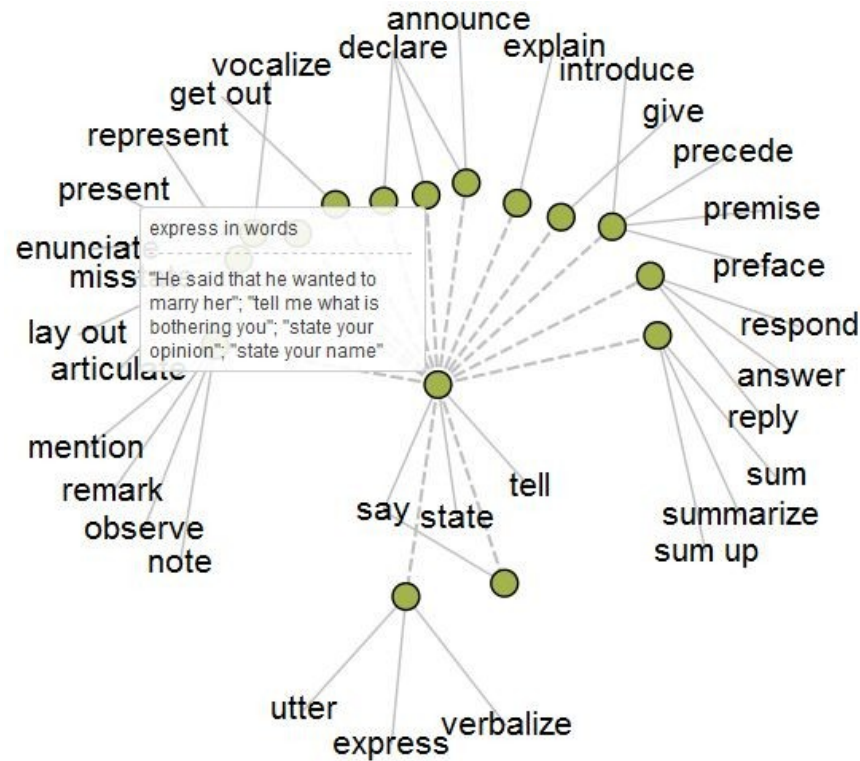

Lastly, I have to say, I'm still not convinced about the value of the word "suggest". The fact is, we do use it in microbiology as a verb with positive meaning - I would even say as a synonym for "prove", because of course, it's biology who dares to say "it proves" :D
I'm actually going to undertake a research among colleagues, because I'm really curious if it's just a mistake of our group, or if it's some field-connected thing.

In their study, Lakhina, Crovella and Diot

<i>important</i>	<i>exploratory</i>
<i>small scale</i>	<i>preliminary</i>
<i>ambitious</i>	<i>impressive</i>
<i>significant</i>	<i>rigorous</i>
<i>limited</i>	<i>simple</i>
<i>original</i>	<i>complex</i>
<i>remarkable</i>	<i>modest</i>
<i>useful</i>	
<i>traditional</i>	

The noble gases, namely neon and radon, are under standard conditions odourless and colourless.

Herbivores that feed mainly or only on plants form an important link in the food chain.

The noble gases, **for example** neon and radon, are under standard conditions odourless and colourless.

Herbivores, **which** feed mainly or only on plants, form an important link in the food chain.

It is



certain

almost certain

very probable / highly likely

probable / likely

possible

unlikely

very / highly unlikely

...that we will experience similar reactions when acids are used.

A

titles

B

C

D

sentences

This sentence has five words. Here are five more words.
Five-word sentences are fine. But several together become
monotonous. Listen to what is happening. The writing is
getting boring. The sound of it drones. It's like a stuck record.
The ear demands some variety.

Now listen. I vary the sentence length, and I create music.
Music. The writing sings. It has a pleasant rhythm, a lilt, a
harmony. I use short sentences. And I use sentences of
medium length. And sometimes when I am certain the reader
is rested, I will engage him with a sentence of considerable
length, a sentence that burns with energy and builds with all
the impetus of a crescendo, the roll of the drums, the crash of
the cymbals—sounds that say listen to this, it is important.

So write with a combination of short, medium, and long
sentences. Create a sound that pleases the reader's ear. Don't
just write words. Write music.

-Gary Provost

Since it was, as mentioned, a test, we did not try to achieve the best results, we just wanted to verify the idea of time characteristics.



The(Our) intention was to verify **(its)** time characteristics **(of...)** by means of a **(...)** test.

paragraphs



Adapted from: <https://www.youtube.com/watch?v=vN4afrr33Ac>

parallel structures...

This report was researched by Steve, written by Joan,
and **the editing was done by Justin.**

This report was **researched by** Steve, **written by** Joan,
and **edited by** Justin.

Writing essays is not easy because it takes time and care and
careful thinking.

Writing essays is not easy because it takes time, care and
thought.

Many gases are invisible, odourless, and **they have no taste.**

Many gases are invisible, odourless, and **tasteless.**



It was the best of times, it was the worst of times,
it was the age of wisdom, it was the age of foolishness,
it was the epoch of belief, it was the epoch of incredulity,
it was the season of Light, it was the season of Darkness,
it was the spring of hope, it was the winter of despair.

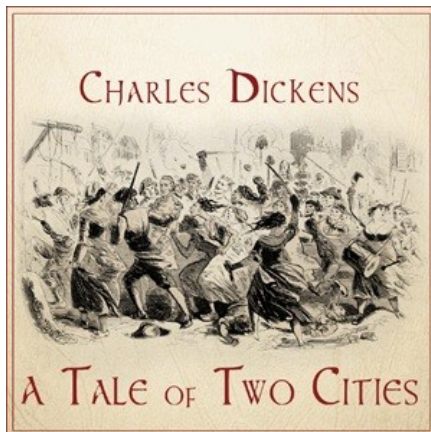

Charles Dickens: A Tale of Two Cities, 1859

A house divided against itself **cannot stand**.

I believe this government **cannot endure**, permanently half slave and half free.

I do not expect the Union to be dissolved.

I do not expect the house to fall.

But I do expect it will cease to be divided.

It will become all one thing, or all the other.

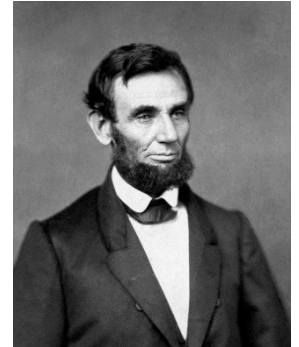

Abraham Lincoln, 1858

The present study was conducted to determine the prevalence of *Listeria monocytogenes* in smoked fish in Sokoto, Nigeria. A total of 115 different species of smoked fish from the various retail outlets and market places within the metropolis were analysed for the presence of *L. monocytogenes* using ISO culture method. Out of the 115 samples analysed, 29 (25%) were positive for *L. monocytogenes*. Other *Listeria* species isolated in this study were *L. grayi* 13 (11%), *L. innocua* 10 (9%) and *L. ivanovi* 15 (13%). The remaining 48 (42%) of the sample were negative for *Listeria* species. The study shows that *L. monocytogenes* and other *Listeria* species are common contaminant of smoked fish, and this may pose serious public health implications. (Salihu et al., 2008)

.....was conducted to determine

.... were analysed

...% were positive for

.... were ...%

...% were negative for ...

The study shows thatare ...

.... this may pose

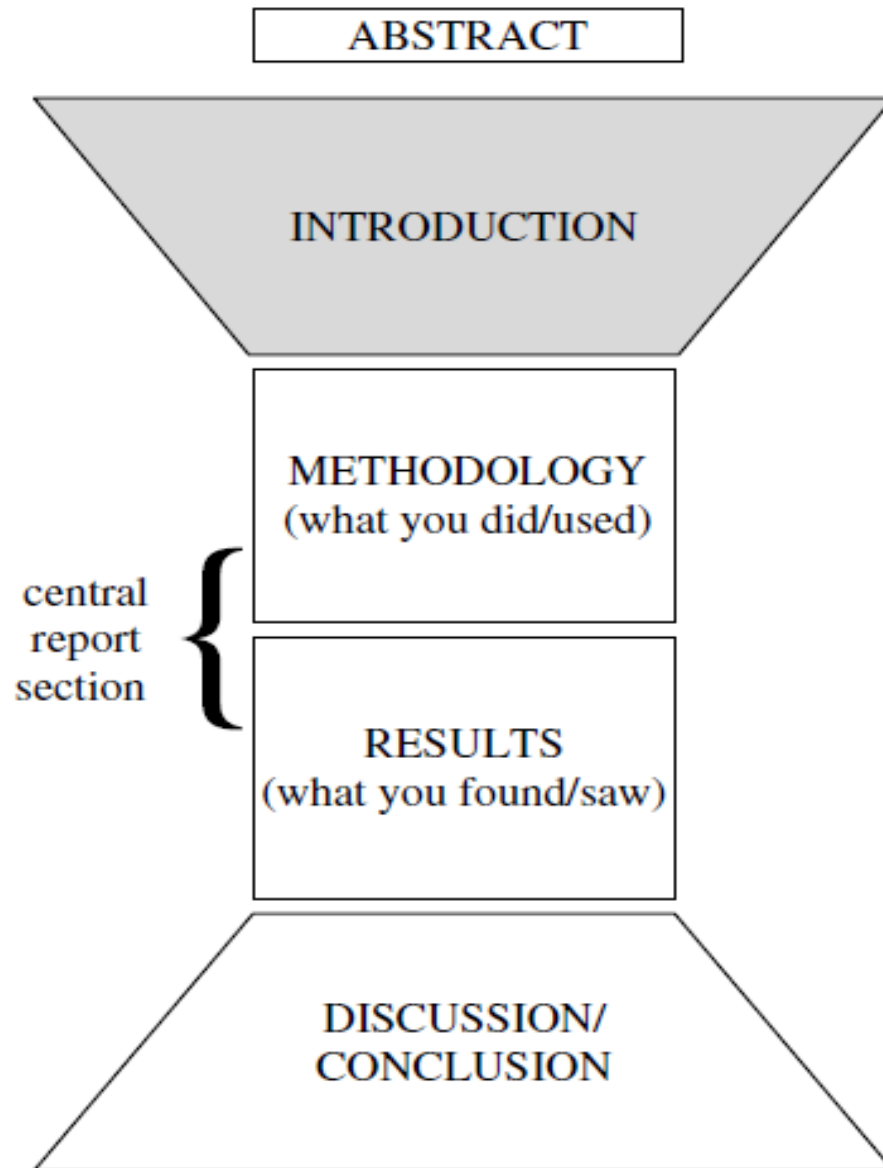

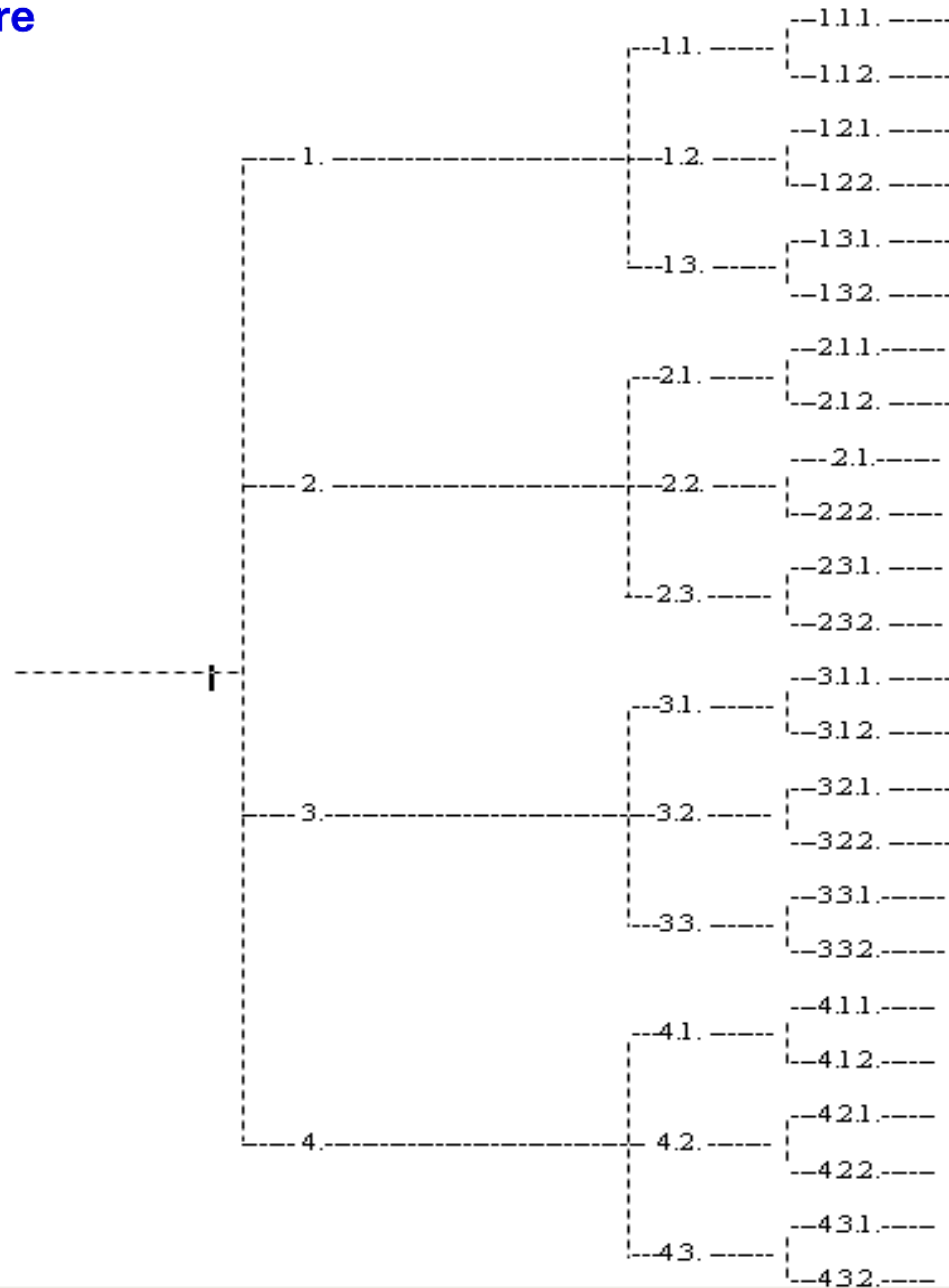

- audience
- complexity of the language
- drafting processes
- details

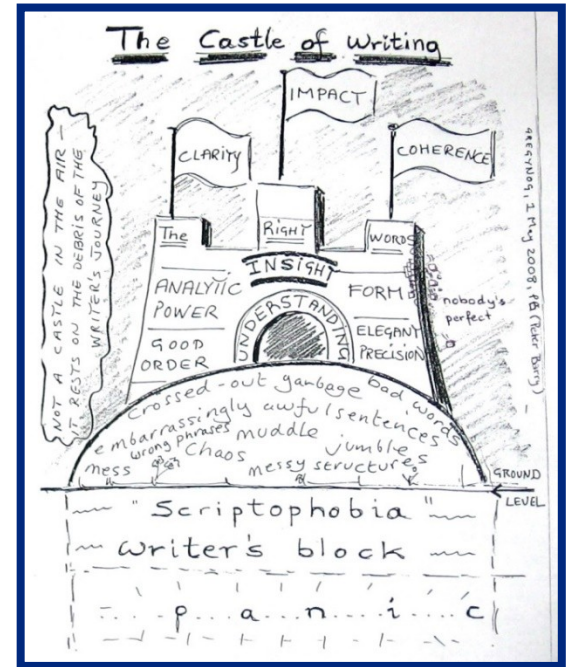

...keep writing...

Reading:

- Brooks and Grundy, 1990:92 in Morgan, J. (2007): Academic Writing Course materials, MU
- Caplan, N. A. (2012): Grammar Choices for Graduate and Professional Writers (Michigan Series in English for Academic & Professional Purposes) 1st Edition. The University of Michigan press.
- Cooper, P. (2011): Academic Writing and Czech Universities, a lecture
- Craswell, G., Poore, M. (2012): Writing for Academic Success , Second Edition
- Glasman-Deal, H. (2010): Science Research Writing for Non-Native Speakers of English, Palgrave Macmillan,
- Glasman-Deal,H.,(2010): Science Research Writing for Non-native Speakers of English, Imperial College Press, London
- Graff, G., Birkenstein, C. (2010): They Say / I Say: The Moves That Matter in Academic Writing. W.W. Norton and comp.
- Hradilová,A., Štěpánek,L. (2007): Academic Writing Course materials, MU
- Hyland, K. (2001): English for Specific Purposes, https://www.researchgate.net/publication/226497899_English_for_Specific_Purposes
- Morley, J. et al. (2009): University Writing Course, Express Publishing, Newbury,
- Ochsner, A. (2013): Introduction to Scientific Publishing: Backgrounds, Concepts, Strategies. Springer Heidelberg New York Dordrecht London.
- Robinson, M., Stoller,F. (2008): Write like a Chemist, OUP, Oxford
- Robinson, M.S.,(2008) Using the ACS Journals Search To Validate Assumptions about Writing in Chemistry and Improve Chemistry Writing Instruction, Journal of Chemical Education, Vol. 85, No. 5,
- Schimmel, J. (2012). Writing Science Oxford University Press.
- Swales, John M. and Feak, Christine B. (2001): Academic Writing for Graduate Students: Essential Tasks and Skills. The University of Michigan press.
- Sword, H (2012). Stylish Academic Writing. Harvard University Press Cambridge, Massachusetts & London, England.
- Štěpánek, L., deHaaff, J.(2011): Academic English, Grada, Praha
- Taylor, R. B.(2011) Medical Writing A Guide for Clinicians, Educators, and Researchers. Springer.
- Wager, E. (2015): Getting Research Published: An A-Z of Publication Strategy, Third Edition, CRC Press
- Zeiger, M. (2000): Essentials of Writing Biomedical Research Papers. Second Edition 2nd
- <http://www.uefap.com/writing/feature/intro.htm>
- https://www.dlsweb.rmit.edu.au/isu/content/4_WritingSkills/writing_pdf/vocabulary.pdf
- http://www.srhe.ac.uk/downloads/events/36_Academic_Writing-Dr_Rowena_Murray.pdf