

Lasers - absorption methods

2010

Vítězslav Otruba

Lasers in AAS

Advantages against classical measuring radiation sources:

1. Narrow spectral line (linear calibration)
2. Continuous tuning of wavelength possible (scanning)
3. High intensity (low noise, fast processes - spark, furnace)
4. Low divergence (spatial profiles, mini atomizers)
5. Short pulse time (time resolution)
6. Any wavelength (AAS of excited and ionized atoms)

AAS with low radiation intensity

Low intensity = not changed significantly occupation of energy levels

1. Atomic absorption profiles ($\Delta\lambda \approx 0,1 - 0,001 \text{ pm}$)
2. Isotopic shifts ($\approx 0,2 \text{ pm pro } \Delta M=1$)
3. Splitting by nuclear spin
4. Doppler broadening (temperature)
5. Collision damping
6. Stark broadening (electron density)
7. Calibration graphs (linearity of up to 6 concentration orders)

Absorption spectroscopy

□ Lambert's law: $dI = -\alpha I_0 dx \Rightarrow I = I_0 e^{-\alpha x}$

□ Lambert-Beer law :

$$\log \frac{I}{I_0} = -\epsilon c x$$

□ General equation for light absorption

$$\frac{dI}{dx} = -h\nu N_n P_{nm} = -h\nu B_{nm} N_n I = -\frac{c^3}{8\pi\nu^2} \frac{g_m}{g_n} A_{nm} N_n I$$

N_n depends on the concentration of atoms (molecules) in a given state n.

Absorption

Example: simple absorption measurement

Theoretical calculation for a single atom:

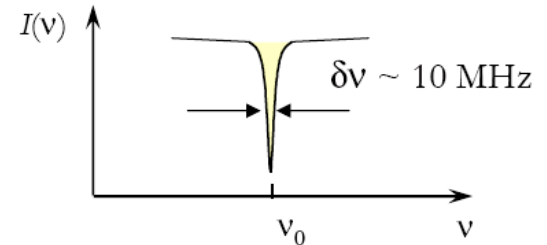
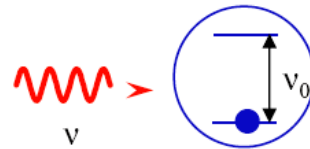

Classical "lamp+monochromator" solution

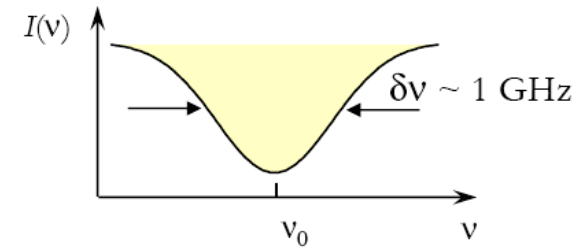
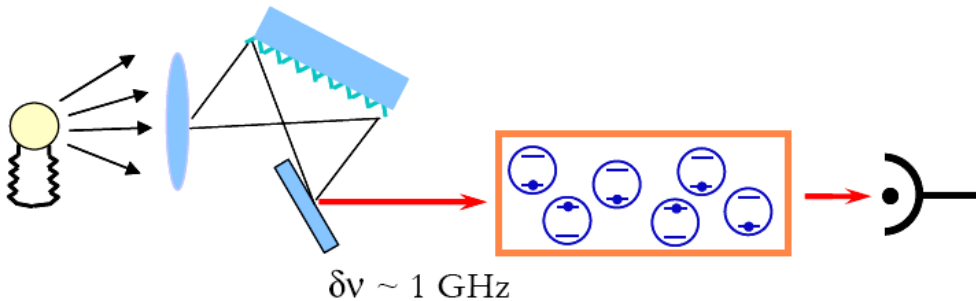

Modern tunable laser system

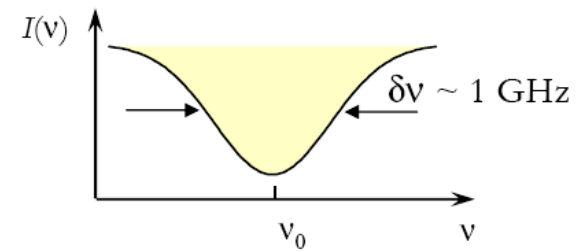
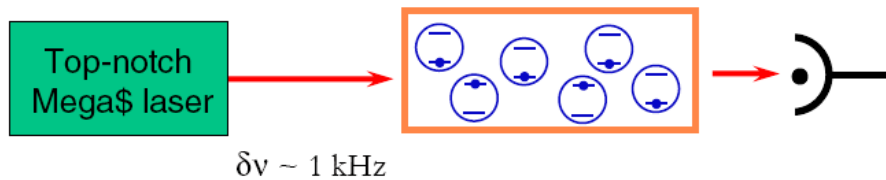

What is going on?
How can this be improved on?

Linear absorption

Linear absorption

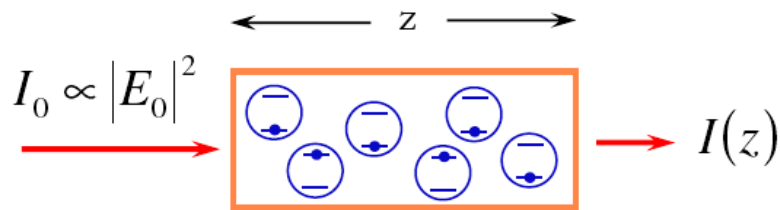

$$E = E_0 e^{i(\omega t - kz)}$$

$$E_k - E_i = \hbar \omega_0$$

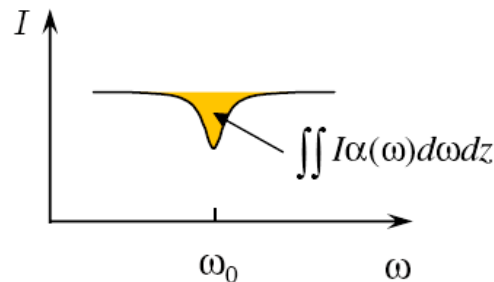
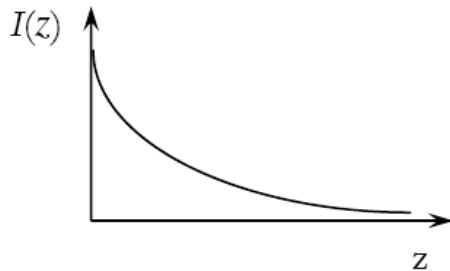
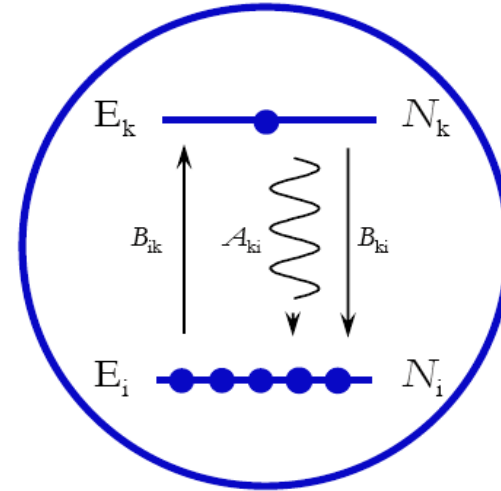

$$dI = -I \alpha(\omega) dz = -I \sigma_{ik}(\omega) (N_i - N_k) dz$$

Absorption cross section: σ_{ik}

For small I :

N_k and N_i not affected

$$\Rightarrow \alpha \neq \alpha(I)$$

$$I(z) = I_0 e^{-\alpha z}$$

Beer's law

Fine structure Hg I 404,7 nm

Around 2/3 of the stable atomic nuclei has a resulting nuclear spin, causing a fine line structure.

^{199}Hg and ^{201}Hg have unpaired neutrons and show spin splitting. Resulting profile is then results of combination with the natural linewidth and Doppler broadening. Isotopes ^{198}Hg ; ^{200}Hg ; ^{202}Hg and ^{204}Hg are not splitted.

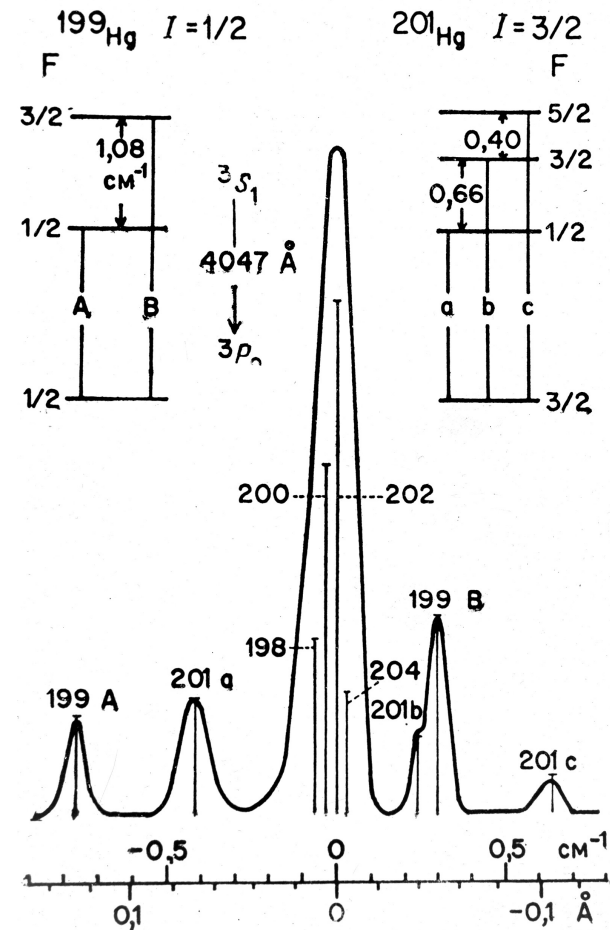

AAS with graphite furnace

Example of AAS spectrometer with laser diode and electrothermal atomizer (graphite furnace)

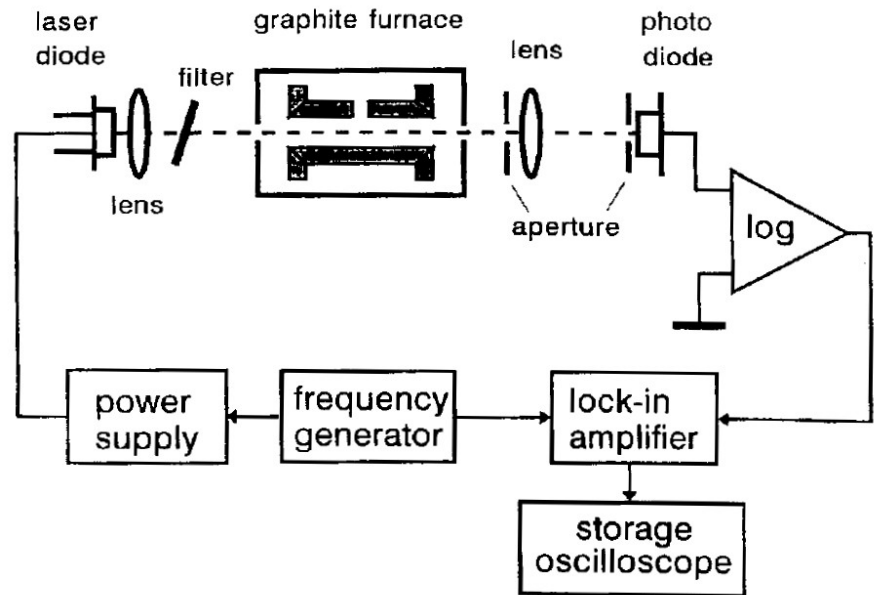
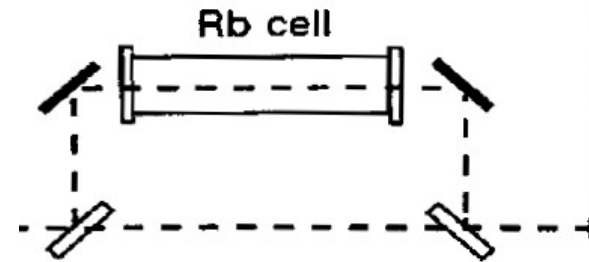
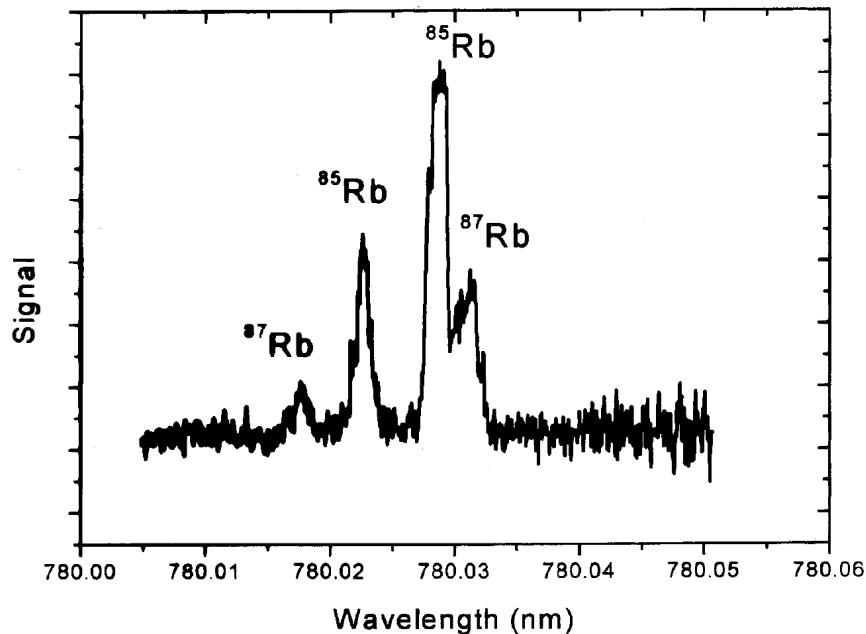

AAS in a laser spark

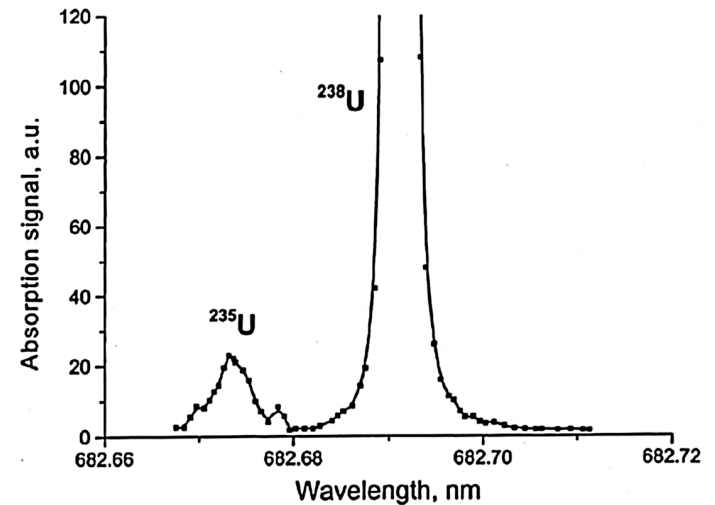
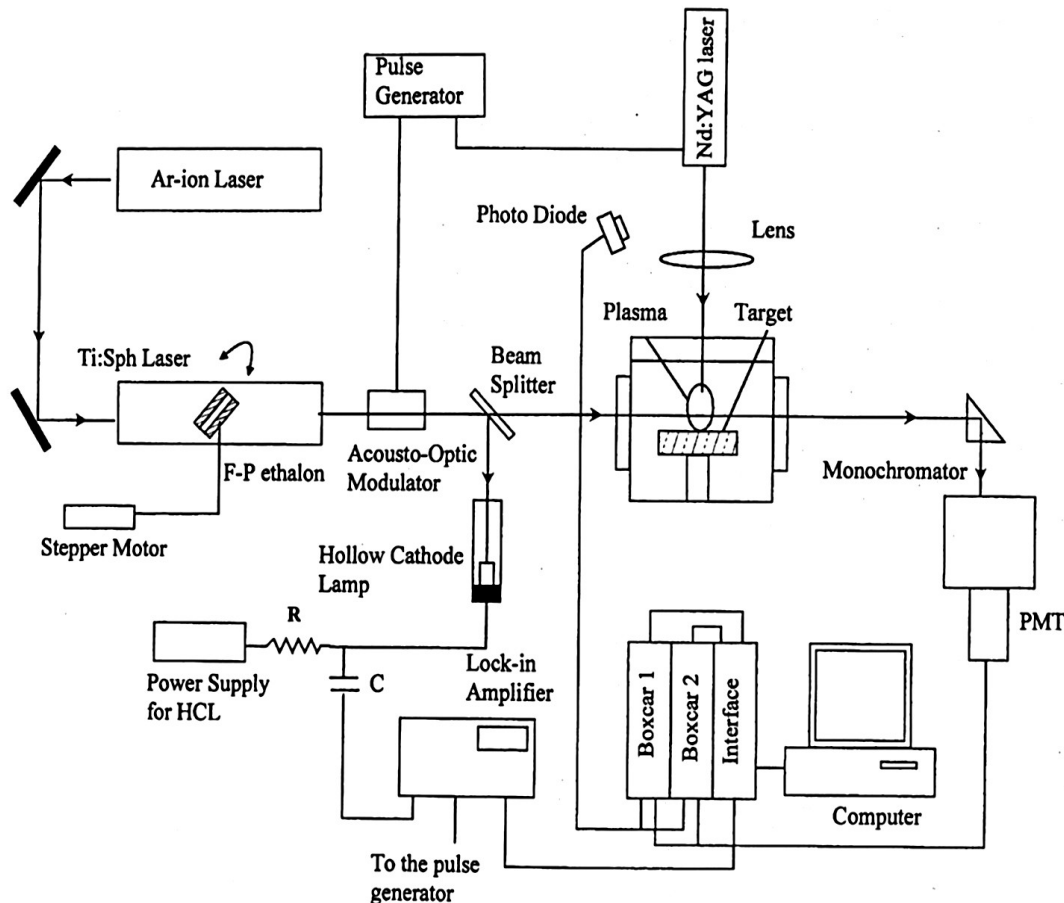

Spectral profile of the uranium absorption line. Distance to sample surface 5 mm, argon atmosphere 540 Pa.

Molecular absorption spectroscopy

- Identification of the composition of the sample is performed by monitoring the loss of light after passing through the sample
- Laser excels extraordinary monochromaticity emitted radiation, wavelength selection is thus ensured directly by the radiation source
- Laser radiation is extremely intense, so the signal to noise ratio is very high. Extremely low detection limits can be achieved when using a multireflective cuvette.
- Measurement speed using a laser is higher than with conventional spectrometers. There is no parasitic infrared radiation from the heat source
- The radiation source can be moved away from the measuring cuvette (using fiber optic)
- Considerable attention is paid to laser spectroscopy in the IR region. Laser (diode) IR spectrometer (semiconductor tunable laser) allows very precise identification of spectral lines in IR (structural analysis)

Absorption spectrometer with laser

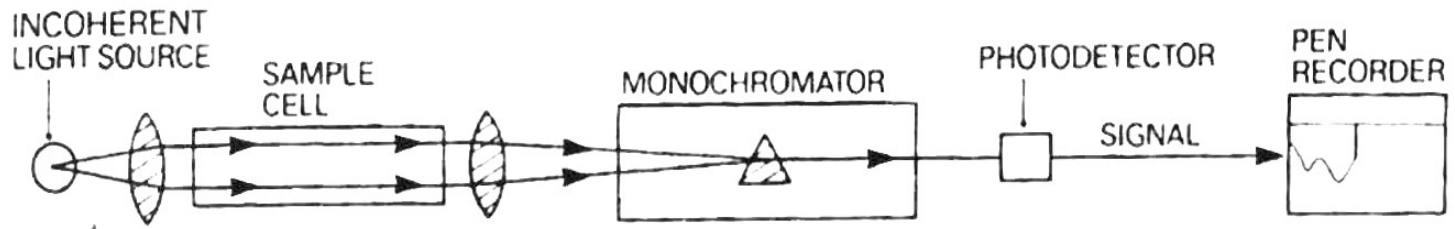

(a)

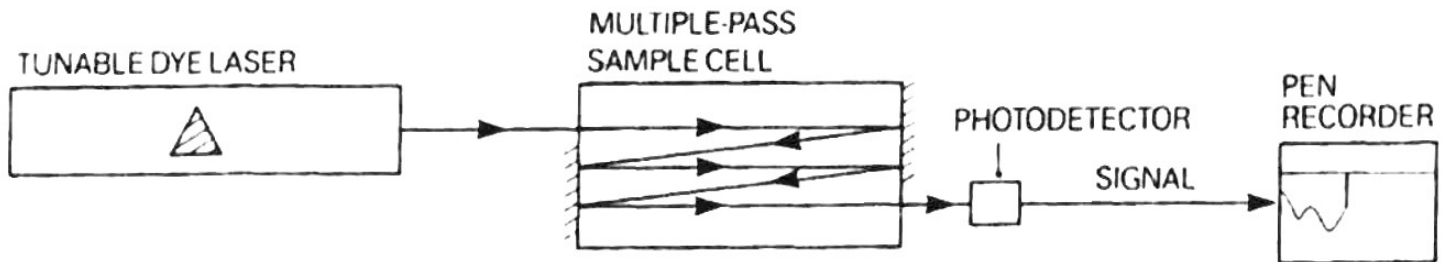

(b)

A - classical absorption spectrometer; B - spectrometer with laser source

Methods of low absorbance measurement

- intense source of monochromatic light, absorption is measured differentially
- multiple passage of absorbed light through the sample, increasing the absorption length
- absorption of radiation and measurement of fluorescence from excited states
- optoacoustic detection methods
- absorption of radiation and measurement of Raman emission spectra

Absorption spectroscopy in resonator cavity

- Between the resonator mirror and the active laser medium is a space usable for spectroscopic purposes, in which a sample cuvette is inserted
- This is a special detection method that excels in extraordinary sensitivity
- Laser radiation passes through the cuvette located inside the resonator repeatedly
- The laser output parameters are strongly influenced by internal absorption
- Due to its sensitivity, the absorption method inside the resonator is best used to detect low concentrations of substances, especially gases
- Spectroscopy inside the resonator is particularly suitable for qualitative analysis

Absorption spectroscopy in resonator cavity

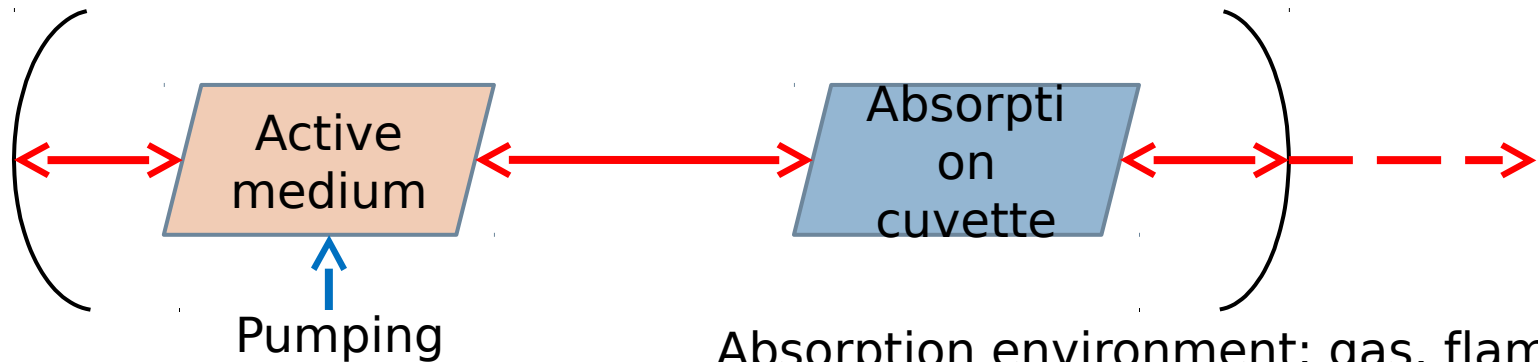

Absorption environment: gas, flame, plasma, solution...

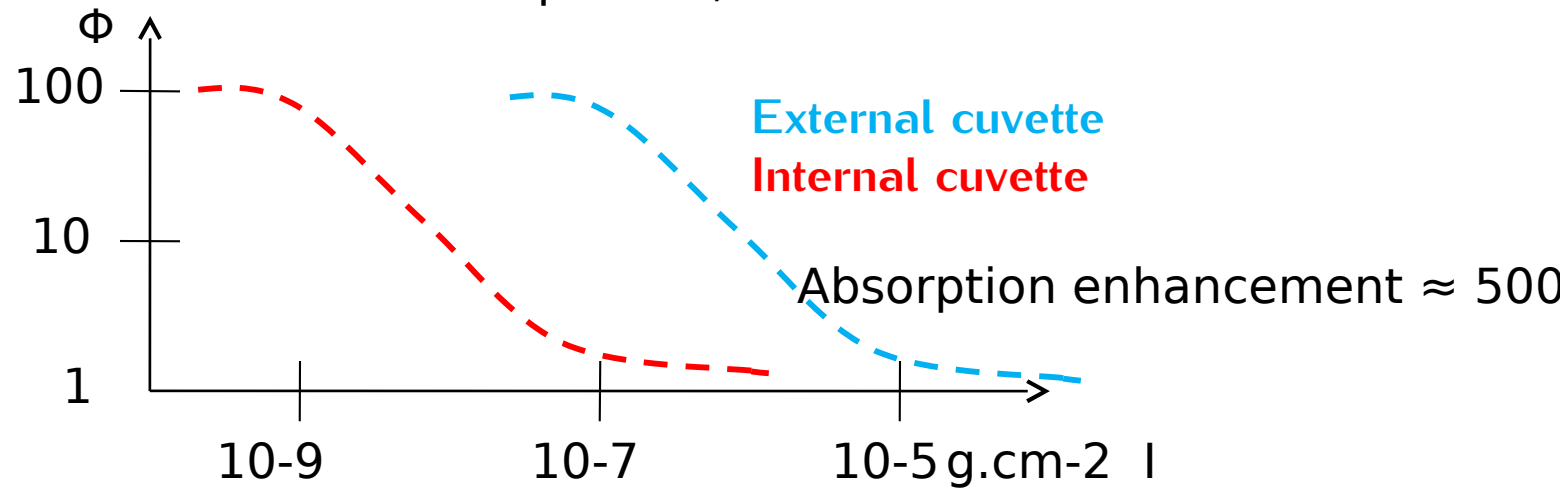

Differential measurement

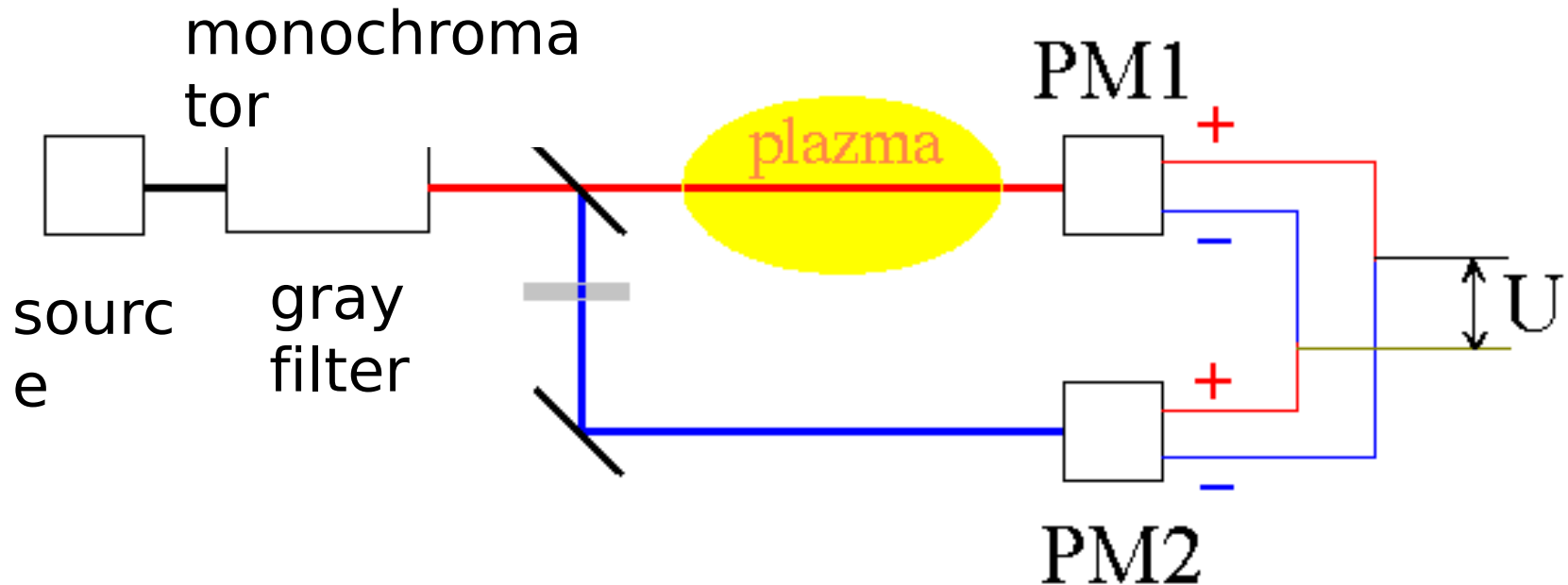

Before the actual measurement it is necessary to set the gain of both photomultipliers so that the resulting voltage is zero. In the presence of plasma we then record the differential voltage in the order of magnitude $\mu\text{V} - \text{mV}$.

Multiple pass of light

source

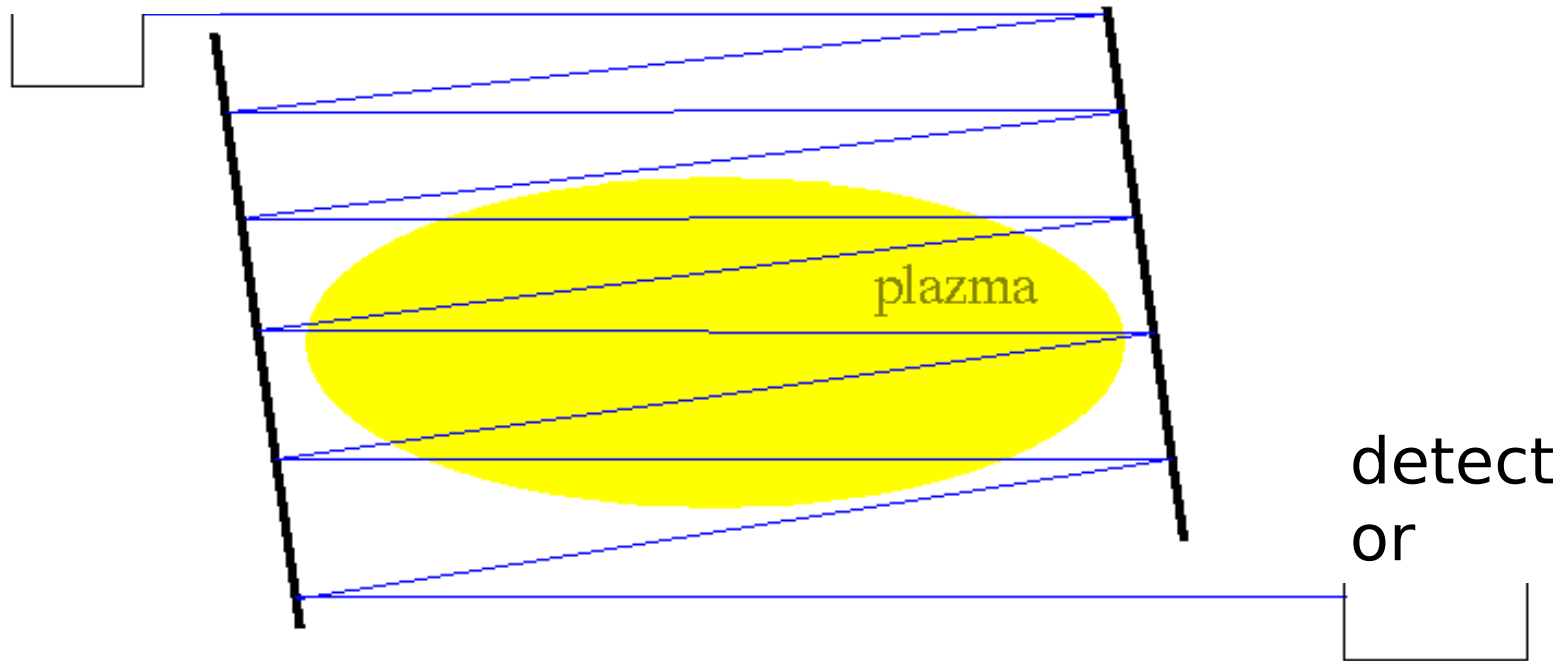

basic disadvantages - we lose spatial resolution
- the light beam is diverging

Application of Fourier transform

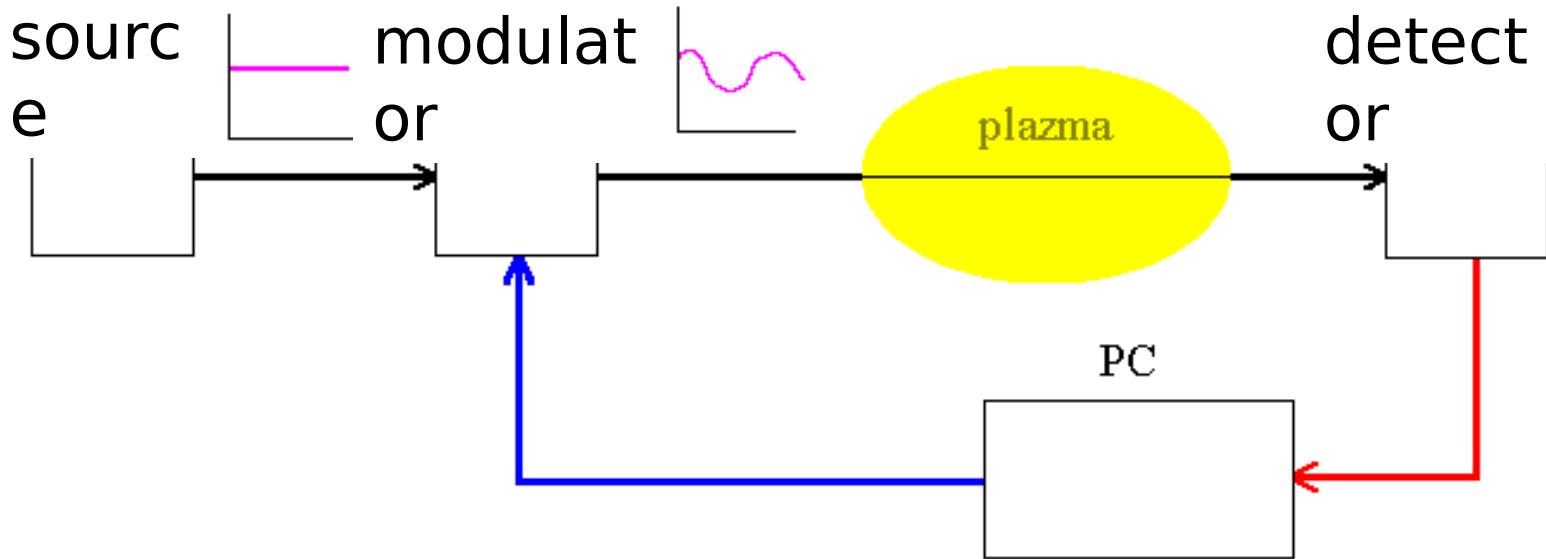

The signal from the detector is modulated by the discharge. Fourier transform in a PC separates a signal with a different frequency than the modulation frequency; the result is noise reduction. It is also possible to realize direct modulation of the source (e.g. by lamp voltage). In absorption spectroscopy, it is suitable to use Fourier transform especially in the differential measurement of

Cavity Ring Down Spectroscopy

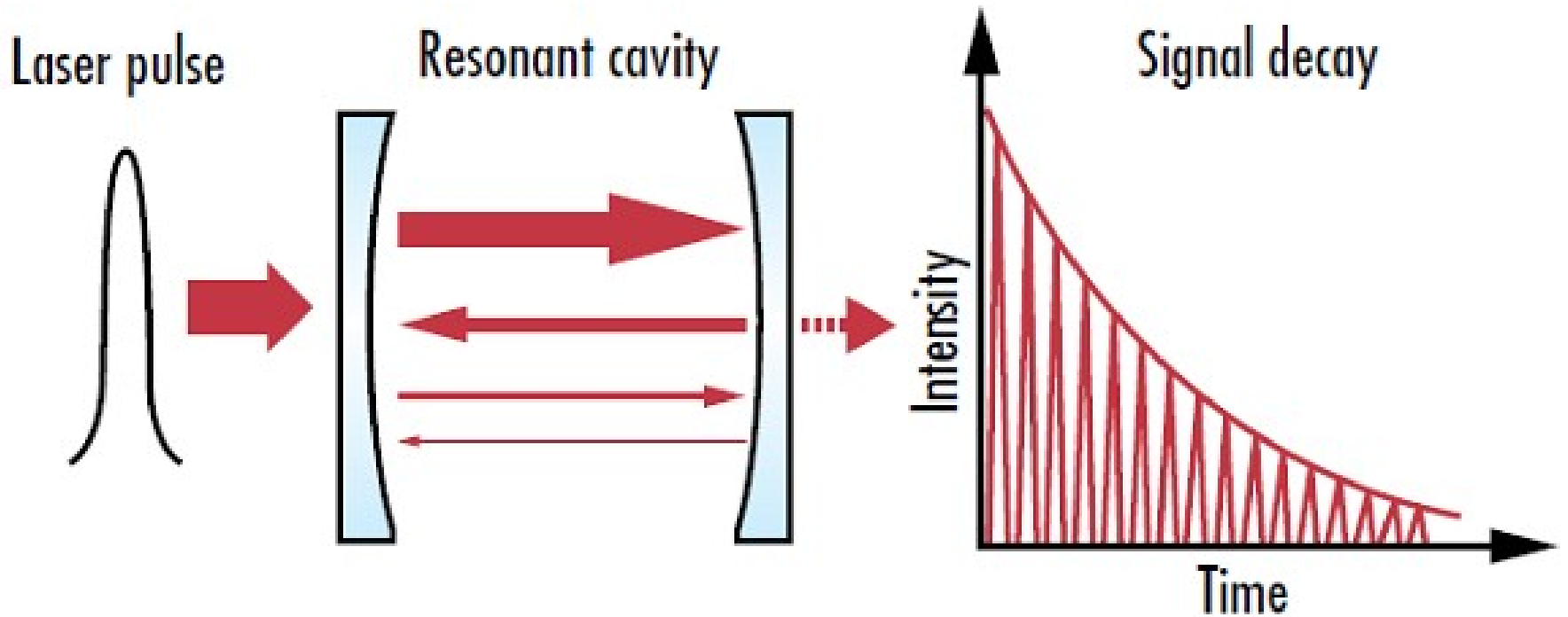

Cavity Ring Down Spectroscopy

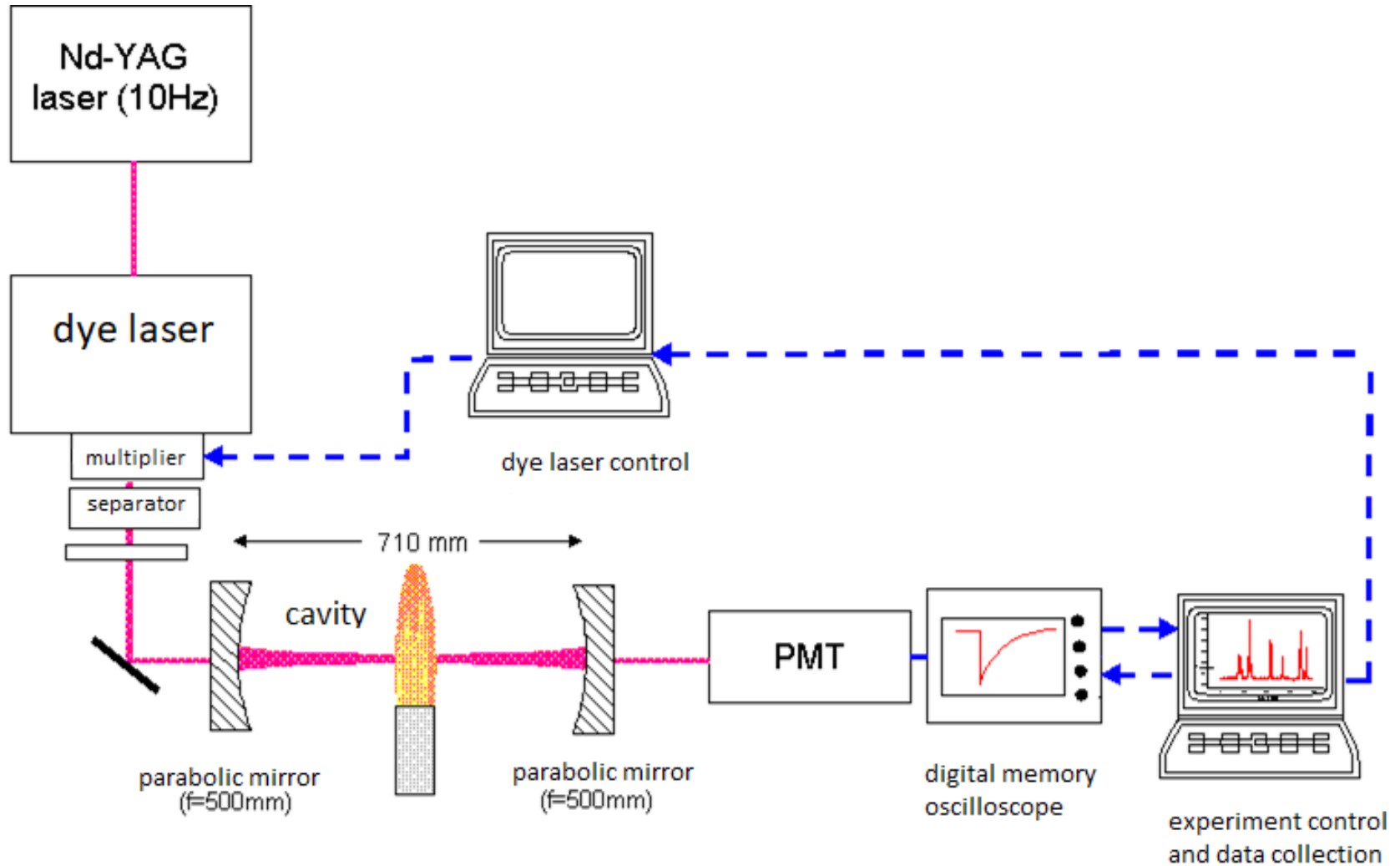

Cavity Ring Down Spectroscopy

- Using memory oscilloscope and PC, a large number of pulses can be averaged and reducing noise.
- The concentration of absorbing particles can be determined from the exponential decrease in light intensity.
- The detection limit is of the order of $A=10^{-6}$.
- Parabolic mirrors allow spatial localization of the detected area, so concentration profiles can be measured.
- Currently, this method is only used in the visible and near UV range.

IR high resolution laser absorption spectrometry

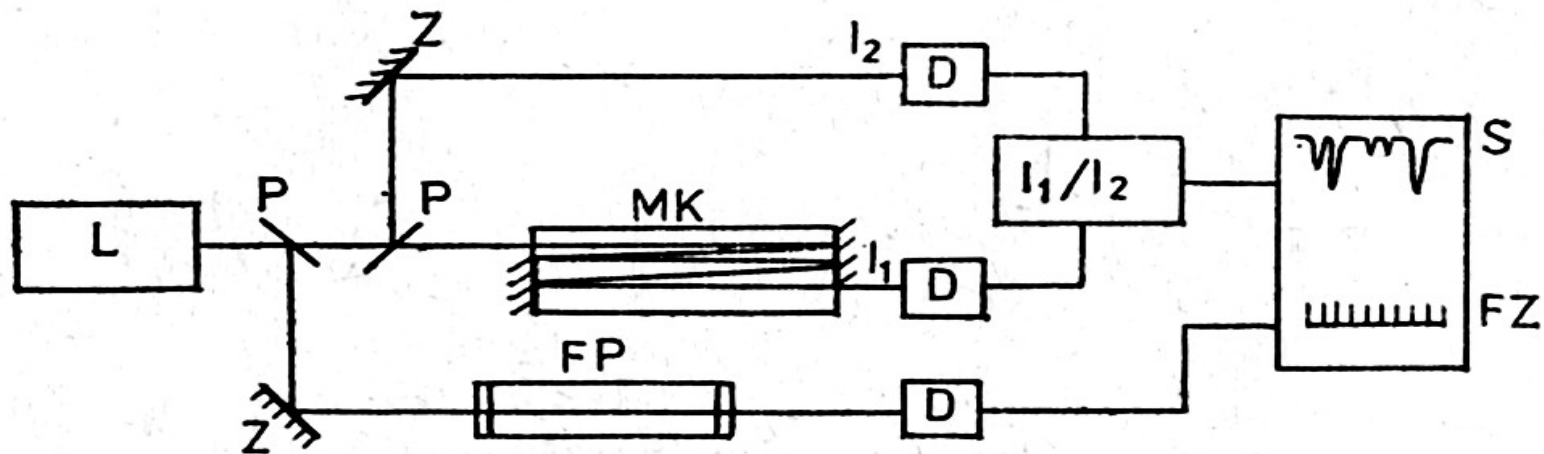

FP = Fabry Perot standard for wave number calibration ($\Delta\nu=c/(2dn)$)

L = semiconductor laser PbSnTe; PbCdS; Pb_{1-x}Sn_xSe;

$\lambda \approx 2 - 30 \mu\text{m}$; $R \approx 10^7$;

UV – VIS: dye lasers, $R \approx 5 \cdot 10^7$

Double resonance methods

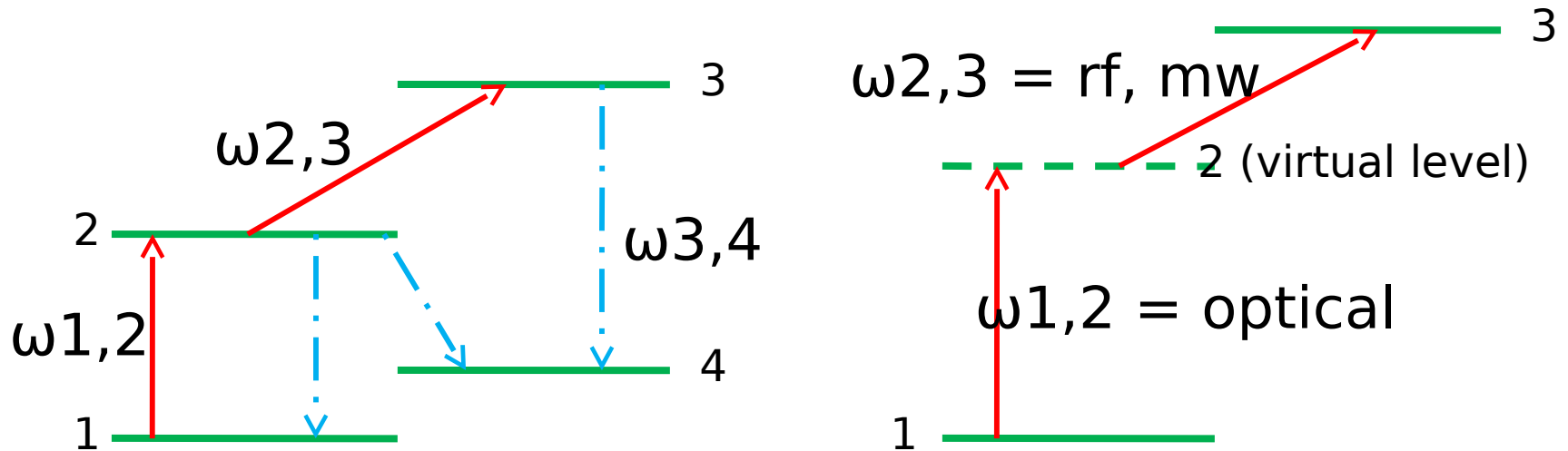

- $\omega_{1,2}$ = constant frequency laser, strong population level 2
- $\omega_{2,3}$ = tuned radio frequency, microwave or optical radiation
- $\omega_{3,4}$ = fluorescence radiation indicating resonance

Optical-microwave double resonance

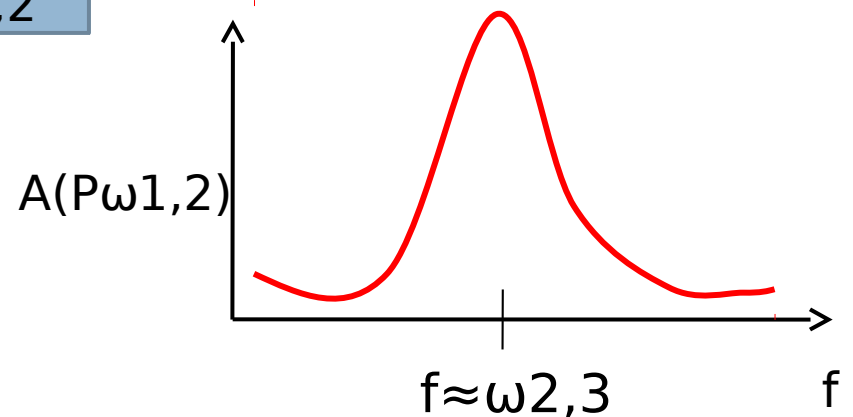
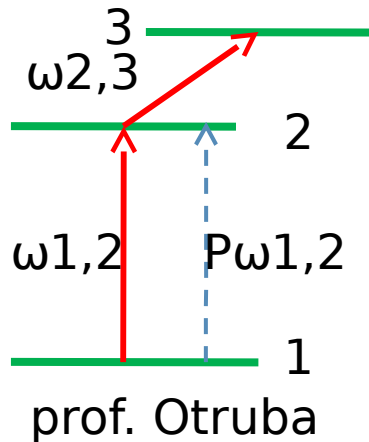
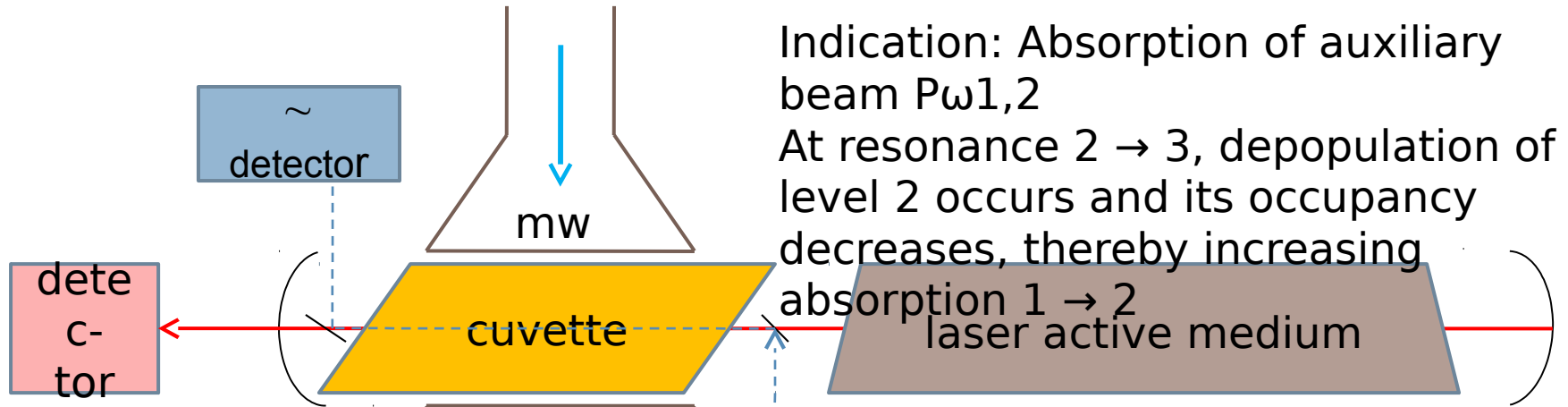

Tuning of absorption levels

- Zeeman effect can be used for molecules with permanent magnetic dipole moment. The magnetic field causes splitting of degenerate levels:

$\Delta E = -\mu_B g m$, where g =Landé factor; μ_B =Bohr magneton; B = magnetic induction; m = magnetic quantum number.

Sensitivity is particularly high for radicals with unpaired electrons.

- **Stark effect** causes the splitting of the molecules in a permanent electric dipole moment. Necessary intensities of homogeneous el. fields are of order 1000V/mm.
- Especially in the IR region, lasers HF, DF, CO, CO₂, N₂O, H₂O, D₂O, HCN

Tuning of absorption levels- Zeeman

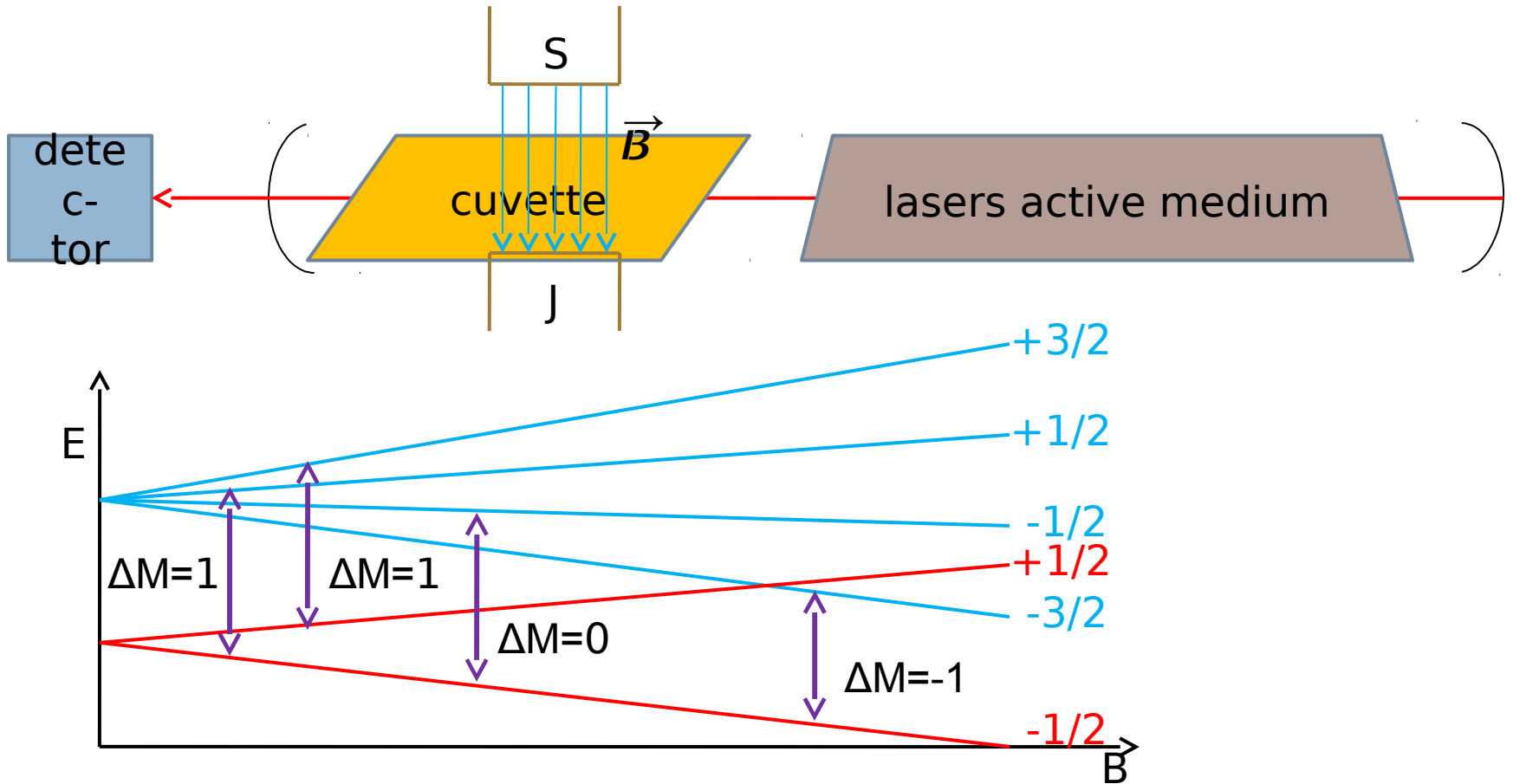

Nonlinear spectroscopic methods

- Methods based on simultaneous absorption of multiple photons by the same sample particle
- The absorption coefficient value changes when more photons are absorbed by the particles at the same time
- Interaction of the sample with a large amount of photons increases the occupancy of the upper energy level and reduces the absorption of the sample due to saturation of the absorption transition
- If non-linear effects occur, Lambert-Beer's law cannot be used for absorption

Non-linear absorption

Non-linear absorption

I large

N_i and N_k change; $N_i + N_k = N$

$$\frac{dN_i}{dt} = -\frac{dN_k}{dt} = -B_{ik}\rho(\omega_0)N_i + B_{ki}\rho(\omega_0)N_k + A_{ki}N_k$$

$$B\rho(\omega) = \frac{I(\omega)}{\hbar\omega}\sigma(\omega)$$

Steady state: $\frac{dN_i}{dt} = 0 \Rightarrow N_i = N \frac{1 + \frac{1}{2}S}{1 + S}$

$$S \equiv \frac{I}{I_s} = \frac{2\rho(\omega)B_{ki}}{A_{ki}} = \frac{2}{A_{ki}} \frac{I(\omega)}{\hbar\omega} \sigma(\omega) = \text{saturation parameter}$$

$$\alpha = \Delta N \sigma = (N_i - N_k) \sigma = \frac{N}{1 + S} \sigma$$

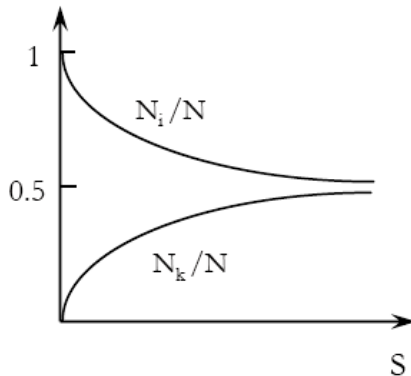

$$\alpha = \frac{\alpha_0}{1 + I/I_s}$$

Absorption **saturates**, when I increases \rightarrow sample becomes transparent

Saturation spectrometry

- Optically thick absorption - absorption coefficient regulation
- Spectroscopy without Doppler Broadening e.g.:
 - Lamb-dip spectrometry
 - Two-photon Doppler-free spectrometry
- Laser frequency stabilization
- Multiphoton methods

Saturation Doppler-free Spectroscopy (Lamb-Dip Spectroscopy)

- The saturation sub Doppler spectroscopy method finds its main application in determining the exact values of absorption lines and in stabilizing of lasers
- The principle of saturation sub Doppler spectroscopy is based on the Doppler effect
- Saturation sub Doppler spectroscopy is a method used for the study of gaseous substances
- Gas particles that move chaotically appear in radiation interaction with frequency shift according to the speed of movement relative to the viewing direction
- The particles interact with the frequency shift radiation given by the instantaneous velocity component

Natural linewidth

Natural linewidth (classical model)

Atom in an excited state: damped oscillator

$$\ddot{x} + \gamma\dot{x} + \omega_0 x = 0$$

$$\omega_0 = (E_i - E_k) / \hbar$$

$$\Rightarrow x(t) = x_0 e^{-\gamma t/2} \cos \omega_0 t, \text{ for } \gamma \ll \omega_0$$

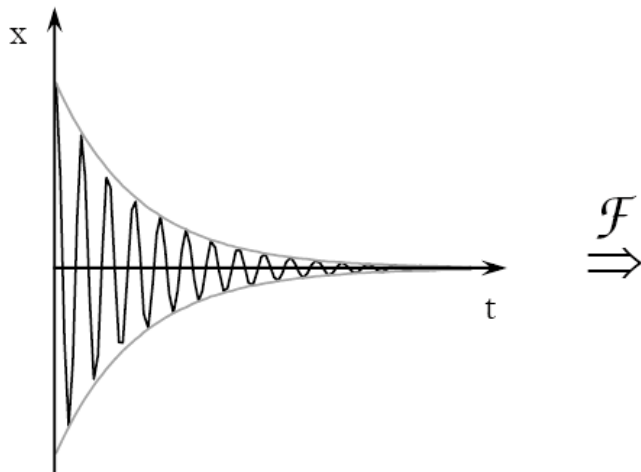

Spectrum by Fourier transformation:

$$\mathcal{F}\{x(t)\} = A(\omega) \rightarrow I(\omega) = |A(\omega)|^2$$

When $|\omega - \omega_0| \ll \omega_0$

$$I(\omega) = I_0 \frac{\gamma}{(\omega - \omega_0)^2 + (\gamma/2)^2}$$

$$\Delta\omega_{ik} = \gamma = 1/\tau = \textit{natural linewidth}$$

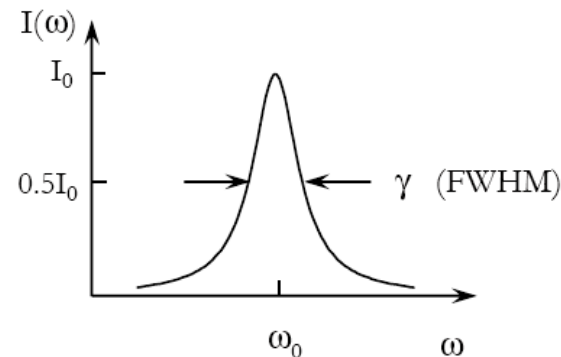

Heisenberg uncertainty principle

The natural line-width can be obtained also by applying

Heisenberg uncertainty principle:

$$\Delta E \cdot \Delta \tau \approx \hbar$$

Excited state life-time: τ_k

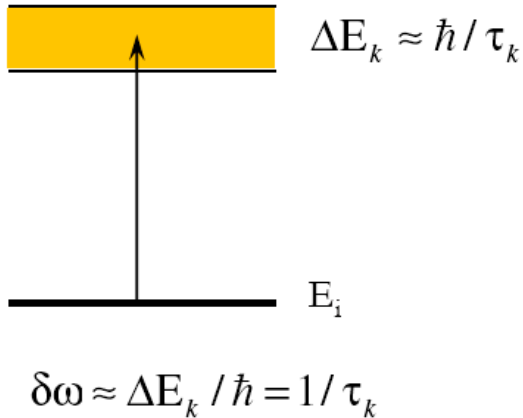

If both levels of the transition have finite life-time:

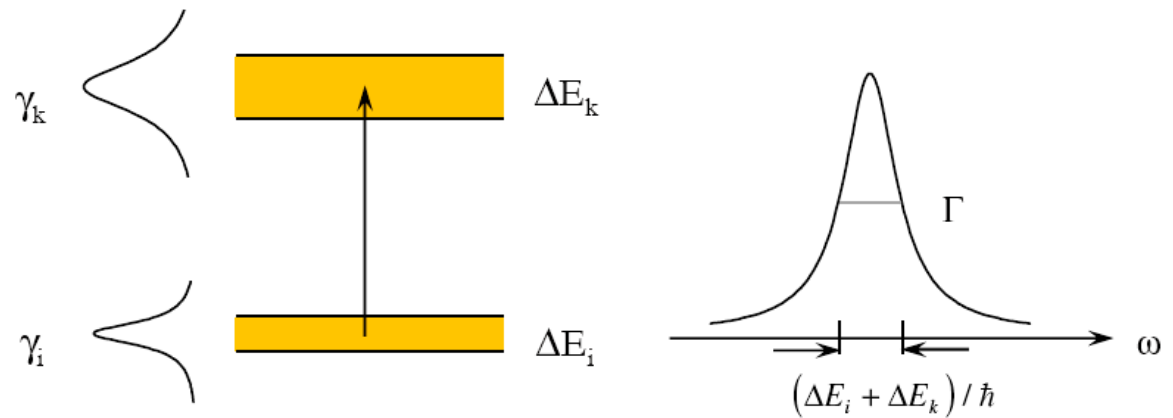

Total width

$$\Gamma = (\gamma_i + \gamma_k)$$

Doppler broadening

Doppler broadening

Emission

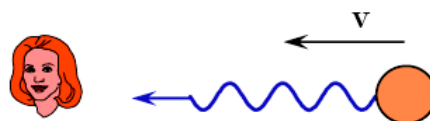

$$\omega_e = \omega_0 + \mathbf{k} \cdot \mathbf{v} = \omega_0 \left(1 + \frac{v}{c} \right)$$

'blue shift'

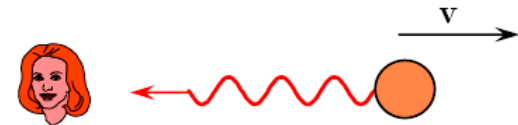

$$\omega_e = \omega_0 + \mathbf{k} \cdot \mathbf{v} = \omega_0 \left(1 - \frac{v}{c} \right)$$

'red shift'

Absorption

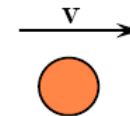
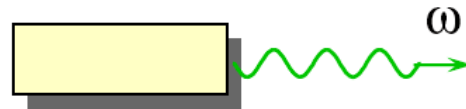

The moving atom 'sees' frequency

$$\omega' = \omega - \mathbf{k} \cdot \mathbf{v}$$

- ✓ In thermal equilibrium the velocity distribution is Gaussian (Maxwell-Boltzmann)
- ✓ Sum over all atoms weighing the sum with the velocity distribution

Emission line of gas atoms

$$I(\omega) = I_0 e^{-\frac{4 \ln 2 (\omega - \omega_0)^2}{\delta \omega_D^2}}$$

($\gamma \ll \delta \omega_D$)

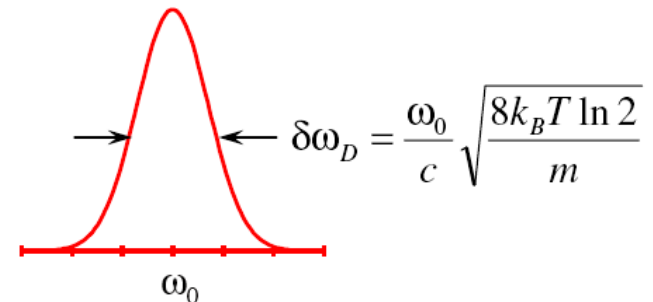

Homogeneous and inhomogeneous broadening

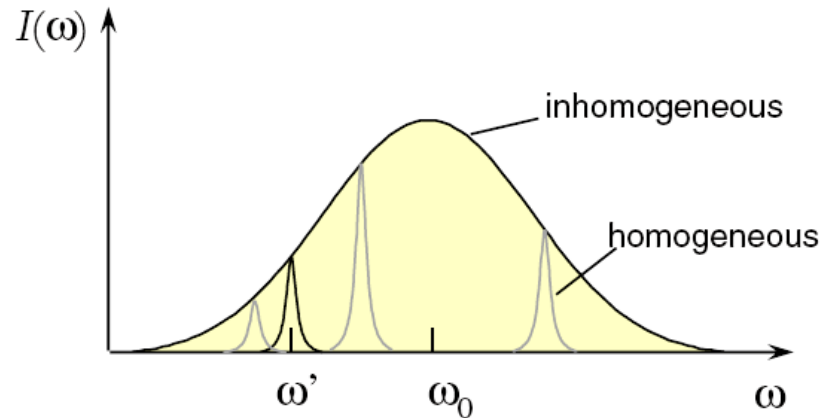

$$\omega' = \omega - \mathbf{k} \cdot \mathbf{v}$$

Typically for atoms:

Doppler width $\frac{\Delta\omega_D}{2\pi} \approx 1\text{GHz}$

Natural width $\gamma / 2\pi \approx 10\text{MHz}$

homogeneous

- all atoms behave identically

inhomogeneous

- atoms behave individually (different velocity, environment, etc.)

In classical spectroscopy on free atoms or molecules the resolution is typically limited by the Doppler effect

Movement of particles in gas

- Gas particles that move chaotically appear in interaction with radiation by frequency shift according to the speed of movement relative to the viewing direction

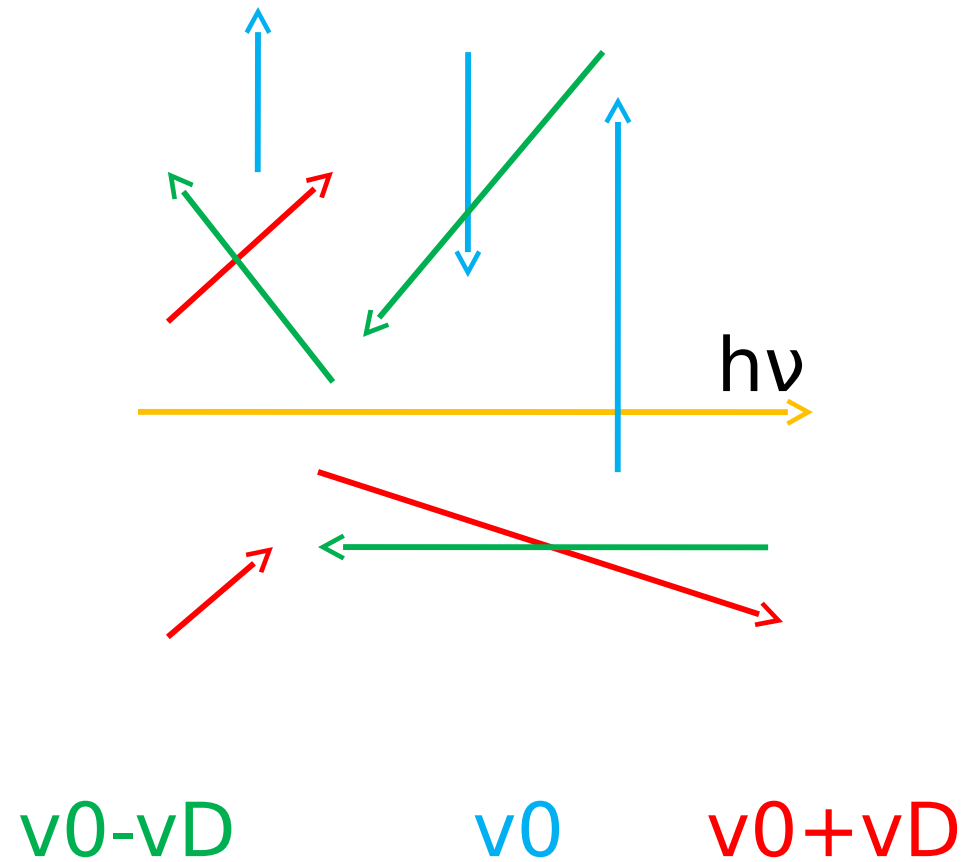

Absorption saturation on inhomogeneously broadened line

Saturation of absorption of an inhomogeneous line profile

Resonance condition: $\omega - \mathbf{k} \cdot \mathbf{v} = \omega_0$

Absorption cross section:
$$\sigma(\mathbf{v}, \omega) = \sigma_0 \frac{(\gamma/2)^2}{(\omega - \omega_0 - \mathbf{k} \cdot \mathbf{v})^2 + (\gamma/2)^2}$$

Saturation parameter:
$$S \propto \sigma \Rightarrow S(\mathbf{v}, \omega) = S_0 \frac{(\gamma/2)^2}{(\omega - \omega_0 - \mathbf{k} \cdot \mathbf{v})^2 + (\gamma/2)^2}$$

Population difference:
$$\Delta N = \frac{\Delta N_0}{1 + S(\mathbf{v}, \omega)}$$

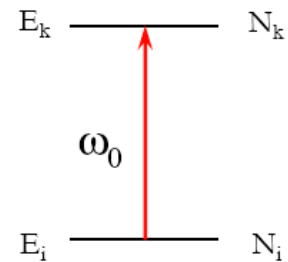
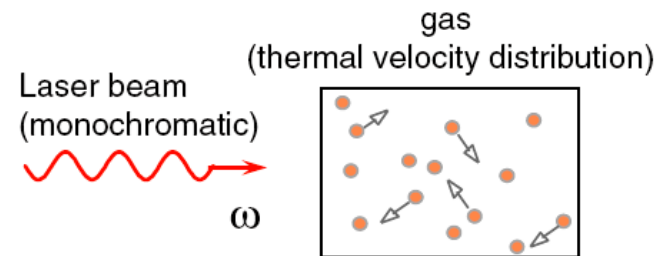

$$\Delta N(\mathbf{v}) = \Delta N_0(\mathbf{v}) \left[1 - \frac{S_0 (\gamma/2)^2}{(\omega - \omega_0 - \mathbf{k} \cdot \mathbf{v})^2 + (\gamma_s/2)^2} \right]$$

$$\gamma_s = \gamma \sqrt{1 + S_0}$$

$$S_0 = I/I_s = \text{saturation parameter}$$

Both the saturation and probe beams are parallel

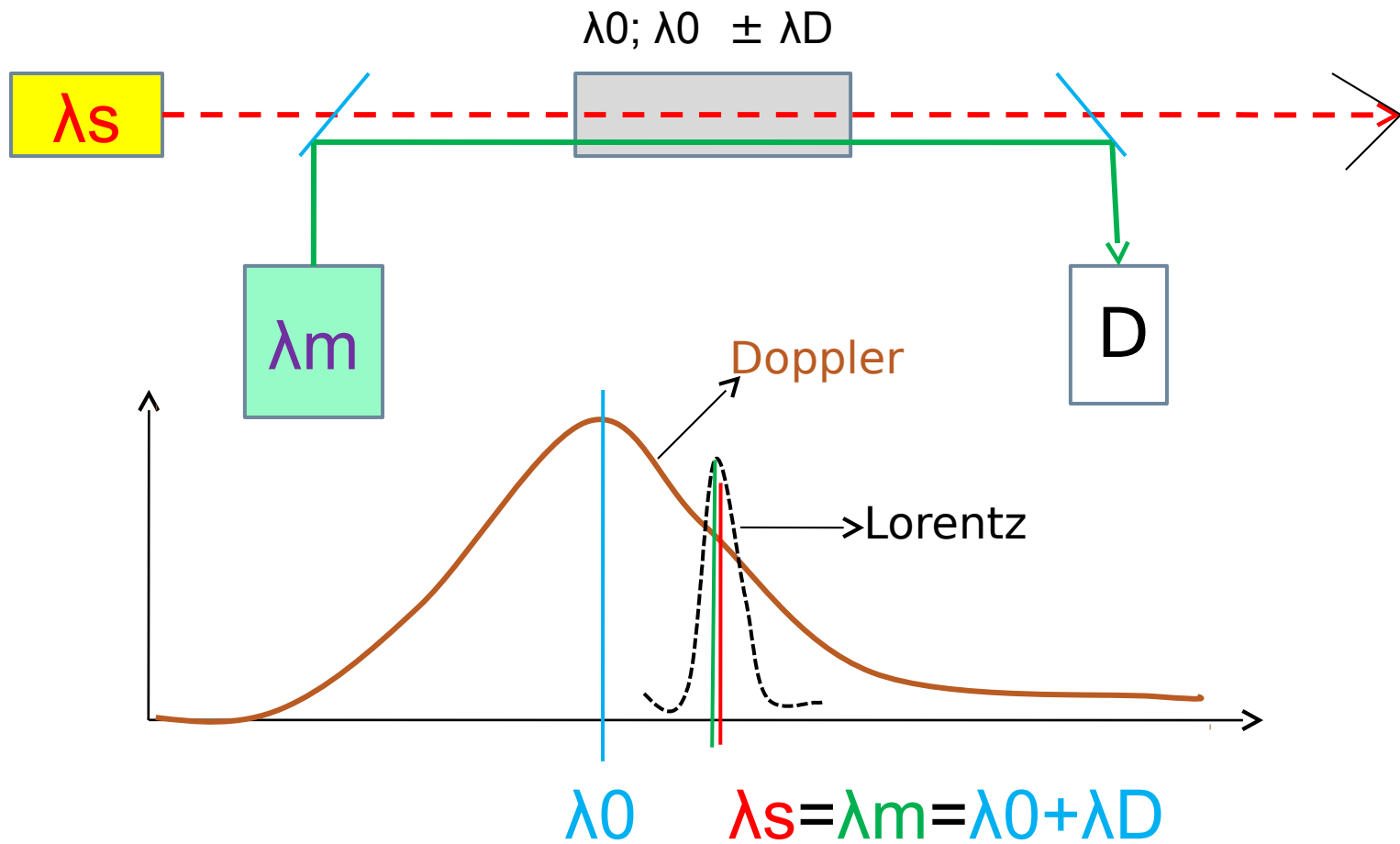

Bennet (Lamb) hole

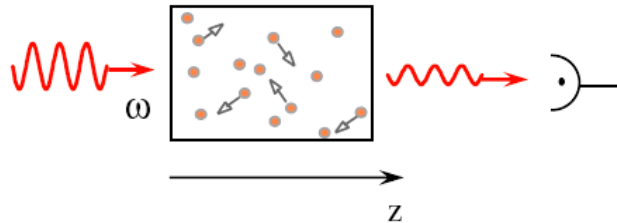

Laser frequency ω tuned \Rightarrow

Sum over all atoms:

$$\text{Absorption: } \alpha(\omega) = \int_{-\infty}^{\infty} \sigma(v_z, \omega) \Delta N(v_z) dv_z$$

$$\alpha_s(\omega) = \frac{\alpha_0(\omega_0)}{\sqrt{1 + S_0}} e^{-\left(\frac{\omega - \omega_0}{\delta\omega_D}\right)^2}$$

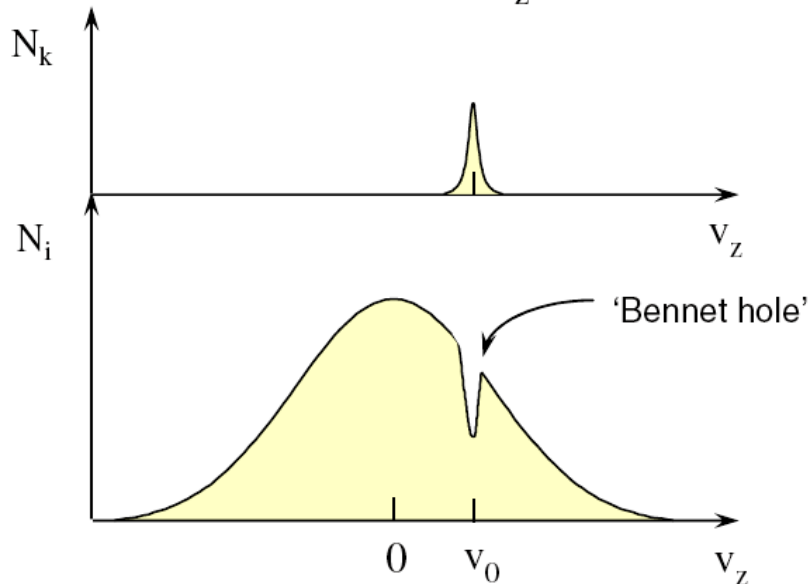

$$\text{Resonance condition: } \omega - kv_0 = \omega_0 \Rightarrow v_0 = \frac{\omega - \omega_0}{k}$$

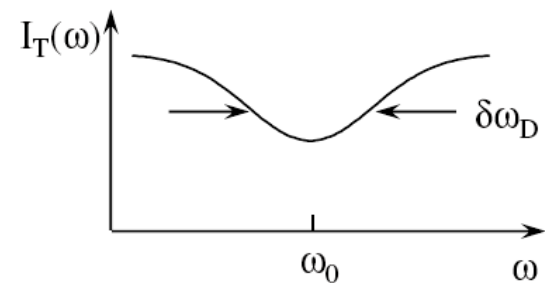

Inhomogeneous linewidth

'Doppler-limited' spectroscopy

Saturation and probing beam in opposite

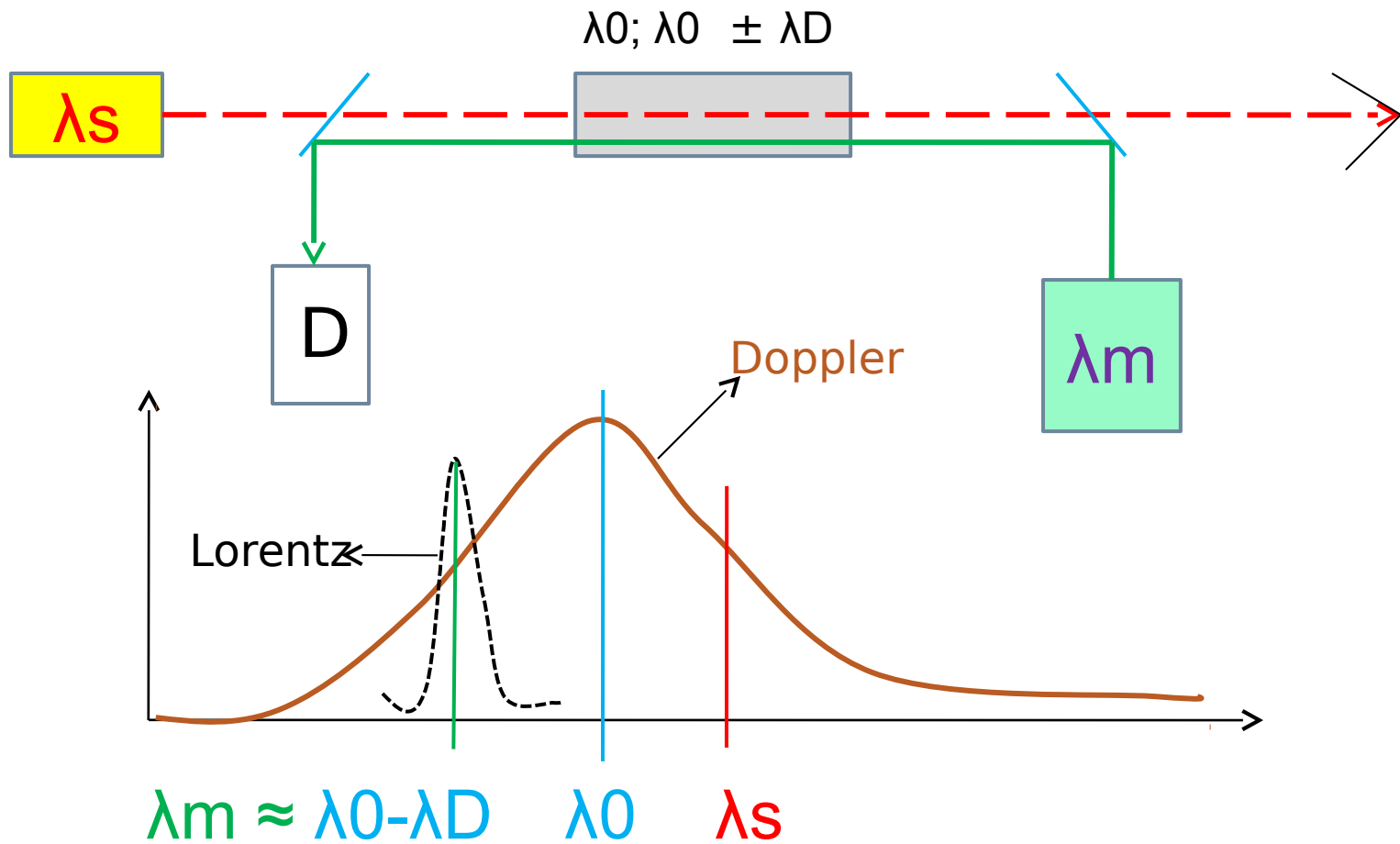

Final solution

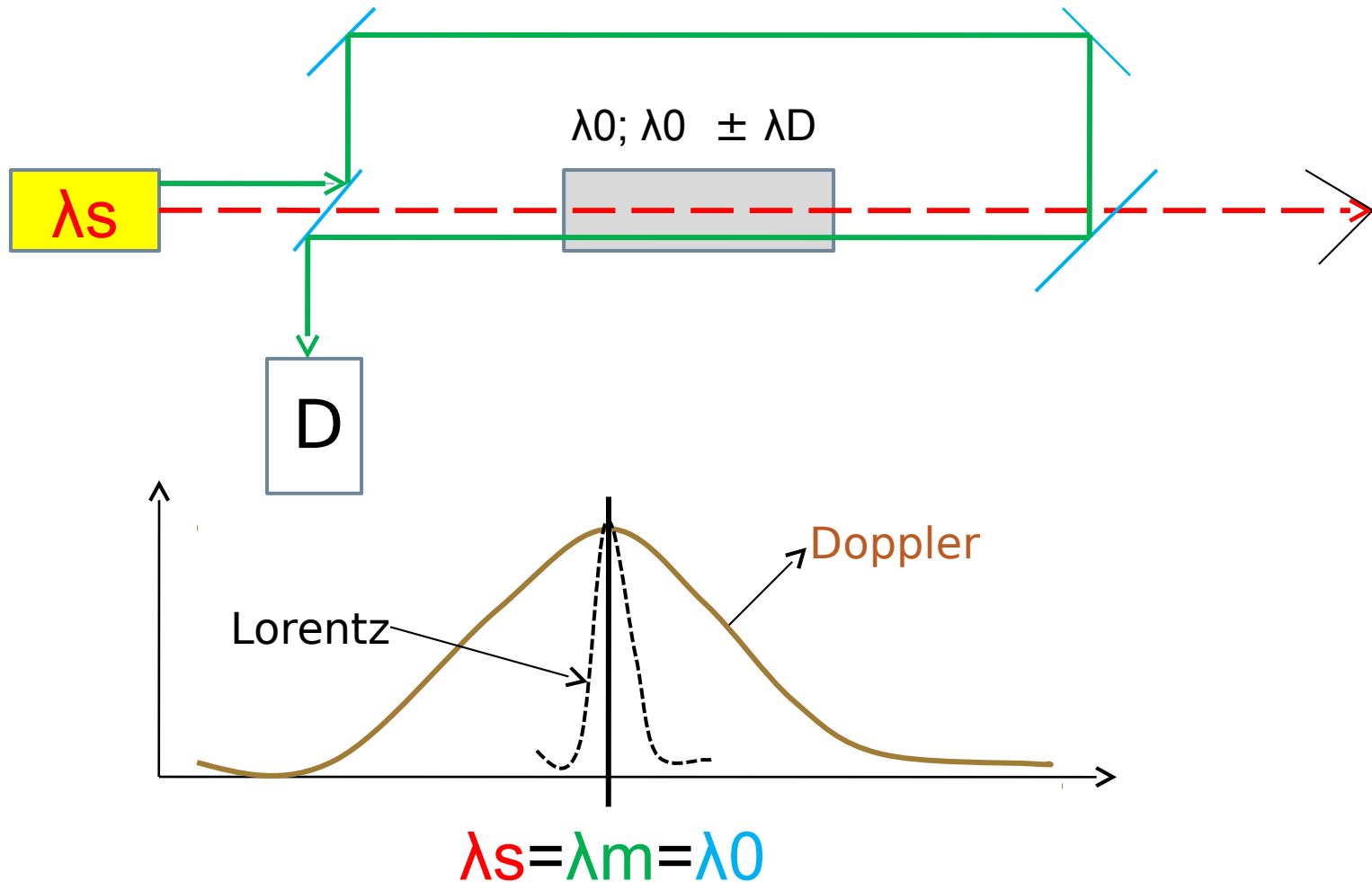

Saturated absorption spectroscopy

Saturated absorption spectroscopy

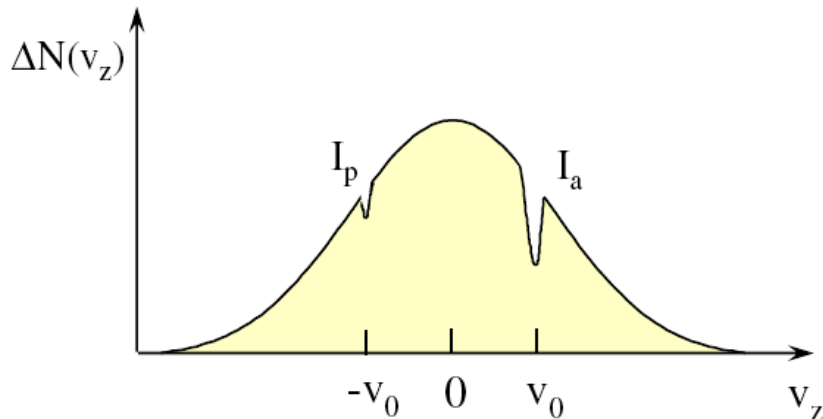
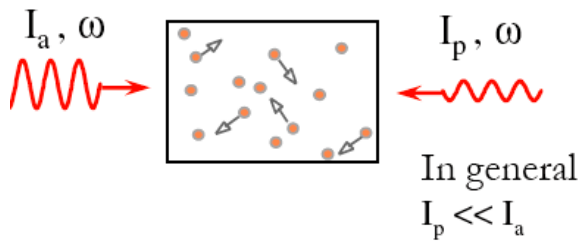

For weak saturation

$$S_p = \frac{I_p}{I_s}, \quad S_a = \frac{I_a}{I_s} \ll 1$$

Perturbation theory

$$\Delta N(v_z) \approx \Delta N_0(v_z) \left[1 - \frac{S_a (\gamma/2)^2}{(\omega - \omega_0 - kv_z)^2 + (\gamma/2)^2} - \frac{S_p (\gamma/2)^2}{(\omega - \omega_0 + kv_z)^2 + (\gamma/2)^2} \right]$$

The absorption of the probe beam (I_p) as a function of ω :

$$\alpha(\omega) = \int_{-\infty}^{\infty} \sigma_p(v_z, \omega) \Delta N(v_z) dv_z$$

$$\alpha_p(\omega) \cong \alpha_0(\omega) \left[1 - \frac{1}{2} S_a \frac{(\gamma/2)^2}{(\omega - \omega_0)^2 + (\gamma/2)^2} \right]$$

Doppler-free spectroscopy

What happens when ω is tuned?

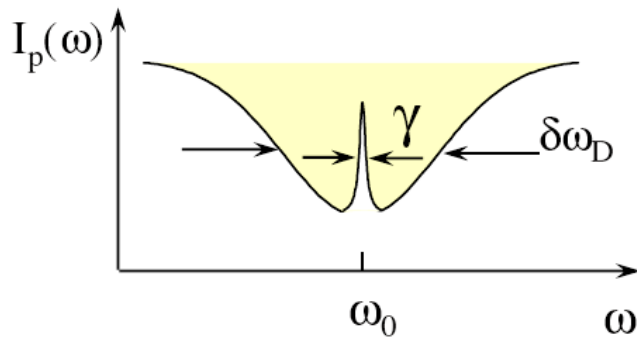
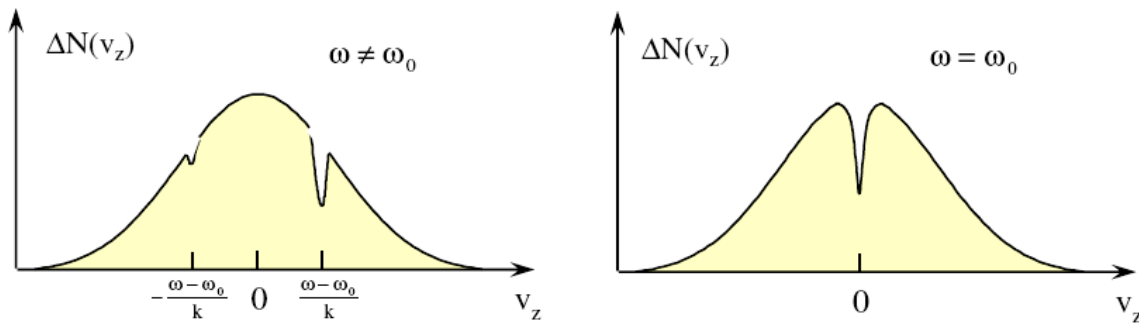

Resolution improved by 2 - 3 orders of magnitude

- High-resolution spectroscopy
Saturation spectroscopy (Lamb-dip spectroscopy)
- Laser frequency stabilization (gas lasers)

At $\omega = \omega_0$
a resonance of width $\sim \gamma$ (homogeneous width)
is obtained

Experimental arrangement

Experiment results:

$\text{Na(g)}, p=40\mu\text{Pa},$

$t=110^\circ\text{C}, \lambda=589\text{ nm}$

$\Delta\lambda_{\text{DOP}} \cong 1,7\text{ pm}$
(1500 MHz)

$\Delta\lambda_{\text{LAS}} \cong 0,008\text{ pm}$
(7 MHz)

$\Delta\lambda_{\text{EXP}} \cong 0,068\text{ pm}$
(40 MHz)

$\Delta\lambda_{\text{NAT}} \cong 0,01\text{ pm}$ ($\approx T=16\text{ ns}$)

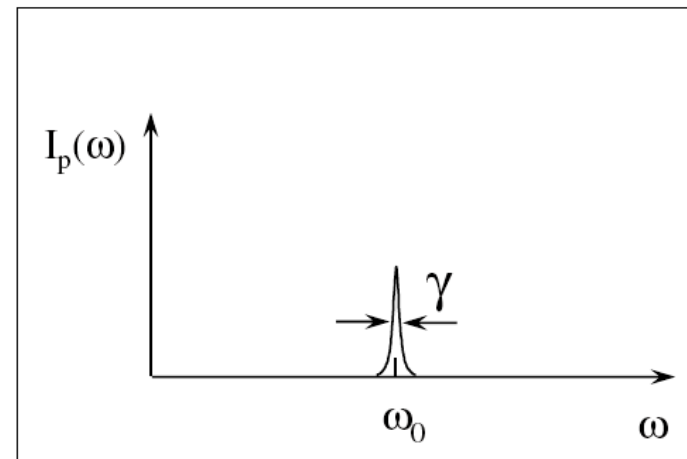
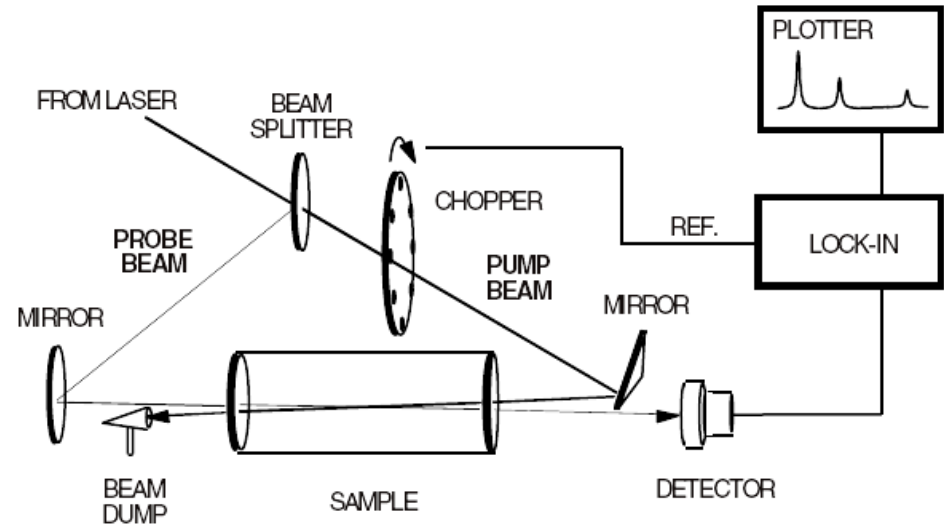

Apparatus for Doppler-free saturated absorption spectroscopy of I₂ and Na

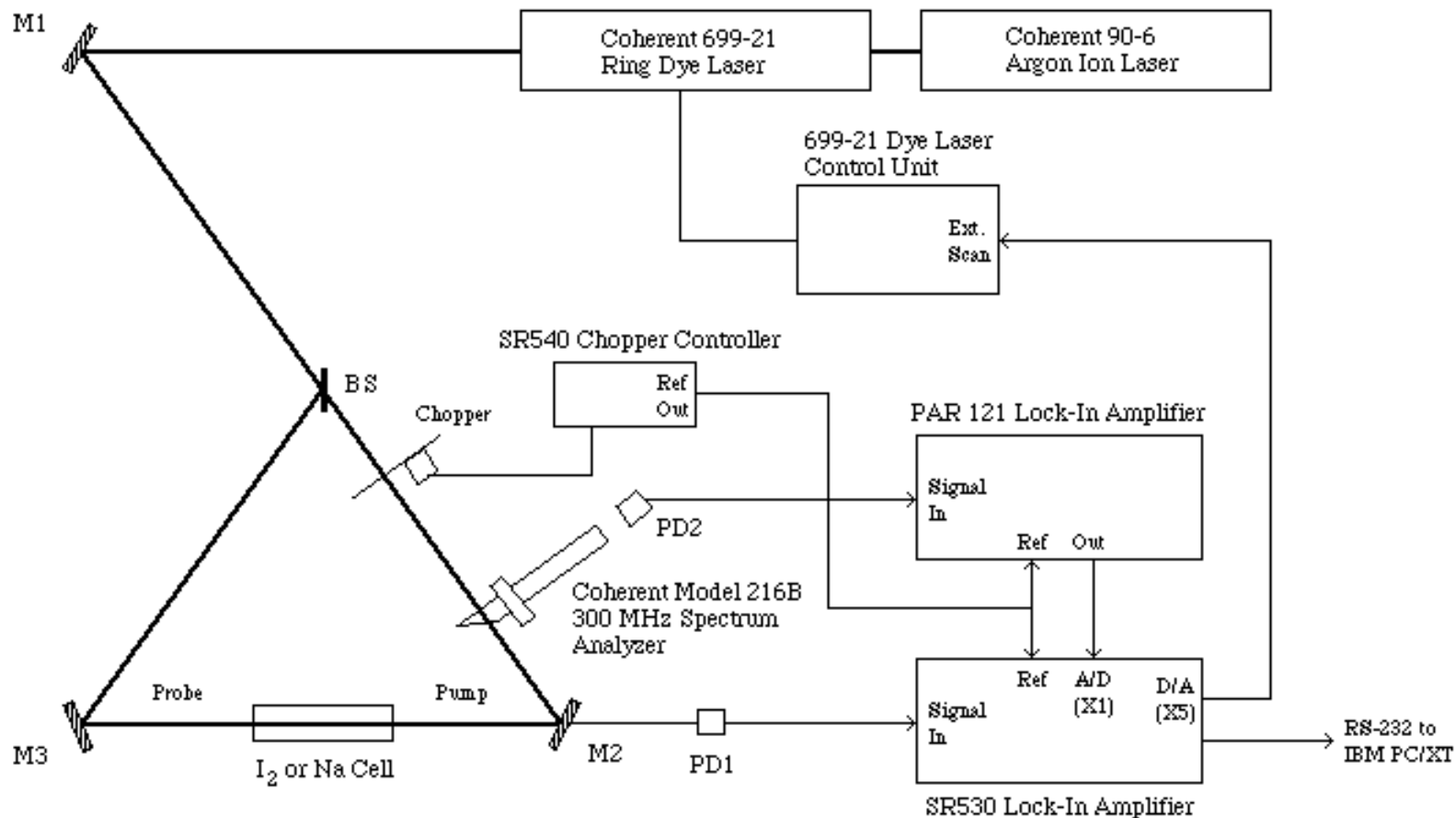

Doppler-Free Saturated Absorption Spectroscopy of Iodine and Sodium Using a Tunable Ring Dye Laser

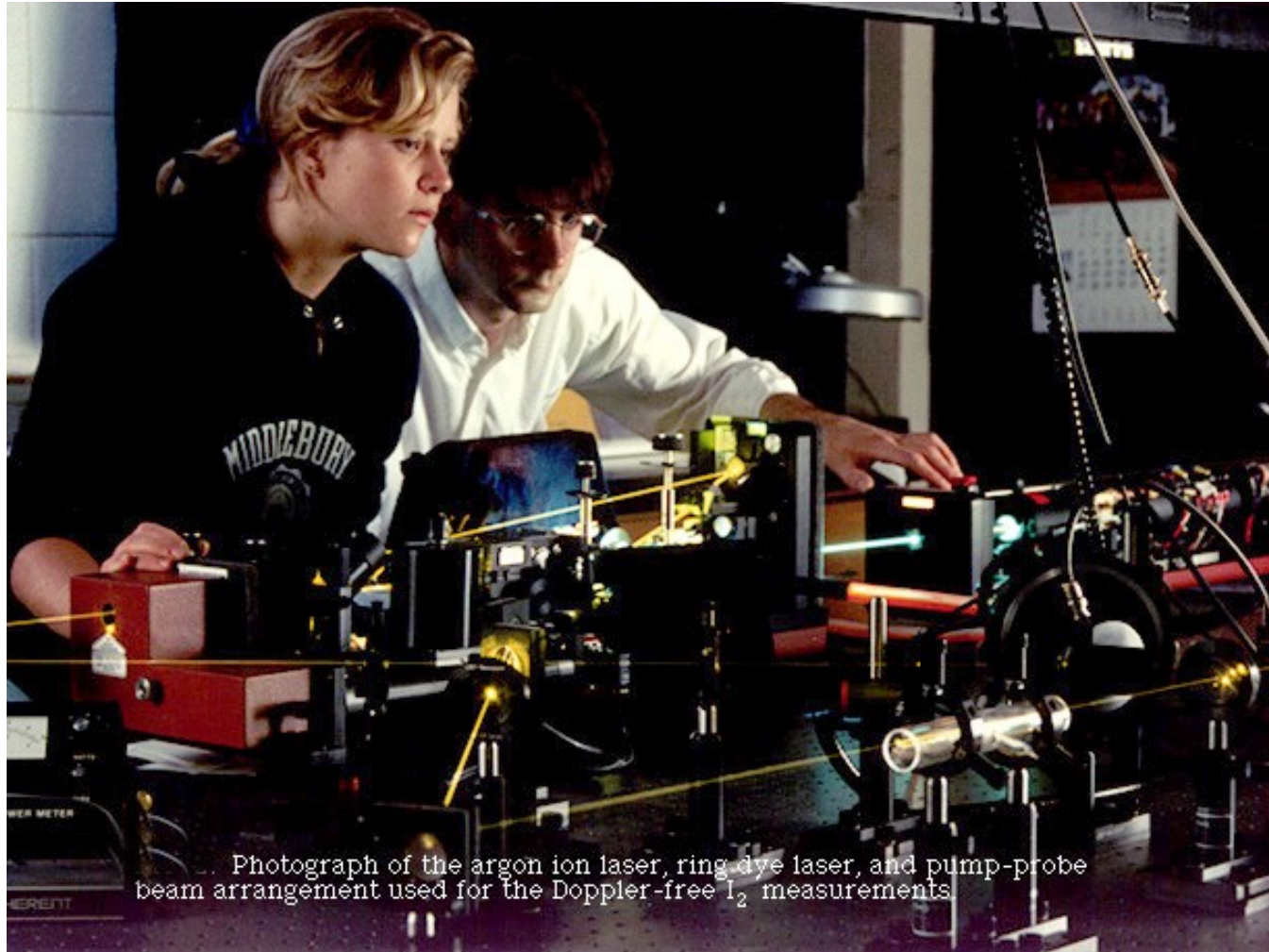

Photograph of the argon ion laser, ring dye laser, and pump-probe beam arrangement used for the Doppler-free I_2 measurements.

Absorption spectrum of iodine

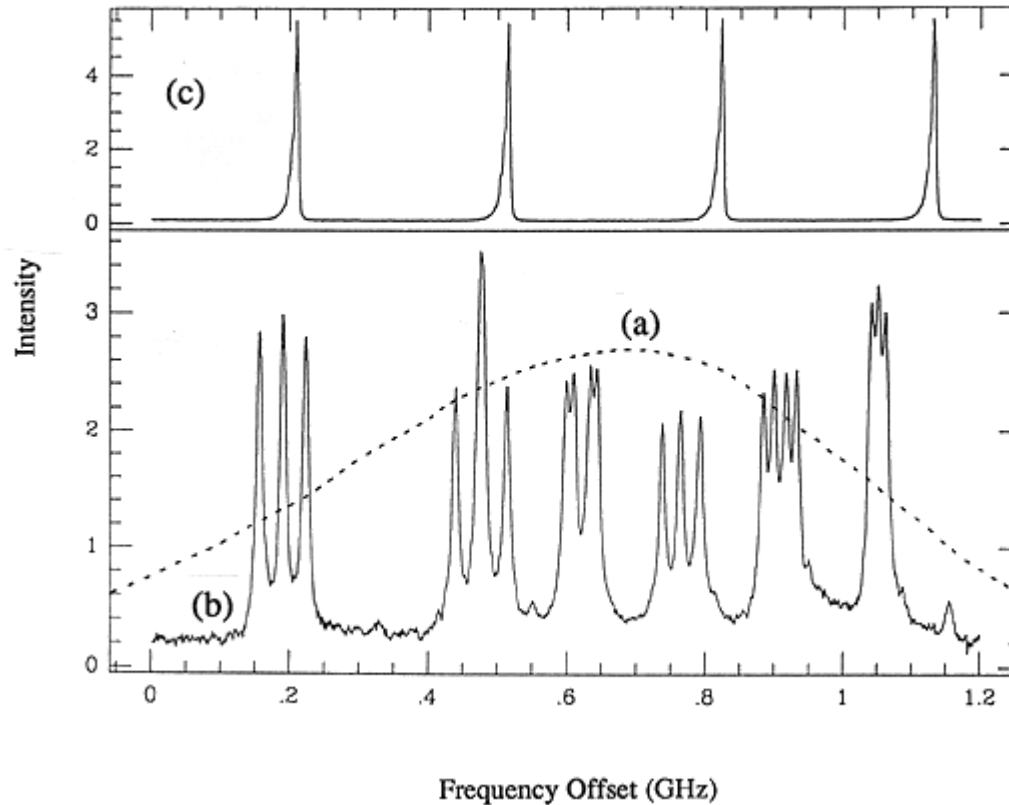

Ordinary, Doppler broadened, (dashed line) and (b) Doppler-free (solid line) absorption spectra of the 5682 Å, P(117), 21-1, X → B transition of I₂.
(c) 300 MHz interferometer transmission peaks for frequency calibration of laser

Laser stabilization

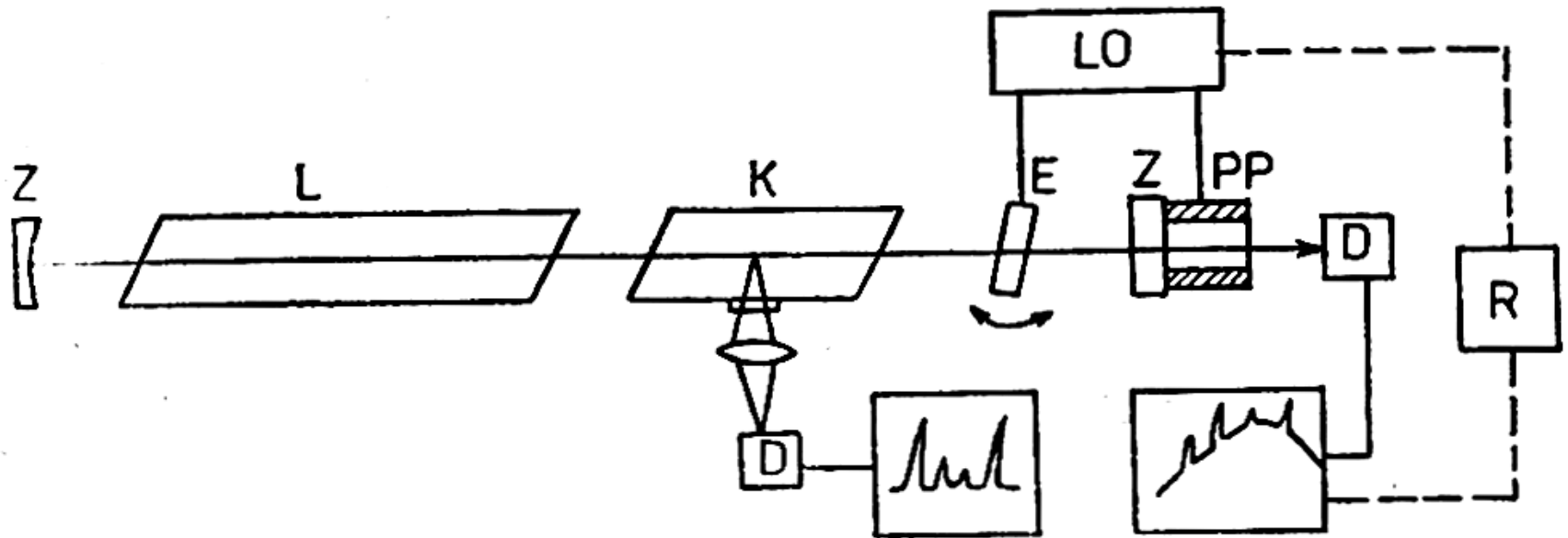

laser active medium, Z - mirrors, K = cuvette,
catalon, PP = piezoelectric interface, LO - tuning circuit,
detector, R - feedback control.
Example: He-Ne laser 3390 nm, methane cuvette, stabilization \pm

Doppler-free spectroscopy - summary

- If the frequency of the intense laser beam is tuned off the centre of the absorption line profile, a dip is formed in the absorption line indicating a decrease in the absorption coefficient (non-linear effect)
- In the experiment the laser beam is divided into two beams, intensive - saturation and weaker - test beams
- Both beams pass through the cuvette against each other - the effects of the two beams, when aligned from the center of the absorption line, are positioned symmetrically with respect to the center of the line
- When tuning the laser to the center of the line, the test beam is less absorbed due to the decrease in absorption in the dip and the laser beam intensity is significantly increased
- A narrow resonance peak is obtained which represents the absorption line of the sample without Doppler broadening
- Doppler-free spectroscopy allows experimentally removing the line broadening by selecting particles of zero velocity from the sample

Experimental results

- ❖ High-resolution measurements of spectra $\mathcal{R} \sim 10^8 - 10^9$
- ❖ Spectral fine structure, shifts (isotopes, Lamb shift ...)
- ❖ Hydrogen spectrum: Rydberg constant 100x improvement of accuracy
- ❖ Collision effects

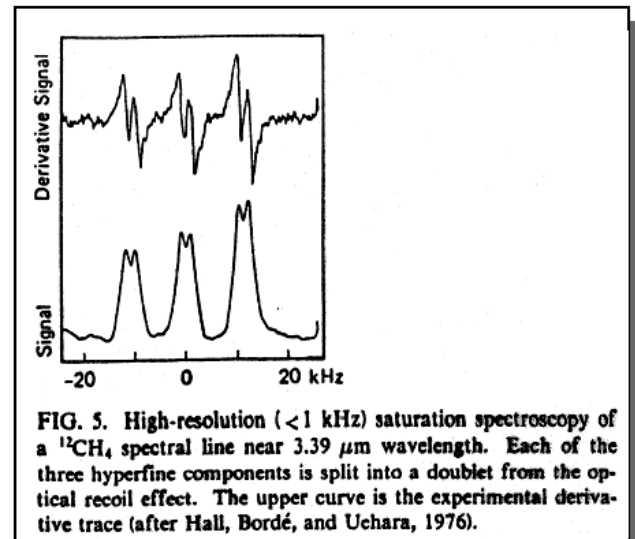
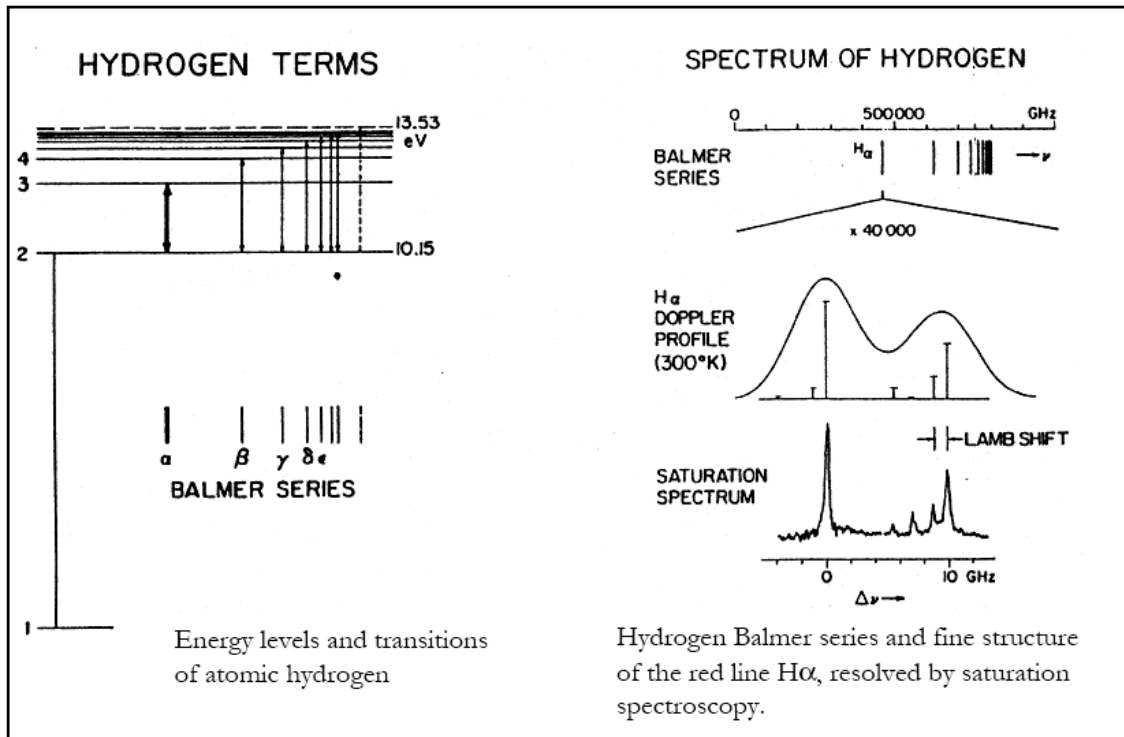

Two-photon Doppler-free spectroscopy

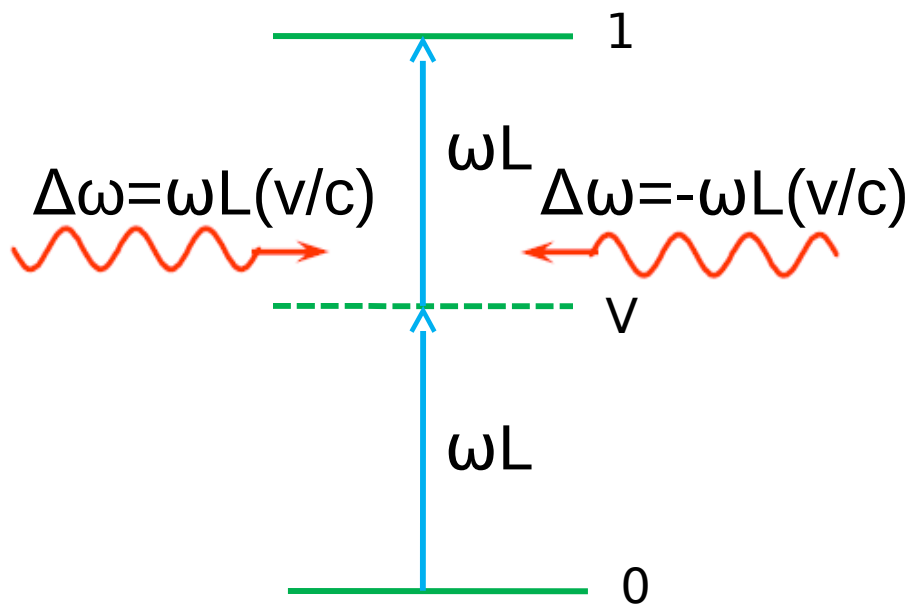

$$\Delta\omega = 0$$

$\Delta\omega = \text{Doppler shift}$

$\tau_V \approx 10-12 \text{ s}$

$\omega_L = \frac{1}{2} E_{01}$

VIS: $\Delta\lambda \approx 1 \text{ GHz}$

$\Phi_L < \text{dyn. Stark effect}$

$\Delta\lambda_L \approx 1 \text{ MHz} \Rightarrow$

necessary stabilization by
combination of Zeeman
and Stark tuning

Experimental arrangement

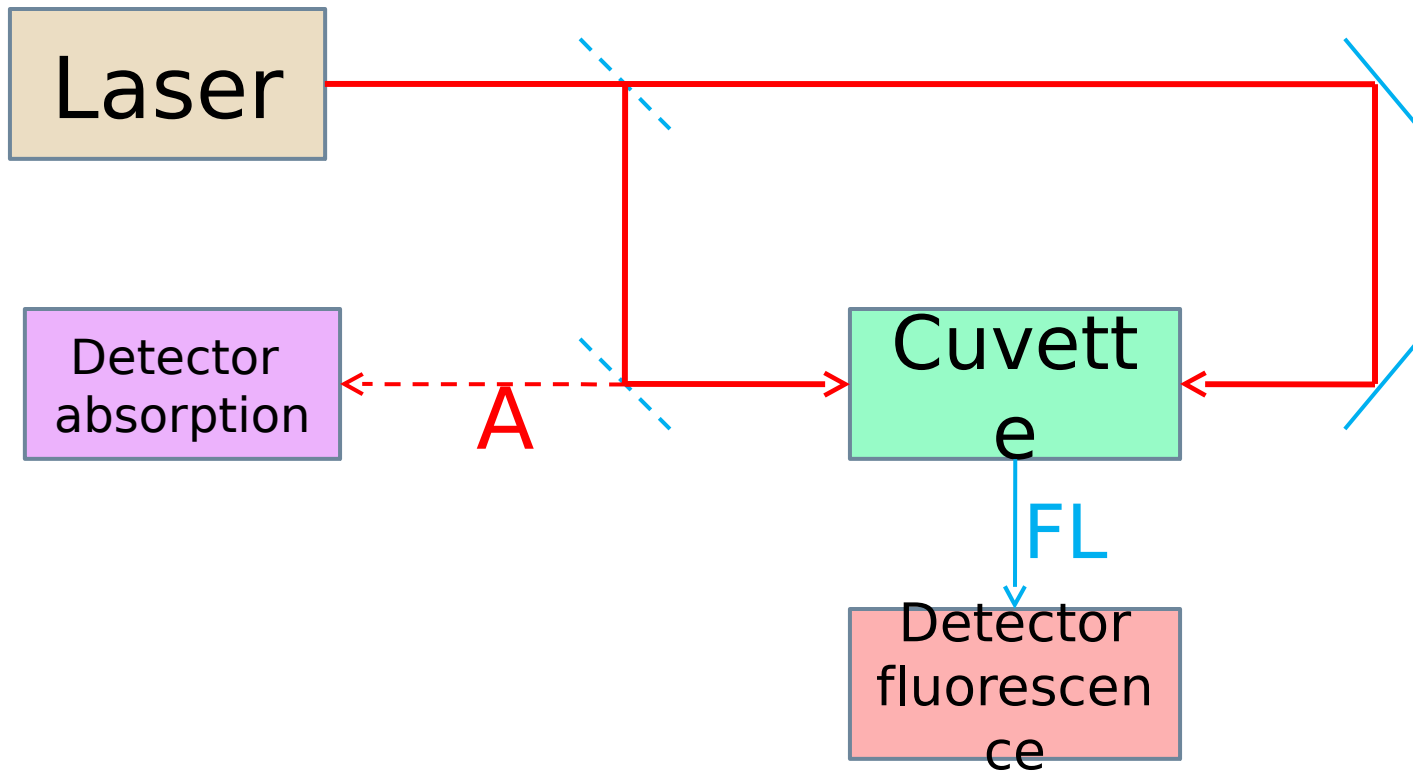

Detection of fluorescence in UV-VIS and near IR - transitions from excited levels

Detection of absorption of one of the exciting beams mainly in the IR region, e.g.

Two-photon spectrometry

Two-photon spectroscopy

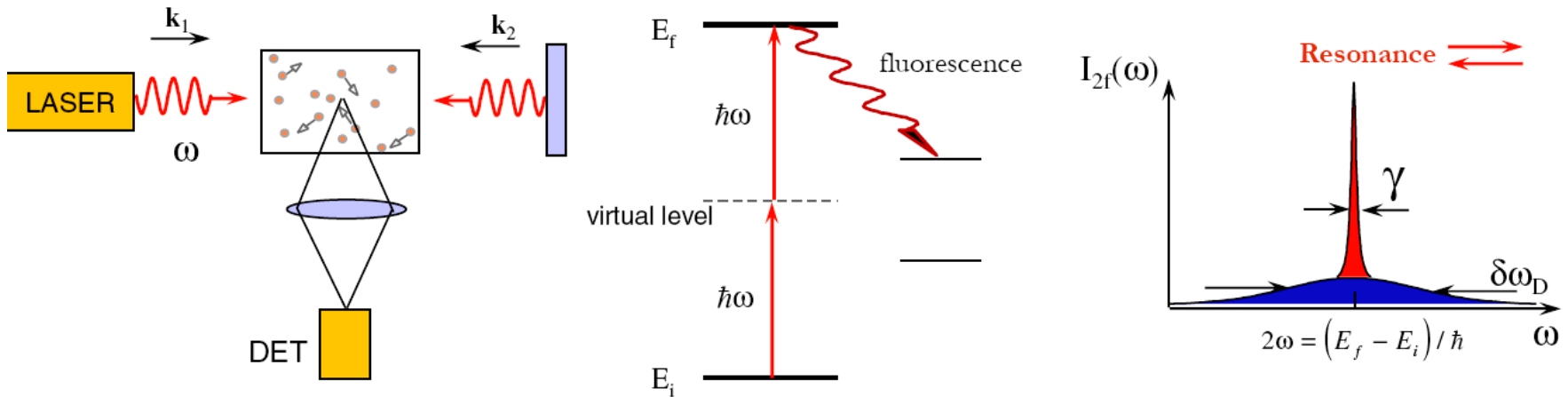

Resonance: $E_f - E_i = \hbar(\omega_1 + \omega_2)$

Doppler shifts: $\omega' = \omega - \mathbf{k} \cdot \mathbf{v}$

$$\Rightarrow E_f - E_i = \hbar(\omega'_1 + \omega'_2) = \hbar(\omega_1 + \omega_2) - (\mathbf{k}_1 + \mathbf{k}_2) \cdot \mathbf{v}$$

$\mathbf{k}_1 = -\mathbf{k}_2 \Rightarrow$ Resonance condition independent of v_z

Doppler background:

$$\Rightarrow + \Leftarrow$$

Signal $\propto I^2$

All atoms participate in the 2-photon signal !

(cf. saturated absorption: only $\gamma/\delta\omega_D$ of the atoms participate)

Application

Applications of two-photon spectroscopy

- ✓ Investigation of high-lying excited states
- ✓ Allows population of levels with the same parity as the initial level (cf. one-photon dipole transitions couple states with opposite parities)

